



Easy Access Rules for Air Operations

EASA eRules: aviation rules for the 21st century

Rules are the core of the EU civil aviation system. The aim of the **EASA eRules** project is to make them **accessible** to stakeholders in an efficient and reliable way.

EASA eRules is a comprehensive, single system for structuring, sharing, and storing of rules. It is the single, easy-access online database for all aviation safety rules applicable to European airspace users.

Easy Access Rules (EAR) are the output of the eRules project. They are consolidated versions of those rules, combining EU regulations with EASA certification specifications (CSs), acceptable means of compliance (AMC), and guidance material (GM) in an easy-to-read format with advanced navigation features through links and bookmarks. EAR are regularly updated, following the adoption of an official publication.

EAR are available:

- in PDF format;
- as dynamic online publications (online format) with a wide range of functionalities, such as filters to obtain regulatory material tailored to one's needs, a search function through the table of contents to quickly access the relevant sections, and easy navigation for computers, tablets, and mobiles; and
- in XML (machine-readable format) that can be easily processed and automated by recipients, producing output that is compatible and can be synchronised with local applications, search databases, etc.

The **EASA eRules** system is developed and implemented in close cooperation with the Member States and aviation industry to ensure that all its capabilities are relevant and effective.

Published November 2022¹

Copyright notice

© European Union, 1998-2022

Unless otherwise specified, you can re-use the legal documents published in EUR-Lex for commercial or non-commercial purposes [...] ('© European Union, <http://eur-lex.europa.eu/>, 1998-2022')².

¹ The published date represents the date when the consolidated version of the document was generated.

² Euro-Lex, Important Legal Notice: <http://eur-lex.europa.eu/content/legal-notice/legal-notice.html>.

DISCLAIMER

This document is issued by the European Union Aviation Safety Agency (referred to as both 'EASA' and 'the Agency') to provide its stakeholders with an updated, consolidated, and easy-to-read publication. It has been prepared by putting together the officially published EU regulations with the related EASA certification specifications (CSs), acceptable means of compliance (AMC) and guidance material (GM) (including their amendments) adopted so far. However, this document is not an official publication, and EASA accepts no liability for damage of any kind resulting from the risks inherent in its use.

NOTE FROM THE EDITOR

The content of this document is arranged as follows: the cover regulation (recitals and articles) of the implementing rule (IR) or delegated rule (DR) appears first, then the IR or DR annex points, followed by the related acceptable means of compliance (AMC) and guidance material (GM).

In case of certification specifications (CSs), a CS is followed by the related GM.

All elements (i.e. articles, IRs, DRs, AMC, CSs, and GM) are colour-coded and can be identified according to the illustration below. The EU regulation or EASA Executive Director (ED) decision through which the article, IR, DR, CS, AMC, or GM was introduced or last amended is indicated below the article, IR, DR, CS, AMC, or GM title in *italics*.

<u>Cover regulation article</u>	<i>EU regulation</i>
Implementing rule annex or delegated rule annex	<i>EU regulation</i>
Certification specification	<i>ED decision</i>
Acceptable means of compliance	<i>ED decision</i>
Guidance material	<i>ED decision</i>

Note:

Rules that have a future applicability date are marked with purple. The respective applicability date is indicated below the rule text in purple, in square brackets '[]', and in *italics*.

This document will be updated regularly to incorporate further amendments.

The format of this document has been adjusted to make it user-friendly and for reference purposes. Any comments should be sent to erules@easa.europa.eu.

INCORPORATED AMENDMENTS

IMPLEMENTING RULES (IRs) (COMMISSION REGULATIONS)

Commission Regulation	Affected Annex	Applicability date ¹
Regulation (EU) No 965/2012	Annex I (Definitions) Annex II (Part-ARO) Annex III (Part-ORO) Annex IV (Part-CAT) Annex V (Part-SPA)	28/10/2012
Regulation (EU) No 800/2013 (NCC, NCO)	Annex I (Definitions) Annex II (Part-ARO) Annex III (Part-ORO) Annex V (Part-SPA) Annex VI (Part-NCC) Annex VII (Part-NCO)	25/8/2013 Opt-out: 25/08/2016
Regulation (EU) No 71/2014 (OSD)	Annex III (Part-ORO) Annex V (Part-SPA)	17/2/2014 Not later than 18 Dec. 2018 or 2 years after the OSD was approved, whichever is the latest
Regulation (EU) No 83/2014 (FTL)	Annex II (Part-ARO) Annex III (Part-ORO)	18/2/2016 Opt-out: ORO.FTL.205(e): 17/02/2017
Regulation (EU) No 379/2014 (SPO, CAT A-A, Sailplanes and balloons)	Annex I (Definitions) Annex II (Part-ARO) Annex III (Part-ORO) Annex IV (Part-CAT) Annex V (Part-SPA) Annex VI (Part-NCC) Annex VII (Part-NCO) Annex VIII (Part-SPO)	1/7/2014 CAT, non-commercial ops and SPO with balloons: 08/4/2018 CAT, non-commercial ops and SPO with sailplanes: 08/04/2019
Regulation (EU) 2015/140 (Sterile flight deck procedures)	Annex I (Definitions) Annex III (Part-ORO) Annex IV (Part-CAT) Annex VII (Part-NCO) Annex VIII (Part-SPO)	19/2/2015 Cover Reg. 'Art. 9b Review': 18/2/2016
Regulation (EU) 2015/640 (Part 26)	Annex III (Part-ORO)	14/5/2015 Some rules in Part-26
Regulation (EU) 2015/1329 (Dry-lease; FDM AOC aeroplanes)	Annex II (Part-ARO) Annex III (Part-ORO) Annex IV (Part-CAT)	1/10/2015 Opt-out: ORO.AOC.110(d): 25/08/2017

¹ This is the main date of application (i.e. the date from which an act or a provision in an act produces its full legal effects) as defined in the relevant cover regulation article. However, some provisions of the regulations may be applicable at a different date (deferred applicability). Additionally, there may be some opt-outs (derogations from certain provisions) notified by the Member States.

Regulation (EU) 2015/2338 (Flight recordings, aircraft tracking system, ULD)	Annex I (Definitions) Annex IV (Part-CAT) Annex VI (Part-NCC) Annex VIII (Part-SPO)	5/1/2016 CAT.GEN.MPA.205: - 16/12/2018 CAT.IDE.A.185: - (b): 31/12/2018; - (c), (d): 01/01/2019 - (h): 16/06/2018 CAT.IDE.A.190(e), 195(d): - 16/06/2018 CAT.IDE.A.285: - 01/01/2019 CAT.IDE.H.185: - (c): 01/01/2019 - (g): 01/01/2020 CAT.IDE.H.190, 195: - 01/01/2020 NCC.IDE.A/H.160, 165, 170: - 01/01/2020 SPO.IDE.A/H.140, 145, 150: - 01/01/2020
Regulation (EU) 2016/1199 (PBN, HOFO, Aeronautical data (Part-DAT) et al.)	Annex I (Definitions) Annex II (Part-ARO) Annex IV (Part-CAT) Annex V (Part-SPA) Annex VI (Part-NCC) Annex VII (Part-NCO) Annex VIII (Part-SPO)	25/8/2016 HOFO: 01/07/2018 Part-DAT: 01/01/2019
Regulation (EU) 2017/363 (CAT SET-IMC et al.)	Annex II (Part-ARO) Annex III (Part-ORO) Annex IV (Part-CAT) Annex V (Part-SPA)	22/3/2017
Regulation (EU) 2018/394 (Deletion of balloon requirements)	Annex I (Definitions) Annex II (Part-ARO) Annex III (Part-ORO) Annex IV (Part-CAT) Annex VII (Part-NCO) Annex VIII (Part-SPO)	8/4/2019
Regulation (EU) 2018/1042 (Support programmes, psychological assessment of flight crew (FC), systematic and random testing of psychoactive substances of FC and CC members)	Annex I (Definitions) Annex II (Part-ARO) Annex IV (Part-CAT) Annex VI (Part-NCC) Annex VII (Part-NCO) Annex VIII (Part-SPO)	14/8/2020 TAWS in CAT.IDE.A.150 and SPO.IDE.A.130: applicable from 14/08/2018
Regulation (EU) 2018/1975 (Deletion of sailplane requirements; Electronic Flight Bags)	Annex I (Definitions) Annex II (Part-ARO) Annex III (Part-ORO) Annex IV (Part-CAT) Annex V (Part-SPA) Annex VI (Part-NCC) Annex VII (Part-NCO) Annex VIII (Part-SPO)	9/7/2019

Regulation (EU) 2019/1384 (Update Air Ops rules, use of aircraft listed on an AOC by other operators for non-CAT operations et al.)	Annex I (Definitions) Annex II (Part-ARO) Annex III (Part-ORO) Annex IV (Part-CAT) Annex V (Part-SPA) Annex VI (Part-NCC) Annex VII (Part-NCO) Annex VIII (Part-SPO)	24/9/2019
Regulation (EU) 2019/1387 (Aeroplane landing performance, lightweight flight recorders et al.)	Annex I (Definitions) Annex II (Part-ARO) Annex III (Part-ORO) Annex IV (Part-CAT) Annex V (Part-SPA) Annex VI (Part-NCC) Annex VII (Part-NCO) Annex VIII (Part-SPO)	25/9/2019 The following rules shall apply from 5/11/2020 : CAT.OP.MPA.300; CAT.OP.MPA.301; CAT.OP.MPA.303; CAT.OP.MPA.311; CAT.POL.A.105(d); CAT.POL.A.255; CAT.POL.A.355.
Regulation (EU) 2020/745 (postponement of application date of certain measures of Reg. (EU) 2018/1042 in the context of COVID-19 pandemic)	Annex II (Part-ARO) Annex IV (Part-CAT) Annex VI (Part-NCC) Annex VII (Part-NCO) Annex VIII (Part-SPO)	The changes to the following rules <i>shall apply from 14 February 2021</i> : Article 4; Some definitions in Annex I; ARO.RAMP.106; CAT.GEN.MPA.100(c)(1); CAT.GEN.MPA.170; CAT.GEN.MPA.175; CAT.GEN.MPA.215; CAT.GEN.MPA.100(b)(1); NCC.GEN.105(e)(2); NCO.SPEC.115(e)(2); SPO.GEN.105(e)(2).
Regulation (EU) 2020/1176 (postponement of application date of certain measures of Reg. (EU) 2019/1387 in the context of COVID-19 pandemic)	Annex IV (Part-CAT)	The changes to the following rules <i>shall apply from 12 August 2021</i> : CAT.OP.MPA.300; CAT.OP.MPA.301; CAT.OP.MPA.303; CAT.OP.MPA.311; CAT.POL.A.105(d); CAT.POL.A.255; CAT.POL.A.355.

<p>Regulation (EU) 2020/2036 (Evidence-based training (EBT) and postponement of application date of certain measures of Reg. (EU) 965/2012 related to some cockpit voice recorder requirements in the context of COVID-19 pandemic)</p>	<p>Annex I (Definitions) Annex II (Part-ARO) Annex III (Part-ORO) Annex IV (Part-CAT) Annex VI (Part-NCC) Annex VIII (Part-SPO)</p>	<p>1/1/2021</p> <p><i>The following rules have changed the date of application to 1 Jan 2022:</i> CAT.IDE.A.185 (c)(1) NCC.IDE.A.160 (b)(1) SPO.IDE.A.140 (b)(1)</p>
<p>Regulation (EU) 2021/1296 (Fuel/energy planning and management, support programmes and psychological assessment of flight crew, as well as testing of psychoactive substances)</p>	<p>Annex I (Definitions) Annex II (Part-ARO) Annex III (Part-ORO) Annex IV (Part-CAT) Annex V (Part-SPA) Annex VI (Part-NCC) Annex VII (Part-NCO) Annex VIII (Part-SPO)</p>	<p>30 October 2022</p> <p>14 February 2021 — definition (98b) reintroduced into Annex I (Definitions)</p>
<p>Regulation (EU) 2021/2237 (All-weather operations (AWO) and flight crew training and checking)</p>	<p>Annex I (Definitions) Annex II (Part-ARO) Annex III (Part-ORO) Annex IV (Part-CAT) Annex V (Part-SPA) Annex VI (Part-NCC) Annex VII (Part-NCO) Annex VIII (Part-SPO)</p>	<p>30 October 2022</p>
<p>Regulation (EU) 2022/2203 (postponing the applicability of the requirements for locating an aircraft in distress)</p>	<p>Annex IV (Part-CAT)</p>	<p>4 December 2022</p>

INCORPORATED AMC & GM (ED DECISIONS)

Annex (Part)	ED Decision	Issue no / Amendment no	Applicability date
GM to Cover Regulation	2014/019/R	Issue 1 (initial)	1/7/2014
	2018/003/R	Amendment 1	8/4/2019
	2018/012/R	Amendment 2	14/8/2020
	2019/019/R	Amendment 3	18/9/2019
GM to Definitions for terms used in Annexes II to VIII	2012/015/R	Issue 1 (initial)	24/10/2012
	2013/017/R	Amendment 1	23/8/2013
	2015/002/R	Amendment 2	31/1/2015
	2015/012/R	Amendment 3	4/5/2015
	2016/016/R	Amendment 4	3/8/2016
	2016/022/R	Amendment 5	1/7/2018
	2017/005/R	Amendment 6	31/3/2017
	2017/023/R	Amendment 7	15/12/2017
	2019/005/R	Amendment 8	20/12/2019
	2019/007/R	Amendment 9	1/9/2019
	2019/008/R	Amendment 10	9/7/2019
	2019/019/R	Amendment 11	18/9/2019
	2021/002/R	Amendment 12	3/3/2021
	2021/005/R	Amendment 13	24/4/2021
	2021/008/R	Amendment 14	30/6/2021
	2022/005/R	Amendment 15	30/10/2022
2022/012/R	Amendment 16	30/10/2022	
AMC&GM to Part-ARO	2014/025/R	Issue 3	28/10/2014
	2015/022/R	Amendment 1	1/10/2016
	2016/008/R	Amendment 2	3/5/2016
	2016/014/R	Amendment 3	3/8/2016
	2016/022/R	Amendment 4	1/7/2018
	2017/004/R	Amendment 5	10/3/2017
	2017/006/R	Amendment 6	31/3/2017
	2018/003/R	Amendment 7	8/4/2019
	2018/012/R	Amendment 8	14/8/2020
	2019/007/R	Amendment 9	1/9/2019 except for AMC1 ARO.RAMP.200(c), which applies from 1/1/2020)
	2019/019/R	Amendment 10	18/9/2019
	2021/002/R	Amendment 11	3/3/2021
	2022/005/R	Amendment 12	30/10/2022
2022/012/R	Amendment 13	30/10/2022	
AMC&GM to Part-ORO	2014/017/R	Issue 2	1/7/2014
	2015/005/R	Amendment 1	31/1/2015
	2015/012/R	Amendment 2	4/5/2015
	2015/022/R	Amendment 3	1/10/2016
	2015/027/R	Amendment 4	20/12/2015

	2015/030/R	Amendment 5	18/12/2015
	2016/004/R	Amendment 6	23/1/2020
	2016/008/R	Amendment 7	3/5/2016
	2016/019/R	Amendment 8	3/8/2016
	2016/022/R	Amendment 9	1/7/2018
	2017/004/R	Amendment 10	10/3/2017
	2017/007/R	Amendment 11	31/3/2017
	2017/023/R	Amendment 12	15/12/2017
	2019/005/R	Amendment 13	20/12/2019
	2019/008/R	Amendment 14	9/7/2019
	2019/019/R	Amendment 15	18/9/2019
	2019/025/R	Amendment 16	20/8/2020
	2021/002/R	Amendment 17	3/3/2021
	2021/005/R	Amendment 18	24/4/2021
	2022/005/R	Amendment 19	30/10/2022
	2022/012/R	Amendment 20	30/10/2022
	2022/014/R	Amendment 21	30/10/2022 (except for AMC2 ORO.FC.105(b)(2);(c), GM2 ORO.FC.105(b)(2), AMC1 ORO.FC.105(b)(3), AMC1 ORO.FC.115, AMC1 ORO.FC.120, AMC3 ORO.FC.120, AMC1 ORO.FC.125(b), AMC1 ORO.FC.130, AMC1 ORO.FC.135, AMC1 ORO.FC.145(a), GM1 ORO.FC.145(a), AMC2 ORO.FC.145(d), GM1 ORO.FC.145(d), AMC2 ORO.FC.146, AMC1 ORO.FC.215, AMC1 ORO.FC.220, AMC3 ORO.FC.220, AMC1 ORO.FC.230, AMC3 ORO.FC.230, GM1 ORO.FC.230, AMC1 ORO.FC.A.245, AMC1 ORO.FC.A.245(d);(e)(2), AMC1 ORO.FC.320, AMC1 ORO.FC.325, AMC1 ORO.FC.330 GM1 ORO.FC.330 AMC1 ORO.CC.115(e), which apply from 26/3/2023)
	2022/017/R	Amendment 22	3/9/2022
CS-FTL.1	2014/002/R	Issue 1 (initial)	10/2/2014
	2014/015/R	Issue 2	1/7/2014
AMC&GM to Part-CAT	2014/029/R	Amendment 1	27/9/2014
	2015/007/R	Amendment 2	31/1/2015

	2015/021/R	Amendment 3	13/10/2015
	2015/030/R	Amendment 4	18/12/2015
	2016/004/R	Amendment 5	23/7/2017
	2016/015/R	Amendment 6	3/8/2016
	2016/012/R	Amendment 7	14/9/2016
	2016/022/R	Amendment 8	1/7/2018
	2017/002/R	Amendment 9	9/3/2017
	2017/003/R	Amendment 10	1/1/2019
	2017/004/R	Amendment 11	10/3/2017
	2017/008/R	Amendment 12	31/3/2017
	2017/023/R	Amendment 13	15/12/2017
	2018/003/R	Amendment 14	8/4/2019
	2018/012/R	Amendment 15	14/8/2020
	2019/008/R	Amendment 16	9/7/2019
	2019/019/R	Amendment 17	18/9/2019
	2021/005/R	Amendment 18	24/4/2021
	2021/008/R	Amendment 19	30/6/2021
	2022/005/R	Amendment 20	30/10/2022
	2022/012/R	Amendment 21	30/10/2022
	2022/014/R	Amendment 22	30/10/2022
	2012/019/R	Issue 1 (initial)	24/10/2012
	2013/020/R	Amendment 1	23/8/2013
	2015/022/R	Amendment 2	1/10/2016
	2016/020/R	Amendment 3	3/8/2016
	2016/022/R	Amendment 4	1/7/2018
	2017/004/R	Amendment 5	10/3/2017
	2017/009/R	Amendment 6	31/3/2017
	2019/008/R	Amendment 7	9/7/2019
	2019/019/R	Amendment 8	18/9/2019
	2021/005/R	Amendment 9	24/4/2021
	2021/008/R	Amendment 10	30/6/2021
	2022/005/R	Amendment 11	30/10/2022
	2022/012/R	Amendment 12	30/10/2022
	2022/014/R	Amendment 13	30/10/2022
AMC&GM to Part-SPA	2013/021/R	Issue 1 (initial)	23/8/2013
	2014/030/R	Amendment 1	27/9/2014
	2015/003/R	Amendment 2	30/01/2015
	2015/021/R	Amendment 3	13/10/2015
	2015/030/R	Amendment 4	18/12/2015
	2016/017/R	Amendment 5	3/8/2016
	2016/012/R	Amendment 6	14/9/2016
	2016/022/R	Amendment 7	1/7/2018
	2017/002/R	Amendment 8	9/3/2017
	2017/003/R	Amendment 9	1/1/2019
	2017/010/R	Amendment 10	31/3/2017
	2019/008/R	Amendment 11	9/7/2019

	2019/019/R	Amendment 12	18/9/2019
	2021/005/R	Amendment 13	24/4/2021
	2021/008/R	Amendment 14	30/6/2021
	2022/005/R	Amendment 15	30/10/2022
	2022/012/R	Amendment 16	30/10/2022
	2022/014/R	Amendment 17	30/10/2022
AMC&GM to Part-NCO	2014/016/R	Issue 2	1/7/2014
	2014/031/R	Amendment 1	27/9/2014
	2015/004/R	Amendment 2	31/1/2015
	2016/018/R	Amendment 3	3/8/2016
	2016/022/R	Amendment 4	1/7/2018
	2017/003/R	Amendment 5	1/1/2019
	2017/011/R	Amendment 6	31/3/2017
	2018/003/R	Amendment 7	8/4/2019
	2019/008/R	Amendment 8	9/7/2019
	2019/019/R	Amendment 9	18/9/2019
	2021/005/R	Amendment 10	24/4/2021
	2021/008/R	Amendment 11	30/6/2021
	2022/005/R	Amendment 12	30/10/2022
	2022/012/R	Amendment 13	30/10/2022
	2022/014/R	Amendment 14	30/10/2022
AMC&GM to Part-SPO	2014/018/R	Issue 1 (initial)	1/7/2014
	2014/032/R	Amendment 1	27/9/2014
	2015/006/R	Amendment 2	31/1/2015
	2015/021/R	Amendment 3	13/10/2015
	2015/030/R	Amendment 4	18/12/2015
	2016/021/R	Amendment 5	3/8/2016
	2016/012/R	Amendment 6	14/9/2016
	2016/022/R	Amendment 7	1/7/2018
	2017/003/R	Amendment 8	1/1/2019
	2017/012/R	Amendment 9	31/3/2017
	2018/003/R	Amendment 10	8/4/2019
	2019/008/R	Amendment 11	9/7/2019
	2019/019/R	Amendment 12	18/9/2019
	2021/005/R	Amendment 13	24/4/2021
	2021/008/R	Amendment 14	30/6/2021
	2022/005/R	Amendment 15	30/10/2022
	2022/012/R	Amendment 16	30/10/2022
	2022/014/R	Amendment 17	30/10/2022

Note: To access the official versions, please click on the hyperlinks provided above.

TABLE OF CONTENTS

Disclaimer.....	3
Note from the editor.....	4
Incorporated amendments.....	5
Implementing Rules (IRs) (Commission regulations)	5
Incorporated AMC & GM (ED decisions)	9
Table of contents	13
Rule amendment status	90
Summary of changes — Revision 19 (November 2022).....	90
Revision table (IRs) Air Ops rules amended by Implementing Regulation (EU) 2022/2203	90
Revision table (IRs) Air Ops rules amended by ED Decision 2022/017/R	91
Revision table (IRs) Air Ops rules amended by ED Decision 2022/014/R	93
Revision table (IRs) Air Ops rules amended by ED Decision 2022/012/R	97
Summary of changes — Revision 18 (May 2022)	105
Revision table (IRs) Air Ops rules amended by ED Decision 2022/005/R	105
Summary of changes – Revision 17 (February 2022).....	110
Revision table (IRs) Air Ops rules amended by Implementing Regulation (EU) 2021/2237	111
Summary of changes – Revision 16 (December 2021).....	114
Revision table (IRs) Air Ops rules amended by Implementing Regulation (EU) 2021/1296	114
Summary of changes – Revision 15 (June 2021)	117
Revision table (IR, AMC, GM) Air Ops rules amended by Reg. (EU) 2020/745, (EU) 2020/2036 and EDD 2021/002/R	122
Revision table (IR, AMC, GM) Air Ops rules amended by EDD 2021/005/R.....	124
Revision table (IR, AMC, GM) Air Ops rules amended by EDD 2021/008/R.....	131
Summary of changes – Revision 14 (October 2019) Easy Access Rules for air operations... 	133
Revision table (IR, AMC, GM) Air Ops rules amended with Revision 14 – October 2019	133
Summary of changes – Revision 13 (September 2019) Easy Access Rules for air operations	137

Revision table (IR, AMC, GM) Air Ops rules amended with Revision 13 – September 2019	138
Summary of changes – Revision 12 (March 2019)	144
Summary of changes – Revision 11 (July 2018)	146
Summary of changes – Revision 10 (March 2018)	147
Summary of changes – Revision 9 (May 2017)	149
Summary of changes – Revision 8 (March 2017)	150
Summary of changes – Revision 7 (Oct. 2016)	151
Summary of changes – Revision 6 (Sept. 2016)	152
Summary of changes – Revision 5 (May 2016)	154
Cover regulation	156
Article 1 - Subject matter and scope	157
Article 2 - Definitions	157
GM1 Article 2(1)(d) Definitions	159
Article 3 - Oversight capabilities	161
GM1 Article 3(5)(e) Oversight capabilities	162
Article 4 - Ramp inspections	162
GM1 Article 4(3) Ramp inspections	162
Article 5 - Air operations	162
Article 6 - Derogations	164
GM1 Article 6.4a Derogations	165
GM2 Article 6.4a(a);(b) Derogations	166
GM3 Article 6.4a(a);(b) Derogations	166
GM1 Article 6.4a(c) Derogations	166
GM2 Article 6.4a(c) Derogations	166
Article 7 - Air operator certificates	166
Article 8 - Flight time limitations	167
Article 9 - Minimum equipment lists	167
Article 9a - Flight and cabin crew training	168
Article 9aa - Flight crew requirements for maintenance check flights	168
Article 9b - Review	168
Article 10 - Entry into force	169
ANNEX I – Definitions	172
Annex I Definitions for terms used in Annexes II to VIII	172

GM1 Annex I Definitions	188
GM2 Annex I Definitions	192
GM3 Annex I Definitions	200
GM4 Annex I Definitions	200
GM5 Annex I Definitions	200
GM6 Annex I Definitions	201
GM7 Annex I Definitions	201
GM8 Annex I Definitions	201
GM9 Annex I Definitions	201
GM10 Annex I Definitions	202
GM11 Annex I Definitions	202
GM12 Annex I Definitions	202
GM13 Annex I Definitions	202
GM14 Annex I Definitions	202
GM15 Annex I Definitions	202
GM16 Annex I Definitions	205
GM17 Annex I Definitions	205
GM18 Annex I Definitions	206
GM19 Annex I Definitions	207
GM20 Annex I Definitions	208
GM21 Annex I Definitions	209
GM22 Annex I Definitions	209
GM23 Annex I Definitions	209
GM24 Annex I Definitions	209
GM25 Annex I Definitions	210
GM26 Annex I Definitions	210
GM27 Annex I Definitions	210
GM28 Annex I Definitions for terms used in Annexes II to VIII	210
GM29 Annex I Definitions for terms used in Annexes II to VIII	211
GM30 Annex I Definitions for terms used in Annexes II to VIII	212
GM31 Annex I Definitions	212
GM32 Annex I Definitions	214
GM33 Annex I Definitions	216
GM34 Annex I Definitions	216
GM35 Annex I Definitions	216

ANNEX II (Part-ARO).....	218
ARO.GEN.005 Scope	218
SUBPART GEN: GENERAL REQUIREMENTS	219
SECTION I – General	219
ARO.GEN.115 Oversight documentation	219
ARO.GEN.120 Means of compliance	219
AMC1 ARO.GEN.120(d)(3) Means of compliance	220
AMC1 ARO.GEN.120(e) Means of compliance	220
GM1 ARO.GEN.120 Means of compliance	220
ARO.GEN.125 Information to the Agency	220
ARO.GEN.135 Immediate reaction to a safety problem	221
SECTION II – Management	221
ARO.GEN.200 Management system	221
AMC1 ARO.GEN.200(a) Management system.....	222
GM1 ARO.GEN.200(a) Management system	222
AMC1 ARO.GEN.200(a)(1) Management system	223
AMC1 ARO.GEN.200(a)(2) Management system	224
AMC2 ARO.GEN.200(a)(2) Management system	225
AMC3 ARO.GEN.200(a)(2) Management system	225
AMC4 ARO.GEN.200(a)(2) Management system	226
AMC5 ARO.GEN.200(a)(2) Management system	227
GM1 ARO.GEN.200(a)(2) Management System.....	227
GM2 ARO.GEN.200(a)(2) Management system	230
GM3 ARO.GEN.200(a)(2) Management system	230
GM4 ARO.GEN.200(a)(2) Management system	230
GM5 ARO.GEN.200(a)(2) Management system	231
GM6 ARO.GEN.200(a)(2) Management system	231
GM7 ARO.GEN.200(a)(2) Management system	231
AMC1 ARO.GEN.200(d) Management system	232
ARO.GEN.205 Allocation of tasks to qualified entities.....	233
ARO.GEN.210 Changes in the management system	233
ARO.GEN.220 Record-keeping	233
AMC1 ARO.GEN.220(a) Record-keeping	234
AMC1 ARO.GEN.220(a)(1);(2);(3) Record-keeping	235
AMC1 ARO.GEN.220(a)(4);(4a) Record-keeping	235
GM1 ARO.GEN.220(a)(4) Record-keeping.....	235
GM1 ARO.GEN.220(a)(4a) Record-keeping.....	236
AMC1 ARO.GEN.220(a)(7) Record-keeping.....	236
GM1 ARO.GEN.220 Record-keeping	236
SECTION III – Oversight, certification and enforcement	237
ARO.GEN.300 Oversight	237
AMC1 ARO.GEN.300(a);(b);(c) Oversight	237
AMC2 ARO.GEN.300(a);(b);(c) Oversight	238
GM1 ARO.GEN.300(a);(b);(c) Oversight	239
GM2 ARO.GEN.300(a);(b);(c) Oversight	239
GM3 ARO.GEN.300(a);(b);(c) Oversight	239
GM4 ARO.GEN.300(a);(b);(c) Oversight	240
AMC1 ARO.GEN.300(a)(2) Oversight.....	240
GM1 ARO.GEN.300(d) Oversight.....	241
ARO.GEN.305 Oversight programme	241
AMC1 ARO.GEN.305(b);(d);(d1) Oversight programme.....	242
AMC2 ARO.GEN.305(b) Oversight programme	243
GM1 ARO.GEN.305(b) Oversight programme.....	244
GM1 ARO.GEN.305(b);(c);(d);(d1) Oversight programme.....	244
AMC1 ARO.GEN.305(b)(1) Oversight programme.....	244

AMC2 ARO.GEN.305(b)(1) Oversight programme.....	245
AMC1 ARO.GEN.305(b);(c);(d);(d1) Oversight programme.....	245
AMC1 ARO.GEN.305(c) Oversight programme.....	246
AMC2 ARO.GEN.305(c) Oversight programme.....	246
AMC1 ARO.GEN.305(d) Oversight programme.....	247
AMC1 ARO.GEN.305(d1) Oversight programme.....	247
GM1 ARO.GEN.305(d1) Oversight programme.....	248
AMC1 ARO.GEN.305(e) Oversight programme.....	248
ARO.GEN.310 Initial certification procedure – organisations.....	248
AMC1 ARO.GEN.310(a) Initial certification procedure – organisations.....	248
ARO.GEN.330 Changes — organisations.....	250
AMC1 ARO.GEN.330 Changes – organisations.....	251
GM1 ARO.GEN.330 Changes – organisations.....	251
ARO.GEN.345 Declaration – organisations.....	251
AMC1 ARO.GEN.345 Declaration – organisations.....	252
GM1 ARO.GEN.345 Declaration – organisations.....	252
ARO.GEN.350 Findings and corrective actions – organisations.....	252
GM1 ARO.GEN.350 Findings and corrective actions – organisations.....	253
GM2 ARO.GEN.350(d) Findings and corrective actions – organisations.....	254
ARO.GEN.355 Findings and enforcement measures – persons.....	254
GM1 ARO.GEN.355(b) Findings and enforcement measures – persons.....	254
ARO.GEN.360 Findings and enforcement measures – all operators.....	254
SUBPART OPS: AIR OPERATIONS.....	256
SECTION I – Certification of commercial air transport operators.....	256
ARO.OPS.100 Issue of the air operator certificate.....	256
GM1 ARO.OPS.100(b) Issue of the air operator certificate.....	256
ARO.OPS.105 Code-share arrangements.....	257
AMC1 ARO.OPS.105 Code-share arrangements.....	257
AMC2 ARO.OPS.105 Code-share arrangements.....	257
ARO.OPS.110 Lease agreements for aeroplanes and helicopters.....	258
AMC1 ARO.OPS.110 Lease agreements for aeroplanes and helicopters.....	259
AMC2 ARO.OPS.110 Lease agreements for aeroplanes and helicopters.....	259
GM1 ARO.OPS.110 Lease agreements for aeroplanes and helicopters.....	259
GM2 ARO.OPS.110 Lease agreements for aeroplanes and helicopters.....	259
GM3 ARO.OPS.110 Lease agreement.....	260
SECTION Ia – Authorisation of high risk commercial specialised operations.....	260
ARO.OPS.150 Authorisation of high risk commercial specialised operations.....	260
AMC1 ARO.OPS.150 Authorisation of high risk commercial specialised operations.....	261
AMC1 ARO.OPS.150(a);(b) Authorisation of high risk commercial specialised operations.....	261
GM1 ARO.OPS.150(b) Authorisation of high risk commercial specialised operations.....	261
GM1 ARO.OPS.150(c) Authorisation of high risk commercial specialised operations.....	261
AMC1 ARO.OPS.150(f) Authorisation of high risk commercial specialised operations.....	262
GM1 ARO.OPS.150(f) Authorisation of high risk commercial specialised operations.....	262
ARO.OPS.155 Lease agreements.....	262
GM1 ARO.OPS.155 Lease agreements.....	262
GM2 ARO.OPS.155 Lease agreements.....	262
SECTION II – Approvals.....	263
ARO.OPS.200 Specific approval procedure.....	263
AMC1 ARO.OPS.200 Specific approval procedure.....	263
AMC2 ARO.OPS.200 SPECIFIC APPROVAL PROCEDURE.....	263
AMC3 ARO.OPS.200 Specific approval procedure.....	265
AMC4 ARO.OPS.200 Specific approval procedure.....	265
AMC5 ARO.OPS.200 Specific approval procedure.....	266
GM1 ARO.OPS.200 Specific approval procedure.....	267
GM2 ARO.OPS.200 Specific approval procedure.....	267
GM3 ARO.OPS.200 Specific approval procedure.....	267

GM4 ARO.OPS.200 Specific approval procedure	267
ARO.OPS.205 Minimum equipment list approval.....	267
GM1 ARO.OPS.205 Minimum equipment list approval	268
ARO.OPS.210 Determination of distance or local area.....	268
GM1 ARO.OPS.210 Determination of local area	268
ARO.OPS.215 Approval of helicopter operations over a hostile environment located outside a congested area	268
AMC1 ARO.OPS.215 Approval of helicopter operations over a hostile environment located outside a congested area	268
AMC2 ARO.OPS.215 Approval of helicopter operations over a hostile environment located outside a congested area	269
ARO.OPS.220 Approval of helicopter operations to or from a public interest site	269
AMC1 ARO.OPS.220 Approval of helicopter operations to or from a public interest site ...	269
AMC2 ARO.OPS.220 Approval of helicopter operations to or from a public interest site ...	269
ARO.OPS.225 Approval of fuel/energy schemes	270
AMC1 ARO.OPS.225 Approval of fuel/energy schemes	270
GM1 ARO.OPS.225 Approval of fuel/energy schemes	271
GM2 ARO.OPS.225 Approval of fuel/energy schemes	271
AMC1 ARO.OPS.225(c) Approval of fuel/energy schemes	272
AMC2 ARO.OPS.225(c) Approval of fuel/energy schemes	272
GM1 ARO.OPS.225(c) Approval of fuel/energy schemes	273
ARO.OPS.226 Approval and oversight of evidence-based training programmes	273
AMC1 ARO.OPS.226(a) Approval and oversight of evidence-based training programmes	274
GM1 ARO.OPS.226(a) Approval and oversight of evidence-based training programmes....	275
GM2 ARO.OPS.226(a) Approval and oversight of evidence-based training programmes ..	276
AMC1 ARO.OPS.226(c) Approval and oversight of evidence-based training programmes	276
AMC2 ARO.OPS.226(c) Approval and oversight of evidence-based training programmes ..	276
AMC1 ARO.OPS.226(d) Approval and oversight of evidence-based training programmes..	276
GM1 ARO.OPS.226(d) Approval and oversight of evidence-based training programmes ...	277
GM2 ARO.OPS.226(d) Approval and oversight of evidence-based training programmes ...	277
ARO.OPS.230 Determination of disruptive schedules	278
ARO.OPS.235 Approval of individual flight time specification schemes.....	278
GM1 ARO.OPS.235(b);(c) Approval of individual flight time specification schemes	278
ARO.OPS.240 Specific approval of RNP AR APCH	278
GM1 ARO.OPS.240 Specific approval of RNP AR APCH	279
GM2 ARO.OPS.240 Specific approval of RNP AR APCH	279
SECTION III – Oversight of operations	279
ARO.OPS.300 Introductory flights.....	279
AMC1 ARO.OPS.300 Introductory flights	279
GM1 ARO.OPS.300 Introductory flights	279
SUBPART RAMP: RAMP INSPECTIONS OF AIRCRAFT OF OPERATORS UNDER THE REGULATORY OVERSIGHT OF ANOTHER STATE	280
ARO.RAMP.005 Scope	280
GM1 ARO.RAMP.005 Scope	280
ARO.RAMP.100 General	280
AMC1 ARO.RAMP.100(b) General.....	281
AMC1 ARO.RAMP.100(c) General	281
ARO.RAMP.105 Prioritisation criteria.....	282
ARO.RAMP.106 Alcohol testing.....	283
AMC1 ARO.RAMP.106 Alcohol testing.....	283
GM1 ARO.RAMP.106 Alcohol testing.....	284
GM2 ARO.RAMP.106 Alcohol testing.....	285

GM3 ARO.RAMP.106 Alcohol testing.....	285
ARO.RAMP.110 Collection of information	285
AMC1 ARO.RAMP.110 Collection of information	285
ARO.RAMP.115 Qualification of ramp inspectors.....	286
AMC1 ARO.RAMP.115(a)(b) Qualification of ramp inspectors	287
AMC2 ARO.RAMP.115(a)(b) Qualification of ramp inspectors	287
AMC3 ARO.RAMP.115(a)(b) Qualification of ramp inspectors	288
AMC4 ARO.RAMP.115(a)(b) Qualification of ramp inspectors	288
AMC5 ARO.RAMP.115(a)(b) Qualification of ramp inspectors	289
AMC6 ARO.RAMP.115(a)(b) Qualification of ramp inspectors	289
AMC7 ARO.RAMP.115(a)(b) Qualification of ramp inspectors	290
AMC8 ARO.RAMP.115(a)(b) Qualification of ramp inspectors	290
ARO.RAMP.120 Approval of training organisations.....	291
AMC1 ARO.RAMP.120(a) Approval of training organisations.....	292
AMC2 ARO.RAMP.120(a) Approval of training organisations.....	292
AMC1 ARO.RAMP.120(a)(4) Approval of training organisations	293
ARO.RAMP.125 Conduct of ramp inspections	293
AMC1 ARO.RAMP.125 Conduct of Ramp Inspections & ARO.RAMP.130 Categorisation of findings	293
AMC1 ARO.RAMP.125(b) Conduct of ramp inspections.....	294
AMC1 ARO.RAMP.125(c) Conduct of ramp inspections	294
ARO.RAMP.130 Categorisation of findings	295
ARO.RAMP.135 Follow-up actions on findings.....	295
AMC1 ARO.RAMP.135(a) Follow-up actions on findings	296
AMC1 ARO.RAMP.135(b) Follow-up actions on findings.....	296
ARO.RAMP.140 Grounding of aircraft.....	297
ARO.RAMP.145 Reporting.....	297
AMC1 ARO.RAMP.145 Safety reports	298
ARO.RAMP.150 Agency coordination tasks	298
AMC1 ARO.RAMP.150(b)(4)(iii) Agency coordination tasks	299
ARO.RAMP.155 Annual report	299
ARO.RAMP.160 Information to the public and protection of information	299
Appendix I to Annex II (Part-ARO)	301
Appendix II to Annex II (Part-ARO)	302
Appendix III to Annex II (Part-ARO)	304
Appendix IV to Annex II (Part-ARO).....	305
ANNEX III (Part-ORO)	306
ORO.GEN.005 Scope	306
SUBPART GEN: GENERAL REQUIREMENTS	307
SECTION 1 – General	307
ORO.GEN.105 Competent authority	307

ORO.GEN.110 Operator responsibilities	307
AMC1 ORO.GEN.110(a) Operator responsibilities	308
AMC2 ORO.GEN.110(a) Operator responsibilities	309
GM1 ORO.GEN.110(a) Operator responsibilities	309
AMC1 ORO.GEN.110(c) Operator responsibilities	309
GM1 ORO.GEN.110(c) Operator responsibilities	309
AMC1 ORO.GEN.110(c)&(e) Operator responsibilities	309
AMC1 ORO.GEN.110(e) Operator responsibilities	312
AMC2 ORO.GEN.110(e) Operator responsibilities	312
GM1 ORO.GEN.110(e) Operator responsibilities	312
GM2 ORO.GEN.110(e) Operator responsibilities	313
AMC1 ORO.GEN.110(f) Operator responsibilities	313
AMC2 ORO.GEN.110(f) Operator responsibilities	313
GM1 ORO.GEN.110(f) Operator responsibilities	313
GM2 ORO.GEN.110(f) Operator responsibilities	314
AMC1 ORO.GEN.110(f)(h) Operator responsibilities	315
ORO.GEN.115 Application for an AOC	316
ORO.GEN.120 Means of compliance	316
AMC1 ORO.GEN.120(a) Means of compliance	317
ORO.GEN.125 Terms of approval and privileges of an AOC holder	317
AMC1 ORO.GEN.125 Terms of approval and privileges of an AOC holder	317
ORO.GEN.130 Changes related to an AOC holder	317
AMC1 ORO.GEN.130 Changes related to an AOC holder	318
GM1 ORO.GEN.130(a) Changes related to an AOC holder	318
GM2 ORO.GEN.130(a) Changes related to an AOC holder	319
AMC1 ORO.GEN.130(b) Changes related to an AOC holder	319
GM1 ORO.GEN.130(b) Changes related to an AOC holder	319
ORO.GEN.135 Continued validity of an AOC	321
ORO.GEN.140 Access	321
ORO.GEN.150 Findings	321
AMC1 ORO.GEN.150(b) Findings	322
GM1 ORO.GEN.150 Findings	322
ORO.GEN.155 Immediate reaction to a safety problem	322
ORO.GEN.160 Occurrence reporting	322
AMC1 ORO.GEN.160 Occurrence reporting	323
AMC2 ORO.GEN.160 Occurrence reporting	323
AMC3 ORO.GEN.160 Occurrence reporting	324
GM1 ORO.GEN.160 Occurrence reporting	324
SECTION 2 – Management	325
ORO.GEN.200 Management system	325
AMC1 ORO.GEN.200(a)(1);(2);(3);(5) Management system	325
AMC1 ORO.GEN.200(a)(1) Management system	326
GM1 ORO.GEN.200(a)(1) Management system	327
GM2 ORO.GEN.200(a)(1) Management system	328
GM3 ORO.GEN.200(a)(1) Management system	328
AMC1 ORO.GEN.200(a)(2) Management system	328
GM1 ORO.GEN.200(a)(2) Management system	329
AMC1 ORO.GEN.200(a)(3) Management system	329
GM1 ORO.GEN.200(a)(3) Management system	331
GM2 ORO.GEN.200(a)(3) Management system	331
GM3 ORO.GEN.200(a)(3) Management system	339
GM4 ORO.GEN.200(a)(3) Management system	340
AMC1 ORO.GEN.200(a)(4) Management system	340
GM1 ORO.GEN.200(a)(4) Management system	341
AMC1 ORO.GEN.200(a)(5) Management system	341
AMC2 ORO.GEN.200(a)(5) Management system	341
GM1 ORO.GEN.200(a)(5) Management system	342
AMC1 ORO.GEN.200(a)(6) Management system	342

GM1 ORO.GEN.200(a)(6) Management system.....	344
GM2 ORO.GEN.200(a)(6) Management system.....	345
GM3 ORO.GEN.200(a)(6) Management system.....	346
GM4 ORO.GEN.200(a)(6) Management system.....	348
AMC1 ORO.GEN.200(b) Management system	348
ORO.GEN.205 Contracted activities	348
AMC1 ORO.GEN.205 Contracted activities	349
AMC2 ORO.GEN.205 Contracted activities	349
GM1 ORO.GEN.205 Contracted activities	350
GM2 ORO.GEN.205 Contracted activities	350
ORO.GEN.210 Personnel requirements	350
AMC1 ORO.GEN.210(a) Application for an air operator certificate	351
GM1 ORO.GEN.210(a) Personnel requirements	351
ORO.GEN.215 Facility requirements	351
ORO.GEN.220 Record-keeping.....	351
AMC1 ORO.GEN.220(b) Record-keeping.....	352
GM1 ORO.GEN.220(b) Record-keeping.....	352
SECTION 3 – Additional organisational requirements.....	352
ORO.GEN.310 Use of aircraft listed on an AOC for non-commercial operations and specialised operations.....	352
GM1 ORO.GEN.310 Use of aircraft listed on an AOC for non-commercial operations and specialised operations.....	354
GM2 ORO.GEN.310 Use of aircraft listed on an AOC for non-commercial operations and specialised operations.....	354
GM1 ORO.GEN.310(a)(2) Use of aircraft listed on an AOC for non-commercial operations and specialised operations.....	355
AMC1 ORO.GEN.310(b);(e) Use of aircraft listed on an AOC for non-commercial operations and specialised operations.....	355
GM1 ORO.GEN.310(d) Use of aircraft listed on an AOC for non-commercial operations and specialised operations.....	356
AMC1 ORO.GEN.310(b);(d);(f) Use of aircraft listed on an AOC for non-commercial operations and specialised operations.....	356
SUBPART AOC: AIR OPERATOR CERTIFICATION.....	358
ORO.AOC.100 Application for an air operator certificate	358
AMC1 ORO.AOC.100 Application for an AOC.....	358
AMC1 ORO.AOC.100(a) Application for an air operator certificate.....	359
GM1 ORO.AOC.100(c) Application for an air operator certificate.....	359
ORO.AOC.105 Operations specifications and privileges of an AOC holder.....	359
ORO.AOC.110 Leasing agreement.....	359
AMC1 ORO.AOC.110 Leasing agreement.....	360
AMC1 ORO.AOC.110(c) Leasing agreement.....	361
AMC2 ORO.AOC.110(c) Leasing agreement.....	361
GM1 ORO.AOC.110(c) Leasing agreement.....	362
AMC1 ORO.AOC.110(f) Leasing agreement	362
ORO.AOC.115 Code-share agreements.....	362
AMC1 ORO.AOC.115(a)(1) Code share agreements	362
AMC1 ORO.AOC.115(b) Code-share arrangements.....	363
AMC2 ORO.AOC.115(b) Code-share agreements	363
ORO.AOC.120 Approvals to provide cabin crew training and to issue cabin crew attestations.....	364

ORO.AOC.125 Non-commercial operations of an AOC holder with aircraft listed on its AOC.....	364
AMC1 ORO.AOC.125(a) Non-commercial operations of an AOC holder with aircraft listed on its AOC.....	365
AMC2 ORO.AOC.125(a) Non-commercial operations of an AOC holder with aircraft listed on its AOC.....	365
AMC1 ORO.AOC.125(a)(2) Non-commercial operations of an AOC holder with aircraft listed on its AOC.....	366
AMC2 ORO.AOC.125(a)(2) Non-commercial operations of an AOC holder with aircraft listed on its AOC.....	366
GM1 ORO.AOC.125(a)(2) Non-commercial operations of an AOC holder with aircraft listed on an AOC.....	367
ORO.AOC.130 Flight data monitoring – aeroplanes.....	368
AMC1 ORO.AOC.130 Flight data monitoring – aeroplanes.....	368
GM1 ORO.AOC.130 Flight data monitoring – aeroplanes.....	370
GM2 ORO.AOC.130 Flight data monitoring – aeroplanes.....	377
GM3 ORO.AOC.130 Flight data monitoring – aeroplanes.....	378
ORO.AOC.135 Personnel requirements.....	379
AMC1 ORO.AOC.135(a) Personnel requirements.....	379
AMC2 ORO.AOC.135(a) Personnel requirements.....	380
AMC1 ORO.AOC.135(a)(4) Personnel requirements.....	380
GM1 ORO.AOC.135(a) Personnel requirements.....	381
GM2 ORO.AOC.135(a) Personnel requirements.....	381
GM1 ORO.AOC.135(a)(4) Personnel requirements.....	382
ORO.AOC.140 Facility requirements.....	383
GM1 ORO.AOC.140(b);(c) Facility requirements.....	383
ORO.AOC.150 Documentation requirements.....	383
SUBPART DEC: DECLARATION.....	384
ORO.DEC.100 Declaration.....	384
GM1 ORO.DEC.100 Declaration.....	384
AMC1 ORO.DEC.100(a);(d) Declaration.....	384
GM1 ORO.DEC.100(a);(d) Declaration.....	385
AMC1 ORO.DEC.100(d) Declaration.....	385
SUBPART SPO: COMMERCIAL SPECIALISED OPERATIONS.....	386
ORO.SPO.100 Common requirements for commercial specialised operators.....	386
AMC1 ORO.SPO.100(a) Personnel requirements.....	386
AMC2 ORO.SPO.100(a) Personnel requirements.....	387
GM1 ORO.SPO.100(a) Personnel requirements.....	387
GM2 ORO.SPO.100(a) Personnel requirements.....	387
AMC1 ORO.SPO.100(c) Common requirements for commercial specialised operators.....	388
GM1 ORO.SPO.100(c) Common requirements for commercial specialised operators.....	389
AMC1 ORO.SPO.100(c)(1) Common requirements for commercial specialised operators.....	389
AMC2 ORO.SPO.100(c)(1) Common requirements for commercial specialised operators.....	390

GM1 ORO.SPO.100(c)(1) Common requirements for commercial specialised operators.....	390
ORO.SPO.110 Authorisation of high risk commercial specialised operations	390
GM1 ORO.SPO.110(a) Authorisation of high-risk commercial specialised operations	391
GM2 ORO.SPO.110(a) Authorisation of high-risk commercial specialised operations	391
ORO.SPO.115 Changes	391
GM1 ORO.SPO.115(a) Changes.....	391
ORO.SPO.120 Continued validity.....	391
SUBPART MLR: MANUALS, LOGS AND RECORDS.....	393
ORO.MLR.100 Operations manual – general	393
AMC1 ORO.MLR.100 Operations manual – general	394
AMC2 ORO.MLR.100 Operations manual – General.....	395
AMC3 ORO.MLR.100 Operations manual – general	395
AMC4 ORO.MLR.100 Operations manual – General.....	413
AMC5 ORO.MLR.100 Operations manual – general.....	418
GM1 ORO.MLR.100(k) Operations manual – general.....	418
ORO.MLR.101 Operations manual – structure for commercial air transport	419
ORO.MLR.105 Minimum equipment list	419
GM1 ORO.MLR.105(a) Minimum equipment list.....	421
AMC1 ORO.MLR.105(c) Minimum equipment list.....	422
AMC1 ORO.MLR.105(d) Minimum equipment list.....	422
AMC1 ORO.MLR.105(d)(1) Minimum equipment list	422
AMC1 ORO.MLR.105(d)(3) Minimum equipment list	423
AMC2 ORO.MLR.105(d)(3) Minimum equipment list	423
GM1 ORO.MLR.105(d)(3) Minimum equipment list	423
GM2 ORO.MLR.105(d)(3) Minimum equipment list	424
GM1 ORO.MLR.105(e);(f) Minimum equipment list.....	424
AMC1 ORO.MLR.105(f) Minimum equipment list	424
GM1 ORO.MLR.105(f) Minimum equipment list	425
AMC1 ORO.MLR.105(g) Minimum equipment list.....	425
GM1 ORO.MLR.105(g) Minimum equipment list.....	425
AMC1 ORO.MLR.105(h) Minimum equipment list.....	426
AMC1 ORO.MLR.105(j) Minimum equipment list.....	426
GM1 ORO.MLR.105(j) Minimum equipment list.....	426
ORO.MLR.110 Journey log.....	427
AMC1 ORO.MLR.110 Journey log.....	427
GM1 ORO.MLR.110 Journey log.....	427
ORO.MLR.115 Record-keeping	428
AMC1 ORO.MLR.115 Record-keeping.....	429
GM1 ORO.MLR.115(c) Record-keeping.....	429
GM1 ORO.MLR.115(d) Record-keeping	429
SUBPART SEC: SECURITY	430
ORO.SEC.100 Flight crew compartment security – aeroplanes	430

ORO.SEC.105 Flight crew compartment security – helicopters	430
SUBPART FC: FLIGHT CREW	431
ORO.FC.005 Scope	431
SECTION 1 – Common requirements	431
ORO.FC.100 Composition of flight crew	431
GM1 ORO.FC.100(c) Composition of flight crew	432
ORO.FC.105 Designation as pilot-in-command/commander.....	432
AMC1 ORO.FC.105(b)(2);(c) Designation as pilot-in-command/commander	433
AMC2 ORO.FC.105(b)(2);(c) Designation as pilot-in-command/commander	435
GM1 ORO.FC.105(b)(2) Route and aerodrome knowledge.....	436
GM2 ORO.FC.105(b)(2) Designation as pilot-in-command/commander	437
AMC1 ORO.FC.105(b)(3) Designation as pilot-in-command/commander.....	437
AMC1 ORO.FC.105(c) Designation as pilot-in-command/commander	438
AMC2 ORO.FC.105(c) Designation as pilot-in-command/commander	438
GM1 ORO.FC.105(c) Designation as pilot-in-command/commander	438
AMC1 ORO.FC.105(d) Designation as pilot-in-command/commander	439
GM1 ORO.FC.105(d) Designation as pilot-in-command/commander	439
ORO.FC.110 Flight engineer	440
ORO.FC.115 Crew resource management (CRM) training.....	440
AMC1 ORO.FC.115 Crew resource management (CRM) training.....	440
AMC2 ORO.FC.115 Crew resource management (CRM) training.....	447
AMC3 ORO.FC.115 Crew resource management (CRM) training.....	448
GM1 ORO.FC.115 Crew resource management (CRM) training.....	450
GM2 ORO.FC.115 Crew resource management (CRM) training.....	451
GM3 ORO.FC.115 Crew resource management (CRM) training.....	451
GM4 ORO.FC.115 Crew resource management (CRM) training.....	452
GM5 ORO.FC.115 Crew resource management (CRM) training.....	452
GM6 ORO.FC.115 Crew resource management (CRM) training.....	453
GM7 ORO.FC.115 Crew resource management (CRM) training.....	454
GM8 ORO.FC.115 Crew resource management (CRM) training.....	455
ORO.FC.120 Operator conversion training	455
AMC1 ORO.FC.120 Operator conversion training	455
AMC2 ORO.FC.120 Operator conversion training	456
AMC3 ORO.FC.120 Operator conversion training	457
GM1 ORO.FC.120 Operator conversion training.....	458
AMC1 ORO.FC.120&130 Operator conversion training and checking & recurrent training and checking	458
ORO.FC.125 Differences training, familiarisation, equipment and procedure training.....	459
AMC1 ORO.FC.125 Differences training, familiarisation, equipment and procedure training	459
AMC2 ORO.FC.125 Differences training, familiarisation, equipment and procedure training	460
GM1 ORO.FC.125 Differences training, familiarisation, equipment and procedure training	460
AMC1 ORO.FC.125(b) Differences training, familiarisation, equipment and procedure training	460
GM1 ORO.FC.125(b) Differences training, familiarisation, equipment and procedure training	460
GM2 ORO.FC.125(b) Differences training, familiarisation, equipment and procedure training	461
ORO.FC.130 Recurrent training and checking.....	461
AMC1 ORO.FC.130 Recurrent training and checking	461
GM1 ORO.FC.130 Recurrent training and checking	462
AMC1 ORO.FC.130(a) Recurrent training and checking	463
ORO.FC.135 Pilot qualification to operate in either pilot’s seat.....	463
AMC1 ORO.FC.135 Pilot qualification to operate in either pilot’s seat.....	463

ORO.FC.140 Operation on more than one type or variant	463
GM1 ORO.FC.140 Operation on more than one type or variant	464
AMC1 ORO.FC.140(a) Operation on more than one type or variant	464
GM1 ORO.FC.140(a) Operation on more than one type or variant	473
AMC1 ORO.FC.140(b) Operation on more than one type or variant	473
AMC1 ORO.FC.140(d) Operation on more than one type or variant	473
ORO.FC.145 Provision of training, checking and assessment	473
AMC1 ORO.FC.145 Provision of training, checking and assessment	474
GM1 ORO.FC.145 Provision of training, checking and assessment	475
AMC1 ORO.FC.145(a) Provision of training, checking and assessment	475
GM1 ORO.FC.145(a) Provision of training, checking and assessment	475
AMC1 ORO.FC.145(b) Provision of training, checking and assessment	476
AMC1 ORO.FC.145(d) Provision of training, checking and assessment	476
AMC2 ORO.FC.145(d) Provision of training, checking and assessment	477
GM1 ORO.FC.145(d) Provision of training, checking and assessment	477
AMC1 ORO.FC.145(g) Provision of training, checking and assessment	478
ORO.FC.146 Personnel providing training, checking and assessment	478
AMC1 ORO.FC.146 Personnel providing training, checking and assessment	479
AMC2 ORO.FC.146 Personnel providing training, checking and assessment	479
AMC1 ORO.FC.146(b) Personnel providing training, checking and assessment	483
AMC2 ORO.FC.146(c) Personnel providing training, checking and assessment	483
AMC2 ORO.FC.146(c) Personnel providing training, checking and assessment	485
GM1 ORO.FC.146(c) Personnel providing training, checking and assessment	485
GM2 ORO.FC.146(c) Personnel providing training, checking and assessment	486
GM3 ORO.FC.146(c) Personnel providing training, checking and assessment	486
AMC1 ORO.FC.146(e);(f)&(g) Personnel providing training, checking and assessment	488
SECTION 2 – Additional requirements for commercial air transport operations	490
ORO.FC.200 Composition of flight crew	490
AMC1 ORO.FC.200(a) Composition of flight crew	490
ORO.FC.A.201 In-flight relief of flight crew members	491
ORO.FC.202 Single-pilot operations under IFR or at night	492
ORO.FC.205 Command course	493
AMC1 ORO.FC.205 Command course	493
ORO.FC.215 Initial operator’s crew resource management (CRM) training	494
AMC1 ORO.FC.215 Initial operator’s crew resource management (CRM) training	494
ORO.FC.220 Operator conversion training and checking	494
AMC1 ORO.FC.220 Operator conversion training and checking	495
AMC1 ORO.FC.220 Operator conversion training and checking	498
AMC2 ORO.FC.220 Operator conversion training and checking	502
AMC3 ORO.FC.220 Operator conversion training and checking	503
AMC1 ORO.FC.220(b) Operator conversion training and checking	503
GM1 ORO.FC.220(b) Operator conversion training and checking	503
GM1 ORO.FC.220(c) Operator conversion training and checking	503
GM1 ORO.FC.220(d) Operator conversion training and checking	504
AMC1 ORO.FC.220(f) Operator conversion training and checking	504
GM1 ORO.FC.220(f) Operator conversion training and checking	505
AMC1 ORO.FC.220&230 Operator conversion training and checking & recurrent training and checking	505
AMC2 ORO.FC.220&230 Operator conversion training and checking & recurrent training and checking	508
GM1 ORO.FC.220&230 Operator conversion training and checking & recurrent training and checking	508
GM2 ORO.FC.220&230 Operator conversion training and checking & recurrent training and checking	509
GM3 ORO.FC.220&230 Operator conversion training and checking & Recurrent training and checking	510
GM4 ORO.FC.220&230 Operator conversion training and checking & recurrent training and checking	512

GM5 ORO.FC.220&230 Operator conversion training and checking & recurrent training and checking	512
ORO.FC.230 Recurrent training and checking.....	513
AMC1 ORO.FC.230 Recurrent training and checking	514
AMC1 ORO.FC.230 Recurrent training and checking	520
AMC2 ORO.FC.230 Recurrent training and checking	526
AMC3 ORO.FC.230 Recurrent training and checking	527
GM1 ORO.FC.230 Recurrent training and checking	527
GM1 ORO.FC.230(a);(b);(f) Recurrent training and checking.....	528
ORO.FC.231 Evidence-based training	531
AMC1 ORO.FC.231(a) Evidence-based training.....	534
AMC2 ORO.FC.231(a) Evidence-based training	535
AMC3 ORO.FC.231(a) Evidence-based training	535
GM1 ORO.FC.231(a) Evidence-based training	536
GM2 ORO.FC.231(a) Evidence-based training	536
GM3 ORO.FC.231(a) Evidence-based training.....	536
GM4 ORO.FC.231(a) Evidence-based training.....	537
AMC1 ORO.FC.231(a)(1) Evidence-based training.....	537
AMC1 ORO.FC.231(a)(2) Evidence-based training	537
AMC2 ORO.FC.231(a)(2) Evidence-based training	538
GM1 ORO.FC.231(a)(2) Evidence-based training	538
GM2 ORO.FC.231(a)(2) Evidence-based training	539
GM3 ORO.FC.231(a)(2) Evidence-based training	539
AMC1 ORO.FC.231(a)(3) Evidence-based training.....	539
GM1 ORO.FC.231(a)(3) Evidence-based training	539
AMC1 ORO.FC.231(a)(4) Evidence-based training	540
GM1 ORO.FC.231(a)(4) Evidence-based training	540
AMC1 ORO.FC.231(a)(5) Evidence-based training	541
GM1 ORO.FC.231(a)(5) Evidence-based training	542
AMC1 ORO.FC.231(b) Evidence-based training	543
AMC2 ORO.FC.231(b) Evidence-based training	546
GM1 ORO.FC.231(b) Evidence-based training	546
AMC1 ORO.FC.231(c) Evidence-based training	546
AMC2 ORO.FC.231(c) Evidence-based training	547
GM1 ORO.FC.231(c) Evidence-based training.....	547
GM2 ORO.FC.231(c) Evidence-based training.....	548
AMC1 ORO.FC.231(d)(1) Evidence-based training	548
AMC2 ORO.FC.231(d)(1) Evidence-based training	549
AMC3 ORO.FC.231(d)(1) Evidence-based training	550
AMC4 ORO.FC.231(d)(1) Evidence-based training	550
GM1 ORO.FC.231(d)(1) Evidence-based training	552
GM2 ORO.FC.231(d)(1) Evidence-based training	553
AMC1 ORO.FC.231(d)(2) Evidence-based training	557
GM1 ORO.FC.231(d)(2) Evidence-based training	558
GM2 ORO.FC.231(d)(2) Evidence-based training	564
AMC1 ORO.FC.231(e) Evidence-based training.....	564
AMC1 ORO.FC.231(f) Evidence-based training	565
AMC1 ORO.FC.231(f)(3) Evidence-based training	565
GM1 ORO.FC.231(f) Evidence-based training	565
GM2 ORO.FC.231(f) Evidence-based training	567
GM3 ORO.FC.231(f) Evidence-based training	567
GM4 ORO.FC.231(f) Evidence-based training	568
AMC1 ORO.FC.231(g) Evidence-based training.....	569
AMC2 ORO.FC.231(g) Evidence-based training.....	569
GM1 ORO.FC.231(g) Evidence-based training.....	570
GM2 ORO.FC.231(g) Evidence-based training.....	570
AMC1 ORO.FC.231(h) Evidence-based training	570
AMC2 ORO.FC.231(h) Evidence-based training	571
AMC1 ORO.FC.231(h)(3) Evidence-based training	571
GM1 ORO.FC.231(h) Evidence-based training	571
GM1 ORO.FC.231(h)(4) Evidence-based training	572

AMC1 ORO.FC.231(i) Evidence-based training.....	572
GM1 ORO.FC.231(i) Evidence-based training.....	575
GM2 ORO.FC.231(i) Evidence-based training.....	575
ORO.FC.232 EBT programme assessment and training topics.....	576
AMC1 ORO.FC.232 EBT programme assessment and training topics	576
AMC2 ORO.FC.232 EBT programme assessment and training topics	577
AMC3 ORO.FC.232 EBT programme assessment and training topics	607
AMC4 ORO.FC.232 EBT programme assessment and training topics	641
AMC5 ORO.FC.232 EBT programme assessment and training topics.....	677
AMC6 ORO.FC.232 EBT programme assessment and training topics	678
AMC7 ORO.FC.232 EBT programme assessment and training topics	716
AMC8 ORO.FC.232 EBT programme assessment and training topics	717
GM1 ORO.FC.232 EBT programme assessment and training topics	717
GM2 ORO.FC.232 EBT programme assessment and training topics	718
AMC1 ORO.FC.232(b)(1) EBT programme assessment and training topics.....	718
AMC1 ORO.FC.232(b)(3) EBT programme assessment and training topics.....	720
ORO.FC.235 Pilot qualification to operate in either pilot’s seat — aeroplanes ..	721
GM1 ORO.FC.235(e);(f) Pilot qualification to operate in either pilot’s seat.....	722
ORO.FC.236 Pilot qualification to operate in either pilot’s seat — helicopters ..	722
AMC1 ORO.FC.236 Pilot qualification to operate in either pilot’s seat	722
GM1 ORO.FC.236 Pilot qualification to operate in either pilot’s seat	723
ORO.FC.240 Operation on more than one type or variant.....	723
AMC1 ORO.FC.240 Operation on more than one type or variant.....	723
ORO.FC.A.245 Alternative training and qualification programme.....	727
AMC1 ORO.FC.A.245 Alternative training and qualification programme	728
GM1 ORO.FC.A.245 Alternative training and qualification programme	735
GM2 ORO.FC.A.245 Alternative training and qualification programme	735
GM3 ORO.FC.A.245 Alternative training and qualification programme	736
AMC1 ORO.FC.A.245(a) Alternative training and qualification programme	736
AMC1 ORO.FC.A.245(d)(e)(2) Alternative training and qualification programme	737
AMC1 ORO.FC.A.245(d);(e)(2) Alternative training and qualification programme	737
GM1 ORO.FC.A.245(e)(2) Alternative training and qualification programme.....	737
AMC1 ORO.FC.A.245(g) Alternative training and qualification programme	737
ORO.FC.A.250 Commanders holding a CPL(A)	738
ORO.FC.H.250 Commanders holding a CPL(H).....	738
SECTION 3 – Additional requirements for commercial specialised operations and CAT	
operations referred to in ORO.FC.005(b)(1) and (2)	739
ORO.FC.320 Operator conversion training and checking	739
AMC1 ORO.FC.320 Operator conversion training and checking	739
ORO.FC.325 Equipment and procedure training and checking	739
AMC1 ORO.FC.325 Equipment and procedure training and checking	739
ORO.FC.330 Recurrent training and checking — operator proficiency check	739
AMC1 ORO.FC.330 Recurrent training and checking — operator proficiency check	740
GM1 ORO.FC.330 Recurrent training and checking — operator proficiency check	741
SUBPART CC: CABIN CREW.....	742
ORO.CC.005 Scope.....	742
SECTION 1 – Common requirements	742
ORO.CC.100 Number and composition of cabin crew	742
AMC1 ORO.CC.100 Number and composition of cabin crew	743
GM1 ORO.CC.100 Number and composition of cabin crew.....	743
AMC1 ORO.CC.100(d)(2) Number and composition of cabin crew	744
GM1 ORO.CC.100(d)(2) Number and composition of cabin crew	745
ORO.CC.110 Conditions for assignment to duties	745
ORO.CC.115 Conduct of training courses and associated checking	746
GM1 ORO.CC.115 Conduct of training courses and associated checking	746

AMC1 ORO.CC.115(c) Conduct of training courses and associated checking	747
AMC1 ORO.CC.115(d) Conduct of training courses and associated checking	747
AMC1 ORO.CC.115(e) Conduct of training courses and associated checking	748
AMC2 ORO.CC.115(e) Conduct of training courses and associated checking	753
AMC3 ORO.CC.115(e) Conduct of training courses and associated checking	754
GM1 ORO.CC.115(e) Conduct of training courses and associated checking	756
GM2 ORO.CC.115(e) Conduct of training courses and associated checking	756
GM3 ORO.CC.115(e) Conduct of training courses and associated checking	756
GM4 ORO.CC.115(e) Conduct of training courses and associated checking	757
GM5 ORO.CC.115(e) Conduct of training courses and associated checking	758
GM6 ORO.CC.115(e) Conduct of training courses and associated checking	759
ORO.CC.120 Initial training course.....	759
AMC1 ORO.CC.120(a)(1) Initial training course	759
ORO.CC.125 Aircraft type specific training and operator conversion training	760
AMC1 ORO.CC.125(c) Aircraft type specific training and operator conversion training	761
AMC1 ORO.CC.125(d) Aircraft type-specific training and operator conversion training	762
AMC1 ORO.CC.125 & ORO.CC.130 Aircraft type specific training and operator conversion training & differences training	764
AMC1 ORO.CC.125(b) & ORO.CC.130(c) Aircraft type specific training and operator conversion training & differences training.....	765
ORO.CC.130 Differences training	765
AMC1 ORO.CC.125 & ORO.CC.130 Aircraft type specific training and operator conversion training & differences training	765
AMC1 ORO.CC.125(b) & ORO.CC.130(c) Aircraft type specific training and operator conversion training & differences training.....	766
ORO.CC.135 Familiarisation	766
AMC1 ORO.CC.135 Familiarisation.....	766
ORO.CC.140 Recurrent training	767
AMC1 ORO.CC.140 Recurrent training.....	769
ORO.CC.145 Refresher training.....	770
AMC1 ORO.CC.145 Refresher training	770
GM1 ORO.CC.145 Refresher training.....	770
SECTION 2 – Additional requirements for commercial air transport operations	771
ORO.CC.200 Senior cabin crew member	771
AMC1 ORO.CC.200(c) Senior cabin crew member	771
AMC1 ORO.CC.200(d) Senior cabin crew member.....	772
AMC1 ORO.CC.200(e) Senior cabin crew member.....	772
AMC2 ORO.CC.200(e) Senior cabin crew member.....	773
GM1 ORO.CC.200(e) Senior cabin crew member.....	773
GM2 ORO.CC.200(e) Senior cabin crew member.....	773
ORO.CC.205 Reduction of the number of cabin crew members during ground operations and in unforeseen circumstances.....	774
GM1 ORO.CC.205(a) Reduction of the number of cabin crew members during ground operations and in unforeseen circumstances	775
GM1 ORO.CC.205(b)(2) Reduction of the number of cabin crew during ground operations and in unforeseen circumstances	775
AMC1 ORO.CC.205(c)(1) Reduction of the number of cabin crew members during ground operations and in unforeseen circumstances	775
AMC1 ORO.CC.205(d) Reduction of the number of cabin crew members during ground operations and in unforeseen circumstances	776
AMC2 ORO.CC.205(d) Reduction of the number of cabin crew members during ground operations and in unforeseen circumstances	776
ORO.CC.210 Additional conditions for assignment to duties	777
GM1 ORO.CC.210(d) Additional conditions for assignment to duties.....	777
ORO.CC.215 Training and checking programs and related documentation.....	778
GM1 ORO.CC.215(b)(2) Training and checking programmes and related documentation ..	778
ORO.CC.250 Operation on more than one aircraft type or variant.....	779
AMC1 ORO.CC.250(b) Operation on more than one aircraft type or variant	779

GM1 ORO.CC.250 Operation on more than one aircraft type or variant	780
ORO.CC.255 Single cabin crew member operations	780
SUBPART TC: TECHNICAL CREW IN HEMS, HHO OR NVIS OPERATIONS	782
ORO.TC.100 Scope	782
ORO.TC.105 Conditions for assignment to duties	782
GM1 ORO.TC.105 Conditions for assignment to duties	782
ORO.TC.110 Training and checking	783
AMC1 ORO.TC.110 Training and checking	783
AMC1 ORO.TC.110(a) Training and checking	783
ORO.TC.115 Initial training	783
AMC1 ORO.TC.115 Initial training	784
ORO.TC.120 Operator conversion training	785
AMC1 ORO.TC.120&.125 Operator conversion training and differences training	785
AMC2 ORO.TC.120&.125 Operator conversion training and differences training	786
ORO.TC.125 Differences training	787
ORO.TC.130 Familiarisation flights	787
ORO.TC.135 Recurrent training	787
AMC1 ORO.TC.135 Recurrent training	787
ORO.TC.140 Refresher training	788
AMC1 ORO.TC.140 Refresher training	788
SUBPART FTL: FLIGHT AND DUTY TIME LIMITATIONS AND REST REQUIREMENTS	789
SECTION 1 – General	789
ORO.FTL.100 Scope	789
ORO.FTL.105 Definitions	789
GM1 ORO.FTL.105(1) Definitions	791
GM2 ORO.FTL.105(1) Definitions	792
GM3 ORO.FTL.105(1) Definitions	792
GM1 ORO.FTL.105(2) Definitions	792
GM1 ORO.FTL.105(3) Definitions	793
GM1 ORO.FTL.105(8) Definitions	793
GM1 ORO.FTL.105(10) Definitions	793
GM1 ORO.FTL.105(17) Definitions	793
ORO.FTL.110 Operator responsibilities	793
AMC1 ORO.FTL.110 Operator responsibilities	794
AMC1 ORO.FTL.110(a) Operator responsibilities	794
AMC1 ORO.FTL.110(j) Operator responsibilities	794
GM1 ORO.FTL.110(j) Operator responsibilities	795
ORO.FTL.115 Crew member responsibilities	795
ORO.FTL.120 Fatigue risk management (FRM)	795
GM1 ORO.FTL.120 Fatigue risk management (FRM)	796
AMC1 ORO.FTL.120(b)(1) Fatigue risk management (FRM)	796
AMC1 ORO.FTL.120(b)(2) Fatigue risk management (FRM)	796
AMC2 ORO.FTL.120(b)(2) Fatigue risk management (FRM)	796
GM1 ORO.FTL.120(b)(3) Fatigue risk management (FRM)	797
AMC1 ORO.FTL.120(b)(4) Fatigue risk management (FRM)	797
AMC2 ORO.FTL.120(b)(4) Fatigue risk management (FRM)	798
AMC1 ORO.FTL.120(b)(5) Fatigue risk management (FRM)	799

AMC1 ORO.FTL.120(b)(6) Fatigue risk management (FRM)	799
AMC1 ORO.FTL.120(b)(7) Fatigue risk management (FRM)	799
ORO.FTL.125 Flight time specification schemes	800
SECTION 2 – Commercial Air Transport Operators	800
ORO.FTL.200 Home base.....	800
ORO.FTL.205 Flight duty period (FDP)	800
GM1 ORO.FTL.205(a)(1) Flight Duty Period (FDP)	803
GM1 ORO.FTL.205(b)(1) Flight duty period (FDP)	803
AMC1 ORO.FTL.205(f) Flight Duty Period (FDP)	804
GM1 ORO.FTL.205(f)(1)(i) Flight Duty Period (FDP)	804
ORO.FTL.210 Flight times and duty periods.....	804
AMC1 ORO.FTL.210(c) Flight times and duty periods	805
ORO.FTL.215 Positioning.....	805
ORO.FTL.220 Split duty	805
ORO.FTL.225 Standby and duties at the airport	805
ORO.FTL.230 Reserve.....	806
GM1 ORO.FTL.230(a) Reserve.....	806
ORO.FTL.235 Rest periods.....	806
GM1 ORO.FTL.235(a)(2) Rest periods	807
AMC1 ORO.FTL.235(b) Rest periods.....	807
ORO.FTL.240 Nutrition	808
AMC1 ORO.FTL.240 Nutrition	808
ORO.FTL.245 Records of home base, flight times, duty and rest periods	808
ORO.FTL.250 Fatigue management training.....	808
AMC1 ORO.FTL.250 Fatigue management training.....	809
CERTIFICATION SPECIFICATIONS AND GUIDANCE MATERIAL FOR COMMERCIAL AIR TRANSPORT BY AEROPLANE — SCHEDULED AND CHARTER OPERATIONS.....	809
CS FTL.1.100 Applicability	809
CS FTL.1.200 Home base	809
GM1 CS FTL.1.200 Home base	810
CS FTL.1.205 Flight duty period (FDP)	810
GM1 CS FTL.1.205(a)(2) Flight duty period (FDP).....	813
GM1 CS FTL.1.205(c)(1)(ii) Flight Duty Period (FDP)	813
GM2 CS FTL.1.205(c)(1)(ii) Flight Duty Period (FDP)	813
GM1 CS FTL.1.205(d) Flight Duty Period (FDP).....	813
CS FTL.1.220 Split duty	814
GM1 CS FTL.1.220(b) Split duty.....	814
CS FTL.1.225 Standby	814
GM1 CS FTL.1.225 Standby	815
GM1 CS FTL.1.225(b) Standby	815
GM1 CS FTL.1.225(b)(2) Standby	815
CS FTL.1.230 Reserve	816
GM1 CS FTL.1.230 Reserve.....	816
GM2 CS FTL.1.230 Reserve.....	816
GM1 CS FTL.1.230(c) Reserve.....	816
CS FTL.1.235 Rest periods	816
GM1 CS FTL.1.235(b)(3) Rest periods.....	818
GM2 CS FTL.1.235(b)(3) Additional rest to compensate for time zone differences.....	818
Appendix I to Annex III (Part-ORO).....	819
ANNEX IV (Part-CAT)	821
SUBPART A: GENERAL REQUIREMENTS	821

CAT.GEN.100 Competent authority	821
SECTION 1 – Motor-powered aircraft	821
CAT.GEN.MPA.100 Crew responsibilities	821
AMC1 CAT.GEN.MPA.100(b) Crew responsibilities	822
AMC1 CAT.GEN.MPA.100(c)(1) Crew responsibilities	822
GM1 CAT.GEN.MPA.100(c)(2) Crew responsibilities	822
CAT.GEN.MPA.105 Responsibilities of the commander	822
GM1 CAT.GEN.MPA.105(a)(10) Responsibilities of the commander	824
CAT.GEN.MPA.110 Authority of the commander	824
CAT.GEN.MPA.115 Personnel or crew members other than cabin crew in the passenger compartment	824
AMC1 CAT.GEN.MPA.115(a) Personnel or crew members other than cabin crew in the passenger compartment	825
GM1 CAT.GEN.MPA.115 Personnel or crew members other than cabin crew in the passenger compartment	825
CAT.GEN.MPA.120 Common language	825
CAT.GEN.MPA.124 Taxiing of aircraft	825
AMC1 CAT.GEN.MPA.124 Taxiing of aircraft	825
CAT.GEN.MPA.125 Taxiing of aeroplanes	826
GM1 CAT.GEN.MPA.125 Taxiing of aeroplanes	826
GM2 CAT.GEN.MPA.125 Taxiing of aeroplanes	827
CAT.GEN.MPA.130 Rotor engagement — helicopters	827
GM1 CAT.GEN.MPA.130 Rotor engagement — helicopters	827
CAT.GEN.MPA.135 Admission to the flight crew compartment	828
AMC1 CAT.GEN.MPA.135(a)(3) Admission to the flight crew compartment	828
CAT.GEN.MPA.140 Portable electronic devices	828
AMC1 CAT.GEN.MPA.140 Portable electronic devices	829
AMC2 CAT.GEN.MPA.140 Portable electronic devices	833
GM1 CAT.GEN.MPA.140 Portable electronic devices	835
GM2 CAT.GEN.MPA.140 Portable electronic devices	836
GM3 CAT.GEN.MPA.140 Portable electronic devices	837
CAT.GEN.MPA.141 Use of electronic flight bags (EFBs)	837
GM1 CAT.GEN.MPA.141 Use of electronic flight bags (EFBs)	837
GM2 CAT.GEN.MPA.141 Use of electronic flight bags (EFBs)	838
AMC1 CAT.GEN.MPA.141(a) Use of electronic flight bags (EFBs)	838
GM1 CAT.GEN.MPA.141(a) Use of electronic flight bags (EFBs)	841
AMC1 CAT.GEN.MPA.141(b) Use of electronic flight bags (EFBs)	842
AMC2 CAT.GEN.MPA.141(b) Use of electronic flight bags (EFBs)	843
AMC3 CAT.GEN.MPA.141(b) Use of electronic flight bags (EFBs)	844
GM1 CAT.GEN.MPA.141(b) Use of electronic flight bags (EFBs)	845
GM2 CAT.GEN.MPA.141(b) Use of electronic flight bags (EFBs)	845
CAT.GEN.MPA.145 Information on emergency and survival equipment carried	845
AMC1 CAT.GEN.MPA.145 Information on emergency and survival equipment carried	846
CAT.GEN.MPA.150 Ditching — aeroplanes	846
CAT.GEN.MPA.155 Carriage of weapons of war and munitions of war	846
GM1 CAT.GEN.MPA.155 Carriage of weapons of war and munitions of war	846
CAT.GEN.MPA.160 Carriage of sporting weapons and ammunition	847
GM1 CAT.GEN.MPA.160 Carriage of sporting weapons and ammunition	847
CAT.GEN.MPA.161 Carriage of sporting weapons and ammunition — alleviations	847
AMC1 CAT.GEN.MPA.161 Carriage of sporting weapons and ammunition — alleviations	848
CAT.GEN.MPA.165 Method of carriage of persons	848
CAT.GEN.MPA.170 Psychoactive substances	848
AMC1 CAT.GEN.MPA.170(b) Psychoactive substances	849
AMC2 CAT.GEN.MPA.170(b) Psychoactive substances	849
GM1 CAT.GEN.MPA.170(b) Psychoactive substances	849

GM2 CAT.GEN.MPA.170(b) Psychoactive substances	850
GM3 CAT.GEN.MPA.170(b) Psychoactive substances	850
GM4 CAT.GEN.MPA.170(b) Psychoactive substances	850
AMC1 CAT.GEN.MPA.170(c) Psychoactive substances	850
CAT.GEN.MPA.175 Endangering safety	851
AMC1 CAT.GEN.MPA.175(b) Endangering safety.....	851
GM1 CAT.GEN.MPA.175(b) Endangering safety	852
AMC1 CAT.GEN.MPA.175(c) Endangering safety	852
CAT.GEN.MPA.180 Documents, manuals and information to be carried.....	852
AMC1 CAT.GEN.MPA.180 Documents, manuals and information to be carried.....	854
GM1 CAT.GEN.MPA.180(a)(1) Documents, manuals and information to be carried	854
GM1 CAT.GEN.MPA.180(a)(5)(6) Documents, manuals and information to be carried.....	854
GM1 CAT.GEN.MPA.180(a)(9) Documents, manuals and information to be carried	855
AMC1 CAT.GEN.MPA.180(a)(13) Documents, manuals and information to be carried	855
GM1 CAT.GEN.MPA.180(a)(14) Documents, manuals and information to be carried	855
AMC1 CAT.GEN.MPA.180(a)(18) Documents, manuals and information to be carried	855
GM1 CAT.GEN.MPA.180(a)(18) Documents, manuals and information to be carried	856
GM2 CAT.GEN.MPA.180(a)(18) Documents, manuals and information to be carried	856
GM3 CAT.GEN.MPA.180(a)(18) Documents, manuals and information to be carried	856
GM1 CAT.GEN.MPA.180(a)(23) Documents, manuals and information to be carried	856
CAT.GEN.MPA.185 Information to be retained on the ground	857
CAT.GEN.MPA.190 Provision of documentation and records	857
CAT.GEN.MPA.195 Handling of flight recorder recordings: preservation, production, protection and use	857
AMC1 CAT.GEN.MPA.195(a) Handling of flight recorder recordings: preservation, production, protection and use	859
GM1 CAT.GEN.MPA.195(a) Handling of flight recorder recordings: preservation, production, protection and use	859
AMC1 CAT.GEN.MPA.195(b) Handling of flight recorder recordings: preservation, production, protection and use	859
GM1 CAT.GEN.MPA.195(b) Handling of flight recorder recordings: preservation, production, protection and use	860
GM2 CAT.GEN.MPA.195(b) Handling of flight recorder recordings: preservation, production, protection and use	861
GM3 CAT.GEN.MPA.195(b) Handling of flight recorder recordings: preservation, production, protection and use	862
AMC1 CAT.GEN.MPA.195(f)(1) Handling of flight recorder recordings: preservation, production, protection and use	862
AMC1 CAT.GEN.MPA.195(f)(1a) Handling of flight recorder recordings: preservation, production, protection and use	863
GM1 CAT.GEN.MPA.195(f)(2) Handling of flight recorder recordings: preservation, production, protection and use	864
AMC1 CAT.GEN.MPA.195(f)(3) Handling of flight recorder recordings: preservation, production, protection and use	864
AMC1 CAT.GEN.MPA.195(f)(3a) Handling of flight recorder recordings: preservation, production, protection and use	865
GM1 CAT.GEN.MPA.195(f) Handling of flight recorder recordings: preservation, production, protection and use	866
CAT.GEN.MPA.200 Transport of dangerous goods.....	866
AMC1 CAT.GEN.MPA.200(e) Transport of dangerous goods	867
GM1 CAT.GEN.MPA.200 Transport of dangerous goods	869
CAT.GEN.MPA.205 Aircraft tracking system — Aeroplanes	870
AMC1 CAT.GEN.MPA.205 Aircraft tracking system — Aeroplanes	870
AMC2 CAT.GEN.MPA.205 Aircraft tracking system — Aeroplanes	872
GM1 CAT.GEN.MPA.205 Aircraft tracking system — Aeroplanes	872
GM2 CAT.GEN.MPA.205 Aircraft tracking system — Aeroplanes	873
GM3 CAT.GEN.MPA.205 Aircraft tracking system — Aeroplanes	873
GM4 CAT.GEN.MPA.205 Aircraft tracking system — Aeroplanes	874
GM5 CAT.GEN.MPA.205 Aircraft tracking system — Aeroplanes	874
GM6 CAT.GEN.MPA.205 Aircraft tracking system — Aeroplanes	875

GM7 CAT.GEN.MPA.205 Aircraft tracking system — Aeroplanes	875
CAT.GEN.MPA.210 Location of an aircraft in distress — Aeroplanes.....	875
AMC1 CAT.GEN.MPA.210 Location of an aircraft in distress — Aeroplanes.....	876
GM1 CAT.GEN.MPA.210 Location of an aircraft in distress — Aeroplanes.....	877
GM2 CAT.GEN.MPA.210 Location of an aircraft in distress — Aeroplanes.....	877
CAT.GEN.MPA.215 Support programme.....	878
AMC1 CAT.GEN.MPA.215 Support programme	879
AMC2 CAT.GEN.MPA.215 Support programme	879
AMC3 CAT.GEN.MPA.215 Support programme	879
AMC4 CAT.GEN.MPA.215 Support programme	880
GM1 CAT.GEN.MPA.215 Support programme	880
GM2 CAT.GEN.MPA.215 Support programme	880
GM3 CAT.GEN.MPA.215 Support programme	881
GM4 CAT.GEN.MPA.215 Support programme	881
GM5 CAT.GEN.MPA.215 Support programme	882
GM6 CAT.GEN.MPA.215 Support programme	882
GM7 CAT.GEN.MPA.215 Support programme	882
GM8 CAT.GEN.MPA.215 Support programme	882
SUBPART B: OPERATING PROCEDURES.....	883
SECTION 1 – Motor-powered aircraft	883
CAT.OP.MPA.100 Use of air traffic services	883
GM1 CAT.OP.MPA.100(a)(2) Use of air traffic services	883
CAT.OP.MPA.101 Altimeter check and settings.....	883
GM1 CAT.OP.MPA.101(b) Altimeter check and settings.....	883
CAT.OP.MPA.105 Use of aerodromes and operating sites	884
AMC1 CAT.OP.MPA.105 Use of aerodromes and operating sites.....	884
CAT.OP.MPA.107 Adequate aerodrome	885
AMC1 CAT.OP.MPA.107 Adequate aerodrome	885
GM1 CAT.OP.MPA.107 Adequate aerodrome	885
CAT.OP.MPA.110 Aerodrome operating minima.....	885
AMC1 CAT.OP.MPA.110 Aerodrome operating minima	886
AMC2 CAT.OP.MPA.110 Aerodrome operating minima	888
AMC3 CAT.OP.MPA.110 Aerodrome operating minima	889
AMC4 CAT.OP.MPA.110 Aerodrome operating minima	891
AMC5 CAT.OP.MPA.110 Aerodrome operating minima	892
AMC6 CAT.OP.MPA.110 Aerodrome operating minima	894
AMC7 CAT.OP.MPA.110 Aerodrome operating minima	896
AMC8 CAT.OP.MPA.110 Aerodrome operating minima	899
AMC9 CAT.OP.MPA.110 Aerodrome operating minima	899
AMC10 CAT.OP.MPA.110 Aerodrome operating minima	899
AMC11 CAT.OP.MPA.110 Aerodrome operating minima	900
AMC12 CAT.OP.MPA.110 Aerodrome operating minima	901
GM1 CAT.OP.MPA.110 Aerodrome operating minima	901
GM2 CAT.OP.MPA.110 Aerodrome operating minima	901
GM3 CAT.OP.MPA.110 Aerodrome operating minima	902
GM4 CAT.OP.MPA.110 Aerodrome operating minima	902
GM5 CAT.OP.MPA.110 Aerodrome operating minima	902
GM6 CAT.OP.MPA.110 Aerodrome operating minima	903
GM7 CAT.OP.MPA.110 Aerodrome operating minima	903
GM8 CAT.OP.MPA.110 Aerodrome operating minima	903
GM9 CAT.OP.MPA.110 Aerodrome operating minima	904
GM1 CAT.OP.MPA.110(b)(6) Aerodrome operating minima	905
CAT.OP.MPA.115 Approach flight technique — aeroplanes	905
AMC1 CAT.OP.MPA.115 Approach flight technique — aeroplanes	905
AMC2 CAT.OP.MPA.115 Approach flight technique — aeroplanes	906
AMC3 CAT.OP.MPA.115 Approach flight technique — aeroplanes	906
AMC1 CAT.OP.MPA.115(a) Approach flight technique — aeroplanes.....	907
GM1 CAT.OP.MPA.115(a) Approach flight techniques — aeroplanes	908

GM1 CAT.OP.MPA.115(b) Approach flight technique — aeroplanes.....	908
CAT.OP.MPA.125 Instrument departure and approach procedures	909
CAT.OP.MPA.126 Performance-based navigation	910
AMC1 CAT.OP.MPA.126 Performance-based navigation.....	910
AMC2 CAT.OP.MPA.126 Performance-based navigation.....	910
AMC3 CAT.OP.MPA.126 Performance-based navigation.....	912
AMC4 CAT.OP.MPA.126 Performance-based navigation.....	912
AMC5 CAT.OP.MPA.126 Performance-based navigation.....	913
AMC6 CAT.OP.MPA.126 Performance-based navigation.....	914
AMC7 CAT.OP.MPA.126 Performance-based navigation.....	914
GM1 CAT.OP.MPA.126 Performance-based navigation.....	914
CAT.OP.MPA.130 Noise abatement procedures — aeroplanes	915
AMC1 CAT.OP.MPA.130 Noise abatement procedures — aeroplanes	915
GM1 CAT.OP.MPA.130 Noise abatement procedures — aeroplanes	915
CAT.OP.MPA.131 Noise abatement procedures — helicopters	916
CAT.OP.MPA.135 Routes and areas of operation — general	916
AMC1 CAT.OP.MPA.135 Routes and areas of operation — general	917
CAT.OP.MPA.136 Routes and areas of operation — single-engined aeroplanes	917
CAT.OP.MPA.137 Routes and areas of operation — helicopters	917
GM1 CAT.OP.MPA.137(b) Routes and areas of operation — helicopters.....	917
CAT.OP.MPA.140 Maximum distance from an adequate aerodrome for two- engined aeroplanes without an ETOPS approval.....	920
AMC1 CAT.OP.MPA.140(d) Maximum distance from an adequate aerodrome for two-engined aeroplanes without an ETOPS approval.....	921
GM1 CAT.OP.MPA.140(c) Maximum distance from an adequate aerodrome for two-engined aeroplanes without an ETOPS approval.....	923
GM1 CAT.OP.MPA.140(d) Maximum distance from an adequate aerodrome for two-engined aeroplanes without an ETOPS approval.....	924
CAT.OP.MPA.145 Establishment of minimum flight altitudes	924
AMC1 CAT.OP.MPA.145(a) Establishment of minimum flight altitudes	925
AMC1.1 CAT.OP.MPA.145(a) Establishment of minimum flight altitudes.....	925
GM1 CAT.OP.MPA.145(a) Establishment of minimum flight altitudes	925
CAT.OP.MPA.150.....	929
CAT.OP.MPA.155 Carriage of special categories of passengers (SCPs)	929
AMC1 CAT.OP.MPA.155(b) Carriage of special categories of passengers (SCPs)	930
AMC2 CAT.OP.MPA.155(b) Carriage of Special Categories of Passengers (SCPs)	930
AMC3 CAT.OP.MPA.155(b) Carriage of Special Categories of Passengers (SCPs)	930
GM1 CAT.OP.MPA.155(b) Carriage of Special Categories of Passengers (SCPs)	931
GM2 CAT.OP.MPA.155(b) Carriage of special categories of passengers (SCPs)	931
GM3 CAT.OP.MPA.155(b) Carriage of Special Categories of Passengers (SCPs)	932
GM4 CAT.OP.MPA.155(b) Carriage of Special Categories of Passengers (SCPs)	932
AMC1 CAT.OP.MPA.155(c) Carriage of Special Categories of Passengers (SCPs).....	933
AMC2 CAT.OP.MPA.155(c) Carriage of Special Categories of Passengers (SCPs).....	933
GM1 CAT.OP.MPA.155(c) Carriage of Special categories of Passengers (SCPs)	933
GM2 CAT.OP.MPA.155(c) Carriage of Special Categories of Passengers (SCPs).....	934
CAT.OP.MPA.160 Stowage of baggage and cargo	935
AMC1 CAT.OP.MPA.160 Stowage of baggage and cargo	935
AMC2 CAT.OP.MPA.160 Stowage of baggage and cargo	935
CAT.OP.MPA.165 Passenger seating.....	936
AMC1 CAT.OP.MPA.165 Passenger seating	936
AMC2 CAT.OP.MPA.165 Passenger seating	936
GM1 CAT.OP.MPA.165 Passenger seating	937
GM2 CAT.OP.MPA.165 Passenger seating	937
CAT.OP.MPA.170 Passenger briefing	937
AMC1 CAT.OP.MPA.170 Passenger briefing.....	937
AMC1.1 CAT.OP.MPA.170 Passenger briefing	939
AMC2 CAT.OP.MPA.170 Passenger briefing.....	939
AMC3 CAT.OP.MPA.170 Passenger briefing.....	939

GM1 CAT.OP.MPA.170(a) Passenger briefing	939
GM2 CAT.OP.MPA.170 Passenger briefing	940
CAT.OP.MPA.175 Flight preparation	942
AMC1 CAT.OP.MPA.175 Flight preparation	943
AMC2 CAT.OP.MPA.175 Flight preparation	943
AMC1 CAT.OP.MPA.175(a) Flight preparation	944
GM1 CAT.OP.MPA.175(b)(5) Flight preparation	945
CAT.OP.MPA.177 Submission of the ATS flight plan	945
AMC1 CAT.OP.MPA.177 Submission of the ATS flight plan	946
CAT.OP.MPA.180 Fuel/energy scheme – aeroplanes	946
AMC1 CAT.OP.MPA.180 Fuel/energy scheme – aeroplanes	947
GM1 CAT.OP.MPA.180 Fuel/energy scheme – aeroplanes	948
GM2 CAT.OP.MPA.180 Fuel/energy scheme – aeroplanes	949
GM3 CAT.OP.MPA.180 Fuel/energy scheme – aeroplanes	950
CAT.OP.MPA.181 Fuel/energy scheme – fuel/energy planning and in-flight re- planning policy – aeroplanes	950
AMC1 CAT.OP.MPA.181 Fuel/energy scheme – fuel/energy planning and in-flight re- planning policy – aeroplanes	952
AMC2 CAT.OP.MPA.181 Fuel/energy scheme – fuel/energy planning and in-flight re- planning policy – aeroplanes	953
AMC3 CAT.OP.MPA.181 Fuel/energy scheme – fuel/energy planning and in-flight re- planning policy – aeroplanes	953
AMC4 CAT.OP.MPA.181 Fuel/energy scheme – Fuel/energy planning and in-flight re- planning policy – aeroplanes	954
AMC5 CAT.OP.MPA.181 Fuel/energy scheme – fuel/energy planning and in-flight re- planning policy – aeroplanes	954
AMC6 CAT.OP.MPA.181 Fuel/energy scheme – fuel/energy planning and in-flight re- planning policy – aeroplanes	954
AMC7 CAT.OP.MPA.181 Fuel/energy scheme – fuel/energy planning and in-flight re- planning policy – aeroplanes	956
AMC8 CAT.OP.MPA.181 Fuel/energy scheme – fuel/energy planning and in-flight re- planning policy – aeroplanes	957
GM1 CAT.OP.MPA.181 Fuel/energy scheme – fuel/energy planning and in-flight re- planning policy – aeroplanes	957
GM2 CAT.OP.MPA.181 Fuel/energy scheme – fuel/energy planning and in-flight re- planning policy – aeroplanes	959
GM3 CAT.OP.MPA.181 Fuel/energy scheme – fuel/energy planning and in-flight re- planning policy – aeroplanes	960
GM4 CAT.OP.MPA.181 Fuel/energy scheme – fuel/energy planning and in-flight re- planning policy – aeroplanes	960
CAT.OP.MPA.182 Fuel/energy scheme – aerodrome selection policy – aeroplanes	960
AMC1 CAT.OP.MPA.182 Fuel/energy scheme – aerodrome selection policy – aeroplanes	961
AMC2 CAT.OP.MPA.182 Fuel/energy scheme – aerodrome selection policy – aeroplanes	962
AMC3 CAT.OP.MPA.182 Fuel/energy scheme – aerodrome selection policy – aeroplanes	962
AMC4 CAT.OP.MPA.182 Fuel/energy scheme – aerodrome selection policy – aeroplanes	964
AMC5 CAT.OP.MPA.182 Fuel/energy scheme – aerodrome selection policy – aeroplanes	964
AMC6 CAT.OP.MPA.182 Fuel/energy scheme – aerodrome selection policy – aeroplanes	965
AMC7 CAT.OP.MPA.182 Fuel/energy scheme – aerodrome selection policy – aeroplanes	965
AMC8 CAT.OP.MPA.182 Fuel/energy scheme – aerodrome selection policy – aeroplanes	966
AMC9 CAT.OP.MPA.182 Fuel/energy scheme – aerodrome selection policy – aeroplanes	967

GM1 CAT.OP.MPA.182 Fuel/energy scheme — aerodrome selection policy — aeroplanes	968
GM2 CAT.OP.MPA.182 Fuel/energy scheme — aerodrome selection policy — aeroplanes	969
GM3 CAT.OP.MPA.182 Fuel/energy scheme — aerodrome selection policy — aeroplanes	970
GM4 CAT.OP.MPA.182 Fuel/energy scheme — aerodrome selection policy — aeroplanes	970
GM1 CAT.OP.MPA.182(d)(1) Fuel/energy scheme — aerodrome selection policy — aeroplanes	970
AMC1 CAT.OP.MPA.182(f) Fuel/energy scheme — aerodrome selection policy — aeroplanes	971
GM1 CAT.OP.MPA.182(f) Fuel/energy scheme — aerodrome selection policy — aeroplanes	971
CAT.OP.MPA.185 Fuel/energy scheme — in-flight fuel/energy management policy — aeroplanes	971
AMC1 CAT.OP.MPA.185(a) Fuel/energy scheme — in-flight fuel/energy management policy — aeroplanes	972
AMC2 CAT.OP.MPA.185(a) Fuel/energy scheme — in-flight fuel/energy management policy — aeroplanes	973
AMC3 CAT.OP.MPA.185(a) Fuel/energy scheme — in-flight fuel/energy management policy — aeroplanes	973
CAT.OP.MPA.190 Fuel/energy scheme — helicopters	974
CAT.OP.MPA.191 Fuel/energy scheme — Fuel/energy planning and in-flight re-planning policy — helicopters	974
AMC1 CAT.OP.MPA.191(b)&(c) Fuel/energy scheme — fuel/energy planning and in-flight re-planning policy — helicopters	975
CAT.OP.MPA.192 Selection of aerodromes and operating sites — helicopters	977
AMC1 CAT.OP.MPA.192 Selection of aerodromes and operating sites — helicopters	978
AMC1 CAT.OP.MPA.192(a) Selection of aerodromes and operating sites — helicopters	981
GM1 CAT.OP.MPA.192(c)&(d) Selection of aerodromes and operating sites — helicopters	981
GM2 CAT.OP.MPA.192(c)&(d) Selection of aerodromes and operating sites — helicopters	982
AMC1 CAT.OP.MPA.192(d) Selection of aerodromes and operating sites — helicopters	983
GM1 CAT.OP.MPA.192(d) Selection of aerodromes and operating sites — helicopters	984
GM2 CAT.OP.MPA.192(d) Selection of aerodromes and operating sites — helicopters	984
CAT.OP.MPA.195 Fuel/energy scheme — in-flight fuel/energy management policy — helicopters	985
AMC1 CAT.OP.MPA.195 Fuel/energy scheme — in-flight fuel/energy management policy — helicopters	985
GM1 CAT.OP.MPA.195 Fuel/energy scheme — in-flight fuel/energy management policy — helicopters	986
CAT.OP.MPA.200 Special refuelling or defuelling of the aircraft	987
AMC1 CAT.OP.MPA.200 Special refuelling or defueling of the aircraft	987
AMC2 CAT.OP.MPA.200 Special refuelling or defueling of the aircraft	988
AMC3 CAT.OP.MPA.200 Special refuelling or defueling of the aircraft	988
AMC4 CAT.OP.MPA.200 Special refuelling or defueling of the aircraft	989
AMC5 CAT.OP.MPA.200 Special refuelling or defueling of the aircraft	989
AMC6 CAT.OP.MPA.200 Special refuelling or defueling of the aircraft	989
AMC7 CAT.OP.MPA.200 Special refuelling or defueling of the aircraft	990
AMC8 CAT.OP.MPA.200 Special refuelling or defueling of the aircraft	991
GM1 CAT.OP.MPA.200 Special refuelling or defueling of the aircraft	991
GM2 CAT.OP.MPA.200 Special refuelling or defueling of the aircraft	991
GM3 CAT.OP.MPA.200 Special refuelling or defuelling of the aircraft	992
CAT.OP.MPA.205 Push back and towing — aeroplanes	992
AMC1 CAT.OP.MPA.205 Push back and towing — aeroplanes	993
CAT.OP.MPA.210 Crew members at stations	993
AMC1 CAT.OP.MPA.210(b) Crew members at stations	993
GM1 CAT.OP.MPA.210 Crew members at stations	994
CAT.OP.MPA.215 Use of headset — aeroplanes	995
CAT.OP.MPA.216 Use of headset — helicopters	995

CAT.OP.MPA.220 Assisting means for emergency evacuation.....	996
CAT.OP.MPA.225 Seats, safety belts and restraint systems.....	996
CAT.OP.MPA.230 Securing of passenger compartment and galley(s).....	996
CAT.OP.MPA.235 Life-jackets — helicopters.....	996
CAT.OP.MPA.240 Smoking on board.....	996
CAT.OP.MPA.245 Meteorological conditions — all aircraft.....	997
CAT.OP.MPA.246 Meteorological conditions — aeroplanes.....	997
CAT.OP.MPA.247 Meteorological conditions — helicopters.....	997
CAT.OP.MPA.250 Ice and other contaminants — ground procedures.....	998
GM1 CAT.OP.MPA.250 Ice and other contaminants — ground procedures.....	998
GM2 CAT.OP.MPA.250 Ice and other contaminants — ground procedures.....	1000
GM3 CAT.OP.MPA.250 Ice and other contaminants — ground procedures.....	1003
CAT.OP.MPA.255 Ice and other contaminants – flight procedures.....	1005
AMC1 CAT.OP.MPA.255 Ice and other contaminants – flight procedures.....	1005
AMC2 CAT.OP.MPA.255 Ice and other contaminants – flight procedures.....	1007
CAT.OP.MPA.260 Fuel/energy and oil supply.....	1008
CAT.OP.MPA.265 Take-off conditions.....	1008
AMC1 CAT.OP.MPA.265(a) Take-off conditions.....	1008
CAT.OP.MPA.270 Minimum flight altitudes.....	1008
CAT.OP.MPA.275 Simulated abnormal situations in flight.....	1009
CAT.OP.MPA.280.....	1009
CAT.OP.MPA.285 Use of supplemental oxygen.....	1009
CAT.OP.MPA.290 Ground proximity detection.....	1009
GM1 CAT.OP.MPA.290 Ground proximity detection.....	1009
CAT.OP.MPA.295 Use of airborne collision avoidance system (ACAS).....	1016
GM1 CAT.OP.MPA.295 Use of airborne collision avoidance system (ACAS).....	1016
CAT.OP.MPA.300 Approach and landing conditions.....	1026
AMC1 CAT.OP.MPA.300(a) Approach and landing conditions - aeroplanes.....	1026
GM1 CAT.OP.MPA.300(a) Approach and landing conditions — aeroplanes.....	1027
CAT.OP.MPA.301 Approach and landing conditions – helicopters.....	1027
AMC1 CAT.OP.MPA.301 Approach and landing conditions — helicopters.....	1027
CAT.OP.MPA.303 In-flight check of the landing distance at time of arrival – aeroplanes.....	1027
AMC1 CAT.OP.MPA.303 In-flight check of the landing distance at time of arrival — aeroplanes.....	1028
GM1 CAT.OP.MPA.303 In-flight check of the landing distance at time of arrival — aeroplanes.....	1029
GM2 CAT.OP.MPA.303 In-flight check of the landing distance at time of arrival — aeroplanes.....	1031
GM3 CAT.OP.MPA.303 In-flight check of the landing distance at time of arrival — aeroplanes.....	1032
AMC1 CAT.OP.MPA.303(e) In-flight check of the landing distance at time of arrival — aeroplanes.....	1032
CAT.OP.MPA.305 Commencement and continuation of approach.....	1034
GM1 CAT.OP.MPA.305 Commencement and continuation of approach.....	1035
AMC1 CAT.OP.MPA.305(a) Commencement and continuation of approach.....	1035
AMC1 CAT.OP.MPA.305(b) Commencement and continuation of approach.....	1036
AMC1 CAT.OP.MPA.305(c) Commencement and continuation of approach.....	1036
CAT.OP.MPA.310 Operating procedures — threshold crossing height — aeroplanes.....	1036
CAT.OP.MPA.311 Reporting on runway braking action.....	1037
AMC1 CAT.OP.MPA.311 Reporting on runway braking action.....	1037
GM1 CAT.OP.MPA.311 Reporting on runway braking action.....	1038
AMC1 CAT.OP.MPA.303 & CAT.OP.MPA.311 In-flight check of the landing distance at time of arrival — aeroplanes & Reporting on runway braking action.....	1038

GM1 CAT.OP.MPA.303 & CAT.OP.MPA.311 In-flight check of the landing distance at time of arrival — aeroplanes & Reporting on runway braking action	1039
CAT.OP.MPA.312 EFVS 200 operations.....	1041
GM1 CAT.OP.MPA.312 EFVS 200 operations	1042
AMC1 CAT.OP.MPA.312(a)(1) EFVS 200 operations	1044
AMC1 CAT.OP.MPA.312(a)(2) EFVS 200 operations	1044
AMC2 CAT.OP.MPA.312(a)(2) EFVS 200 operations	1045
AMC1 CAT.OP.MPA.312(a)(3) EFVS 200 operations	1045
AMC2 CAT.OP.MPA.312(a)(3) EFVS 200 operations	1048
AMC3 CAT.OP.MPA.312(a)(3) EFVS 200 operations	1048
AMC4 CAT.OP.MPA.312(a)(3) EFVS 200 operations	1048
AMC5 CAT.OP.MPA.312(a)(3) EFVS 200 operations	1048
GM1 CAT.OP.MPA.312(a)(3) EFVS 200 operations	1049
AMC1 CAT.OP.MPA.312(a)(4) EFVS 200 operations	1049
AMC1 CAT.OP.MPA.312(a)(8) EFVS 200 operations	1050
AMC1 CAT.OP.MPA.312(c) EFVS 200 operations	1051
GM1 CAT.OP.MPA.312(c) EFVS 200 operations	1051
CAT.OP.MPA.315 Flight hours reporting – helicopters.....	1051
GM1 CAT.OP.MPA.315 Flight hours reporting — helicopters.....	1051
CAT.OP.MPA.320 Aeroplane categories	1051

SUBPART C: AIRCRAFT PERFORMANCE AND OPERATING LIMITATIONS 1053

SECTION 1 – Aeroplanes..... 1053

CHAPTER 1 – General requirements 1053

CAT.POL.A.100 Performance classes..... 1053

CAT.POL.A.105 General..... 1053

CHAPTER 2 – Performance class A 1053

CAT.POL.A.200 General..... 1053

AMC1 CAT.POL.A.200 General..... 1054

CAT.POL.A.205 Take-off 1054

AMC1 CAT.POL.A.205 Take-off 1055

GM1 CAT.POL.A.205 Take-off 1056

CAT.POL.A.210 Take-off obstacle clearance 1057

AMC1 CAT.POL.A.210 Take-off obstacle clearance 1058

AMC2 CAT.POL.A.210 Take-off obstacle clearance 1059

AMC3 CAT.POL.A.210 Take-off obstacle clearance 1059

GM1 CAT.POL.A.210 Take-off obstacle clearance..... 1060

CAT.POL.A.215 En-route – one-engine-inoperative (OEI) 1060

AMC1 CAT.POL.A.215 En-route – one-engine-inoperative (OEI)..... 1061

CAT.POL.A.220 En-route – aeroplanes with three or more engines, two engines inoperative 1062

CAT.POL.A.225 Landing – destination and alternate aerodromes 1062

AMC1 CAT.POL.A.225 Landing – destination and alternate aerodromes..... 1063

AMC2 CAT.POL.A.225 Landing – destination and alternate aerodromes..... 1063

GM1 CAT.POL.A.225 Landing – destination and alternate aerodromes..... 1063

CAT.POL.A.230 Landing – dry runways 1063

AMC1 CAT.POL.A.230 Landing — dry runways 1064

AMC2 CAT.POL.A.230 Landing — dry runways 1065

GM1 CAT.POL.A.230 Landing – dry runways..... 1065

GM1 CAT.POL.A.230 & CAT.POL.A.235 Landing — dry runways & Landing — wet and contaminated runways 1066

GM2 CAT.POL.A.230 & CAT.POL.A.235 Landing — dry runways & Landing — wet and contaminated runways 1070

GM1 CAT.POL.A.230(a) Landing — dry runways..... 1071

GM1 CAT.POL.A.230(d)(2) Landing — dry runways 1072

CAT.POL.A.235 Landing – wet and contaminated runways 1072

AMC1 CAT.POL.A.235 Landing — dry runways 1073

AMC2 CAT.POL.A.235 Landing — wet and contaminated runways 1073

GM1 CAT.POL.A.235(a) and (b) Landing — wet and contaminated runways..... 1074

GM1 CAT.POL.A.235(a)(1) Landing — wet and contaminated runways..... 1074

AMC1 CAT.POL.A.235(a)(3) Landing — wet and contaminated runways..... 1074

CAT.POL.A.240 Approval of operations with increased bank angles 1074

CAT.POL.A.245 Approval of steep approach operations.....	1075
GM1 CAT.POL.A.245(a) Approval of steep approach operations.....	1075
CAT.POL.A.250 Approval of short landing operations.....	1075
CAT.POL.A.255 Approval of reduced required landing distance operations.....	1076
GM1 CAT.POL.A.255(a)(2) Approval of reduced required landing distance operations.....	1078
GM1 CAT.POL.A.255(a)(3) Approval of reduced required landing distance operations.....	1078
AMC1 CAT.POL.A.255(b)(1) Approval of reduced required landing distance operations.....	1078
AMC1 CAT.POL.A.255(b)(2)(iv) Approval of reduced required landing distance operations..	1079
AMC2 CAT.POL.A.255(b)(2)(iv) Approval of reduced required landing distance operations..	1082
GM1 CAT.POL.A.255(b)(2)(iv) Approval of reduced required landing distance operations....	1083
GM2 CAT.POL.A.255(b)(2)(iv) Approval of reduced required landing distance operations....	1083
AMC1 CAT.POL.A.255(b)(2)(v) Approval of reduced required landing distance operations....	1083
GM1 CAT.POL.A.255(b)(2)(v) Approval of reduced required landing distance operations	1084
AMC1 CAT.POL.A.255(b)(2)(vi) Approval of reduced required landing distance operations..	1085
GM1 CAT.POL.A.255(b)(2)(vi) Approval of reduced required landing distance operations....	1085
AMC1 CAT.POL.A.255(b)(2)(vii) Approval of reduced required landing distance operations..	1085
AMC1 CAT.POL.A.255(b)(2)(ix) Approval of reduced required landing distance operations..	1085
CHAPTER 3 – Performance class B	1086
CAT.POL.A.300 General.....	1086
CAT.POL.A.305 Take-off	1086
AMC1 CAT.POL.A.305 Take-off	1087
AMC2 CAT.POL.A.305 Take-off	1087
GM1 CAT.POL.A.305 Take-off	1087
CAT.POL.A.310 Take-off obstacle clearance – multi-engined aeroplanes.....	1088
AMC1 CAT.POL.A.310 Take-off obstacle clearance – multi-engined aeroplanes	1089
AMC2 CAT.POL.A.310 Take-off obstacle clearance – multi-engined aeroplanes	1089
GM1 CAT.POL.A.310 Take-off obstacle clearance – multi-engined aeroplanes	1090
GM2 CAT.POL.A.310 Take-off obstacle clearance – multi-engined aeroplanes	1091
CAT.POL.A.315 En-route – multi-engined aeroplanes	1093
GM1 CAT.POL.A.315 En-route – multi-engined aeroplanes	1093
CAT.POL.A.320 En-route – single-engined aeroplanes.....	1093
AMC1 CAT.POL.A.320 En-route – single-engined aeroplanes	1093
GM1 CAT.POL.A.320 En-route – single-engined aeroplanes	1094
GM2 CAT.POL.A.320 En-route – single-engined aeroplanes	1094
CAT.POL.A.325 Landing – destination and alternate aerodromes	1094
AMC1 CAT.POL.A.325 Landing – destination and alternate aerodromes.....	1094
CAT.POL.A.330 Landing – dry runways	1095
AMC1 CAT.POL.A.330 Landing – dry runways.....	1095
AMC2 CAT.POL.A.330 Landing – dry runways.....	1096
GM1 CAT.POL.A.330 Landing – dry runways.....	1096
GM1 CAT.POL.A.330(a) Landing – dry runways.....	1096
CAT.POL.A.335 Landing – wet and contaminated runways	1096
AMC1 CAT.POL.A.335 Landing – wet and contaminated runways.....	1097
GM1 CAT.POL.A.335 Landing – wet and contaminated runways	1097
GM2 CAT.POL.A.335 Landing – wet and contaminated runways	1097
GM1 CAT.POL.A.335(a)(1) Landing – wet and contaminated runways.....	1097
AMC1 CAT.POL.A.335(a)(3) Landing – wet and contaminated runways.....	1098
GM1 CAT.POL.A.330 & CAT.POL.A.335 Landing – dry runways & Landing – wet and contaminated runways.....	1098
CAT.POL.A.340 Take-off and landing climb requirements	1099
CAT.POL.A.345 Approval of steep approach operations.....	1100
GM1 CAT.POL.A.345(a) Approval of steep approach operations	1101
CAT.POL.A.350 Approval of short landing operations.....	1101
CAT.POL.A.355 Approval of reduced required landing distance operations.....	1102
GM1 CAT.POL.A.355(b) Approval of reduced required landing distance operations	1103
AMC1 CAT.POL.A.355(b)(4) Approval of reduced required landing distance operations.....	1103
AMC1 CAT.POL.A.355(b)(5) and (b)(6) Approval of reduced required landing distance operations	1103
GM1 CAT.POL.A.355(b)(7) Approval of reduced required landing distance operations.....	1104
GM1 CAT.POL.A.355(b)(7) Approval of reduced required landing distance operations.....	1105
AMC1 CAT.POL.A.355(b)(8)(i) Approval of reduced required landing distance operations ...	1106
GM1 CAT.POL.A.355(b)(8)(i) Approval of reduced required landing distance operations	1106
GM1 CAT.POL.A.355(b)(8)(ii) Approval of reduced required landing distance operations	1106
AMC1 CAT.POL.A.355(b)(9) Approval of reduced required landing distance operations.....	1106
AMC1 CAT.POL.A.355(b)(11) Approval of reduced required landing distance operations.....	1107
CHAPTER 4 – Performance class C	1107

CAT.POL.A.400 Take-off	1107
AMC1 CAT.POL.A.400 Take-off	1108
AMC2 CAT.POL.A.400 Take-off	1110
AMC3 CAT.POL.A.400 Take-off	1110
GM1 CAT.POL.A.400 Take-off	1110
CAT.POL.A.405 Take-off obstacle clearance	1110
AMC1 CAT.POL.A.405 Take-off obstacle clearance	1111
AMC2 CAT.POL.A.405 Take-off obstacle clearance	1112
CAT.POL.A.410 En-route – all engines operating	1112
CAT.POL.A.415 En-route – OEI	1113
AMC1 CAT.POL.A.415 En-route – OEI	1113
CAT.POL.A.420 En-route – aeroplanes with three or more engines, two engines inoperative	1114
CAT.POL.A.425 Landing – destination and alternate aerodromes	1115
AMC1 CAT.POL.A.425 Landing – destination and alternate aerodromes	1115
CAT.POL.A.430 Landing – dry runways	1115
AMC1 CAT.POL.A.430 Landing – dry runways	1115
AMC2 CAT.POL.A.430 Landing – dry runways	1116
GM1 CAT.POL.A.430 Landing – dry runways	1116
GM1 CAT.POL.A.430(a) Landing – dry runways	1116
CAT.POL.A.435 Landing – wet and contaminated runways	1116
AMC1 CAT.POL.A.435 Landing – wet and contaminated runways	1117
GM1 CAT.POL.A.435 Landing – wet and contaminated runways	1117
GM1 CAT.POL.A.435(a)(1) Landing – wet and contaminated runways	1117
GM1 CAT.POL.A.430 & CAT.POL.A.435 Landing – dry runways & Landing – wet and contaminated runways	1117
SECTION 2 – Helicopters	1118
CHAPTER 1 – General requirements	1118
CAT.POL.H.100 Applicability	1118
CAT.POL.H.105 General	1119
GM1 CAT.POL.H.105(c)(3)(ii)(A) General	1120
CAT.POL.H.110 Obstacle accountability	1120
GM1 CAT.POL.H.110(a)(2)(i) Obstacle accountability	1121
CHAPTER 2 – Performance class 1	1121
CAT.POL.H.200 General	1121
GM1 CAT.POL.H.200 & CAT.POL.H.300 & CAT.POL.H.400 General	1121
CAT.POL.H.205 Take-off	1122
AMC1 CAT.POL.H.205(b)(4) Take-off	1123
GM1 CAT.POL.H.205(b)(4) Take-off	1123
AMC1 CAT.POL.H.205(e) Take-off	1127
AMC1 CAT.POL.H.205 & CAT.POL.H.220 Take-off and landing	1128
GM1 CAT.POL.H.205&CAT.POL.H.220 Take-off and landing	1129
CAT.POL.H.210 Take-off flight path	1130
CAT.POL.H.215 En-route – critical engine inoperative	1130
GM1 CAT.POL.H.215(b)(3) En-route – critical engine inoperative	1131
CAT.POL.H.220 Landing	1131
GM1 CAT.POL.H.205&CAT.POL.H.220 Take-off and landing	1131
CAT.POL.H.225 Helicopter operations to/from a public interest site	1132
AMC1 CAT.POL.H.225(a)(5) Helicopter operations to/from a public interest site	1133
GM1 CAT.POL.H.225 Helicopter operations to/from a public interest site	1134
GM1 CAT.POL.H.225(a)(6) Helicopter operations to/from a public interest site	1136
CHAPTER 3 – Performance class 2	1137
CAT.POL.H.300 General	1137
GM to Section 2, Chapter 3 performance class 2	1137
CAT.POL.H.305 Operations without an assured safe forced landing capability	1152
AMC1 CAT.POL.H.305(a) Operations without an assured safe forced landing capability	1153
AMC1 CAT.POL.H.305(b) Helicopter operations without an assured safe forced landing capability	1153
AMC2 CAT.POL.H.305(b) Helicopter operations without an assured safe forced landing capability	1155
GM1 CAT.POL.H.305(b) Helicopter operations without an assured safe forced landing capability	1157
CAT.POL.H.310 Take-off	1157
GM1 CAT.POL.H.310(c) & CAT.POL.H.325(c) Take-off and landing	1158

GM1 CAT.POL.H.310 & CAT.POL.H.325 Take-off and landing	1161
AMC1 CAT.POL.H.310(c)(2) and CAT.POL.H.325(c)(2) Take-off and landing	1166
CAT.POL.H.315 Take-off flight path.....	1166
CAT.POL.H.320 En-route – critical engine inoperative.....	1166
CAT.POL.H.325 Landing.....	1166
GM1 CAT.POL.H.310 & CAT.POL.H.325 Take-off and landing	1167
CHAPTER 4 – Performance class 3	1172
CAT.POL.H.400 General.....	1172
GM1 CAT.POL.H.400(c) General.....	1172
CAT.POL.H.405 Take-off	1173
CAT.POL.H.410 En-route	1174
CAT.POL.H.415 Landing.....	1174
CAT.POL.H.420 Helicopter operations over a hostile environment located outside a congested area	1174
AMC1 CAT.POL.H.420 Helicopter operations over a hostile environment located outside a congested area	1175
GM1 CAT.POL.H.420 Helicopter operations over a hostile environment located outside a congested area	1176
GM2 CAT.POL.H.420(a) Helicopter operations over a hostile environment located outside a congested area	1177
SECTION 3 – Mass and balance	1177
CHAPTER 1 – Motor-powered aircraft	1177
CAT.POL.MAB.100 Mass and balance, loading.....	1177
AMC1 CAT.POL.MAB.100(a) Mass and balance, loading.....	1178
AMC1 CAT.POL.MAB.100(b) Mass and balance, loading.....	1179
AMC2 CAT.POL.MAB.100(b) Mass and balance, loading.....	1180
AMC1 CAT.POL.MAB.100(d) Mass and balance, loading.....	1181
AMC2 CAT.POL.MAB.100(d) Mass and balance, loading.....	1181
AMC1 CAT.POL.MAB.100(e) Mass and balance, loading.....	1181
AMC2 CAT.POL.MAB.100(e) Mass and balance, loading.....	1185
GM1 CAT.POL.MAB.100(e) Mass and balance, loading.....	1186
GM2 CAT.POL.MAB.100(e) Mass and Balance, Loading.....	1187
GM3 CAT.POL.MAB.100(e) Mass and balance, loading.....	1191
GM1 CAT.POL.MAB.100(g) Mass and balance, loading.....	1193
GM1 CAT.POL.MAB.100(i) Mass and balance, loading.....	1193
CAT.POL.MAB.105 Mass and balance data and documentation.....	1193
AMC1 CAT.POL.MAB.105(a) Mass and balance data and documentation	1194
AMC1 CAT.POL.MAB.105(b) Mass and balance data and documentation	1195
AMC1 CAT.POL.MAB.105(c) Mass and balance data and documentation	1195
AMC2 CAT.POL.MAB.105(c) Mass and balance data and documentation	1195
SUBPART D: INSTRUMENTS, DATA, EQUIPMENT.....	1196
SECTION 1 – Aeroplanes.....	1196
CAT.IDE.A.100 Instruments and equipment – general	1196
GM1 CAT.IDE.A.100(a) Instruments and equipment – general.....	1197
GM1 CAT.IDE.A.100(b) Instruments and equipment – general	1197
GM1 CAT.IDE.A.100(d) Instruments and equipment – general	1197
CAT.IDE.A.105 Minimum equipment for flight	1197
AMC1 CAT.IDE.A.105 Minimum equipment for flight	1198
GM1 CAT.IDE.A.105 Minimum equipment for flight.....	1198
CAT.IDE.A.110 Spare electrical fuses	1198
GM1 CAT.IDE.A.110 Spare electrical fuses.....	1198
CAT.IDE.A.115 Operating lights.....	1198
CAT.IDE.A.120 Equipment to clear windshield	1199
AMC1 CAT.IDE.A.120 Equipment to clear windshield	1199
CAT.IDE.A.125 Operations under VFR by day – flight and navigational instruments and associated equipment.....	1199
AMC1 CAT.IDE.A.125 & CAT.IDE.A.130 Operations under VFR by day & Operations under IFR or at night – flight and navigational instruments and associated equipment.....	1200
AMC2 CAT.IDE.A.125 Operations under VFR by day — flight and navigational instruments and associated equipment	1200

AMC1 CAT.IDE.A.125(a)(1)(i) & CAT.IDE.A.130(a)(1) Operations under VFR by day & Operations under IFR or at night – flight and navigational instruments and associated equipment.....	1201
AMC1 CAT.IDE.A.125(a)(1)(ii) & CAT.IDE.A.130(a)(2) Operations under VFR by day & Operations under IFR or at night – flight and navigational instruments and associated equipment.....	1201
AMC1 CAT.IDE.A.125(a)(1)(iii) & CAT.IDE.A.130(b) Operations under VFR by day & Operations under IFR or at night – flight and navigational instruments and associated equipment ...	1201
AMC1 CAT.IDE.A.125(a)(1)(iv) & CAT.IDE.A.130(a)(3) Operations under VFR by day & Operations under IFR or at night – flight and navigational instruments and associated equipment.....	1201
AMC1 CAT.IDE.A.125(a)(1)(ix) & CAT.IDE.A.130(a)(8) Operations under VFR by day & operations under IFR or at night – flight and navigational instruments and associated equipment.....	1202
AMC1 CAT.IDE.A.125(b) & CAT.IDE.A.130(h) Operations under VFR by day & Operations under IFR or at night – flight and navigational instruments and associated equipment.....	1202
AMC1 CAT.IDE.A.125(c) & CAT.IDE.A.130(d) Operations under VFR by day & Operations under IFR or at night – flight and navigational instruments and associated equipment.....	1202
GM1 CAT.IDE.A.125 & CAT.IDE.A.130 Operations under VFR by day & Operations under IFR or at night – flight and navigational instruments and associated equipment.....	1202
CAT.IDE.A.130 Operations under IFR or at night – flight and navigational instruments and associated equipment	1204
AMC1 CAT.IDE.A.125 & CAT.IDE.A.130 Operations under VFR by day & Operations under IFR or at night – flight and navigational instruments and associated equipment.....	1205
AMC1 CAT.IDE.A.125(a)(1)(i) & CAT.IDE.A.130(a)(1) Operations under VFR by day & Operations under IFR or at night – flight and navigational instruments and associated equipment.....	1206
AMC1 CAT.IDE.A.125(a)(1)(ii) & CAT.IDE.A.130(a)(2) Operations under VFR by day & Operations under IFR or at night – flight and navigational instruments and associated equipment.....	1206
AMC1 CAT.IDE.A.125(a)(1)(iv) & CAT.IDE.A.130(a)(3) Operations under VFR by day & Operations under IFR or at night – flight and navigational instruments and associated equipment.....	1206
AMC1 CAT.IDE.A.130(a)(5) Operations under IFR or at night – flight and navigational instruments and associated equipment.....	1206
AMC1 CAT.IDE.A.125(a)(1)(ix) & CAT.IDE.A.130(a)(8) Operations under VFR by day & operations under IFR or at night – flight and navigational instruments and associated equipment.....	1206
AMC1 CAT.IDE.A.125(a)(1)(iii) & CAT.IDE.A.130(b) Operations under VFR by day & Operations under IFR or at night – flight and navigational instruments and associated equipment ...	1207
AMC2 CAT.IDE.A.130(b) Operations under IFR or at night – flight and navigational instruments and associated equipment.....	1207
AMC1 CAT.IDE.A.125(c) & CAT.IDE.A.130(d) Operations under VFR by day & Operations under IFR or at night – flight and navigational instruments and associated equipment.....	1207
AMC1 CAT.IDE.A.130(e) Operations under IFR or at night – flight and navigational instruments and associated equipment.....	1207
AMC1 CAT.IDE.A.125(b) & CAT.IDE.A.130(h) Operations under VFR by day & Operations under IFR or at night – flight and navigational instruments and associated equipment.....	1207
AMC1 CAT.IDE.A.130(i)(5) Operations under IFR or at night – flight and navigational instruments and associated equipment.....	1208
AMC1 CAT.IDE.A.130(j) Operations under IFR or at night – flight and navigational instruments and associated equipment.....	1208
GM1 CAT.IDE.A.125 & CAT.IDE.A.130 Operations under VFR by day & Operations under IFR or at night – flight and navigational instruments and associated equipment.....	1208
CAT.IDE.A.135 Additional equipment for single-pilot operation under IFR.....	1209
CAT.IDE.A.140 Altitude alerting system.....	1209
CAT.IDE.A.150 Terrain awareness warning system (TAWS).....	1210
AMC1 CAT.IDE.A.150 Terrain awareness warning system (TAWS)	1210
GM1 CAT.IDE.A.150 Terrain awareness warning system (TAWS)	1210
CAT.IDE.A.155 Airborne collision avoidance system (ACAS).....	1210

CAT.IDE.A.160 Airborne weather detecting equipment	1211
AMC1 CAT.IDE.A.160 Airborne weather detecting equipment	1211
CAT.IDE.A.165 Additional equipment for operations in icing conditions at night	1211
CAT.IDE.A.170 Flight crew interphone system	1211
AMC1 CAT.IDE.A.170 Flight crew interphone system	1211
CAT.IDE.A.175 Crew member interphone system	1211
AMC1 CAT.IDE.A.175 Crew member interphone system	1212
CAT.IDE.A.180 Public address system	1212
AMC1 CAT.IDE.A.180 Public address system	1212
CAT.IDE.A.185 Cockpit voice recorder	1213
AMC1 CAT.IDE.A.185 Cockpit voice recorder	1214
GM1 CAT.IDE.A.185 Cockpit voice recorder	1215
CAT.IDE.A.190 Flight data recorder	1215
AMC1.1 CAT.IDE.A.190 Flight data recorder	1216
AMC1.2 CAT.IDE.A.190 Flight data recorder	1220
AMC2 CAT.IDE.A.190 Flight data recorder	1225
AMC3 CAT.IDE.A.190 Flight data recorder	1229
AMC4 CAT.IDE.A.190 Flight data recorder	1235
AMC5 CAT.IDE.A.190 Flight data recorder	1237
AMC6 CAT.IDE.A.190 Flight data recorder	1241
GM1 CAT.IDE.A.190 Flight data recorder	1242
CAT.IDE.A.191 Lightweight flight recorder	1244
AMC1 CAT.IDE.A.191 Lightweight flight recorder	1244
GM1 CAT.IDE.A.191 Lightweight flight recorder	1245
GM2 CAT.IDE.A.191 Lightweight flight recorder	1246
GM3 CAT.IDE.A.191 Lightweight flight recorder	1246
GM1 CAT.IDE.A.191(e) Lightweight flight recorder	1246
CAT.IDE.A.195 Data link recording	1246
AMC1 CAT.IDE.A.195 Data link recording	1247
GM1 CAT.IDE.A.195 Data link recording	1249
GM1 CAT.IDE.A.195(a) Data link recording	1251
CAT.IDE.A.200 Combination recorder	1251
AMC1 CAT.IDE.A.200 Combination recorder	1251
GM1 CAT.IDE.A.200 Combination recorder	1252
CAT.IDE.A.205 Seats, seat safety belts, restraint systems and child restraint devices	1252
AMC1 CAT.IDE.A.205 Seats, seat safety belts, restraint systems and child restraint devices	1253
AMC2 CAT.IDE.A.205 Seats, seat safety belts, restraint systems and child restraint devices	1255
AMC3 CAT.IDE.A.205 Seats, seat safety belts, restraint systems and child restraint devices	1255
GM1 CAT.IDE.A.205 Seats, seat safety belts, restraint systems and child restraint devices	1256
GM2 CAT.IDE.A.205 Seats, seat safety belts, restraint systems and child restraint devices	1256
CAT.IDE.A.210 Fasten seat belt and no smoking signs	1256
CAT.IDE.A.215 Internal doors and curtains	1256
CAT.IDE.A.220 First-aid kit	1257
AMC1 CAT.IDE.A.220 First-aid kit	1257
AMC2 CAT.IDE.A.220 First-aid kit	1258
GM1 CAT.IDE.A.220 First-aid kit	1259
GM2 CAT.IDE.A.220 First-aid kit	1259
GM3 CAT.IDE.A.220 First-aid kit	1259
GM4 CAT.IDE.A.220 First-aid kit	1259
CAT.IDE.A.225 Emergency medical kit	1259
AMC1 CAT.IDE.A.225 Emergency medical kit	1260

AMC2 CAT.IDE.A.225 Emergency medical kit.....	1261
AMC3 CAT.IDE.A.225 Emergency medical kit.....	1261
AMC4 CAT.IDE.A.225 Emergency medical kit.....	1261
GM1 CAT.IDE.A.225 Emergency medical kit	1262
GM2 CAT.IDE.A.225 Emergency medical kit	1262
GM3 CAT.IDE.A.225 Emergency medical kit	1262
CAT.IDE.A.230 First-aid oxygen.....	1262
GM1 CAT.IDE.A.230 First-aid oxygen	1263
AMC1 CAT.IDE.A.230(d) First-aid oxygen.....	1263
CAT.IDE.A.235 Supplemental oxygen – pressurised aeroplanes	1263
AMC1 CAT.IDE.A.235 Supplemental oxygen – pressurised aeroplanes	1265
AMC2 CAT.IDE.A.235 Supplemental oxygen – pressurised aeroplanes	1265
GM1 CAT.IDE.A.235(b)(1) Supplemental oxygen – pressurised aeroplanes	1266
AMC1 CAT.IDE.A.235(c) Supplemental oxygen – pressurised aeroplanes	1266
GM1 CAT.IDE.A.235(c) Supplemental oxygen – pressurised aeroplanes	1266
AMC1 CAT.IDE.A.235(e) Supplemental oxygen – pressurised aeroplanes	1267
CAT.IDE.A.240 Supplemental oxygen – non-pressurised aeroplanes.....	1267
AMC1 CAT.IDE.A.240 Supplemental oxygen – non-pressurised aeroplanes.....	1268
CAT.IDE.A.245 Crew protective breathing equipment	1268
AMC1 CAT.IDE.A.245 Crew protective breathing equipment	1269
CAT.IDE.A.250 Hand fire extinguishers	1269
AMC1 CAT.IDE.A.250 Hand fire extinguishers.....	1270
CAT.IDE.A.255 Crash axe and crowbar.....	1270
AMC1 CAT.IDE.A.255 Crash axe and crowbar	1270
CAT.IDE.A.260 Marking of break-in points.....	1270
AMC1 CAT.IDE.A.260 Marking of break-in points	1271
CAT.IDE.A.265 Means for emergency evacuation	1271
CAT.IDE.A.270 Megaphones	1272
AMC1 CAT.IDE.A.270 Megaphones.....	1272
CAT.IDE.A.275 Emergency lighting and marking.....	1272
CAT.IDE.A.280 Emergency locator transmitter (ELT)	1273
AMC1 CAT.IDE.A.280 Emergency locator transmitter (ELT).....	1273
AMC2 CAT.IDE.A.280 Emergency locator transmitter (ELT).....	1274
GM1 CAT.IDE.A.280 Emergency locator transmitter (ELT).....	1275
GM2 CAT.IDE.A.280 Emergency locator transmitter (ELT).....	1275
CAT.IDE.A.285 Flight over water	1275
AMC1 CAT.IDE.A.285 Flight over water	1276
AMC1 CAT.IDE.A.285(e)(4) & CAT.IDE.A.305(a)(2) Flight over water & Survival equipment	1277
AMC1 CAT.IDE.A.285(a) Flight over water	1277
AMC2 CAT.IDE.A.285(a) Flight over water	1277
GM1 CAT.IDE.A.285(a) Flight over water	1277
AMC1 CAT.IDE.A.285(f) Flight over water	1277
AMC2 CAT.IDE.A.285(f) Flight over water	1277
GM1 CAT.IDE.A.285(f)(2) Flight over water	1278
CAT.IDE.A.305 Survival equipment	1278
AMC1 CAT.IDE.A.305 Survival equipment.....	1278
AMC1 CAT.IDE.A.285(e)(4) & CAT.IDE.A.305(a)(2) Flight over water & Survival equipment	1279
AMC1 CAT.IDE.A.305(b)(2) Survival equipment.....	1279
GM1 CAT.IDE.A.305 Survival equipment.....	1279
GM2 CAT.IDE.A.305 Survival equipment.....	1279
CAT.IDE.A.325 Headset	1279
AMC1 CAT.IDE.A.325 Headset.....	1280
GM1 CAT.IDE.A.325 Headset	1280
CAT.IDE.A.330 Radio communication equipment	1280
CAT.IDE.A.335 Audio selector panel	1280

CAT.IDE.A.340 Radio equipment for operations under VFR over routes navigated by reference to visual landmarks.....	1280
CAT.IDE.A.345 Communication, navigation and surveillance equipment for operations under IFR or under VFR over routes not navigated by reference to visual landmarks.....	1281
AMC1 CAT.IDE.A.345 Communication and navigation equipment for operations under IFR or under VFR over routes not navigated by reference to visual landmarks	1281
AMC2 CAT.IDE.A.345 Communication and navigation equipment for operations under IFR or under VFR over routes not navigated by reference to visual landmarks	1281
AMC3 CAT.IDE.A.345 Communication and navigation equipment for operations under IFR or under VFR over routes not navigated by reference to visual landmarks	1283
AMC4 CAT.IDE.A.345 Communication and navigation equipment for operations under IFR or under VFR over routes not navigated by reference to visual landmarks	1283
GM1 CAT.IDE.A.345 Communication and navigation equipment for operations under IFR or under VFR over routes not navigated by reference to visual landmarks	1283
GM2 CAT.IDE.A.345 Communication and navigation equipment for operations under IFR or under VFR over routes not navigated by reference to visual landmarks	1284
GM3 CAT.IDE.A.345 Communication and navigation equipment for operations under IFR or under VFR over routes not navigated by reference to visual landmarks	1288
GM1 CAT.IDE.A.345(c) Communication and navigation equipment for operations under IFR or under VFR over routes not navigated by reference to visual landmarks	1288
AMC1 CAT.IDE.A.345(a) Communication, navigation and surveillance equipment for operations under IFR or under VFR over routes not navigated by reference to visual landmarks	1288
GM1 CAT.IDE.A.345(a) Communication, navigation and surveillance equipment for operations under IFR or under VFR over routes not navigated by reference to visual landmarks	1289
CAT.IDE.A.350 Transponder	1292
AMC1 CAT.IDE.A.350 Transponder	1292
CAT.IDE.A.355 Management of aeronautical databases	1292
AMC1 CAT.IDE.A.355 Management of aeronautical databases	1293
GM1 CAT.IDE.A.355 Management of aeronautical databases	1293
GM2 CAT.IDE.A.355 Management of aeronautical databases	1293
GM3 CAT.IDE.A.355 Management of aeronautical databases	1293
SECTION 2 – Helicopters.....	1294
CAT.IDE.H.100 Instruments and equipment – general	1294
GM1 CAT.IDE.H.100(a) Instruments and equipment – general	1294
GM1 CAT.IDE.H.100(b) Instruments and equipment – general	1295
GM1 CAT.IDE.H.100(d) Instruments and equipment – general.....	1295
CAT.IDE.H.105 Minimum equipment for flight	1295
AMC1 CAT.IDE.H.105 Minimum equipment for flight.....	1295
GM1 CAT.IDE.H.105 Minimum equipment for flight.....	1296
CAT.IDE.H.115 Operating lights.....	1296
CAT.IDE.H.125 Operations under VFR by day – flight and navigational instruments and associated equipment.....	1296
AMC1 CAT.IDE.H.125 & CAT.IDE.H.130 Operations under VFR by day & Operations under IFR or at night – flight and navigational instruments and associated equipment.....	1297
AMC1 CAT.IDE.H.125(a)(1)(i) & CAT.IDE.H.130(a)(1) Operations under VFR by day & Operations under IFR or at night – flight and navigational instruments and associated equipment.....	1297
AMC1 CAT.IDE.H.125(a)(1)(ii) & CAT.IDE.H.130(a)(2) Operations under VFR by day & Operations under IFR or at night – flight and navigational instruments and associated equipment.....	1298
AMC1 CAT.IDE.H.125(a)(1)(iii) & CAT.IDE.H.130(b) Operations under VFR by day & Operations under IFR or at night – flight and navigational instruments and associated equipment ...	1298
AMC1 CAT.IDE.H.125(a)(1)(iv) & CAT.IDE.H.130(a)(3) Operations under VFR by day & Operations under IFR or at night – flight and navigational instruments and associated equipment.....	1298

AMC1 CAT.IDE.H.125(a)(1)(vii) & CAT.IDE.H.130(a)(8) Operations under VFR by day & Operations under IFR or at night – flight and navigational instruments and associated equipment.....	1298
AMC1 CAT.IDE.H.125(b) & CAT.IDE.H.130(h) Operations under VFR by day & Operations under IFR or at night – flight and navigational instruments and associated equipment ...	1299
GM1 CAT.IDE.H.125(b) Operations under VFR by day – flight and navigational instruments and associated equipment	1299
AMC1 CAT.IDE.H.125(c)(2) & CAT.IDE.H.130(a)(7) Operations under VFR by day & Operations under IFR or at night – flight and navigational instruments and associated equipment ...	1299
AMC1 CAT.IDE.H.125(d) & CAT.IDE.H.130(d) Operations under VFR by day & Operations under IFR or at night operations – flight and navigational instruments and associated equipment.....	1299
GM1 CAT.IDE.H.125 & CAT.IDE.H.130 Operations under VFR by day & Operations under IFR or at night – flight and navigational instruments and associated equipment.....	1300
CAT.IDE.H.130 Operations under IFR or at night – flight and navigational instruments and associated equipment	1301
GM1 CAT.IDE.H.130(a)(3) Operations under IFR – flight and navigational instruments and associated equipment.....	1302
AMC1 CAT.IDE.H.130(e) Operations under IFR or at night – flight and navigational instruments and associated equipment	1302
AMC1 CAT.IDE.H.130(f)(6) Operations under IFR or at night – flight and navigational instruments and associated equipment.....	1303
GM1 CAT.IDE.H.130(h) Operations under IFR or at night – flight and navigational instruments and associated equipment	1303
AMC1 CAT.IDE.H.130(i) Operations under IFR or at night – flight and navigational instruments and associated equipment	1303
GM1 CAT.IDE.H.125 & CAT.IDE.H.130 Operations under VFR by day & Operations under IFR or at night – flight and navigational instruments and associated equipment.....	1303
CAT.IDE.H.135 Additional equipment for single-pilot operation under IFR	1304
CAT.IDE.H.145 Radio altimeters.....	1304
AMC1 CAT.IDE.H.145 Radio altimeters	1305
AMC2 CAT.IDE.H.145 Radio altimeters	1305
GM1 CAT.IDE.H.145 Radio altimeters	1305
GM2 CAT.IDE.H.145 Radio altimeters	1306
CAT.IDE.H.160 Airborne weather detecting equipment.....	1306
AMC1 CAT.IDE.H.160 Airborne weather detecting equipment.....	1306
CAT.IDE.H.165 Additional equipment for operations in icing conditions at night	1306
CAT.IDE.H.170 Flight crew interphone system	1307
AMC1 CAT.IDE.H.170 Flight crew interphone system	1307
CAT.IDE.H.175 Crew member interphone system	1307
AMC1 CAT.IDE.H.175 Crew member interphone system.....	1307
CAT.IDE.H.180 Public address system	1307
AMC1 CAT.IDE.H.180 Public address system	1308
CAT.IDE.H.185 Cockpit voice recorder	1308
AMC1 CAT.IDE.H.185 Cockpit voice recorder.....	1309
CAT.IDE.H.190 Flight data recorder	1310
AMC1.1 CAT.IDE.H.190 Flight data recorder	1310
AMC1.2 CAT.IDE.H.190 Flight data recorder	1313
AMC2 CAT.IDE.H.190 Flight data recorder.....	1316
AMC3 CAT.IDE.H.190 Flight data recorder.....	1320
GM1 CAT.IDE.H.190 Flight data recorder	1328
CAT.IDE.H.191 Lightweight flight recorder	1328
AMC1 CAT.IDE.H.191 Lightweight flight recorder	1328
GM1 CAT.IDE.H.191 Lightweight flight recorder	1329
GM2 CAT.IDE.H.191 Lightweight flight recorder	1330
GM3 CAT.IDE.H.191 Lightweight flight recorder	1330
GM1 CAT.IDE.H.191(e) Lightweight flight recorder	1330

CAT.IDE.H.195 Data link recording.....	1330
AMC1 CAT.IDE.H.195 Data link recording	1331
GM1 CAT.IDE.H.195 Data link recording	1332
GM1 CAT.IDE.H.195(a) Data link recording.....	1334
CAT.IDE.H.200 Flight data and cockpit voice combination recorder	1334
AMC1 CAT.IDE.H.200 Flight data and cockpit voice combination recorder	1335
CAT.IDE.H.205 Seats, seat safety belts, restraint systems and child restraint devices	1335
AMC1 CAT.IDE.H.205 Seats, seat safety belts, restraint systems and child restraint devices	1335
AMC2 CAT.IDE.H.205 Seats, seat safety belts, restraint systems and child restraint devices	1338
AMC3 CAT.IDE.H.205 Seats, seat safety belts, restraint systems and child restraint devices	1338
CAT.IDE.H.210 Fasten seat belt and no smoking signs	1338
CAT.IDE.H.220 First-aid kits.....	1338
AMC1 CAT.IDE.H.220 First-aid kits	1338
AMC2 CAT.IDE.H.220 First-aid kits	1340
GM1 CAT.IDE.H.220 First-aid kit	1340
GM2 CAT.IDE.H.220 First-aid kit	1341
GM3 CAT.IDE.H.220 First-aid kit	1341
GM4 CAT.IDE.H.220 First-aid kit	1341
CAT.IDE.H.240 Supplemental oxygen – non-pressurised helicopters.....	1341
AMC1 CAT.IDE.H.240 Supplemental oxygen – non-pressurised helicopters.....	1342
CAT.IDE.H.250 Hand fire extinguishers	1342
AMC1 CAT.IDE.H.250 Hand fire extinguishers	1343
CAT.IDE.H.260 Marking of break-in points	1343
AMC1 CAT.IDE.H.260 Marking of break-in points	1344
CAT.IDE.H.270 Megaphones	1344
AMC1 CAT.IDE.H.270 Megaphones.....	1344
CAT.IDE.H.275 Emergency lighting and marking	1344
CAT.IDE.H.280 Emergency locator transmitter (ELT)	1344
AMC1 CAT.IDE.H.280 Emergency locator transmitter (ELT).....	1345
AMC2 CAT.IDE.H.280 Emergency locator transmitter (ELT).....	1345
GM1 CAT.IDE.H.280 Emergency locator transmitter (ELT).....	1346
GM2 CAT.IDE.H.280 Emergency locator transmitter (ELT).....	1346
CAT.IDE.H.290 Life-jackets	1346
AMC1 CAT.IDE.H.290 Life-jackets	1346
AMC2 CAT.IDE.H.290(b) Life-jackets	1347
GM1 CAT.IDE.H.290 Life-jackets	1347
CAT.IDE.H.295 Crew survival suits	1347
GM1 CAT.IDE.H.295 Crew survival suits.....	1347
CAT.IDE.H.300 Life-rafts, survival ELTs and survival equipment on extended overwater flights	1349
AMC1 CAT.IDE.H.300 Life-rafts, survival ELTs and survival equipment on extended overwater flights	1350
AMC1 CAT.IDE.H.300(b)(3) & CAT.IDE.H.305(b) Flight over water & Survival equipment. 1351	
CAT.IDE.H.305 Survival equipment	1351
AMC1 CAT.IDE.H.305 Survival equipment.....	1351
AMC1 CAT.IDE.H.300(b)(3) & CAT.IDE.H.305(b) Flight over water & Survival equipment. 1352	
GM1 CAT.IDE.H.305 Survival equipment	1352
GM2 CAT.IDE.H.305 Survival equipment	1352
CAT.IDE.H.315 Helicopters certified for operating on water – miscellaneous equipment.....	1352
GM1 CAT.IDE.H.315 Helicopters certificated for operating on water – Miscellaneous equipment.....	1353
CAT.IDE.H.320 All helicopters on flights over water – ditching	1353

GM1 CAT.IDE.H.320 Landing on water	1353
AMC1 CAT.IDE.H.320(b) All helicopters on flight over water – ditching	1353
CAT.IDE.H.325 Headset	1353
AMC1 CAT.IDE.H.325 Headset	1354
GM1 CAT.IDE.H.325 Headset	1354
CAT.IDE.H.330 Radio communication equipment	1354
CAT.IDE.H.335 Audio selector panel	1354
CAT.IDE.H.340 Radio equipment for operations under VFR over routes navigated by reference to visual landmarks.....	1354
CAT.IDE.H.345 Communication, navigation and surveillance equipment for operations under IFR or under VFR over routes not navigated by reference to visual landmarks.....	1355
AMC1 CAT.IDE.H.345 Communication and navigation equipment for operations under IFR or under VFR over routes not navigated by reference to visual landmarks	1355
AMC2 CAT.IDE.H.345 Communication and navigation equipment for operations under IFR or under VFR over routes not navigated by reference to visual landmarks	1355
AMC3 CAT.IDE.H.345 Communication and navigation equipment for operations under IFR or under VFR over routes not navigated by reference to visual landmarks	1356
GM1 CAT.IDE.H.345 Communication and navigation equipment for operations under IFR or under VFR over routes not navigated by reference to visual landmarks	1356
GM2 CAT.IDE.H.345 Communication and navigation equipment for operations under IFR or under VFR over routes not navigated by reference to visual landmarks	1356
GM3 CAT.IDE.H.345 Communication and navigation equipment for operations under IFR or under VFR over routes not navigated by reference to visual landmarks	1360
CAT.IDE.H.350 Transponder	1361
AMC1 CAT.IDE.H.350 Transponder	1361
CAT.IDE.H.355 Management of aeronautical databases	1361
AMC1 CAT.IDE.H.355 Management of aeronautical databases	1361
GM1 CAT.IDE.H.355 Management of aeronautical databases.....	1361
GM2 CAT.IDE.H.355 Management of aeronautical databases.....	1362
GM3 CAT.IDE.H.355 Management of aeronautical databases.....	1362

ANNEX V (Part-SPA) 1363

SUBPART A: GENERAL REQUIREMENTS 1363

SPA.GEN.100 Competent authority.....	1363
GM1 SPA.GEN.100(a) Competent authority	1363
SPA.GEN.105 Application for a specific approval.....	1364
AMC1 SPA.GEN.105(a) Application for a specific approval	1364
SPA.GEN.110 Privileges of an operator holding a specific approval	1364
SPA.GEN.115 Changes to a specific approval.....	1364
SPA.GEN.120 Continued validity of a specific approval	1364

SUBPART B: PERFORMANCE-BASED NAVIGATION (PBN) OPERATIONS 1365

SPA.PBN.100 PBN operations.....	1365
GM1 SPA.PBN.100 PBN operations.....	1366
SPA.PBN.105 PBN operational approval	1368
AMC1 SPA.PBN.105(b) PBN operational approval.....	1368
AMC1 SPA.PBN.105(c) PBN operational approval	1376
GM1 SPA.PBN.105(c) PBN operational approval	1376
AMC1 SPA.PBN.105(d) PBN operational approval.....	1378
AMC2 SPA.PBN.105(d) PBN operational approval.....	1379

AMC3 SPA.PBN.105(d) PBN operational approval.....	1383
AMC1 SPA.PBN.105(e) PBN operational approval.....	1383
AMC1 SPA.PBN.105(f) PBN operational approval.....	1384
SUBPART C: OPERATIONS WITH SPECIFIED MINIMUM NAVIGATION PERFORMANCE (MNPS)	1385
SPA.MNPS.100 MNPS operations.....	1385
GM1 SPA.MNPS.100 MNPS operations	1385
SPA.MNPS.105 MNPS operational approval	1385
AMC1 SPA.MNPS.105 MNPS operational approval	1385
SUBPART D: OPERATIONS IN AIRSPACE WITH REDUCED VERTICAL SEPARATION MINIMA (RVSM).....	1387
SPA.RVSM.100 RVSM operations	1387
SPA.RVSM.105 RVSM operational approval.....	1387
AMC1 SPA.RVSM.105 RVSM operational approval.....	1387
AMC2 SPA.RVSM.105 RVSM operational approval.....	1388
AMC3 SPA.RVSM.105 RVSM operational approval.....	1392
GM1 SPA.RVSM.105(d)(9) RVSM operational approval.....	1392
SPA.RVSM.110 RVSM equipment requirements.....	1393
AMC1 SPA.RVSM.110(a) RVSM equipment requirements	1393
SPA.RVSM.115 RVSM height-keeping errors.....	1393
SUBPART E: Low-visibility operations (LVOs) and operations with operational credits	1395
SPA.LVO.100 Low-visibility operations and operations with operational credits.....	1395
GM1 SPA.LVO.100 Low-visibility operations and operations with operational credits.....	1395
GM2 SPA.LVO.100 Low-visibility operations and operations with operational credits.....	1396
AMC1 SPA.LVO.100(a) Low-visibility operations and operations with operational credits.....	1396
AMC2 SPA.LVO.100(a) Low-visibility operations and operations with operational credits.....	1397
GM1 SPA.LVO.100(a) Low-visibility operations and operations with operational credits.....	1398
GM2 SPA.LVO.100(a) Low-visibility operations and operations with operational credits.....	1398
AMC1 SPA.LVO.100(b) Low-visibility operations and operations with operational credits.....	1398
AMC2 SPA.LVO.100(b) Low-visibility operations and operations with operational credits.....	1399
AMC3 SPA.LVO.100(b) Low-visibility operations and operations with operational credits.....	1400
GM1 SPA.LVO.100(b) Low-visibility operations and operations with operational credits.....	1402
GM2 SPA.LVO.100(b) Low-visibility operations and operations with operational credits.....	1403
GM3 SPA.LVO.100(b) Low-visibility operations and operations with operational credits.....	1404

GM4 SPA.LVO.100(b) Low-visibility operations and operations with operational credits.....	1407
AMC1 SPA.LVO.100(c) Low-visibility operations and operations with operational credits.....	1407
AMC2 SPA.LVO.100(c) Low-visibility operations and operations with operational credits.....	1408
AMC3 SPA.LVO.100(c) Low-visibility operations and operations with operational credits.....	1409
AMC4 SPA.LVO.100(c) Low-visibility operations and operations with operational credits.....	1410
GM1 SPA.LVO.100(c) Low-visibility operations and operations with operational credits.....	1413
GM2 SPA.LVO.100(c) Low-visibility operations and operations with operational credits.....	1414
GM3 SPA.LVO.100(c) Low-visibility operations and operations with operational credits.....	1414
GM4 SPA.LVO.100(c) Low-visibility operations and operations with operational credits.....	1414
GM5 SPA.LVO.100(c) Low-visibility operations and operations with operational credits.....	1418
GM6 SPA.LVO.100(c) Low-visibility operations and operations with operational credits.....	1418
SPA.LVO.105 Specific approval criteria	1418
AMC1 SPA.LVO.105(a) Specific approval criteria	1419
GM1 SPA.LVO.105(a) Specific approval criteria	1419
AMC1 SPA.LVO.105(c) Specific approval criteria	1419
AMC2 SPA.LVO.105(c) Specific approval criteria	1419
AMC3 SPA.LVO.105(c) Specific approval criteria	1421
AMC4 SPA.LVO.105(c) Specific approval criteria	1421
AMC5 SPA.LVO.105(c) Specific approval criteria	1422
AMC6 SPA.LVO.105(c) Specific approval criteria	1422
AMC7 SPA.LVO.105(c) Specific approval criteria	1423
GM1 SPA.LVO.105(c) Specific approval criteria	1423
AMC1 SPA.LVO.105(g) Specific approval criteria	1424
AMC2 SPA.LVO.105(g) Specific approval criteria	1425
GM1 SPA.LVO.105(g) Specific approval criteria	1426
GM2 SPA.LVO.105(g) Specific approval criteria	1427
GM3 SPA.LVO.105(g) Specific approval criteria	1429
SPA.LVO.110 Aerodrome-related requirements, including instrument flight procedures	1430
AMC1 SPA.LVO.110 Aerodrome-related requirements, including instrument flight procedures	1430
AMC2 SPA.LVO.110 Aerodrome-related requirements, including instrument flight procedures	1435
AMC3 SPA.LVO.110 Aerodrome-related requirements, including instrument flight procedures	1435
AMC4 SPA.LVO.110 Aerodrome-related requirements, including instrument flight procedures	1437

GM1 SPA.LVO.110 Aerodrome-related requirements, including instrument flight procedures	1437
GM2 SPA.LVO.110 Aerodrome-related requirements, including instrument flight procedures	1437
GM3 SPA.LVO.110 Aerodrome-related requirements, including instrument flight procedures	1440
GM4 SPA.LVO.110 Aerodrome-related requirements, including instrument flight procedures	1441
GM5 SPA.LVO.110 Aerodrome-related requirements, including instrument flight procedures	1441
GM6 SPA.LVO.110 Aerodrome-related requirements, including instrument flight procedures	1442
GM7 SPA.LVO.110 Aerodrome-related requirements, including instrument flight procedures	1442
GM8 SPA.LVO.110 Aerodrome-related requirements, including instrument flight procedures	1445
GM9 SPA.LVO.110 Aerodrome-related requirements, including instrument flight procedures	1451
GM10 SPA.LVO.110 Aerodrome-related requirements, including instrument flight procedures	1453
GM11 SPA.LVO.110 Aerodrome-related requirements, including instrument flight procedures	1453
GM12 SPA.LVO.110 Aerodrome-related requirements, including instrument flight procedures	1454
SPA.LVO.120 Flight crew competence	1455
AMC1 SPA.LVO.120(a) Flight crew competence	1456
AMC2 SPA.LVO.120(a) Flight crew competence	1456
AMC3 SPA.LVO.120(a) Flight crew competence	1456
GM1 SPA.LVO.120(a) Flight crew competence	1457
AMC1 SPA.LVO.120(b) Flight crew competence	1458
AMC2 SPA.LVO.120(b) Flight crew competence	1459
AMC3 SPA.LVO.120(b) Flight crew competence	1463
AMC4 SPA.LVO.120(b) Flight crew competence	1467
AMC5 SPA.LVO.120(b) Flight crew competence	1468
AMC6 SPA.LVO.120(b) Flight crew competence	1468
AMC7 SPA.LVO.120(b) Flight crew competence	1468
GM1 SPA.LVO.120(b) Flight crew competence	1469
GM2 SPA.LVO.120(b) Flight crew competence	1472
GM3 SPA.LVO.120(b) Flight crew competence	1473
SPA.LVO.125 Operating procedures	1473
SPA.LVO.130 Minimum equipment	1473
SUBPART F: EXTENDED RANGE OPERATIONS WITH TWO-ENGINED AEROPLANES (ETOPS)	
.....	1474
SPA.ETOPS.100 ETOPS	1474
SPA.ETOPS.105 ETOPS operational approval	1474
GM1 SPA.ETOPS.105 ETOPS operational approval	1474
SPA.ETOPS.110 ETOPS en-route alternate aerodrome	1474

SPA.ETOPS.115 ETOPS en-route alternate aerodrome planning minima	1475
SUBPART G: TRANSPORT OF DANGEROUS GOODS.....	1476
SPA.DG.100 Transport of dangerous goods	1476
SPA.DG.105 Approval to transport dangerous goods	1476
AMC1 SPA.DG.105(a) Approval to transport dangerous goods.....	1476
AMC1 SPA.DG.105(b) Approval to transport dangerous goods.....	1477
GM1 SPA.DG.105(b)(6) Approval to transport dangerous goods	1477
SPA.DG.110 Dangerous goods information and documentation.....	1477
AMC1 SPA.DG.110(a) Dangerous goods information and documentation	1478
AMC1 SPA.DG.110(b) Dangerous goods information and documentation	1478
SUBPART H: HELICOPTER OPERATIONS WITH NIGHT VISION IMAGING SYSTEMS	1480
SPA.NVIS.100 Night vision imaging system (NVIS) operations.....	1480
SPA.NVIS.110 Equipment requirements for NVIS operations	1480
AMC1 SPA.NVIS.110(b) Equipment requirements for NVIS operations	1481
GM1 SPA.NVIS.110(b) Equipment requirements for NVIS operations	1481
GM1 SPA.NVIS.110(f) Equipment requirements for NVIS operations	1481
SPA.NVIS.120 NVIS operating minima.....	1482
AMC1 SPA.NVIS.120 NVIS operating minima.....	1482
GM1 SPA.NVIS.120 NVIS operating minima.....	1482
SPA.NVIS.130 Crew requirements for NVIS operations	1482
GM1 SPA.NVIS.130(e) Crew requirements for NVIS operations.....	1483
GM2 SPA.NVIS.130(e) Crew requirements for NVIS operations.....	1483
AMC1 SPA.NVIS.130(f)(1) Crew requirements for NVIS operations	1484
AMC1 SPA.NVIS.130(f) Crew requirements for NVIS operations.....	1485
AMC2 SPA.NVIS.130(f) Crew requirements for NVIS operations.....	1485
AMC3 SPA.NVIS.130(f) Crew requirements for NVIS operations.....	1486
GM1 SPA.NVIS.130(f) Crew requirements for NVIS operations	1489
GM2 SPA.NVIS.130(f) Crew requirements for NVIS operations	1492
GM3 SPA.NVIS.130(f) Crew requirements for NVIS operations	1497
GM4 SPA.NVIS.130(f) Crew requirements for NVIS operations	1498
GM5 SPA.NVIS.130(f) Crew requirements for NVIS operations	1499
SPA.NVIS.140 Information and documentation	1499
AMC1 SPA.NVIS.140 Information and documentation.....	1499
GM1 SPA.NVIS.140 Information and documentation.....	1500
SUBPART I: HELICOPTER HOIST OPERATIONS.....	1523
SPA.HHO.100 Helicopter hoist operations (HHO)	1523
SPA.HHO.110 Equipment requirements for HHO	1523
AMC1 SPA.HHO.110(a) Equipment requirements for HHO	1523
SPA.HHO.115 HHO communication	1524
SPA.HHO.125 Performance requirements for HHO	1524
SPA.HHO.130 Crew requirements for HHO.....	1524
AMC1 SPA.HHO.130(b)(2)(ii) Crew requirements for HHO.....	1525
AMC1 SPA.HHO.130(e) Crew requirements for HHO	1526

AMC1 SPA.HHO.130(f)(1) Crew requirements for HHO.....	1526
SPA.HHO.135 HHO passenger briefing.....	1527
SPA.HHO.140 Information and documentation.....	1527
AMC1 SPA.HHO.140 Information and documentation.....	1527
SUBPART J: HELICOPTER EMERGENCY MEDICAL SERVICE OPERATIONS	1528
SPA.HEMS.100 Helicopter emergency medical service (HEMS) operations	1528
GM1 SPA.HEMS.100(a) Helicopter emergency medical service (HEMS) operations	1528
SPA.HEMS.110 Equipment requirements for HEMS operations.....	1532
SPA.HEMS.115 Communication	1532
SPA.HEMS.120 HEMS operating minima.....	1532
GM1 SPA.HEMS.120 HEMS operating minima.....	1533
SPA.HEMS.125 Performance requirements for HEMS operations.....	1533
GM1 SPA.HEMS.125(b)(3) Performance requirements for HEMS operations ..	1534
AMC1 SPA.HEMS.125(b)(4) Performance requirements for HEMS operations.	1534
SPA.HEMS.130 Crew requirements.....	1534
AMC1 SPA.HEMS.130(b)(2) Crew requirements.....	1536
AMC1 SPA.HEMS.130(d) Crew requirements	1536
AMC1 SPA.HEMS.130(e) Crew requirements	1536
GM1 SPA.HEMS.130(e)(2)(ii) Crew requirements.....	1537
AMC1 SPA.HEMS.130(e)(2)(ii)(B) Crew requirements	1537
AMC1 SPA.HEMS.130(f)(1) Crew requirements.....	1537
AMC1 SPA.HEMS.130(f)(2)(ii)(B) Crew requirements.....	1538
SPA.HEMS.135 HEMS medical passenger and other personnel briefing	1538
AMC1 SPA.HEMS.135(a) HEMS medical passenger and other personnel briefing	1539
AMC1.1 SPA.HEMS.135(a) HEMS medical passenger and other personnel briefing	1539
AMC1 SPA.HEMS.135(b) HEMS medical passenger and other personnel briefing	1539
SPA.HEMS.140 Information and documentation.....	1540
AMC1 SPA.HEMS.140 Information and documentation.....	1540
SPA.HEMS.145 HEMS operating base facilities	1540
SPA.HEMS.150 Fuel/energy supply – alleviation.....	1541
SPA.HEMS.155 Refuelling with passengers on board	1541
SUBPART K: HELICOPTER OFFSHORE OPERATIONS.....	1542
SPA.HOFO.100 Helicopter offshore operations (HOFO)	1542
SPA.HOFO.105 Approval for helicopter offshore operations.....	1542
GM1 SPA.HOFO.105(c) Approval for offshore operations.....	1542
SPA.HOFO.110 Operating procedures.....	1542
AMC1 SPA.HOFO.110(a) Operating procedures	1543
AMC1 SPA.HOFO.110(a)(4) Operating procedures.....	1544

AMC1 SPA.HOFO.110(b)(1) Operating procedures.....	1544
AMC1 SPA.HOFO.110(b)(2) Operating procedures.....	1544
AMC1.1 SPA.HOFO.110(b)(2) Operating procedures.....	1544
AMC1 SPA.HOFO.110(b)(5) Operating procedures.....	1545
GM1 SPA.HOFO.110(b)(9) Operating Procedures.....	1545
SPA.HOFO.115 Use of offshore locations.....	1545
AMC1 SPA.HOFO.115 Use of offshore locations.....	1545
GM1 SPA.HOFO.115 Use of offshore locations.....	1550
GM2 SPA.HOFO.115 Use of offshore locations.....	1552
SPA.HOFO.120 Selection of aerodromes and operating sites.....	1553
AMC1 SPA.HOFO.120 Selection of aerodromes and operating sites.....	1553
AMC2 SPA.HOFO.120 Selection of aerodromes and operating sites.....	1554
SPA.HOFO.125 Offshore standard approach procedures (OSAPs).....	1556
AMC1 SPA.HOFO.125 Offshore standard approach procedures (OSAPs)	1557
AMC2 SPA.HOFO.125 Offshore standard approach procedures (OSAPs)	1557
GM1 SPA.HOFO.125 Offshore standard approach procedures (OSAPs)	1559
GM2 SPA.HOFO.125 Offshore standard approach procedures (OSAPs)	1563
AMC1 SPA.HOFO.125(g) Offshore standard approach procedures (OSAPs)	1563
SPA.HOFO.130 Meteorological conditions.....	1564
SPA.HOFO.135 Wind limitations for operations to offshore locations	1564
SPA.HOFO.140 Performance requirements at offshore locations	1564
AMC1 SPA.HOFO.140 Performance requirements – take-off and landing at offshore locations	1565
SPA.HOFO.145 Flight data monitoring (FDM) system.....	1565
AMC1 SPA.HOFO.145 Flight data monitoring (FDM) programme	1565
GM1 SPA.HOFO.145 Flight data monitoring (FDM) programme	1565
GM2 SPA.HOFO.145 Flight data monitoring (FDM) programme	1565
SPA.HOFO.150 Aircraft tracking system.....	1572
AMC1 SPA.HOFO.150 Aircraft tracking system.....	1572
GM1 SPA.HOFO.150 Aircraft tracking system.....	1572
SPA.HOFO.155 Vibration health monitoring (VHM) system	1572
AMC1 SPA.HOFO.155 Vibration health monitoring (VHM) system	1573
GM1 SPA.HOFO.155 Vibration health monitoring (VHM) system	1573
SPA.HOFO.160 Equipment requirements.....	1574
GM1 SPA.HOFO.160(a)(1) Additional equipment requirements	1574
GM1 SPA.HOFO.160(a)(2) Additional equipment requirements	1575
SPA.HOFO.165 Additional procedures and equipment for operations in a hostile environment.....	1575
AMC1 SPA.HOFO.165(c) Additional procedures and equipment for operations in hostile environment.....	1576
AMC1 SPA.HOFO.165(d) Additional procedures and equipment for operations in hostile environment.....	1576
AMC1 SPA.HOFO.165(h) Additional procedures and equipment for operations in a hostile environment.....	1577

GM1 SPA.HOFO.165(h) Additional procedures and equipment for operations in a hostile environment.....	1577
AMC1 SPA.HOFO.165(i) Additional procedures and equipment for operations in a hostile environment.....	1578
SPA.HOFO.170 Crew requirements.....	1578
AMC1 SPA.HOFO.170(a) Crew requirements.....	1579
SUBPART L: SINGLE-ENGINED TURBINE AEROPLANE OPERATIONS AT NIGHT OR IN INSTRUMENT METEOROLOGICAL CONDITIONS (SET-IMC).....	1580
SPA.SET-IMC.100 SET-IMC operations	1580
SPA.SET-IMC.105 SET-IMC operations approval	1580
AMC1 SPA.SET-IMC.105 SET-IMC operations approval	1581
AMC1 SPA.SET-IMC.105(a) SET-IMC operations approval.....	1581
AMC1 SPA.SET-IMC.105(b) SET-IMC operations approval.....	1581
AMC1 SPA.SET-IMC.105(c) SET-IMC operations approval	1582
AMC2 SPA.SET-IMC.105(c) SET-IMC operations approval	1584
AMC1 SPA.SET-IMC.105(d)(2) SET-IMC operations approval	1584
AMC2 SPA.SET-IMC.105(d)(2) SET-IMC operations approval	1585
AMC3 SPA.SET-IMC.105(d)(2) SET-IMC operations approval	1586
GM1 SPA.SET-IMC.105(d)(2) SET-IMC operations approval	1586
GM2 SPA.SET-IMC.105(d)(2) SET-IMC operations approval	1587
AMC1 SPA.SET-IMC.105(d)(4) SET-IMC operations approval	1592
SPA.SET-IMC.110 Equipment requirements for SET-IMC operations	1592
AMC1 SPA.SET-IMC.110(b) Equipment requirements for SET-IMC operations.....	1593
AMC1 SPA.SET-IMC.110(d) Equipment requirements for SET-IMC operations.....	1593
AMC1 SPA.SET-IMC.110(f) Equipment requirements for SET-IMC operations.....	1593
GM1 SPA.SET-IMC.110(f) Equipment requirements for SET-IMC operations ...	1593
GM1 SPA.SET-IMC.110(h) Equipment requirements for SET-IMC operations.....	1594
GM1 SPA.SET-IMC.110(i)(7) Equipment requirements for SET-IMC operations.....	1594
AMC1 SPA.SET-IMC.110(l) Equipment requirements for SET-IMC operations.....	1594
SUBPART M: ELECTRONIC FLIGHT BAGS (EFB).....	1595
SPA.EFB.100 Use of electronic flight bags (EFBs) – operational approval	1595
AMC1 SPA.EFB.100(b) Use of electronic flight bags (EFBs) – operational approval	1595
AMC2 SPA.EFB.100(b) Use of electronic flight bags (EFBs) – Operational approval	1597
AMC3 SPA.EFB.100(b) Use of electronic flight bags (EFBs)	1598
AMC4 SPA.EFB.100(b) Use of electronic flight bags (EFBs)	1600
GM1 SPA.EFB.100(b) Use of electronic flight bags (EFBs) – Operational approval	1600
GM2 SPA.EFB.100(b) Use of electronic flight bags (EFBs) – Operational approval	1602
AMC1 SPA.EFB.100(b)(1) Use of electronic flight bags (EFBs) – Operational approval	1602
AMC1 SPA.EFB.100(b)(2) Use of electronic flight bags (EFBs) – Operational approval	1604
AMC1 SPA.EFB.100(b)(3) Use of electronic flight bags (EFBs) – Operational approval	1606

AMC2 SPA.EFB.100(b)(3) Use of electronic flight bags (EFBs) – Operational approval	1607
AMC3 SPA.EFB.100(b)(3) Use of electronic flight bags (EFBs) – Operational approval	1608
AMC4 SPA.EFB.100(b)(3) Use of electronic flight bags (EFBs) – Operational approval	1611
AMC5 SPA.EFB.100(b)(3) Use of electronic flight bags (EFBs) – Operational approval	1615
AMC6 SPA.EFB.100(b)(3) Use of electronic flight bags (EFBs) – Operational approval	1618
AMC7 SPA.EFB.100(b)(3) Use of electronic flight bags (EFBs) – Operational approval	1620
AMC8 SPA.EFB.100(b)(3) Use of electronic flight bags (EFBs) – Operational approval	1621
AMC9 SPA.EFB.100(b)(3) Use of electronic flight bags (EFBs) – Operational approval	1621
AMC10 SPA.EFB.100(b)(3) Use of electronic flight bags (EFBs) – Operational approval	1623
GM1 SPA.EFB.100(b)(3) Use of electronic flight bags (EFBs) – Operational approval	1625
GM2 SPA.EFB.100(b)(3) Use of electronic flight bags (EFBs) – Operational approval	1626
GM3 SPA.EFB.100(b)(3) Use of electronic flight bags (EFBs) – Operational approval	1628
GM4 SPA.EFB.100(b)(3) Use of electronic flight bags (EFBs) – Operational approval	1628
GM5 SPA.EFB.100(b)(3) Use of electronic flight bags (EFBs) – Operational approval	1629
GM6 SPA.EFB.100(b)(3) Use of electronic flight bags (EFBs) – Operational approval	1629
SUBPART N: HELICOPTER POINT-IN-SPACE APPROACHES AND DEPARTURES WITH REDUCED VFR MINIMA (PINS-VFR)	1630
SPA.PINS-VFR.100 Helicopter point-in-space (PinS) approaches and departures with reduced VFR minima	1630
AMC1 SPA.PINS-VFR.100 Helicopter point-in-space (PinS) approaches and departures with reduced VFR minima	1630
ANNEX VI (Part-NCC)	1634
SUBPART A: GENERAL REQUIREMENTS	1634
NCC.GEN.100 Competent authority	1634
GM1 NCC.GEN.100 Competent authority	1634
NCC.GEN.101 Additional requirements for flight training organisations.....	1634
NCC.GEN.105 Crew responsibilities.....	1634
GM1 NCC.GEN.105(e)(2) Crew responsibilities.....	1635
AMC1 NCC.GEN.105(g) Crew responsibilities	1636
NCC.GEN.106 Pilot-in-command responsibilities and authority	1636
AMC1 NCC.GEN.106 Pilot-in-command responsibilities and authority	1637

AMC2 NCC.GEN.106 Pilot-in-command responsibilities and authority	1638
GM1 NCC.GEN.106 Pilot-in-command responsibilities and authority	1639
GM1 NCC.GEN.106(a)(9) Pilot-in-command responsibilities and authority	1639
GM1 NCC.GEN.106(b) Pilot-in-command responsibilities and authority	1639
AMC1 NCC.GEN.106(c) Pilot-in-command responsibilities and authority	1639
AMC1 NCC.GEN.106(d) Pilot-in-command responsibilities and authority	1640
GM1 NCC.GEN.106(d) Pilot-in-command responsibilities and authority	1640
AMC1 NCC.GEN.106(e) Pilot-in-command responsibilities and authority	1641
NCC.GEN.110 Compliance with laws, regulations and procedures	1642
NCC.GEN.115 Common language	1642
NCC.GEN.119 Taxiing of aircraft	1642
AMC1 NCC.GEN.119 Taxiing of aircraft	1642
NCC.GEN.120 Taxiing of aeroplanes	1643
GM1 NCC.GEN.120 Taxiing of aeroplanes	1643
GM1 NCC.GEN.120(b)(4) Taxiing of aeroplanes	1643
NCC.GEN.125 Rotor engagement – helicopters	1644
GM1 NCC.GEN.125 Rotor engagement	1644
NCC.GEN.130 Portable electronic devices	1645
AMC1 NCC.GEN.130 Portable electronic devices	1645
AMC2 NCC.GEN.130 Portable electronic devices	1649
GM1 NCC.GEN.130 Portable electronic devices	1651
GM2 NCC.GEN.130 Portable electronic devices	1652
GM3 NCC.GEN.130 Portable electronic devices	1653
NCC.GEN.131 Use of electronic flight bags (EFBs)	1653
AMC1 NCC.GEN.131(a) Use of electronic flight bags (EFBs)	1654
AMC1 NCC.GEN.131(b) Use of electronic flight bags (EFBs)	1656
AMC1 NCC.GEN.131(b)(1) Use of electronic flight bags (EFBs)	1656
AMC1 NCC.GEN.131(b)(2) Use of electronic flight bags (EFBs)	1658
AMC2 NCC.GEN.131(b)(2) Use of electronic flight bags (EFBs)	1658
AMC3 NCC.GEN.131(b)(2) Use of electronic flight bags (EFBs)	1661
AMC4 NCC.GEN.131(b)(2) Use of electronic flight bags (EFBs)	1662
AMC5 NCC.GEN.131(b)(2) Use of electronic flight bags (EFBs)	1665
AMC6 NCC.GEN.131(b)(2) Use of electronic flight bags (EFBs)	1667
AMC7 NCC.GEN.131(b)(2) Use of electronic flight bags (EFBs)	1668
AMC8 NCC.GEN.131(b)(2) Use of electronic flight bags (EFBs)	1668
AMC9 NCC.GEN.131(b)(2) Use of electronic flight bags (EFBs)	1670
GM1 NCC.GEN.131(b)(2) Use of electronic flight bags (EFBs)	1672
GM2 NCC.GEN.131(b)(2) Use of electronic flight bags (EFBs)	1672
GM3 NCC.GEN.131(b)(2) Use of electronic flight bags (EFBs)	1672
NCC.GEN.135 Information on emergency and survival equipment carried	1672
AMC1 NCC.GEN.135 Information on emergency and survival equipment carried	1673
NCC.GEN.140 Documents, manuals and information to be carried	1673
AMC1 NCC.GEN.140 Documents, manuals and information to be carried	1674
GM1 NCC.GEN.140(a)(1) Documents, manuals and information to be carried	1674

AMC1 NCC.GEN.140(a)(3) Documents, manuals and information to be carried	1674
GM1 NCC.GEN.140(a)(9) Documents, manuals and information to be carried	1674
AMC1 NCC.GEN.140(a)(11) Documents, manuals and information to be carried	1674
AMC1 NCC.GEN.140(a)(12) Documents, manuals and information to be carried	1675
GM1 NCC.GEN.140(a)(13) Documents, manuals and information to be carried	1675
AMC1 NCC.GEN.140(a)(17) Documents, manuals and information to be carried	1675
GM1 NCC.GEN.140(a)(17) Documents, manuals, and information to be carried	1676
GM2 NCC.GEN.140(a)(17) Documents, manuals, and information to be carried	1676
GM3 NCC.GEN.140(a)(17) Documents, manuals, and information to be carried	1676
GM1 NCC.GEN.140(a)(19) Documents, manuals and information to be carried	1676
NCC.GEN.145 Handling of flight recorder recordings: Preservation, production, protection and use	1677
AMC1 NCC.GEN.145(a) Handling of flight recorder recordings: preservation, production, protection and use	1678
GM1 NCC.GEN.145(a) Handling of flight recorder recordings: preservation, production, protection and use	1678
AMC1 NCC.GEN.145(b) Handling of flight recorder recordings: preservation, production, protection and use	1678
GM1 NCC.GEN.145(b) Handling of flight recorder recordings: preservation, production, protection and use	1679
GM2 NCC.GEN.145(b) Handling of flight recorder recordings: preservation, production, protection and use	1681
GM3 NCC.GEN.145(b) Handling of flight recorder recordings: preservation, production, protection and use	1681
AMC1 NCC.GEN.145(f)(1) Handling of flight recorder recordings: preservation, production, protection and use	1682
AMC1 NCC.GEN.145(f)(1a) Handling of flight recorder recordings: preservation, production, protection and use	1683
AMC1 NCC.GEN.145(f)(3) Handling of flight recorder recordings: preservation, production, protection and use	1683
AMC1 NCC.GEN.145(f)(3a) Handling of flight recorder recordings: preservation, production, protection and use	1684
GM1 NCC.GEN.145(f) Handling of flight recorder recordings: preservation, production, protection and use	1685
NCC.GEN.150 Transport of dangerous goods	1685
AMC1 NCC.GEN.150(e) Transport of dangerous goods	1686
GM1 NCC.GEN.150 Transport of dangerous goods	1688
SUBPART B: OPERATIONAL PROCEDURES.....	1690
NCC.OP.100 Use of aerodromes and operating sites.....	1690

AMC1 NCC.OP.100 Use of aerodromes and operating sites.....	1690
GM1 NCC.OP.100 Use of aerodromes and operating sites.....	1690
NCC.OP.101 Altimeter check and settings	1691
GM1 NCC.OP.101 Altimeter check and settings	1691
NCC.OP.105 Specification of isolated aerodromes – aeroplanes	1691
GM1 NCC.OP.105 Specification of isolated aerodromes – aeroplanes.....	1691
NCC.OP.110 Aerodrome operating minima – general.....	1691
AMC1 NCC.OP.110 Aerodrome operating minima – general	1692
AMC2 NCC.OP.110 Aerodrome operating minima – general	1692
AMC3 NCC.OP.110 Aerodrome operating minima – general.....	1693
AMC4 NCC.OP.110 Aerodrome operating minima – general.....	1695
AMC5 NCC.OP.110 Aerodrome operating minima	1697
AMC6 NCC.OP.110 Aerodrome operating minima – general.....	1700
AMC7 NCC.OP.110 Aerodrome operating minima – general	1701
AMC8 NCC.OP.110 Aerodrome operating minima – general.....	1701
AMC9 NCC.OP.110 Aerodrome operating minima – general.....	1702
GM1 NCC.OP.110 Aerodrome operating minima – general	1703
GM2 NCC.OP.110 Aerodrome operating minima – general	1704
GM3 NCC.OP.110 Aerodrome operating minima – general	1705
GM4 NCC.OP.110 Aerodrome operating minima – general	1706
GM5 NCC.OP.110 Aerodrome operating minima – general	1706
GM6 NCC.OP.110 Aerodrome operating minima – general	1706
GM7 NCC.OP.110 Aerodrome operating minima – general	1707
GM8 NCC.OP.110 Aerodrome operating minima – general	1707
GM9 NCC.OP.110 Aerodrome operating minima – general	1707
GM1 NCC.OP.110(b)(5) Aerodrome operating minima	1708
NCC.OP.112 Aerodrome operating minima – circling operations with aeroplanes ...	1708
GM1 NCC.OP.112 Aerodrome operating minima – circling operations with aeroplanes.....	1708
NCC.OP.113 Aerodrome operating minima – onshore circling operations with helicopters.....	1711
NCC.OP.115 Departure and approach procedures	1711
AMC1 NCC.OP.115 Departure and approach procedures	1712
NCC.OP.116 Performance-based navigation – aeroplanes and helicopters	1712
AMC1 NCC.OP.116 Performance-based navigation – aeroplanes and helicopters	1712
AMC2 NCC.OP.116 Performance-based navigation – aeroplanes and helicopters	1712
AMC3 NCC.OP.116 Performance-based navigation – aeroplanes and helicopters	1714
AMC4 NCC.OP.116 Performance-based navigation – aeroplanes and helicopters	1715
AMC5 NCC.OP.116 Performance-based navigation – aeroplanes and helicopters	1715
AMC6 NCC.OP.116 Performance-based navigation – aeroplanes and helicopters	1716

AMC7 NCC.OP.116 Performance-based navigation – aeroplanes and helicopters	1716
AMC8 NCC.OP.116 Performance-based navigation – aeroplanes and helicopters	1717
GM1 NCC.OP.116 Performance-based navigation – aeroplanes and helicopters	1717
NCC.OP.120 Noise abatement procedures	1717
AMC1 NCC.OP.120 Noise abatement procedures	1717
GM1 NCC.OP.120 Noise abatement procedures	1718
NCC.OP.125 Minimum obstacle clearance altitudes – IFR flights	1718
AMC1 NCC.OP.125 Minimum obstacle clearance altitudes – IFR flights	1719
NCC.OP.130 Fuel/energy scheme – aeroplanes and helicopters	1719
NCC.OP.131 Fuel/energy scheme – fuel/energy planning and in flight re-planning policy – aeroplanes and helicopters	1719
AMC1 NCC.OP.131 Fuel/energy scheme — fuel/energy planning and in-flight re-planning policy — aeroplanes and helicopters	1721
NCC.OP.135 Stowage of baggage and cargo	1722
NCC.OP.140 Passenger briefing	1722
AMC1 NCC.OP.140 Passenger briefing	1723
NCC.OP.145 Flight preparation	1723
GM1 NCC.OP.145(b) Flight preparation	1723
NCC.OP.147 Destination alternate aerodromes planning minima — aeroplanes	1724
NCC.OP.148 Destination alternate aerodrome planning minima — helicopters	1725
NCC.OP.150 Take-off alternate aerodromes — aeroplanes	1725
NCC.OP.151 Destination alternate aerodromes – aeroplanes	1725
NCC.OP.152 Destination alternate aerodromes – helicopters	1726
NCC.OP.153 Destination aerodromes – instrument approach operations	1726
AMC1 NCC.OP.153 Destination aerodromes — instrument approach operations	1727
GM1 NCC.OP.153 Destination aerodromes – instrument approach operations	1728
GM2 NCC.OP.153 Destination aerodromes — instrument approach operations	1728
NCC.OP.155 Refuelling with passengers embarking, on board or disembarking	1729
AMC1 NCC.OP.155 Refuelling with passengers embarking, on board or disembarking	1729
AMC2 NCC.OP.155 Refuelling with passengers embarking, on board or disembarking	1730
GM1 NCC.OP.155 Refuelling with passengers embarking, on board or disembarking	1730
NCC.OP.157 Refuelling with engine(s) and/or rotors turning – helicopters	1730
AMC1 NCC.OP.157 Refuelling with engine(s) running and/or rotors turning — helicopters	1731

AMC2 NCC.OP.157 Refuelling with the engine(s) running and/or rotors turning — helicopters.....	1731
GM1 NCC.OP.157 Refuelling with the engine(s) and/or rotors turning — helicopters	1732
NCC.OP.160 Use of headset	1733
NCC.OP.165 Carriage of passengers.....	1733
AMC1 NCC.OP.165 Carriage of passengers.....	1733
GM1 NCC.OP.165 Carriage of passengers.....	1734
NCC.OP.170 Securing of passenger compartment and galley(s).....	1734
NCC.OP.175 Smoking on board	1734
NCC.OP.180 Meteorological conditions.....	1734
AMC1 NCC.OP.180 Meteorological conditions.....	1735
GM1 NCC.OP.180 Meteorological conditions	1735
NCC.OP.185 Ice and other contaminants – ground procedures	1735
GM1 NCC.OP.185 Ice and other contaminants – ground procedures.....	1735
GM2 NCC.OP.185 Ice and other contaminants – ground procedures.....	1737
GM3 NCC.OP.185 Ice and other contaminants – ground procedures.....	1741
NCC.OP.190 Ice and other contaminants – flight procedures	1742
AMC1 NCC.OP.190 Ice and other contaminants – flight procedures	1743
NCC.OP.195 Take-off conditions — aeroplanes and helicopters.....	1744
NCC.OP.200 Simulated situations in flight	1744
NCC.OP.205 Fuel/energy scheme – in-flight fuel/energy management policy.....	1744
GM1 NCC.OP.205(b)&(d) Fuel/energy scheme — in-flight fuel/energy management policy.....	1745
GM1 NCC.OP.205(c) Fuel/energy scheme — in-flight fuel/energy management policy	1745
NCC.OP.210 Use of supplemental oxygen.....	1745
NCC.OP.215 Ground proximity detection	1746
GM1 NCC.OP.215 Ground proximity detection	1746
NCC.OP.220 Airborne collision avoidance system (ACAS)	1753
GM1 NCC.OP.220 Airborne collision avoidance system (ACAS)	1753
NCC.OP.225 Approach and landing conditions — aeroplanes and helicopters.....	1762
AMC1 NCC.OP.225 Approach and landing conditions — aeroplanes.....	1763
GM1 NCC.OP.225 Approach and landing conditions — aeroplanes.....	1763
GM2 NCC.OP.225 Approach and landing conditions — aeroplanes.....	1765
GM3 NCC.OP.225 Approach and landing conditions — aeroplanes.....	1766
GM4 NCC.OP.225 Approach and landing conditions — aeroplanes.....	1766
GM5 NCC.OP.225 Approach and landing conditions — aeroplanes.....	1767
NCC.OP.226 Approach and landing conditions – helicopters	1768
AMC1 NCC.OP.226 Approach and landing conditions — helicopters.....	1768
NCC.OP.230 Commencement and continuation of approach.....	1768
GM1 NCC.OP.230 Commencement and continuation of approach	1768
AMC1 NCC.OP.230(a) Commencement and continuation of approach	1769

AMC1 NCC.OP.230(b) Commencement and continuation of approach	1769
AMC1 NCC.OP.230(c) Commencement and continuation of approach	1770
GM1 NCC.OP.230(f) Commencement and continuation of approach.....	1770
NCC.OP.235 EFVS 200 operations	1770
GM1 NCC.OP.235 EFVS 200 operations	1771
AMC1 NCC.OP.235(a)(1) EFVS 200 operations	1773
AMC1 NCC.OP.235(a)(2) EFVS 200 operations	1773
AMC2 NCC.OP.235(a)(2) EFVS 200 operations	1773
AMC1 NCC.OP.235(a)(3) EFVS 200 operations	1774
AMC2 NCC.OP.235(a)(3) EFVS 200 operations	1776
AMC3 NCC.OP.235(a)(3) EFVS 200 operations	1777
AMC4 NCC.OP.235(a)(3) EFVS 200 operations	1777
AMC5 NCC.OP.235(a)(3) EFVS 200 operations	1777
GM1 NCC.OP.235(a)(3) EFVS 200 operations	1777
AMC1 NCC.OP.235(a)(4) EFVS 200 operations	1778
AMC1 NCC.OP.235(a)(8) EFVS 200 operations	1779
AMC1 NCC.OP.235(c) EFVS 200 operations	1779
GM1 NCC.OP.235(c) EFVS 200 operations	1780
SUBPART C: AIRCRAFT PERFORMANCE AND OPERATING LIMITATIONS	1781
NCC.POL.100 Operating limitations – all aircraft	1781
NCC.POL.105 Mass and balance, loading	1781
AMC1 NCC.POL.105(a) Mass and balance, loading.....	1783
AMC1 NCC.POL.105(b) Mass and balance, loading	1784
AMC1 NCC.POL.105(c) Mass and balance, loading.....	1784
AMC1 NCC.POL.105(d) Mass and balance, loading	1785
GM1 NCC.POL.105(d) Mass and balance, loading	1786
GM1 NCC.POL.105(e) Mass and balance, loading	1786
GM1 NCC.POL.105(g) Mass and balance, loading.....	1787
NCC.POL.110 Mass and balance data and documentation.....	1787
AMC1 NCC.POL.110(a) Mass and balance data and documentation	1788
AMC2 NCC.POL.110(b) Mass and balance data and documentation	1788
AMC1 NCC.POL.110(c) Mass and balance data and documentation.....	1789
AMC2 NCC.POL.110(c) Mass and balance data and documentation.....	1789
GM1 NCC.POL.110(b) Mass and balance data and documentation	1789
GM2 NCC.POL.110(b) Mass and balance data and documentation	1789
NCC.POL.111 Mass and balance data and documentation – alleviations.....	1790
NCC.POL.115 Performance – general.....	1790
NCC.POL.120 Take-off mass limitations – aeroplanes	1790
NCC.POL.125 Take-off – aeroplanes.....	1790
AMC1 NCC.POL.125 Take-off – aeroplanes	1791
AMC2 NCC.POL.125 Take-off – aeroplanes.....	1791
AMC3 NCC.POL.125 Take-off – aeroplanes.....	1791
GM1 NCC.POL.125 Take-off – aeroplanes	1791
GM2 NCC.POL.125 Take-off – aeroplanes	1792
NCC.POL.130 En-route – one engine inoperative – aeroplanes.....	1792

NCC.POL.135 Landing – aeroplanes	1792
AMC1 NCC.POL.135 Landing – aeroplanes	1792
AMC2 NCC.POL.135 Landing – aeroplanes	1793
GM1 NCC.POL.135 Landing – aeroplanes.....	1793
SUBPART D: INSTRUMENTS, DATA AND EQUIPMENT.....	1794
SECTION 1 – Aeroplanes.....	1794
NCC.IDE.A.100 Instruments and equipment – general.....	1794
GM1 NCC.IDE.A.100(a) Instruments and equipment – general	1795
GM1 NCC.IDE.A.100(b) Instruments and equipment – general	1795
GM1 NCC.IDE.A.100(c) Instruments and equipment – general	1795
GM1 NCC.IDE.A.100(d) Instruments and equipment – general	1796
NCC.IDE.A.105 Minimum equipment for flight.....	1796
AMC1 NCC.IDE.A.105 Minimum equipment for flight	1796
GM1 NCC.IDE.A.105 Minimum equipment for flight	1796
NCC.IDE.A.110 Spare electrical fuses	1796
GM1 NCC.IDE.A.110 Spare electrical fuses	1797
NCC.IDE.A.115 Operating lights	1797
NCC.IDE.A.120 Operations under VFR – flight and navigational instruments and associated equipment.....	1797
AMC1 NCC.IDE.A.120&NCC.IDE.A.125 Operations under VFR & operations under IFR – flight and navigational instruments and associated equipment	1798
AMC2 NCC.IDE.A.120 Operations under VFR – flight and navigational instruments and associated equipment.....	1798
AMC1 NCC.IDE.A.120(a)(1)&NCC.IDE.A.125(a)(1) Operations under VFR & operations under IFR – flight and navigational instruments and associated equipment	1799
AMC1 NCC.IDE.A.120(a)(2)&NCC.IDE.A.125(a)(2) Operations under VFR & operations under IFR – flight and navigational instruments and associated equipment	1799
AMC1 NCC.IDE.A.120(a)(3)&NCC.IDE.A.125(a)(3) Operations under VFR & operations under IFR – flight and navigational instruments and associated equipment	1799
NCC.IDE.A.125 Operations under IFR – flight and navigational instruments and associated equipment.....	1799
AMC1 NCC.IDE.A.120(a)(4)&NCC.IDE.A.125(a)(4) Operations under VFR & operations under IFR – flight and navigational instruments and associated equipment	1800
AMC1 NCC.IDE.A.120(c)&NCC.IDE.A.125(c) Operations under VFR & operations under IFR – flight and navigational instruments and associated equipment	1801
AMC1 NCC.IDE.A.125(a)(9) Operations under IFR – flight and navigational instruments and associated equipment.....	1801
AMC1 NCC.IDE.A.125(d) Operations under IFR – flight and navigational instruments and associated equipment.....	1801
AMC1 NCC.IDE.A.125(f) Operations under IFR – flight and navigational instruments and associated equipment.....	1801
AMC2 NCC.IDE.A.125(a)(3) Operations under IFR – flight and navigational instruments and associated equipment.....	1801
NCC.IDE.A.130 Additional equipment for single-pilot operations under IFR	1802
NCC.IDE.A.135 Terrain awareness warning system (TAWS)	1802
AMC1 NCC.IDE.A.135 Terrain awareness warning system (TAWS).....	1802
GM1 NCC.IDE.A.135 Terrain awareness warning system (TAWS).....	1802
NCC.IDE.A.140 Airborne collision avoidance system (ACAS)	1802
NCC.IDE.A.145 Airborne weather detecting equipment.....	1802
AMC1 NCC.IDE.A.145 Airborne weather detecting equipment	1803
NCC.IDE.A.150 Additional equipment for operations in icing conditions at night	1803
NCC.IDE.A.155 Flight crew interphone system	1803
AMC1 NCC.IDE.A.155 Flight crew interphone system.....	1803
NCC.IDE.A.160 Cockpit voice recorder.....	1803

AMC1 NCC.IDE.A.160 Cockpit voice recorder	1804
NCC.IDE.A.165 Flight data recorder	1805
AMC1 NCC.IDE.A.165 Flight data recorder.....	1805
AMC2 NCC.IDE.A.165 Flight data recorder.....	1809
NCC.IDE.A.170 Data link recording	1814
AMC1 NCC.IDE.A.170 Data link recording.....	1815
GM1 NCC.IDE.A.170 Data link recording.....	1816
GM1 NCC.IDE.A.170(a) Data link recording.....	1818
NCC.IDE.A.175 Flight data and cockpit voice combination recorder.....	1818
AMC1 NCC.IDE.A.175 Flight data and cockpit voice combination recorder.....	1818
GM1 NCC.IDE.A.175 Flight data and cockpit voice combination recorder.....	1819
NCC.IDE.A.180 Seats, seat safety belts, restraint systems and child restraint devices	1819
AMC1 NCC.IDE.A.180 Seats, seat safety belts, restraint systems and child restraint devices	1820
AMC2 NCC.IDE.A.180 Seats, seat safety belts, restraint systems and child restraint devices	1822
AMC3 NCC.IDE.A.180 Seats, seat safety belts, restraint systems and child restraint devices	1822
GM1 NCC.IDE.A.180 Seats, seat safety belts, restraint systems and child restraint devices	1822
GM2 NCC.IDE.A.180 Seats, seat safety belts, restraint systems and child restraint devices	1823
NCC.IDE.A.185 Fasten seat belt and no smoking signs	1823
NCC.IDE.A.190 First-aid kit	1823
AMC1 NCC.IDE.A.190 First-aid kit	1823
AMC2 NCC.IDE.A.190 First-aid kit	1825
GM1 NCC.IDE.A.190 First-aid kit	1825
GM2 NCC.IDE.A.190 First-aid kit	1825
GM3 NCC.IDE.A.190 First-aid kit	1825
GM4 NCC.IDE.A.190 First-aid kit	1826
NCC.IDE.A.195 Supplemental oxygen – pressurised aeroplanes.....	1826
AMC1 NCC.IDE.A.195 Supplemental oxygen – pressurised aeroplanes	1826
GM1 NCC.IDE.A.195(c)(2) Supplemental oxygen – pressurised aeroplanes	1827
NCC.IDE.A.200 Supplemental oxygen – non-pressurised aeroplanes	1827
AMC1 NCC.IDE.A.200 Supplemental oxygen – non-pressurised aeroplanes	1828
NCC.IDE.A.205 Hand fire extinguishers.....	1828
AMC1 NCC.IDE.A.205 Hand fire extinguishers	1828
NCC.IDE.A.206 Crash axe and crowbar	1829
NCC.IDE.A.210 Marking of break-in points	1829
AMC1 NCC.IDE.A.210 Marking of break-in points.....	1830
NCC.IDE.A.215 Emergency locator transmitter (ELT).....	1830
AMC1 NCC.IDE.A.215 Emergency locator transmitter (ELT)	1830
AMC2 NCC.IDE.A.215 Emergency locator transmitter (ELT)	1830
GM1 NCC.IDE.A.215 Emergency locator transmitter (ELT)	1831
GM2 NCC.IDE.A.215 Emergency locator transmitter (ELT)	1831
NCC.IDE.A.220 Flight over water.....	1831
AMC1 NCC.IDE.A.220 Flight over water	1832
AMC2 NCC.IDE.A.220 Flight over water	1832
GM1 NCC.IDE.A.220 Flight over water	1833
NCC.IDE.A.230 Survival equipment.....	1833
AMC1 NCC.IDE.A.230(a)(2) Survival equipment.....	1833
AMC1 NCC.IDE.A.230(a)(3) Survival equipment.....	1833
AMC1 NCC.IDE.A.230(b)(2) Survival equipment	1834
GM1 NCC.IDE.A.230 Survival equipment	1834
GM2 NCC.IDE.A.230 Survival equipment	1834
NCC.IDE.A.240 Headset.....	1834
AMC1 NCC.IDE.A.240 Headset	1835

GM1 NCC.IDE.A.240 Headset	1835
NCC.IDE.A.245 Radio communication equipment	1835
AMC1 NCC.IDE.A.245 & NCC.IDE.A.250 Radio communication equipment & Navigation equipment.....	1835
GM1 NCC.IDE.A.245 Radio communication equipment.....	1836
GM1 NCC.IDE.A.245 & NCC.IDE.A.250 Radio communication equipment & Navigation equipment.....	1836
NCC.IDE.A.250 Navigation equipment	1839
GM1 NCC.IDE.A.250 Navigation equipment	1840
GM2 NCC.IDE.A.250 Navigation equipment	1844
NCC.IDE.A.255 Transponder	1844
AMC1 NCC.IDE.A.255 Transponder	1844
NCC.IDE.A.260 Management of aeronautical databases.....	1844
AMC1 NCC.IDE.A.260 Management of aeronautical databases.....	1845
GM1 NCC.IDE.A.260 Management of aeronautical databases	1845
GM2 NCC.IDE.A.260 Management of aeronautical databases	1845
GM3 NCC.IDE.A.260 Management of aeronautical databases	1845
SECTION 2 – Helicopters.....	1846
NCC.IDE.H.100 Instruments and equipment – general.....	1846
GM1 NCC.IDE.H.100(a) Instruments and equipment – general	1846
GM1 NCC.IDE.H.100(b) Instruments and equipment – general	1847
GM1 NCC.IDE.H.100(c) Instruments and equipment – general	1847
GM1 NCC.IDE.H.100(d) Instruments and equipment – general	1847
NCC.IDE.H.105 Minimum equipment for flight.....	1848
AMC1 NCC.IDE.H.105 Minimum equipment for flight	1848
GM1 NCC.IDE.H.105 Minimum equipment for flight	1848
NCC.IDE.H.115 Operating lights	1848
AMC1 NCC.IDE.H.115 Operating lights.....	1849
NCC.IDE.H.120 Operations under VFR – flight and navigational instruments and associated equipment.....	1849
AMC1 NCC.IDE.H.120&NCC.IDE.H.125 Operations under VFR & operations under IFR – flight and navigational instruments and associated equipment	1850
AMC1 NCC.IDE.H.120(a)(1)&NCC.IDE.H.125(a)(1) Operations under VFR & operations under IFR – flight and navigational instruments and associated equipment	1850
AMC1 NCC.IDE.H.120(a)(2)&NCC.IDE.H.125(a)(2) Operations under VFR & operations under IFR – flight and navigational instruments and associated equipment	1850
AMC1 NCC.IDE.H.120(a)(3)&NCC.IDE.H.125(a)(3) Operations under VFR & operations under IFR – flight and navigational instruments and associated equipment	1850
AMC1 NCC.IDE.H.120(a)(4)&NCC.IDE.H.125(a)(4) Operations under VFR & operations under IFR – flight and navigational instruments and associated equipment	1851
AMC1 NCC.IDE.H.120(b)(1)(iii)&NCC.IDE.H.125(a)(8) Operations under VFR & operations under IFR – flight and navigational instruments and associated equipment	1851
AMC1 NCC.IDE.H.120(c) Operations under VFR – flight and navigational instruments and associated equipment.....	1851
GM1 NCC.IDE.H.120(c) Operations under VFR – flight and navigational instruments and associated equipment	1851
NCC.IDE.H.125 Operations under IFR – flight and navigational instruments and associated equipment.....	1851
GM1 NCC.IDE.H.125(a)(3) Operations under IFR – flight and navigational instruments and associated equipment	1852
AMC1 NCC.IDE.H.125(a)(9) Operations under IFR – flight and navigational instruments and associated equipment	1852
AMC1 NCC.IDE.H.125(c) Operations under IFR – flight and navigational instruments and associated equipment	1853
AMC1 NCC.IDE.H.120(c)&NCC.IDE.H.125(c) Operations under VFR & operations under IFR – flight and navigational instruments and associated equipment	1853
AMC1 NCC.IDE.H.125(d) Operations under VFR & operations under IFR – flight and navigational instruments and associated equipment	1853

AMC1 NCC.IDE.H.125(f) Operations under IFR – flight and navigational instruments and associated equipment.....	1853
NCC.IDE.H.130 Additional equipment for single-pilot operations under IFR	1853
NCC.IDE.H.145 Airborne weather detecting equipment	1854
AMC1 NCC.IDE.H.145 Airborne weather detecting equipment	1854
NCC.IDE.H.150 Additional equipment for operations in icing conditions at night	1854
NCC.IDE.H.155 Flight crew interphone system.....	1854
AMC1 NCC.IDE.H.155 Flight crew interphone system	1854
NCC.IDE.H.160 Cockpit voice recorder.....	1854
AMC1 NCC.IDE.H.160 Cockpit voice recorder	1855
NCC.IDE.H.165 Flight data recorder	1855
AMC1 NCC.IDE.H.165 Flight data recorder	1856
AMC2 NCC.IDE.H.165 Flight data recorder	1858
NCC.IDE.H.170 Data link recording	1861
AMC1 NCC.IDE.H.170 Data link recording.....	1862
GM1 NCC.IDE.H.170 Data link recording.....	1864
GM1 NCC.IDE.H.170(a) Data link recording	1866
NCC.IDE.H.175 Flight data and cockpit voice combination recorder.....	1866
GM1 NCC.IDE.H.175 Flight data and cockpit voice combination recorder	1866
NCC.IDE.H.180 Seats, seat safety belts, restraint systems and child restraint devices	1866
AMC1 NCC.IDE.H.180 Seats, seat safety belts, restraint systems and child restraint devices	1867
AMC2 NCC.IDE.H.180 Seats, seat safety belts, restraint systems and child restraint devices	1869
AMC3 NCC.IDE.H.180 Seats, seat safety belts, restraint systems and child restraint devices	1869
NCC.IDE.H.185 Fasten seat belt and no smoking signs.....	1869
NCC.IDE.H.190 First-aid kit.....	1870
AMC1 NCC.IDE.H.190 First-aid kit	1870
AMC2 NCC.IDE.H.190 First-aid kit	1871
GM1 NCC.IDE.H.190 First-aid kit	1871
GM2 NCC.IDE.H.190 First-aid kit	1872
GM3 NCC.IDE.H.190 First-aid kit	1872
GM4 NCC.IDE.H.190 First-aid kit	1872
NCC.IDE.H.200 Supplemental oxygen – non-pressurised helicopters	1872
AMC1 NCC.IDE.H.200 Supplemental oxygen – non-pressurised helicopters	1873
NCC.IDE.H.205 Hand fire extinguishers	1873
AMC1 NCC.IDE.H.205 Hand fire extinguishers	1873
NCC.IDE.H.210 Marking of break-in points.....	1874
AMC1 NCC.IDE.H.210 Marking of break-in points.....	1874
NCC.IDE.H.215 Emergency locator transmitter (ELT)	1874
AMC1 NCC.IDE.H.215 Emergency locator transmitter (ELT)	1874
AMC2 NCC.IDE.H.215 Emergency locator transmitter (ELT)	1875
GM1 NCC.IDE.H.215 Emergency locator transmitter (ELT)	1875
GM2 NCC.IDE.H.215 Emergency locator transmitter (ELT)	1875
NCC.IDE.H.225 Life-jackets.....	1875
AMC1 NCC.IDE.H.225(a) Life-jackets.....	1876
AMC1 NCC.IDE.H.225(b) Life-jackets.....	1876
GM1 NCC.IDE.H.225 Life-jackets	1876
NCC.IDE.H.226 Crew survival suits	1876
GM1 NCC.IDE.H.226 Crew survival suits	1876
NCC.IDE.H.227 Life-rafts, survival ELTs and survival equipment on extended overwater flights	1878
AMC1 NCC.IDE.H.227 Life-rafts, survival ELTs and survival equipment on extended overwater flights	1879

AMC1 NCC.IDE.H.227(b)(3) Life rafts, survival ELTs, and survival equipment on extended overwater flights.....	1880
NCC.IDE.H.230 Survival equipment.....	1880
AMC1 NCC.IDE.H.230 Survival equipment	1880
AMC2 NCC.IDE.H.230 Survival equipment	1881
GM1 NCC.IDE.H.230 Survival equipment	1881
GM2 NCC.IDE.H.230 Survival equipment	1881
NCC.IDE.H.231.....	1881
NCC.IDE.H.232 Helicopters certified for operating on water – miscellaneous equipment.....	1881
GM1 NCC.IDE.H.232 Helicopters certificated for operating on water – Miscellaneous equipment.....	1882
NCC.IDE.H.235 All helicopters on flights over water – ditching.....	1882
AMC1 NCC.IDE.H.235 All helicopters on flight over water – ditching.....	1882
NCC.IDE.H.240 Headset.....	1882
GM1 NCC.IDE.H.240 Headset.....	1882
NCC.IDE.H.245 Radio communication equipment.....	1883
GM1 NCC.IDE.H.245 Radio communication equipment	1883
NCC.IDE.H.250 Navigation equipment.....	1883
GM1 NCC.IDE.H.250 Navigation equipment	1884
GM2 NCC.IDE.H.250 Navigation equipment	1887
NCC.IDE.H.255 Transponder	1888
AMC1 NCC.IDE.H.255 Transponder.....	1888
NCC.IDE.H.260 Management of aeronautical databases.....	1888
AMC1 NCC.IDE.H.260 Management of aeronautical databases	1888
GM1 NCC.IDE.H.260 Management of aeronautical databases	1889
GM2 NCC.IDE.H.260 Management of aeronautical databases	1889
GM3 NCC.IDE.H.260 Management of aeronautical databases	1889

ANNEX VII (Part-NCO) 1890

SUBPART A: GENERAL REQUIREMENTS 1890

NCO.GEN.100 Competent authority	1890
GM1 NCO.GEN.100(b) Competent authority.....	1890
NCO.GEN.101 Means of compliance.....	1890
NCO.GEN.103 Introductory flights	1890
NCO.GEN.104 Use of aircraft included in an AOC by an NCO operator.....	1891
AMC1 NCO.GEN.104 Use of aircraft included in an AOC by an NCO operator..	1891
GM1 NCO.GEN.104 Use of aircraft included in an AOC by an NCO operator....	1892
GM1 NCO.GEN.104(c) Use of aircraft included in an AOC by an NCO operator	1892
NCO.GEN.105 Pilot-in-command responsibilities and authority	1892
AMC1 NCO.GEN.105 Pilot-in-command responsibilities and authority	1894
AMC2 NCO.GEN.105 Pilot-in-command responsibilities and authority	1894
GM1 NCO.GEN.105 Pilot-in-command responsibilities and authority	1895
GM1 NCO.GEN.105(a)(8) Pilot-in-command responsibilities and authority.....	1895
AMC1 NCO.GEN.105(a)(3) Pilot-in-command responsibilities and authority....	1895
GM1 NCO.GEN.105(d) Pilot-in-command responsibilities and authority.....	1896
AMC1 NCO.GEN.105(e) Pilot-in-command responsibilities and authority.....	1896
NCO.GEN.110 Compliance with laws, regulations and procedure.....	1896
NCO.GEN.115 Taxiing of aeroplanes	1897

GM1 NCO.GEN.115 Taxiing of aeroplanes	1897
GM1 NCO.GEN.115(b)(4) Taxiing of aeroplanes	1897
NCO.GEN.120 Rotor engagement – helicopters	1898
GM1 NCO.GEN.120 Rotor engagement	1898
NCO.GEN.125 Portable electronic devices	1898
AMC1 NCO.GEN.125 Portable electronic devices (PEDs)	1898
AMC2 NCO.GEN.125 Portable electronic devices (PEDs)	1899
GM1 NCO.GEN.125 Portable electronic devices.....	1900
GM2 NCO.GEN.125 Portable electronic devices.....	1901
NCO.GEN.130 Information on emergency and survival equipment carried	1901
AMC1 NCO.GEN.130 Information on emergency and survival equipment carried	1901
NCO.GEN.135 Documents, manuals and information to be carried.....	1902
AMC1 NCO.GEN.135(a)(3) Documents, manuals and information to be carried	1902
AMC1 NCO.GEN.135(a)(10) Documents, manuals and information to be carried	1903
GM1 NCO.GEN.135 Documents, manuals and information to be carried.....	1903
GM1 NCO.GEN.135(a)(1) Documents, manuals and information to be carried	1903
GM1 NCO.GEN.135(a)(8) Documents, manuals and information to be carried	1904
GM1 NCO.GEN.135(a)(11) Documents, manuals and information to be carried	1904
GM1 NCO.GEN.135(a)(13) Documents, manuals and information to be carried	1904
NCO.GEN.140 Transport of dangerous goods.....	1904
GM1 NCO.GEN.140(a) Transport of dangerous goods	1905
AMC1 NCO.GEN.140(d) Transport of dangerous goods	1906
AMC1 NCO.GEN.140(f) Transport of dangerous goods	1908
GM1 NCO.GEN.140(f) Transport of dangerous goods	1908
NCO.GEN.145 Immediate reaction to a safety problem	1908
NCO.GEN.150 Journey log	1909
AMC1 NCO.GEN.150 Journey log.....	1909
NCO.GEN.155 Minimum equipment list	1909
AMC1 NCO.GEN.155 Minimum equipment list	1910
AMC2 NCO.GEN.155 Minimum equipment list	1911
AMC3 NCO.GEN.155 Minimum equipment list	1911
AMC4 NCO.GEN.155 Minimum equipment list	1911
AMC5 NCO.GEN.155 Minimum equipment list	1912
GM1 NCO.GEN.155 Minimum equipment list	1912
GM2 NCO.GEN.155 Minimum equipment list	1913
GM3 NCO.GEN.155 Minimum equipment list	1913
GM4 NCO.GEN.155 Minimum equipment list	1913
SUBPART B: OPERATIONAL PROCEDURES.....	1914
NCO.OP.100 Use of aerodromes and operating sites	1914
NCO.OP.101 Altimeter check and settings.....	1914

AMC1 NCO.OP.101(a) Altimeter check and settings	1914
NCO.OP.105.....	1914
NCO.OP.110 Aerodrome operating minima — aeroplanes and helicopters	1914
AMC1 NCO.OP.110 Aerodrome operating minima — aeroplanes and helicopters	1915
AMC2 NCO.OP.110 Aerodrome operating minima — aeroplanes and helicopters	1916
AMC3 NCO.OP.110 Aerodrome operating minima — aeroplanes and helicopters	1918
GM1 NCO.OP.110 Aerodrome operating minima — aeroplanes and helicopters	1919
GM2 NCO.OP.110 Aerodrome operating minima — aeroplanes and helicopters	1919
GM3 NCO.OP.110 Aerodrome operating minima — aeroplanes and helicopters	1919
GM4 NCO.OP.110 Aerodrome operating minima — aeroplanes and helicopters	1920
GM5 NCO.OP.110 Aerodrome operating minima — aeroplanes and helicopters	1920
GM1 NCO.OP.110(b)(5) Aerodrome operating minima — aeroplanes and helicopters.....	1920
NCO.OP.111 Aerodrome operating minima — 2D and 3D approach operations.....	1920
AMC1 NCO.OP.111 Aerodrome operating minima — 2D and 3D approach operations	1921
GM1 NCO.OP.111 Aerodrome operating minima — 2D and 3D approach operations	1922
GM2 NCO.OP.111 Aerodrome operating minima — 2D and 3D approach operations	1923
GM3 NCO.OP.111 Aerodrome operating minima — 2D and 3D approach operations	1923
NCO.OP.112 Aerodrome operating minima — circling operations with aeroplanes ..	1923
GM1 NCO.OP.112 Aerodrome operating minima — circling operations with aeroplanes.....	1924
GM2 NCO.OP.112 Aerodrome operating minima — circling operations with aeroplanes.....	1927
NCO.OP.113 Aerodrome operating minima – onshore circling operations with helicopters.....	1927
NCO.OP.115 Departure and approach procedures – aeroplanes and helicopters	1927
AMC1 NCO.OP.115 Departure and approach procedures — aeroplanes and helicopters.....	1927
NCO.OP.116 Performance-based navigation – aeroplanes and helicopters.....	1928
AMC1 NCO.OP.116 Performance-based navigation – aeroplanes and helicopters	1928
AMC2 NCO.OP.116 Performance-based navigation – aeroplanes and helicopters	1928
AMC3 NCO.OP.116 Performance-based navigation – aeroplanes and helicopters	1930

AMC4 NCO.OP.116 Performance-based navigation – aeroplanes and helicopters	1931
AMC5 NCO.OP.116 Performance-based navigation – aeroplanes and helicopters	1931
AMC6 NCO.OP.116 Performance-based navigation – aeroplanes and helicopters	1932
AMC7 NCO.OP.116 Performance-based navigation – aeroplanes and helicopters	1932
AMC8 NCO.OP.116 Performance-based navigation – aeroplanes and helicopters	1933
GM1 NCO.OP.116 Performance-based navigation – aeroplanes and helicopters	1933
NCO.OP.120 Noise abatement procedures – aeroplanes and helicopters	1933
NCO.OP.125 Fuel/energy and oil supply – aeroplanes and helicopters	1934
AMC1 NCO.OP.125(b) Fuel/energy and oil supply – aeroplanes and helicopters	1934
AMC2 NCO.OP.125(b) Fuel/energy and oil supply – aeroplanes and helicopters	1935
AMC3 NCO.OP.125(b) Fuel/energy and oil supply – aeroplanes and helicopters	1935
GM1 NCO.OP.125(b) Fuel/energy and oil supply – aeroplanes and helicopters	1935
GM2 NCO.OP.125(b) Fuel/energy and oil supply – aeroplanes and helicopters	1935
NCO.OP.130 Passenger briefing	1935
AMC1 NCO.OP.130 Passenger briefing	1936
NCO.OP.135 Flight preparation	1936
NCO.OP.140 Destination alternate aerodromes – aeroplanes.....	1936
NCO.OP.141 Destination alternate aerodromes – helicopters	1936
NCO.OP.142 Destination alternate aerodromes – instrument approach operations	1937
AMC1 NCO.OP.142(b)(1) Destination alternate aerodromes – instrument approach operations	1937
AMC2 NCO.OP.142(b)(3) Destination alternate aerodromes – instrument approach operations	1937
GM1 NCO.OP.142(b)(4) Destination alternate aerodromes – instrument approach operations	1937
AMC1 NCO.OP.142(b)(5) Destination alternate aerodromes – instrument approach operations	1938
NCO.OP.143 Destination alternate aerodromes planning minima – aeroplanes	1938
GM1 NCO.OP.143 Destination alternate aerodromes planning minima – aeroplanes.....	1939
NCO.OP.144 Destination alternate aerodromes planning minima – helicopters	1939
GM1 NCO.OP.144 Destination alternate aerodromes planning minima – helicopters.....	1939
NCO.OP.145 Refuelling with passengers embarking, on board or disembarking.....	1940

AMC1 NCO.OP.145 Refuelling with passengers embarking, on board or disembarking.....	1940
NCO.OP.147 Refuelling with engine(s) and/or rotors turning – helicopters	1940
AMC1 NCO.OP.147 Refuelling with the engine(s) running and/or rotors turning – helicopters.....	1941
GM1 NCO.OP.147 Refuelling with the engine(s) running and/or rotors turning – helicopters.....	1941
NCO.OP.150 Carriage of passengers	1941
NCO.OP.155 Smoking on board – aeroplanes and helicopters	1941
NCO.OP.160 Meteorological conditions	1941
AMC1 NCO.OP.160 Meteorological conditions	1942
GM1 NCO.OP.160 Meteorological conditions	1943
GM2 NCO.OP.160 Meteorological conditions	1943
NCO.OP.165 Ice and other contaminants – ground procedures.....	1943
NCO.OP.170 Ice and other contaminants – flight procedures.....	1943
GM1 NCO.OP.170(b) Ice and other contaminants – flight procedures	1943
NCO.OP.175 Take-off conditions – aeroplanes and helicopters	1944
AMC1 NCO.OP.175 Take-off conditions – aeroplanes and helicopters	1944
NCO.OP.180 Simulated situations in flight.....	1944
GM1.NCO.OP.180 Simulated situations in flight.....	1944
NCO.OP.185 In-flight fuel/energy management	1945
GM1 NCO.OP.185(b)&(c) In-flight fuel/energy management	1945
NCO.OP.190 Use of supplemental oxygen	1946
AMC1 NCO.OP.190(a) Use of supplemental oxygen.....	1946
GM1 NCO.OP.190 Use of supplemental oxygen.....	1947
GM2 NCO.OP.190 Use of supplemental oxygen.....	1947
NCO.OP.195 Ground proximity detection.....	1947
NCO.OP.200 Airborne collision avoidance system (ACAS II)	1948
NCO.OP.205 Approach and landing conditions – aeroplanes	1948
AMC1 NCO.OP.205 Approach and landing conditions – aeroplanes.....	1948
GM1 NCO.OP.205 Approach and landing conditions – aeroplanes.....	1948
NCO.OP.206 Approach and landing conditions – helicopters	1949
AMC1 NCO.OP.206 Approach and landing conditions – helicopters	1949
NCO.OP.210 Commencement and continuation of approach – aeroplanes and helicopters.....	1949
AMC1 NCO.OP.210 Commencement and continuation of approach – aeroplanes and helicopters.....	1950
AMC2 NCO.OP.210 Commencement and continuation of approach – aeroplanes and helicopters.....	1950
GM1 NCO.OP.210 Commencement and continuation of approach – aeroplanes and helicopters.....	1950
NCO.OP.220 Airborne collision avoidance system (ACAS II)	1951
SUBPART C: AIRCRAFT PERFORMANCE AND OPERATING LIMITATIONS	1952

NCO.POL.100 Operating limitations – all aircraft.....	1952
NCO.POL.105 Weighing.....	1952
GM1 NCO.POL.105 Weighing.....	1952
NCO.POL.110 Performance – general	1952
SUBPART D: INSTRUMENTS, DATA AND EQUIPMENT.....	1953
SECTION 1 – Aeroplanes.....	1953
NCO.IDE.A.100 Instruments and equipment – general	1953
GM1 NCO.IDE.A.100(a) Instruments and equipment – general.....	1953
GM1 NCO.IDE.A.100(b) Instruments and equipment – general.....	1954
GM1 NCO.IDE.A.100(c) Instruments and equipment – general.....	1954
NCO.IDE.A.105 Minimum equipment for flight	1954
AMC1 NCO.IDE.A.105 Minimum equipment for flight.....	1955
GM1 NCO.IDE.A.105 Minimum equipment for flight.....	1955
NCO.IDE.A.110 Spare electrical fuses	1955
GM1 NCO.IDE.A.110 Spare electrical fuses.....	1955
NCO.IDE.A.115 Operating lights.....	1955
NCO.IDE.A.120 Operations under VFR – flight and navigational instruments and associated equipment.....	1956
AMC1 NCO.IDE.A.120&NCO.IDE.A.125 Operations under VFR & operations under IFR – flight and navigational instruments and associated equipment	1956
AMC2 NCO.IDE.A.120 Operations under VFR – flight and navigational instruments and associated equipment.....	1957
GM1 NCO.IDE.A.120 Operations under VFR – flight and navigational instruments and associated equipment.....	1957
NCO.IDE.A.125 Operations under IFR – flight and navigational instruments and associated equipment.....	1957
GM1 NCO.IDE.A.125 Operations under IFR – flight and navigational instruments and associated equipment.....	1958
AMC1 NCO.IDE.A.120(a)(1)&NCO.IDE.A.125(a)(1) Operations under VFR & operations under IFR – flight and navigational instruments and associated equipment	1958
AMC1 NCO.IDE.A.120(a)(2)&NCO.IDE.A.125(a)(2) Operations under VFR & operations under IFR – flight and navigational instruments and associated equipment	1958
AMC1 NCO.IDE.A.120(a)(3)&NCO.IDE.A.125(a)(3) Operations under VFR operations & operations under IFR – flight and navigational instruments and associated equipment...	1958
GM1 NCO.IDE.A.125(a)(3) Operations under IFR – flight and navigational instruments and associated equipment.....	1958
AMC1 NCO.IDE.A.120(a)(4)&NCO.IDE.A.125(a)(4) Operations under VFR & operations under IFR – flight and navigational instruments and associated equipment	1959
AMC1 NCO.IDE.A.120(c)&NCO.IDE.A.125(c) Operations under IFR – flight and navigational instruments and associated equipment.....	1959
AMC1 NCO.IDE.A.125(a)(9) Operations under IFR – flight and navigational instruments and associated equipment.....	1959
NCO.IDE.A.130 Terrain awareness warning system (TAWS).....	1959
AMC1 NCO.IDE.A.130 Terrain awareness warning system (TAWS)	1960
GM1 NCO.IDE.A.130 Terrain awareness warning system (TAWS)	1960
NCO.IDE.A.135 Flight crew interphone system.....	1960
AMC1 NCO.IDE.A.135 Flight crew interphone system	1960
GM1 NCO.IDE.A.135 Flight crew interphone system	1960
NCO.IDE.A.140 Seats, seat safety belts, restraint systems and child restraint devices	1961
AMC1 NCO.IDE.A.140 Seats, seat safety belts, restraint systems and child restraint devices	1961
AMC2 NCO.IDE.A.140 Seats, seat safety belts, restraint systems and child restraint devices	1963
NCO.IDE.A.145 First-aid kit	1963

AMC1 NCO.IDE.A.145 First-aid kit.....	1963
AMC2 NCO.IDE.A.145 First-aid kit.....	1964
GM1 NCO.IDE.A.145 First-aid kit.....	1964
GM2 NCO.IDE.A.145 First-aid kit.....	1964
NCO.IDE.A.150 Supplemental oxygen – pressurised aeroplanes	1964
AMC1 NCO.IDE.A.150 Supplemental oxygen – pressurised aeroplanes	1965
NCO.IDE.A.155 Supplemental oxygen – non-pressurised aeroplanes.....	1965
AMC1 NCO.IDE.A.155 Supplemental oxygen – non-pressurised aeroplanes.....	1965
AMC2 NCO.IDE.A.155 Supplemental oxygen supply – non-pressurised aeroplanes.....	1966
NCO.IDE.A.160 Hand fire extinguishers	1966
NCO.IDE.A.165 Marking of break-in points.....	1966
AMC1 NCO.IDE.A.165 Marking of break-in points	1967
NCO.IDE.A.170 Emergency locator transmitter (ELT)	1967
AMC1 NCO.IDE.A.170 Emergency locator transmitter (ELT).....	1967
AMC2 NCO.IDE.A.170 Emergency locator transmitter (ELT).....	1968
AMC3 NCO.IDE.A.170 Emergency locator transmitter (ELT).....	1968
AMC4 NCO.IDE.A.170 Emergency locator transmitter (ELT).....	1969
GM1 NCO.IDE.A.170 Emergency locator transmitter (ELT).....	1969
NCO.IDE.A.175 Flight over water	1969
AMC1 NCO.IDE.A.175 Flight over water.....	1970
GM1 NCO.IDE.A.175 Flight over water	1970
NCO.IDE.A.180 Survival equipment	1970
AMC1 NCO.IDE.A.180 Survival equipment.....	1970
AMC2 NCO.IDE.A.180 Survival equipment.....	1971
GM1 NCO.IDE.A.180 Survival equipment.....	1971
GM2 NCO.IDE.A.180 Survival equipment.....	1971
NCO.IDE.A.190 Radio communication equipment.....	1972
GM1 NCO.IDE.A.190 Radio communication equipment	1972
NCO.IDE.A.195 Navigation equipment	1972
AMC1 NCO.IDE.A.195 Navigation equipment	1972
GM1 NCO.IDE.A.195 Navigation equipment.....	1973
GM2 NCO.IDE.A.195 Navigation equipment.....	1977
AMC1 NCO.IDE.A.195(a) Navigation equipment.....	1977
GM1 NCO.IDE.A.195(a) Navigation equipment.....	1978
GM2 NCO.IDE.A.195(a) Navigation equipment.....	1978
GM3 NCO.IDE.A.195(a) Navigation equipment.....	1979
AMC1 NCO.IDE.A.195(b) Navigation equipment.....	1979
NCO.IDE.A.200 Transponder	1979
AMC1 NCO.IDE.A.200 Transponder	1979
NCO.IDE.A.205 Management of aeronautical databases	1980
AMC1 NCO.IDE.A.205 Management of aeronautical databases	1980
GM1 NCO.IDE.A.205 Management of aeronautical databases.....	1980
GM2 NCO.IDE.A.205 Management of aeronautical databases.....	1980
GM3 NCO.IDE.A.205 Management of aeronautical databases.....	1980
SECTION 2 – Helicopters.....	1981
NCO.IDE.H.100 Instruments and equipment – general	1981
GM1 NCO.IDE.H.100(a) Instruments and equipment – general.....	1982
GM1 NCO.IDE.H.100(b) Instruments and equipment – general	1982
GM1 NCO.IDE.H.100(c) Instruments and equipment – general.....	1982
NCO.IDE.H.105 Minimum equipment for flight	1982
AMC1 NCO.IDE.H.105 Minimum equipment for flight.....	1983
GM1 NCO.IDE.H.105 Minimum equipment for flight.....	1983
NCO.IDE.H.115 Operating lights.....	1983
AMC1 NCO.IDE.H.115 Operating lights	1983
NCO.IDE.H.120 Operations under VFR – flight and navigational instruments and associated equipment.....	1983

AMC1 NCO.IDE.H.120&NCO.IDE.H.125 Operations under VFR & operations under IFR – flight and navigational instruments and associated equipment	1984
AMC1 NCO.IDE.H.120(a)(1)&NCO.IDE.H.125(a)(1) Operations under VFR & operations under IFR – flight and navigational instruments and associated equipment	1985
AMC1 NCO.IDE.H.120(a)(2)&NCO.IDE.H.125(a)(2) Operations under VFR & operations under IFR – flight and navigational instruments and associated equipment	1985
AMC1 NCO.IDE.H.120(a)(3)&NCO.IDE.H.125(a)(3) Operations under VFR & operations under IFR – flight and navigational instruments and associated equipment	1985
AMC1 NCO.IDE.H.120(a)(5) Operations under VFR – flight and navigational instruments and associated equipment	1985
NCO.IDE.H.125 Operations under IFR – flight and navigational instruments and associated equipment	1985
GM1 NCO.IDE.H.125(a)(3) Operations under IFR – flight and navigational instruments and associated equipment	1986
AMC1 NCO.IDE.H.120(a)(4)&NCO.IDE.H.125(a)(4) Operations under VFR & operations under IFR – flight and navigational instruments and associated equipment	1986
AMC1 NCO.IDE.H.120(b)(1)(iii)&NCO.IDE.H.125(a)(8) Operations under VFR & operations under IFR – flight and navigational instruments and associated equipment	1986
AMC1 NCO.IDE.H.120(c)&NCO.IDE.H.125(c) Operations under VFR & Operations under IFR – flight and navigational instruments and associated equipment	1987
AMC1 NCO.IDE.H.125(a)(9) Operations under IFR – flight and navigational instruments and associated equipment	1987
NCO.IDE.H.126 Additional equipment for single pilot operations under IFR	1987
NCO.IDE.H.135 Flight crew interphone system	1987
AMC1 NCO.IDE.H.135 Flight crew interphone system	1987
GM1 NCO.IDE.H.135 Flight crew interphone system	1988
NCO.IDE.H.140 Seats, seat safety belts, restraint systems and child restraint devices.....	1988
AMC1 NCO.IDE.H.140 Seats, seat safety belts, restraint systems and child restraint devices	1988
AMC2 NCO.IDE.H.140 Seats, seat safety belts, restraint systems and child restraint devices	1990
NCO.IDE.H.145 First-aid kit	1990
AMC1 NCO.IDE.H.145 First-aid kit.....	1991
AMC2 NCO.IDE.H.145 First-aid kit.....	1991
GM1 NCO.IDE.H.145 First-aid kit.....	1991
GM2 NCO.IDE.H.145 First-aid kit.....	1992
NCO.IDE.H.155 Supplemental oxygen – non-pressurised helicopters.....	1992
AMC1 NCO.IDE.H.155 Supplemental oxygen – non-pressurised helicopters.....	1992
AMC2 NCO.IDE.H.155 Supplemental oxygen supply – non-pressurised helicopters	1992
NCO.IDE.H.160 Hand fire extinguishers	1992
NCO.IDE.H.165 Marking of break-in points	1993
AMC1 NCO.IDE.H.165 Marking of break-in points	1993
NCO.IDE.H.170 Emergency locator transmitter (ELT)	1993
AMC1 NCO.IDE.H.170 Emergency locator transmitter (ELT).....	1994
AMC2 NCO.IDE.H.170 Emergency locator transmitter (ELT).....	1994
AMC3 NCO.IDE.H.170 Emergency locator transmitter (ELT).....	1995
AMC4 NCO.IDE.H.170 Emergency locator transmitter (ELT).....	1995
GM1 NCO.IDE.H.170 Emergency locator transmitter (ELT).....	1995
NCO.IDE.H.175 Flight over water	1995
AMC1 NCO.IDE.H.175 Flight over water	1996
GM1 NCO.IDE.H.175 Flight over water	1997
NCO.IDE.H.180 Survival equipment	1997
AMC1 NCO.IDE.H.180 Survival equipment.....	1997
AMC2 NCO.IDE.H.180 Survival equipment.....	1997
GM1 NCO.IDE.H.180 Survival equipment	1997
GM2 NCO.IDE.H.180 Survival equipment	1998
NCO.IDE.H.185 All helicopters on flights over water – ditching	1998

AMC1 NCO.IDE.H.185 All helicopters on flights over water – ditching	1998
NCO.IDE.H.190 Radio communication equipment	1998
NCO.IDE.H.195 Navigation equipment	1999
AMC1 NCO.IDE.H.195 Navigation equipment	1999
GM1 NCO.IDE.H.195 Navigation equipment	1999
GM2 NCO.IDE.H.195 Navigation equipment	1999
GM3 NCO.IDE.H.195 Navigation equipment	2003
AMC1 NCO.IDE.H.195(a) Navigation equipment	2004
GM1 NCO.IDE.H.195(a) Navigation equipment	2004
GM2 NCO.IDE.H.195(a) Navigation equipment	2004
GM3 NCO.IDE.H.195(a) Navigation equipment	2004
AMC1 NCO.IDE.H.195(b) Navigation equipment	2005
NCO.IDE.H.200 Transponder	2005
AMC1 NCO.IDE.H.200 Transponder	2005
NCO.IDE.H.205 Management of aeronautical databases	2005
AMC1 NCO.IDE.H.205 Management of aeronautical databases	2006
GM1 NCO.IDE.H.205 Management of aeronautical databases	2006
GM2 NCO.IDE.H.205 Management of aeronautical databases	2006
GM3 NCO.IDE.H.205 Management of aeronautical databases	2006
SUBPART E: SPECIFIC REQUIREMENTS	2007
SECTION 1 – General	2007
NCO.SPEC.100 Scope	2007
AMC1 NCO.SPEC.100 Scope	2007
GM1 NCO.SPEC.100 Scope	2007
NCO.SPEC.105 Checklist	2008
GM1 NCO.SPEC.105 Checklist	2008
GM2 NCO.SPEC.105 Checklists	2010
NCO.SPEC.110 Pilot-in-command responsibilities and authority	2012
AMC1 NCO.SPEC.110(f) Pilot-in-command responsibilities and authority	2013
GM1 NCO.SPEC.110(f) Pilot-in-command responsibilities and authority	2013
GM2 NCO.SPEC.110(f) Pilot-in-command responsibilities and authority	2014
NCO.SPEC.115 Crew responsibilities	2014
AMC1 NCO.SPEC.115(a) Crew responsibilities	2015
NCO.SPEC.120 Task specialists responsibilities	2015
NCO.SPEC.125 Safety briefing	2015
AMC1 NCO.SPEC.125 Safety briefing	2015
NCO.SPEC.130 Minimum obstacle clearance altitudes – IFR flights	2016
NCO.SPEC.145 Simulated situations in flight	2016
NCO.SPEC.150 Ground proximity detection	2016
NCO.SPEC.155 Airborne collision avoidance system (ACAS II)	2016
NCO.SPEC.160 Release of dangerous goods	2017
NCO.SPEC.165 Carriage and use of weapons	2017
NCO.SPEC.170 Performance and operating criteria – aeroplanes	2017
NCO.SPEC.175 Performance and operating criteria – helicopters	2017
GM1 NCO.SPEC.175(c) Performance and operating criteria – helicopters	2018
SECTION 2 – Helicopter external sling load operations (HESLO)	2018
NCO.SPEC.HESLO.100 Checklist	2018
GM1 NCO.SPEC.HESLO.100 Checklist	2018
NCO.SPEC.HESLO.105 Specific HESLO equipment	2018
NCO.SPEC.HESLO.110 Transportation of dangerous goods	2019
SECTION 3 – Human external cargo operations (HEC)	2019
NCO.SPEC.HEC.100 Checklist	2019
GM1 NCO.SPEC.HEC.100 Checklist	2019

NCO.SPEC.HEC.105 Specific HEC equipment	2019
SECTION 4 – Parachute operations (PAR)	2020
NCO.SPEC.PAR.100 Checklist	2020
NCO.SPEC.PAR.105 Carriage of crew members and task specialists	2020
NCO.SPEC.PAR.110 Seats	2020
NCO.SPEC.PAR.115 Supplemental oxygen	2020
NCO.SPEC.PAR.120 Release of dangerous goods	2020
SECTION 5 – Aerobatic flights (ABF)	2021
NCO.SPEC.ABF.100 Checklist.....	2021
NCO.SPEC.ABF.105 Documents and information	2021
NCO.SPEC.ABF.110 Equipment	2021
SECTION 6 – Maintenance Check Flights (MCF)	2021
NCO.SPEC.MCF.100 Levels of maintenance check flights.....	2021
NCO.SPEC.MCF.105 Operational limitations.....	2022
NCO.SPEC.MCF.110 Checklist and safety briefing	2022
GM1 NCO.SPEC.MCF.110 Checklist and safety briefing	2022
NCO.SPEC.MCF.120 Flight crew requirements	2022
AMC1 NCO.SPEC.MCF.120 Flight crew requirements	2023
NCO.SPEC.MCF.125 Crew composition and persons on board	2023
GM1 NCO.SPEC.MCF.125 Crew composition and persons on board	2023
NCO.SPEC.MCF.130 Simulated abnormal or emergency procedures in flight ..	2023
NCO.SPEC.MCF.140 Systems and equipment	2023

ANNEX VIII (Part-SPO) 2024

SPO.GEN.005 Scope	2024
AMC1 SPO.GEN.005 Scope	2024
GM1 SPO.GEN.005 Scope	2025
SUBPART A: GENERAL REQUIREMENTS	2026
SPO.GEN.100 Competent authority	2026
GM1 SPO.GEN.100 Competent authority	2026
SPO.GEN.101 Means of compliance.....	2026
SPO.GEN.105 Crew responsibilities.....	2026
AMC1 SPO.GEN.105(a) Crew responsibilities	2027
GM1 SPO.GEN.105(e)(2) Crew member responsibilities	2028
SPO.GEN.106 Task specialists responsibilities.....	2028
SPO.GEN.107 Pilot-in-command responsibilities and authority	2028
AMC1 SPO.GEN.107 Pilot-in-command responsibilities and authority	2030
AMC2 SPO.GEN.107 Pilot-in-command responsibilities and authority	2030
GM1 SPO.GEN.107 Pilot-in-command responsibilities and authority	2031
GM1 SPO.GEN.107(a)(8) Pilot-in-command responsibilities and authority	2031
GM1 SPO.GEN.107(a)(9) Pilot-in-command responsibilities and authority	2032
AMC1 SPO.GEN.107(c) Pilot-in-command responsibilities and authority	2032
AMC1 SPO.GEN.107(e) Pilot-in-command responsibilities and authority	2032
SPO.GEN.110 Compliance with laws, regulations and procedures.....	2032

SPO.GEN.115 Common language	2033
SPO.GEN.119 Taxiing of aircraft	2033
AMC1 SPO.GEN.119 Taxiing of aircraft	2033
SPO.GEN.120 Taxiing of aeroplanes	2033
GM1 SPO.GEN.120 Taxiing of aeroplanes	2034
GM1 SPO.GEN.120(b)(4) Taxiing of aeroplanes	2034
SPO.GEN.125 Rotor engagement	2035
GM1 SPO.GEN.125 Rotor engagement	2035
SPO.GEN.130 Portable electronic devices	2035
GM1 SPO.GEN.130 Portable electronic devices	2035
GM2 SPO.GEN.130 Portable electronic devices	2036
SPO.GEN.131 Use of electronic flight bags (EFBs)	2037
AMC1 SPO.GEN.131(a) Use of electronic flight bags (EFBs)	2037
AMC2 SPO.GEN.131(a) Use of electronic flight bags (EFBs)	2039
AMC1 SPO.GEN.131(b) Use of electronic flight bags (EFBs)	2039
AMC2 SPO.GEN.131(b) Use of electronic flight bags (EFBs)	2039
AMC1 SPO.GEN.131(b)(1) Use of electronic flight bags (EFBs)	2039
GM1 SPO.GEN.131(b)(1) Use of electronic flight bags (EFBs)	2042
AMC1 SPO.GEN.131(b)(2) Use of electronic flight bags (EFBs)	2042
AMC2 SPO.GEN.131(b)(2) Use of electronic flight bags (EFBs)	2042
AMC3 SPO.GEN.131(b)(2) Use of electronic flight bags (EFBs)	2045
AMC4 SPO.GEN.131(b)(2) Use of electronic flight bags (EFBs)	2046
AMC5 SPO.GEN.131(b)(2) Use of electronic flight bags (EFBs)	2049
AMC6 SPO.GEN.131(b)(2) Use of electronic flight bags (EFBs)	2051
AMC7 SPO.GEN.131(b)(2) Use of electronic flight bags (EFBs)	2052
AMC8 SPO.GEN.131(b)(2) Use of electronic flight bags (EFBs)	2052
AMC9 SPO.GEN.131(b)(2) Use of electronic flight bags (EFBs)	2054
GM1 SPO.GEN.131(b)(2) Use of electronic flight bags (EFBs)	2056
GM2 SPO.GEN.131(b)(2) Use of electronic flight bags (EFBs)	2056
GM3 SPO.GEN.131(b)(2) Use of electronic flight bags (EFBs)	2056
SPO.GEN.135 Information on emergency and survival equipment carried	2057
AMC1 SPO.GEN.135 Information on emergency and survival equipment carried	2057
SPO.GEN.140 Documents, manuals and information to be carried	2057
AMC1 SPO.GEN.140 Documents, manuals and information to be carried	2058
GM1 SPO.GEN.140(a)(1) Documents, manuals and information to be carried	2058
AMC1 SPO.GEN.140(a)(3) Documents, manuals and information to be carried	2059
GM1 SPO.GEN.140(a)(9) Documents, manuals and information to be carried	2059
AMC1 SPO.GEN.140(a)(12) Documents, manuals and information to be carried	2059
AMC1 SPO.GEN.140(a)(13) Documents, manuals and information to be carried	2060
GM1 SPO.GEN.140(a)(14) Documents, manuals and information to be carried	2060
AMC1 SPO.GEN.140(a)(18) Documents, manuals and information to be carried	2060

GM1 SPO.GEN.140(a)(18) Documents, manuals, and information to be carried	2060
GM2 SPO.GEN.140(a)(18) Documents, manuals, and information to be carried	2061
GM3 SPO.GEN.140(a)(18) Documents, manuals, and information to be carried	2061
GM1 SPO.GEN.140(a)(20) Documents, manuals and information to be carried	2061
SPO.GEN.145 Handling of flight recorder recordings: preservation, production, protection and use	2061
AMC1 SPO.GEN.145(a) Handling of flight recorder recordings: preservation, production, protection and use	2063
GM1 SPO.GEN.145(a) Handling of flight recorder recordings: preservation, production, protection and use	2063
AMC1 SPO.GEN.145(b) Handling of flight recorder recordings: preservation, production, protection and use	2063
GM1 SPO.GEN.145(b) Handling of flight recorder recordings: preservation, production, protection and use	2064
GM2 SPO.GEN.145(b) Handling of flight recorder recordings: preservation, production, protection and use	2065
GM3 SPO.GEN.145(b) Handling of flight recorder recordings: preservation, production, protection and use	2066
AMC1 SPO.GEN.145(f)(1) Handling of flight recorder recordings: preservation, production, protection and use	2066
AMC1 SPO.GEN.145(f)(1a) Handling of flight recorder recordings: preservation, production, protection and use	2067
AMC1 SPO.GEN.145(f)(3) Handling of flight recorder recordings: preservation, production, protection and use	2068
AMC1 SPO.GEN.145(f)(3a) Handling of flight recorder recordings: preservation, production, protection and use	2069
GM1 SPO.GEN.145(f) Handling of flight recorder recordings: preservation, production, protection and use	2069
SPO.GEN.150 Transport of dangerous goods.....	2070
GM1 SPO.GEN.150(a) Transport of dangerous goods	2070
AMC1 SPO.GEN.150(e) Transport of dangerous goods	2071
SPO.GEN.155 Release of dangerous goods	2073
SPO.GEN.160 Carriage and use of weapons.....	2073
SPO.GEN.165 Admission to the flight crew compartment.....	2073
SUBPART B: OPERATIONAL PROCEDURES.....	2074
SPO.OP.100 Use of aerodromes and operating sites	2074
AMC1 SPO.OP.100 Use of aerodromes and operating sites.....	2074
SPO.OP.101 Altimeter check and settings.....	2075
GM1 SPO.OP.101 Altimeter check and settings.....	2075
SPO.OP.105 Specification of isolated aerodromes – aeroplanes.....	2075
GM1 SPO.OP.105 Specification of isolated aerodromes – aeroplanes	2075
SPO.OP.110 Aerodrome operating minima – aeroplanes and helicopters.....	2075

AMC1 SPO.OP.110 Aerodrome operating minima – aeroplanes and helicopters	2076
AMC2 SPO.OP.110 Aerodrome operating minima – aeroplanes and helicopters	2076
AMC3 SPO.OP.110 Aerodrome operating minima – aeroplanes and helicopters	2077
AMC4 SPO.OP.110 Aerodrome operating minima – aeroplanes and helicopters	2079
AMC5 SPO.OP.110 Aerodrome operating minima – aeroplanes and helicopters	2081
AMC6 SPO.OP.110 Aerodrome operating minima – aeroplanes and helicopters	2084
AMC7 SPO.OP.110 Aerodrome operating minima – aeroplanes and helicopters	2085
AMC8 SPO.OP.110 Aerodrome operating minima – aeroplanes and helicopters	2085
AMC9 SPO.OP.110 Aerodrome operating minima – aeroplanes and helicopters	2086
AMC10 SPO.OP.110 Aerodrome operating minima – aeroplanes and helicopters	2087
GM1 SPO.OP.110 Aerodrome operating minima – aeroplanes and helicopters	2087
GM2 SPO.OP.110 Aerodrome operating minima – aeroplanes and helicopters	2088
GM3 SPO.OP.110 Aerodrome operating minima – aeroplanes and helicopters	2089
GM4 SPO.OP.110 Aerodrome operating minima – aeroplanes and helicopters	2090
GM5 SPO.OP.110 Aerodrome operating minima – aeroplanes and helicopters	2090
GM6 SPO.OP.110 Aerodrome operating minima – aeroplanes and helicopters	2090
GM7 SPO.OP.110 Aerodrome operating minima – aeroplanes and helicopters	2091
GM8 SPO.OP.110 Aerodrome operating minima – aeroplanes and helicopters	2091
GM9 SPO.OP.110 Aerodrome operating minima – aeroplanes and helicopters	2092
GM10 SPO.OP.110 Aerodrome operating minima – aeroplanes and helicopters	2092
GM1 SPO.OP.110(b)(5) Aerodrome operating minima	2092
SPO.OP.112 Aerodrome operating minima – circling operations with aeroplanes ...	2092
GM1 SPO.OP.112 Aerodrome operating minima – circling operations with aeroplanes.....	2093
SPO.OP.113 Aerodrome operating minima – onshore circling operations with helicopters.....	2096
SPO.OP.115 Departure and approach procedures – aeroplanes and helicopters	2096
AMC1 SPO.OP.115 Departure and approach procedures – aeroplanes and helicopters.....	2096

SPO.OP.116 Performance-based navigation – aeroplanes and helicopters	2096
AMC1 SPO.OP.116 Performance-based navigation – aeroplanes and helicopters	2097
AMC2 SPO.OP.116 Performance-based navigation – aeroplanes and helicopters	2097
AMC3 SPO.OP.116 Performance-based navigation – aeroplanes and helicopters	2099
AMC4 SPO.OP.116 Performance-based navigation – aeroplanes and helicopters	2099
AMC5 SPO.OP.116 Performance-based navigation – aeroplanes and helicopters	2100
AMC6 SPO.OP.116 Performance-based navigation – aeroplanes and helicopters	2101
AMC7 SPO.OP.116 Performance-based navigation – aeroplanes and helicopters	2101
AMC8 SPO.OP.116 Performance-based navigation – aeroplanes and helicopters	2101
GM1 SPO.OP.116 Performance-based navigation – aeroplanes and helicopters	2102
SPO.OP.120 Noise abatement procedures.....	2102
AMC1 SPO.OP.120 Noise abatement procedures.....	2102
GM1 SPO.OP.120 Noise abatement procedures	2103
SPO.OP.125 Minimum obstacle clearance altitudes – IFR flights	2103
AMC1 SPO.OP.125 Minimum obstacle clearance altitudes – IFR flights	2103
SPO.OP.130 Fuel/energy scheme – aeroplanes and helicopters	2104
SPO.OP.131 Fuel/energy scheme – fuel/energy planning and in flight re-planning policy – aeroplanes and helicopters	2104
AMC1 SPO.OP.131 Fuel/energy scheme — fuel/energy planning and in-flight re-planning policy — aeroplanes and helicopters.....	2106
AMC1 SPO.OP.131(a)(1)(ii) Fuel and oil supply – helicopters.....	2108
SPO.OP.135 Safety briefing	2108
AMC1 SPO.OP.135 Safety briefing	2108
SPO.OP.140 Flight preparation.....	2109
SPO.OP.143 Destination alternate aerodromes planning minima — aeroplanes	2109
SPO.OP.144 Destination alternate aerodrome planning minima — helicopters.....	2110
SPO.OP.145 Take-off alternate aerodromes — complex motor-powered aeroplanes.....	2110
SPO.OP.150 Destination alternate aerodromes – aeroplanes	2110
SPO.OP.151 Destination alternate aerodromes – helicopters.....	2111
SPO.OP.152 Destination aerodromes – instrument approach operations	2111
AMC1 SPO.OP.152 Destination aerodromes — instrument approach operations	2112
GM1 SPO.OP.152 Destination aerodromes – instrument approach operations	2113
GM2 SPO.OP.152 Destination aerodromes — instrument approach operations	2113

SPO.OP.155 Refuelling with persons embarking, on board or disembarking	2114
AMC1 SPO.OP.155 Refuelling with persons embarking, on board or disembarking	2114
AMC2 SPO.OP.155 Refuelling with persons embarking, on board or disembarking	2114
GM1 SPO.OP.155 Refuelling with persons embarking, on board or disembarking	2115
SPO.OP.157 Refuelling with engine(s) and/or rotors turning – helicopters	2115
AMC1 SPO.OP.157 Refuelling with engine(s) and/or rotors turning – helicopters	2115
AMC2 SPO.OP.157 Refuelling with the engine(s) running and/or rotors turning – helicopters.....	2116
GM1 SPO.OP.157 Refuelling with the engine(s) and/or rotors turning – helicopters	2117
SPO.OP.160 Use of headset.....	2117
SPO.OP.165 Smoking.....	2117
SPO.OP.170 Meteorological conditions	2117
AMC1 SPO.OP.170 Meteorological conditions	2118
AMC2 SPO.OP.170 Meteorological conditions	2118
GM1 SPO.OP.170 Meteorological conditions	2119
SPO.OP.175 Ice and other contaminants – ground procedures	2119
GM1 SPO.OP.175 Ice and other contaminants – ground procedures	2119
GM2 SPO.OP.175 Ice and other contaminants – ground procedures	2121
GM3 SPO.OP.175 Ice and other contaminants – ground procedures	2125
SPO.OP.176 Ice and other contaminants – flight procedures.....	2127
AMC1 SPO.OP.176 Ice and other contaminants – flight procedures.....	2127
SPO.OP.180 Take-off conditions — aeroplanes and helicopters	2128
SPO.OP.185 Simulated situations in flight.....	2128
SPO.OP.190 Fuel/energy scheme – in-flight fuel/energy management policy.....	2128
GM1 SPO.OP.190(b)&(d) Fuel/energy scheme — in-flight fuel/energy management policy	2129
GM1 SPO.OP.190(c) Fuel/energy scheme — in-flight fuel/energy management policy	2129
SPO.OP.195 Use of supplemental oxygen.....	2129
SPO.OP.200 Ground proximity detection.....	2130
GM1 SPO.OP.200 Ground proximity detection	2130
SPO.OP.205 Airborne collision avoidance system (ACAS).....	2137
GM1 SPO.OP.205 Airborne collision avoidance system (ACAS).....	2138
SPO.OP.210 Approach and landing conditions — aeroplanes and helicopters	2147
AMC1 SPO.OP.210 Approach and landing conditions — aeroplanes	2147
GM1 SPO.OP.210 Approach and landing conditions — aeroplanes.....	2148
GM2 SPO.OP.210 Approach and landing conditions — aeroplanes.....	2150
GM3 SPO.OP.210 Approach and landing conditions — aeroplanes.....	2151
GM4 SPO.OP.210 Approach and landing conditions — aeroplanes.....	2151

GM5 SPO.OP.210 Approach and landing conditions — aeroplanes.....	2152
SPO.OP.211 Approach and landing conditions – helicopters.....	2153
AMC1 SPO.OP.211 Approach and landing conditions — helicopters.....	2153
SPO.OP.215 Commencement and continuation of approach.....	2153
GM1 SPO.OP.215 Commencement and continuation of approach.....	2154
AMC1 SPO.OP.215(a) Commencement and continuation of approach	2154
AMC1 SPO.OP.215(b) Commencement and continuation of approach	2155
AMC1 SPO.OP.215(c) Commencement and continuation of approach.....	2155
GM1 SPO.OP.215(f) Commencement and continuation of approach	2155
SPO.OP.230 Standard operating procedures	2156
AMC1 SPO.OP.230 Standard operating procedures	2156
AMC2 SPO.OP.230 Standard operating procedures	2156
GM1 SPO.OP.230 Standard operating procedures	2160
SPO.OP.235 EFVS 200 operations	2162
GM1 SPO.OP.235 EFVS 200 operations	2163
AMC1 SPO.OP.235(a)(1) EFVS 200 operations.....	2165
AMC1 SPO.OP.235(a)(2) EFVS 200 operations.....	2165
AMC2 SPO.OP.235(a)(2) EFVS 200 operations.....	2166
AMC1 SPO.OP.235(a)(3) EFVS 200 operations.....	2166
AMC2 SPO.OP.235(a)(3) EFVS 200 operations.....	2168
AMC3 SPO.OP.235(a)(3) EFVS 200 operations.....	2169
AMC4 SPO.OP.235(a)(3) EFVS 200 operations.....	2169
AMC5 SPO.OP.235(a)(3) EFVS 200 operations.....	2169
GM1 SPO.OP.235(a)(3) EFVS 200 operations.....	2169
AMC1 SPO.OP.235(a)(4) EFVS 200 operations.....	2170
AMC1 SPO.OP.235(a)(8) EFVS 200 operations.....	2171
AMC1 SPO.OP.235(c) EFVS 200 operations	2171
GM1 SPO.OP.235(c) EFVS 200 operations	2172
SUBPART C: AIRCRAFT PERFORMANCE AND OPERATING LIMITATIONS	2173
SPO.POL.100 Operating limitations – all aircraft.....	2173
AMC1 SPO.POL.100 Operating Limitations – all aircraft.....	2173
SPO.POL.105 Mass and balance	2173
GM1 SPO.POL.105 Mass and balance	2173
AMC1 SPO.POL.105(b) Mass and balance.....	2174
SPO.POL.110 Mass and balance system – commercial operations with aeroplanes and helicopters and non-commercial operations with complex motor-powered aircraft .	2175
AMC1 SPO.POL.110(a)(1) Mass and balance system – commercial operations with aeroplanes and helicopters and non-commercial operations with complex motor-powered aircraft	2175
AMC1 SPO.POL.110(a)(2) Mass and balance system – commercial operations with aeroplanes and helicopters and non-commercial operations with complex motor-powered aircraft	2176
GM1 SPO.POL.110(a)(2) Mass and balance system – commercial operations with aeroplanes and helicopters and non-commercial operations with complex motor-powered aircraft	2176

AMC1 SPO.POL.110(a)(3) Mass and balance system – commercial operations with aeroplanes and helicopters and non-commercial operations with complex motor-powered aircraft	2176
GM1 SPO.POL.110(a)(3) Mass and balance system – commercial operations with aeroplanes and helicopters and non-commercial operations with complex motor-powered aircraft	2176
AMC1 SPO.POL.110(a)(4) Mass and balance system – commercial operations with aeroplanes and helicopters and non-commercial operations with complex motor-powered aircraft	2177
GM1 SPO.POL.110(b) Mass and balance system – commercial operations with aeroplanes and helicopters and non-commercial operations with complex motor-powered aircraft	2177
SPO.POL.115 Mass and balance data and documentation – commercial operations with aeroplanes and helicopters and non-commercial operations with complex motor-powered aircraft.....	2177
AMC1 SPO.POL.115 Mass and balance data and documentation – commercial operations with aeroplanes and helicopters and non-commercial operations with complex motor-powered aircraft.....	2178
GM1 SPO.POL.115 Mass and balance data and documentation – commercial operations with aeroplanes and helicopters and non-commercial operations with complex motor-powered aircraft.....	2178
AMC1 SPO.POL.115(b) Mass and balance data and documentation – commercial operations with aeroplanes and helicopters and non-commercial operations with complex motor-powered aircraft.....	2179
AMC2 SPO.POL.115(b) Mass and balance data and documentation – commercial operations with aeroplanes and helicopters and non-commercial operations with complex motor-powered aircraft.....	2179
GM1 SPO.POL.115(b) Mass and balance data and documentation – commercial operations with aeroplanes and helicopters and non-commercial operations with complex motor-powered aircraft.....	2179
GM2 SPO.POL.115(b) Mass and balance data and documentation – commercial operations with aeroplanes and helicopters and non-commercial operations with complex motor-powered aircraft.....	2180
SPO.POL.116 Mass and balance data and documentation – alleviations	2180
SPO.POL.120 Performance – general	2180
SPO.POL.125 Take-off mass limitations – complex motor-powered aeroplanes	2180
SPO.POL.130 Take-off – complex motor-powered aeroplanes.....	2181
AMC1 SPO.POL.130(a) Take-off – complex motor-powered aeroplanes	2181
AMC1 SPO.POL.130(a)(4) Take-off – complex motor-powered aeroplanes.....	2181
GM1 SPO.POL.130(a)(4) Take-off – complex motor-powered aeroplanes.....	2182
AMC1 SPO.POL.130(b)(2) Take-off – complex motor-powered aeroplanes.....	2182
GM1 SPO.POL.130(b)(2) Take-off – complex motor-powered aeroplanes	2182
SPO.POL.135 En-route – one engine inoperative – complex motor-powered aeroplanes	2182
SPO.POL.140 Landing – complex motor-powered aeroplanes	2182
AMC1 SPO.POL.140 Landing – complex motor-powered aeroplanes	2183
AMC2 SPO.POL.140 Landing – complex motor-powered aeroplanes	2183

GM1 SPO.POL.140 Landing — complex motor-powered aeroplanes.....	2183
SPO.POL.145 Performance and operating criteria – aeroplanes	2183
AMC1 SPO.POL.145(a) and (b) Performance and operating criteria – aeroplanes, and AMC1 SPO.POL.146(b)(1) and (2) Performance and operating criteria – helicopters.....	2184
SPO.POL.146 Performance and operating criteria – helicopters	2184
AMC1 SPO.POL.146(c) Performance and operating criteria – helicopters	2184
GM1 SPO.POL.146(c) Performance and operating criteria – helicopters	2185
SUBPART D: INSTRUMENTS, DATA AND EQUIPMENT	2186
SECTION 1 – Aeroplanes	2186
SPO.IDE.A.100 Instruments and equipment – general	2186
GM1 SPO.IDE.A.100(a) Instruments and equipment – general	2187
GM1 SPO.IDE.A.100(b) Instruments and equipment – general	2187
GM1 SPO.IDE.A.100(c) Instruments and equipment – general.....	2187
GM1 SPO.IDE.A.100(d) Instruments and equipment – general	2187
SPO.IDE.A.105 Minimum equipment for flight	2188
AMC1 SPO.IDE.A.105 Minimum equipment for flight.....	2188
GM1 SPO.IDE.A.105 Minimum equipment for flight.....	2188
SPO.IDE.A.110 Spare electrical fuses	2188
GM1 SPO.IDE.A.110 Spare electrical fuses.....	2188
SPO.IDE.A.115 Operating lights.....	2189
SPO.IDE.A.120 Operations under VFR – flight and navigational instruments and associated equipment.....	2189
AMC1 SPO.IDE.A.120 & SPO.IDE.A.125 Operations under VFR & operations under IFR – flight and navigational instruments and associated equipment	2190
AMC2 SPO.IDE.A.120 Operations under VFR – flight and navigational instruments and associated equipment	2190
GM1 SPO.IDE.A.120 Operations under VFR – flight and navigational instruments and associated equipment.....	2191
AMC1 SPO.IDE.A.120(a)(1) & SPO.IDE.A.125(a)(1) Operations under VFR & operations under IFR – flight and navigational instruments and associated equipment	2191
AMC1 SPO.IDE.A.120(a)(2) & SPO.IDE.A.125(a)(2) Operations under VFR & operations under IFR – flight and navigational instruments and associated equipment	2191
AMC1 SPO.IDE.A.120(a)(3) & SPO.IDE.A.125(a)(3) Operations under VFR operations & operations under IFR – flight and navigational instruments and associated equipment...	2191
AMC1 SPO.IDE.A.120(a)(4) & SPO.IDE.A.125(a)(4) Operations under VFR & operations under IFR – flight and navigational instruments and associated equipment	2192
AMC1 SPO.IDE.A.120(c) & SPO.IDE.A.125(d) Operations under VFR & operations under IFR – flight and navigational instruments and associated equipment	2192
AMC1 SPO.IDE.A.120(e) & SPO.IDE.A.125(c) Operations under VFR & operations under IFR – flight and navigational instruments and associated equipment	2192
SPO.IDE.A.125 Operations under IFR – flight and navigational instruments and associated equipment.....	2192
GM1 SPO.IDE.A.125 Operations under IFR – flight and navigational instruments and associated equipment.....	2193
GM1 SPO.IDE.A.125(a)(3) Operations under IFR – flight and navigational instruments and associated equipment	2194
AMC1 SPO.IDE.A.125(a)(9) Operations under IFR – flight and navigational instruments and associated equipment	2194
AMC1 SPO.IDE.A.125(e)(2) Operations under IFR – flight and navigational instruments and associated equipment	2194
SPO.IDE.A.126 Additional equipment for single-pilot operation under IFR	2194
SPO.IDE.A.130 Terrain awareness warning system (TAWS)	2194
AMC1 SPO.IDE.A.130 Terrain awareness warning system (TAWS)	2195
GM1 SPO.IDE.A.130 Terrain awareness warning system (TAWS)	2195

SPO.IDE.A.131 Airborne collision avoidance system (ACAS II)	2195
SPO.IDE.A.132 Airborne weather detecting equipment – complex motor-powered aeroplanes.....	2195
AMC1 SPO.IDE.A.132 Airborne weather detecting equipment – complex motor-powered aeroplanes	2195
SPO.IDE.A.133 Additional equipment for operations in icing conditions at night – complex motor-powered aeroplanes	2196
SPO.IDE.A.135 Flight crew interphone system	2196
AMC1 SPO.IDE.A.135 Flight crew interphone system	2196
SPO.IDE.A.140 Cockpit voice recorder	2196
AMC1 SPO.IDE.A.140 Cockpit voice recorder.....	2197
SPO.IDE.A.145 Flight data recorder	2197
AMC1 SPO.IDE.A.145 Flight data recorder.....	2198
AMC2 SPO.IDE.A.145 Flight data recorder.....	2202
SPO.IDE.A.146 Lightweight flight recorder	2207
AMC1 SPO.IDE.A.146 Lightweight flight recorder	2207
GM1 SPO.IDE.A.146 Lightweight flight recorder.....	2208
GM1 SPO.IDE.A.146(e) Lightweight flight recorder	2209
GM2 SPO.IDE.A.146 Lightweight flight recorder.....	2209
GM3 SPO.IDE.A.146 Lightweight flight recorder.....	2209
SPO.IDE.A.150 Data link recording.....	2210
AMC1 SPO.IDE.A.150 Data link recording	2210
GM1 SPO.IDE.A.150 Data link recording	2212
GM1 SPO.IDE.A.150(a) Data link recording.....	2214
SPO.IDE.A.155 Flight data and cockpit voice combination recorder	2214
AMC1 SPO.IDE.A.155 Flight data and cockpit voice combination recorder	2214
GM1 SPO.IDE.A.155 Flight data and cockpit voice combination recorder	2215
SPO.IDE.A.160 Seats, seat safety belts and restraint systems	2215
AMC1 SPO.IDE.A.160 Seats, seat safety belts and restraint systems.....	2216
GM1 SPO.IDE.A.160 Seats, seat safety belts, restraint systems.....	2216
SPO.IDE.A.165 First-aid kit	2216
AMC1 SPO.IDE.A.165 First-aid kit.....	2217
AMC2 SPO.IDE.A.165 First-aid kit.....	2217
AMC3 SPO.IDE.A.165 First-aid kit.....	2218
GM1 SPO.IDE.A.165 First-aid kit.....	2219
GM2 SPO.IDE.A.165 First-aid kit.....	2219
GM3 SPO.IDE.A.165 First-aid kit.....	2219
GM4 SPO.IDE.A.165 First-aid kit.....	2219
SPO.IDE.A.170 Supplemental oxygen – pressurised aeroplanes	2219
AMC1 SPO.IDE.A.170 Supplemental oxygen – pressurised aeroplanes	2220
GM1 SPO.IDE.A.170(c)(2) Supplemental oxygen – pressurised aeroplanes.....	2220
SPO.IDE.A.175 Supplemental oxygen – non-pressurised aeroplanes.....	2221
AMC1 SPO.IDE.A.175 Supplemental oxygen – non-pressurised aeroplanes.....	2221
SPO.IDE.A.180 Hand fire extinguishers	2221
AMC1 SPO.IDE.A.180 Hand fire extinguishers	2221
SPO.IDE.A.181 Crash axe and crowbar	2222
SPO.IDE.A.185 Marking of break-in points	2222
AMC1 SPO.IDE.A.185 Marking of break-in points	2223
SPO.IDE.A.190 Emergency locator transmitter (ELT)	2223
AMC1 SPO.IDE.A.190 Emergency locator transmitter (ELT).....	2223
AMC2 SPO.IDE.A.190 Emergency locator transmitter (ELT).....	2224
AMC3 SPO.IDE.A.190 Emergency locator transmitter (ELT).....	2224
AMC4 SPO.IDE.A.190 Emergency locator transmitter (ELT).....	2224
GM1 SPO.IDE.A.190 Emergency locator transmitter (ELT).....	2224
GM2 SPO.IDE.A.190 Emergency locator transmitter (ELT).....	2225
GM3 SPO.IDE.A.190 Emergency locator transmitter (ELT).....	2225
SPO.IDE.A.195 Flight over water	2225

AMC1 SPO.IDE.A.195 Flight over water	2226
AMC2 SPO.IDE.A.195 Flight over water	2226
GM1 SPO.IDE.A.195 Flight over water	2227
SPO.IDE.A.200 Survival equipment	2227
AMC1 SPO.IDE.A.200 Survival equipment.....	2227
AMC1 SPO.IDE.A.200(a)(2) Survival equipment.....	2228
AMC1 SPO.IDE.A.200(b)(2) Survival equipment.....	2228
GM1 SPO.IDE.A.200 Survival equipment	2228
GM2 SPO.IDE.A.200 Survival equipment	2228
SPO.IDE.A.205 Individual protective equipment	2228
GM1 SPO.IDE.A.205 Individual protective equipment	2229
SPO.IDE.A.210 Headset	2229
AMC1 SPO.IDE.A.210 Headset	2229
GM1 SPO.IDE.A.210 Headset	2229
SPO.IDE.A.215 Radio communication equipment	2229
AMC1 SPO.IDE.A.215 & SPO.IDE.A.220 Radio communication equipment & Navigation equipment.....	2230
GM1 SPO.IDE.A.215 Radio communication equipment.....	2230
GM1 SPO.IDE.A.215 & SPO.IDE.A.220 Radio communication equipment & Navigation equipment.....	2230
SPO.IDE.A.220 Navigation equipment	2234
AMC1 SPO.IDE.A.220 Navigation equipment.....	2234
GM1 SPO.IDE.A.220 Navigation equipment.....	2234
GM2 SPO.IDE.A.220 Navigation equipment.....	2238
SPO.IDE.A.225 Transponder	2238
AMC1 SPO.IDE.A.225 Transponder	2239
SPO.IDE.A.230 Management of aeronautical databases	2239
AMC1 SPO.IDE.A.230 Management of aeronautical databases.....	2239
GM1 SPO.IDE.A.230 Management of aeronautical databases.....	2239
GM2 SPO.IDE.A.230 Management of aeronautical databases.....	2239
GM3 SPO.IDE.A.230 Management of aeronautical databases.....	2240
SECTION 2 – Helicopters.....	2240
SPO.IDE.H.100 Instruments and equipment – general	2240
GM1 SPO.IDE.H.100(a) Instruments and equipment – general	2241
GM1 SPO.IDE.H.100(b) Instruments and equipment – general	2241
GM1 SPO.IDE.H.100(c) Instruments and equipment – general.....	2241
GM1 SPO.IDE.H.100(d) Instruments and equipment – general	2242
SPO.IDE.H.105 Minimum equipment for flight.....	2242
AMC1 SPO.IDE.H.105 Minimum equipment for flight.....	2242
GM1 SPO.IDE.H.105 Minimum equipment for flight	2242
SPO.IDE.H.115 Operating lights	2242
AMC1 SPO.IDE.H.115 Operating lights	2243
SPO.IDE.H.120 Operations under VFR – flight and navigational instruments and associated equipment.....	2243
AMC1 SPO.IDE.H.120 & SPO.IDE.H.125 Operations under VFR & operations under IFR – flight and navigational instruments and associated equipment	2244
AMC1 SPO.IDE.H.120(a)(1) & SPO.IDE.H.125(a)(1) Operations under VFR & operations under IFR – flight and navigational instruments and associated equipment	2244
AMC1 SPO.IDE.H.120(a)(2) & SPO.IDE.H.125(a)(2) Operations under VFR & operations under IFR – flight and navigational instruments and associated equipment	2244
AMC1 SPO.IDE.H.120(a)(3) & SPO.IDE.H.125(a)(3) Operations under VFR & operations under IFR – flight and navigational instruments and associated equipment	2245
AMC1 SPO.IDE.H.120(a)(4) & SPO.IDE.H.125(a)(4) Operations under VFR & operations under IFR – flight and navigational instruments and associated equipment	2245
AMC1 SPO.IDE.H.120(a)(5) Operations under VFR – flight and navigational instruments and associated equipment	2245
AMC1 SPO.IDE.H.120(b)(1)(iii) & SPO.IDE.H.125(a)(8) Operations under VFR & operations under IFR – flight and navigational instruments and associated equipment.....	2245

AMC1 SPO.IDE.H.120(b)(3) & SPO.IDE.H.125(d) Operations under VFR & operations under IFR – flight and navigational instruments and associated equipment	2246
AMC1 SPO.IDE.H.120(d) Operations under VFR — flight and navigational instruments and associated equipment	2246
GM1 SPO.IDE.H.120(d) Operations under VFR — flight and navigational instruments and associated equipment	2246
AMC1 SPO.IDE.H.120(d) & SPO.IDE.H.125(c) Operations under VFR & operations under IFR – flight and navigational instruments and associated equipment	2246
SPO.IDE.H.125 Operations under IFR – flight and navigational instruments and associated equipment	2246
GM1 SPO.IDE.H.125(a)(3) Operations under IFR – flight and navigational instruments and associated equipment	2247
AMC1 SPO.IDE.H.125(a)(9) Operations under IFR – flight and navigational instruments and associated equipment	2247
AMC1 SPO.IDE.H.125(c) Operations under IFR — flight and navigational instruments and associated equipment	2248
AMC1 SPO.IDE.H.125(f)(2) Operations under IFR – flight and navigational instruments and associated equipment	2248
SPO.IDE.H.126 Additional equipment for single-pilot operation under IFR	2248
SPO.IDE.H.132 Airborne weather detecting equipment – complex motor-powered helicopters	2248
AMC1 SPO.IDE.H.132 Airborne weather detecting equipment – complex motor-powered helicopters	2248
SPO.IDE.H.133 Additional equipment for operations in icing conditions at night – complex motor-powered helicopters	2249
SPO.IDE.H.135 Flight crew interphone system	2249
AMC1 SPO.IDE.H.135 Flight crew interphone system	2249
SPO.IDE.H.140 Cockpit voice recorder	2249
AMC1 SPO.IDE.H.140 Cockpit voice recorder	2250
SPO.IDE.H.145 Flight data recorder	2250
AMC1 SPO.IDE.H.145 Flight data recorder	2250
AMC2 SPO.IDE.H.145 Flight data recorder	2253
SPO.IDE.H.146 Lightweight flight recorder	2256
AMC1 SPO.IDE.H.146 Lightweight flight recorder	2257
GM1 SPO.IDE.H.146 Lightweight flight recorder	2258
GM1 SPO.IDE.H.146(e) Lightweight flight recorder	2258
GM2 SPO.IDE.H.146 Lightweight flight recorder	2258
GM3 SPO.IDE.H.146 Lightweight flight recorder	2258
SPO.IDE.H.150 Data link recording	2258
AMC1 SPO.IDE.H.150 Data link recording	2259
GM1 SPO.IDE.H.150 Data link recording	2261
GM1 SPO.IDE.H.150(a) Data link recording	2263
SPO.IDE.H.155 Flight data and cockpit voice combination recorder	2263
GM1 SPO.IDE.H.155 Flight data and cockpit voice combination recorder	2263
SPO.IDE.H.160 Seats, seat safety belts and restraint systems	2263
AMC2 SPO.IDE.H.160 Seats, seat safety belts and restraint systems	2264
SPO.IDE.H.165 First-aid kit	2264
AMC1 SPO.IDE.H.165 First-aid kit	2264
AMC2 SPO.IDE.H.165 First-aid kit	2265
AMC3 SPO.IDE.H.165 First-aid kit	2266
GM1 SPO.IDE.H.165 First-aid kit	2266
GM2 SPO.IDE.H.165 First-aid kit	2267
GM3 SPO.IDE.H.165 First-aid kit	2267
GM4 SPO.IDE.H.165 First-aid kit	2267
SPO.IDE.H.175 Supplemental oxygen – non-pressurised helicopters	2267
AMC1 SPO.IDE.H.175 Supplemental oxygen – non-pressurised helicopters	2268
SPO.IDE.H.180 Hand fire extinguishers	2268
AMC1 SPO.IDE.H.180 Hand fire extinguishers	2268

SPO.IDE.H.185 Marking of break-in points	2269
AMC1 SPO.IDE.H.185 Marking of break-in points	2269
SPO.IDE.H.190 Emergency locator transmitter (ELT)	2269
AMC1 SPO.IDE.H.190 Emergency locator transmitter (ELT)	2270
AMC2 SPO.IDE.H.190 Emergency locator transmitter (ELT)	2270
AMC3 SPO.IDE.H.190 Emergency locator transmitter (ELT)	2271
AMC4 SPO.IDE.H.190 Emergency locator transmitter (ELT)	2271
GM1 SPO.IDE.H.190 Emergency locator transmitter (ELT)	2271
GM2 SPO.IDE.H.190 Emergency locator transmitter (ELT)	2271
GM3 SPO.IDE.H.190 Emergency locator transmitter (ELT)	2271
SPO.IDE.H.195 Flight over water – other-than complex motor-powered helicopters	2272
AMC1 SPO.IDE.H.195 Flight over water – other-than complex motor-powered helicopters	2272
GM1 SPO.IDE.H.195 Flight over water – other-than complex motor-powered helicopters	2273
SPO.IDE.H.197 Life-jackets – complex motor-powered helicopters	2273
AMC1 SPO.IDE.H.197 Life-jackets – complex motor-powered helicopters	2273
GM1 SPO.IDE.H.197 Life-jackets – complex motor-powered helicopters	2274
SPO.IDE.H.198 Survival suits – complex motor-powered helicopters	2274
GM1 SPO.IDE.H.198 Survival suits – complex motor-powered helicopters	2274
SPO.IDE.H.199 Life-rafts, survival ELTs and survival equipment on extended overwater flights – complex motor-powered helicopters	2276
AMC1 SPO.IDE.H.199 Life-rafts, survival ELTs and survival equipment on extended overwater flights – complex motor-powered helicopters	2277
SPO.IDE.H.200 Survival equipment	2278
AMC1 SPO.IDE.H.200 Survival equipment	2278
AMC1 SPO.IDE.H.200(b) Survival equipment	2278
GM1 SPO.IDE.H.200 Survival equipment	2278
GM2 SPO.IDE.H.200 Survival equipment	2279
SPO.IDE.H.202 Helicopters certified for operating on water – miscellaneous equipment	2279
GM1 SPO.IDE.H.202 Helicopters certificated for operating on water – miscellaneous equipment	2279
SPO.IDE.H.203 All helicopters on flights over water – ditching	2279
AMC1 SPO.IDE.H.203 All helicopters on flights over water – ditching	2280
SPO.IDE.H.205 Individual protective equipment	2280
GM1 SPO.IDE.H.205 Individual protective equipment	2280
SPO.IDE.H.210 Headset	2280
AMC1 SPO.IDE.H.210 Headset	2280
GM1 SPO.IDE.H.210 Headset	2280
SPO.IDE.H.215 Radio communication equipment	2281
GM1 SPO.IDE.H.215 Radio communication equipment	2281
SPO.IDE.H.220 Navigation equipment	2281
AMC1 SPO.IDE.H.220 Navigation equipment	2282
GM1 SPO.IDE.H.220 Navigation equipment	2282
GM2 SPO.IDE.H.220 Navigation equipment	2286
SPO.IDE.H.225 Transponder	2286
AMC1 SPO.IDE.H.225 Transponder	2286
SPO.IDE.H.230 Management of aeronautical databases	2286
AMC1 SPO.IDE.H.230 Management of aeronautical databases	2287
GM1 SPO.IDE.H.230 Management of aeronautical databases	2287
GM2 SPO.IDE.H.230 Management of aeronautical databases	2287
GM3 SPO.IDE.H.230 Management of aeronautical databases	2287
SUBPART E: SPECIFIC REQUIREMENTS	2288
SECTION 1 – Helicopter external sling load operations (HESLO)	2288

SPO.SPEC.HESLO.100 Standard operating procedures	2288
AMC1 SPO.SPEC.HESLO.100 Standard operating procedures	2288
GM1 SPO.SPEC.HESLO.100 Standard operating procedures	2295
SPO.SPEC.HESLO.105 Specific HESLO equipment	2296
SPO.SPEC.HESLO.110 Transportation of dangerous goods	2296
SECTION 2 – Human external cargo operations (HEC)	2296
SPO.SPEC.HEC.100 Standard operating procedures	2296
AMC1 SPO.SPEC.HEC.100 Standard operating procedures	2297
SPO.SPEC.HEC.105 Specific HEC equipment	2302
AMC1 SPO.SPEC.HEC.105(b) Specific HEC equipment	2302
SECTION 3 – Parachute operations (PAR)	2303
SPO.SPEC.PAR.100 Standard operating procedures	2303
SPO.SPEC.PAR.105 Carriage of crew members and task specialists	2303
SPO.SPEC.PAR.110 Seats	2303
SPO.SPEC.PAR.115 Supplemental oxygen	2303
SPO.SPEC.PAR.125 Releasing of dangerous goods	2304
SECTION 4 – Aerobatic flights (ABF)	2304
SPO.SPEC.ABF.100 Standard operating procedures	2304
SPO.SPEC.ABF.105 Documents, manuals and information to be carried	2304
SPO.SPEC.ABF.115 Equipment	2304
SECTION 5 – Maintenance check flights (MCFs)	2305
SPO.SPEC.MCF.100 Levels of maintenance check flight	2305
SPO.SPEC.MCF.105 Flight programme for a 'Level A' maintenance check flight	2305
GM1 SPO.SPEC.MCF.105 Flight programme	2305
SPO.SPEC.MCF.110 Maintenance check flight manual for a 'Level A' maintenance check flight	2305
AMC1 SPO.SPEC.MCF.110 Maintenance check flight manual	2305
SPO.SPEC.MCF.115 Flight crew requirements for a 'Level A' maintenance check flight	2307
GM1 SPO.SPEC.MCF.115 and SPO.SPEC.MCF.120 Flight crew requirements for a "Level A" maintenance check flight & Flight crew training course for Level A maintenance check flights	2308
SPO.SPEC.MCF.120 Flight crew training course for Level A maintenance check flights	2308
AMC1 SPO.SPEC.MCF.120 Flight crew training course	2308
AMC2 SPO.SPEC.MCF.120 Flight crew training course	2309
SPO.SPEC.MCF.125 Crew composition and persons on board	2309
GM1 SPO.SPEC.MCF.125 Crew composition and persons on board	2310
SPO.SPEC.MCF.130 Simulated abnormal or emergency procedures in flight ...	2310
SPO.SPEC.MCF.135 Flight time limitations and rest requirements	2310
SPO.SPEC.MCF.140 Systems and equipment	2310
SPO.SPEC.MCF.145 Cockpit voice recorder, flight data recorder and data link recording requirements for AOC holders	2311

RULE AMENDMENT STATUS

SUMMARY OF CHANGES — REVISION 19 (NOVEMBER 2022)

1. Commission Implementing Regulation (EU) 2022/2203 of 11 November 2022 amending Regulation (EU) No 965/2012 as regards the applicability of the requirements for locating an aircraft in distress

amends:

- Annex IV (Part-CAT) to,

Regulation (EU) No 965/2012.

ICAO Standard 6.18.1 was incorporated into point CAT.GEN.MPA.210 of Annex IV (Part-CAT) to Commission Regulation (EU) No 965/2012 (2), which requires certain aeroplanes to be equipped with robust and automatic means to accurately determine, following an accident during which the aeroplane is severely damaged, the location of the point of end of flight.

The ICAO Council adopted Amendment 48 to ICAO Annex 6, Part I at the 16th Meeting of their 226th Session on 18 July 2022. That amendment postpones the applicability date of ICAO Standard 6.18.1 to 1 January 2025 and restricts its applicability to aeroplanes first issued with an individual Certificate of Airworthiness (CofA) on or after 1 January 2024.

That amendment intends (i) to address the significant delays, faced by all aircraft manufacturers concerned worldwide, in fitting aeroplanes with the required equipment, and setting up the necessary communication infrastructure between all relevant stakeholders (including air traffic service (ATS) providers and rescue coordination centres (RCCs)); and (ii) to provide more time for RCCs and ATS units to prepare and adapt their procedures.

The amendment shall become **applicable from 4 December 2022**.

Date of publication in the Official Journal: 14 November 2022.

Date of entry into force of Regulation (EU) 2022/2203: on the twentieth day following that of its publication in the Official Journal of the European Union: 4 December 2022

REVISION TABLE (IRs)

AIR OPS RULES AMENDED BY IMPLEMENTING REGULATION (EU) 2022/2203

Part, subpart, article, rule	Action	EDD Issue/ Amdt. no	Amended by Commission Regulation
Annex IV (Part-CAT)			
CAT.GEN.MPA.210	Changed	N/a	Regulation (EU) 2022/2203

2. EASA Executive Director Decision 2022/017/R of 2 September 2022 issues:

- Amendment 22 to Issue 2 of the Acceptable Means of Compliance and Guidance Material to Annex III (Part-ORO)

to **Regulation (EU) No 965/2012** to facilitate the implementation of the new requirements introduced by Regulation (EU) 2022/410, which amended Regulation (EU) No 1321/2014

(‘Continuing Airworthiness (CAW) Regulation’) as regards the CAW management in a single air carrier business grouping.

This Decision amends the Acceptable Means of Compliance (AMC) & Guidance Material (GM) to Annex I (Part M) and Annex Vc (Part-CAMO) to the CAW Regulation, as well as the AMC & GM to Annex III (Part-ORO) to Regulation (EU) No 965/2012 (‘Air OPS Regulation’) regarding the following topics:

- definition of a ‘single air carrier business grouping’;
- harmonisation of the management systems of the organisations involved;
- cooperation in the oversight by competent authorities (CAs) of the organisations involved; and
- nomination by the operator of the person responsible for the management and supervision of the contract with a CAMO.

The new AMC and GM shall become **applicable from 3 September 2022**.

Date of publication of ED Decision 2022/017/R in the Official Publication of EASA: 2 September 2022.

Date of entry into force of ED Decision 2022/017/R: on the day following that of its publication in the Official Publication of EASA: 3 September 2022.

REVISION TABLE (IRs)

AIR OPS RULES AMENDED BY ED DECISION 2022/017/R

Part, subpart, article, rule	Action	EDD Issue/ Amdt. no	Amended by EASA ED Decision
Annex III (Part-ORO)			
GM2 ORO.AOC.135(a)	Changed	Issue 2, Amdt 22	ED Decision 2022/017/R
AMC1 ORO.AOC.135(a)(4)	New	Issue 2, Amdt 22	ED Decision 2022/017/R
GM1 ORO.AOC.135(a)(4)	New	Issue 2, Amdt 22	ED Decision 2022/017/R

3. EASA Executive Director Decision 2022/014/R of 18 August 2022 issues:

- Amendment 21 to Issue 2 of the Acceptable Means of Compliance and Guidance Material to Annex III (Part-ORO);
- Amendment 22 to Issue 2 of the Acceptable Means of Compliance and Guidance Material to Annex IV (Part-CAT);
- Amendment 13 to Issue 1 of the Acceptable Means of Compliance and Guidance Material to Annex V (Part-SPA);
- Amendment 17 to Issue 1 of the Acceptable Means of Compliance and Guidance Material to Annex VI (Part-NCC);
- Amendment 14 to Issue 2 of the Acceptable Means of Compliance and Guidance Material to Annex VII (Part-NCO); and
- Amendment 17 to Issue 1 of the Acceptable Means of Compliance and Guidance Material to Annex VIII (Part-SPO)

to **Regulation (EU) No 965/2012** to facilitate the implementation of the new requirements related to flight crew training introduced into Regulation (EU) No 965/2012 (the 'Air OPS Regulation') by Commission Implementing Regulation (EU) 2021/2237 and into Regulation (EU) No 1178/2011 (the 'Aircrew Regulation') by Commission Implementing Regulation (EU) 2021/2227. Those Regulations and this ED Decision amend the operator's flight crew training and checking provisions to better reflect the increased complexity in the aviation system. The updates cover aeroplanes and helicopters that carry out commercial air transport (CAT) operations, specialised operations (SPO) and non-commercial operations with complex motor-powered aircraft (NCC).

The most important items are:

- new conditions for multi-pilot operations in single-pilot certified helicopters;
- new provisions for initial training and checking under SPO;
- new provisions for recurrent training and checking under CAT and SPO;
- new conditions for the operation on different aircraft types or variants;
- introduction of the option for NCC operators to accept previous training and checking; and
- addressing other minor issues regarding flight crew training and checking.

Some changes are expected to increase safety in a cost-effective way, whereas others should reduce the training costs without an impact on safety. Several clarifications are also introduced to maintain a high level of safety for air operations by ensuring a harmonised implementation of the Air OPS and the Aircrew Regulations.

The new AMC and GM shall become **applicable from 30 October 2022 except for the following provisions, which will apply from 26 March 2023:**

- AMC2 ORO.FC.105(b)(2);(c),
- GM2ORO.FC.105(b)(2),
- AMC1 ORO.FC.105(b)(3),
- AMC1 ORO.FC.115,
- AMC1 ORO.FC.120,
- AMC3 ORO.FC.120,
- AMC1 ORO.FC.125(b),
- AMC1 ORO.FC.130,
- AMC1 ORO.FC.135,
- AMC1 ORO.FC.145(a),
- GM1 ORO.FC.145(a),
- AMC2 ORO.FC.145(d),
- GM1 ORO.FC.145(d),
- AMC2 ORO.FC.146,
- AMC1 ORO.FC.215,
- AMC1 ORO.FC.220,

- AMC3 ORO.FC.220,
- AMC1 ORO.FC.230,
- AMC3 ORO.FC.230,
- GM1 ORO.FC.230,
- AMC1 ORO.FC.A.245,
- AMC1 ORO.FC.A.245(d);(e)(2),
- AMC1 ORO.FC.320,
- AMC1 ORO.FC.325,
- AMC1 ORO.FC.330,
- GM1 ORO.FC.330, and
- AMC1 ORO.CC.115(e).

Date of publication of ED Decision 2022/014/R in the Official Publication of EASA: 19 August 2022.

Date of entry into force of ED Decision 2022/014/R: on the day following that of its publication in the Official Publication of EASA: 20 August 2022.

REVISION TABLE (IRs)

AIR OPS RULES AMENDED BY ED DECISION 2022/014/R

Part, subpart, article, rule	Action	EDD Issue/ Amdt. no	Amended by EASA ED Decision
Annex III (Part-ORO)			
GM2 ORO.GEN.110(f)	Changed	Issue 2, Amdt 21	ED Decision 2022/014/R
AMC1 ORO.FC.100(c)	Deleted	Issue 2, Amdt 21	ED Decision 2022/014/R
GM1 ORO.FC.100(c)	New	Issue 2, Amdt 21	ED Decision 2022/014/R
AMC1 ORO.FC.105(b)(2);(c)	Changed	Issue 2, Amdt 21	ED Decision 2022/014/R
AMC2 ORO.FC.105(b)(2);(c)	New	Issue 2, Amdt 21	ED Decision 2022/014/R
GM2 ORO.FC.105(b)(2)	New	Issue 2, Amdt 21	ED Decision 2022/014/R
AMC1 ORO.FC.105(b)(3)	New	Issue 2, Amdt 21	ED Decision 2022/014/R
AMC1 ORO.FC.105(c)	Changed	Issue 2, Amdt 21	ED Decision 2022/014/R
GM1 ORO.FC.105(c)	New	Issue 2, Amdt 21	ED Decision 2022/014/R
AMC1 ORO.FC.105(d)	New	Issue 2, Amdt 21	ED Decision 2022/014/R
AMC1 ORO.FC.115	Changed	Issue 2, Amdt 21	ED Decision 2022/014/R
AMC2 ORO.FC.115	Changed	Issue 2, Amdt 21	ED Decision 2022/014/R
AMC2 ORO.FC.146	Changed	Issue 2, Amdt 21	ED Decision 2022/014/R
GM3 ORO.FC.115	Changed	Issue 2, Amdt 21	ED Decision 2022/014/R
GM8 ORO.FC.115	New	Issue 2, Amdt 21	ED Decision 2022/014/R
AMC1 ORO.FC.120	New	Issue 2, Amdt 21	ED Decision 2022/014/R
AMC2 ORO.FC.120	New	Issue 2, Amdt 21	ED Decision 2022/014/R
AMC3 ORO.FC.120	New	Issue 2, Amdt 21	ED Decision 2022/014/R

GM1 ORO.FC.120	New	Issue 2, Amdt 21	ED Decision 2022/014/R
AMC1 ORO.FC.125	Changed	Issue 2, Amdt 21	ED Decision 2022/014/R
AMC2 ORO.FC.125	New	Issue 2, Amdt 21	ED Decision 2022/014/R
GM1 ORO.FC.125	New	Issue 2, Amdt 21	ED Decision 2022/014/R
AMC1 ORO.FC.125(b)	New	Issue 2, Amdt 21	ED Decision 2022/014/R
GM1 ORO.FC.125(b)	New	Issue 2, Amdt 21	ED Decision 2022/014/R
GM2 ORO.FC.125(b)	New	Issue 2, Amdt 21	ED Decision 2022/014/R
AMC1 ORO.FC.130	New	Issue 2, Amdt 21	ED Decision 2022/014/R
GM1 ORO.FC.130	New	Issue 2, Amdt 21	ED Decision 2022/014/R
AMC1 ORO.FC.130(a)	New	Issue 2, Amdt 21	ED Decision 2022/014/R
AMC1 ORO.FC.135	New	Issue 2, Amdt 21	ED Decision 2022/014/R
GM1 ORO.FC.140	New	Issue 2, Amdt 21	ED Decision 2022/014/R
AMC1 ORO.FC.140(a)	New	Issue 2, Amdt 21	ED Decision 2022/014/R
GM1 ORO.FC.140(a)	New	Issue 2, Amdt 21	ED Decision 2022/014/R
AMC1 ORO.FC.140(b)	New	Issue 2, Amdt 21	ED Decision 2022/014/R
AMC1 ORO.FC.140(d)	New	Issue 2, Amdt 21	ED Decision 2022/014/R
AMC1 ORO.FC.145	New	Issue 2, Amdt 21	ED Decision 2022/014/R
GM1 ORO.FC.145	New	Issue 2, Amdt 21	ED Decision 2022/014/R
AMC1 ORO.FC.145(a)	New	Issue 2, Amdt 21	ED Decision 2022/014/R
GM1 ORO.FC.145(a)	New	Issue 2, Amdt 21	ED Decision 2022/014/R
AMC1 ORO.FC.145(b)	Changed	Issue 2, Amdt 21	ED Decision 2022/014/R
AMC1 ORO.FC.145(d)	Changed	Issue 2, Amdt 21	ED Decision 2022/014/R
AMC2 ORO.FC.145(d)	New	Issue 2, Amdt 21	ED Decision 2022/014/R
GM1 ORO.FC.145(d)	New	Issue 2, Amdt 21	ED Decision 2022/014/R
AMC1 ORO.FC.145(g)	New	Issue 2, Amdt 21	ED Decision 2022/014/R
AMC1 ORO.FC.146	New	Issue 2, Amdt 21	ED Decision 2022/014/R
AMC1 ORO.FC.146(b)	New	Issue 2, Amdt 21	ED Decision 2022/014/R
AMC1 ORO.FC.146(c)	Changed	Issue 2, Amdt 21	ED Decision 2022/014/R
AMC2 ORO.FC.146(c)	Changed	Issue 2, Amdt 21	ED Decision 2022/014/R
AMC1 ORO.FC.146(e);(f)&(g)	New	Issue 2, Amdt 21	ED Decision 2022/014/R
AMC1 ORO.FC.205	Changed	Issue 2, Amdt 21	ED Decision 2022/014/R
AMC1 ORO.FC.215	Changed	Issue 2, Amdt 21	ED Decision 2022/014/R
AMC1 ORO.FC.220	Changed	Issue 2, Amdt 21	ED Decision 2022/014/R
AMC3 ORO.FC.220	New	Issue 2, Amdt 21	ED Decision 2022/014/R
AMC1 ORO.FC.220(b)	New	Issue 2, Amdt 21	ED Decision 2022/014/R
AMC1 ORO.FC.220(f)	New	Issue 2, Amdt 21	ED Decision 2022/014/R
GM1 ORO.FC.220(f)	New	Issue 2, Amdt 21	ED Decision 2022/014/R
AMC1 ORO.FC.230	Changed	Issue 2, Amdt 21	ED Decision 2022/014/R
AMC3 ORO.FC.230	New	Issue 2, Amdt 21	ED Decision 2022/014/R
GM1 ORO.FC.230	Changed	Issue 2, Amdt 21	ED Decision 2022/014/R
GM3 ORO.FC.231(a)	Changed	Issue 2, Amdt 21	ED Decision 2022/014/R
GM3 ORO.FC.231(a)(2)	Changed	Issue 2, Amdt 21	ED Decision 2022/014/R
GM1 ORO.FC.231(a)(5)	Changed	Issue 2, Amdt 21	ED Decision 2022/014/R

AMC1 ORO.FC.231(c)	Changed	Issue 2, Amdt 21	ED Decision 2022/014/R
AMC4 ORO.FC.231(d)(1)	Changed	Issue 2, Amdt 21	ED Decision 2022/014/R
GM1 ORO.FC.231(d)(1)	Changed	Issue 2, Amdt 21	ED Decision 2022/014/R
GM2 ORO.FC.231(d)(1)	Changed	Issue 2, Amdt 21	ED Decision 2022/014/R
AMC1 ORO.FC.231(d)(2)	Changed	Issue 2, Amdt 21	ED Decision 2022/014/R
AMC2 ORO.FC.232	Changed	Issue 2, Amdt 21	ED Decision 2022/014/R
AMC3 ORO.FC.232	Changed	Issue 2, Amdt 21	ED Decision 2022/014/R
AMC4 ORO.FC.232	Changed	Issue 2, Amdt 21	ED Decision 2022/014/R
AMC6 ORO.FC.232	Changed	Issue 2, Amdt 21	ED Decision 2022/014/R
AMC1 ORO.FC.235(d)	Deleted	Issue 2, Amdt 21	ED Decision 2022/014/R
GM1 ORO.FC.235(e);(f)	Changed	Issue 2, Amdt 21	ED Decision 2022/014/R
AMC1 ORO.FC.236	New	Issue 2, Amdt 21	ED Decision 2022/014/R
GM1 ORO.FC.236	New	Issue 2, Amdt 21	ED Decision 2022/014/R
AMC1 ORO.FC.240	Changed	Issue 2, Amdt 21	ED Decision 2022/014/R
AMC2 ORO.FC.240	Deleted	Issue 2, Amdt 21	ED Decision 2022/014/R
AMC1 ORO.FC.A.245	Changed	Issue 2, Amdt 21	ED Decision 2022/014/R
GM3 ORO.FC.A.245	New	Issue 2, Amdt 21	ED Decision 2022/014/R
GM1 ORO.FC.A.245(e)(2)	New	Issue 2, Amdt 21	ED Decision 2022/014/R
AMC1 ORO.FC.A.245(d);(e)(2)	Changed	Issue 2, Amdt 21	ED Decision 2022/014/R
AMC1 ORO.FC.A.245(g)	New	Issue 2, Amdt 21	ED Decision 2022/014/R
AMC1 ORO.FC.320	New	Issue 2, Amdt 21	ED Decision 2022/014/R
AMC1 ORO.FC.325	New	Issue 2, Amdt 21	ED Decision 2022/014/R
AMC1 ORO.FC.330	New	Issue 2, Amdt 21	ED Decision 2022/014/R
GM1 ORO.FC.330	New	Issue 2, Amdt 21	ED Decision 2022/014/R
AMC1 ORO.CC.115(e)	Changed	Issue 2, Amdt 21	ED Decision 2022/014/R
AMC2 ORO.CC.115(e)	Changed	Issue 2, Amdt 21	ED Decision 2022/014/R
GM2 ORO.CC.115(e)	Changed	Issue 2, Amdt 21	ED Decision 2022/014/R
GM3 ORO.CC.115(e)	Changed	Issue 2, Amdt 21	ED Decision 2022/014/R
GM4 ORO.CC.115(e)	Changed	Issue 2, Amdt 21	ED Decision 2022/014/R
GM6 ORO.CC.115(e)	New	Issue 2, Amdt 21	ED Decision 2022/014/R
Annex IV (Part-CAT)			
GM1 CAT.OP.MPA.101(b)	Changed	Issue 2, Amdt 22	ED Decision 2022/014/R
AMC5 CAT.OP.MPA.110	Changed	Issue 2, Amdt 22	ED Decision 2022/014/R
AMC11 CAT.OP.MPA.110	Changed	Issue 2, Amdt 22	ED Decision 2022/014/R
AMC1 CAT.OP.MPA.115(a)	Changed	Issue 2, Amdt 22	ED Decision 2022/014/R
AMC1 CAT.OP.MPA.140(d)	Changed	Issue 2, Amdt 22	ED Decision 2022/014/R
AMC9 CAT.OP.MPA.182	Changed	Issue 2, Amdt 22	ED Decision 2022/014/R
AMC2 CAT.OP.MPA.312(a)(2)	Changed	Issue 2, Amdt 22	ED Decision 2022/014/R
Annex V (Part-SPA)			
AMC1 SPA.LVO.100(a)	Changed	Issue 1, Amdt 13	ED Decision 2022/014/R
AMC3 SPA.LVO.100(b)	Changed	Issue 1, Amdt 13	ED Decision 2022/014/R
GM3 SPA.LVO.110	Changed	Issue 1, Amdt 13	ED Decision 2022/014/R
GM4 SPA.LVO.110	Changed	Issue 1, Amdt 13	ED Decision 2022/014/R

GM8 SPA.LVO.110	Changed	Issue 1, Amdt 13	ED Decision 2022/014/R
AMC4 SPA.LVO.120(b)	Changed	Issue 1, Amdt 13	ED Decision 2022/014/R
Annex VI (Part-NCC)			
GM1 NCC.OP.101	Changed	Issue 1, Amdt 17	ED Decision 2022/014/R
AMC5 NCC.OP.110	Changed	Issue 1, Amdt 17	ED Decision 2022/014/R
AMC9 NCC.OP.110	Changed	Issue 1, Amdt 17	ED Decision 2022/014/R
GM9 NCC.OP.110	Changed	Issue 1, Amdt 17	ED Decision 2022/014/R
GM1 NCC.OP.110(b)(5)	Changed	Issue 1, Amdt 17	ED Decision 2022/014/R
AMC2 NCC.OP.235(a)(2)	Changed	Issue 1, Amdt 17	ED Decision 2022/014/R
Annex VII (Part-NCO)			
GM1 NCO.OP.105	Deleted	Issue 2, Amdt 14	ED Decision 2022/014/R
Annex VIII (Part-SPO)			
GM1 SPO.OP.101	Changed	Issue 1, Amdt 17	ED Decision 2022/014/R
AMC3 SPO.OP.110	Changed	Issue 1, Amdt 17	ED Decision 2022/014/R
AMC4 SPO.OP.110	Changed	Issue 1, Amdt 17	ED Decision 2022/014/R
AMC5 SPO.OP.110	Changed	Issue 1, Amdt 17	ED Decision 2022/014/R
AMC9 SPO.OP.110	Changed	Issue 1, Amdt 17	ED Decision 2022/014/R
GM10 SPO.OP.110	Changed	Issue 1, Amdt 17	ED Decision 2022/014/R
AMC2 SPO.OP.116	Changed	Issue 1, Amdt 17	ED Decision 2022/014/R
AMC2 SPO.OP.235(a)(2)	Changed	Issue 1, Amdt 17	ED Decision 2022/014/R

4. EASA Executive Director Decision 2022/012/R of 30 June 2022 issues:

- Amendment 16 to Issue 1 of the Guidance Material to Annex I (Definitions for terms used in Annexes II to VIII);
- Amendment 13 to Issue 3 of the Acceptable Means of Compliance and Guidance Material to Annex II (Part-ARO);
- Amendment 20 to Issue 2 of the Acceptable Means of Compliance and Guidance Material to Annex III (Part-ORO);
- Amendment 21 to Issue 2 of the Acceptable Means of Compliance and Guidance Material to Annex IV (Part-CAT);
- Amendment 12 to Issue 1 of the Acceptable Means of Compliance and Guidance Material to Annex V (Part-SPA);
- Amendment 16 to Issue 1 of the Acceptable Means of Compliance and Guidance Material to Annex VI (Part-NCC);
- Amendment 13 to Issue 2 of the Acceptable Means of Compliance and Guidance Material to Annex VII (Part-NCO); and
- Amendment 16 to Issue 1 of the Acceptable Means of Compliance and Guidance Material to Annex VIII (Part-SPO)

to **Regulation (EU) No 965/2012** to facilitate the implementation of the new requirements introduced into Regulation (EU) No 965/2012 (the ‘Air OPS Regulation’) related to all-weather operations (AWOs) by Commission Implementing Regulation (EU) 2021/2237 (the ‘AWO Regulation’).

The AWO Regulation, which will apply from 30 October 2022, includes elements from two different areas: all-weather operations and operator flight crew training.

The AWO Regulation introduced a performance-based, ‘technology-neutral’ approach to the regulation of AWOs, which aims to facilitate a better integration and use of new, advanced technologies as well as new operational procedures to support AWOs and to ensure the availability of aerodrome infrastructure, information, and procedures to support AWOs. The new AMC and GM shall become **applicable from 30 October 2022**.

Date of publication of ED Decision 2022/012/R in the Official Publication of EASA: 30 June 2022.

Date of entry into force of ED Decision 2022/012/R: 1 July 2022.

REVISION TABLE (IRs)

AIR OPS RULES AMENDED BY ED DECISION 2022/012/R

Part, subpart, article, rule	Action	EDD Issue/ Amdt. no	Amended by EASA ED Decision
Annex I (Definitions)			
GM1 Annex I	Changed	Issue 1, Amdt 16	ED Decision 2022/012/R
GM2 Annex I	Changed	Issue 1, Amdt 16	ED Decision 2022/012/R
GM31 Annex I	New	Issue 1, Amdt 16	ED Decision 2022/012/R
GM32 Annex I	New	Issue 1, Amdt 16	ED Decision 2022/012/R
GM33 Annex I	New	Issue 1, Amdt 16	ED Decision 2022/012/R
GM34 Annex I	New	Issue 1, Amdt 16	ED Decision 2022/012/R
GM35 Annex I	New	Issue 1, Amdt 16	ED Decision 2022/012/R
Annex II (Part-ARO)			
AMC5 ARO.OPS.200	New	Issue 3, Amdt 13	ED Decision 2022/012/R
GM4 ARO.OPS.200	New	Issue 3, Amdt 13	ED Decision 2022/012/R
Annex III (Part-ORO)			
GM2 ORO.GEN.110(f)	Changed	Issue 2, Amdt 20	ED Decision 2022/012/R
GM1 ORO.GEN.130(b)	Changed	Issue 2, Amdt 20	ED Decision 2022/012/R
AMC3 ORO.GEN.160	New	Issue 2, Amdt 20	ED Decision 2022/012/R
GM1 ORO.GEN.160	New	Issue 2, Amdt 20	ED Decision 2022/012/R
AMC1 ORO.DEC.100(a);(d)	New	Issue 2, Amdt 20	ED Decision 2022/012/R
GM1 ORO.DEC.100(a);(d)	New	Issue 2, Amdt 20	ED Decision 2022/012/R
Annex IV (Part-CAT)			
GM1 CAT.OP.MPA.101(b)	New	Issue 2, Amdt 21	ED Decision 2022/012/R
AMC1 CAT.OP.MPA.110	Changed	Issue 2, Amdt 21	ED Decision 2022/012/R
AMC2 CAT.OP.MPA.110	Changed	Issue 2, Amdt 21	ED Decision 2022/012/R
AMC3 CAT.OP.MPA.110	Changed	Issue 2, Amdt 21	ED Decision 2022/012/R
AMC4 CAT.OP.MPA.110	New	Issue 2, Amdt 21	ED Decision 2022/012/R
AMC5 CAT.OP.MPA.110	Changed	Issue 2, Amdt 21	ED Decision 2022/012/R
AMC6 CAT.OP.MPA.110	Changed	Issue 2, Amdt 21	ED Decision 2022/012/R

AMC7 CAT.OP.MPA.110	Changed	Issue 2, Amdt 21	ED Decision 2022/012/R
AMC8 CAT.OP.MPA.110	Changed	Issue 2, Amdt 21	ED Decision 2022/012/R
AMC10 CAT.OP.MPA.110	Changed	Issue 2, Amdt 21	ED Decision 2022/012/R
AMC11 CAT.OP.MPA.110	Changed	Issue 2, Amdt 21	ED Decision 2022/012/R
GM2 CAT.OP.MPA.110	Changed	Issue 2, Amdt 21	ED Decision 2022/012/R
GM3 CAT.OP.MPA.110	Changed	Issue 2, Amdt 21	ED Decision 2022/012/R
GM4 CAT.OP.MPA.110	New	Issue 2, Amdt 21	ED Decision 2022/012/R
GM5 CAT.OP.MPA.110	New	Issue 2, Amdt 21	ED Decision 2022/012/R
GM6 CAT.OP.MPA.110	Changed	Issue 2, Amdt 21	ED Decision 2022/012/R
GM7 CAT.OP.MPA.110	New		
GM8 CAT.OP.MPA.110	New	Issue 2, Amdt 21	ED Decision 2022/012/R
GM9 CAT.OP.MPA.110	New	Issue 2, Amdt 21	ED Decision 2022/012/R
GM1 CAT.OP.MPA.110(b)(6)	New	Issue 2, Amdt 21	ED Decision 2022/012/R
AMC1 CAT.OP.MPA.115	Changed	Issue 2, Amdt 21	ED Decision 2022/012/R
AMC2 CAT.OP.MPA.115	Changed	Issue 2, Amdt 21	ED Decision 2022/012/R
AMC3 CAT.OP.MPA.115	Changed	Issue 2, Amdt 21	ED Decision 2022/012/R
AMC1 CAT.OP.MPA.115(a)	New	Issue 2, Amdt 21	ED Decision 2022/012/R
GM1 CAT.OP.MPA.115(a)	New	Issue 2, Amdt 21	ED Decision 2022/012/R
GM1 CAT.OP.MPA.115(b)	Changed	Issue 2, Amdt 21	ED Decision 2022/012/R
AMC2 CAT.OP.MPA.126	Changed	Issue 2, Amdt 21	ED Decision 2022/012/R
AMC8 CAT.OP.MPA.182	Changed	Issue 2, Amdt 21	ED Decision 2022/012/R
AMC9 CAT.OP.MPA.182	Changed	Issue 2, Amdt 21	ED Decision 2022/012/R
GM1 CAT.OP.MPA.185	Deleted	Issue 2, Amdt 21	ED Decision 2022/012/R
AMC1 CAT.OP.MPA.182(f)	Changed	Issue 2, Amdt 21	ED Decision 2022/012/R
AMC1 CAT.OP.MPA.192(d)	Changed	Issue 2, Amdt 21	ED Decision 2022/012/R
GM2 CAT.OP.MPA.192(d)	New	Issue 2, Amdt 21	ED Decision 2022/012/R
AMC1 CAT.OP.MPA.265(a)	New	Issue 2, Amdt 21	ED Decision 2022/012/R
GM1 CAT.OP.MPA.305	New	Issue 2, Amdt 21	ED Decision 2022/012/R
AMC1 CAT.OP.MPA.305(a)	New	Issue 2, Amdt 21	ED Decision 2022/012/R
AMC1 CAT.OP.MPA.305(b)	New	Issue 2, Amdt 21	ED Decision 2022/012/R
AMC1 CAT.OP.MPA.305(c)	Changed	Issue 2, Amdt 21	ED Decision 2022/012/R
GM1 CAT.OP.MPA.305(f)	Deleted	Issue 2, Amdt 21	ED Decision 2022/012/R
GM1 CAT.OP.MPA.312	New	Issue 2, Amdt 21	ED Decision 2022/012/R
AMC1 CAT.OP.MPA.312(a)(1)	New	Issue 2, Amdt 21	ED Decision 2022/012/R
AMC1 CAT.OP.MPA.312(a)(2)	New	Issue 2, Amdt 21	ED Decision 2022/012/R
AMC2 CAT.OP.MPA.312(a)(2)	New	Issue 2, Amdt 21	ED Decision 2022/012/R
AMC1 CAT.OP.MPA.312(a)(3)	New	Issue 2, Amdt 21	ED Decision 2022/012/R
AMC2 CAT.OP.MPA.312(a)(3)	New	Issue 2, Amdt 21	ED Decision 2022/012/R
AMC3 CAT.OP.MPA.312(a)(3)	New	Issue 2, Amdt 21	ED Decision 2022/012/R
AMC4 CAT.OP.MPA.312(a)(3)	New	Issue 2, Amdt 21	ED Decision 2022/012/R
AMC5 CAT.OP.MPA.312(a)(3)	New	Issue 2, Amdt 21	ED Decision 2022/012/R
GM1 CAT.OP.MPA.312(a)(3)	New	Issue 2, Amdt 21	ED Decision 2022/012/R
AMC1 CAT.OP.MPA.312(a)(4)	New	Issue 2, Amdt 21	ED Decision 2022/012/R

AMC1 CAT.OP.MPA.312(a)(8)	New	Issue 2, Amdt 21	ED Decision 2022/012/R
AMC1 CAT.OP.MPA.312(c)	New	Issue 2, Amdt 21	ED Decision 2022/012/R
GM1 CAT.OP.MPA.312(c)	New	Issue 2, Amdt 21	ED Decision 2022/012/R
AMC1 CAT.POL.A.230 & CAT.POL.A.235	Deleted	Issue 2, Amdt 21	ED Decision 2022/012/R
AMC1 CAT.POL.A.230	New	Issue 2, Amdt 21	ED Decision 2022/012/R
AMC2 CAT.POL.A.230	New	Issue 2, Amdt 21	ED Decision 2022/012/R
AMC1 CAT.POL.A.235	New	Issue 2, Amdt 21	ED Decision 2022/012/R
AMC2 CAT.POL.A.235	New	Issue 2, Amdt 21	ED Decision 2022/012/R
GM1 CAT.POL.H.400(c)	Changed	Issue 2, Amdt 21	ED Decision 2022/012/R
AMC2 CAT.IDE.A.190	Changed	Issue 2, Amdt 21	ED Decision 2022/012/R
AMC3 CAT.IDE.A.190	Changed	Issue 2, Amdt 21	ED Decision 2022/012/R
GM1 CAT.IDE.H.125(b)	New	Issue 2, Amdt 21	ED Decision 2022/012/R
GM1 CAT.IDE.H.130(h)	New	Issue 2, Amdt 21	ED Decision 2022/012/R
Annex V (Part-SPA)			
AMC1 SPA.LVO.100	Deleted	Issue 1, Amdt 12	ED Decision 2022/012/R
AMC3 SPA.LVO.100	Deleted	Issue 1, Amdt 12	ED Decision 2022/012/R
AMC4 SPA.LVO.100	Deleted	Issue 1, Amdt 12	ED Decision 2022/012/R
AMC6 SPA.LVO.100	Deleted	Issue 1, Amdt 12	ED Decision 2022/012/R
GM1 SPA.LVO.100	Changed	Issue 1, Amdt 12	ED Decision 2022/012/R
GM2 SPA.LVO.100	Changed	Issue 1, Amdt 12	ED Decision 2022/012/R
AMC1 SPA.LVO.100(a)	New	Issue 1, Amdt 12	ED Decision 2022/012/R
AMC2 SPA.LVO.100(a)	Changed	Issue 1, Amdt 12	ED Decision 2022/012/R
GM1 SPA.LVO.100(a)	New	Issue 1, Amdt 12	ED Decision 2022/012/R
GM2 SPA.LVO.100(a)	New	Issue 1, Amdt 12	ED Decision 2022/012/R
AMC1 SPA.LVO.100(b)	New	Issue 1, Amdt 12	ED Decision 2022/012/R
AMC2 SPA.LVO.100(b)	Changed	Issue 1, Amdt 12	ED Decision 2022/012/R
AMC3 SPA.LVO.100(b)	Changed	Issue 1, Amdt 12	ED Decision 2022/012/R
GM1 SPA.LVO.100(b)	New	Issue 1, Amdt 12	ED Decision 2022/012/R
GM2 SPA.LVO.100(b)	New	Issue 1, Amdt 12	ED Decision 2022/012/R
GM3 SPA.LVO.100(b)	Changed	Issue 1, Amdt 12	ED Decision 2022/012/R
GM4 SPA.LVO.100(b)	New	Issue 1, Amdt 12	ED Decision 2022/012/R
AMC1 SPA.LVO.100(c)	New	Issue 1, Amdt 12	ED Decision 2022/012/R
AMC2 SPA.LVO.100(c)	New	Issue 1, Amdt 12	ED Decision 2022/012/R
AMC3 SPA.LVO.100(c)	New	Issue 1, Amdt 12	ED Decision 2022/012/R
AMC4 SPA.LVO.100(c)	New	Issue 1, Amdt 12	ED Decision 2022/012/R
GM1 SPA.LVO.100(c)	New	Issue 1, Amdt 12	ED Decision 2022/012/R
GM2 SPA.LVO.100(c)	New	Issue 1, Amdt 12	ED Decision 2022/012/R
GM3 SPA.LVO.100(c)	New	Issue 1, Amdt 12	ED Decision 2022/012/R
GM4 SPA.LVO.100(c)	New	Issue 1, Amdt 12	ED Decision 2022/012/R
GM5 SPA.LVO.100(c)	New	Issue 1, Amdt 12	ED Decision 2022/012/R
GM6 SPA.LVO.100(c)	New	Issue 1, Amdt 12	ED Decision 2022/012/R
GM1 SPA.LVO.100(f)	Deleted	Issue 1, Amdt 12	ED Decision 2022/012/R

AMC1 SPA.LVO.105	Deleted	Issue 1, Amdt 12	ED Decision 2022/012/R
AMC2 SPA.LVO.105	Deleted	Issue 1, Amdt 12	ED Decision 2022/012/R
AMC3 SPA.LVO.105	Deleted	Issue 1, Amdt 12	ED Decision 2022/012/R
AMC4 SPA.LVO.105	Deleted	Issue 1, Amdt 12	ED Decision 2022/012/R
AMC5 SPA.LVO.105	Deleted	Issue 1, Amdt 12	ED Decision 2022/012/R
AMC6 SPA.LVO.105	Deleted	Issue 1, Amdt 12	ED Decision 2022/012/R
AMC1 SPA.LVO.105(a)	New	Issue 1, Amdt 12	ED Decision 2022/012/R
GM1 SPA.LVO.105(a)	New	Issue 1, Amdt 12	ED Decision 2022/012/R
AMC1 SPA.LVO.105(c)	New	Issue 1, Amdt 12	ED Decision 2022/012/R
AMC2 SPA.LVO.105(c)	New	Issue 1, Amdt 12	ED Decision 2022/012/R
AMC3 SPA.LVO.105(c)	New	Issue 1, Amdt 12	ED Decision 2022/012/R
AMC4 SPA.LVO.105(c)	New	Issue 1, Amdt 12	ED Decision 2022/012/R
AMC5 SPA.LVO.105(c)	New	Issue 1, Amdt 12	ED Decision 2022/012/R
AMC6 SPA.LVO.105(c)	New	Issue 1, Amdt 12	ED Decision 2022/012/R
AMC7 SPA.LVO.105(c)	New	Issue 1, Amdt 12	ED Decision 2022/012/R
GM1 SPA.LVO.105(c)	Changed	Issue 1, Amdt 12	ED Decision 2022/012/R
AMC1 SPA.LVO.105(g)	New	Issue 1, Amdt 12	ED Decision 2022/012/R
AMC2 SPA.LVO.105(g)	New	Issue 1, Amdt 12	ED Decision 2022/012/R
GM1 SPA.LVO.105(g)	Changed	Issue 1, Amdt 12	ED Decision 2022/012/R
GM2 SPA.LVO.105(g)	New	Issue 1, Amdt 12	ED Decision 2022/012/R
GM3 SPA.LVO.105(g)	New	Issue 1, Amdt 12	ED Decision 2022/012/R
GM1 SPA.LVO.110(c)(4)(i)	Deleted	Issue 1, Amdt 12	ED Decision 2022/012/R
AMC1 SPA.LVO.110	New	Issue 1, Amdt 12	ED Decision 2022/012/R
AMC2 SPA.LVO.110	New	Issue 1, Amdt 12	ED Decision 2022/012/R
AMC3 SPA.LVO.110	New	Issue 1, Amdt 12	ED Decision 2022/012/R
AMC4 SPA.LVO.110	New	Issue 1, Amdt 12	ED Decision 2022/012/R
GM1 SPA.LVO.110	New	Issue 1, Amdt 12	ED Decision 2022/012/R
GM2 SPA.LVO.110	New	Issue 1, Amdt 12	ED Decision 2022/012/R
GM3 SPA.LVO.110	New	Issue 1, Amdt 12	ED Decision 2022/012/R
GM4 SPA.LVO.110	New	Issue 1, Amdt 12	ED Decision 2022/012/R
GM5 SPA.LVO.110	New	Issue 1, Amdt 12	ED Decision 2022/012/R
GM6 SPA.LVO.110	New	Issue 1, Amdt 12	ED Decision 2022/012/R
GM7 SPA.LVO.110	New	Issue 1, Amdt 12	ED Decision 2022/012/R
GM8 SPA.LVO.110	New	Issue 1, Amdt 12	ED Decision 2022/012/R
GM9 SPA.LVO.110	New	Issue 1, Amdt 12	ED Decision 2022/012/R
GM10 SPA.LVO.110	New	Issue 1, Amdt 12	ED Decision 2022/012/R
GM11 SPA.LVO.110	New	Issue 1, Amdt 12	ED Decision 2022/012/R
GM12 SPA.LVO.110	New	Issue 1, Amdt 12	ED Decision 2022/012/R
AMC1 SPA.LVO.120	Deleted	Issue 1, Amdt 12	ED Decision 2022/012/R
GM1 SPA.LVO.120	Deleted	Issue 1, Amdt 12	ED Decision 2022/012/R
AMC1 SPA.LVO.120(a)	New	Issue 1, Amdt 12	ED Decision 2022/012/R
AMC2 SPA.LVO.120(a)	New	Issue 1, Amdt 12	ED Decision 2022/012/R
AMC3 SPA.LVO.120(a)	New	Issue 1, Amdt 12	ED Decision 2022/012/R

GM1 SPA.LVO.120(a)	New	Issue 1, Amdt 12	ED Decision 2022/012/R
AMC1 SPA.LVO.120(b)	New	Issue 1, Amdt 12	ED Decision 2022/012/R
AMC2 SPA.LVO.120(b)	New	Issue 1, Amdt 12	ED Decision 2022/012/R
AMC3 SPA.LVO.120(b)	New	Issue 1, Amdt 12	ED Decision 2022/012/R
AMC4 SPA.LVO.120(b)	New	Issue 1, Amdt 12	ED Decision 2022/012/R
AMC5 SPA.LVO.120(b)	New	Issue 1, Amdt 12	ED Decision 2022/012/R
AMC6 SPA.LVO.120(b)	New	Issue 1, Amdt 12	ED Decision 2022/012/R
AMC7 SPA.LVO.120(b)	New	Issue 1, Amdt 12	ED Decision 2022/012/R
GM1 SPA.LVO.120(b)	New	Issue 1, Amdt 12	ED Decision 2022/012/R
GM2 SPA.LVO.120(b)	New	Issue 1, Amdt 12	ED Decision 2022/012/R
GM3 SPA.LVO.120(b)	New	Issue 1, Amdt 12	ED Decision 2022/012/R
AMC1 SPA.LVO.125	Deleted	Issue 1, Amdt 12	ED Decision 2022/012/R
AMC1 SPA.NVIS.120	New	Issue 1, Amdt 12	ED Decision 2022/012/R
GM1 SPA.NVIS.120	New	Issue 1, Amdt 12	ED Decision 2022/012/R
AMC1 SPA.NVIS.130(f)	Changed	Issue 1, Amdt 12	ED Decision 2022/012/R
AMC2 SPA.NVIS.130(f)	New	Issue 1, Amdt 12	ED Decision 2022/012/R
AMC3 SPA.NVIS.130(f)	New	Issue 1, Amdt 12	ED Decision 2022/012/R
GM1 SPA.NVIS.130(f)	Changed	Issue 1, Amdt 12	ED Decision 2022/012/R
GM2 SPA.NVIS.130(f)	Changed	Issue 1, Amdt 12	ED Decision 2022/012/R
GM3 SPA.NVIS.130(f)	Changed	Issue 1, Amdt 12	ED Decision 2022/012/R
GM4 SPA.NVIS.130(f)	Changed	Issue 1, Amdt 12	ED Decision 2022/012/R
GM5 SPA.NVIS.130(f)	New	Issue 1, Amdt 12	ED Decision 2022/012/R
GM1 SPA.NVIS.140	Changed	Issue 1, Amdt 12	ED Decision 2022/012/R
AMC1 SPA.HOFO.120	Changed	Issue 1, Amdt 12	ED Decision 2022/012/R
AMC1 SPA.HOFO.125	Changed	Issue 1, Amdt 12	ED Decision 2022/012/R
AMC2 SPA.HOFO.125	New	Issue 1, Amdt 12	ED Decision 2022/012/R
AMC1 SPA.HOFO.125(g)	New	Issue 1, Amdt 12	ED Decision 2022/012/R
GM1 SPA.HOFO.125	Changed	Issue 1, Amdt 12	ED Decision 2022/012/R
GM2 SPA.HOFO.125	Changed	Issue 1, Amdt 12	ED Decision 2022/012/R
AMC1 SPA.PINS-VFR.100	New	Issue 1, Amdt 12	ED Decision 2022/012/R
Annex VI (Part-NCC)			
GM1 NCC.OP.101	New	Issue 1, Amdt 16	ED Decision 2022/012/R
AMC3 NCC.OP.110	Changed	Issue 1, Amdt 16	ED Decision 2022/012/R
AMC4 NCC.OP.110	Changed	Issue 1, Amdt 16	ED Decision 2022/012/R
AMC5 NCC.OP.110	Changed	Issue 1, Amdt 16	ED Decision 2022/012/R
AMC6 NCC.OP.110	Changed	Issue 1, Amdt 16	ED Decision 2022/012/R
AMC8 NCC.OP.110	Changed	Issue 1, Amdt 16	ED Decision 2022/012/R
AMC9 NCC.OP.110	Changed	Issue 1, Amdt 16	ED Decision 2022/012/R
GM1 NCC.OP.110	Changed	Issue 1, Amdt 16	ED Decision 2022/012/R
GM4 NCC.OP.110	New	Issue 1, Amdt 16	ED Decision 2022/012/R
GM5 NCC.OP.110	New	Issue 1, Amdt 16	ED Decision 2022/012/R
GM6 NCC.OP.110	New	Issue 1, Amdt 16	ED Decision 2022/012/R
GM7 NCC.OP.110	New	Issue 1, Amdt 16	ED Decision 2022/012/R

GM8 NCC.OP.110	New	Issue 1, Amdt 16	ED Decision 2022/012/R
GM9 NCC.OP.110	New	Issue 1, Amdt 16	ED Decision 2022/012/R
GM10 NCC.OP.110(b)(5)	New	Issue 1, Amdt 16	ED Decision 2022/012/R
AMC1 NCC.OP.111	Deleted	Issue 1, Amdt 16	ED Decision 2022/012/R
GM1 NCC.OP.112	Changed	Issue 1, Amdt 16	ED Decision 2022/012/R
AMC1 NCC.OP.115	New	Issue 1, Amdt 16	ED Decision 2022/012/R
AMC2 NCC.OP.116	Changed	Issue 1, Amdt 16	ED Decision 2022/012/R
AMC1 NCC.OP.153	Changed	Issue 1, Amdt 16	ED Decision 2022/012/R
GM2 NCC.OP.153	New	Issue 1, Amdt 16	ED Decision 2022/012/R
AMC1 NCC.OP.230(a)	Changed	Issue 1, Amdt 16	ED Decision 2022/012/R
GM1 NCC.OP.230	New	Issue 1, Amdt 16	ED Decision 2022/012/R
AMC1 NCC.OP.230(b)	New	Issue 1, Amdt 16	ED Decision 2022/012/R
AMC1 NCC.OP.230(c)	New	Issue 1, Amdt 16	ED Decision 2022/012/R
GM1 NCC.OP.230(f)	New	Issue 1, Amdt 16	ED Decision 2022/012/R
GM1 NCC.OP.235	New	Issue 1, Amdt 16	ED Decision 2022/012/R
AMC1 NCC.OP.235(a)(1)	New	Issue 1, Amdt 16	ED Decision 2022/012/R
AMC1 NCC.OP.235(a)(2)	New	Issue 1, Amdt 16	ED Decision 2022/012/R
AMC2 NCC.OP.235(a)(2)	New	Issue 1, Amdt 16	ED Decision 2022/012/R
AMC1 NCC.OP.235(a)(3)	New	Issue 1, Amdt 16	ED Decision 2022/012/R
AMC2 NCC.OP.235(a)(3)	New	Issue 1, Amdt 16	ED Decision 2022/012/R
AMC3 NCC.OP.235(a)(3)	New	Issue 1, Amdt 16	ED Decision 2022/012/R
AMC4 NCC.OP.235(a)(3)	New	Issue 1, Amdt 16	ED Decision 2022/012/R
AMC5 NCC.OP.235(a)(3)	New	Issue 1, Amdt 16	ED Decision 2022/012/R
GM1 NCC.OP.235(a)(3)	New	Issue 1, Amdt 16	ED Decision 2022/012/R
AMC1 NCC.OP.235(a)(4)	New	Issue 1, Amdt 16	ED Decision 2022/012/R
AMC1 NCC.OP.235(a)(8)	New	Issue 1, Amdt 16	ED Decision 2022/012/R
AMC1 NCC.OP.235(c)	New	Issue 1, Amdt 16	ED Decision 2022/012/R
GM1 NCC.OP.235(c)	New	Issue 1, Amdt 16	ED Decision 2022/012/R
AMC1 NCC.IDE.H.120(c)	New	Issue 1, Amdt 16	ED Decision 2022/012/R
GM1 NCC.IDE.H.120(c)	New	Issue 1, Amdt 16	ED Decision 2022/012/R
AMC1 NCC.IDE.H.125(c)	New	Issue 1, Amdt 16	ED Decision 2022/012/R
Annex VII (Part-NCO)			
AMC1 NCO.OP.101(a)	New	Issue 2, Amdt 13	ED Decision 2022/012/R
AMC1 NCO.OP.110	Changed	Issue 2, Amdt 13	ED Decision 2022/012/R
AMC2 NCO.OP.110	New	Issue 2, Amdt 13	ED Decision 2022/012/R
AMC3 NCO.OP.110	Changed	Issue 2, Amdt 13	ED Decision 2022/012/R
GM1 NCO.OP.110	Changed	Issue 2, Amdt 13	ED Decision 2022/012/R
GM2 NCO.OP.110	Changed	Issue 2, Amdt 13	ED Decision 2022/012/R
GM3 NCO.OP.110	Changed	Issue 2, Amdt 13	ED Decision 2022/012/R
GM4 NCO.OP.110	Changed	Issue 2, Amdt 13	ED Decision 2022/012/R
GM5 NCO.OP.110	Changed	Issue 2, Amdt 13	ED Decision 2022/012/R
GM7 NCO.OP.110	Deleted	Issue 2, Amdt 13	ED Decision 2022/012/R
GM8 NCO.OP.110	Deleted	Issue 2, Amdt 13	ED Decision 2022/012/R

GM1 NCO.OP.110(b)(5)	New	Issue 2, Amdt 13	ED Decision 2022/012/R
AMC1 NCO.OP.111	Changed	Issue 2, Amdt 13	ED Decision 2022/012/R
GM1 NCO.OP.111	New	Issue 2, Amdt 13	ED Decision 2022/012/R
GM2 NCO.OP.111	New	Issue 2, Amdt 13	ED Decision 2022/012/R
GM3 NCO.OP.111	New	Issue 2, Amdt 13	ED Decision 2022/012/R
GM1 NCO.OP.112	Changed	Issue 2, Amdt 13	ED Decision 2022/012/R
GM2 NCO.OP.112	New	Issue 2, Amdt 13	ED Decision 2022/012/R
AMC1 NCO.OP.115	New	Issue 2, Amdt 13	ED Decision 2022/012/R
AMC1 NCO.OP.142(b)(1)	New	Issue 2, Amdt 13	ED Decision 2022/012/R
AMC2 NCO.OP.142(b)(3)	New	Issue 2, Amdt 13	ED Decision 2022/012/R
GM1 NCO.OP.142	Deleted	Issue 2, Amdt 13	ED Decision 2022/012/R
GM1 NCO.OP.142(b)(4)	New	Issue 2, Amdt 13	ED Decision 2022/012/R
AMC1 NCO.OP.142(b)(5)	New	Issue 2, Amdt 13	ED Decision 2022/012/R
GM1 NCO.OP.143	New	Issue 2, Amdt 13	ED Decision 2022/012/R
GM1 NCO.OP.144	New	Issue 2, Amdt 13	ED Decision 2022/012/R
AMC1 NCO.OP.175	New	Issue 2, Amdt 13	ED Decision 2022/012/R
AMC1 NCO.OP.210	Changed	Issue 2, Amdt 13	ED Decision 2022/012/R
AMC2 NCO.OP.210	New	Issue 2, Amdt 13	ED Decision 2022/012/R
GM1 NCO.OP.210	New	Issue 2, Amdt 13	ED Decision 2022/012/R
AMC1 NCO.IDE.A.195(a)	New	Issue 2, Amdt 13	ED Decision 2022/012/R
GM1 NCO.IDE.A.195(a)	New	Issue 2, Amdt 13	ED Decision 2022/012/R
GM2 NCO.IDE.A.195(a)	New	Issue 2, Amdt 13	ED Decision 2022/012/R
GM3 NCO.IDE.A.195(a)	New	Issue 2, Amdt 13	ED Decision 2022/012/R
AMC1 NCO.IDE.A.195(b)	New	Issue 2, Amdt 13	ED Decision 2022/012/R
AMC1 NCO.IDE.H.195(a)	New	Issue 2, Amdt 13	ED Decision 2022/012/R
GM1 NCO.IDE.H.195(a)	New	Issue 2, Amdt 13	ED Decision 2022/012/R
GM2 NCO.IDE.H.195(a)	New	Issue 2, Amdt 13	ED Decision 2022/012/R
GM3 NCO.IDE.H.195(a)	New	Issue 2, Amdt 13	ED Decision 2022/012/R
AMC1 NCO.IDE.H.195(b)	New	Issue 2, Amdt 13	ED Decision 2022/012/R
AMC1 NCO.SPEC.115(a)	New	Issue 2, Amdt 13	ED Decision 2022/012/R
Annex VIII (Part-SPO)			
AMC1 SPO.GEN.105(a)	New	Issue 1, Amdt 16	ED Decision 2022/012/R
GM1 SPO.OP.101	New	Issue 1, Amdt 16	ED Decision 2022/012/R
AMC2 SPO.OP.110	Changed	Issue 1, Amdt 16	ED Decision 2022/012/R
AMC3 SPO.OP.110	Changed	Issue 1, Amdt 16	ED Decision 2022/012/R
AMC4 SPO.OP.110	Changed	Issue 1, Amdt 16	ED Decision 2022/012/R
AMC5 SPO.OP.110	Changed	Issue 1, Amdt 16	ED Decision 2022/012/R
AMC6 SPO.OP.110	Changed	Issue 1, Amdt 16	ED Decision 2022/012/R
AMC7 SPO.OP.110	Changed	Issue 1, Amdt 16	ED Decision 2022/012/R
AMC8 SPO.OP.110	Changed	Issue 1, Amdt 16	ED Decision 2022/012/R
AMC9 SPO.OP.110	Changed	Issue 1, Amdt 16	ED Decision 2022/012/R
AMC10 SPO.OP.110	Changed	Issue 1, Amdt 16	ED Decision 2022/012/R
GM1 SPO.OP.110	Changed	Issue 1, Amdt 16	ED Decision 2022/012/R

GM5 SPO.OP.110	New	Issue 1, Amdt 16	ED Decision 2022/012/R
GM6 SPO.OP.110	New	Issue 1, Amdt 16	ED Decision 2022/012/R
GM7 SPO.OP.110	New	Issue 1, Amdt 16	ED Decision 2022/012/R
GM8 SPO.OP.110	New	Issue 1, Amdt 16	ED Decision 2022/012/R
GM9 SPO.OP.110	New	Issue 1, Amdt 16	ED Decision 2022/012/R
GM10 SPO.OP.110	New	Issue 1, Amdt 16	ED Decision 2022/012/R
GM1 SPO.OP.110(b)(5)	New	Issue 1, Amdt 16	ED Decision 2022/012/R
GM1 SPO.OP.112	Changed	Issue 1, Amdt 16	ED Decision 2022/012/R
AMC1 SPO.OP.115	New	Issue 1, Amdt 16	ED Decision 2022/012/R
AMC1 SPO.OP.152	Changed	Issue 1, Amdt 16	ED Decision 2022/012/R
GM2 SPO.OP.152	New	Issue 1, Amdt 16	ED Decision 2022/012/R
AMC1 SPO.OP.215(a)	Changed	Issue 1, Amdt 16	ED Decision 2022/012/R
AMC1 SPO.OP.215(b)	New	Issue 1, Amdt 16	ED Decision 2022/012/R
GM1 SPO.OP.215	New	Issue 1, Amdt 16	ED Decision 2022/012/R
AMC1 SPO.OP.215(c)	New	Issue 1, Amdt 16	ED Decision 2022/012/R
GM1 SPO.OP.215(f)	New	Issue 1, Amdt 16	ED Decision 2022/012/R
AMC2 SPO.OP.230	Changed	Issue 1, Amdt 16	ED Decision 2022/012/R
GM1 SPO.OP.235	New	Issue 1, Amdt 16	ED Decision 2022/012/R
AMC1 SPO.OP.235(a)(1)	New	Issue 1, Amdt 16	ED Decision 2022/012/R
AMC1 SPO.OP.235(a)(2)	New	Issue 1, Amdt 16	ED Decision 2022/012/R
AMC2 SPO.OP.235(a)(2)	New	Issue 1, Amdt 16	ED Decision 2022/012/R
AMC1 SPO.OP.235(a)(3)	New	Issue 1, Amdt 16	ED Decision 2022/012/R
AMC2 SPO.OP.235(a)(3)	New	Issue 1, Amdt 16	ED Decision 2022/012/R
AMC3 SPO.OP.235(a)3)	New	Issue 1, Amdt 16	ED Decision 2022/012/R
AMC4 SPO.OP.235(a)(3)	New	Issue 1, Amdt 16	ED Decision 2022/012/R
AMC5 SPO.OP.235(a)(3)	New	Issue 1, Amdt 16	ED Decision 2022/012/R
GM1 SPO.OP.235(a)(3)	New	Issue 1, Amdt 16	ED Decision 2022/012/R
AMC1 SPO.OP.235(a)(4)	New	Issue 1, Amdt 16	ED Decision 2022/012/R
AMC1 SPO.OP.235(a)(8)	New	Issue 1, Amdt 16	ED Decision 2022/012/R
AMC1 SPO.OP.235(c)	New	Issue 1, Amdt 16	ED Decision 2022/012/R
GM1 SPO.OP.235(c)	New	Issue 1, Amdt 16	ED Decision 2022/012/R
AMC1 SPO.IDE.H.120(d)	New	Issue 1, Amdt 16	ED Decision 2022/012/R
GM1 SPO.IDE.H.120(d)	New	Issue 1, Amdt 16	ED Decision 2022/012/R
AMC1 SPO.IDE.H.125(c)	New	Issue 1, Amdt 16	ED Decision 2022/012/R

SUMMARY OF CHANGES — REVISION 18 (MAY 2022)

EASA Executive Director Decision 2022/005/R of 22 March 2022 issues:

- Amendment 15 to Issue 1 of the Guidance Material to Annex I (Definitions for terms used in Annexes II to VIII);
- Amendment 12 to Issue 3 of the Acceptable Means of Compliance and Guidance Material to Annex II (Part-ARO);
- Amendment 19 to Issue 2 of the Acceptable Means of Compliance and Guidance Material to Annex III (Part-ORO);
- Amendment 20 to Issue 2 of the Acceptable Means of Compliance and Guidance Material to Annex IV (Part-CAT);
- Amendment 11 to Issue 1 of the Acceptable Means of Compliance and Guidance Material to Annex V (Part-SPA);
- Amendment 15 to Issue 1 of the Acceptable Means of Compliance and Guidance Material to Annex VI (Part-NCC);
- Amendment 12 to Issue 2 of the Acceptable Means of Compliance and Guidance Material to Annex VII (Part-NCO); and
- Amendment 15 to Issue 1 of the Acceptable Means of Compliance and Guidance Material to Annex VIII (Part-SPO)

to **Regulation (EU) No 965/2012** to facilitate the implementation of the new requirements on fuel/energy planning and management, particularly those regarding the development and oversight of the air operators' fuel schemes, introduced into Regulation (EU) No 965/2012 (the 'Air OPS Regulation') by Commission Implementing Regulation (EU) 2021/1296. The new AMC and GM on fuel schemes, which consider the robustness of the operators' management system and are structured around three levels of performance, allowing operators to increase operational efficiency, with both cost-efficiency and environmental benefits, shall become **applicable from 30 October 2022**.

Date of publication of ED Decision 2022/005/R in the Official Publication of EASA: 25 March 2022.

Date of entry into force of ED Decision 2022/005/R: on the day following that of its publication in the Official Publication of EASA: 26 March 2022

REVISION TABLE (IRs) AIR OPS RULES AMENDED BY ED DECISION 2022/005/R

Part, subpart, article, rule	Action	EDD Issue/ Amdt. no	Amended by Commission Regulation
Annex I (Definitions)			
GM2 Annex I	Changed	Issue 1, Amdt 15	ED Decision 2022/005/R
GM28 Annex I	New	Issue 1, Amdt 15	ED Decision 2022/005/R
GM29 Annex I	New	Issue 1, Amdt 15	ED Decision 2022/005/R
GM30 Annex I	New	Issue 1, Amdt 15	ED Decision 2022/005/R

Annex II (Part-ARO)			
AMC1 ARO.OPS.225	New	Issue 3, Amdt 12	ED Decision 2022/005/R
GM1 ARO.OPS.225	Changed	Issue 3, Amdt 12	ED Decision 2022/005/R
GM2 ARO.OPS.225	New	Issue 3, Amdt 12	ED Decision 2022/005/R
AMC1 ARO.OPS.225(c)	New	Issue 3, Amdt 12	ED Decision 2022/005/R
AMC2 ARO.OPS.225(c)	New	Issue 3, Amdt 12	ED Decision 2022/005/R
GM1 ARO.OPS.225(c)	New	Issue 3, Amdt 12	ED Decision 2022/005/R
Annex III (Part-ORO)			
GM1 ORO.GEN.110(c)	Changed	Issue 2, Amdt 19	ED Decision 2022/005/R
AMC1 ORO.GEN.110(c)&(e)	New	Issue 2, Amdt 19	ED Decision 2022/005/R
AMC2 ORO.GEN.110(f)	New	Issue 2, Amdt 19	ED Decision 2022/005/R
GM2 ORO.GEN.110(f)	New	Issue 2, Amdt 19	ED Decision 2022/005/R
GM1 ORO.GEN.130(b)	Changed	Issue 2, Amdt 19	ED Decision 2022/005/R
AMC3 ORO.MLR.100	Changed	Issue 2, Amdt 19	ED Decision 2022/005/R
Annex IV (Part-CAT)			
AMC1 CAT.GEN.MPA.180(a)(18)	New	Issue 2, Amdt 20	ED Decision 2022/005/R
GM1 CAT.GEN.MPA.180(a)(18)	New	Issue 2, Amdt 20	ED Decision 2022/005/R
GM2 CAT.GEN.MPA.180(a)(18)	New	Issue 2, Amdt 20	ED Decision 2022/005/R
GM3 CAT.GEN.MPA.180(a)(18)	New	Issue 2, Amdt 20	ED Decision 2022/005/R
GM1 CAT.OP.MPA.107	New	Issue 2, Amdt 20	ED Decision 2022/005/R
AMC1 CAT.OP.MPA.150(b)	Deleted	Issue 2, Amdt 20	ED Decision 2022/005/R
AMC2 CAT.OP.MPA.150(b)	Deleted	Issue 2, Amdt 20	ED Decision 2022/005/R
AMC3 CAT.OP.MPA.150(b)	Deleted	Issue 2, Amdt 20	ED Decision 2022/005/R
GM1 CAT.OP.MPA.150(b)	Deleted	Issue 2, Amdt 20	ED Decision 2022/005/R
GM1 CAT.OP.MPA.150(c)(3)(i)	Deleted	Issue 2, Amdt 20	ED Decision 2022/005/R
GM1 CAT.OP.MPA.150(c)(3)(ii)	Deleted	Issue 2, Amdt 20	ED Decision 2022/005/R
AMC1 CAT.OP.MPA.175(a)	Changed	Issue 2, Amdt 20	ED Decision 2022/005/R
AMC1 CAT.OP.MPA.177	New	Issue 2, Amdt 20	ED Decision 2022/005/R
AMC1 CAT.OP.MPA.180	New	Issue 2, Amdt 20	ED Decision 2022/005/R
GM1 CAT.OP.MPA.180	New	Issue 2, Amdt 20	ED Decision 2022/005/R
GM2 CAT.OP.MPA.180	New	Issue 2, Amdt 20	ED Decision 2022/005/R
GM3 CAT.OP.MPA.180	New	Issue 2, Amdt 20	ED Decision 2022/005/R
AMC1 CAT.OP.MPA.181	New	Issue 2, Amdt 20	ED Decision 2022/005/R
AMC2 CAT.OP.MPA.181	New	Issue 2, Amdt 20	ED Decision 2022/005/R
AMC3 CAT.OP.MPA.181	New	Issue 2, Amdt 20	ED Decision 2022/005/R
AMC4 CAT.OP.MPA.181	New	Issue 2, Amdt 20	ED Decision 2022/005/R
AMC5 CAT.OP.MPA.181	New	Issue 2, Amdt 20	ED Decision 2022/005/R
AMC6 CAT.OP.MPA.181	New	Issue 2, Amdt 20	ED Decision 2022/005/R
AMC7 CAT.OP.MPA.181	New	Issue 2, Amdt 20	ED Decision 2022/005/R
AMC8 CAT.OP.MPA.181	New	Issue 2, Amdt 20	ED Decision 2022/005/R
GM1 CAT.OP.MPA.181	Deleted	Issue 2, Amdt 20	ED Decision 2022/005/R
GM1 CAT.OP.MPA.181	New	Issue 2, Amdt 20	ED Decision 2022/005/R
GM2 CAT.OP.MPA.181	New	Issue 2, Amdt 20	ED Decision 2022/005/R

GM3 CAT.OP.MPA.181	New	Issue 2, Amdt 20	ED Decision 2022/005/R
GM4 CAT.OP.MPA.181	New	Issue 2, Amdt 20	ED Decision 2022/005/R
AMC1 CAT.OP.MPA.182	Changed	Issue 2, Amdt 20	ED Decision 2022/005/R
AMC2 CAT.OP.MPA.182	New	Issue 2, Amdt 20	ED Decision 2022/005/R
AMC3 CAT.OP.MPA.182	New	Issue 2, Amdt 20	ED Decision 2022/005/R
AMC4 CAT.OP.MPA.182	New	Issue 2, Amdt 20	ED Decision 2022/005/R
AMC5 CAT.OP.MPA.182	New	Issue 2, Amdt 20	ED Decision 2022/005/R
AMC6 CAT.OP.MPA.182	New	Issue 2, Amdt 20	ED Decision 2022/005/R
AMC7 CAT.OP.MPA.182	New	Issue 2, Amdt 20	ED Decision 2022/005/R
AMC8 CAT.OP.MPA.182	New	Issue 2, Amdt 20	ED Decision 2022/005/R
AMC9 CAT.OP.MPA.182	New	Issue 2, Amdt 20	ED Decision 2022/005/R
GM1 CAT.OP.MPA.182	New	Issue 2, Amdt 20	ED Decision 2022/005/R
GM2 CAT.OP.MPA.182	Changed	Issue 2, Amdt 20	ED Decision 2022/005/R
GM3 CAT.OP.MPA.182	New	Issue 2, Amdt 20	ED Decision 2022/005/R
GM4 CAT.OP.MPA.182	New	Issue 2, Amdt 20	ED Decision 2022/005/R
GM1 CAT.OP.MPA.182(d)(1)	New	Issue 2, Amdt 20	ED Decision 2022/005/R
AMC1 CAT.OP.MPA.182(f)	New	Issue 2, Amdt 20	ED Decision 2022/005/R
GM1 CAT.OP.MPA.182(f)	New	Issue 2, Amdt 20	ED Decision 2022/005/R
GM1 CAT.OP.MPA.185	New	Issue 2, Amdt 20	ED Decision 2022/005/R
AMC1 CAT.OP.MPA.185(a)	New	Issue 2, Amdt 20	ED Decision 2022/005/R
AMC2 CAT.OP.MPA.185(a)	New	Issue 2, Amdt 20	ED Decision 2022/005/R
AMC3 CAT.OP.MPA.185(a)	New	Issue 2, Amdt 20	ED Decision 2022/005/R
GM2 CAT.OP.MPA.185	Deleted	Issue 2, Amdt 20	ED Decision 2022/005/R
GM1 CAT.OP.MPA.186	Deleted	Issue 2, Amdt 20	ED Decision 2022/005/R
AMC1 CAT.OP.MPA.190	Deleted	Issue 2, Amdt 20	ED Decision 2022/005/R
AMC1 CAT.OP.MPA.191(b)&(c)	New	Issue 2, Amdt 20	ED Decision 2022/005/R
AMC1 CAT.OP.MPA.192	New	Issue 2, Amdt 20	ED Decision 2022/005/R
AMC1 CAT.OP.MPA.192(a)	New	Issue 2, Amdt 20	ED Decision 2022/005/R
GM1 CAT.OP.MPA.192(c)&(d)	New	Issue 2, Amdt 20	ED Decision 2022/005/R
GM2 CAT.OP.MPA.192(c)&(d)	New	Issue 2, Amdt 20	ED Decision 2022/005/R
AMC1 CAT.OP.MPA.192(d)	New	Issue 2, Amdt 20	ED Decision 2022/005/R
GM1 CAT.OP.MPA.192(d)	New	Issue 2, Amdt 20	ED Decision 2022/005/R
AMC1 CAT.OP.MPA.195	Deleted	Issue 2, Amdt 20	ED Decision 2022/005/R
AMC1 CAT.OP.MPA.195	New	Issue 2, Amdt 20	ED Decision 2022/005/R
GM1 CAT.OP.MPA.195	New	Issue 2, Amdt 20	ED Decision 2022/005/R
AMC1 CAT.OP.MPA.200	New	Issue 2, Amdt 20	ED Decision 2022/005/R
AMC2 CAT.OP.MPA.200	New	Issue 2, Amdt 20	ED Decision 2022/005/R
AMC3 CAT.OP.MPA.200	New	Issue 2, Amdt 20	ED Decision 2022/005/R
AMC4 CAT.OP.MPA.200	New	Issue 2, Amdt 20	ED Decision 2022/005/R
GM1 CAT.OP.MPA.200	New	Issue 2, Amdt 20	ED Decision 2022/005/R
GM2 CAT.OP.MPA.200	New	Issue 2, Amdt 20	ED Decision 2022/005/R
AMC5 CAT.OP.MPA.200	New	Issue 2, Amdt 20	ED Decision 2022/005/R
AMC6 CAT.OP.MPA.200	New	Issue 2, Amdt 20	ED Decision 2022/005/R

AMC7 CAT.OP.MPA.200	New	Issue 2, Amdt 20	ED Decision 2022/005/R
AMC8 CAT.OP.MPA.200	New	Issue 2, Amdt 20	ED Decision 2022/005/R
GM3 CAT.OP.MPA.200	New	Issue 2, Amdt 20	ED Decision 2022/005/R
AMC1 CAT.OP.MPA.281	Deleted	Issue 2, Amdt 20	ED Decision 2022/005/R
GM1 CAT.POL.H.215(b)(3)	Changed	Issue 2, Amdt 20	ED Decision 2022/005/R
Annex V (Part-SPA)			
AMC1 SPA.HOFO.110(a)(4)	New	Issue 1, Amdt 11	ED Decision 2022/005/R
AMC1 SPA.HOFO.120	Changed	Issue 1, Amdt 11	ED Decision 2022/005/R
Annex VI (Part-NCC)			
AMC1 NCC.GEN.140(a)(17)	New	Issue 1, Amdt 15	ED Decision 2022/005/R
GM1 NCC.GEN.140(a)(17)	New	Issue 1, Amdt 15	ED Decision 2022/005/R
GM2 NCC.GEN.140(a)(17)	New	Issue 1, Amdt 15	ED Decision 2022/005/R
GM3 NCC.GEN.140(a)(17)	New	Issue 1, Amdt 15	ED Decision 2022/005/R
GM1 NCC.OP.105	New	Issue 1, Amdt 15	ED Decision 2022/005/R
AMC1 NCC.OP.131	New	Issue 1, Amdt 15	ED Decision 2022/005/R
AMC1 NCC.OP.155	Changed	Issue 1, Amdt 15	ED Decision 2022/005/R
AMC2 NCC.OP.155	New	Issue 1, Amdt 15	ED Decision 2022/005/R
AMC1 NCC.OP.157	New	Issue 1, Amdt 15	ED Decision 2022/005/R
AMC2 NCC.OP.157	New	Issue 1, Amdt 15	ED Decision 2022/005/R
GM1 NCC.OP.157	New	Issue 1, Amdt 15	ED Decision 2022/005/R
GM1 NCC.OP.205(b)&(d)	New	Issue 1, Amdt 15	ED Decision 2022/005/R
GM1 NCC.OP.205(c)	New	Issue 1, Amdt 15	ED Decision 2022/005/R
Annex VII (Part-NCO)			
AMC1 NCO.GEN.105(c)	Deleted	Issue 2, Amdt 12	ED Decision 2022/005/R
AMC1 NCO.GEN.105(a)(3)	New	Issue 2, Amdt 12	ED Decision 2022/005/R
GM1 NCO.OP.105	New	Issue 2, Amdt 12	ED Decision 2022/005/R
AMC1 NCO.OP.125(b)	New	Issue 2, Amdt 12	ED Decision 2022/005/R
AMC2 NCO.OP.125(b)	New	Issue 2, Amdt 12	ED Decision 2022/005/R
AMC3 NCO.OP.125(b)	New	Issue 2, Amdt 12	ED Decision 2022/005/R
GM1 NCO.OP.125(b)	New	Issue 2, Amdt 12	ED Decision 2022/005/R
GM2 NCO.OP.125(b)	New	Issue 2, Amdt 12	ED Decision 2022/005/R
AMC1 NCO.OP.147	New	Issue 2, Amdt 12	ED Decision 2022/005/R
GM1 NCO.OP.147	New	Issue 2, Amdt 12	ED Decision 2022/005/R
GM1 NCO.OP.185(b)&(c)	New	Issue 2, Amdt 12	ED Decision 2022/005/R
Annex VIII (Part-SPO)			
AMC1 SPO.GEN.140(a)(18)	New	Issue 1, Amdt 15	ED Decision 2022/005/R
GM1 SPO.GEN.140(a)(18)	New	Issue 1, Amdt 15	ED Decision 2022/005/R
GM2 SPO.GEN.140(a)(18)	New	Issue 1, Amdt 15	ED Decision 2022/005/R
GM3 SPO.GEN.140(a)(18)	New	Issue 1, Amdt 15	ED Decision 2022/005/R
GM1 SPO.OP.105	New	Issue 1, Amdt 15	ED Decision 2022/005/R
AMC1 SPO.OP.131	New	Issue 1, Amdt 15	ED Decision 2022/005/R
AMC1 SPO.OP.155	Changed	Issue 1, Amdt 15	ED Decision 2022/005/R
AMC2 SPO.OP.155	New	Issue 1, Amdt 15	ED Decision 2022/005/R

AMC1 SPO.OP.157	New	Issue 1, Amdt 15	ED Decision 2022/005/R
AMC2 SPO.OP.157	New	Issue 1, Amdt 15	ED Decision 2022/005/R
GM1 SPO.OP.157	New	Issue 1, Amdt 15	ED Decision 2022/005/R
GM1 SPO.OP.190(b)&(d)	New	Issue 1, Amdt 15	ED Decision 2022/005/R
GM1 SPO.OP.190(c)	New	Issue 1, Amdt 15	ED Decision 2022/005/R
AMC1 SPO.GEN.140(a)(18)	New	Issue 1, Amdt 15	ED Decision 2022/005/R
GM1 SPO.GEN.140(a)(18)	New	Issue 1, Amdt 15	ED Decision 2022/005/R
GM2 SPO.GEN.140(a)(18)	New	Issue 1, Amdt 15	ED Decision 2022/005/R

SUMMARY OF CHANGES – REVISION 17 (FEBRUARY 2022)

1. Commission Implementing Regulation (EU) 2021/2237 of 15 December 2021 amending Regulation (EU) No 965/2012 as regards the requirements for all-weather operations and for flight crew training and checking

amends:

- Article 5(2), point (a)(iv) of,
- Annex I (Definitions),
- Annex II (Part-ARO),
- Annex III (Part-ORO),
- Annex IV (Part-CAT),
- Annex V (Part-SPA),
- Annex VI (Part-NCC),
- Annex VII (Part-NCO), and
- Annex VIII (Part-SPO) to,

Regulation (EU) No 965/2012 to reflect recent technological advancements in new airborne systems and best practices in the domain of air operations, allow for a level playing field for all actors in the EU market, improve safety in a cost-effective way, and seek the use of innovative training tools. The amendments shall become **applicable from 30 October 2022**.

Date of publication in the Official Journal: 16 December 2021.

Date of entry into force of Regulation (EU) 2021/2237: on the twentieth day following that of its publication in the Official Journal of the European Union: 5 January 2022

2. Revision 17 also corrects the following errors identified in Revision 16:

- in the tables of **AMC4 ORO.FC.232 EBT programme assessment and training topics** and **AMC6 ORO.FC.232 EBT programme assessment and training topics**, the width of some cells was adjusted to allow all content to be visible;
- in **AMC1 CAT.IDE.A.225 Emergency medical kit**, point b(1)(v) was removed, as per **ED Decision 2021/005/R** amending **ED Decision 2014/015/R**; and
- in point **SPO.POL.146 Performance and operating criteria – helicopters**, the erroneously amended point (a)(1) was restored to its correct version, which was introduced by **Commission Regulation (EU) No 379/2014** amending **Commission Regulation (EU) No 965/2012**.

REVISION TABLE (IRs)

AIR OPS RULES AMENDED BY IMPLEMENTING REGULATION (EU) 2021/2237

Part, subpart, article, rule	Action	EDD Issue/ Amdt. no	Amended by Commission Regulation
Cover regulation			
Article 5(2)	Changed	N/a	Regulation (EU) 2021/2237
Annex I (Definitions)			
Annex I (Definitions)	Changed	N/a	Regulation (EU) 2021/2237
Annex II (Part-ARO)			
Appendix II	Changed	N/a	Regulation (EU) 2021/2237
Annex III (Part-ORO)			
ORO.FC.100	Changed	N/a	Regulation (EU) 2021/2237
ORO.FC.105	Changed	N/a	Regulation (EU) 2021/2237
ORO.FC.125	Changed	N/a	Regulation (EU) 2021/2237
ORO.FC.130	Changed	N/a	Regulation (EU) 2021/2237
ORO.FC.140	Changed	N/a	Regulation (EU) 2021/2237
ORO.FC.145	Changed	N/a	Regulation (EU) 2021/2237
ORO.FC.146	Changed	N/a	Regulation (EU) 2021/2237
ORO.FC.200	Changed	N/a	Regulation (EU) 2021/2237
ORO.FC.202	Changed	N/a	Regulation (EU) 2021/2237
ORO.FC.220	Changed	N/a	Regulation (EU) 2021/2237
ORO.FC.230	Changed	N/a	Regulation (EU) 2021/2237
ORO.FC.235	Changed	N/a	Regulation (EU) 2021/2237
ORO.FC.236	New	N/a	Regulation (EU) 2021/2237
ORO.FC.240	Changed	N/a	Regulation (EU) 2021/2237
ORO.FC.A.245	Changed	N/a	Regulation (EU) 2021/2237
ORO.FC.H.250	Changed	N/a	Regulation (EU) 2021/2237
ORO.FC.320	New	N/a	Regulation (EU) 2021/2237
ORO.FC.325	New	N/a	Regulation (EU) 2021/2237
ORO.FC.330	Changed	N/a	Regulation (EU) 2021/2237
Appendix I	Changed	N/a	Regulation (EU) 2021/2237
Annex IV (Part-CAT)			
CAT.GEN.MPA.100	Changed	N/a	Regulation (EU) 2021/2237
CAT.OP.MPA.101	New	N/a	Regulation (EU) 2021/2237
CAT.OP.MPA.107	Changed	N/a	Regulation (EU) 2021/2237
CAT.OP.MPA.110	Changed	N/a	Regulation (EU) 2021/2237
CAT.OP.MPA.115	Changed	N/a	Regulation (EU) 2021/2237
CAT.OP.MPA.245	Changed	N/a	Regulation (EU) 2021/2237
CAT.OP.MPA.246	Changed	N/a	Regulation (EU) 2021/2237
CAT.OP.MPA.247	Changed	N/a	Regulation (EU) 2021/2237
CAT.OP.MPA.265	Changed	N/a	Regulation (EU) 2021/2237

CAT.OP.MPA.300	Changed	N/a	Regulation (EU) 2021/2237
CAT.OP.MPA.305	Changed	N/a	Regulation (EU) 2021/2237
CAT.OP.MPA.310	Changed	N/a	Regulation (EU) 2021/2237
CAT.OP.MPA.312	New	N/a	Regulation (EU) 2021/2237
Annex V (Part-SPA)			
Subpart E title	Changed	N/a	Regulation (EU) 2021/2237
SPA.LVO.100	Changed	N/a	Regulation (EU) 2021/2237
SPA.LVO.105	Changed	N/a	Regulation (EU) 2021/2237
SPA.LVO.110	Changed	N/a	Regulation (EU) 2021/2237
SPA.LVO.115	Deleted		
SPA.LVO.120	Changed	N/a	Regulation (EU) 2021/2237
SPA.NVIS.120	Changed	N/a	Regulation (EU) 2021/2237
SPA.HOFO.120	Changed	N/a	Regulation (EU) 2021/2237
SPA.HOFO.125	Changed	N/a	Regulation (EU) 2021/2237
Subpart N	New	N/a	Regulation (EU) 2021/2237
SPA.PINS-VFR.100	New	N/a	Regulation (EU) 2021/2237
Annex VI (Part-NCC)			
NCC.OP.101	New	N/a	Regulation (EU) 2021/2237
NCC.OP.110	Changed	N/a	Regulation (EU) 2021/2237
NCC.OP.111	Deleted	N/a	Regulation (EU) 2021/2237
NCC.OP.112	Changed	N/a	Regulation (EU) 2021/2237
NCC.OP.145	Changed	N/a	Regulation (EU) 2021/2237
NCC.OP.147	New	N/a	Regulation (EU) 2021/2237
NCC.OP.148	New	N/a	Regulation (EU) 2021/2237
NCC.OP.150	Changed	N/a	Regulation (EU) 2021/2237
NCC.OP.180	Changed	N/a	Regulation (EU) 2021/2237
NCC.OP.195	Changed	N/a	Regulation (EU) 2021/2237
NCC.OP.225	Changed	N/a	Regulation (EU) 2021/2237
NCC.OP.230	Changed	N/a	Regulation (EU) 2021/2237
NCC.OP.235	New	N/a	Regulation (EU) 2021/2237
Annex VII (Part-NCO)			
NCO.OP.101	New	N/a	Regulation (EU) 2021/2237
NCO.OP.105	Deleted	N/a	Regulation (EU) 2021/2237
NCO.OP.110	Changed	N/a	Regulation (EU) 2021/2237
NCO.OP.111	Changed	N/a	Regulation (EU) 2021/2237
NCO.OP.112	Changed	N/a	Regulation (EU) 2021/2237
NCO.OP.135	Changed	N/a	Regulation (EU) 2021/2237
NCO.OP.140	Changed	N/a	Regulation (EU) 2021/2237
NCO.OP.141	Changed	N/a	Regulation (EU) 2021/2237

NCO.OP.142	Changed	N/a	Regulation (EU) 2021/2237
NCO.OP.143	New	N/a	Regulation (EU) 2021/2237
NCO.OP.144	New	N/a	Regulation (EU) 2021/2237
NCO.OP.160	Changed	N/a	Regulation (EU) 2021/2237
NCO.OP.175	Changed	N/a	Regulation (EU) 2021/2237
NCO.OP.205	Changed	N/a	Regulation (EU) 2021/2237
NCO.OP.206	Changed	N/a	Regulation (EU) 2021/2237
NCO.OP.210	Changed	N/a	Regulation (EU) 2021/2237
Annex VIII (Part-SPO)			
SPO.OP.101	New	N/a	Regulation (EU) 2021/2237
SPO.OP.110	Changed	N/a	Regulation (EU) 2021/2237
SPO.OP.111	Deleted	N/a	Regulation (EU) 2021/2237
SPO.OP.112	Changed	N/a	Regulation (EU) 2021/2237
SPO.OP.140	Changed	N/a	Regulation (EU) 2021/2237
SPO.OP.143	New	N/a	Regulation (EU) 2021/2237
SPO.OP.144	New	N/a	Regulation (EU) 2021/2237
SPO.OP.145	Changed	N/a	Regulation (EU) 2021/2237
SPO.OP.170	Changed	N/a	Regulation (EU) 2021/2237
SPO.OP.180	Changed	N/a	Regulation (EU) 2021/2237
SPO.OP.210	Changed	N/a	Regulation (EU) 2021/2237
SPO.OP.215	Changed	N/a	Regulation (EU) 2021/2237
SPO.OP.235	New	N/a	Regulation (EU) 2021/2237

SUMMARY OF CHANGES – REVISION 16 (DECEMBER 2021)

Commission Implementing Regulation (EU) 2021/1296 of 4 August 2021 amending and correcting Regulation (EU) No 965/2012 as regards the requirements for fuel/energy planning and management, and as regards requirements on support programmes and psychological assessment of flight crew, as well as testing of psychoactive substances

amends the second paragraph of Article 9b of **Regulation (EU) No 965/2012** by deferring the applicability date of EASA’s obligation to produce a first report on the results of its review of the effectiveness of the provisions concerning support programmes, as well as the psychological assessment of flight crew and the systematic and random testing of psychoactive substances to ensure the medical fitness of flight crew and cabin crew members set out in Annex II (Part-ARO) and Annex IV (Part-CAT) to **Regulation (EU) No 965/2012**.

In this regard, **Regulation (EU) 2021/1296** reintroduces into Annex I (Definitions) to **Regulation (EU) No 965/2012** definition 98(a) that defined the term ‘psychoactive substances’. That definition is essential for the consistent interpretation of the provisions introduced by **Regulation (EU) 2018/1042** and for clearly defining which substances are subject to those provisions and which are not. Therefore, to safeguard legitimate expectations of the persons subject to those provisions, that definition was reintroduced with effect from the applicability date (**14 February 2021**) of the related changes introduced by **Regulation (EU) 2018/1042**.

The amendments introduced by **Regulation (EU) 2021/1296** to the Cover Regulation and Annexes I-VII to **Regulation (EU) No 965/2012** regarding the requirements for fuel/energy planning and management shall apply from **30 October 2022**.

Date of publication in the Official Journal: 5 August 2021.

Date of entry into force of Regulation (EU) 2021/1296: on the twentieth day following that of its publication in the Official Journal of the European Union: 25 August 2021

REVISION TABLE (IRs)

AIR OPS RULES AMENDED BY IMPLEMENTING REGULATION (EU) 2021/1296

Part, subpart, article, rule	Action	EDD Issue/ Amdt. no	Amended by Commission Regulation
Cover regulation			
Article 9b	Changed	N/a	Regulation (EU) 2021/1296
Annex I (Definitions)			
Annex I (Definitions)	Changed	N/a	Regulation (EU) 2021/1296
Annex II (Part-ARO)			
ARO.OPS.225	Changed	N/a	Regulation (EU) 2021/1296
Annex III (Part-ORO)			
Appendix I	Changed	N/a	Regulation (EU) 2021/1296
Annex IV (Part-CAT)			
CAT.OP.MPA.100 (b)(3)	Changed	N/a	Regulation (EU) 2021/1296

CAT.OP.MPA.106	Deleted	N/a	Regulation (EU) 2021/1296
CAT.OP.MPA.150	Changed	N/a	Regulation (EU) 2021/1296
CAT.OP.MPA.151	Deleted	N/a	Regulation (EU) 2021/1296
CAT.OP.MPA.175 (b)(7)	Changed	N/a	Regulation (EU) 2021/1296
CAT.OP.MPA.177	New	N/a	Regulation (EU) 2021/1296
CAT.OP.MPA.180	Changed	N/a	Regulation (EU) 2021/1296
CAT.OP.MPA.181	Changed	N/a	Regulation (EU) 2021/1296
CAT.OP.MPA.185	Changed	N/a	Regulation (EU) 2021/1296
CAT.OP.MPA.186	Deleted	N/a	Regulation (EU) 2021/1296
GM1 CAT.OP.MPA.186	To be deleted	N/a	As CAT.OP.MPA.186 is deleted
CAT.OP.MPA.190	Changed	N/a	Regulation (EU) 2021/1296
CAT.OP.MPA.191	New	N/a	Regulation (EU) 2021/1296
CAT.OP.MPA.192	New	N/a	Regulation (EU) 2021/1296
CAT.OP.MPA.195	Changed	N/a	Regulation (EU) 2021/1296
CAT.OP.MPA.200	Changed	N/a	Regulation (EU) 2021/1296
CAT.OP.MPA.245 (a)(1)	Changed	N/a	Regulation (EU) 2021/1296
CAT.OP.MPA.246 (a)	Changed	N/a	Regulation (EU) 2021/1296
CAT.OP.MPA.260	Changed	N/a	Regulation (EU) 2021/1296
CAT.OP.MPA.280	Changed	N/a	Regulation (EU) 2021/1296
CAT.OP.MPA.281	Deleted	N/a	Regulation (EU) 2021/1296
AMC1 CAT.OP.MPA.281	To be deleted	N/a	As CAT.OP.MPA.281 is deleted
CAT.POL.A.220 (f)	Changed	N/a	Regulation (EU) 2021/1296
CAT.POL.A.420 (d)	Changed	N/a	Regulation (EU) 2021/1296
CAT.IDE.A.195 (e)	Changed	N/a	Regulation (EU) 2021/1296
Annex V (Part-SPA)			
SPA.HEMS.150	Changed	N/a	Regulation (EU) 2021/1296
SPA.HEMS.155	Changed	N/a	Regulation (EU) 2021/1296
SPA.HOFO.120 (a)	Changed	N/a	Regulation (EU) 2021/1296
SPA.SET-IMC.110 (I)	Changed	N/a	Regulation (EU) 2021/1296
Annex VI (Part-NCC)			
NCC.OP.105	Changed	N/a	Regulation (EU) 2021/1296
NCC.OP.130	Changed	N/a	Regulation (EU) 2021/1296
NCC.OP.131	Changed	N/a	Regulation (EU) 2021/1296
NCC.OP.151 (b)	Changed	N/a	Regulation (EU) 2021/1296
NCC.OP.155 (b)	Changed	N/a	Regulation (EU) 2021/1296
NCC.OP.157	New	N/a	Regulation (EU) 2021/1296
NCC.OP.205	Changed	N/a	Regulation (EU) 2021/1296
NCC.POL.110 (a)(6)-(a)(9)	Changed	N/a	Regulation (EU) 2021/1296
Annex VII (Part-NCO)			
NCO.OP.105	Changed	N/a	Regulation (EU) 2021/1296
NCO.OP.125	Changed	N/a	Regulation (EU) 2021/1296

NCO.OP.126	Deleted	N/a	Regulation (EU) 2021/1296
NCO.OP.145 (b)	Changed	N/a	Regulation (EU) 2021/1296
NCO.OP.147	New	N/a	Regulation (EU) 2021/1296
NCO.OP.185	Changed	N/a	Regulation (EU) 2021/1296
NCO.SPEC.135	Deleted	N/a	Regulation (EU) 2021/1296
NCO.SPEC.140	Deleted	N/a	Regulation (EU) 2021/1296
Annex VIII (Part-SPO)			
SPO.OP.105	Changed	N/a	Regulation (EU) 2021/1296
SPO.OP.130	Changed	N/a	Regulation (EU) 2021/1296
SPO.OP.131	Changed	N/a	Regulation (EU) 2021/1296
SPO.OP.150 (b)	Changed	N/a	Regulation (EU) 2021/1296
SPO.OP.155 (b)	Changed	N/a	Regulation (EU) 2021/1296
SPO.OP.157	New	N/a	Regulation (EU) 2021/1296
SPO.OP.190	Changed	N/a	Regulation (EU) 2021/1296
SPO.POL.110	Changed	N/a	Regulation (EU) 2021/1296
SPO.POL.115 (a)(6)-(a)(9)	Changed	N/a	Regulation (EU) 2021/1296
SPO.IDE.H.146 (a)(1)	Changed	N/a	Regulation (EU) 2021/1296

SUMMARY OF CHANGES – REVISION 15 (JUNE 2021)

1. Commission Implementing Regulation (EU) 2020/745 of 4 June 2020 amending Regulation (EU) 2018/1042 as regards postponing dates of application of certain measures in the context of the COVID-19 pandemic

amends Article 2 of Regulation (EU) 2018/1042, the third paragraph, by deferring the date of application of points 1 and 3 of Article 1 of Reg. (EU) 2018/1042 from 14 August 2020 to 14 February 2021, with the exception of points 3(f) and 6(b) of the Annex to Reg. (EU) 2018/1042 (related to TAWS), which shall apply from 14 August 2018.

This means that the following points will become applicable as of 12 February 2021 instead of 14 August 2020:

- Article 4 ‘Ramp inspections’;
- Annex I (Definitions): Definitions 78a, 98a, 105a;
- Annex II (Part-ARO): ARO.RAMP.106;
- Annex IV (Part-CAT): CAT.GEN.MPA.100 point (c)(1); CAT.GEN.MPA.170; CAT.GEN.MPA.175; CAT.GEN.MPA.215; CAT.GEN.MPA.100 point (b)(1);
- Annex VI (Part-NCC): NCC.GEN.105 point (e)(2);
- Annex VII (Part-NCO): NCO.SPEC.115 point (e)(2);
- Annex VIII (Part-SPO): SPO.GEN.105 point (e)(2).

Article 1 point (2) of Reg. (EU) 2018/1042, which introduces changes to Article 9b ‘Review’ of Reg. (EU) No 965/2012, shall apply from 14 August 2020. It is not affected by the deferred date of application introduced by Reg. (EU) 2020/745.

Date of publication in the Official Journal: 5 June 2020.

Date of entry into force of Reg. (EU) 2020/745: on the day following that of its publication in the Official Journal of the EU.

2. Commission Implementing Regulation (EU) 2020/1176 of 7 August 2020 amending Implementing Regulation (EU) 2019/1387 as regards postponing dates of application of certain measures in the context of the COVID-19 pandemic

amends Article 2 of Reg. (EU) 2019/1387, the third paragraph, by deferring its date of application from 5 November 2020 to 12 August 2021.

This affects the amendments introduced by Reg. (EU) 2019/1387 related to the global reporting format for aeroplane performance in Annex IV (Part-CAT).

The following points of point (4) of the Annex to Reg. (EU) 2019/1387 shall apply from 12 August 2021 instead of 5 November 2020:

- point (c). This is CAT.OP.MPA.300;
- point (d). This is CAT.OP.MPA.301;
- point (e). This is CAT.OP.MPA.303;
- point (f). This is CAT.OP.MPA.311;
- point (g). This is CAT.POL.A.105 point (d);

- point (n). This is CAT.POL.A.255;
- point (q). This is CAT.POL.A.355.

Date of publication in the Official Journal: 10 August 2020.

Date of entry into force of Reg. (EU) 2020/1176: on the day following that of its publication in the Official Journal of the EU.

3. Commission Implementing Regulation (EU) 2020/2036 of 9 December 2020 amending Regulation (EU) No 965/2012 as regards the requirements for flight crew competence and training methods and postponing dates of application of certain measures in the context of the COVID-19 pandemic

This amendment aligns the EU rules with ICAO Doc 9995 ‘Manual of evidence-based training’ (EBT) and introduces requirements on the provision of training, checking and assessment of the EBT programme and to allow authorities to approve the baseline EBT, which replaces previous checks such as operator proficiency checks and licence proficiency checks.

The following Annexes are affected:

- Annex I – Definitions
- Annex II – Part-ARO
- Annex III – Part-ORO, Subpart ORO.FC.

This amendment also defers the date of application of the requirements that cockpit voice recorders (CVR) with a recording capability of 25 hours are installed and used as of 1 January 2021.

This means that the following points will be applicable from 1 January 2022 instead of 1 January 2021:

- CAT.IDE.A.185 (c)(1)
- NCC.IDE.A.160 (b)(1)
- SPO.IDE.A.140 (b)(1)

Date of publication in the Official Journal: 11 December 2020.

Date of entry into force of Reg. (EU) 2020/2036: on the twentieth day following that of its publication in the Official Journal of the EU.

4. EASA ED Decision 2019/025/R of 17 December 2019 amending ED Decision 2018/006/R of 3 May 2018 issuing the Certification Specifications for Aeroplane Flight Simulation Training Devices, as well as amending ED Decisions 2014/017/R of 24 April 2014 and 2019/005/R of 27 February 2019 on the Acceptable Means of Compliance and Guidance Material to Annex III (Part-ORO) to Commission Regulation (EU) No 965/2012

affects the following document in the air operations domain:

- AMC & GM to Part-ORO — Issue 2, Amendment 16

Date of publication in the EASA Official Publication: 16 December 2019

Date of entry into force of Decision 2019/025/R: 17 December 2019

Article 3 of this Decision (i.e. changes made to the AMC&GM to Part-ORO) become applicable from 20 August 2020.

5. EASA ED Decision 2020/013/R of 18 August 2020 amending ED Decision 2019/025/R amending ED Decision 2018/006/R of 3 May 2018 issuing the Certification Specifications for Aeroplane Flight Simulation Training Devices, as well as amending ED Decisions 2014/017/R of 24 April 2014 and 2019/005/R of 27 February 2019 on the Acceptable Means of Compliance and Guidance Material to Annex III (Part-ORO) to Commission Regulation (EU) No 965/2012

This Decision introduces an amendment to ED Decision 2019/025/R — AMC & GM to Part-ORO Issue 2, Amendment 16 ‘Deferment of the use of aeroplane flight simulation training devices (FSTDs) qualified against “CS-FSTD(A) Issue 2” in air operator upset prevention and recovery training (UPRT) in relation to the COVID-19 pandemic’

The Decision amends Article 4 of EDD 2019/025/R by deferring the application of changes made to AMC & GM to Part-ORO (specified in Article 3 of EDD 2019/025/R) from 20 August 2020 to 31 March 2021. This is related to the use of aeroplane flight simulation training devices (FSTDs) qualified against CS-FSTD(A) Issue 2 in air operator upset prevention and recovery training (UPRT).

The following AMC and GM are affected and will become applicable from 31 March 2020 instead of 20 August 2020:

- AMC1 ORO.FC.220&230 point (d);
- AMC2 ORO.FC.220&230 point (d);
- GM3 ORO.FC.220&230.

Date of publication in the EASA Official Publication: 18 August 2020

Date of entry into force of Decision 2020/013/R: 19 August 2020

Changes made to AMC&GM to Part-ORO become applicable from 31 March 2021.

6. EASA ED Decision 2021/002/R

This Decision is related to Reg. (EU) 2020/2036 on flight crew competence and training methods, which amends Regulation (EU) No 965/2012 on air operations. The AMC and GM will facilitate the implementation of the new requirements on evidence-based training.

(related Regulation in the aircrew domain: Commission Implementing Regulation (EU) 2020/2193 amending Reg. (EU) No 1178/2011)

The Decision and the related Regulations are parts of a global safety initiative endorsed by ICAO, whose objective is to determine the relevance of the existing pilot training according to aircraft generation. In particular, they constitute a second step in the context of European Union rulemaking actions to implement EBT. The first step was completed in 2015 with the publication of ED Decision 2015/027/R that provided guidance material to allow the implementation of a ‘mixed EBT’ which maintains the current operator proficiency check (OPC) and licence proficiency check (LPC). This Decision completes the second step initiated by the Regulations that amended Reg. (EU) No 965/2012 (Air OPS Regulation) and Reg. (EU) No 1178/2011 (Aircrew Regulation) to allow authorities to approve the baseline EBT, which replaces OPC and LPC. This will allow a single philosophy of recurrent training within the airline. EBT is intended to improve

safety by enhancing the capability of flight crews to operate the aircraft in all flight regimes by recognising and managing unexpected situations. The EBT concept is designed to maximise learning and minimise formal checking.

The following AMC and GM related to Reg. (EU) 2020/2036 which amends Reg. (EU) No 965/2012 are affected by this Decision:

- AMC and GM to Annex I Definitions (Issue 1, amendment 12)
- AMC and GM to Annex II (Part-ARO) (Issue 3, amendment 11)
- AMC and GM to Annex III (Part-ORO) (Issue 2, amendment 17)

For information, the following AMC and GM related to Reg. (EU) 2020/2193 which amends Reg. (EU) No 1178/2011 are affected by this Decision:

- AMC and GM to Annex I (Part-FCL) (Issue 1, amendment 11)
- AMC and GM to Annex VI (Part-ARA) (Issue 1, amendment 11)

Date of publication in the EASA Official Publication: 2 March 2021

Date of entry into force of Decision 2021/002/R: 3 March 2021

7. ED Decision 2021/005/R

Update of the Acceptable Means of Compliance and Guidance Material to Regulation (EU) No 965/2012 - Aeroplane performance, PBS, oxygen equipment, medical equipment, recorders, technical records, non-ETOPS operations, ground de-icing/anti-icing procedures

Following the adoption of Regulation (EU) 2019/1387, amending Regulation (EU) No 965/2012 (Air OPS Regulation), the objective of this Decision is to support the implementation of the requirements on:

- power supply to cockpit voice recorders (CVRs) in order to improve the availability of recordings;
- in-flight recording for light aircraft;
- commercial operation of certain categories of aeroplanes without an ETOPS approval;
- runway surface condition reporting and in-flight assessment of landing performance;
- reduced required landing distance for certain categories of commercially operated aeroplanes;
- operations in airspaces where performance-based communication and surveillance (PBCS) is implemented;
- new technical standards on first-aid oxygen dispensing units, medical equipment, de-icing/anti-icing ground
- procedures; and
- technical records.

This Decision amends as necessary the acceptable means of compliance and guidance material in relation to the above-listed topics.

The following Annexes are affected:

- ‘GM to Annex I (Definitions for terms used in Annexes II to VIII) — Issue 1, Amendment 13’
- ‘AMC & GM to Part-ORO — Issue 2, Amendment 18’
- ‘AMC & GM to Part-CAT — Issue 2, Amendment 18’
- ‘AMC & GM to Part-SPA — Issue 1, Amendment 9’
- ‘AMC & GM to Part-NCC — Initial issue, Amendment 13’
- ‘AMC & GM to Part-NCO — Issue 2, Amendment 10’
- ‘AMC & GM to Part-SPO — Initial issue, Amendment 13’

The following AMC and GM shall apply from 12 August 2021:

- CAT.OP.MPA.300
- CAT.OP.MPA.301
- CAT.OP.MPA.303
- CAT.OP.MPA.311
- CAT.POL.A.255
- CAT.POL.A.355

Date of publication in the EASA Official Publication: 23 April 2021

Date of entry into force of Decision 2021/005/R: 24 April 2021

8. ED Decision 2021/008/R

Amendment of requirements for flight recorders and underwater locating devices — Certification specifications, acceptable means of compliance, and guidance material for locating an aircraft in distress.

The objective of this Decision is to facilitate the implementation of point CAT.GEN.MPA.210 ‘Location of an aircraft in distress — Aeroplanes’ of Annex IV (Part-CAT) to Regulation (EU) No 965/2012 (‘Air OPS Regulation’).

This Decision amends certification specifications (CSs), acceptable means of compliance (AMC), and guidance material (GM), to support the implementation of point CAT.GEN.MPA.210. The scope of this Decision includes air operations (Air OPS), initial airworthiness (IAW), and air traffic management (ATM).

The amendments are expected to increase safety as they will facilitate locating an accident scene. This will increase the chances of rescuing accident survivors, and accelerate the collection of evidence that is necessary for determining the accident causes. In addition, these amendments are expected to ensure consistency with the existing requirements on flight recorders, emergency locator transmitters (ELTs), and low-frequency (8.8 kHz) underwater locating devices (ULDs).

Date of publication in the EASA Official Publication: 31 May 2021

Date of entry into force of Decision 2021/005/R: 1 June 2021

REVISION TABLE (IR, AMC, GM)

AIR OPS RULES AMENDED BY REG. (EU) 2020/745, (EU) 2020/2036 AND EDD 2021/002/R

Part, subpart, article, rule	Action	EDD Issue/ Amdt. no	Amended by Commission Regulation / EASA ED Decision
(1) Cover regulation			
Art. 4	Changed		Reg. EU 2020/745
Annex I (Definitions)			
Annex I (Definitions)	Changed		Reg. (EU) 2020/2036
GM2 Annex I	Changed	1/12	EDD 2019/025/R
GM19 Annex I	New	1/12	EDD 2019/025/R
Annex II (Part-ARO)			
ARO.OPS.226	New		Reg. (EU) 2020/2036
AMC1 ARO.OPS.226(a)	New	3/11	EDD 2021/002/R
GM1 ARO.OPS.226(a)	New	3/11	EDD 2021/002/R
GM2 ARO.OPS.226(a)	New	3/11	EDD 2021/002/R
AMC1 ARO.OPS.226(c)	New	3/11	EDD 2021/002/R
AMC2 ARO.OPS.226(c)	New	3/11	EDD 2021/002/R
AMC1 ARO.OPS.226(d)	New	3/11	EDD 2021/002/R
GM1 ARO.OPS.226(d)	New	3/11	EDD 2021/002/R
GM2 ARO.OPS.226(d)	New	3/11	EDD 2021/002/R
(2) Annex III (Part-ORO)			
GM1 ORO.GEN.130(b)	Changed	2/17	EDD 2021/002/R
AMC1 ORO.FC.115	Changed	2/17	EDD 2021/002/R
ORO.FC.145	Changed		Reg. (EU) 2020/2036
ORO.FC.146	New		Reg. (EU) 2020/2036
AMC1 ORO.FC.146(c)	New	2/17	EDD 2021/002/R
AMC2 ORO.FC.146(c)	New	2/17	EDD 2021/002/R
GM1 ORO.FC.146(c)	New	2/17	EDD 2021/002/R
GM2 ORO.FC.146(c)	New	2/17	EDD 2021/002/R
GM3 ORO.FC.146(c)	New	2/17	EDD 2021/002/R
AMC1 ORO.FC.220&230 point (d)	Changed	2/16	EDD 2019/025/R
AMC2 ORO.FC.220&230 point (d)	Changed	2/16	EDD 2019/025/R
GM3 ORO.FC.220&230 point (d)	Changed	2/16	EDD 2019/025/R
GM1 ORO.FC.230(a);(b);(f)	Changed	2/17	EDD 2021/002/R
ORO.FC.231	New		Reg. (EU) 2020/.2036
AMC1 ORO.FC.231(a)	New	2/17	EDD 2021/002/R
AMC2 ORO.FC.231(a)	New	2/17	EDD 2021/002/R

AMC3 ORO.FC.231(a)	New	2/17	EDD 2021/002/R
GM1 ORO.FC.231(a)	New	2/17	EDD 2021/002/R
GM2 ORO.FC.231(a)	New	2/17	EDD 2021/002/R
GM3 ORO.FC.231(a)	New	2/17	EDD 2021/002/R
GM4 ORO.FC.231(a)	New	2/17	EDD 2021/002/R
AMC1 ORO.FC.231(a)(1)	New	2/17	EDD 2021/002/R
AMC1 ORO.FC.231(a)(2)	New	2/17	EDD 2021/002/R
AMC2 ORO.FC.231(a)(2)	New	2/17	EDD 2021/002/R
GM1 ORO.FC.231(a)(2)	New	2/17	EDD 2021/002/R
GM2 ORO.FC.231(a)(2)	New	2/17	EDD 2021/002/R
GM3 ORO.FC.231(a)(2)	New	2/17	EDD 2021/002/R
AMC1 ORO.FC.231(a)(3)	New	2/17	EDD 2021/002/R
GM1 ORO.FC.231(a)(3)	New	2/17	EDD 2021/002/R
AMC1 ORO.FC.231(a)(4)	New	2/17	EDD 2021/002/R
GM1 ORO.FC.231(a)(4)	New	2/17	EDD 2021/002/R
AMC1 ORO.FC.231(a)(5)	New	2/17	EDD 2021/002/R
GM1 ORO.FC.231(a)(5)	New	2/17	EDD 2021/002/R
AMC1 ORO.FC.231(b)	New	2/17	EDD 2021/002/R
AMC2 ORO.FC.231(b)	New	2/17	EDD 2021/002/R
GM1 ORO.FC.231(b)	New	2/17	EDD 2021/002/R
AMC1 ORO.FC.231(c)	New	2/17	EDD 2021/002/R
AMC2 ORO.FC.231(c)	New	2/17	EDD 2021/002/R
GM1 ORO.FC.231(c)	New	2/17	EDD 2021/002/R
GM2 ORO.FC.231(c)	New	2/17	EDD 2021/002/R
AMC1 ORO.FC.231(d)(1)	New	2/17	EDD 2021/002/R
AMC2 ORO.FC.231(d)(1)	New	2/17	EDD 2021/002/R
AMC3 ORO.FC.231(d)(1)	New	2/17	EDD 2021/002/R
AMC4 ORO.FC.231(d)(1)	New	2/17	EDD 2021/002/R
GM1 ORO.FC.231(d)(1)	New	2/17	EDD 2021/002/R
GM2 ORO.FC.231(d)(1)	New	2/17	EDD 2021/002/R
AMC1 ORO.FC.231(d)(2)	New	2/17	EDD 2021/002/R
GM1 ORO.FC.231(d)(2)	New	2/17	EDD 2021/002/R
GM2 ORO.FC.231(d)(2)	New	2/17	EDD 2021/002/R
AMC1 ORO.FC.231(e)	New	2/17	EDD 2021/002/R
AMC1 ORO.FC.231(f)	New	2/17	EDD 2021/002/R
AMC1 ORO.FC.231(f)(3)	New	2/17	EDD 2021/002/R
GM1 ORO.FC.231(f)	New	2/17	EDD 2021/002/R
GM2 ORO.FC.231(f)	New	2/17	EDD 2021/002/R
GM3 ORO.FC.231(f)	New	2/17	EDD 2021/002/R
GM4 ORO.FC.231(f)	New	2/17	EDD 2021/002/R
AMC1 ORO.FC.231(g)	New	2/17	EDD 2021/002/R
AMC2 ORO.FC.231(g)	New	2/17	EDD 2021/002/R
GM1 ORO.FC.231(g)	New	2/17	EDD 2021/002/R

GM2 ORO.FC.231(g)	New	2/17	EDD 2021/002/R
AMC2 ORO.FC.231(h)	New	2/17	EDD 2021/002/R
AMC1 ORO.FC.231(h)(3)	New	2/17	EDD 2021/002/R
GM1 ORO.FC.231(h)	New	2/17	EDD 2021/002/R
GM1 ORO.FC.231(h)(4)	New	2/17	EDD 2021/002/R
AMC1 ORO.FC.231(i)	New	2/17	EDD 2021/002/R
GM1 ORO.FC.231(i)	New	2/17	EDD 2021/002/R
GM2 ORO.FC.231(i)	New	2/17	EDD 2021/002/R
ORO.FC.232	New		Reg. (EU) 2020/2036
AMC1 ORO.FC.232	New	2/17	EDD 2021/002/R
AMC2 ORO.FC.232	New	2/17	EDD 2021/002/R
AMC3 ORO.FC.232	New	2/17	EDD 2021/002/R
AMC4 ORO.FC.232	New	2/17	EDD 2021/002/R
AMC5 ORO.FC.232	New	2/17	EDD 2021/002/R
AMC6 ORO.FC.232	New	2/17	EDD 2021/002/R
AMC7 ORO.FC.232	New	2/17	EDD 2021/002/R
AMC8 ORO.FC.232	New	2/17	EDD 2021/002/R
GM1 ORO.FC.232	New	2/17	EDD 2021/002/R
GM2 ORO.FC.232	New	2/17	EDD 2021/002/R
AMC1 ORO.FC.232(b)(1)	New	2/17	EDD 2021/002/R
AMC1 ORO.FC.232(b)(3)	New	2/17	EDD 2021/002/R
ORO.FC.235	Changed		Reg. (EU) 2020/2036
AMC1 ORO.FC.240	Changed	2/17	EDD 2021/002/R
Annex IV (Part-CAT)			
CAT.IDE.A.185 pt. (c)(1)	Changed		Reg. (EU) 2020/2036
Annex VI (Part-NCC)			
NCC.IDE.A.160 pt. (b)(1)	Changed		Reg. (EU) 2020/2036
Annex VIII (Part-SPO)			
SPO.IDE.A.140 pt. (b)(1)	Changed		Reg. (EU) 2020/2036

REVISION TABLE (IR, AMC, GM)

AIR OPS RULES AMENDED BY EDD 2021/005/R

Part, subpart, article, rule	Action	EDD Issue/ Amdt. No	Amended by Commission Regulation / EASA ED Decision
(3) Cover regulation			
Article 9aa	Changed		(EU) 2019/1387
Annex I (Definitions)			
GM1 Annex I	Changed	1/13	EDD 2021/005/R
GM2 Annex I	Changed	1/13	EDD 2021/005/R

GM20 Annex I	New	1/13	EDD 2021/005/R
GM21 Annex I	New	1/13	EDD 2021/005/R
GM22 Annex I	New	1/13	EDD 2021/005/R
GM23 Annex I	New	1/13	EDD 2021/005/R
GM24 Annex I	New	1/13	EDD 2021/005/R
GM25 Annex I	New	1/13	EDD 2021/005/R
GM26 Annex I	New	1/13	EDD 2021/005/R
GM27 Annex I	New	1/13	EDD 2021/005/R
(4) Annex III (Part-ORO)			
AMC1 ORO.AOC.130	Changed	2/18	EDD 2021/005/R
GM1 ORO.AOC.130	Changed	2/18	EDD 2021/005/R
Appendix 1 to AMC1	Changed	2/18	EDD 2021/005/R
GM2 ORO.AOC.130	Changed	2/18	EDD 2021/005/R
GM1 ORO.GEN.130(b)	Changed	2/18	EDD 2021/005/R
AMC3 ORO.MLR.100	Changed	2/18	EDD 2021/005/R
AMC5 ORO.MLR.100	New	2/18	EDD 2021/005/R
(5) Annex IV (Part-CAT)			
AMC1 CAT.GEN.MPA.195(b)	Changed	2/18	EDD 2021/005/R
GM1 CAT.GEN.MPA.195(b)	Changed	2/18	EDD 2021/005/R
GM3 CAT.GEN.MPA.195(b)	Changed	2/18	EDD 2021/005/R
AMC1 CAT.GEN.MPA.195(f)(1)	Changed	2/18	EDD 2021/005/R
GM1 CAT.GEN.MPA.195(f)(1)	Deleted	2/18	EDD 2021/005/R
AMC1 CAT.GEN.MPA.195(f)(1a)	Changed	2/18	EDD 2021/005/R
AMC1 CAT.GEN.MPA.195(f)(3)	New	2/18	EDD 2021/005/R
AMC1 CAT.GEN.MPA.195(f)(3a)	New	2/18	EDD 2021/005/R
GM1 CAT.GEN.MPA.195(f)	New	2/18	EDD 2021/005/R
AMC1 CAT.OP.MPA.140(d)	Changed	2/18	EDD 2021/005/R
GM1 CAT.OP.MPA.140(d)	New	2/18	EDD 2021/005/R
GM1 CAT.OP.MPA.250	Changed	2/18	EDD 2021/005/R
GM2 CAT.OP.MPA.250	Changed	2/18	EDD 2021/005/R
GM3 CAT.OP.MPA.250	Changed	2/18	EDD 2021/005/R
AMC1 CAT.OP.MPA.300	Changed	2/18	EDD 2021/005/R
GM1 CAT.OP.MPA.300(a)	New	2/18	EDD 2021/005/R
AMC1 CAT.OP.MPA.301	New	2/18	EDD 2021/005/R
AMC1 CAT.OP.MPA.303	New	2/18	EDD 2021/005/R
GM1 CAT.OP.MPA.303	New	2/18	EDD 2021/005/R
GM2 CAT.OP.MPA.303	New	2/18	EDD 2021/005/R
GM3 CAT.OP.MPA.303	New	2/18	EDD 2021/005/R
AMC1 CAT.OP.MPA.303(e)	New	2/18	EDD 2021/005/R
AMC1 CAT.OP.MPA.311	New	2/18	EDD 2021/005/R
GM1 CAT.OP.MPA.311	New	2/18	EDD 2021/005/R
AMC1 CAT.OP.MPA.303 & CAT.OP.MPA.311	New	2/18	EDD 2021/005/R

GM1 CAT.OP.MPA.303 & CAT.OP.MPA.311	New	2/18	EDD 2021/005/R
AMC1 CAT.POL.A.200	Changed	2/18	EDD 2021/005/R
AMC1 CAT.POL.A.215	Changed	2/18	EDD 2021/005/R
GM1 CAT.POL.A.230	Changed	2/18	EDD 2021/005/R
GM1 CAT.POL.A.230(a)	New	2/18	EDD 2021/005/R
GM1 CAT.POL.A.230(d)(2)	New	2/18	EDD 2021/005/R
GM1 CAT.POL.A.235(a) and (b)	New	2/18	EDD 2021/005/R
GM1 CAT.POL.A.235(a)(1)	New	2/18	EDD 2021/005/R
AMC1 CAT.POL.A.235(a)(3)	New	2/18	EDD 2021/005/R
AMC1 CAT.POL.A.230 & CAT.POL.A.235	Changed	2/18	EDD 2021/005/R
GM1 CAT.POL.A.230 & CAT.POL.A.235	New	2/18	EDD 2021/005/R
GM2 CAT.POL.A.230 & CAT.POL.A.235	New	2/18	EDD 2021/005/R
GM1 CAT.POL.A.245(a)	New	2/18	EDD 2021/005/R
GM1 CAT.POL.A.255(a)(2)	New	2/18	EDD 2021/005/R
GM1 CAT.POL.A.255(a)(3)	New	2/18	EDD 2021/005/R
AMC1 CAT.POL.A.255(b)(1)	New	2/18	EDD 2021/005/R
AMC1 CAT.POL.A.255(b)(2)(iv)	New	2/18	EDD 2021/005/R
AMC2 CAT.POL.A.255(b)(2)(iv)	New	2/18	EDD 2021/005/R
GM1 CAT.POL.A.255(b)(2)(iv)	New	2/18	EDD 2021/005/R
GM2 CAT.POL.A.255(b)(2)(iv)	New	2/18	EDD 2021/005/R
AMC1 CAT.POL.A.255(b)(2)(v)	New	2/18	EDD 2021/005/R
GM1 CAT.POL.A.255(b)(2)(v)	New	2/18	EDD 2021/005/R
AMC1 CAT.POL.A.255(b)(2)(vi)	New	2/18	EDD 2021/005/R
GM1 CAT.POL.A.255(b)(2)(vi)	New	2/18	EDD 2021/005/R
AMC1 CAT.POL.A.255(b)(2)(vii)	New	2/18	EDD 2021/005/R
AMC1 CAT.POL.A.255(b)(2)(ix)	New	2/18	EDD 2021/005/R
AMC1 CAT.POL.A.305	Changed	2/18	EDD 2021/005/R
AMC1 CAT.POL.A.330	Changed	2/18	EDD 2021/005/R
GM1 CAT.POL.A.330	Changed	2/18	EDD 2021/005/R
GM1 CAT.POL.A.330(a)	New	2/18	EDD 2021/005/R
AMC1 CAT.POL.A.335	New	2/18	EDD 2021/005/R
GM1 CAT.POL.A.335	New	2/18	EDD 2021/005/R
GM1 CAT.POL.A.335(a)(1)	New	2/18	EDD 2021/005/R
AMC1 CAT.POL.A.335(a)(3)	New	2/18	EDD 2021/005/R
GM1 CAT.POL.A.330 & CAT.POL.A.335	New	2/18	EDD 2021/005/R
GM1 CAT.POL.A.345(a)	New	2/18	EDD 2021/005/R
GM1 CAT.POL.A.355(b)	New	2/18	EDD 2021/005/R
AMC1 CAT.POL.A.355(b)(4)	New	2/18	EDD 2021/005/R

AMC1 CAT.POL.A.355(b)(5) and (b)(6)	New	2/18	EDD 2021/005/R
GM1 CAT.POL.A.355(b)(7)	New	2/18	EDD 2021/005/R
GM1 CAT.POL.A.355(b)(7)	New	2/18	EDD 2021/005/R
AMC1 CAT.POL.A.355(b)(8)(i)	New	2/18	EDD 2021/005/R
GM1 CAT.POL.A.355(b)(8)(i)	New	2/18	EDD 2021/005/R
GM1 CAT.POL.A.355(b)(8)(ii)	New	2/18	EDD 2021/005/R
AMC1 CAT.POL.A.355(b)(9)	New	2/18	EDD 2021/005/R
AMC1 CAT.POL.A.355(b)(11)	New	2/18	EDD 2021/005/R
AMC1 CAT.POL.A.400	Changed	2/18	EDD 2021/005/R
AMC3 CAT.POL.A.400	New	2/18	EDD 2021/005/R
GM1 CAT.POL.A.430(a)	New	2/18	EDD 2021/005/R
AMC1 CAT.POL.A.435	New	2/18	EDD 2021/005/R
GM1 CAT.POL.A.435	New	2/18	EDD 2021/005/R
GM1 CAT.POL.A.435(a)(1)	New	2/18	EDD 2021/005/R
GM1 CAT.POL.A.430 & CAT.POL.A.435	New	2/18	EDD 2021/005/R
AMC1 CAT.POL.MAB.100(e)	Changed	2/18	EDD 2021/005/R
AMC1 CAT.IDE.A.105	New	2/18	EDD 2021/005/R
GM1 CAT.IDE.A.105	New	2/18	EDD 2021/005/R
AMC1 CAT.IDE.A.185	Changed	2/18	EDD 2021/005/R
GM1 CAT.IDE.A.185	New	2/18	EDD 2021/005/R
AMC1.2 CAT.IDE.A.190	Changed	2/18	EDD 2021/005/R
AMC1 CAT.IDE.A.191	New	2/18	EDD 2021/005/R
GM1 CAT.IDE.A.191	New	2/18	EDD 2021/005/R
GM2 CAT.IDE.A.191	New	2/18	EDD 2021/005/R
GM3 CAT.IDE.A.191	New	2/18	EDD 2021/005/R
GM1 CAT.IDE.A.191(e)	New	2/18	EDD 2021/005/R
AMC1 CAT.IDE.A.200	Changed	2/18	EDD 2021/005/R
AMC1 CAT.IDE.A.220	Changed	2/18	EDD 2021/005/R
GM1 CAT.IDE.A.220	New	2/18	EDD 2021/005/R
GM2 CAT.IDE.A.220	New	2/18	EDD 2021/005/R
GM3 CAT.IDE.A.220	New	2/18	EDD 2021/005/R
GM4 CAT.IDE.A.220	New	2/18	EDD 2021/005/R
AMC1 CAT.IDE.A.225	Changed	2/18	EDD 2021/005/R
AMC3 CAT.IDE.A.225	Changed	2/18	EDD 2021/005/R
GM2 CAT.IDE.A.225	New	2/18	EDD 2021/005/R
GM3 CAT.IDE.A.225	New	2/18	EDD 2021/005/R
AMC1 CAT.IDE.A.230(d)	New	2/18	EDD 2021/005/R
GM1 CAT.IDE.A.230	Changed	2/18	EDD 2021/005/R
AMC1 CAT.IDE.A.345(a)	New	2/18	EDD 2021/005/R
GM1 CAT.IDE.A.345(a)	New	2/18	EDD 2021/005/R
AMC1 CAT.IDE.H.105	New	2/18	EDD 2021/005/R

GM1 CAT.IDE.H.105	New	2/18	EDD 2021/005/R
AMC1 CAT.IDE.H.191	New	2/18	EDD 2021/005/R
GM1 CAT.IDE.H.191	New	2/18	EDD 2021/005/R
GM2 CAT.IDE.H.191	New	2/18	EDD 2021/005/R
GM3 CAT.IDE.H.191	New	2/18	EDD 2021/005/R
GM1 CAT.IDE.H.191(e)	New	2/18	EDD 2021/005/R
AMC1 CAT.IDE.H.220	Changed	2/18	EDD 2021/005/R
GM1 CAT.IDE.H.220	New	2/18	EDD 2021/005/R
GM2 CAT.IDE.H.220	New	2/18	EDD 2021/005/R
GM3 CAT.IDE.H.220	New	2/18	EDD 2021/005/R
GM4 CAT.IDE.H.220	New	2/18	EDD 2021/005/R
(6) Annex V (Part-SPA)			
AMC1 SPA.HOFO.145	Changed	1/9	EDD 2021/005/R
Annex VI (Part-NCC)			
AMC1 NCC.GEN.145(b)	Changed	1/13	EDD 2021/005/R
GM1 NCC.GEN.145(b)	New	1/13	EDD 2021/005/R
GM3 NCC.GEN.145(b)	New	1/13	EDD 2021/005/R
AMC1 NCC.GEN.145(f)(1)	New	1/13	EDD 2021/005/R
GM1 NCC.GEN.145(f)(1)	Deleted	1/13	EDD 2021/005/R
AMC1 NCC.GEN.145(f)(1a)	Changed	1/13	EDD 2021/005/R
AMC1 NCC.GEN.145(f)(3)	New	1/13	EDD 2021/005/R
AMC1 NCC.GEN.145(f)(3a)	New	1/13	EDD 2021/005/R
GM1 NCC.GEN.145(f)	New	1/13	EDD 2021/005/R
GM1 NCC.OP.185	Changed	1/13	EDD 2021/005/R
GM2 NCC.OP.185	Changed	1/13	EDD 2021/005/R
GM3 NCC.OP.185	Changed	1/13	EDD 2021/005/R
AMC1 NCC.OP.225	Changed	1/13	EDD 2021/005/R
GM1 NCC.OP.225	New	1/13	EDD 2021/005/R
GM2 NCC.OP.225	New	1/13	EDD 2021/005/R
GM3 NCC.OP.225	New	1/13	EDD 2021/005/R
GM4 NCC.OP.225	New	1/13	EDD 2021/005/R
GM5 NCC.OP.225	New	1/13	EDD 2021/005/R
AMC1 NCC.OP.226	New	1/13	EDD 2021/005/R
GM1 NCC.POL.105(e)	Changed	1/13	EDD 2021/005/R
GM1 NCC.POL.125	Changed	1/13	EDD 2021/005/R
GM1 NCC.POL.135	New	1/13	EDD 2021/005/R
AMC1 NCC.IDE.A.105	New	1/13	EDD 2021/005/R
GM1 NCC.IDE.A.105	New	1/13	EDD 2021/005/R
AMC2 NCC.IDE.A.165	Changed	1/13	EDD 2021/005/R
AMC1 NCC.IDE.A.190	Changed	1/13	EDD 2021/005/R
GM1 NCC.IDE.A.190	New	1/13	EDD 2021/005/R
GM2 NCC.IDE.A.190	New	1/13	EDD 2021/005/R
GM3 NCC.IDE.A.190	New	1/13	EDD 2021/005/R

GM4 NCC.IDE.A.190	New	1/13	EDD 2021/005/R
AMC1 NCC.IDE.A.245 & NCC.IDE.A.250	New	1/13	EDD 2021/005/R
GM1 NCC.IDE.A.245 & CAT.IDE.A.250	New	1/13	EDD 2021/005/R
AMC1 NCC.IDE.H.105	New	1/13	EDD 2021/005/R
GM1 NCC.IDE.H.105	New	1/13	EDD 2021/005/R
AMC1 NCC.IDE.H.190	Changed	1/13	EDD 2021/005/R
GM1 NCC.IDE.H.190	New	1/13	EDD 2021/005/R
GM2 NCC.IDE.H.190	New	1/13	EDD 2021/005/R
GM3 NCC.IDE.H.190	New	1/13	EDD 2021/005/R
GM4 NCC.IDE.H.190	New	1/13	EDD 2021/005/R
(7) Annex VII (Part-NCO)			
AMC1 NCO.OP.205	Changed	2/10	EDD 2021/005/R
GM1 NCO.OP.205	New	2/10	EDD 2021/005/R
AMC1 NCO.OP.206	New	2/10	EDD 2021/005/R
AMC1 NCO.IDE.A.105	New	2/10	EDD 2021/005/R
GM1 NCO.IDE.A.105	New	2/10	EDD 2021/005/R
AMC1 NCO.IDE.A.145	Changed	2/10	EDD 2021/005/R
GM1 NCO.IDE.A.145	New	2/10	EDD 2021/005/R
GM2 NCO.IDE.A.145	New	2/10	EDD 2021/005/R
AMC1 NCO.IDE.H.105	New	2/10	EDD 2021/005/R
GM1 NCO.IDE.H.105	New	2/10	EDD 2021/005/R
AMC1 NCO.IDE.H.145	Changed	2/10	EDD 2021/005/R
GM1 NCO.IDE.H.145	New	2/10	EDD 2021/005/R
GM2 NCO.IDE.H.145	New	2/10	EDD 2021/005/R
Annex VIII (Part SPO)			
AMC1 SPO.GEN.145(b)	Changed	1/13	EDD 2021/005/R
GM1 SPO.GEN.145(b)	Changed	1/13	EDD 2021/005/R
GM3 SPO.GEN.145(b)	Changed	1/13	EDD 2021/005/R
AMC1 SPO.GEN.145(f)	Changed	1/13	EDD 2021/005/R
AMC2 SPO.GEN.145(f)	Changed	1/13	EDD 2021/005/R
GM1 SPO.GEN.145(f) H	Deleted	1/13	EDD 2021/005/R
AMC1 SPO.GEN.145(f)(3)	New	1/13	EDD 2021/005/R
AMC1 SPO.GEN.145(f)(3a)	New	1/13	EDD 2021/005/R
GM1 SPO.GEN.145(f)	New	1/13	EDD 2021/005/R
GM1 SPO.OP.175	Changed	1/13	EDD 2021/005/R
GM2 SPO.OP.175	Changed	1/13	EDD 2021/005/R
GM3 SPO.OP.175	Changed	1/13	EDD 2021/005/R
AMC1 SPO.OP.210	Changed	1/13	EDD 2021/005/R
GM1 SPO.OP.210	New	1/13	EDD 2021/005/R
GM2 SPO.OP.210	New	1/13	EDD 2021/005/R
GM3 SPO.OP.210	New	1/13	EDD 2021/005/R

GM4 SPO.OP.210	New	1/13	EDD 2021/005/R
GM5 SPO.OP.210	New	1/13	EDD 2021/005/R
AMC1 SPO.OP.211	New	1/13	EDD 2021/005/R
GM1 SPO.POL.130(a)(4)	Changed	1/13	EDD 2021/005/R
GM1 SPO.POL.140	New	1/13	EDD 2021/005/R
AMC1 SPO.IDE.A.105	New	1/13	EDD 2021/005/R
GM1 SPO.IDE.A.105	New	1/13	EDD 2021/005/R
AMC2 SPO.IDE.A.145	Changed	1/13	EDD 2021/005/R
AMC1 SPO.IDE.A.146	New	1/13	EDD 2021/005/R
GM1 SPO.IDE.A.146	New	1/13	EDD 2021/005/R
GM2 SPO.IDE.A.146	New	1/13	EDD 2021/005/R
GM3 SPO.IDE.A.146	New	1/13	EDD 2021/005/R
GM1 SPO.IDE.A.146(e)	New	1/13	EDD 2021/005/R
AMC1 SPO.IDE.A.165	Changed	1/13	EDD 2021/005/R
AMC2 SPO.IDE.A.165	Changed	1/13	EDD 2021/005/R
GM1 SPO.IDE.A.165	New	1/13	EDD 2021/005/R
GM2 SPO.IDE.A.165	New	1/13	EDD 2021/005/R
GM3 SPO.IDE.A.165	New	1/13	EDD 2021/005/R
GM4 SPO.IDE.A.165	New	1/13	EDD 2021/005/R
AMC1 SPO.IDE.A.215 & SPO.IDE.A.220	New	1/13	EDD 2021/005/R
GM1 SPO.IDE.A.215 & SPO.IDE.A.220	New	1/13	EDD 2021/005/R
AMC1 SPO.IDE.H.105	New	1/13	EDD 2021/005/R
GM1 SPO.IDE.H.105	New	1/13	EDD 2021/005/R
AMC1 SPO.IDE.H.146	New	1/13	EDD 2021/005/R
GM1 SPO.IDE.H.146	New	1/13	EDD 2021/005/R
GM2 SPO.IDE.H.146	New	1/13	EDD 2021/005/R
GM3 SPO.IDE.H.146	New	1/13	EDD 2021/005/R
GM1 SPO.IDE.H.146(e)	New	1/13	EDD 2021/005/R
AMC1 SPO.IDE.H.165	Changed	1/13	EDD 2021/005/R
AMC2 SPO.IDE.H.165	Changed	1/13	EDD 2021/005/R
GM1 SPO.IDE.H.165	New	1/13	EDD 2021/005/R
GM2 SPO.IDE.H.165	New	1/13	EDD 2021/005/R
GM3 SPO.IDE.H.165	New	1/13	EDD 2021/005/R
GM4 SPO.IDE.H.165	New	1/13	EDD 2021/005/R

REVISION TABLE (IR, AMC, GM)

AIR OPS RULES AMENDED BY EDD 2021/008/R

Part, subpart, article, rule	Action	EDD Issue/ Amdt. No	Amended by Commission Regulation / EASA ED Decision
Annex I (Definitions)			
GM1 Annex I	Changed	1/14	EDD 2021/008/R
GM2 Annex I	Changed	1/14	EDD 2021/008/R
(8) Annex IV (Part-CAT)			
AMC1 CAT.GEN.MPA.205	Changed	2/19	EDD 2021/008/R
GM6 CAT.GEN.MPA.205	Changed	2/19	EDD 2021/008/R
AMC1 CAT.GEN.MPA.210	New	2/19	EDD 2021/008/R
GM1 CAT.GEN.MPA.210	New	2/19	EDD 2021/008/R
GM2 CAT.GEN.MPA.210	New	2/19	EDD 2021/008/R
AMC2 CAT.IDE.A.280	Changed	2/19	EDD 2021/008/R
GM1 CAT.IDE.A.280	Changed	2/19	EDD 2021/008/R
GM2 CAT.IDE.A.280	New	2/19	EDD 2021/008/R
AMC2 CAT.IDE.A.285(f)	New	2/19	EDD 2021/008/R
AMC2 CAT.IDE.H.280	Changed	2/19	EDD 2021/008/R
GM1 CAT.IDE.H.280	Changed	2/19	EDD 2021/008/R
GM2 CAT.IDE.H.280	New	2/19	EDD 2021/008/R
AMC1 CAT.IDE.H.300(b)(3) & CAT.IDE.H.305(b)	Changed	2/19	EDD 2021/008/R
(9) Annex V (Part-SPA)			
GM2 SPA.HOFO.145	Changed	1/10	EDD 2021/008/R
Annex VI (Part-NCC)			
AMC2 NCC.IDE.A.215	Changed	1/14	EDD 2021/008/R
GM1 NCC.IDE.A.215	New	1/14	EDD 2021/008/R
GM2 NCC.IDE.A.215	New	1/14	EDD 2021/008/R
AMC2 NCC.IDE.H.215	Changed	1/14	EDD 2021/008/R
GM1 NCC.IDE.H.215	New	1/14	EDD 2021/008/R
GM2 NCC.IDE.H.215	New	1/14	EDD 2021/008/R
AMC1 NCC.IDE.H.227(b)(3)	New	1/14	EDD 2021/008/R
(10) Annex VII (Part-NCO)			
AMC2 NCO.IDE.A.170	Changed	2/11	EDD 2021/008/R
GM1 NCO.IDE.A.170	Changed	2/11	EDD 2021/008/R
AMC2 NCO.IDE.H.170	Changed	2/11	EDD 2021/008/R
GM1 NCO.IDE.H.170	Changed	2/11	EDD 2021/008/R
Annex VIII (Part SPO)			
AMC2 SPO.IDE.A.190	Changed	1/14	EDD 2021/008/R
GM1 SPO.IDE.A.190	Changed	1/14	EDD 2021/008/R

GM3 SPO.IDE.A.190	New	1/14	EDD 2021/008/R
AMC2 SPO.IDE.H.190	Changed	1/14	EDD 2021/008/R
GM1 SPO.IDE.H.190	Changed	1/14	EDD 2021/008/R
GM3 SPO.IDE.H.190	New	1/14	EDD 2021/008/R

SUMMARY OF CHANGES – REVISION 14 (OCTOBER 2019)

EASY ACCESS RULES FOR AIR OPERATIONS

1. EASA ED Decision 2019/019/R related to Regulation (EU) 2019/1384 amending Regulation (EU) No 965/2012 on air operations, containing an update of the air operations rules and maintenance check flights

affects the following documents:

- GM to Cover Regulation (Article 2(1)(d)), issue 1 amendment 3
- GM to Annex I (Definitions), issue 1 amendment 11
- AMC&GM to Annex II (Part-ARO), issue 3 amendment 10
- AMC&GM to Annex III (Part-ORO), issue 2, amendment 15
- AMC&GM to Annex IV (Part-CAT), issue 2 amendment 17
- AMC&GM to Annex V (Part-SPA), issue 1 amendment 8
- AMC&GM to Annex VI (Part-NCC), initial issue, amendment 12
- AMC&GM to Annex VII (Part-NCO), issue 2, amendment 9
- AMC&GM to Annex VIII (Part-SPO), initial issue, amendment 12

Date of publication in the EASA Official Publication: 17 September 2019.

Date of entry into force: on the day following that of its publication in the Official Publication of EASA.

REVISION TABLE (IR, AMC, GM)

AIR OPS RULES AMENDED WITH REVISION 14 – OCTOBER 2019

ED Decision 2019/019/R containing AMC&GM related to Commission Regulation (EU) 2019/1384

Part, subpart, article, rule	Action	EDD Issue/ Amdt. no	Amended by Commission Regulation / EASA ED Decision
Cover regulation			
GM1 Art. 2(1)(d)	New	1/3	EDD 2019/019/R
GM1 Art. 3(5)(e)	New	1/3	EDD 2019/019/R
Annex I (Definitions)			
GM17 Annex I	New	1/11	EDD 2019/019/R
GM18 Annex I	New	1/11	EDD 2019/019/R
Annex II (Part-ARO)			
GM1 ARO.GEN.205	Deleted	3/10	EDD 2019/019/R
AMC2 ARO.GEN.305(b)	Changed	3/10	EDD 2019/019/R
AMC1 ARO.GEN.330	Changed	3/10	EDD 2019/019/R
GM2 ARO.OPS.110	Changed	3/10	EDD 2019/019/R
GM3 ARO.OPS.110	New	3/10	EDD 2019/019/R
GM2 ARO.OPS.200	Changed	3/10	EDD 2019/019/R

Part, subpart, article, rule	Action	EDD Issue/ Amdt. no	Amended by Commission Regulation / EASA ED Decision
GM3 ARO.OPS.200	New	3/10	EDD 2019/019/R
Annex III (Part-ORO)			
GM1 ORO.GEN.105	Deleted	2/15	EDD 2019/019/R
AMC1 ORO.GEN.110(f)(h)	Changed	2/15	EDD 2019/019/R
AMC1 ORO.GEN.130	Changed	2/15	EDD 2019/019/R
GM1 ORO.GEN.130(b)	Changed	2/15	EDD 2019/019/R
AMC1 ORO.GEN.160	Changed	2/15	EDD 2019/019/R
AMC1 ORO.GEN.200(a)(1)	Changed	2/15	EDD 2019/019/R
GM1 ORO.GEN.200(a)(1)	Changed	2/15	EDD 2019/019/R
GM2 ORO.GEN.200(a)(3)	Changed	2/15	EDD 2019/019/R
AMC1 ORO.GEN.200(a)(6)	Changed	2/15	EDD 2019/019/R
AMC2 ORO.GEN.205	New	2/15	EDD 2019/019/R
GM1 ORO.GEN.310	New	2/15	EDD 2019/019/R
GM2 ORO.GEN.310	New	2/15	EDD 2019/019/R
GM1 ORO.GEN.310(a)(2)	New	2/15	EDD 2019/019/R
AMC1 ORO.GEN.310(b);(e)	New	2/15	EDD 2019/019/R
GM1 ORO.GEN.310(d)	New	2/15	EDD 2019/019/R
AMC1 ORO.GEN.310(b);(d);(f)	New	2/15	EDD 2019/019/R
AMC1 ORO.AOC.110	Changed	2/15	EDD 2019/019/R
AMC1 ORO.AOC.110(c)	Changed	2/15	EDD 2019/019/R
GM1 ORO.AOC.110(c)	Changed	2/15	EDD 2019/019/R
AMC2 ORO.AOC.115(b)	Changed	2/15	EDD 2019/019/R
AMC1 ORO.AOC.125(a)	New	2/15	EDD 2019/019/R
AMC2 ORO.AOC.125(a)	New	2/15	EDD 2019/019/R
AMC1 ORO.AOC.125(a)(2)	New	2/15	EDD 2019/019/R
AMC2 ORO.AOC.125(a)(2)	New	2/15	EDD 2019/019/R
GM1 ORO.AOC.125(a)(2)	New	2/15	EDD 2019/019/R
GM2 ORO.AOC.135(a)	Changed	2/15	EDD 2019/019/R
AMC3 ORO.MLR.100	Changed	2/15	EDD 2019/019/R
GM1 ORO.MLR.105(d)(3)	Changed	2/15	EDD 2019/019/R
GM1 ORO.CC.100	Changed	2/15	EDD 2019/019/R
AMC1 ORO.CC.100(d)(2)	New	2/15	EDD 2019/019/R
GM1 ORO.CC.100(d)(2)	New	2/15	EDD 2019/019/R
AMC1 ORO.CC.125(d)	Changed	2/15	EDD 2019/019/R
AMC1 ORO.CC.135	Changed	2/15	EDD 2019/019/R
GM1 ORO.CC.205(a)	New	2/15	EDD 2019/019/R
AMC1 ORO.CC.205(c)(1)	Changed title	2/15	EDD 2019/019/R
AMC1 ORO.CC.205(d)	New	2/15	EDD 2019/019/R
AMC2 ORO.CC.205(d)	New	2/15	EDD 2019/019/R
GM1 ORO.FTL.105(1)	Changed	2/15	EDD 2019/019/R
Annex IV (Part-CAT)			
AMC1 CAT.OP.MPA.107	New	2/17	EDD 2019/019/R
GM1 CAT.OP.MPA.107	New	2/17	EDD 2019/019/R
GM2 CAT.OP.MPA.155(b)	Changed	2/17	EDD 2019/019/R

Part, subpart, article, rule	Action	EDD Issue/ Amdt. no	Amended by Commission Regulation / EASA ED Decision
AMC1 CAT.OP.MPA.170	Changed	2/17	EDD 2019/019/R
AMC3 CAT.OP.MPA.170	New	2/17	EDD 2019/019/R
GM1 CAT.OP.MPA.295	Changed	2/17	EDD 2019/019/R
AMC1 CT.IDE.A.125(a)(1)(iii) & CAT.IDE.A.130(b)	Changed	2/17	EDD 2019/019/R
AMC2 CAT.IDE.A.190	Changed	2/17	EDD 2019/019/R
AMC4 CAT.IDE.A.190	Changed	2/17	EDD 2019/019/R
AMC6 CAT.IDE.A.190	Changed	2/17	EDD 2019/019/R
AMC1 CAT.IDE.A.205	Changed	2/17	EDD 2019/019/R
GM2 CAT.IDE.A.205	New	2/17	EDD 2019/019/R
AMC2 CAT.IDE.H.190	Changed	2/17	EDD 2019/019/R
AMC1 CAT.IDE.H.205	Changed	2/17	EDD 2019/019/R
Annex V (Part-SPA)			
GM1 SPA.GEN.100(a)	New	1/8	EDD 2019/019/R
GM1 SPA.NVIS.130(e) → GM2 SPA.NVIS.130(e)	Renumbered	1/8	EDD 2019/019/R
AMC10 SPA.EFB.100(b)(3)	Changed	1/8	EDD 2019/019/R
Annex VI (Part-NCC)			
GM1 NCC.GEN.100	New	1/12	EDD 2019/019/R
GM1 NCC.OP.220	Changed	1/12	EDD 2019/019/R
AMC1 NCC.IDE.A.120(a)(3) & NCC.IDE.A.125(a)(3)	Changed	1/12	EDD 2019/019/R
AMC1 NCC.IDE.A.180	Changed	1/12	EDD 2019/019/R
GM2 NCC.IDE.A.180	New	1/12	EDD 2019/019/R
AMC1 NCC.IDE.H.180	Changed	1/12	EDD 2019/019/R
Annex VII (Part-NCO)			
GM1 NCO.GEN.100(b)	New	2/9	EDD 2019/019/R
AMC1 NCO.GEN.104	New	2/9	EDD 2019/019/R
GM1 NCO.GEN.104	New	2/9	EDD 2019/019/R
GM1 NCO.GEN.104(c)	New	2/9	EDD 2019/019/R
AMC1 NCO.IDE.A.120(a)(3) & NCO.IDE.A.125(a)(3)	Changed	2/9	EDD 2019/019/R
AMC1 NCO.IDE.H.140	Changed	2/9	EDD 2019/019/R
AMC1 NCO.SPEC.100	Changed	2/9	EDD 2019/019/R
GM1 NCO.SPEC.100	Changed	2/9	EDD 2019/019/R
GM1 NCO.SPEC.MCF.110	New	2/9	EDD 2019/019/R
AMC1 NCO.SPEC.MCF.120	New	2/9	EDD 2019/019/R
GM1 NCO.SPEC.MCF.125	New	2/9	EDD 2019/019/R
Annex VIII (Part-SPO)			
GM1 SPO.GEN.100	New	1/12	EDD 2019/019/R
GM1 SPO.OP.205	Changed	1/12	EDD 2019/019/R
AMC1 SPO.IDE.A.120(a)(3) & SPO.IDE.A.125(a)(3)	Changed	1/12	EDD 2019/019/R
GM1 SPO.IDE.H.150	Changed	1/12	EDD 2019/019/R

Part, subpart, article, rule	Action	EDD Issue/ Amdt. no	Amended by Commission Regulation / EASA ED Decision
GM1 SPO.SPEC.MCF.105	New	1/12	EDD 2019/019/R
AMC1 SPO.SPEC.MCF.110	New	1/12	EDD 2019/019/R
GM1 SPO.SPEC.MCF.115 and SPO.SPEC.MCF.120	New	1/12	EDD 2019/019/R
AMC1 SPO.SPEC.MCF.120	New	1/12	EDD 2019/019/R
AMC2 SPO.SPEC.MCF.120	New	1/12	EDD 2019/019/R
GM1 SPO.SPEC.MCF.125	New	1/12	EDD 2019/019/R

SUMMARY OF CHANGES – REVISION 13 (SEPTEMBER 2019)

EASY ACCESS RULES FOR AIR OPERATIONS

- 1. Commission Implementing Regulation (EU) 2019/1384 of 24 July 2019 amending Regulation (EU) No 965/2012 as regards the use of aircraft listed on an air operator certificate for non-commercial operations and specialised operations, the establishment of operational requirements for the conduct of maintenance check flights, the establishment of rules on non-commercial operations with reduced cabin crew on board and introducing editorial updates concerning air operations requirements**

affects the Cover Regulation (Articles 2, 6 and 9aa) and the following Annexes to Reg. (EU) 965/2012:

- Annex I – Definitions
- Annex II – Part-ARO
- Annex III – Part-ORO
- Annex IV – Part-CAT
- Annex V – Part-SPA
- Annex VI – Part-NCC
- Annex VII – Part-NCO
- Annex VIII – Part-SPO

This regulation introduces, among others, new requirements for maintenance check flights, a new definition of emergency exits, and a regulatory framework to allow the use of aircraft registered on an AOC by other operators for other-than-CAT operations, and as a result, proposes an amendment to Part-M of Regulation (EU) No 1321/2014.

Date of publication in the Official Journal: 4 September 2019.

Date of entry into force of Reg. (EU) 2019/1384: on the 20th day following that of its publication in the Official Journal of the EU.

- 2. Commission Implementing Regulation (EU) 2019/1387 of 1 August 2019 as regards requirements for aeroplane landing performance calculations and the standards for assessing the runway surface conditions, update on certain aircraft safety equipment and requirements and operations without holding an extended range operational approval**

affects the Cover Regulation (Article 9aa) and the following Annexes to Reg. (EU) No 965/2012:

- Annex I – Definitions
- Annex II – Part-ARO
- Annex III – Part-ORO
- Annex IV – Part-CAT
- Annex V – Part-SPA
- Annex VI – Part-NCC

- Annex VII – Part-NCO
- Annex VIII – Part-SPO

This regulation mandates the carriage of lightweight flight recorders for certain categories of light aircraft that are commercially operated (CAT and SPO). The current mass threshold for ‘non-ETOPS’ operations is removed, as well as the type design requirement for the 120–180-minute non-ETOPS operations with turbojet aeroplanes, and the mass limit requiring a reinforced cockpit door for certain categories of aeroplanes is increased.

The regulation requires the installation of an alternate power supply of the CVRs and associated cockpit-mounted area microphone installed on certain large aeroplanes.

This regulation also introduces standards for runway surface condition reporting, landing performance at time of arrival as well as a reduced required landing distance for CAT operations with certain categories of aeroplanes.

Date of publication in the Official Journal: 5 September 2019.

Date of entry into force of Reg. (EU) 2019/1387: on the 20th day following that of its publication in the Official Journal of the EU.

The following points of the Annex, addressing flight recorders for light aircraft, shall apply from 25 September 2019:

- Point (4)(a)
- Point (6)(b)
- Point (8)(b)

The following points of point (4) of the Annex, addressing runway performance, shall apply from 5 November 2020:

- Point (c)
- Point (d)
- Point (e)
- Point (f)
- Point (g)
- Point (n)
- Point (q).

REVISION TABLE (IR, AMC, GM)

AIR OPS RULES AMENDED WITH REVISION 13 – SEPTEMBER 2019

Part, subpart, article, rule	Action	EDD Issue/ Amdt. no	Amended by Commission Regulation / EASA ED Decision
Cover regulation			
Article 2, pt. 7	Changed		Reg. (EU) 2019/1384
Article 6(3)	Changed		Reg. (EU) 2019/1384

Part, subpart, article, rule	Action	EDD Issue/ Amdt. no	Amended by Commission Regulation / EASA ED Decision
Article 9aa	New		Reg. (EU) 2019/1384
Article 9aa	Changed		Reg. (EU) 2019/1387
Annex I (Definitions)			
Point (17)	Changed		Reg. (EU) 2019/1384
Point (22a)	New		Reg. (EU) 2019/1387
Point (25)	Changed		Reg. (EU) 2019/1387
Point (32)	Deleted		Reg. (EU) 2019/1387
Point (42)	Changed		Reg. (EU) 2019/1387
Point (45a)	New		Reg. (EU) 2019/1384
Point (48a)	New		Reg. (EU) 2019/1384
Point (49a)	New		Reg. (EU) 2019/1384
Point (49b)	New		Reg. (EU) 2019/1387
Point (49c)	New		Reg. (EU) 2019/1387
Point (70a)	New		Reg. (EU) 2019/1387
Point (76a)	New		Reg. (EU) 2019/1384
Point (95a)	New		Reg. (EU) 2019/1384
Point (95b)	New		Reg. (EU) 2019/1384
Point (103b)	New		Reg. (EU) 2019/1384
Point (103c)	New		Reg. (EU) 2019/1387
Point (107a)	New		Reg. (EU) 2019/1387
Point (128)	Changed		Reg. (EU) 2019/1387
Annex II (Part-ARO)			
ARO.GEN.120 (a),(b),(c)	Changed		Reg. (EU) 2019/1384
ARO.GEN.135(a)	Changed		Reg. (EU) 2019/1384
ARO.GEN.300(a)	Changed		Reg. (EU) 2019/1384
ARO.GEN.350(d)	Changed		Reg. (EU) 2019/1384
ARO.OPS.110 (a),(b),(d)	Changed		Reg. (EU) 2019/1384
ARO.OPS.150(b)	Changed		Reg. (EU) 2019/1384
ARO.OPS.200(b)	Changed		Reg. (EU) 2019/1384
ARO.RAMP.105(b)	Changed		Reg. (EU) 2019/1384
ARO.RAMP.115(b)	Changed		Reg. (EU) 2019/1384
ARO.RAMP.125	Changed		Reg. (EU) 2019/1384
ARO.RAMP.140(d)	Changed		Reg. (EU) 2019/1384
ARO.RAMP.150(a)	Changed		Reg. (EU) 2019/1384
Appendix I AOC	Changed		Reg. (EU) 2019/1384
Appendix II OpSpecs	Changed		Reg. (EU) 2019/1384
	Changed		Reg. (EU) 2019/1387
Appendix III Proof of ramp inspection	Deleted		Reg. (EU) 2019/1384
Appendix IV Ramp inspection report	Deleted		Reg. (EU) 2019/1384
Appendix V List of SPA → Appendix III	Changed number		Reg. (EU) 2019/1384

Part, subpart, article, rule	Action	EDD Issue/ Amdt. no	Amended by Commission Regulation / EASA ED Decision
Appendix VI Authorisation of high risk SPO → Appendix IV	Changed number		Reg. (EU) 2019/1384
Annex III (Part-ORO)			
ORO.GEN.110(h)	Changed		Reg. (EU) 2019/1384
ORO.GEN.135(a)	Changed		Reg. (EU) 2019/1384
ORO.GEN.140(a)	Changed		Reg. (EU) 2019/1384
ORO.GEN.160 (a),(c)	Changed		Reg. (EU) 2019/1384
ORO.GEN.205(a)	Changed		Reg. (EU) 2019/1384
Section 3 – Additional organisation requirements	New		Reg. (EU) 2019/1384
ORO.GEN.310	New		Reg. (EU) 2019/1384
ORO.GEN.310(f)(3)	Changed		Reg. (EU) 2019/1387
ORO.AOC.110(c)	Changed		Reg. (EU) 2019/1384
ORO.AOC.125	Changed		Reg. (EU) 2019/1384
ORO.AOC.135(a)	Changed		Reg. (EU) 2019/1384
ORO.SPO.100(c)	Changed		Reg. (EU) 2019/1384
ORO.SEC.100	Changed		Reg. (EU) 2019/1387
ORO.CC.100	Changed		Reg. (EU) 2019/1384
ORO.CC.205	Changed		Reg. (EU) 2019/1384
Appendix I Declaration	Changed		Reg. (EU) 2019/1384
Annex IV (Part-CAT)			
CAT.GEN.MPA.105 (a),(e)	Changed		Reg. (EU) 2019/1384
CAT.GEN.MPA.150	Changed		Reg. (EU) 2019/1384
CAT.GEN.MPA.180(a)	Changed		Reg. (EU) 2019/1384
CAT.GEN.MPA.210	Changed		Reg. (EU) 2019/1384
CAT.OP.MPA.170(b)	Changed		Reg. (EU) 2019/1384
CAT.GEN.MPA.195	Changed		Reg. (EU) 2019/1387
CAT.OP.MPA.140 (a),(d)	Changed		Reg. (EU) 2019/1387
CAT.OP.MPA.300	Changed		Reg. (EU) 2019/1387 – applies from 5/11/2020
CAT.OP.MPA.301	New		Reg. (EU) 2019/1387 – applies from 5/11/2020
CAT.OP.MPA.303	New		Reg. (EU) 2019/1387 – applies from 5/11/2020
CAT.OP.MPA.311	New		Reg. (EU) 2019/1387 – applies from 5/11/2020
CAT.OP.MPA.320	Changed		Reg. (EU) 2019/1384
CAT.POL.A.105	Changed		Reg. (EU) 2019/1387 – applies from 5/11/2020
CAT.POL.A.215 (b),(c),(d)	Changed		Reg. (EU) 2019/1387
CAT.POL.A.220	Changed		Reg. (EU) 2019/1387
CAT.POL.A.230	Changed		Reg. (EU) 2019/1387
CAT.POL.A.235	Changed		Reg. (EU) 2019/1387
CAT.POL.A.250(b)(11a)	New point		Reg. (EU) 2019/1387
CAT.POL.A.255	New		Reg. (EU) 2019/1387

Part, subpart, article, rule	Action	EDD Issue/ Amdt. no	Amended by Commission Regulation / EASA ED Decision
			– applies from 5/11/2020
CAT.POL.A.330	Changed		Reg. (EU) 2019/1387
CAT.POL.A.335	Changed		Reg. (EU) 2019/1387
CAT.POL.A.355	New		Reg. (EU) 2019/1387 – applies from 5/11/2020
CAT.POL.A.415 (d),(e)	Changed		Reg. (EU) 2019/1387
CAT.POL.A.420	Changed		Reg. (EU) 2019/1387
CAT.POL.A.430(a)	Changed		Reg. (EU) 2019/1387
CAT.POL.A.435(a)	Changed		Reg. (EU) 2019/1387
CAT.IDE.A.100(b)	Changed		Reg. (EU) 2019/1384
CAT.IDE.A.105(b)	Changed		Reg. (EU) 2019/1384
CAT.IDE.A.125 (a),(b)	Changed		Reg. (EU) 2019/1384
CAT.IDE.A.130 (b),(h)	Changed		Reg. (EU) 2019/1384
CAT.IDE.A.185(i)	New point		Reg. (EU) 2019/1387
CAT.IDE.A.191	New		Reg. (EU) 2019/1387
CAT.IDE.A.205 (a),(b)	Changed		Reg. (EU) 2019/1384
CAT.IDE.A.230 (b),(d)	Changed		Reg. (EU) 2019/1387
CAT.IDE.A.245(d)	Changed		Reg. (EU) 2019/1384
CAT.IDE.A.275 (c),(d)	Changed		Reg. (EU) 2019/1384
CAT.IDE.A.285(c)	Changed		Reg. (EU) 2019/1384
CAT.IDE.A.345	Title changed		Reg. (EU) 2019/1387
CAT.IDE.A.345(a)	Changed		Reg. (EU) 2019/1387
CAT.IDE.A.345(c)	Changed		Reg. (EU) 2019/1384
CAT.IDE.H.100 (a),(b)	Changed		Reg. (EU) 2019/1384
CAT.IDE.H.105(b)	Changed		Reg. (EU) 2019/1384
CAT.IDE.H.125 (a),(b)	Changed		Reg. (EU) 2019/1384
CAT.IDE.H.130 (b),(h)	Changed		Reg. (EU) 2019/1384
CAT.IDE.H.191	New		Reg. (EU) 2019/1387
CAT.IDE.H.315(a)	Changed		Reg. (EU) 2019/1384
CAT.IDE.H.320	Changed		Reg. (EU) 2019/1384
CAT.IDE.H.345	Title changed		Reg. (EU) 2019/1387
CAT.IDE.H.345(a)	Changed		Reg. (EU) 2019/1387
Annex V (Part-SPA)			
SPA.GEN.100	Changed		Reg. (EU) 2019/1384
SPA.DG.110(e)	Changed		Reg. (EU) 2019/1384
SPA.NVIS.110(b)	Changed		Reg. (EU) 2019/1384
SPA.HHO.110	Changed		Reg. (EU) 2019/1384
SPA.SET-IMC.105(b)	Changed		Reg. (EU) 2019/1387
Annex VI (Part-NCC)			
NCC.GEN.100	Changed		Reg. (EU) 2019/1384
NCC.GEN.101	New		Reg. (EU) 2019/1384
	Changed		Reg. (EU) 2019/1387
NCC.GEN.145	Changed		Reg. (EU) 2019/1387
NCC.OP.225	Changed		Reg. (EU) 2019/1387

Part, subpart, article, rule	Action	EDD Issue/ Amdt. no	Amended by Commission Regulation / EASA ED Decision
NCC.OP.226	New		Reg. (EU) 2019/1387
NCC.IDE.A.100(c)	Changed		Reg. (EU) 2019/1384
NCC.IDE.A.105(b)	Changed		Reg. (EU) 2019/1384
NCC.IDE.A.120 (a),(c)	Changed		Reg. (EU) 2019/1384
NCC.IDE.A.125 (a),(c),(h)	Changed		Reg. (EU) 2019/1384
NCC.IDE.A.180(b)	Changed		Reg. (EU) 2019/1384
NCC.IDE.A.250(e)	New point		Reg. (EU) 2019/1384
NCC.IDE.H.100(c)	Changed		Reg. (EU) 2019/1384
NCC.IDE.H.105(b)	Changed		Reg. (EU) 2019/1384
NCC.IDE.H.120 (a),(c)	Changed		Reg. (EU) 2019/1384
NCC.IDE.H.125 (a),(c)	Changed		Reg. (EU) 2019/1384
NCC.IDE.H.235	Changed		Reg. (EU) 2019/1384
NCC.IDE.H.250(e)	New point		Reg. (EU) 2019/1384
Annex VII (Part-NCO)			
NCO.GEN.100(b)	Changed		Reg. (EU) 2019/1384
NCO.GEN.104	New		Reg. (EU) 2019/1384
NCO.OP.205	Changed		Reg. (EU) 2019/1387
NCO.OP.206	New		Reg. (EU) 2019/1387
NCO.IDE.A.100 (b),(c)	Changed		Reg. (EU) 2019/1384
NCO.IDE.A.120(a)	Changed		Reg. (EU) 2019/1384
NCO.IDE.A.125(a)	Changed		Reg. (EU) 2019/1384
NCO.IDE.A.140(a)	Changed		Reg. (EU) 2019/1384
NCO.IDE.A.195(e)	New point		Reg. (EU) 2019/1384
NCO.IDE.H.100 (b),(c)	Changed		Reg. (EU) 2019/1384
NCO.IDE.H.120(a)	Changed		Reg. (EU) 2019/1384
NCO.IDE.H.125(a)	Changed		Reg. (EU) 2019/1384
NCO.IDE.H.140(a)	Changed		Reg. (EU) 2019/1384
NCO.IDE.H.185	Changed		Reg. (EU) 2019/1384
NCO.IDE.H.195(e)	New point		Reg. (EU) 2019/1384
NCO.SPEC.HEC.105(b)	Changed		Reg. (EU) 2019/1384
NCO.SPEC.PAR.120	Changed		Reg. (EU) 2019/1384
Subpart E, Section 6 Maintenance check flights (NCO.SPEC.MCF)	New section		Reg. (EU) 2019/1384
NCO.SPEC.MCF.105(a)	Changed		Reg. (EU) 2019/1387
NCO.SPEC.MCF.130	Changed		Reg. (EU) 2019/1387
Annex VIII (Part-SPO)			
SPO.GEN.005	Changed		Reg. (EU) 2019/1384
SPO.GEN.100	Changed		Reg. (EU) 2019/1384
SPO.GEN.140(a)	Changed		Reg. (EU) 2019/1387
SPO.GEN.145	Changed		Reg. (EU) 2019/1387
SPO.OP.210	Changed		Reg. (EU) 2019/1387
SPO.OP.211	New		Reg. (EU) 2019/1387
SPO.POL.110(a)	Changed		Reg. (EU) 2019/1384

Part, subpart, article, rule	Action	EDD Issue/ Amdt. no	Amended by Commission Regulation / EASA ED Decision
SPO.IDE.A.100 (b),(c)	Changed		Reg. (EU) 2019/1384
SPO.IDE.A.105	Changed		Reg. (EU) 2019/1384
SPO.IDE.A.120 (a),(e)	Changed		Reg. (EU) 2019/1384
SPO.IDE.A.125 (a),(c),(e)	Changed		Reg. (EU) 2019/1384
SPO.IDE.A.146	New		Reg. (EU) 2019/1387
SPO.IDE.A.160(e)	Changed		Reg. (EU) 2019/1384
SPO.IDE.A.220(e)	New point		Reg. (EU) 2019/1384
SPO.IDE.H.100 (b),(c)	Changed		Reg. (EU) 2019/1384
SPO.IDE.H.105	Changed		Reg. (EU) 2019/1384
SPO.IDE.H.120 (a),(d)	Changed		Reg. (EU) 2019/1384
SPO.IDE.H.125 (a),(c)	Changed		Reg. (EU) 2019/1384
SPO.IDE.H.220(e)	New point		Reg. (EU) 2019/1384
SPO.IDE.H.146	New		Reg. (EU) 2019/1387
SPO.SPEC.HESLO.100	Changed		Reg. (EU) 2019/1384
SPO.SPEC.HEC.100	Changed		Reg. (EU) 2019/1384
SPO.SPEC.HEC.105(b)	Changed		Reg. (EU) 2019/1384
SPO.SPEC.PAR.125	Changed		Reg. (EU) 2019/1384
Subpart E, Section 5 Maintenance check flights (SPO.SPEC.MCF)	New section		Reg. (EU) 2019/1384
SPO.SPEC.MCF.100	New		Reg. (EU) 2019/1384
SPO.SPEC.MCF.100(a)	Changed		Reg. (EU) 2019/1387
SPO.SPEC.MCF.105	New		Reg. (EU) 2019/1384
SPO.SPEC.MCF.110	New		Reg. (EU) 2019/1384
SPO.SPEC.MCF.115	New		Reg. (EU) 2019/1384
SPO.SPEC.MCF.120	New		Reg. (EU) 2019/1384
SPO.SPEC.MCF.125	New		Reg. (EU) 2019/1384
SPO.SPEC.MCF.130	New		Reg. (EU) 2019/1384
SPO.SPEC.MCF.135	New		Reg. (EU) 2019/1384
SPO.SPEC.MCF.140	New		Reg. (EU) 2019/1384
SPO.SPEC.MCF.145	New		Reg. (EU) 2019/1384

SUMMARY OF CHANGES – REVISION 12 (MARCH 2019)

1. **Commission Implementing Regulation (EU) 2018/1975 of 14 December 2018 amending Regulation (EU) No 965/2012 as regards air operations requirements for sailplanes and electronic flight bags**

affects the Cover Regulation (Articles 1, 2, 5, 6 and 10) and the following Annexes to Reg. (EU) 965/2012:

- Annex I – Definitions
- Annex II – Part-ARO
- Annex III – Part-ORO
- Annex IV – Part-CAT
- Annex V – Part-SPA
- Annex VI – Part-NCC
- Annex VII – Part-NCO
- Annex VIII – Part-SPO

Date of publication in the Official Journal: 20 December 2018.

Date of application of Reg. (EU) 2018/1975: 9 July 2019.

2. **EASA ED Decision 2018/012/R related to Regulation (EU) 2018/1042 amending regulation (EU) No 965/2012 on air operations, containing requirements on aircrew medical fitness**

affects the following documents:

- GM to Cover Regulation (Article 4.3), issue 1 amendment 2
- AMC and GM to Annex II Part-ARO, issue 3 amendment 8
- AMC and GM to Annex IV Part-CAT, issue 2 amendment 15

Date of publication in the EASA Official Publication: 22 November 2018.

Date of application of EDD 2018/012/R: 14 August 2020.

3. **EASA ED Decision 2019/005/R related to Reg. (EU) 2018/1974 amending Reg. (EU) No 1178/2011 on aircrew, containing new requirements on loss of control prevention and recovery training (UPRT)**

affects the following documents:

- GM to Annex I (Definitions), issue 1 amendment 8
- AMC and GM to Annex III (Part-ORO), issue 2 amendment 13

Date of publication in the EASA Official Publication: 27 Feb. 2019.

Date of application of EDD 2019/005/R: 20 December 2019.

4. EASA ED Decision 2019/007/R on the simplification of ramp requirements

affects the following documents:

- GM to Annex I (Definitions), issue 1 amendment 9
- AMC and GM to Annex II (Part-ARO), issue 3 amendment 9

Date of publication in the EASA Official Publication: 27 Feb. 2019.

Date of application of EDD 2019/007/R: 01 September 2019, except for Annex II pt. 4 of EDD 2019/007/R introducing AMC1 ARO.RAMP.100(c), which shall apply from 1 January 2020.

5. EASA ED Decision 2019/008/R related to Reg. (EU) 2018/1975 amending Reg. (EU) No 965/2012 on air operations, containing the transposition of provisions on electronic flight bags (EFB) from ICAO Annex 6 and deleting the sailplane requirements from the AMC and GM associated to Reg. (EU) No 965/2012

affects the following documents:

- GM to Annex I (Definitions), issue 1 amendment 10
- AMC and GM to Annex III (Part-ORO), issue 2 amendment 14
- AMC and GM to Annex IV (Part-CAT), issue 2 amendment 16
- AMC and GM to Annex V (Part-SPA), issue 1 amendment 7
- AMC and GM Annex VI (Part-NCC), initial issue, amendment 11
- AMC and GM to Annex VII (Part-NCO), issue 2 amendment 8
- AMC and GM to Annex VIII (Part-SPO), initial issue, amendment 11

Date of publication in the EASA Official Publication: 27 Feb. 2019.

Date of application of EDD 2019/008/R: 9 July 2019.

6. Typographical errors in the unofficial consolidated document on Easy Access Rules, in the following paragraphs:

- AMC1 ARO.RAMP.125(b) point (g); and
- CAT.IDE.H.350.

SUMMARY OF CHANGES – REVISION 11 (JULY 2018)

1. **Commission Regulation (EU) 2018/1042 of 23 July 2018 amending Regulation (EU) No 965/2012, as regards technical requirements and administrative procedures related to introducing support programmes, psychological assessment of flight crew, as well as systematic and random testing of psychoactive substances to ensure medical fitness of flight and cabin crew members, and as regards equipping newly manufactured turbine-powered aeroplanes with a maximum certified take-off mass of 5 700 kg or less and approved to carry six to nine passengers with a terrain awareness warning system**

affects the Cover Regulation (Articles 4 and 9b) and the following Annexes to Reg. (EU) 965/2012:

- Annex I – Definitions
- Annex II – Part-ARO
- Annex IV – Part-CAT
- Annex VI – Part-NCC
- Annex VII – Part-NCO
- Annex VIII – Part-SPO

Date of publication in the Official Journal: 25 July 2018.

Date of application of Reg. (EU) 2018/1042: 14 August 2020, except for the provisions related to TAWS (CAT.IDE.A.150 and SPO.IDE.A.130), which shall apply from 14 August 2018.

SUMMARY OF CHANGES – REVISION 10 (MARCH 2018)

1. **EASA Decision 2017/023/R containing amendments on flight recorders, underwater locating devices and aircraft tracking systems**

affects the following documents:

- GM to Annex I (Definitions), amendment 7
- AMC and GM to Annex III Part-ORO, issue 2 amendment 12
- AMC and GM to Annex IV Part-CAT, issue 2 amendment 13

This Decision is a result of Reg. (EU) 2015/2338, which introduced new requirements for flight recorders, underwater locating devices and aircraft tracking systems. With this regulation, a new point (f) was added to CAT.IDE.A.285 (Flight over water), requiring that large aeroplane operated for commercial air transport over oceanic areas be fitted with a low-frequency underwater locating device.

A first set of AMC and GM complementing the implementing rules published in Reg. (EU) 2015/2338 was issued through Decision 2015/030/R of 17 December 2015.

A second set of AMC and GM covering protection of cockpit voice recorder and flight data recorder parameters was issued through Decision 2016/012/R of 12 September 2016.

This is the third set of AMC and GM to support the implementation of CAT.GEN.MPA.205 and to clarify point (f) of CAT.IDE.A.285.

Date of publication in the EASA Official Publication: 14 December 2017.

Date of application of EDD 2017/023/R: the day following the day of its publication in the EASA Official Publication.

2. **Commission Regulation 2018/394 amending Reg. (EU) No 965/2012 as regards the deletion of air operations requirements for balloons**

affects the Cover Regulation (Articles 1, 2, 3, 5, 6, 8, 10) and the following Annexes to Reg. (EU) 965/2012:

- Annex I – Definitions
- Annex II – Part-ARO
- Annex III – Part-ORO
- Annex IV – Part-CAT
- Annex VII – Part-NCO
- Annex VIII – Part-SPO

Date of publication in the Official Journal: 14 March 2018.

Date of application of Reg. (EU) 2018/394: 8 April 2019.

3. **EASA Decision 2018/003/R related to Reg. (EU) 2018/394 as regards the deletion of the air operations requirements on balloons**

The Decision affects the following documents:

- GM to Cover Regulation – amendment 2
- AMC&GM to Annex II (Part-ARO) – issue 3, amendment 7
- AMC&GM to Annex IV (Part-CAT) – issue 2 amendment 14
- AMC&GM to Annex VII (Part-NCO) – issue 2 amendment 7
- AMC&GM to Annex VIII (Part-SPO) – issue 1 amendment 10

Date of publication in the EASA Official Publication: 23 March 2018.

Date of application of EDD 2018/003/R: 8 April 2019.

SUMMARY OF CHANGES – REVISION 9 (MAY 2017)

EASA Decisions containing the update of the Air Ops rules:

- ED Decision 2017/005/R on GM to Annex I (Definitions), amendment 6
- ED Decision 2017/006/R on AMC/GM to Part-ARO, issue 3 amendment 6
- ED Decision 2017/007/R on AMC/GM to Part-ORO, issue 2 amendment 11
- ED Decision 2017/008/R on AMC/GM to Part-CAT, issue 2 amendment 12
- ED Decision 2017/009/R on AMC/GM to Part-SPA, amendment 6
- ED Decision 2017/010/R on AMC/GM to Part-NCC, amendment 10
- ED Decision 2017/011/R on AMC/GM to Part-NCO, issue 2 amendment 6
- ED Decision 2017/012/R on AMC/GM to Part-SPO, amendment 9

The main changes performed with these Decisions are the following:

- Editorial changes in the AMC/GM to all Annexes;
- Better identification of inspector qualifications (AMC/GM to Part-ARO);
- AMC4 ARO.GEN.200(a)(2) ‘Management system. Inspector qualification for CAT operations’ becomes applicable 24 months from 30/03/2017;
- More flexibility for operators regarding the location of emergency medical kit (EMK);
- Safety issues identified in passenger (emergency exit) seating and briefing;
- Implementation issues related to helicopter sling load operations (HESLO).

Date of application for all the ED Decisions above: the day following the day of its publication in the EASA Official Publication.

Exception: ED Decision 2017/006/R (Part-ARO):

“AMC4 ARO.GEN.200(a)(2) Management system, INSPECTOR QUALIFICATION FOR CAT OPERATIONS:

- a. shall apply 24 months from the day following that of the publication of this Decision in the EASA Official Publication, and
- b. shall not apply to inspecting staff already qualified as inspector to perform oversight tasks.”

Date of publication in the EASA Official Publication of all the ED Decisions above: 30 March 2017.

SUMMARY OF CHANGES – REVISION 8 (MARCH 2017)

1. **Reg. (EU) 2017/363 on single-engined turbine aeroplane operations at night or in instrument meteorological conditions (SET-IMC) and the approval requirements for the dangerous goods training related to commercial SPO, NCC, and non-commercial SPO of complex motor-powered aircraft**

This regulation enters into force on the 20th day following the day of its publication in the Official Journal of the EU.

Date of publication in the Official Journal of the EU: 02 March 2017.

The affected parts are the Cover Regulation (Article 6(3)), Annex II (Part-ARO), Annex III (Part-ORO), Annex IV (Part-CAT) and Annex V (Part-SPA) and related AMC/GM.

The affected paragraphs with the applicability date are marked accordingly in the Revision Table (IR, AMC, GM) further down.

2. **Related EASA Decision 2017/004/R**

The main changes are related to the following topics:

- The single-engined turbine aeroplane operations at night or in instrument meteorological conditions (SET-IMC);
- The one-off flights carrying no passengers or cargo where the aircraft is ferried for refurbishment, repair, maintenance checks, inspections, delivery, export or similar purposes shall be exempted from the application of Regulation (EU) No 965/2012;
- The approval requirements for the dangerous goods training programme for the commercial SPO, NCC and non-commercial SPO with complex-motor powered aircraft.

3. **EASA Decisions 2017/002/R and 2017/003/R (post-transition) in relation to the publication of Regulation (EU) 2017/373 on the management of aeronautical databases and also linked to the OPS amendments to Reg. (EU) 965/2012 already published (Reg. (EU) 2016/1199)**

The changes are related to the publication of Reg. (EU) No 2017/373 on the management of aeronautical databases.

This regulation brings changes only at the level of AMC and GM of the Air operations rules.

The changes affect the following AMC/GM:

- a. EDD 2017/002/R: AMC/GM to Annexes IV (Part-CAT) and VI (Part-NCC).

Date of application: the day following the day of publication in the EASA Official Publication.

Date of publication in the EASA Official Publication: 08 March 2017.

- b. EDD 2017/003/R: AMC/GM to Annexes IV (Part-CAT), VI (Part-NCC), VII (Part-NCO) and VIII (Part-SPO).

Date of application: 1 January 2019.

SUMMARY OF CHANGES – REVISION 7 (OCT. 2016)

1. EASA Decision 2016/022/R on helicopter offshore operations (HOFO) in Reg. (EU) 2016/1199

ED Decision 2016/022/R affected all Annexes to Reg. (EU) No 965/2012.

The changes are related to helicopter offshore operations (HOFO).

This Decision entered into force on the following day after its publication in the EASA Official Publication. It shall apply from 1 July 2018.

Date of publication in the EASA Official Publication: 07 Oct. 2016.

2. Editorial changes, correcting Rev. 6 of Air Ops consolidated version

These changes are not repeated in the Revision Table (IR, AMC, GM).

#	Rule reference	Change
Annex II (Part-ARO)		
1.	AMC1 ARO.RAMP.110	Improper numbering of subparagraphs
2.	Appendix II Operations specifications – the row with PBN	The word “complex” was added in the box
Annex IV (Part-CAT)		
3.	CAT.GEN.MPA.105 (a)(10)	(iii) instead of (ii)
4.	CAT.IDE.A.205 (a)(3)	Update as amended by Reg. 2016/1199

SUMMARY OF CHANGES – REVISION 6 (SEPT. 2016)

1. **Reg. (EU) 2016/1199 on PBN, Helicopter Offshore Operations (HOFO) and data service providers of aeronautical data**

- Operational approval of performance-based navigation;
- Certification and oversight of data services providers and processing of the aeronautical data and information – applicable only from 01 January 2019. The related text is marked and barred;
- Helicopter offshore operations (HOFO) – applicable only from 01 July 2018. The affected text is marked in grey and barred;
- Rules related to the transport of dangerous goods and rules related to upper torso restraint systems on flight crew seats and on passenger seats of certain small aeroplanes;
- Rules related to the carriage and use of supplemental oxygen supply in non-pressurised aeroplanes and helicopters engaged in non-commercial operations;
- Alleviation for twin turboprop aeroplanes with an MCTOM at or below 5 700 kg to operate under the NCO rules.

2. **EASA ED Decision 2016/016/R related to the implementation of PBN requirements of Reg. (EU) 2016/1199**

- ED Decision 2016/016/R on Annex I – Definitions
- ED Decision 2016/014/R on Annex II – Part-ARO
- ED Decision 2016/019/R on Annex III – Part-ORO
- ED Decision 2016/015/R on Annex IV – Part-CAT
- ED Decision 2016/020/R on Annex V – Part-SPA
- ED Decision 2016/017/R on Annex VI – Part-NCC
- ED Decision 2016/018/R on Annex VII – Part-NCO
- ED Decision 2016/021/R on Annex VII – Part-SPO

These Decisions, amending the acceptable means of compliance (AMC) and guidance material (GM) to the annexes to Regulation (EU) No 965/2012 (the ‘Air OPS Regulation’), address an economic issue related to performance-based navigation (PBN) operations. EASA is issuing these Decisions following the amendment of the Air OPS Regulation through Regulation (EU) 2016/1199.

The main changes are:

- The provision of PBN-related rules on pilot training and checking;
- The removal of the requirements for specific approvals for most PBN operations;
- The compliance with the fourth edition of the ICAO PBN Manual; and
- The introduction of proportionate operating procedures where necessary.

The Decisions also include clarifications on the requirements on upper torso restraint (UTR) systems, as well as new AMC and GM on the use of oxygen and on the transport of dangerous goods in the context of NCO operations.

These Decisions entered into force on the following day after their publication in the EASA Official Publication.

Date of publication in the EASA Official Publication: 02/08/2016.

3. **EASA ED Decision 2016/012/R related to Reg. (EU) 2015/2338 (second set)**

ED Decision 2016/012/R includes changes and new AMC/GM related to Reg. (EU) 2015/2338 on flight recorders, underwater locating devices and aircraft tracking systems.

The new AMC and GM are intended to update the operational requirements applicable to flight data recorders (FDRs). The AMC and GM are related to the following topics:

- Protection and use of recordings of the CVR in normal operation;
- Operational requirements for FDRs when installed on future aircraft; and
- Recording inspection.

This Decision enters into force on the following day after their publication in the EASA Official Publication.

Date of publication in the EASA Official Publication: 13/09/2016.

SUMMARY OF CHANGES – REVISION 5 (MAY 2016)

1. **EDD 2016/008 on PBN (Reg. (EU) 2016/539 amending Reg. (EU) 1178/2011) affecting AMC/GM to Part-ARO and Part-ORO**

This Decision addresses a safety and regulatory coordination issue related to training, testing and checking of pilots who wish to perform performance-based navigation (PBN) operations; it addresses a regulatory coordination issue related to the theoretical knowledge training for aeroplane and helicopter CPL, ATPL, MPL and IR; and it addresses a regulatory coordination issue related to pilot training with an operator after the issue of an MPL. The specific objective is to maintain a high level of safety for holders of the above-mentioned pilot licences.

On 6 April 2016, Commission Regulation (EU) 2016/539 entered into force, which amends Commission Regulation (EU) No 1178/2011 (the Aircrew Regulation) by implementing PBN-related changes to the training, testing and checking of pilots. This Decision proposes the related AMC and GM. It also contains other aircrew-related AMC and GM that were initially related to other Agency rulemaking tasks and, therefore, the following three annexes are annexed to it:

- Annex I: amendments to the AMC/GM to the Aircrew Regulation related to PBN operations (RMT.0256), and AMC/GM to ARA.MED.330 (RMT.0413);
- Annex II: amendments to the AMC/GM to the Aircrew Regulation related to the detailed theoretical knowledge syllabus and learning objectives for ATPL, MPL, CPL and IR for aeroplanes and helicopters (RMT.0188); and
- Annex III: amendments to the AMC/GM to Part-ORO (Issue 2 amd. 7) and Part-ARO (Issue 3 and. 2) of Commission Regulation (EU) No 965/2012 related to the removal of the licence restriction to an operator for MPL holders.

Date of entry into force: on the day following the day of its publication in the Official Publication of the Agency.

Date of publication in the EASA Official Publication: 02 May 2016.

2. **EDD 2016/004 on Special Categories of Passengers (SCP) affecting AMC/GM to Part-ORO and Part-CAT**

This Decision addresses a safety issue related to the safe carriage of special categories of passengers (SCPs). SCPs are persons with reduced mobility (PRMs), infants and unaccompanied children, deportees, inadmissible passengers, or prisoners in custody.

These changes are based on passenger rights and anti-discrimination regulations and will provide operators with more reliable tools to mitigate SCP-related risks and hazards.

This Decision affects the AMC/GM to Part-ORO and Part-CAT. It only applies to European commercial air transport (CAT) operators and is related to Regulation (EU) No 965/2012 on Air Operations.

Application:

- **The AMC/GM to Part-ORO enters into force 48 months following the day of its publication in the Official Publication of the Agency.**
- **The AMC/GM to Part-CAT enters into force 18 months following the day of its publication in the Official Publication of the Agency.**

- **Date of publication in the EASA Official Publication: 27 January 2016**

COVER REGULATION

COMMISSION REGULATION (EU) No 965/2012

of 5 October 2012

laying down technical requirements and administrative procedures related to air operations pursuant to Regulation (EC) No 216/2008 of the European Parliament and of the Council

Regulation (EU) No 965/2012

THE EUROPEAN COMMISSION,

Having regard to the Treaty on the Functioning of the European Union,

Having regard to Regulation (EC) No 216/2008 of the European Parliament and of the Council of 20 February 2008 on common rules in the field of civil aviation and establishing a European Aviation Safety Agency, and repealing Council Directive 91/670/EEC, Regulation (EC) No 1592/2002 and Directive 2004/36/EC¹, and in particular Articles 8(5) and 10(5) thereof,

Whereas:

- (1) Operators and personnel involved in the operation of certain aircraft have to comply with the relevant essential requirements set out in Annex IV to Regulation (EC) No 216/2008.
- (2) Regulation (EC) No 216/2008 requires that Member States, in addition to their oversight of certificates that they have issued, conduct investigations, including ramp inspections, and shall take any measure, including the grounding of aircraft, to prevent the continuation of an infringement.
- (3) In accordance with Regulation (EC) No 216/2008 the Commission should adopt the necessary implementing rules for establishing the conditions for the safe operation of aircraft.
- (4) In order to ensure a smooth transition and a high level of civil aviation safety in the European Union, implementing measures should reflect the state of the art, including best practices, and scientific and technical progress in the field of air operations. Accordingly, technical requirements and administrative procedures agreed under the auspices of the International Civil Aviation Organisation (hereinafter 'ICAO') and the European Joint Aviation Authorities until 30 June 2009, as well as existing legislation pertaining to a specific national environment, should be considered.
- (5) It is necessary to provide sufficient time for the aeronautical industry and Member State administrations to adapt to the new regulatory framework and to recognise under certain conditions the validity of certificates issued before this Regulation applies.
- (6) As this Regulation constitutes an implementing measure referred to in Articles 8(5) and 10(5) of Regulation (EC) No 216/2008, Annex III to Council Regulation (EEC) No 3922/91² and Directive 2004/36/EC of the European Parliament and of the Council³ shall be considered repealed in accordance with Article 69(3) and 69(5) of Regulation (EC) No 216/2008. However, Annex III should remain in place temporarily until the transitional periods foreseen in this Regulation have expired and for those areas for which no implementing measures have yet been adopted.

¹ OJ L 79, 19.3.2008, p. 1.

² OJ L 373, 31.12.1991, p. 4.

³ OJ L 143, 30.4.2004, p. 76.

Similarly, Directive 2004/36/EC should remain applicable temporarily until the transitional periods foreseen in this Regulation have expired.

- (7) The European Aviation Safety Agency prepared draft implementing rules and submitted them as an opinion to the Commission in accordance with Article 19(1) of Regulation (EC) No 216/2008.
- (8) The measures provided for in this Regulation are in accordance with the opinion of the Committee established by Article 65 of Regulation (EC) No 216/2008,

HAS ADOPTED THIS REGULATION:

Article 1 - Subject matter and scope

Regulation (EU) 2018/1975

1. This Regulation lays down detailed rules for air operations with aeroplanes and helicopters, including ramp inspections of aircraft of operators under the safety oversight of another State when landed at aerodromes located in the territory subject to the provisions of the Treaties.
2. This Regulation also lays down detailed rules on the conditions for issuing, maintaining, amending, limiting, suspending or revoking the certificates of operators of aircraft referred to in points (b) (i) and (ii) of Article 2(1) of Regulation (EU) 2018/1139, except for balloons and sailplanes, engaged in commercial air transport operation, the privileges and responsibilities of the holders of certificates as well as conditions under which operations shall be prohibited, limited or subject to certain conditions in the interest of safety.
3. This Regulation also lays down detailed rules on the conditions and procedures for the declaration by operators engaged in commercial specialised operations of aeroplanes and helicopters or in non-commercial operation of complex motor-powered aircraft, including non-commercial specialised operations of complex motor-powered aircraft, of their capability and the availability of the means to discharge the responsibilities associated with the operation of aircraft, and for the oversight of such operators.
4. This Regulation also lays down detailed rules on the conditions under which certain high risk commercial specialised operations shall be subject to authorisation in the interest of safety, and on the conditions for issuing, maintaining, amending, limiting, suspending or revoking the authorisations.
5. This Regulation shall not apply to air operations within the scope of Article 1(2)(a) of Regulation (EC) No 216/2008.
6. This Regulation shall not apply to air operations with airships.
7. This Regulation shall not apply to air operations with balloons and sailplanes. However, in respect of such air operations with balloons, other than tethered gas balloons, and sailplanes, the requirements in respect of oversight of Article 3 shall apply.

Article 2 - Definitions

Regulation (EU) 2019/1384

For the purposes of this Regulation:

- (1) ‘aeroplane’ means an engine-driven fixed-wing aircraft heavier than air that is supported in flight by the dynamic reaction of the air against its wings;
- (1a) ‘helicopter’ means a heavier-than-air aircraft supported in flight chiefly by the reactions of the air on one or more power-driven rotors on substantially vertical axes;

-
- (1b) 'balloon' means a manned lighter-than-air aircraft which is not power-driven and sustains flight through the use of either a lighter-than-air gas or an airborne heater, including gas balloons, hot-air balloons, mixed balloons and, although power-driven, hot-air airships;
 - (1c) 'sailplane' means a heavier-than-air aircraft that is supported in flight by the dynamic reaction of the air against its fixed lifting surfaces, the free flight of which does not depend on an engine;
 - (1d) 'commercial operation' means any operation of an aircraft, in return for remuneration or other valuable consideration, which is available for the public or, when not made available to the public, which is performed under a contract between an operator and a customer, where the latter has no control over the operator;
 - (1e) 'tethered gas balloon' means a gas balloon with a tether system that continuously anchors the balloon to a fixed point during operation;
 - (2) 'performance class B aeroplanes' means aeroplanes powered by propeller engines with a maximum operational passenger seating configuration of nine or less and a maximum take-off mass of 5 700 kg or less;
 - (3) 'public interest site (PIS)' means a site used exclusively for operations in the public interest;
 - (4) 'operation in performance class 1' means an operation that, in the event of failure of the critical engine, the helicopter is able to land within the rejected take-off distance available or safely continue the flight to an appropriate landing area, depending on when the failure occurs;
 - (5) 'performance-based navigation (PBN)' means area navigation based on performance requirements for aircraft operating along an ATS route, on an instrument approach procedure or in a designated airspace;
 - (6) 'air taxi operation' means, for the purpose of flight time and duty time limitations, a non-scheduled on demand commercial air transport operation with an aeroplane with a maximum operational passenger seating configuration ('MOPSC') of 19 or less;
 - (7) 'specialised operation' means any operation, other than commercial air transport operation, where the aircraft is used for specialised activities such as agriculture, construction, photography, surveying, observation and patrol, aerial advertisement, maintenance check flights;
 - (8) 'high risk commercial specialised operation' means any commercial specialised aircraft operation carried out over an area where the safety of third parties on the ground is likely to be endangered in the event of an emergency, or, as determined by the competent authority of the place where the operation is conducted, any commercial specialised aircraft operation that, due to its specific nature and the local environment in which it is conducted, poses a high risk, in particular to third parties on the ground;
 - (9) 'introductory flight' means any operation against remuneration or other valuable consideration consisting of an air tour of short duration for the purpose of attracting new trainees or new members, performed either by a training organisation referred to in Article 10a of Commission Regulation (EU) No 1178/2011¹ or by an organisation created with the aim of promoting aerial sport or leisure aviation;

¹ Commission Regulation (EU) No 1178/2011 of 3 November 2011 laying down technical requirements and administrative procedures related to civil aviation aircrew pursuant to Regulation (EC) No 216/2008 of the European Parliament and of the Council (OJ L 311, 25.11.2011, p. 1).

- (10) 'competition flight' means any flying activity where the aircraft is used in air races or contests, as well as where the aircraft is used to practice for air races or contests and to fly to and from racing or contest events;
- (11) 'flying display' means any flying activity deliberately performed for the purpose of providing an exhibition or entertainment at an advertised event open to the public, including where the aircraft is used to practice for a flying display and to fly to and from the advertised event.

Additional definitions are laid down in [Annex I](#) for the purposes of Annexes II to VIII.

GM1 Article 2(1)(d) Definitions

ED Decision 2019/019/R

NON-COMMERCIAL OPERATIONS — EXAMPLES

The following examples of operations are not covered by the definition of commercial operations or by that of specialised operations. They are identified as non-commercial operations. Some of these flights are listed by an AOC holder in its operations manual Part-A, ch. 8.7 as non-commercial operations (as specified in [AMC3 ORO.MLR.100](#)) and covered by the provisions of [ORO.AOC.125](#).

Some of these operations are performed on an irregular basis. The operator and its crew members may consider them as non-routine operations, situated outside their operational routine. This constitutes a risk that the operator should include in its risk assessment process.

The operations listed below are performed with aircraft having a certificate of airworthiness or a permit to fly and being already listed on an AOC or on a declaration. They are grouped by the purpose of the flight.

Demonstration flights

- (a) A flight performed with the purpose of demonstrating:
- (1) an aircraft's handling, performance and functionalities to buyers or lessees;
 - (2) an aircraft's flying characteristics or the operational procedures to the competent authority, for verification of compliance with the operational requirements, as per [ARO.GEN.310\(a\)](#).

Other terms used: (route) proving flight; operational evaluation flight.

- (b) Flight at the end of lease or upon transfer of ownership: a flight performed at the request of the operator to verify compliance of the aircraft with the contractual specifications of the lessee/lessor or buyer.

Other term used: acceptance flight.

- (c) 'Public relations (PR) flight': a flight carrying official or media representatives as non-paying passengers. Sometimes personnel of the operator are included. The PR flight is performed in the interest of the operator's own business.

Testing the results of maintenance work is outside the scope of demonstration flights. Such flights are not expected to execute flight manoeuvres where the aircraft might react with an unexpected behaviour. This is covered by a maintenance check flight (listed below).

Maintenance check flights

(d) Maintenance check flight (MCF)

The definition of an MCF is provided in Annex I to Regulation (EU) No 965/2012. The provisions on MCF are developed in Annex VII (Part-NCO), Subpart E Section 6 and Annex VIII (Part-SPO), Subpart E Section 5.

Ferry flights – flights changing the location of the aircraft

A ferry flight could be performed for the following purposes:

(e) The aircraft is moved to and from a maintenance base. The aircraft may be operated under the permit-to-fly conditions.

Examples:

- (1) unpressurised flight,
- (2) gear-down flight,
- (3) flight with one engine inoperative.

(f) The aircraft is moved from one location to another, e.g. from the manufacturer, refurbishment location, previous owner, lessor/lessee, long-term storage to the operator's base.

Other term used: delivery flight.

(g) The aircraft and its aircrew are positioned to an aerodrome from which a further commercial air transport (CAT) operation will be performed.

Other term used: positioning flight.

(h) The aircraft is moved from its current location to a secure location for various reasons (e.g. to remove it from a hazardous area).

Other term used: recovery flight.

Training flights

(i) A flight for instructional purposes for the operator's own flight crew.

Operator training and checking flight: a flight performed by the operator with the purpose of training, checking and/or familiarising a flight crew member with the operator's procedures linked to the aircraft being operated. A training flight is conducted using the procedures detailed in the operator's documentation.

Line flying under supervision (LIFUS), line checks and similar flights are not included in this category, as they are usually performed during commercial operations (CAT flights).

Other non-commercial flights

(j) 'Corporate flight': a flight conducted for business purposes: the operator may carry its own personnel and/or property in the interest of business.

Other terms used: business flight, private flight.

(k) 'Leisure flight': a flight operated by an operator for personal or recreational purposes, not associated with a business or a profession.

Other term used: private flight.

(l) Managed flight: a flight operated by an operator for the business purposes of the aircraft owner, with no remuneration or other valuable consideration involved.

Charity flights, humanitarian flights

- (m) 'Charity flight': a flight performed for the benefit of a registered charity organisation, carrying persons and/or goods. For such a flight, the proceeds of the raffled flight go to the charity. Any additional proceeds are limited to the recovery of direct costs of the flight.
- (n) 'Humanitarian flight': a flight with the purpose of carrying relief personnel and/or life-saving supplies (basic necessities) during or after an emergency or a natural disaster, or to evacuate persons from an endangered area.

Article 3 - Oversight capabilities

Regulation (EU) 2018/394

1. Member States shall designate one or more entities as the competent authority within that Member State with the necessary powers and allocated responsibilities for the certification and oversight of persons and organisations subject to Regulation (EC) No 216/2008 and its implementing rules.

The administration and management systems of the competent authorities of the Member States and of the Agency shall comply with the requirements specified in Annex II.
2. If a Member State designates more than one entity as competent authority:
 - (a) the areas of competence of each competent authority shall be clearly defined in terms of responsibilities and geographic limitation; and
 - (b) coordination shall be established between those entities to ensure effective oversight of all organisations and persons subject to Regulation (EC) No 216/2008 and its implementing rules within their respective remits.
3. Member States shall ensure that the competent authority(ies) has(ve) the necessary capability to ensure the oversight of all persons and organisations covered by their oversight programme, including sufficient resources to fulfil the requirements of this Regulation.
4. Member States shall ensure that competent authority personnel do not perform oversight activities when there is evidence that this could result directly or indirectly in a conflict of interest, in particular when relating to family or financial interest.
5. Personnel authorised by the competent authority to carry out certification and/or oversight tasks shall be empowered to perform at least the following tasks:
 - (a) examine the records, data, procedures and any other material relevant to the execution of the certification and/or oversight task;
 - (b) take copies of or extracts from such records, data, procedures and other material;
 - (c) ask for an oral explanation on site;
 - (d) enter relevant premises, operating sites or means of transport;
 - (e) perform audits, investigations, assessments, inspections, including ramp inspections and unannounced inspections;
 - (f) take or initiate enforcement measures as appropriate.
6. The tasks under paragraph 5 shall be carried out in compliance with the legal provisions of the relevant Member State.

GM1 Article 3(5)(e) Oversight capabilities

ED Decision 2019/019/R

INSPECTIONS BY PERSONNEL AUTHORISED BY THE COMPETENT AUTHORITY

Inspections performed by personnel authorised by the competent authority to perform oversight or certification tasks means announced or unannounced inspections, including in-flight inspections, to oversee any operations in accordance with this Regulation.

Article 4 - Ramp inspections

Regulation (EU) 2018/1042

1. Ramp inspections of aircraft of operators under the safety oversight of another Member State or of a third country shall be carried out in accordance with Subpart RAMP of Annex II.
2. Member States shall ensure that alcohol testing of flight crew and cabin crew members is carried out with regard to operators under their own oversight as well as with regard to operators under the oversight of another Member State or of a third country. Such testing shall be performed by ramp inspectors within the framework of the ramp inspection programme of Subpart RAMP of Annex II.
3. By way of derogation from paragraph 2, Member States may ensure alcohol testing of flight crew and cabin crew members to be carried out by other authorised officials and outside the framework of the ramp inspection programme of Subpart RAMP of Annex II, provided that such alcohol testing meets the same objectives and adheres to the same principles as tests carried out under the framework of Subpart RAMP of Annex II. Results of such alcohol tests shall be included in the centralised database in accordance with point (b) of [ARO.RAMP.145](#).
4. Member States may carry out additional testing for psychoactive substances other than alcohol. In that case, the Member State shall notify the European Aviation Safety Agency ('the Agency') and the Commission.

GM1 Article 4(3) Ramp inspections

ED Decision 2018/012/R

GENERAL — ALCOHOL TESTING

If alcohol testing of flight crew and cabin crew is carried out by other authorised officials, e.g. by the police, and outside the framework of the ramp inspection programme of Subpart RAMP of Annex II, those other authorised officials do not need to comply with the requirements for qualification of inspectors of Subpart RAMP of Annex II. Member States should ensure that these officials are qualified for carrying out alcohol tests.

Article 5 - Air operations

Regulation (EU) 2021/2237

1. Operators shall only operate an aeroplane or a helicopter for the purpose of commercial air transport (hereinafter "CAT") operations as specified in Annexes III and IV.
 - 1a. Operators engaged in CAT operations starting and ending at the same aerodrome/operating site with Performance class B aeroplanes or non-complex helicopters shall comply with the relevant provisions of Annexes III and IV.

2. Operators shall comply with the relevant provisions of Annex V when operating:
 - (a) aeroplanes and helicopters used for:
 - (i) operations using performance-based navigation (PBN);
 - (ii) operations in accordance with minimum navigation performance specifications (MNPS);
 - (iii) operations in airspace with reduced vertical separation minima (RVSM);
 - (iv) low-visibility operations (LVOs) or operations with operational credits;
 - (b) aeroplanes and helicopters used for the transport of dangerous goods (DG);
 - (c) two-engined aeroplanes used for extended range operations (ETOPS) in commercial air transport;
 - (d) helicopters used for commercial air transport operations with the aid of night vision imaging systems (NVIS);
 - (e) helicopters used for commercial air transport hoist operations (HHO);
 - (f) helicopters used for commercial air transport emergency medical service operations (HEMS);
 - (g) helicopters used for offshore operations (HOFO).
3. Operators of complex motor-powered aeroplanes and helicopters involved in non-commercial operations shall declare their capability and means to discharge their responsibilities associated with the operation of aircraft and operate the aircraft in accordance with the provisions specified in Annex III and Annex VI. Such operators when engaged in non-commercial specialised operations shall operate the aircraft in accordance with the provisions specified in Annex III and VIII instead.
4. Operators of other-than-complex motor-powered aeroplanes and helicopters involved in non-commercial operations, including non-commercial specialised operations, shall operate the aircraft in accordance with the provisions set out in Annex VII.
5. Training organisations referred to in Article 10a of Regulation (EU) No 1178/2011 and having their principal place of business in a Member State shall, when conducting flight training into, within or out of the Union, operate:
 - (a) complex motor-powered aeroplanes and helicopters in accordance with the provisions specified in Annex VI;
 - (b) other aeroplanes and helicopters in accordance with the provisions specified in Annex VII.
6. Operators shall only operate an aeroplane or a helicopter for the purpose of commercial specialised operations in accordance with the requirements specified in Annexes III and VIII.
7. Flights taking place immediately before, during or immediately after specialised operations and directly connected to those operations shall be operated in accordance with paragraphs 3, 4 and 6, as applicable. Except for crew members, persons other than those indispensable to the mission shall not be carried on board.

Article 6 - Derogations

Regulation (EU) 2019/1384

2. By way of derogation from Article 5(1), aircraft referred to in Article 4(5) of Regulation (EC) No 216/2008 shall, in the case of aeroplanes, be operated under the conditions set out in Commission Decision C(2009) 7633 of 14 October 2009 when used in CAT operations. Any change to the operation that affects the conditions set out in that Decision shall be notified to the Commission and the European Aviation Safety Agency (hereinafter 'the Agency') before the change is implemented.

A Member State, other than an addressee of Decision C(2009)7633, which intends to use the derogation provided for in that Decision shall notify its intention to the Commission and the Agency before the derogation is implemented. The Commission and the Agency shall assess to what extent the change or the intended use deviates from the conditions of Decision C(2009)7633 or impacts on the initial safety assessment performed in the context of that Decision. If the assessment shows that the change or the intended use does not correspond to the initial safety assessment done for Decision C(2009)7633, the Member State concerned shall submit a new derogation request in accordance with Article 14(6) of Regulation (EC) No 216/2008.
3. By way of derogation from Article 5 of this Regulation and without prejudice to point (b) of Article 18(2) of Regulation (EU) 2018/1139 and to Subpart P of Annex I to Commission Regulation (EU) No 748/2012¹ concerning the permit to fly, the following flights shall continue to be operated under the requirements specified in the national law of the Member State in which the operator has its principal place of business, or, where the operator has no principal place of business, the place where the operator is established or resides:
 - (a) flights related to the introduction or modification of aeroplane or helicopter types conducted by design or production organisations within the scope of their privileges;
 - (b) flights carrying no passengers or cargo, where the aeroplane or helicopter is ferried for refurbishment, repair, inspections, delivery, export or similar purposes, provided that the aircraft is not listed on an air operator certificate or on a declaration.
4. Notwithstanding Article 5, Member States may, until 30 June 2018, continue to require a specific approval and additional requirements regarding operational procedures, equipment, crew qualification and training for CAT helicopter offshore operations in accordance with their national law. Member States shall notify the Commission and the Agency of the additional requirements being applied to such specific approvals. Those requirements shall not be less restrictive than those of Annexes III and IV.
- 4a. By way of derogation from Article 5(1) and (6), the following operations with other-than-complex motor-powered aeroplanes and helicopters, may be conducted in accordance with Annex VII:
 - (a) cost-shared flights by private individuals, on the condition that the direct cost is shared by all the occupants of the aircraft, pilot included and the number of persons sharing the direct costs is limited to six;
 - (b) competition flights or flying displays, on the condition that the remuneration or any valuable consideration given for such flights is limited to recovery of direct costs and a

¹ Commission Regulation (EU) No 748/2012 of 3 August 2012 laying down implementing rules for the airworthiness and environmental certification of aircraft and related products, parts and appliances, as well as for the certification of design and production organisations (OJ L 224, 21.8.2012, p. 1).

proportionate contribution to annual costs, as well as prizes of no more than a value specified by the competent authority;

- (c) introductory flights, parachute dropping, sailplane towing or aerobatic flights performed either by a training organisation having its principal place of business in a Member State and referred to in Article 10a of Regulation (EU) No 1178/2011, or by an organisation created with the aim of promoting aerial sport or leisure aviation, on the condition that the aircraft is operated by the organisation on the basis of ownership or dry lease, that the flight does not generate profits distributed outside of the organisation, and that whenever non-members of the organisation are involved, such flights represent only a marginal activity of the organisation.
5. Until 2 September 2017, exemptions granted before 22 March 2017 in accordance with Article 8(2) of Regulation (EEC) No 3922/91, as provided for in Article 6(5) of Regulation (EU) No 965/2012 as applicable before 22 March 2017, shall be considered to constitute approvals referred to in point (a) of [CAT.POL.A.300](#) of Annex IV (Part-CAT). After 2 September 2017, those exemptions shall no longer be valid for the operation of single-engined aeroplanes.

If any change to the operation of those aeroplanes that affects the conditions set out in those exemptions is envisaged between 22 March 2017 and 2 September 2017, that envisaged change shall be notified to the Commission and the Agency before it is implemented. The Commission and the Agency shall assess the envisaged change in accordance with Article 14(5) of Regulation (EC) No 216/2008.

6. Existing helicopter operations to/from a public interest site (PIS) may be conducted in derogation to [CAT.POL.H.225](#) of Annex IV whenever the size of the PIS, the obstacle environment or the helicopter does not permit compliance with the requirements for operation in performance class 1. Such operations shall be conducted under conditions determined by Member States. Member States shall notify the Commission and the Agency of the conditions being applied.
7. [deleted with Reg. EU 2016/1199]
8. By way of derogation from the first sentence of Article 5(3), operators of complex motor-powered aeroplanes with a maximum certificated take-off mass (MCTOM) at or below 5 700 kg, equipped with turboprop engines, involved in non-commercial operations, shall operate those aircraft only in accordance with Annex VII.
9. By way of derogation from Article 5(5)(a), training organisations shall, when conducting flight training on complex motor-powered aeroplanes with a maximum certificated take-off mass (MCTOM) at or below 5 700 kg, equipped with turboprop engines, operate those aircraft in accordance with Annex VII.

GM1 Article 6.4a Derogations

ED Decision 2018/003/R

OTHER-THAN-COMPLEX MOTOR-POWERED AIRCRAFT

The term 'other-than-complex motor-powered aircraft' is used synonymously with the terms 'other-than complex motor-powered aircraft' and 'other than complex motor-powered aircraft'. Whenever one of these terms is used, it includes also non-motor-powered aircraft such as sailplanes.

GM2 Article 6.4a(a);(b) Derogations

ED Decision 2014/019/R

DIRECT COST

‘Direct cost’ means the cost directly incurred in relation to a flight, e.g. fuel, airfield charges, rental fee for an aircraft. There is no element of profit.

GM3 Article 6.4a(a);(b) Derogations

ED Decision 2014/019/R

ANNUAL COST

‘Annual cost’ means the cost of keeping, maintaining and operating the aircraft over a period of one calendar year. There is no element of profit.

GM1 Article 6.4a(c) Derogations

ED Decision 2014/019/R

ORGANISATION CREATED WITH THE AIM OF PROMOTING AERIAL SPORT OR LEISURE AVIATION

An ‘organisation created with the aim of promoting aerial sport or leisure aviation’ means a non-profit organisation, established under applicable national law for the sole purpose of gathering persons sharing the same interest in general aviation to fly for pleasure or to conduct parachute jumping. The organisation should have aircraft available.

GM2 Article 6.4a(c) Derogations

ED Decision 2014/019/R

MARGINAL ACTIVITY

The term ‘marginal activity’ should be understood as representing a very minor part of the overall activity of an organisation, mainly for the purpose of promoting itself or attracting new students or members. An organisation intending to offer such flights as regular business activity is not considered to meet the condition of marginal activity. Also, flights organised with the sole intent to generate income for the organisation, are not considered to be a marginal activity.

Article 7 - Air operator certificates

Regulation (EU) No 965/2012

1. Air operator certificates (AOCs) issued by a Member State to CAT operators of aeroplanes before this Regulation applies in accordance with Regulation (EEC) No 3922/91 shall be deemed to have been issued in accordance with this Regulation.

However, no later than 28 October 2014:

- (a) operators shall adapt their management system, training programmes, procedures and manuals to be compliant with Annexes III, IV and V, as relevant;
 - (b) the AOC shall be replaced by certificates issued in accordance with Annex II to this Regulation.
2. AOCs issued by a Member State to CAT operators of helicopters before this Regulation applies shall be converted into AOCs compliant with this Regulation in accordance with a conversion report established by the Member State that issued the AOC, in consultation with the Agency.

The conversion report shall describe:

- (a) the national requirements on the basis of which the AOCs were issued;
- (b) the scope of privileges that were given to the operators;
- (c) the differences between the national requirements on the basis of which the AOCs were issued and the requirements of Annexes III, IV and V, together with an indication of how and when the operators will be required to ensure full compliance with those Annexes.

The conversion report shall include copies of all documents necessary to demonstrate the elements set out in points (a) to (c), including copies of the relevant national requirements and procedures.

Article 8 - Flight time limitations

Regulation (EU) 2018/394

1. CAT operations shall be subject to the requirements of Subpart FTL of Annex III.
2. By way of derogation from paragraph 1, air taxi, emergency medical service and single pilot CAT operations by aeroplanes shall be subject to the requirements specified in the national law referred to in Article 8(4) of Regulation (EEC) No 3922/91 and in Subpart Q of Annex III to that Regulation.
3. By way of derogation from paragraph 1, CAT operations with helicopters and CAT operations with sailplanes shall comply with the requirements specified in the national law of the Member State in which the operator has its principal place of business.
4. Non-commercial operations, including non-commercial specialised operations, with complex motor-powered aeroplanes and helicopters, as well as commercial specialised operations with aeroplanes, helicopters and sailplanes shall comply as regards flight time limitations, with the requirements specified in the national law of the Member State in which the operator has its principal place of business, or, where the operator has no principal place of business, the place where the operator is established or resides.

Article 9 - Minimum equipment lists

Regulation (EU) No 71/2014

Minimum equipment lists ('MEL') approved by the State of Operator or Registry before the application of this Regulation, are deemed to be approved in accordance with this Regulation and may continue to be used by the operator.

After the entry into force of this Regulation any change to the MEL referred to in the first subparagraph for which a Master Minimum Equipment List ('MMEL') is established as part of the operational suitability data in accordance with Commission Regulation (EU) No 748/2012¹ shall be made in compliance with point [ORO.MLR.105](#) of Section 2 of Annex III to this Regulation at the earliest opportunity and not later than 18 December 2017 or two years after the operational suitability data was approved, whichever is the latest.

Any change to an MEL referred to in the first subparagraph, for which an MMEL has not been established as part of the operational suitability data, shall continue to be made in accordance with the MMEL accepted by the State of Operator or Registry as applicable.

¹ OJ L 224, 21.8.2012, p. 1.

Article 9a - Flight and cabin crew training

Regulation (EU) No 71/2014

Operators shall ensure that flight crew and cabin crew members who are already in operation and have completed training in accordance with Subparts FC and CC of Annex III which did not include the mandatory elements established in the relevant operational suitability data, undertake training covering those mandatory elements not later than 18 December 2017 or two years after the approval of the operational suitability data, whichever is the latest.

Article 9aa - Flight crew requirements for maintenance check flights

Regulation (EU) 2019/1387

A pilot having acted, before 25 September 2019, as a pilot-in-command on a maintenance check flight that in accordance with the definition in point [SPO.SPEC.MCF.100](#) in Annex VIII is categorised as a Level A maintenance check flight, shall be given credit for the purpose of complying with point [SPO.SPEC.MCF.115\(a\)\(1\)](#) of that Annex. In that case, the operator shall ensure that the pilot-in-command receives a briefing on any differences identified between the operating practices established before 25 September 2019 and the obligations provided in Section 5 of Subpart E of Annex VIII to this Regulation including those derived from the related procedures established by the operator.

Article 9b - Review

Regulation (EU) 2021/1296

1. The Agency shall conduct a continuous review of the effectiveness of the provisions concerning flight and duty time limitations and rest requirements contained in Annexes II and III. No later than 18 February 2019 the Agency shall produce a first report on the results of this review.

That review shall involve scientific expertise and shall be based on operational data gathered, with the assistance of Member States, on a long-term basis after the date of application of this Regulation.

The review shall assess the impact of at least the following on the alertness of aircrew:

- (a) duties of more than 13 hours at the most favourable times of the day;
 - (b) duties of more than 10 hours at less favourable times of the day;
 - (c) duties of more than 11 hours for crew members in an unknown state of acclimatisation;
 - (d) duties including a high level of sectors (more than 6);
 - (e) on-call duties such as standby or reserve followed by flight duties; and
 - (f) disruptive schedules.
2. The Agency shall conduct a continuous review of the effectiveness of the provisions concerning support programmes, the psychological assessment of flight crew and the systematic and random testing of psychoactive substances to ensure the medical fitness of flight crew and cabin crew members set out in Annexes II and IV. No later than 14 August 2023, the Agency shall produce a first report on the results of this review.

That review shall involve relevant expertise and shall be based on data gathered, with the assistance of Member States and the Agency, on a long-term basis.

Article 10 - Entry into force¹

Regulation (EU) 2021/2237

1. This Regulation shall enter into force on the third day following that of its publication in the *Official Journal of the European Union*.

It shall apply from 28 October 2012.

Amending Regulation (EU) No 800/2013 shall apply from 25 August 2013².

Amending Regulation (EU) No 71/2014 shall enter into force on 17 February 2014³. It shall apply not later than 18 December 2017 or two years after the approval of the operational suitability data, whichever is the latest.

Amending Regulation (EU) No 83/2014 shall apply from 18 February 2016, except for the provisions of [ORO.FTL.205\(e\)](#), which shall apply only from 17 February 2017 by way of derogation⁴.

Amending Regulation (EU) No 379/2014 shall apply from 1 July 2014⁵.

Amending Regulation (EU) 2015/140 shall apply from 18 February 2015, except for the provisions of Article 9b 'Review', which shall apply from 18 February 2016⁶.

Amending Regulation (EU) 2015/640 shall apply from 14 May 2015⁷.

Amending Regulation (EU) 2015/1329 shall apply from 1 October 2015, except for the provisions of [ORO.AOC.110\(d\)](#), which shall apply only from 25 August 2017 by way of derogation⁸.

Amending Regulation (EU) 2015/2338 shall apply from 5 January 2016⁹.

Amending Regulation (EU) 2016/1199 shall apply from 25 August 2016¹⁰, except for the provisions related to the helicopter offshore operations, which shall apply from 1 July 2018, and the provisions related to the certification and oversight of data services providers, which shall apply from 1 January 2019.

Amending Regulation (EU) 2017/363 shall apply from 22 March 2017¹¹.

Amending Regulation (EU) 2018/394 shall apply from 8 April 2019¹².

¹ This version of Article 10 is a compilation of the provisions related to the entry into force and application of all previous amendments to Regulation (EU) No 965/2012 to date. For the official version of each amending regulation, please consult the [Official Journal](#).

² Please consult [Regulation \(EU\) No 800/2013](#) for the official version.

³ Please consult [Regulation \(EU\) No 71/2014](#) for the official version.

⁴ Please consult [Regulation \(EU\) No 83/2014](#) for the official version.

⁵ Please consult [Regulation \(EU\) No 379/2014](#) for the official version.

⁶ Please consult [Regulation \(EU\) 2015/140](#) for the official version.

⁷ Please consult [Regulation \(EU\) 2015/640](#) for the official version.

⁸ Please consult [Regulation \(EU\) 2015/1329](#) for the official version.

⁹ Please consult [Regulation \(EU\) 2015/2338](#) for the official version.

¹⁰ Please consult [Regulation \(EU\) 2016/1199](#) for the official version.

¹¹ Please consult [Regulation \(EU\) 2017/363](#) for the official version.

¹² Please consult [Regulation \(EU\) 2018/394](#) for the official version.

Amending Regulation (EU) 2018/1042 shall apply from 14 August 2020, except for the provisions related to [CAT.IDE.A.150](#) and [SPO.IDE.A.130](#), which shall apply from 14 August 2018¹.

Amending Regulation (EU) 2018/1975 shall apply from 9 July 2019².

Amending Regulation (EU) 2019/1384 shall enter into force on 24 September 2019³.

Amending Regulation (EU) 2019/1387 shall enter into force on 25 September 2019⁴.

The following points of the Annex to Regulation (EU) 2019/1387 shall apply from 25 September 2019:

- point (4)(a);
- point (6)(b);
- point (8)(b).

The following points of point (4) of the Annex to Regulation (EU) 2019/1387 shall apply from 5 November 2020:

- point (c);
- point (d);
- point (e);
- point (f);
- point (g);
- point (n);
- point (q).

Regulation (EU) 2020/745, amending the dates of application of Regulation (EU) 2018/1042, shall enter into force on 5 June 2020⁵.

Regulation (EU) 2020/1176, amending the dates of application of Regulation (EU) 2019/1387, shall enter into force on 11 August 2020⁶.

Regulation (EU) 2020/2036 shall enter into force on 1 January 2021⁷.

Regulation (EU) 2021/1296 shall enter into force on 25 August 2021⁸.

Regulation (EU) 2021/2237 shall enter into force on 5 January 2022⁹.

Regulation (EU) 2022/2203 shall enter into force on 4 December 2022¹⁰.

¹ Please consult [Regulation \(EU\) 2018/1042](#) for the official version.

² Please consult [Regulation \(EU\) 2018/1975](#) for the official version.

³ Please consult [Regulation \(EU\) 2019/1384](#) for the official version.

⁴ Please consult [Regulation \(EU\) 2019/1387](#) for the official version.

⁵ Please consult [Regulation \(EU\) 2020/745](#) for the official version.

⁶ Please consult [Regulation \(EU\) 2020/1176](#) for the official version.

⁷ Please consult [Regulation \(EU\) 2020/2036](#) for the official version.

⁸ Please consult [Regulation \(EU\) 2021/1296](#) for the official version.

⁹ Please consult [Regulation \(EU\) 2021/2237](#) for the official version.

¹⁰ Please consult [Regulation \(EU\) 2022/2203](#) for the official version.

Regulation (EU) No 965/2012

This Regulation shall be binding in its entirety and directly applicable in all Member States.

Done at Brussels, 5 October 2012.

For the Commission
The President
José Manuel BARROSO

ANNEX I – DEFINITIONS

Annex I Definitions for terms used in Annexes II to VIII

Regulation (EU) 2021/2237

For the purpose of this Regulation, the following definitions shall apply:

- (1) ‘accelerate-stop distance available (ASDA)’ means the length of the take-off run available plus the length of stopway, if such stopway is declared available by the State of the aerodrome and is capable of bearing the mass of the aeroplane under the prevailing operating conditions;
- (2) ‘acceptable means of compliance (AMC)’ means non-binding standards adopted by the Agency to illustrate means to establish compliance with Regulation (EC) No 216/2008 and its Implementing Rules;
- (3) ‘acceptance checklist’ means a document used to assist in carrying out a check on the external appearance of packages of dangerous goods and their associated documents to determine that all appropriate requirements have been met with;
- (4) ‘adequate aerodrome’ means an aerodrome on which the aircraft can be operated, taking account of the applicable performance requirements and runway characteristics;
- (5) For the purpose of passenger classification:
 - (a) ‘adult’ means a person of an age of 12 years and above;
 - (b) ‘child/children’ means persons who are of an age of two years and above but who are less than 12 years of age;
 - (c) ‘infant’ means a person under the age of two years;
- (6) ‘aerodrome operating minima’ means the limits of usability of an aerodrome for:
 - (a) take-off, expressed in terms of runway visual range (RVR) and/or visibility and, if necessary, ceiling;
 - (b) landing in 2D instrument approach operations, expressed in terms of visibility and/or RVR, minimum descent altitude/height (MDA/H) and, if necessary, ceiling;
 - (c) landing in 3D instrument approach operations, expressed in terms of visibility and/or RVR and decision altitude/height (DA/H) as appropriate to the type and/or category of the operation;
- (7) ‘aided night vision imaging system (NVIS) flight’ means, in the case of NVIS operations, that portion of a visual flight rules (VFR) flight performed at night when a crew member is using night vision goggles (NVG);
- (8) ‘aircraft’ means a machine that can derive support in the atmosphere from the reactions of the air other than the reactions of the air against the earth’s surface;
- (8a) ‘aircraft tracking’ means a ground based process that maintains and updates, at standardised intervals, a record of the four dimensional position of individual aircraft in flight;
- (8b) ‘aircraft tracking system’ means a system that relies on aircraft tracking in order to identify abnormal flight behaviour and provide alert;
- (8c) ‘alternate aerodrome’ means an adequate aerodrome to which an aircraft may proceed when it becomes either impossible or inadvisable to proceed to or land at the aerodrome of intended landing, where the necessary services and facilities are available, where aircraft performance

- requirements can be met, and which is operational at the expected time of use; ‘alternate aerodrome’ includes the following:
- (a) ‘take-off alternate aerodrome’: an alternate aerodrome at which an aircraft would be able to land if it becomes necessary shortly after take-off and it is not possible to use the aerodrome of departure;
 - (b) ‘en route alternate (ERA) aerodrome’: an alternate aerodrome at which an aircraft would be able to land if a diversion becomes necessary while en route;
 - (c) ‘fuel/energy en route alternate (fuel/energy ERA) aerodrome’ means an ERA aerodrome that is required at the planning stage for use in the calculation of fuel/energy;
 - (d) ‘destination alternate aerodrome’: an alternate aerodrome at which an aircraft would be able to land if it becomes either impossible or inadvisable to land at the aerodrome of intended landing;
- (9) ‘alternative means of compliance’ means those means that propose an alternative to an existing acceptable means of compliance or those that propose new means to establish compliance with Regulation (EC) No 216/2008 and its Implementing Rules for which no associated AMC have been adopted by the Agency;
- (10) ‘anti-icing’, in the case of ground procedures, means a procedure that provides protection against the formation of frost or ice and accumulation of snow on treated surfaces of the aircraft for a limited period of time (hold-over time);
- (11) [deleted with Reg. (EU) 2021/2237]
- (11a) [deleted with Reg. (EU) 2018/1975]
- (12) ‘cabin crew member’ means an appropriately qualified crew member, other than a flight crew or technical crew member, who is assigned by an operator to perform duties related to the safety of passengers and flight during operations;
- (13) [deleted with Reg. (EU) 2021/2237]
- (14) [deleted with Reg. (EU) 2021/2237]
- (15) [deleted with Reg. (EU) 2021/2237]
- (16) [deleted with Reg. (EU) 2021/2237]
- (17) ‘category A with respect to helicopters’ means a multi-engined helicopter designed with engine and system isolation features specified in the applicable certification specification and capable of operations using take-off and landing data scheduled under a critical engine failure concept that assures adequate designated surface area and adequate performance capability for continued safe flight or safe rejected take-off in the event of engine failure;
- (18) ‘category B with respect to helicopters’ means a single-engined or multi-engined helicopter that does not meet category A standards. Category B helicopters have no guaranteed capability to continue safe flight in the event of an engine failure, and unscheduled landing is assumed;
- (18a) ‘ceiling’ means the height above the ground or water of the base of the lowest layer of cloud below 6 000 m (20 000 ft) covering more than half the sky;
- (19) ‘certification specifications’ (CS) means technical standards adopted by the Agency indicating means to show compliance with Regulation (EC) No 216/2008 and its Implementing Rules and which can be used by an organisation for the purpose of certification;
- (20) ‘circling’ means the visual phase of a circling approach operation;

-
- (20a) ‘circling approach operation’ means a Type A instrument approach operation to bring an aircraft into position for landing on a runway/final approach and take-off area (FATO) that is not suitably located for a straight-in approach;
- (21) ‘clearway’ means a defined rectangular area on the ground or water under the control of the appropriate authority, selected or prepared as a suitable area over which an aeroplane may make a portion of its initial climb to a specified height;
- (22) ‘cloud base’ means the height of the base of the lowest observed or forecast cloud element in the vicinity of an aerodrome or operating site or within a specified area of operations, normally measured above aerodrome elevation or, in the case of offshore operations, above mean sea level;
- (22a) ‘cockpit voice recorder (CVR)’ means a crash-protected flight recorder that uses a combination of microphones and other audio and digital inputs to collect and record the aural environment of the flight crew compartment and communications to, from and between the flight crew members;
- (23) ‘code share’ means an arrangement under which an operator places its designator code on a flight operated by another operator, and sells and issues tickets for that flight;
- (23a) ‘competency’ means a dimension of human performance that is used to reliably predict successful performance on the job and which is manifested and observed through behaviours that mobilise the relevant knowledge, skills and attitudes to carry out activities or tasks under specified conditions;
- (23b) ‘competency-based training’ means assessment and training programmes that are characterised by a performance orientation, emphasis on standards of performance and their measurement and the development of training to the specified performance standards;
- (23c) ‘competency framework’ means a complete set of identified competencies that are developed, trained and assessed in the operator’s evidence-based training programme utilising scenarios that are relevant to operations and which is wide enough to prepare the pilot for both foreseen and unforeseen threats and errors;
- (24) ‘congested area’ means in relation to a city, town or settlement, any area which is substantially used for residential, commercial or recreational purposes;
- (25) ‘contaminated runway’ means a runway of which a significant portion of its surface area (whether in isolated areas or not) within the length and width being used is covered by one or more of the substances listed under the runway surface condition descriptors;
- (26) ‘contingency fuel/energy’ means the fuel/energy required to compensate for unforeseen factors that could have an influence on the fuel/energy consumption to the destination aerodrome;
- (27) ‘continuous descent final approach (CDFA)’ means a technique, consistent with stabilised approach procedures, for flying the final approach segment (FAS) of an instrument non-precision approach (NPA) procedure as a continuous descent, without level-off, from an altitude/height at or above the final approach fix altitude/height:
- (a) for straight-in approach operations, to a point approximately 15 m (50 ft) above the landing runway threshold or the point where the flare manoeuvre begins; or
 - (b) for circling approach operations, until MDA/H or visual flight manoeuvre altitude/height is reached;

-
- (28) ‘converted meteorological visibility (CMV)’ means a value, equivalent to an RVR, which is derived from the reported meteorological visibility;
- (29) ‘crew member’ means a person assigned by an operator to perform duties on board an aircraft;
- (30) ‘critical phases of flight’ in the case of aeroplanes means the take-off run, the take-off flight path, the final approach, the missed approach, the landing, including the landing roll, and any other phases of flight as determined by the pilot-in-command or commander;
- (31) ‘critical phases of flight’ in the case of helicopters means taxiing, hovering, take-off, final approach, missed approach, the landing and any other phases of flight as determined by the pilot-in-command or commander;
- (31a) ‘current fuel/energy scheme’ means the approved fuel/energy scheme that is currently used by the operator;
- (32) [deleted with Reg. (EU) 2019/1387]
- (33) ‘dangerous goods (DG)’ means articles or substances which are capable of posing a risk to health, safety, property or the environment and which are shown in the list of dangerous goods in the technical instructions or which are classified according to those instructions;
- (34) ‘dangerous goods accident’ means an occurrence associated with and related to the transport of dangerous goods by air which results in fatal or serious injury to a person or major property damage;
- (35) ‘dangerous goods incident’ means:
- (a) an occurrence other than a dangerous goods accident associated with and related to the transport of dangerous goods by air, not necessarily occurring on board an aircraft, which results in injury to a person, property damage, fire, breakage, spillage, leakage of fluid or radiation or other evidence that the integrity of the packaging has not been maintained;
 - (b) any occurrence relating to the transport of dangerous goods which seriously jeopardises an aircraft or its occupants;
- (35a) ‘decision altitude (DA) or decision height (DH)’ means a specified altitude or height in a 3D instrument approach operation at which a missed approach procedure must be initiated if the required visual reference to continue the approach has not been established;
- (36) ‘de-icing’, in the case of ground procedures, means a procedure by which frost, ice, snow or slush is removed from an aircraft in order to provide uncontaminated surfaces;
- (37) ‘defined point after take-off (DPATO)’ means the point, within the take-off and initial climb phase, before which the helicopter’s ability to continue the flight safely, with the critical engine inoperative, is not assured and a forced landing may be required;
- (38) ‘defined point before landing (DPBL)’ means the point within the approach and landing phase, after which the helicopter’s ability to continue the flight safely, with the critical engine inoperative, is not assured and a forced landing may be required;
- (39) ‘distance DR’ means the horizontal distance that the helicopter has travelled from the end of the take-off distance available;
- (40) ‘dry lease agreement’ means an agreement between undertakings pursuant to which the aircraft is operated under the air operator certificate (AOC) of the lessee or, in the case of commercial operations other than CAT, under the responsibility of the lessee;
- (41) ‘dry operating mass’ means the total mass of the aircraft ready for a specific type of operation, excluding usable fuel and traffic load;

-
- (42) 'dry runway' means a runway whose surface is free of visible moisture and not contaminated within the area intended to be used;
- (42a) 'EFB application' means a software application installed on an EFB host platform that provides one or more specific operational functions which support flight operations;
- (42b) 'EFB host platform' means the hardware equipment in which the computing capabilities and basic software reside, including the operating system and the input/output software;
- (42c) 'EFB system' means the hardware equipment (including any battery, connectivity provisions, input/output components) and software (including databases and the operating system) needed to support the intended EFB application(s);
- (42d) 'EBT module' means a combination of sessions in a qualified flight simulation training device as part of the 3-year period of recurrent assessment and training;
- (43) 'ELA1 aircraft' means the following manned European Light Aircraft:
- (a) an aeroplane with a Maximum Take-off Mass (MTOM) of 1 200 kg or less that is not classified as complex motor-powered aircraft;
 - (b) a sailplane or powered sailplane of 1 200 kg MTOM or less;
 - (c) a balloon with a maximum design lifting gas or hot air volume of not more than 3400 m³ for hot air balloons, 1 050 m³ for gas balloons, 300 m³ for tethered gas balloons;
- (44) 'ELA2 aircraft' means the following manned European Light Aircraft:
- (a) an aeroplane with a Maximum Take-off Mass (MTOM) of 2 000 kg or less that is not classified as complex motor-powered aircraft;
 - (b) a sailplane or powered sailplane of 2 000 kg MTOM or less;
 - (c) a balloon;
 - (d) a Very Light Rotorcraft with a MTOM not exceeding 600 kg which is of a simple design, designed to carry not more than two occupants, not powered by turbine and/or rocket engines; restricted to VFR day operations;
- (44a) 'electronic flight bag (EFB)' means an electronic information system, comprised of equipment and applications for flight crew, which allows for the storing, updating, displaying and processing of EFB functions to support flight operations or duties;
- (45) 'elevated final approach and take-off area (elevated FATO)' means a FATO that is at least 3 m above the surrounding surface;
- (45a) 'emergency exit' means an installed exit-type egress point from the aircraft that allows maximum opportunity for cabin and flight crew compartment evacuation within an appropriate time period and includes floor level door, window exit or any other type of exit, for instance hatch in the flight crew compartment and tail cone exit;
- (46) 'enhanced flight vision system (EFVS)' is an electronic means to provide the flight crew with a real-time sensor-derived or enhanced display of the external scene topography (the natural or man-made features of a place or region especially in a way to show their relative positions and elevation) through the use of imaging sensors; an EFVS is integrated with a flight guidance system and is implemented on a head-up display or an equivalent display system; if an EFVS is certified according to the applicable airworthiness requirements and an operator holds the necessary specific approval (when required), then it may be used for EFVS operations and may allow operations with operational credits;

-
- (46a) ‘EFVS operation’ means an operation in which visibility conditions require an EFVS to be used instead of natural vision in order to perform an approach or landing, identify the required visual references or conduct a roll-out;
- (46b) ‘EFVS 200 operation’ means an operation with an operational credit in which visibility conditions require an EFVS to be used down to 200 ft above the FATO or runway threshold. From that point to land, natural vision is used. The RVR shall not be less than 550 m;
- (47) ‘enhanced vision system (EVS)’ is an electronic means to provide the flight crew with a real-time image of the actual external scene topography (the natural or man-made features of a place or region especially in a way to show their relative positions and elevation) through the use of imaging sensors;
- (47a) ‘enrolment’ means the administrative action carried out by the operator where a pilot participates in the operator’s EBT programme;
- (47b) ‘enrolled pilot’ means the pilot that participates in the EBT recurrent training programme;
- (47c) ‘equivalency of approaches’ means all the approaches that place an additional demand on a proficient crew regardless of whether they are used or not in the EBT modules;
- (47d) ‘equivalency of malfunctions’ means all the malfunctions that put a significant demand on a proficient crew regardless of whether they are used or not in the EBT modules;
- (47e) ‘evaluation phase’ means one of the phases of an EBT module which is a line-orientated flight scenario, representative of the operator’s environment during which there are one or more occurrences to evaluate key elements of the defined competency framework;
- (47f) ‘evidence-based training (EBT)’ means assessment and training based on operational data that is characterised by developing and assessing the overall capability of a pilot across a range of competencies (competency framework) rather than by measuring the performance in individual events or manoeuvres;
- (48) ‘final approach and take-off area (FATO)’ means a defined area for helicopter operations, over which the final phase of the approach manoeuvre to hover or land is completed, and from which the take-off manoeuvre is commenced. In the case of helicopters operating in performance class 1, the defined area includes the rejected take-off area available;
- (48a) ‘flight crew member’ means a licensed crew member charged with duties essential to the operation of an aircraft during a flight duty period;
- (48b) ‘final approach segment (FAS)’ means that segment of an instrument approach procedure (IAP) in which alignment and descent for landing are accomplished;
- (49) ‘flight data monitoring (FDM)’ means the proactive and non-punitive use of digital flight data from routine operations to improve aviation safety;
- (49a) ‘flight operations officer’ or ‘flight dispatcher’ means a person designated by the operator to engage in the control and supervision of flight operations, who is suitably qualified, who supports, briefs or assists, or both, the pilot-in-command in the safe conduct of the flight;
- (49b) ‘flight data recorder (FDR)’ means a crash-protected flight recorder that uses a combination of data sources to collect and record parameters that reflect the state and performance of the aircraft;
- (49c) ‘flight recorder’ means any type of recorder that is installed on the aircraft for the purpose of facilitating accident or incident safety investigations;

- (49d) ‘flight following’ means the recording in real time of departure and arrival messages by operational personnel to ensure that a flight is operating and has arrived at the destination aerodrome or an alternate aerodrome;
- (49e) ‘flight monitoring’ means, in addition to the requirements defined for flight following:
- (a) operational monitoring of flights by suitably qualified operational-control personnel from departure throughout all phases of the flight;
 - (b) communication of all available and relevant safety information between the operational-control personnel on the ground and the flight crew; and
 - (c) critical assistance to the flight crew in the event of an in-flight emergency or security issue, or at the request of the flight crew;
- (50) ‘flight simulation training device (FSTD)’ means a training device which is:
- (a) in the case of aeroplanes, a full flight simulator (FFS), a flight training device (FTD), a flight and navigation procedures trainer (FNPT), or a basic instrument training device (BITD);
 - (b) in the case of helicopters, a full flight simulator (FFS), a flight training device (FTD) or a flight and navigation procedures trainer (FNPT);
- (50a) ‘flight time’ means:
- (a) for aeroplanes, the total time from the moment an aeroplane first moves for the purpose of taking off until the moment the aeroplane finally comes to rest at the end of the flight;
 - (b) for helicopters, the total time between the moment a helicopter’s rotor blades start turning for the purpose of taking off until the moment the helicopter finally comes to rest at the end of the flight, and the rotor blades are stopped;
- (50b) ‘flight watch’ means, in addition to all elements defined for ‘flight monitoring’, the active tracking of a flight by suitably qualified operational-control personnel throughout all phases of the flight to ensure that the flight is following its prescribed route without unplanned deviations, diversions or delays;
- (52) ‘GBAS landing system (GLS)’ means an approach landing system using ground based augmented global navigation satellite system (GNSS/GBAS) information to provide guidance to the aircraft based on its lateral and vertical GNSS position. It uses geometric altitude reference for its final approach slope;
- (52a) ‘go-around’ means a transition from an approach operation to a stabilised climb. This includes manoeuvres conducted at or above the MDA/H or DA/H, or below the DA/H (balked landings);
- (53) ‘ground emergency service personnel’ means any ground emergency service personnel (such as policemen, firemen, etc.) involved with helicopter emergency medical services (HEMSs) and whose tasks are to any extent pertinent to helicopter operations;
- (54) ‘grounding’ means the formal prohibition of an aircraft to take-off and the taking of such steps as are necessary to detain it;
- (55) ‘head-up display landing system (HUDLS)’ means the total airborne system which provides head-up guidance to the pilot to enable the pilot to either control the aircraft or to monitor the autopilot during take-off (if applicable), approach and landing (and roll-out if applicable), or go-around. It includes all the sensors, computers, power supplies, indications and controls;
- (56) [deleted with Reg. (EU) 2021/2237]
- (57) [deleted with Reg. (EU) 2018/1975]

-
- (58) ‘helicopter hoist operation (HHO) crew member’ means a technical crew member who performs assigned duties relating to the operation of a hoist;
- (59) ‘helideck’ means a FATO located on a floating or fixed offshore structure;
- (60) ‘HEMS crew member’ means a technical crew member who is assigned to a HEMS flight for the purpose of attending to any person in need of medical assistance carried in the helicopter and assisting the pilot during the mission;
- (61) ‘HEMS flight’ means a flight by a helicopter operating under a HEMS approval, the purpose of which is to facilitate emergency medical assistance, where immediate and rapid transportation is essential, by carrying:
- (a) medical personnel;
 - (b) medical supplies (equipment, blood, organs, drugs); or
 - (c) ill or injured persons and other persons directly involved;
- (62) ‘HEMS operating base’ means an aerodrome at which the HEMS crew members and the HEMS helicopter may be on stand-by for HEMS operations;
- (63) ‘HEMS operating site’ means a site selected by the commander during a HEMS flight for helicopter hoist operations, landing and take-off;
- (64) ‘HHO flight’ means a flight by a helicopter operating under an HHO approval, the purpose of which is to facilitate the transfer of persons and/or cargo by means of a helicopter hoist;
- (65) ‘HHO offshore’ means a flight by a helicopter operating under an HHO approval, the purpose of which is to facilitate the transfer of persons and/or cargo by means of a helicopter hoist from or to a vessel or structure in a sea area or to the sea itself;
- (66) ‘HHO passenger’ means a person who is to be transferred by means of a helicopter hoist;
- (67) ‘HHO site’ means a specified area at which a helicopter performs a hoist transfer;
- (68) ‘hold-over time (HoT)’ means the estimated time the anti-icing fluid will prevent the formation of ice and frost and the accumulation of snow on the protected (treated) surfaces of an aeroplane;
- (69) ‘hostile environment’ means:
- (a) an area in which:
 - (i) a safe forced landing cannot be accomplished because the surface is inadequate; or
 - (ii) the helicopter occupants cannot be adequately protected from the elements; or
 - (iii) search and rescue response/capability are not provided consistent with anticipated exposure; or
 - (iv) there is an unacceptable risk of endangering persons or property on the ground;
 - (b) in any case, the following areas:
 - (i) for overwater operations, the open sea area north of 45 N and south of 45 S, unless any part is designated as non-hostile by the responsible authority of the State in which the operations take place; and
 - (ii) those parts of a congested area without adequate safe forced landing areas;

- (69a) ‘human–machine interface (HMI)’ means a component of certain devices that is capable of handling human–machine interactions. The interface consists of hardware and software that allow user inputs to be interpreted and processed by machines or systems that, in turn, provide the required results to the user;
- (69b) ‘in-seat instruction’ means a technique used in the manoeuvres training phase or the scenario-based training phase, where the instructors can:
- (a) provide simple instructions to one pilot; or
 - (b) perform predetermined exercises acting, in a pilot seat, as pilot flying (PF) or pilot monitoring (PM) for:
 - (1) the demonstration of techniques; and/or
 - (2) triggering the other pilot to intervene or interact;
- (69c) ‘instructor concordance’ means the consistency or stability of scores between different EBT instructors which gives a score (or scores) of how much homogeneity, or consensus, there is in the ratings given by instructors (raters);
- (69d) ‘instrument approach operation’ means an approach and landing using instruments for navigation guidance based on an instrument approach procedure (IAP). There are two methods for executing instrument approach operations:
- (a) a two-dimensional (2D) instrument approach operation, using lateral navigation guidance only; and
 - (b) a three-dimensional (3D) instrument approach operation, using both lateral and vertical navigation guidance;
- (69e) ‘instrument approach procedure (IAP)’ means a series of predetermined manoeuvres by reference to flight instruments with specified protection from obstacles from the initial approach fix or, where applicable, from the beginning of a defined arrival route to a point from which a landing can be completed and thereafter, if a landing is not completed, to a position at which holding or en-route obstacle clearance criteria apply. IAPs are classified as follows:
- (a) non-precision approach (NPA) procedure, which means an IAP designed for 2D instrument approach operations Type A;
 - (b) approach procedure with vertical guidance (APV) means a performance-based navigation (PBN) IAP designed for 3D instrument approach operations Type A;
 - (c) precision approach (PA) procedure means an IAP based on navigation systems designed for 3D instrument approach operations Type A or B;
- (70) ‘landing decision point (LDP)’ means the point used in determining landing performance from which, an engine failure having been recognised at this point, the landing may be safely continued or a bailed landing initiated;
- (70a) ‘landing distance at time of arrival (LDTA)’ means a landing distance that is achievable in normal operations based on landing performance data and associated procedures determined for the prevailing conditions at the time of landing;
- (71) ‘landing distance available (LDA)’ means the length of the runway which is declared available by the State of the aerodrome and suitable for the ground run of an aeroplane landing;
- (72) ‘landplane’ means a fixed wing aircraft which is designed for taking off and landing on land and includes amphibians operated as landplanes;

-
- (72a) ‘line-orientated flight scenario’ means the assessment and training involving a realistic, ‘real-time’, full mission simulation of scenarios that are representative of line operations;
- (72b) ‘line check’ means a check conducted by the operator and completed by the pilot or the technical crew member to demonstrate competence in carrying out normal line operations described in the operations manual;
- (73) ‘local helicopter operation (LHO)’ means a commercial air transport operation of helicopters with a maximum certified take-off mass (MCTOM) over 3 175 kg and a maximum operational passenger seating configuration (MOPSC) of nine or less, by day, over routes navigated by reference to visual landmarks, conducted within a local and defined geographical area specified in the operations manual;
- (74) ‘low-visibility operations (LVOs)’ means approach or take-off operations on a runway with a runway visual range less than 550 m or with a decision height less than 200 ft;
- (75) ‘low-visibility take-off (LVTO)’ means a take-off with an RVR less than 550 m;
- (76) [deleted with Reg. (EU) 2021/2237]
- (76a) ‘maintenance check flight (‘MCF’)’ means a flight of an aircraft with an airworthiness certificate or with a permit to fly which is carried out for troubleshooting purposes or to check the functioning of one or more systems, parts or appliances after maintenance, if the functioning of the systems, parts or appliances cannot be established during ground checks and which is carried out in any of the following situations:
- (a) as required by the aircraft maintenance manual (‘AMM’) or any other maintenance data issued by a design approval holder being responsible for the continuing airworthiness of the aircraft;
 - (b) after maintenance, as required by the operator or proposed by the organisation responsible for the continuing airworthiness of the aircraft;
 - (c) as requested by the maintenance organisation for verification of a successful defect rectification;
 - (d) to assist with fault isolation or troubleshooting;
- (76b) ‘manoeuvres training phase’ means a phase of an EBT module during which, according to aircraft generation, crews have time to practise and improve performance in largely psychomotor skill-based exercises by achieving a prescribed flight path or performing a prescribed event to a prescribed outcome;
- (76c) ‘mixed EBT programme’ means an operator’s recurrent training and checking programme as per ORO.FC.230, a portion of which is dedicated to the application of EBT but which does not replace proficiency checks as per Appendix 9 to Annex I (Part-FCL) to Regulation (EU) No 1178/2011;
- (77) ‘maximum operational passenger seating configuration (MOPSC)’ means the maximum passenger seating capacity of an individual aircraft, excluding crew seats, established for operational purposes and specified in the operations manual. Taking as a baseline the maximum passenger seating configuration established during the certification process conducted for the type certificate (TC), supplemental type certificate (STC) or change to the TC or STC as relevant to the individual aircraft, the MOPSC may establish an equal or lower number of seats, depending on the operational constraints;
- (78) ‘medical passenger’ means a medical person carried in a helicopter during a HEMS flight, including but not limited to doctors, nurses and paramedics;

- (78a) ‘minor failure condition’ means a failure condition that would not significantly reduce aircraft safety, and which involves flight crew actions that are well within their capabilities;
- (78b) ‘misuse of substances’ means the use of one or more psychoactive substances by flight crew, cabin crew members and other safety-sensitive personnel in a way that:
- (a) constitutes a direct hazard to the user or endangers the lives, health or welfare of others, and/or
 - (b) causes or worsens an occupational, social, mental or physical problem or disorder;
- (78c) ‘minimum descent altitude (MDA) or minimum descent height (MDH)’ means a specified altitude or height in a 2D instrument approach operation or circling approach operation below which descent must not be made without the required visual reference;’
- (79) ‘night’ means the period between the end of evening civil twilight and the beginning of morning civil twilight or such other period between sunset and sunrise as may be prescribed by the appropriate authority, as defined by the Member State;
- (80) ‘night vision goggles (NVG)’ means a head-mounted, binocular, light intensification appliance that enhances the ability to maintain visual surface references at night;
- (81) ‘night vision imaging system (NVIS)’ means the integration of all elements required to successfully and safely use NVGs while operating a helicopter. The system includes as a minimum: NVGs, NVIS lighting, helicopter components, training and continuing airworthiness;
- (82) ‘non-hostile environment’ means an environment in which:
- (a) a safe forced landing can be accomplished;
 - (b) the helicopter occupants can be protected from the elements; and
 - (c) search and rescue response/capability is provided consistent with the anticipated exposure.
- In any case, those parts of a congested area with adequate safe forced landing areas shall be considered non-hostile;
- (83) [deleted with Reg. (EU) 2021/2237]
- (84) ‘NVIS crew member’ means a technical crew member assigned to an NVIS flight;
- (85) ‘NVIS flight’ means a flight under night visual meteorological conditions (VMC) with the flight crew using NVGs in a helicopter operating under an NVIS approval;
- (85a) ‘obstacle clearance altitude (OCA) or obstacle clearance height (OCH)’ means the lowest altitude or the lowest height above the elevation of the relevant runway threshold or the aerodrome elevation, as applicable, used in establishing compliance with the appropriate obstacle clearance criteria;
- (86) ‘offshore operation’ means a helicopter operation that has a substantial proportion of any flight conducted over open sea areas to or from an offshore location;
- (86a) ‘offshore location’ means a facility intended to be used for helicopter operations on a fixed or floating offshore structure or a vessel;
- (86b) ‘open sea area’ means the area of water to seaward of the coastline;
- (87) ‘operating site’ means a site, other than an aerodrome, selected by the operator or pilot-in-command or commander for landing, take-off and/or external load operations;

-
- (88) ‘operation in performance class 1’ means an operation that, in the event of failure of the critical engine, the helicopter is able to land within the rejected take-off distance available or safely continue the flight to an appropriate landing area, depending on when the failure occurs;
- (89) ‘operation in performance class 2’ means an operation that, in the event of failure of the critical engine, performance is available to enable the helicopter to safely continue the flight, except when the failure occurs early during the take-off manoeuvre or late in the landing manoeuvre, in which cases a forced landing may be required;
- (90) ‘operation in performance class 3’ means an operation that, in the event of an engine failure at any time during the flight, a forced landing may be required in a multi-engined helicopter and will be required in a single-engined helicopter;
- (91) ‘operational control’ means the responsibility for the initiation, continuation, termination or diversion of a flight in the interest of safety;
- (91a) ‘operational credit’ means a credit for operations with an advanced aircraft enabling lower aerodrome operating minima than would normally be established by the operator for a basic aircraft, based upon the performance of advanced aircraft systems utilising the available external infrastructure. Lower operating minima may include a lower decision height/altitude or minimum descent height/altitude, reduced visibility requirements or reduced ground facilities or a combination of these;
- (92) ‘operator proficiency check’ means a check conducted by the operator and completed by the pilot or the technical crew member to demonstrate competence in carrying out normal, abnormal and emergency procedures;
- (93) ‘performance class A aeroplanes’ means multi-engined aeroplanes powered by turbo-propeller engines with an MOPSC of more than nine or a maximum take-off mass exceeding 5 700 kg, and all multi-engined turbo-jet powered aeroplanes;
- (94) ‘performance class B aeroplanes’ means aeroplanes powered by propeller engines with an MOPSC of nine or less and a maximum take-off mass of 5 700 kg or less;
- (95) ‘performance class C aeroplanes’ means aeroplanes powered by reciprocating engines with an MOPSC of more than nine or a maximum take-off mass exceeding 5 700 kg;
- (95a) ‘personnel-carrying device system (PCDS)’ means a system including one or more devices that is either attached to a hoist or cargo hook or mounted to the rotorcraft airframe during human external cargo (HEC) or helicopter hoist operations (HHO). The devices have the structural capability and features needed to transport occupants external to the helicopter e.g. a life safety harness with or without a quick release and stop with a connector ring, a rigid basket or a cage;
- (95b) ‘simple personnel carrying device system (simple ‘PCDS’)’ means a PCDS that complies with the following conditions:
- (a) meets a harmonised standard under Regulation (EU) 2016/425 of the European Parliament and of the Council¹ or Directive 2006/42/EC of the European Parliament and of the Council²;

¹ Regulation (EU) 2016/425 of the European Parliament and of the Council of 9 March 2016 on personal protective equipment and repealing Council Directive 89/686/EEC (OJ L 81, 31.3.2016, p. 51).

² Directive 2006/42/EC of the European Parliament and of the Council of 17 May 2006 on machinery, and amending Directive 95/16/EC (OJ L 157, 9.6.2006, p. 24).

- (b) is designed to restrain no more than a single person (for instance, hoist or cargo hook operator, task specialist or photographer) inside the cabin, or to restrain no more than two persons outside the cabin;
 - (c) is not a rigid structure such as a cage, a platform or a basket;
- (96) ‘pilot-in-command’ means the pilot designated as being in command and charged with the safe conduct of the flight. For the purpose of commercial air transport operations, the ‘pilot-in-command’ shall be termed the ‘commander’;
- (96a) ‘portable EFB’ means a portable EFB host platform, used on the flight deck, which is not part of the configuration of the certified aircraft;
- (96b) ‘portable electronic device (PED)’ means any kind of electronic device, typically but not limited to consumer electronics, brought on board the aircraft by crew members, passengers, or as part of the cargo, that is not included in the configuration of the certified aircraft. It includes all equipment that is able to consume electrical energy. The electrical energy can be provided from internal sources such as batteries (chargeable or non-rechargeable) or the devices may also be connected to specific aircraft power sources;
- (97) ‘principal place of business’ means the head office or registered office of the organisation within which the principal financial functions and operational control of the activities referred to in this Regulation are exercised;
- (98) ‘prioritisation of ramp inspections’ means the dedication of an appropriate portion of the total number of ramp inspections conducted by or on behalf of a competent authority on an annual basis as provided in Part-ARO;
- (98a) ‘proficient’ means having demonstrated the necessary skills, knowledge and attitudes that are required to perform any defined tasks to the prescribed standard;
- (98b) ‘psychoactive substances’ means alcohol, opioids, cannabinoids, sedatives and hypnotics, cocaine, other psychostimulants, hallucinogens, and volatile solvents, with the exception of caffeine and tobacco;
- (99) ‘public interest site (PIS)’ means a site used exclusively for operations in the public interest;
- (100) ‘ramp inspection’ means the inspection of aircraft, of flight and cabin crew qualifications and of flight documentation in order to verify the compliance with the applicable requirements;
- (101) ‘rectification interval’ means a limitation on the duration of operations with inoperative equipment;
- (102) ‘rejected take-off distance available (RTODAH)’ means the length of the final approach and take-off area declared available and suitable for helicopters operated in performance class 1 to complete a rejected take-off;
- (103) ‘rejected take-off distance required (RTODRH)’ means the horizontal distance required from the start of the take-off to the point where the helicopter comes to a full stop following an engine failure and rejection of the take-off at the take-off decision point;
- (103a) ‘required navigation performance (RNP) specification’ means a navigation specification for PBN operations which includes a requirement for on-board navigation performance monitoring and alerting;

- (103b) 'rules of the air' means the rules established in Commission Implementing Regulation (EU) No 923/2012¹;
- (103c) 'runway condition report (RCR)' means a comprehensive standardised report relating to the conditions of the runway surface and their effect on the aeroplane landing and take-off performance, described by means of runway conditions code;
- (104) 'runway visual range (RVR)' means the range over which the pilot of an aircraft on the centre line of a runway can see the runway surface markings or the lights delineating the runway or identifying its centre line;
- (104a) 'safe landing' means, in the context of the fuel/energy policy or fuel/energy schemes, a landing at an adequate aerodrome or operating site with no less than the final reserve fuel/energy remaining and in compliance with the applicable operational procedures and aerodrome operating minima;
- (105) 'safe forced landing' means an unavoidable landing or ditching with a reasonable expectancy of no injuries to persons in the aircraft or on the surface;
- (105a) 'safety-sensitive personnel' means persons who might endanger aviation safety if they perform their duties and functions improperly, including flight crew and cabin crew members, aircraft maintenance personnel and air traffic controllers;
- (105b) 'scenario-based training phase' means a phase of an EBT module which focuses on the development of competencies, whilst the pilot is trained to mitigate the most critical risks identified for the aircraft generation. It should include the management of specific operator's threats and errors in a real-time line orientated environment;
- (106) 'seaplane' means a fixed wing aircraft which is designed for taking off and landing on water and includes amphibians operated as seaplanes;
- (107) 'separate runways' means runways at the same aerodrome that are separate landing surfaces. These runways may overlay or cross in such a way that if one of the runways is blocked, it will not prevent the planned type of operations on the other runway. Each runway shall have a separate approach procedure based on a separate navigation aid;
- (107a) 'specially prepared winter runway' means a runway with a dry frozen surface of compacted snow or ice which has been treated with sand or grit or has been mechanically treated to improve runway friction;
- (108) 'special VFR flight' means a VFR flight cleared by air traffic control to operate within a control zone in meteorological conditions below VMC;
- (109) 'stabilised approach (SAp)' means an approach that is flown in a controlled and appropriate manner in terms of configuration, energy and control of the flight path from a pre-determined point or altitude/height down to a point 50 ft above the threshold or the point where the flare manoeuvre is initiated if higher;
- (109a) 'sterile flight crew compartment' means any period of time when the flight crew members are not disturbed or distracted, except for matters critical to the safe operation of the aircraft or the safety of the occupants;

¹ Commission Implementing Regulation (EU) No 923/2012 of 26 September 2012 laying down the common rules of the air and operational provisions regarding services and procedures in air navigation and amending Implementing Regulation (EU) No 1035/2011 and Regulations (EC) No 1265/2007, (EC) No 1794/2006, (EC) No 730/2006, (EC) No 1033/2006 and (EU) No 255/2010 (OJ L 281, 13.10.2012, p. 1).

-
- (110) ‘take-off alternate aerodrome’ means an alternate aerodrome at which an aircraft can land should this become necessary shortly after take-off and if it is not possible to use the aerodrome of departure;
- (111) ‘take-off decision point (TDP)’ means the point used in determining take-off performance from which, an engine failure having been recognised at this point, either a rejected take-off may be made or a take-off safely continued;
- (112) ‘take-off distance available (TODA)’ in the case of aeroplanes means the length of the take-off run available plus the length of the clearway, if provided;
- (113) ‘take-off distance available (TODAH)’ in the case of helicopters means the length of the final approach and take-off area plus, if provided, the length of helicopter clearway declared available and suitable for helicopters to complete the take-off;
- (114) ‘take-off distance required (TODRH)’ in the case of helicopters means the horizontal distance required from the start of the take-off to the point at which take-off safety speed (V_{T0SS}), a selected height and a positive climb gradient are achieved, following failure of the critical engine being recognised at the TDP, the remaining engines operating within approved operating limits;
- (115) ‘take-off flight path’ means the vertical and horizontal path, with the critical engine inoperative, from a specified point in the take-off for aeroplanes to 1 500 ft above the surface and for helicopters to 1 000 ft above the surface;
- (116) ‘take-off mass’ means the mass including everything and everyone carried at the commencement of the take-off for helicopters and take-off run for aeroplanes;
- (117) ‘take-off run available (TORA)’ means the length of runway that is declared available by the State of the aerodrome and suitable for the ground run of an aeroplane taking off;
- (117a) ‘task specialist’ means a person assigned by the operator or a third party, or acting as an undertaking, who performs tasks on the ground directly associated with a specialised task or performs specialised tasks on board or from the aircraft;
- (118) ‘technical crew member’ means a crew member in commercial air transport HEMS, HHO or NVIS operations other than a flight or cabin crew member, assigned by the operator to duties in the aircraft or on the ground for the purpose of assisting the pilot during HEMS, HHO or NVIS operations, which may require the operation of specialised on-board equipment;
- (119) ‘technical instructions (TI)’ means the latest effective edition of the ‘Technical instructions for the safe transport of dangerous goods by air’, including the supplement and any addenda, approved and published by the International Civil Aviation Organisation;
- (120) ‘traffic load’ means the total mass of passengers, baggage, cargo and carry-on specialist equipment and including any ballast;
- (120a) ‘type A EFB application’ means an EFB application whose malfunction or misuse has no safety effect;
- (120b) ‘type B EFB application’ means an EFB application:
- (a) whose malfunction or misuse is classified as minor failure condition or below; and
 - (b) which neither replaces nor duplicates any system or functionality required by airworthiness regulations, airspace requirements, or operational rules;
- (120c) ‘training to proficiency’ means training designed to achieve end-state performance objectives, providing sufficient assurance that the trained individual is capable of consistently carrying out specific tasks safely and effectively;

- (120d) ‘Type A instrument approach operation’ means an instrument approach operation with an MDH or a DH at or above 250 ft;
- (120e) ‘Type B instrument approach operation’ means an operation with a DH below 250 ft. Type B instrument approach operations are categorised as:
- (a) Category I (CAT I): a DH not lower than 200 ft and with either a visibility not less than 800 m or an RVR not less than 550 m;
 - (b) Category II (CAT II): a DH lower than 200 ft but not lower than 100 ft, and an RVR not less than 300 m;
 - (c) Category III (CAT III): a DH lower than 100 ft or no DH, and an RVR less than 300 m or no RVR limitation;
- (121) ‘unaided NVIS flight’ means, in the case of NVIS operations, that portion of a VFR flight performed at night when a crew member is not using NVG;
- (122) ‘undertaking’ means any natural or legal person, whether profit-making or not, or any official body whether having its own personality or not;
- (123) ‘ V_1 ’ means the maximum speed in the take-off at which the pilot must take the first action to stop the aeroplane within the accelerate-stop distance. V_1 also means the minimum speed in the take-off, following a failure of the critical engine at V_{EF} , at which the pilot can continue the take-off and achieve the required height above the take-off surface within the take-off distance;
- (124) ‘ V_{EF} ’ means the speed at which the critical engine is assumed to fail during take-off;
- (124a) ‘visibility (VIS)’ means visibility for aeronautical purposes, which is the greater of:
- (a) the greatest distance at which a black object of suitable dimensions, situated near the ground, can be seen and recognised when observed against a bright background; and
 - (b) the greatest distance at which lights in the vicinity of 1 000 candelas can be seen and identified against an unlit background;
- (125) ‘visual approach operation’ means an approach operation by an IFR flight when either a part or all parts of an IAP is (are) not completed and the approach operation is executed with visual reference to terrain;
- (126) ‘weather-permissible aerodrome’ means an adequate aerodrome where, for the anticipated time of use, meteorological reports, or forecasts, or any combination thereof, indicate that the meteorological conditions will be at or above the required aerodrome operating minima, and the runway surface condition reports indicate that a safe landing will be possible;
- (127) ‘wet lease agreement’ means an agreement:
- in the case of CAT operations, between air carriers pursuant to which the aircraft is operated under the AOC of the lessor; or
 - in the case of commercial operations other than CAT, between operators pursuant to which the aircraft is operated under the responsibility of the lessor;
- (128) ‘wet runway’ means a runway whose surface is covered by any visible dampness or water up to and including 3 mm deep within the area intended to be used.

GM1 Annex I Definitions

ED Decision 2022/012/R

DEFINITIONS FOR TERMS USED IN ACCEPTABLE MEANS OF COMPLIANCE AND GUIDANCE MATERIAL

For the purpose of Acceptable Means of Compliance and Guidance Material to [Regulation \(EU\) No 965/2012](#), the following definitions should apply:

- (a) 'Abnormal flight behaviour' means, in the context of an aircraft tracking system, an event affecting a flight:
 - (1) which is outside of the parameters defined by the operator for normal operation or which indicates an obvious deviation from normal operation; and
 - (2) for which the operator has determined that it poses a risk for the safe continuation of the flight or for third parties.
- (a) 'Accuracy' means, in the context of PBN operations, the degree of conformance between the estimated, measured or desired position and/or the velocity of a platform at a given time, and its true position or velocity. Navigation performance accuracy is usually presented as a statistical measure of system error and is specified as predictable, repeatable and relative.
- (b) 'Aircraft-based augmentation system (ABAS)' means a system that augments and/or integrates the information obtained from the other GNSS elements with information available on board the aircraft. The most common form of ABAS is receiver autonomous integrity monitoring (RAIM).
- (ba) 'Airport moving map display (AMMD)' means a software application that displays an airport map on a display device and uses data from a navigation source to depict the aircraft current position on this map while the aircraft is on the ground.
- (c) 'Area navigation (RNAV)' means a method of navigation which permits aircraft operation on any desired flight path within the coverage of station-referenced navigation aids or within the limits of the capability of self-contained aids, or a combination of these.
- (d) 'Availability' means, in the context of PBN operations, an indication of the ability of the system to provide usable service within the specified coverage area and is defined as the portion of time during which the system is to be used for navigation during which reliable navigation information is presented to the crew, autopilot or other system managing the flight of the aircraft.
- (e) 'Committal point' means the point in the approach at which the pilot flying decides that, in the event of an engine failure being recognised, the safest option is to continue to the elevated final approach and take-off area (elevated FATO).
- (f) 'Continuity of function' means, in the context of PBN operations, the capability of the total system, comprising all elements necessary to maintain aircraft position within the defined airspace, to perform its function without non-scheduled interruptions during the intended operation.
- (fa) 'Controlled portable electronic device (C-PED)' means a PED subject to administrative control by the operator that uses it. This includes, inter alia, tracking the allocation of the devices to specific aircraft or persons and ensuring that no unauthorised changes are made to the hardware, software, or databases. C-PEDs can be assigned to the category of non-intentional transmitters or T-PEDs.

- (fb) ‘EFB installed resources’ means certified EFB hardware components external to the EFB host platform itself, such as input/output components (installed remote displays, keyboards, pointing devices, switches, etc.) or a docking station.
- (fc) ‘EFB mounting device’ means an aircraft certified part that secures a portable or installed EFB, or EFB system components.
- (fd) ‘EFB system supplier’ means the company responsible for developing, or for having developed, the EFB system or part of it.
- (g) ‘Emergency locator transmitter’ is a generic term describing equipment that broadcasts distinctive signals on designated frequencies for the purpose of search and rescue (SAR). The ELT may be activated by various conditions (e.g. manual activation, automatic detection of a distress situation, automatic detection of a crash impact, automatic detection of aircraft immersion into water, etc.). The ELT signals usually include signals that are intended to be detected by the international COSPAS-SARSAT programme, and homing signals that are intended to guide SAR teams to the ELT.
- (h) ‘Exposure time’ means the actual period during which the performance of the helicopter with the critical engine inoperative in still air does not guarantee a safe forced landing or the safe continuation of the flight.
- (i) ‘Fail-operational flight control system’ means a flight control system with which, in the event of a failure below alert height, the approach, flare and landing can be completed automatically. In the event of a failure, the automatic landing system will operate as a fail-passive system.
- (j) ‘Fail-operational hybrid landing system’ means a system that consists of a primary fail-passive automatic landing system and a secondary independent guidance system enabling the pilot to complete a landing manually after failure of the primary system.
- (k) ‘Fail-passive flight control system’: a flight control system is fail-passive if, in the event of a failure, there is no significant out-of-trim condition or deviation of flight path or attitude but the landing is not completed automatically. For a fail-passive automatic flight control system the pilot assumes control of the aeroplane after a failure.
- (l) ‘Flight control system’ in the context of low visibility operations means a system that includes an automatic landing system and/or a hybrid landing system.
- (m) ‘HEMS dispatch centre’ means a place where, if established, the coordination or control of the helicopter emergency medical service (HEMS) flight takes place. It may be located in a HEMS operating base.
- (n) ‘Hybrid head-up display landing system (hybrid HUDLS)’ means a system that consists of a primary fail-passive automatic landing system and a secondary independent HUD/HUDLS enabling the pilot to complete a landing manually after failure of the primary system.
- (na) ‘Installed EFB’ means an EFB host platform installed in an aircraft, capable of hosting type A and/or type B EFB applications. It may also host certified applications. It is an aircraft part, and, is therefore, covered by the aircraft airworthiness approval.
- (o) ‘Integrity’ means, in the context of PBN operations, the ability of a system to provide timely warnings to users when the system should not be used for navigation.
- (p) ‘Landing distance available (LDAH)’ means the length of the final approach and take-off area plus any additional area declared available by the State of the aerodrome and suitable for helicopters to complete the landing manoeuvre from a defined height.

- (q) ‘Landing distance required (LDRH)’, in the case of helicopters, means the horizontal distance required to land and come to a full stop from a point 15 m (50 ft) above the landing surface.
- (r) ‘Lateral navigation’ means a method of navigation which permits aircraft operation on a horizontal plane using radio navigation signals, other positioning sources, external flight path references, or a combination of these.
- (ra) ‘mass’ and ‘weight’: In accordance with ICAO Annex 5 and the International System of Units (SI), both terms are used to indicate the actual and limiting masses of aircraft, the payload and its constituent elements, the fuel load, etc. These are expressed in units of mass (kg), but in most approved flight manuals and other operational documentation, these quantities are published as weights in accordance with the common language. In the ICAO standardised system of units of measurement, a weight is a force rather than a mass. Since the use of the term ‘weight’ does not cause any problem in the day-to-day handling of aircraft, its continued use in operational applications and publications is acceptable.
- (s) ‘Maximum structural landing mass’ means the maximum permissible total aeroplane mass upon landing under normal circumstances.
- (t) ‘Maximum zero fuel mass’ means the maximum permissible mass of an aeroplane with no usable fuel. The mass of the fuel contained in particular tanks should be included in the zero fuel mass when it is explicitly mentioned in the aircraft flight manual.
- (ta) ‘Miscellaneous (non-EFB) software applications’ means non-EFB applications that support function(s) not directly related to the tasks performed by the flight crew in the aircraft.
- (u) ‘Overpack’, for the purpose of transporting dangerous goods, means an enclosure used by a single shipper to contain one or more packages and to form one handling unit for convenience of handling and stowage.
- (v) ‘Package’, for the purpose of transporting dangerous goods, means the complete product of the packing operation consisting of the packaging and its contents prepared for transport.
- (w) ‘Packaging’, for the purpose of transporting dangerous goods, means receptacles and any other components or materials necessary for the receptacle to perform its containment function.
- (x) ‘Personal locator beacon (PLB)’ is an emergency beacon other than an ELT that broadcasts distinctive signals on designated frequencies, is standalone, portable and is manually activated by the survivors.
- (xa) ‘Ramp inspection tool’ means the IT application including a centralised database used by all stakeholders to store and exchange data related to ramp inspections.
- (y) ‘Receiver autonomous integrity monitoring (RAIM)’ means a technique whereby a GNSS receiver/processor determines the integrity of the GNSS navigation signals using only GNSS signals or GNSS signals augmented with altitude. This determination is achieved by a consistency check among redundant pseudo-range measurements. At least one satellite in addition to those required for navigation has to be in view for the receiver to perform the RAIM function.
- (z) ‘Rotation point (RP)’ means the point at which a cyclic input is made to initiate a nose-down attitude change during the take-off flight path. It is the last point in the take-off path from which, in the event of an engine failure being recognised, a forced landing on the aerodrome can be achieved.

-
- (za) ‘Runway condition assessment matrix (RCAM)’ means a matrix that allows the assessment of the runway condition code (RWYCC), using associated procedures, from a set of observed runway surface condition(s) and pilot report of braking action.
- (zb) ‘Runway condition code (RWYCC)’ means a number, to be used in the runway condition report (RCR), that describes the effect of the runway surface condition on aeroplane deceleration performance and lateral control.
- (zc) ‘Runway surface condition’ means a description of the condition of the runway surface used in the RCR which establishes the basis for the determination of the RWYCC for aeroplane performance purposes.
- (zd) ‘Runway surface condition descriptors’ means one of the following elements on the surface of the runway:
- (1) ‘compacted snow’: snow that has been compacted into a solid mass such that aeroplane tyres, at operating pressures and loadings, will run on the surface without significant further compaction or rutting of the surface;
 - (2) ‘dry snow’: snow from which a snowball cannot readily be made;
 - (3) ‘frost’: ice crystals formed from airborne moisture on a surface whose temperature is at or below freezing; frost differs from ice in that the frost crystals grow independently and, therefore, have a more granular texture;
 - (4) ‘ice’: water that has frozen or compacted snow that has transitioned into ice in cold and dry conditions;
 - (5) ‘slush’: snow that is so water-saturated that water will drain from it when a handful is picked up or will splatter if stepped on forcefully;
 - (6) ‘standing water’: water of depth greater than 3 mm;
 - (7) ‘Wet ice’: ice with water on top of it or ice that is melting.
 - (8) ‘wet snow’: snow that contains enough water to be able to make a well compacted, solid snowball, but water will not squeeze out.
- (aaa) ‘Slippery wet runway’ means a wet runway where the surface friction characteristics of a significant portion of the runway have been determined to be degraded.
- (ab) ‘Touch down and lift-off area (TLOF)’ means a load-bearing area on which a helicopter may touch down or lift off.
- (ac) ‘Transmitting PED (T-PED)’ means a portable electronic device (PED) that has intentional radio frequency (RF) transmission capabilities.
- (ad) ‘Vertical navigation’ means a method of navigation which permits aircraft operation on a vertical flight profile using altimetry sources, external flight path references, or a combination of these.
- (ae) ‘Viewable stowage’ means a non-certified device that is attached to the flight crew member (e.g. with a kneeboard) or to an existing aircraft part (e.g. using suction cups), and is intended to hold charts or to hold low-mass portable electronic devices that are viewable by the flight crew members at their assigned duty stations.

GM2 Annex I Definitions

ED Decision 2022/012/R

ABBREVIATIONS AND ACRONYMS

The following abbreviations are used in the Annexes to this Regulation:

2D	two-dimensional
3D	three-dimensional
A	aeroplane
a/c	aircraft
AAC	aeronautical administrative communications
AAIM	aircraft autonomous integrity monitoring
AAL	above aerodrome level
ABAS	aircraft-based augmentation system
AC	advisory circular
AC	alternating current
ACAS	airborne collision avoidance system
ADF	automatic direction finder
ADG	air driven generator
ADS	automatic dependent surveillance
ADS-B	automatic dependent surveillance - broadcast
ADS-C	automatic dependent surveillance - contract
AEA	Association of European Airlines
AEO	all-engines-operative
AFFF	aqueous film forming foams
AFM	aircraft flight manual
AFN	aircraft flight notification
AFN	ATS facilities notification
AGL	above ground level
AHRS	attitude heading reference system
AIREP	air-report
AIS	aeronautical information service
ALAP	aerodrome landing analysis programme
ALARP	as low as reasonably practicable
ALD	actual landing distance
ALSF	approach lighting system with sequenced flashing lights
AMC	Acceptable Means of Compliance
AML	aircraft maintenance licence
AMSL	above mean sea level
ANP	actual navigation performance
AOC	aeronautical operational control
AOC	air operator certificate
APCH	approach
APP	approach
APU	auxiliary power unit
APV	approach procedure with vertical guidance
AR	authorisation required
ARA	airborne radar approach
ARA	Authority Requirements for Aircrew
A-RNP	advanced required navigation performance
ARO	Authority Requirements for Air Operations
ARP	Aerospace Recommended Practices
ASC	Air Safety Committee
ASDA	accelerate-stop distance available
ASE	altimeter system error

ATA	Air Transport Association
ATC	air traffic control
ATIS	automatic terminal information service
ATN	air traffic navigation
ATPL	airline transport pilot licence
ATQP	alternative training and qualification programme
ATS	air traffic services
ATSC	air traffic service communication
AVGAS	aviation gasoline
AVTAG	aviation turbine gasoline (wide-cut fuel)
AWO	all weather operations
BALS	basic approach lighting system
Baro VNAV	barometric VNAV
BCAR	British civil airworthiness requirements
BITD	basic instrument training device
CAP	controller access parameters
CAT	commercial air transport
CAT I / II / III	category I / II / III
CBT	computer-based training
CC	cabin crew
CDFA	continuous descent final approach
CDL	configuration deviation list
CFIT	controlled flight into terrain
CG	centre of gravity
CLB	climb
CM	context management
CMV	converted meteorological visibility
CofA	certificate of airworthiness
COM	communication (EBT competency)
COP	code of practice
CoR	certificate of registration
COSPAS-SARSAT	cosmicheskaya sistyema poiska avariynich sudov - search and rescue satellite-aided tracking
CP	committal point
CPA	closest point of approach
CPDLC	controller pilot data link communication
C-PED	controlled portable electronic device
CPL	commercial pilot licence
CRE	class rating examiner
CRI	class rating instructor
CRM	crew resource management
CRZ	cruise
CS	Certification Specifications
CSP	communication service provider
CVR	cockpit voice recorder
CVS	combined vision system
DA	decision altitude
DA/H	decision altitude/height
DAP	downlinked aircraft parameters
D-ATIS	digital automatic terminal information service
DC	direct current
DCL	departure clearance
DES	descent
D-FIS	data link flight information service
DG	dangerous goods

DH	decision height
DI	daily inspection
DIFF	deck integrated fire fighting system
DLR	data link recorder
DME	distance measuring equipment
D-METAR	data link - meteorological aerodrome report
D-OTIS	data link - operational terminal information service
DPATO	defined point after take-off
DPBL	defined point before landing
DR	decision range
DSTRK	desired track
EBT	evidence-based training
EC	European Community
ECAC	European Civil Aviation Conference
EFB	electronic flight bag
EFIS	electronic flight instrument system
EFVS	enhanced flight vision system
EFVS-A	enhanced flight vision system used for approach
EFVS-L	enhanced flight vision system used for landing
EGNOS	European geostationary navigation overlay service
EGT	exhaust gas temperature
ELT	emergency locator transmitter
ELT(AD)	emergency locator transmitter (automatically deployable)
ELT(AF)	emergency locator transmitter (automatic fixed)
ELT(DT)	emergency locator transmitter (distress tracking)
ELT(AP)	emergency locator transmitter (automatic portable)
ELT(S)	survival emergency locator transmitter
EPE	estimated position of error
EPR	engine pressure ratio
EPU	estimated position of uncertainty
ERA	en-route alternate (aerodrome)
ERP	emergency response plan
ETOPS	extended range operations with two-engined aeroplanes
EU	European Union
EUROCAE	European Organisation for Civil Aviation Equipment
EVAL	evaluation phase
EVS	enhanced vision system
FAA	Federal Aviation Administration
FAF	final approach fix
FALS	full approach lighting system
FANS	future air navigation systems
FAP	final approach point
FAR	Federal Aviation Regulation
FAS	final approach segment
FATO	final approach and take-off
FC	flight crew
FCL	flight crew licensing
FCOM	flight crew operating manual
FDM	flight data monitoring
FDO	flying display operation
FDR	flight data recorder
FFS	full flight simulator
FGS	flight control/guidance system
FI	flight instructor
FLIPCY	flight plan consistency

FLTA	forward-looking terrain avoidance
FMECA	failure mode, effects and criticality analysis
FMS	flight management system
FNPT	flight and navigation procedures trainer
FOD	foreign object damage
FOSA	flight operational safety assessment
FOV	field of view
FPA	flight path management — automation (EBT competency)
FPM	flight path management — manual control (EBT competency)
fpm	feet per minute
FRT	fixed radius transition
FSTD	flight simulation training device
ft	feet
FTD	flight training device
FTE	full time equivalent
FTE	flight technical error
FTL	flight and duty time limitations
g	gram
GAGAN	GPS aided geo augmented navigation
GBAS	ground-based augmentation system
GCAS	ground collision avoidance system
GEN	general
GIDS	ground ice detection system
GLS	GBAS landing system
GM	Guidance Material
GMP	general medical practitioner
GND	ground
GNSS	global navigation satellite system
GPS	global positioning system
GPWS	ground proximity warning system
H	helicopter
HEMS	helicopter emergency medical service
HF	high frequency
Hg	mercury
HHO	helicopter hoist operation
HIALS	high intensity approach lighting system
HIGE	hover in ground effect
HLL	helideck limitations list
HOGE	hover out of ground effect
HoT	hold-over time
hPa	hectopascals
HPL	human performance and limitations
HUD	head-up display
HUDLS	head-up guidance landing system
HUMS	health usage monitor system
IAF	initial approach fix
IALS	intermediate approach lighting system
IAP	instrument approach procedure
ICAO	International Civil Aviation Organization
IDE	instruments, data and equipment
IF	intermediate fix
IFR	instrument flight rules
IFSD	in-flight shutdown
IGE	in ground effect
ILS	instrument landing system

IMC	instrument meteorological conditions
in	inches
INS	inertial navigation system
IP	intermediate point
IR	Implementing Rule
IR	instrument rating
IRS	inertial reference system
ISA	international standard atmosphere
ISI	in-seat instruction
ISO	International Organization for Standardization
IV	intravenous
JAA	Joint Aviation Authorities
JAR	Joint Aviation Requirements
kg	kilograms
km	kilometres
KNO	application of knowledge (EBT competency)
kt	knots
LDA	landing distance available
LDF	landing distance factor
LDG	landing
LDP	landing decision point
LDTA	landing distance at time of arrival
LED	light-emitting diode
LHO	local helicopter operation
LHS	left-hand seat
LIFUS	line flying under supervision
LNAV	lateral navigation
LoA	letter of acceptance
LOC	localiser
LOC-I	loss of control in-flight
LOE	line-oriented evaluation
LOFT	line-oriented flight training
LOQE	line-oriented quality evaluation
LOS	limited obstacle surface
LP	Localiser performance
LPV	localiser performance with vertical guidance
LRCS	long range communication system
LRNS	long range navigation system
LSAA	landing system assessment area
LTW	Leadership and teamwork (EBT competency)
LVO	low visibility operation
LVP	low visibility procedures
LVTO	low visibility take-off
m	metres
MALS	medium intensity approach lighting system
MALSF	medium intensity approach lighting system with sequenced flashing lights
MALSR	medium intensity approach lighting system with runway alignment indicator lights
MAPt	missed approach point
MCTOM	maximum certified take-off mass
MDA	minimum descent altitude
MDH	minimum descent height
MEA	minimum en-route altitude
MED	medical
MEL	minimum equipment list
METAR	meteorological aerodrome report

MGA	minimum grid altitude
MHA	minimum holding altitude
MHz	megahertz
MID	midpoint
MLR	manuals, logs and records
MLS	microwave landing system
MLX	millilux
mm	millimetres
MM	multi-mode
MMEL	master minimum equipment list
MNPS	minimum navigation performance specifications
MOC	minimum obstacle clearance
MOCA	minimum obstacle clearance altitude
MOPSC	maximum operational passenger seating configuration
MORA	minimum off-route altitude
MPSC	maximum passenger seating capacity
MSA	minimum sector altitude
MSAS	multi-functional satellite augmentation system
MT	manoeuvres training phase
MTCA	minimum terrain clearance altitude
N	North
NADP	noise abatement departure procedure
NALS	no approach lighting system
NCC	non-commercial operations with complex motor-powered aircraft
NCO	non-commercial operations with other-than-complex motor-powered aircraft
N _F	free power turbine speed
N _G	engine gas generator speed
NM	nautical miles
NOTAM	notice to airmen
NOTECHS	non-technical skills evaluation
NOTOC	notification to captain
NPA	non-precision approach
NPA	Notice of Proposed Amendment
NSE	navigation system error
NVD	night vision device
NVG	night vision goggles
NVIS	night vision imaging system
OAT	outside air temperature
OB	observable behaviour
OCH	obstacle clearance height
OCL	oceanic clearance
ODALS	omnidirectional approach lighting system
OEI	one-engine-inoperative
OFS	obstacle-free surface
OFZ	obstacle free zone
OGE	out of ground effect
OIP	offset initiation point
OM	operations manual
OML	operational multi-pilot limitation
ONC	operational navigation chart
OPS	operations
ORO	Organisation Requirements for Air Operations
OTS CAT II	other than standard category II
PAPI	precision approach path indicator
PAR	precision approach radar

PBCS	performance-based communication and surveillance
PBE	protective breathing equipment
PBN	performance-based navigation
PC/PT	proficiency check/proficiency training
PCDS	personnel carrying device system
PDA	premature descent alert
PDP	predetermined point
PED	portable electronic device
PFC	porous friction course
PIC	pilot-in-command
PIN	personal identification number
PIS	public interest site
PLB	personal locator beacon
PNR	point of no return
POH	pilot's operating handbook
PRM	person with reduced mobility
PRO	application of procedures (EBT competency)
PSD	problem-solving & decision making (EBT competency)
PVD	paravirtual display
QAR	quick access recorder
QFE	atmospheric pressure at aerodrome elevation / runway threshold
QNH	atmospheric pressure at nautical height
RA	resolution advisory
RAIM	receiver autonomous integrity monitoring
RAT	ram air turbine
RCAM	runway condition assessment matrix
RCC	rescue coordination centre
RCF	reduced contingency fuel
RCLL	runway centre line lights
RCP	required communication performance
RCR	runway condition report
RF	radius to fix
RF	radio frequency
RFC	route facility chart
RI	ramp inspection
RI	rectification interval
RIE	rectification interval extension
RMA	regional monitoring agency
RNAV	area navigation
RNP	required navigation performance
RNP APCH	RNP approach
RNP AR APCH	RNP approach for which authorisation is required
ROD	rate of descent
RP	rotation point
RSP	required surveillance performance
RTCA	Radio Technical Commission for Aeronautics
RTODAH	rejected take-off distance available (helicopters)
RTODRH	rejected take-off distance required (helicopters)
RTOM	reduced take-off mass
RTZL	runway touchdown zone lights
RVR	runway visual range
RVSM	reduced vertical separation minima
RWYCC	runway condition code
S	South
SA CAT I	special authorisation category I

SA CAT II	special authorisation category II
SAFA	safety assessment of foreign aircraft
SALS	simple approach lighting system
SALSF	simple approach lighting system with sequenced flashing lights
SAP	stabilised approach
SAP	system access parameters
SAR	search and rescue
SAS	stability augmentation system
SAW	situation awareness (EBT competency)
SBAS	satellite-based augmentation system
SBT	scenario-based training
SCC	senior cabin crew
SCP	special category of passenger
SDCM	system of differential correction and monitoring
SFE	synthetic flight examiner
SFI	synthetic flight instructor
SID	standard instrument departure
SMM	safety management manual
SMS	safety management system
SNAS	satellite navigation augmentation system
SOP	standard operating procedure
SPA	operations requiring specific approvals
SPECI	aviation selected special weather report
SPO	specialised operations
SRA	surveillance radar approach
SSALF	simplified short approach lighting system with sequenced flashing lights
SSALR	simplified short approach lighting system with runway alignment indicator lights
SSALS	simplified short approach lighting system
SSEC	static source error correction
SSR	secondary surveillance radar
STAR	standard terminal arrival route
STC	supplemental type certificate
SVS	synthetic vision system
TA	traffic advisory
TAC	terminal approach chart
TAS	true airspeed
TAWS	terrain awareness warning system
TC	technical crew
TC	type certificate
TCAS	traffic collision avoidance system
TCCA	Transport Canada Civil Aviation
TCH	type certificate holder
TDP	take-off decision point
TDZ	touchdown zone
TDZE	touchdown zone elevation
THR	threshold
TI	Technical Instructions
TIT	turbine inlet temperature
TLS	target level of safety
TMG	touring motor glider
TO	take-off
TODA	take-off distance available (aeroplanes)
TODAH	take-off distance available (helicopters)
TODRH	take-off distance required (helicopters)
TOGA	take-off/go around

TORA	take-off run available
T-PED	transmitting portable electronic device
TRE	type rating examiner
TRI	type rating instructor
TSE	total system error
TVE	total vertical error
TWIP	terminal weather information for pilots
UMS	usage monitoring system
UPRT	upset prevention and recovery training
UTC	coordinated universal time
V ₂	take-off safety speed
V ₅₀	stalling speed
V _{AT}	indicated airspeed at threshold
VDF	VHF direction finder
VFR	visual flight rules
VHF	very high frequency
VIS	visibility
VMC	visual meteorological conditions
V _{MO}	maximum operating speed
VNAV	vertical navigation
VOR	VHF omnidirectional radio range
VSS	visual segment surface
V _T	threshold speed
VTOL	vertical take-off and landing
V _{TOSS}	take-off safety speed
WAAS	wide area augmentation system
WAC	world aeronautical chart
WIFI	wireless fidelity
WLM	workload management (EBT competency)
ZFTT	zero flight-time training

GM3 Annex I Definitions

ED Decision 2016/022/R

HELIDECK

The term ‘helideck’ includes take-off and landing operations on ships and vessels and covers ‘shipboard final approach and take off areas (FATOs).

GM4 Annex I Definitions

ED Decision 2012/015/R

HEAD-UP GUIDANCE LANDING SYSTEM (HUDLS)

A HUDLS is typically used for primary approach guidance to decision heights of 50 ft.

GM5 Annex I Definitions

ED Decision 2016/022/R

HELICOPTER EMERGENCY MEDICAL SERVICES (HEMS) FLIGHT

- (a) A HEMS flight (or more commonly referred to as HEMS mission) normally starts and ends at the HEMS operating base following tasking by the ‘HEMS dispatch centre’. Tasking can also occur when airborne, or on the ground at locations other than the HEMS operating base.

- (b) The following elements should be regarded as integral parts of the HEMS mission:
- (1) flights to and from the HEMS operating site when initiated by the HEMS dispatch centre;
 - (2) flights to and from an aerodrome/operating site for the delivery or pick-up of medical supplies and/or persons required for completion of the HEMS mission; and
 - (3) flights to and from an aerodrome/operating site for refuelling required for completion of the HEMS mission.

GM6 Annex I Definitions

ED Decision 2016/022/R

HOSTILE ENVIRONMENT

Those parts of an open-sea area not considered to constitute a hostile environment should be designated by the appropriate authority in the appropriate aeronautical information publication (AIP) or other suitable documentation.

GM7 Annex I Definitions

ED Decision 2016/022/R

NIGHT VISION IMAGING SYSTEM (NVIS)

Helicopter components of the NVIS include the radio altimeter, visual warning system and audio warning system.

GM8 Annex I Definitions

ED Decision 2016/022/R

OFFSHORE LOCATION

‘Offshore location’ includes, but is not limited to:

- (a) helidecks;
- (b) shipboard heliports; and
- (c) winching areas on vessels or renewable-energy installations.

GM9 Annex I Definitions

ED Decision 2016/022/R

OFFSHORE OPERATIONS

An offshore operation is considered to be a helicopter flight for the purpose of:

- (a) support of offshore oil, gas and mineral exploration, production, storage and transport;
- (b) support to offshore wind turbines and other renewable-energy sources; or
- (c) support to ships including sea pilot transfer.

GM10 Annex I Definitions

ED Decision 2016/022/R

COASTLINE

The national definition of coastline should be included by the appropriate authority in the aeronautical information publication (AIP) or other suitable documentation.

GM11 Annex I Definitions

ED Decision 2016/022/R

PUBLIC INTEREST SITE

An example of a public interest sites is a landing site based at a hospital located in a hostile environment in a congested area, which due to its size or obstacle environment does not allow the application of performance class 1 requirements that would otherwise be required for operations in a congested hostile environment.

GM12 Annex I Definitions

ED Decision 2016/022/R

TECHNICAL INSTRUCTIONS

The ICAO document number for the Technical Instructions is Doc 9284-AN/905.

GM13 Annex I Definitions

ED Decision 2016/022/R

V₁

The first action includes for example: apply brakes, reduce thrust, deploy speed brakes.

GM14 Annex I Definitions

ED Decision 2016/022/R

TASK SPECIALISTS

For the purpose of this Regulation, persons that are carried in a specialised operation, e.g. on a parachute flight, sensational flight or scientific research flight, are considered to be task specialists.

GM15 Annex I Definitions

ED Decision 2019/005/R

UPSET PREVENTION AND RECOVERY TRAINING (UPRT) DEFINITIONS

‘Aeroplane upset prevention and recovery training (UPRT)’ refers to training consisting of:

- aeroplane upset prevention training: a combination of theoretical knowledge and flying training with the aim of providing flight crew with the required competencies to prevent aeroplane upsets; and
- aeroplane upset recovery training: a combination of theoretical knowledge and flying training with the aim of providing flight crew with the required competencies to recover from aeroplane upsets.

‘Aeroplane upset’ refers to an undesired aircraft state characterised by unintentional divergences from parameters normally experienced during operations. An aeroplane upset may involve pitch and/or bank angle divergences as well as inappropriate airspeeds for the conditions.

‘Angle of attack (AOA)’ means the angle between the oncoming air, or relative wind, and a defined reference line on the aeroplane or wing.

‘Approach-to-stall’ means flight conditions bordered by the stall warning and stall.

‘Competency’ means a combination of skills, knowledge, and attitudes required to perform a task to the prescribed standard.

‘Developed upset’ means a condition meeting the definition of an aeroplane upset.

‘Developing upset’ means any time the aeroplane begins to unintentionally diverge from the intended flight path or airspeed.

‘Energy state’ means how much of each kind of energy (kinetic, potential or chemical) the aeroplane has available at any given time.

‘Error’ means an action or inaction by the flight crew that leads to deviations from organisational or flight crew intentions or expectations.

‘Error management’ means the process of detecting and responding to errors with countermeasures that reduce or eliminate the consequences of errors, and mitigate the probability of further errors or undesired aircraft states.

‘First indication of a stall’ means the initial aural, tactile or visual sign of an impending stall, which can be either naturally or synthetically induced.

‘Flight crew resilience’ means the ability of a flight crew member to recognise, absorb and adapt to disruptions.

‘Fidelity level’ means the level of realism assigned to each of the defined FSTD features.

‘Flight path’ means the trajectory or path of the aeroplane travelling through the air over a given space of time.

‘Flight path management’ means active manipulation, using either the aeroplanes automation or manual handling, to command the aeroplane flight controls to direct the aeroplane along a desired trajectory.

‘FSTD Training Envelope’ refers to the high and moderate confidence regions of the FSTD validation envelope.

‘Load factor’ factor means the ratio of a specified load to the weight of the aeroplane, the former being expressed in terms of aerodynamic forces, propulsive forces, or ground reactions.

‘Loss of control in flight (LOCI)’ means a categorisation of an accident or incident resulting from a deviation from the intended flight path.

‘Manoeuvre-based training’ means training that focuses on a single event or manoeuvre in isolation.

‘Negative training’ means training which unintentionally introduces incorrect information or invalid concepts, which could actually decrease rather than increase safety.

‘Negative transfer of training’ means the application (and ‘transfer’) of what was learned in a training environment (i.e., a classroom, an FSTD) to normal practice, i.e. it describes the degree to which what was learned in training is applied to actual normal practices. In this context, negative transfer of training refers to the inappropriate generalisation of knowledge and skill to a situation or setting in normal practice that does not equal the training situation or setting.

‘Post-stall regime’ means flight conditions at an angle of attack greater than the critical angle of attack.

‘Scenario-based training’ means training that incorporates manoeuvres into real-world experiences to cultivate practical flying skills in an operational environment.

‘Stall’ means a loss of lift caused by exceeding the aeroplane’s critical angle of attack.

Note: A stalled condition can exist at any attitude and airspeed, and may be recognised by continuous stall warning activation accompanied by at least one of the following:

- (a) buffeting, which could be heavy at times;
- (b) lack of pitch authority and/or roll control; and
- (c) inability to arrest the descent rate.

‘Stall Event’ means an occurrence whereby the aeroplane experiences conditions associated with an approach-to-stall or a stall.

‘Stall (event) recovery procedure’ means the manufacturer-approved aeroplane-specific stall recovery procedure. If an OEM-approved recovery procedure does not exist, the aeroplane-specific stall recovery procedure developed by the operator, based on the stall recovery template contained in GM5 ORO.FC.220&230, may be used.

‘Stall warning’ means a natural or synthetic indication provided when approaching a stall that may include one or more of the following indications:

- (a) aerodynamic buffeting (some aeroplanes will buffet more than others);
- (b) reduced roll stability and aileron effectiveness;
- (c) visual or aural cues and warnings;
- (d) reduced elevator (pitch) authority;
- (e) inability to maintain altitude or arrest rate of descent; and
- (f) stick shaker activation (if installed).

Note: A stall warning indicates an immediate need to reduce the angle of attack.

‘Startle’ means the initial short-term, involuntary physiological and cognitive reactions to an unexpected event that commence the normal human stress response.

‘Stick pusher’ means a device that, automatically applies a nose down movement and pitch force to an aeroplane’s control columns, to attempt to decrease the aeroplane’s angle of attack. Device activation may occur before or after aerodynamic stall, depending on the aeroplane type.

Note: A stick pusher is not installed on all aeroplane types.

‘Stick shaker’ means a device that automatically vibrates the control column to warn the pilot of an approaching stall.

Note: A stick shaker is not installed on all aeroplane types.

‘Stress (response)’ means the response to a threatening event that includes physiological, psychological and cognitive effects. These effects may range from positive to negative and can either enhance or degrade performance.

‘Surprise’ means the emotionally-based recognition of a difference in what was expected and what is actual.

‘Threat’ means events or errors that occur beyond the influence of the flight crew, increase operational complexity and must be managed to maintain the margin of safety.

‘Threat management’ means the process of detecting and responding to threats with countermeasures that reduce or eliminate the consequences of threats and mitigate the probability of errors or undesired aircraft states.

‘Train-to-proficiency’ means approved training designed to achieve end-state performance objectives, providing sufficient assurances that the trained individual is capable to consistently carry out specific tasks safely and effectively.

Note: In the context of this definition, ‘train-to-proficiency’ can be replaced by ‘training-to-proficiency’.

‘Undesired aircraft state’ means flight crew-induced aircraft position or speed deviation, misapplication of controls, or incorrect systems configuration, associated with a reduction in margins of safety.

Note: Undesired states can be managed effectively, restoring margins of safety, or flight crew response(s) can induce an additional error, incident, or accident.

Note: All countermeasures are necessary flight crew actions. However, some countermeasures to threats, errors and undesired aircraft states that flight crew employ, build upon ‘hard’/systemic-based resources provided by the aviation system.

‘Unsafe situation’ means a situation, which has led to an unacceptable reduction in safety margin.

GM16 Annex I Definitions

ED Decision 2019/008/R

MINOR FAILURE CONDITION

Minor failure conditions may include, for example, a slight reduction in safety margins or functional capabilities, a slight increase in crew workload, such as routine flight plan changes, or some physical discomfort to passengers or cabin crew. Further guidance can be found in AMC 25.1309.

Minor failure conditions are not considered to be unsafe conditions in accordance with AMC 21.A.3B(b).

GM17 Annex I Definitions

ED Decision 2019/019/R

SIMPLE AND COMPLEX PERSONNEL-CARRYING DEVICE SYSTEM (PCDS)

- (a) The following may qualify as a simple PCDS:
 - (1) A safety harness or rescue triangle for no more than two persons.
 - (2) A fixed-rope system for no more than two persons, to be attached under a single cargo hook or Y-rope to be attached to a dual hook.
- (b) The following may not qualify as a simple PCDS:
 - (1) Any system that connects three persons or more to the helicopter.
 - (2) A PCDS with new or novel features.
 - (3) A PCDS that has not yet been proven by an appreciable and satisfactory service experience.
- (c) The connecting elements to the hoist or cargo hook are part of the PCDS.

- (d) The following standards may be used for a simple PCDS:

Table 1: Information on existing available standards applicable to a simple PCDS

Regulation (EU) 2016/425 ¹ or Directive 89/686/EEC if validly marketed before 21 April 2019	Personal protective equipment
Directive 2006/42/EC ²	Machinery
EN 354	Personal protective equipment for work positioning and prevention of falls from a height — lanyards
EN 355	Personal protective equipment against falls from a height — energy absorbers
EN 358	Personal protective equipment for work positioning and prevention of falls from a height — belts for work positioning and restraint and work positioning lanyards
EN 361	Personal protective equipment against falls from a height — full body harnesses
EN 362	Personal protective equipment against falls from a height — connectors
EN 363	Personal fall protection equipment — personal fall-protection systems
EN 364	Personal protective equipment against falls from a height — test methods
EN 365	Marking/packaging/instructions to use
EN 813	Personal fall-protection equipment — sit harnesses
EN 1497	Personal protective equipment against falls from a height — rescue harnesses
EN 1498	Personal protective equipment against falls from a height — rescue loops
EN 1891	Personal protective equipment for the prevention of falls from a height — low stretch kernmantle ropes
EN 12275	Mountaineering equipment — connectors — safety requirements and test methods
EN 12277	Mountaineering equipment — harnesses — safety requirements and test methods

GM18 Annex I Definitions

ED Decision 2019/019/R

DETERMINING THE PRINCIPAL PLACE OF BUSINESS

- (a) The principal place of business encompasses the principal financial functions and operational control of the activities of an operator. It may refer to the organisation's site from which the majority of its management personnel specified in [ORO.GEN.110](#) directs, controls or coordinates its operational activities, ensuring that the organisation complies with Regulation (EU) No 965/2012. For non-commercial operations, this is usually the home base of the aircraft concerned or the location of the flight department.

¹ OJ L 81, 31.3.2016, p. 51.

² OJ L 157, 9.6.2006, p. 24.

- (b) Since an operator, especially in the world of non-commercial operations, may use several places where it performs financial transactions, or several operational bases where there are personnel in charge of operational control, for the purpose of an effective oversight, it is relevant that the principal place of business be the one:
- (1) where the operator has registered its organisation with the local register and where it pays corporate tax;
 - (2) where its main building facilities are located;
 - (3) where main administrative and financial work is being done (where salaries and employment benefits are paid); and
 - (4) from where the organisation management directs, controls or coordinates a substantial part of its activities, ensuring that the organisation complies with the requirements specified in Regulation (EU) No 965/2012.
- (c) Organisations that perform also activities which are not subject to Part-ORO, Part-NCC or Part-SPO are recommended to consider that part of the organisation which is responsible for the operation of aircraft subject to Part-ORO, Part-NCC or Part-SPO.

For such organisations, the accountable manager is that manager who has the authority to ensure that all activities subject to Part-ORO, Part-NCC or Part-SPO can be financed and carried out in accordance with the applicable requirements. If the accountable manager is not located in the part of the organisation that is responsible for the operation of aircraft, but the other criteria mentioned in point (b) apply, the location of the accountable manager does not need to be considered for the determination of the principal place of business.

GM19 Annex I Definitions

ED Decision 2021/002/R

EVIDENCE-BASED TRAINING

‘Behaviour’ refers to the way a person responds, either overtly or covertly, to a specific set of conditions, and which is capable of being measured.

‘Instructor concordance’ is also called ‘inter-rater reliability’.

‘Conditions’ refers to anything that may qualify a specific environment in which performance will be demonstrated.

‘Cycle’ refers to the combination of two modules where Cycle 1 comprises Modules 1 and 2, Cycle 2 comprises Modules 3 and 4, and Cycle 3 comprises Modules 5 and 6 of the 3-year EBT programme.

‘Equivalency of approaches’ refers to approach clustering in other industry documentation.

‘Equivalency of malfunctions’ refers to malfunction clustering in other industry documentation.

‘Evaluation phase (EVAL)’ refers to the phase where a first assessment of competencies is performed in order to identify individual training needs. On completion of the evaluation phase, any areas that do not meet the minimum competency standard will become the focus of the subsequent training. The evaluation phase comprises a complete mission as a crew but not necessarily a complete flight.

‘Facilitation technique’ refers to an active training method, which uses effective questioning, listening and a non-judgemental approach, and is particularly effective in developing skills and attitudes, assisting trainees in developing insight and their own solutions, resulting in better understanding, retention and commitment.

‘Line-orientated flight scenario(s)’ are comprised of scenario elements derived from the table of assessment and training topics.

‘Line-orientated safety audit (LOSA)’ is one of the tools used to help evaluate the performance of the operations. It consists of line flights that are observed by appropriately qualified operator personnel to provide feedback to validate the EBT programme. LOSA may be one of the tools used to look at those elements of the operation that are unable to be monitored by FDM or Advanced FDM programmes.

‘Manoeuvres training phase’ refers to the phase where skill retention is trained (body memory actions). Flight path control may be accomplished by a variety of means including manual aircraft control and the use of auto flight systems.

‘Monitoring’ refers to a cognitive process to compare an actual to an expected state. It requires knowledge, skills and attitudes to create a mental model and to take appropriate action when deviations are recognised.

‘Observable behaviour (OB)’ refers to a single role-related behaviour that can be observed. The instructor may or may not be able to measure it.

‘Performance criteria’ refers to statements used to assess whether the required levels of performance have been achieved for a competency. A performance criterion consists of an OB, a condition (or conditions) and a competency standard.

‘Practical assessment (or EBT practical assessment)’ refers to a method for assessing performance that serves to verify the integrated performance of competencies. It takes place in either a simulated or an operational environment. An EBT assessment is equivalent to a proficiency check and is performed under the instructor privilege in the context of proficiency check in accordance with Appendix 10 to Part-FCL. More information can be found in ICAO Doc 9868 ‘PANS-TRG’.

‘Scenario-based training phase (SBT)’ refers to the largest phase in the EBT programme. It is designed to maximise crew’s exposure to a variety of situations that develop and sustain a high level of competency and resilience. The scenario for this phase should include critical external and environmental threats, to build effective crew interaction to identify and manage errors. A portion of the phase will also be directed towards the management of critical system malfunctions.

Scenario elements address the training topic and detail the threat and/or error that the crew are exposed to.

‘Train-to-proficiency’ refers to approved training designed to achieve end-state performance objectives, providing sufficient assurance that the trained individual is capable of consistently carrying out specific tasks safely and effectively.

Note: In the context of this definition, ‘train-to-proficiency’ can be replaced by ‘training-to-proficiency’.

GM20 Annex I Definitions

ED Decision 2021/005/R

CONTAMINATED RUNWAY

As the runway condition is reported in runway thirds, a significant portion of the runway surface area is more than 25 % of one third of the runway surface area within the required length and width being used.

The runway length being used in this context is the physical length of runway available, typically from the start of the take-off run available (TORA) in one direction to the start of the TORA in the opposite direction. When the runway is shortened by a notice to airmen (NOTAM) — for example, due to works,

or the aerodrome operator is not able to clear the full length of the runway and closes part of it for operations, the length being used is that declared in the NOTAM and the ‘reduced runway length’ that declared in the RCR.

The runway width being used in this context is the physical width of the runway (between the runway edge lights), or the ‘cleared width’ if reported in the RCR. It is not intended that 25 % coverage is reported when contaminants affect only the runway edges after runway cleaning. Runway inspectors are instructed to focus on the area around the wheel tracks when reporting the contaminant type, coverage and depth.

GM21 Annex I Definitions

ED Decision 2021/005/R

DRY RUNWAY/WET RUNWAY

The ‘area intended to be used’ means the area of the runway that is part of the TORA, accelerate and stop distance available (ASDA) or landing distance available (LDA) declared in the aeronautical information publication (AIP) or by a NOTAM.

GM22 Annex I Definitions

ED Decision 2021/005/R

RUNWAY CONDITION CODE (RWYCC)

The purpose of the runway condition code (RWYCC) is to permit an operational aeroplane landing performance calculation by the flight crew.

GM23 Annex I Definitions

ED Decision 2021/005/R

RUNWAY SURFACE CONDITION(S)

- (a) The runway surface conditions used in the RCR establish a common language between the aerodrome operator, the aeroplane manufacturer and the aeroplane operator.
- (b) Aircraft de-icing chemicals and other contaminants are also reported but are not included in the list of runway surface condition descriptors because their effect on the runway surface friction characteristics and the RWYCC cannot be evaluated in a standardised manner.

GM24 Annex I Definitions

ED Decision 2021/005/R

RUNWAY SURFACE CONDITION DESCRIPTORS — GENERAL

The runway surface condition descriptors are used solely in the context of the RCR and are not intended to supersede or replace any existing World Meteorological Organization (WMO) definitions.

RUNWAY SURFACE CONDITION DESCRIPTORS — FROST

- (a) Freezing refers to the freezing point of water (0 °C).
- (b) Under certain conditions, frost can cause the surface to become very slippery, and it is then reported appropriately as downgraded RWYCC.

RUNWAY SURFACE CONDITION DESCRIPTORS — STANDING WATER

Running water of depth greater than 3 mm is reported as ‘standing water’ by convention.

RUNWAY SURFACE CONDITION DESCRIPTORS – WET ICE

Freezing precipitation can lead to runway conditions associated with wet ice from an aeroplane performance point of view. Wet ice can cause the surface to become very slippery. It is then reported appropriately as downgraded RWYCC.

GM25 Annex I Definitions

ED Decision 2021/005/R

LANDING DISTANCE AT TIME OF ARRIVAL

The landing distance data to be used for a landing performance assessment at time of arrival allow to establish an operationally achievable landing distance from 50ft above runway threshold to full stop that takes into account AFM procedures for final approach and landing and is provided as a function of the main influence parameters such as aeroplane mass and configuration, pressure altitude, wind, outside air temperature, runway slope and approach speed increments. It may be provided for use of automation such as autobrakes and autoland and may account for reverse thrust use. As the landing distance at time of arrival is the unfactored minimum landing distance achievable for the assumed conditions, an appropriate margin should be applied to this distance to determine the minimum LDA necessary for a safe stop.

GM26 Annex I Definitions

ED Decision 2021/005/R

SLIPPERY WET RUNWAY

- (a) The surface friction characteristics of the runway are considered degraded when below the minimum standards.
- (b) A portion of runway in the order of 100 m long may be considered significant.

GM27 Annex I Definitions

ED Decision 2021/005/R

FLIGHT RECORDER

A flight recorder may be crash-protected or lightweight and may be deployable or not. Crash-protected flight recorders are capable of withstanding very severe crash conditions such as those encountered during some accidents of large aeroplanes and large helicopters. Crash-protected flight recorders comprise one or more of the following systems: a flight data recorder (FDR), a cockpit voice recorder (CVR), an airborne image recorder (AIR), or a data link recorder (DLR). Lightweight flight recorders are usually designed to meet less demanding requirements than crash-protected flight recorders, which allows them to be lighter. A non-deployable flight recorder is permanently attached to the aircraft. A deployable flight recorder includes a part that is capable of automatically deploying from the aircraft.

GM28 Annex I Definitions for terms used in Annexes II to VIII

ED Decision 2022/005/R

FLIGHT MONITORING AND FLIGHT WATCH — RELEVANT SAFETY INFORMATION

Relevant safety information is any element that may affect the safety of the flight, such as:

- (a) an aircraft technical failure (e.g. failures where flight operations personnel can help to calculate the landing distance or new trip fuel or to update the aerodrome minima);

- (b) unforeseen hazards:
 - (1) air traffic (e.g. delays and/or long distance to complete the approach, extensive use of radar vectoring);
 - (2) meteorological conditions (e.g. DH and aerodrome operating minima, adverse or extreme meteorological conditions);
 - (3) aerodrome and runway status (e.g. insufficient runway length due to brake failure, obstruction or closure of the runway, runway contamination, failure or malfunction caused by on-ground navigation or approach equipment);
 - (4) navigation aid status (e.g. failure of the navigation aids);
 - (5) availability of communications (e.g. failure of communications capabilities, interruptions, interferences, change of frequency channels); and
 - (6) terrain and obstacles (e.g. geophysical phenomena (volcanic eruptions, earthquakes, tsunami), difficult terrain at an unplanned aerodrome (large bodies of water, mountains));
- (c) updates of the operational flight plan when they affect the fuel reserves:
 - (1) diversion to an en route alternate (ERA) aerodrome, a destination alternate, or a take-off alternate aerodrome;
 - (2) change of the runway selected for landing if the new runway is shorter;
 - (3) location of the decision point or the point of no return (PNR) due to, for instance, change in altitude, in wind data, etc.;
 - (4) significant in-flight change of the flight route compared to the route in the flight planning; or
 - (5) significant deviation from the planned fuel consumption; and
- (d) position reporting:
 - (1) flight-monitoring personnel should report in every phase of the flight: taxi, take-off, climb, cruise, cruise steep climb, descent, approach, landing;
 - (2) flight watch provides active tracking; and
 - (3) where no real-time automatic position-reporting is possible, the operator should have an acceptable alternative to ensure in-flight reporting at least every hour.

GM29 Annex I Definitions for terms used in Annexes II to VIII

ED Decision 2022/005/R

FUEL/ENERGY

The energy used for aircraft propulsion comes from various sources and is of various types.

A frequently used type of energy in aviation is derived from processing (in a piston or turbine engine) hydrocarbon-based fuels that include gasoline (leaded or unleaded), diesel, avgas, JET A-1, and JET B. Hydrogen may also be used as fuel for fuel cell applications, which generate electricity that is used to generate propulsion. However, as current technologies already use other sources of energy for aircraft propulsion, such as stored electrical energy, the typical term 'fuel' has become restrictive and no longer covers emerging technologies.

Therefore, a broader, combined term is introduced to accommodate new types of energy, other than fuel, used for aircraft propulsion purposes.

The term ‘fuel/energy’ should cater for both typical fuel and any other type or source of energy used for aircraft propulsion, including but not limited to electrical energy stored in batteries.

When used in the combination ‘fuel/energy’, the term ‘energy’ only refers to the electrical energy used for aircraft propulsion purposes. It does not include any other form of stored electrical energy that is used on board an aircraft (e.g. batteries of EFBs, ELTs, underwater locating devices (ULDs), automatic external defibrillators (AEDs), or backup energy sources).

GM30 Annex I Definitions for terms used in Annexes II to VIII

ED Decision 2022/005/R

FUEL/ENERGY EN ROUTE ALTERNATE (ERA) AERODROME

Fuel/energy ERA aerodromes could be used in the following cases:

- (a) ‘fuel ERA aerodrome critical scenario’: that aerodrome is used when additional fuel is required at the most critical point along the route to comply with point (c)(6) of point [CAT.OP.MPA.181](#) ‘Fuel/energy scheme — fuel/energy planning and in-flight re-planning policy — aeroplanes’;
- (b) ‘fuel ERA aerodrome 3 %’: that aerodrome is used when an operator reduces the contingency fuel to 3 %; and
- (c) ‘fuel ERA aerodrome PNR’: that aerodrome is used at the PNR during isolated aerodrome operations.

GM31 Annex I Definitions

ED Decision 2022/012/R

DEFINITIONS OF TERMS RELATED TO ALL-WEATHER OPERATIONS

The following terms and concepts are used in the provisions related to all-weather operations in the AMC and GM to [Regulation \(EU\) No 965/2012](#):

‘Advanced aircraft’ means an aircraft with equipment in addition to that required for a basic aircraft for a given take-off, approach or landing operation.

‘AFM or additional data from the TC/STC holder’ — an AFM or additional data from the TC/STC holder may provide:

- limitations, in accordance with which the aircraft must be operated, as described under point 4.1 of Annex V to [Regulation \(EU\) 2018/1139](#). This means that the aircraft may NOT exceed those given values; or
- demonstrated capabilities, which are the assumptions, envelope or conditions that were used to demonstrate adequate performance to comply with the appropriate certification specifications.

However, some AFMs (especially for those aircraft or landing systems that were certified before the introduction of CS-AWO Issue 2) may not include all of the assumptions, envelope or conditions that were used to demonstrate adequate performance. Information regarding the assumptions, envelope, or conditions that were used to demonstrate adequate performance of a landing system can be provided by equivalent documentation issued by TC/STC holder.

Other types of information issued by the TC/STC holder may include (not an exhaustive list):

- equivalence between different aircraft models (types);
- equivalence between aircraft types and variants;

- landing systems equivalence;
- a list of runways with their demonstrated performance;
- a letter of no-technical objection/evaluation letter.

Note: 'TC/STC holder' should be understood as the holder of the certificate for the landing system.

'Basic aircraft' means an aircraft which has the minimum equipment required to perform the intended take-off, approach or landing operation.

'Continuous descent final approach (CDFA)': when the circling altitude/height is reached, it is acceptable to maintain altitude (level-off) and transition to the visual segment. The operator may provide a point in the visual segment in which the descent may be resumed to follow a continuous descent to a point approximately 15 m (50 ft) above the landing runway threshold or the point where the flare manoeuvre begins for the type of aircraft flown.

'Enhanced flight vision system (EFVS)-Approach (EFVS-A)' means a system that has been demonstrated to meet the criteria to be used for approach operations from a decision altitude/height (DA/H) or a minimum descent altitude/height (MDA/H) to 100 ft (30 m) threshold elevation while all system components are functioning as intended, but may have failure modes that could result in the loss of EFVS capability. It should be assumed for an EFVS-A that:

- (a) the pilot will conduct a go-around at or above 100 ft threshold elevation, in the event of an EFVS failure; and
- (b) descent below 100 ft above the threshold elevation through to touchdown and roll-out should be conducted using natural vision so that any failure of the EFVS does not prevent the pilot from completing the approach and landing.

'Enhanced flight vision system (EFVS)-Landing (EFVS-L)' means a system that has been demonstrated to meet the criteria to be used for approach and landing operations that rely on sufficient visibility conditions to enable unaided roll-out and to mitigate for loss of EFVS function.

'Head-up display (HUD) or equivalent display system' means a display system which presents flight information to the pilot's forward external field of view (FOV), and which does not significantly restrict the external view.

'Landing system' means an airborne equipment, which:

- (a) provides automatic control of the aircraft during the approach and landing (i.e. automatic landing system); or
- (b) has been demonstrated to meet the criteria to be used for approach and landing operations (e.g. HUD landing system, EFVS-L or any other approved system).

'Landing system assessment area (LSAA)' means the part of the runway that extends from the threshold to a distance of 600 m from the threshold.

Note — Although the landing systems certification criteria use a value greater than 600 m after the threshold to evaluate limit conditions, for the purpose of flight operations assessment a distance of 600 m is the relevant part as landing beyond this point is not expected to occur in day-to-day operations. The LSAA may not necessarily be coincident with the touchdown zone. The touchdown zone is specified in CS-ADR DSN.

'Low-visibility procedures (LVPs)' means procedures applied by an aerodrome for the purpose of ensuring safety during low-visibility operations (LVOs).

Regular runway means a runway whose characteristics fit within the acceptable limits demonstrated by the original equipment manufacturer (OEM) during certification. The classification of a runway as a ‘regular runway’ is different from one set of equipment to another.

‘Required visual reference’ refers to that section of the visual aids or of the approach area which should have been in view for sufficient time for the pilot to have made an assessment of the aircraft position and rate of change of position, in relation to the desired flight path. In the case of a circling approach, the required visual reference is the runway environment.

‘Satellite-based augmentation system (SBAS)’ means a wide coverage augmentation system in which the user receives augmentation information from a satellite-based transmitter. The most common form of SBAS in Europe is the European Geostationary Navigation Overlay Service (EGNOS).

‘Synthetic vision system (SVS)’ means a system that displays data derived synthetic images of the external scene from the perspective of the flight deck.

‘Landing area’ means that part of a movement area intended for the landing or take-off of aircraft.

‘Touchdown zone (TDZ)’ means the portion of a runway, beyond the threshold, where landing aeroplanes are intended to first contact the runway.

‘Type B instrument approach operations categories’: where decision height (DH) and runway visual range (RVR) fall into different categories of operation, the instrument approach operation would be conducted in accordance with requirements of the most demanding category. This does not apply if the RVR and/or DH has been approved as operational credits.

GM32 Annex I Definitions

ED Decision 2022/012/R

EFVSs — DIFFERENCES WITH ENHANCED VISION SYSTEMS (EVSs)

(a) Introduction to EVSs

EVSs use sensing technology to improve a pilot’s ability to detect objects and topographical features ahead of the aircraft. Different types of sensing technology are used on different aircraft installations. Sensing technologies used include forward-looking infrared, millimetre wave radiometry, millimetre wave radar or low-light level intensification; additional technologies may be developed in the future. The image from sensors may be displayed to the pilot in a number of different ways including ‘head-up’ and ‘head-down’ displays.

(b) EVSs and EFVSs

An EFVS is an EVS that is integrated with a flight guidance system, which presents the image from sensors to the pilot on a head-up display (HUD) or equivalent display. If EFVS equipment is certified according to the applicable airworthiness requirements and an operator holds the necessary specific approval, then an EFVS may be used for EFVS operations. An EFVS operation is an operation with an operational credit which allows operating in visibility conditions lower than those in which operations without the use of EFVS are permitted.

(c) Functions of EVSs

Depending on the capabilities of the particular system, EVSs may be useful during operations at night or in reduced visibility for the following:

- (1) improving visibility of airport features and other traffic during ground operations;
- (2) displaying terrain and obstructions in flight;
- (3) displaying weather in flight;

- (4) improving visibility of the runway environment during approach operations; and
- (5) improving visibility of obstructions on a runway (e.g. aircraft, vehicles or animals) during take-off and approach operations.

(d) Limitations of EVSs

EVSs are a useful tool for enhancing situational awareness; however, each EVS installation has its own specific limitations. These may include:

- (1) Performance variations depend on conditions including ambient temperature and lighting and weather phenomena. A system may provide very different image qualities in the same visibility depending on the particular phenomena causing restricted visibility, e.g. haze, rain, fog, snow, dust, etc.
- (2) An EVS may not be able to detect certain types of artificial lighting. Light emitting diode (LED) lights have a much lower infrared signature than incandescent lights and therefore may not be detected by some types of EVSs. LED lighting is used for runway, taxiway and approach lighting at many airports.
- (3) Monochrome display. EVSs will generally not be able to detect and display the colour of airport lighting. This means that colour coding used on airport lighting will not be visible to the pilot using an EVS.
- (4) Many EVS installations do not have redundancy, so a single failure may lead to loss of EVS image.
- (5) The location of the sensor on the airframe may mean that in certain conditions it could be susceptible to ice accretion or obscuration from impact damage from objects such as insects or birds.
- (6) Where an EVS image is presented on a HUD or an equivalent display, the image needs to be consistent with the pilot's external view through the display. Particular installations may have limitations on the conditions under which this consistent image can be generated (e.g. crosswind conditions during approach).
- (7) Imaging sensor performance can be variable and unpredictable. Pilots should not assume that a flightpath is free of hazards because none are visible in an EVS image.

(e) Considerations for the use of EVSs

EVSs may be used in all phases of flight and have significant potential to enhance the pilot's situational awareness. No specific approval is required for the use of an EVS; however, the operator is responsible for ensuring that the flight crew members have received training on the equipment installed on their aircraft in accordance with [ORO.FC.120](#). In addition, the operator is responsible for evaluating the risks associated with system limitations and for implementing suitable mitigation measures in accordance with [ORO.GEN.200\(a\)\(3\)](#) before using the EVS.

The use of EVSs does not permit the use of different operating minima, and EVS images cannot replace natural vision for the required visual reference in any phase of flight including take-off, approach or landing.

An EVS that is not an EFVS cannot be used for EFVS operations and therefore does not obtain an operational credit.

GM33 Annex I Definitions

ED Decision 2022/012/R

INSTRUMENT APPROACH OPERATIONS

- (a) Depending on the instrument approach procedure (IAP) in use, the lateral and vertical navigation guidance for an instrument approach operation may be provided by:
 - (1) a ground-based radio navigation aid; or
 - (2) computer-generated navigation data from ground-based, space-based or self-contained navigation aids or a combination of these.
- (b) A non-precision approach (NPA) procedure flown as CDFAs with vertical path guidance calculated by on-board equipment is considered to be a 3D instrument approach operation. Depending on the limitations of the equipment and information sources used to generate vertical guidance, it may be necessary for the pilot to cross-check this guidance against other navigational sources during the approach and to ensure that the minimum altitude/height over published step-down fixes is observed. CDFAs with manual calculation of the required rate of descent are considered 2D operations.
- (c) Further guidance on the classification of an instrument approach operation based on the designed lowest operating minima is contained in Appendix J to ICAO Doc 9365 Manual of All-Weather Operations, Fourth Edition, 2017.

GM34 Annex I Definitions

ED Decision 2022/012/R

DECISION ALTITUDE (DA) OR DECISION HEIGHT (DH)

- (a) Decision altitude (DA) is referenced to mean sea level and decision height (DH) is referenced to the threshold elevation.
- (b) For operations using DA, the aircraft altimeters are set to QNH. For operations using a barometric DH, the aircraft altimeters are set to QFE.
- (c) For SA CAT I, SA CAT II, CAT II/III operations, the DH is based on the use of a radio altimeter or other devices capable of providing equivalent performance. The DH is determined with reference to threshold elevation, but the value of the DH set for the approach will be based on the height of the aircraft above the pre-threshold terrain, which may be higher or lower than the threshold.
- (d) For convenience, when both expressions are used, they may be written in the form 'decision altitude/height' and abbreviated 'DA/H'.

GM35 Annex I Definitions

ED Decision 2022/012/R

MINIMUM DESCENT ALTITUDE (MDA) OR MINIMUM DESCENT HEIGHT (MDH)

- (a) Minimum descent altitude (MDA) is referenced to mean sea level and minimum descent height (MDH) is referenced to the aerodrome elevation or to the threshold elevation if that is more than 7 ft below the aerodrome elevation. An MDH for a circling approach is referenced to the aerodrome elevation.
- (b) For operations using MDA, the aircraft altimeters are set to QNH. For operations using a barometric MDH, the aircraft altimeters are set to QFE.

- (c) For convenience, when both expressions are used, they may be written in the form ‘minimum descent altitude/height’ and abbreviated ‘MDA/H’.

ANNEX II (PART-ARO)

ARO.GEN.005 Scope

Regulation (EU) No 965/2012

This Annex establishes requirements for the administration and management system to be fulfilled by the Agency and Member States for the implementation and enforcement of Regulation (EC) No 216/2008 and its Implementing Rules regarding civil aviation air operations.

SUBPART GEN: GENERAL REQUIREMENTS

SECTION I – GENERAL

ARO.GEN.115 Oversight documentation

Regulation (EU) No 965/2012

The competent authority shall provide all legislative acts, standards, rules, technical publications and related documents to relevant personnel in order to allow them to perform their tasks and to discharge their responsibilities.

ARO.GEN.120 Means of compliance

Regulation (EU) 2019/1384

- (a) The Agency shall develop acceptable means of compliance (AMC) that may be used to establish compliance with Regulation (EU) 2018/1139 and its delegated and implementing acts.
- (b) Alternative means of compliance may be used to establish compliance with Regulation (EU) 2018/1139 and its delegated and implementing acts.
- (c) The competent authority shall establish a system to consistently evaluate whether the alternative means of compliance used by itself or by organisations and persons under its oversight comply with Regulation (EU) 2018/1139 and its delegated and implementing acts. That system shall include procedures to limit, revoke or amend approved alternative means of compliance, if it has been demonstrated by the competent authority that those alternative means of compliance do not comply with Regulation (EU) 2018/1139 and delegated and implementing acts adopted on its basis.
- (d) The competent authority shall evaluate all alternative means of compliance proposed by an organisation in accordance:
 - (1) with point [ORO.GEN.120\(b\)](#) of Annex III (Part-ORO) to this Regulation;
 - (2) for balloons with point BOP.ADD.010 of Annex II (Part-BOP) to Commission Regulation (EU) 2018/395¹; or
 - (3) for sailplanes with point SAO.DEC.100(c) of Annex II (Part-SAO) to Commission Implementing Regulation (EU) 2018/1976²;

by analysing the documentation provided and, if considered necessary, conducting an inspection of the organisation.

When the competent authority finds that the alternative means of compliance are in accordance with the Implementing Rules, it shall without undue delay:

- (1) notify the applicant that the alternative means of compliance may be implemented and, if applicable, amend the approval, specialised operation authorisation or certificate of the applicant accordingly; and

¹ Commission Regulation (EU) 2018/395 of 13 March 2018 laying down detailed rules for the operation of balloons pursuant to Regulation (EC) No 216/2008 of the European Parliament and of the Council (OJ L 71, 14.3.2018, p. 10).

² Commission Implementing Regulation (EU) 2018/1976 of 14 December 2018 laying down detailed rules for the operation of sailplanes pursuant to Regulation (EU) 2018/1139 of the European Parliament and of the Council (OJ L 326, 20.12.2018, p. 64).

- (2) notify the Agency of their content, including copies of all relevant documentation.
- (e) When the competent authority itself uses alternative means of compliance to achieve compliance with Regulation (EC) No 216/2008 and its Implementing Rules it shall:
- (1) make them available to all organisations and persons under its oversight; and
 - (2) without undue delay notify the Agency.

The competent authority shall provide the Agency with a full description of the alternative means of compliance, including any revisions to procedures that may be relevant, as well as an assessment demonstrating that the Implementing Rules are met.

AMC1 ARO.GEN.120(d)(3) Means of compliance

ED Decision 2014/025/R

GENERAL

The information to be provided to other Member States following approval of an alternative means of compliance should contain a reference to the Acceptable Means of Compliance (AMC) to which such means of compliance provides an alternative, as well as a reference to the corresponding Implementing Rule, indicating as applicable the subparagraph(s) covered by the alternative means of compliance.

AMC1 ARO.GEN.120(e) Means of compliance

ED Decision 2017/006/R

DEMONSTRATION OF COMPLIANCE

In order to demonstrate that the implementing rules are met, a risk assessment should be completed and documented. The result of this risk assessment should demonstrate that an equivalent level of safety to that established by the acceptable means of compliance (AMC) adopted by the Agency is reached.

GM1 ARO.GEN.120 Means of compliance

ED Decision 2014/025/R

GENERAL

Alternative means of compliance used by a competent authority or by organisations under its oversight may be used by other competent authorities or organisations only if processed again in accordance with [ARO.GEN.120\(d\) and \(e\)](#).

ARO.GEN.125 Information to the Agency

Regulation (EU) No 965/2012

- (a) The competent authority shall without undue delay notify the Agency in case of any significant problems with the implementation of Regulation (EC) No 216/2008 and its Implementing Rules.
- (b) The competent authority shall provide the Agency with safety-significant information stemming from the occurrence reports it has received.

ARO.GEN.135 Immediate reaction to a safety problem

Regulation (EU) 2019/1384

- (a) Without prejudice to Regulation (EU) No 376/2014 of the European Parliament and of the Council¹, the competent authority shall implement a system to appropriately collect, analyse and disseminate safety information.
- (b) The Agency shall implement a system to appropriately analyse any relevant safety information received and without undue delay provide to Member States and the Commission any information, including recommendations or corrective actions to be taken, necessary for them to react in a timely manner to a safety problem involving products, parts, appliances, persons or organisations subject to Regulation (EC) No 216/2008 and its Implementing Rules.
- (c) Upon receiving the information referred to in (a) and (b), the competent authority shall take adequate measures to address the safety problem.
- (d) Measures taken under (c) shall immediately be notified to all persons or organisations which need to comply with them under Regulation (EC) No 216/2008 and its Implementing Rules. The competent authority shall also notify those measures to the Agency and, when combined action is required, the other Member States concerned.

SECTION II – MANAGEMENT

ARO.GEN.200 Management system

Regulation (EU) No 379/2014

- (a) The competent authority shall establish and maintain a management system, including as a minimum:
 - (1) documented policies and procedures to describe its organisation, means and methods to achieve compliance with Regulation (EC) No 216/2008 and its Implementing Rules. The procedures shall be kept up to date and serve as the basic working documents within that competent authority for all related tasks;
 - (2) a sufficient number of personnel to perform its tasks and discharge its responsibilities. Such personnel shall be qualified to perform their allocated tasks and have the necessary knowledge, experience, initial and recurrent training to ensure continuing competence. A system shall be in place to plan the availability of personnel, in order to ensure the proper completion of all tasks;
 - (3) adequate facilities and office accommodation to perform the allocated tasks;
 - (4) a function to monitor compliance of the management system with the relevant requirements and adequacy of the procedures including the establishment of an internal audit process and a safety risk management process. Compliance monitoring shall include a feedback system of audit findings to the senior management of the competent authority to ensure implementation of corrective actions as necessary; and
 - (5) a person or group of persons, ultimately responsible to the senior management of the competent authority for the compliance monitoring function.

¹ Regulation (EU) No 376/2014 of the European Parliament and of the Council of 3 April 2014 on the reporting, analysis and follow-up of occurrences in civil aviation, amending Regulation (EU) No 996/2010 of the European Parliament and of the Council and repealing Directive 2003/42/EC of the European Parliament and of the Council and Commission Regulations (EC) No 1321/2007 and (EC) No 1330/2007 (OJ L 122, 24.4.2014, p. 18).

- (b) The competent authority shall, for each field of activity, including management system, appoint one or more persons with the overall responsibility for the management of the relevant task(s).
- (c) The competent authority shall establish procedures for participation in a mutual exchange of all necessary information and assistance with other competent authorities concerned including on all findings raised and follow-up actions taken as a result of oversight of persons and organisations exercising activities in the territory of a Member State, but certified or authorised by or making declarations to the competent authority of another Member State or the Agency.
- (d) A copy of the procedures related to the management system and their amendments shall be made available to the Agency for the purpose of standardisation.

AMC1 ARO.GEN.200(a) Management system

ED Decision 2014/025/R

GENERAL

- (a) All of the following should be considered when deciding upon the required organisational structure:
 - (1) the number of certificates, attestations, authorisations and approvals to be issued;
 - (2) the number of declared organisations;
 - (3) the number of certified or authorised persons and organisations exercising an activity within that Member State, including persons or organisations certified or authorised by other competent authorities;
 - (4) the possible use of qualified entities and of resources of other competent authorities to fulfil the continuing oversight obligations;
 - (5) the level of civil aviation activity in terms of:
 - (i) number and complexity of aircraft operated;
 - (ii) size and complexity of the Member State's aviation industry;
 - (6) the potential growth of activities in the field of civil aviation.
- (b) The set-up of the organisational structure should ensure that the various tasks and obligations of the competent authority do not rely solely on individuals. A continuous and undisturbed fulfilment of these tasks and obligations of the competent authority should also be guaranteed in case of illness, accident or leave of individual employees.

GM1 ARO.GEN.200(a) Management system

ED Decision 2014/025/R

GENERAL

- (a) The competent authority designated by each Member State should be organised in such a way that:
 - (1) there is specific and effective management authority in the conduct of all relevant activities;

- (2) the functions and processes described in the applicable requirements of Regulation (EC) No 216/2008¹ and its Implementing Rules and AMCs, Certification Specifications (CSs) and Guidance Material (GM) may be properly implemented;
 - (3) the competent authority's organisation and operating procedures for the implementation of the applicable requirements of Regulation (EC) No 216/2008 and its Implementing Rules are properly documented and applied;
 - (4) all competent authority personnel involved in the related activities are provided with training where necessary;
 - (5) specific and effective provision is made for the communication and interface as necessary with the Agency and the competent authorities of other Member States; and
 - (6) all functions related to implementing the applicable requirements are adequately described.
- (b) A general policy in respect of activities related to the applicable requirements of Regulation (EC) No 216/2008 and its Implementing Rules should be developed, promoted and implemented by the manager at the highest appropriate level; for example the manager at the top of the functional area of the competent authority that is responsible for such activities.
- (c) Appropriate steps should be taken to ensure that the policy is known and understood by all personnel involved, and all necessary steps should be taken to implement and maintain the policy.
- (d) The general policy, whilst also satisfying additional national regulatory responsibilities, should in particular take into account:
- (1) the provisions of Regulation (EC) No 216/2008;
 - (2) the provisions of the applicable Implementing Rules and their AMCs, CSs and GM;
 - (3) the needs of industry; and
 - (4) the needs of the Agency and of the competent authority.
- (e) The policy should define specific objectives for key elements of the organisation and processes for implementing related activities, including the corresponding control procedures and the measurement of the achieved standard.

AMC1 ARO.GEN.200(a)(1) Management system

ED Decision 2014/025/R

DOCUMENTED POLICIES AND PROCEDURES

- (a) The various elements of the organisation involved with the activities related to Regulation (EC) No 216/2008 and its Implementing Rules should be documented in order to establish a reference source for the establishment and maintenance of this organisation.
- (b) The documented procedures should be established in a way that facilitates their use. They should be clearly identified, kept up-to-date and made readily available to all personnel involved in the related activities.

¹ Regulation (EC) No 216/2008 of the European Parliament and of the Council of 20 February 2008 on common rules in the field of civil aviation and establishing a European Aviation Safety Agency, and repealing Council Directive 91/670/EEC, Regulation (EC) No 1592/2002 and Directive 2004/36/EC. OJ L 79, 19.3.2008, p. 1. Regulation as last amended by Commission Regulation (EU) No 6/2013 of 8 January 2013 (OJ L 4, 9.1.2013, p. 34).

- (c) The documented procedures should cover, as a minimum, all of the following aspects:
- (1) policy and objectives;
 - (2) organisational structure;
 - (3) responsibilities and associated authority;
 - (4) procedures and processes;
 - (5) internal and external interfaces;
 - (6) internal control procedures;
 - (7) training of personnel;
 - (8) cross-references to associated documents;
 - (9) assistance from other competent authorities or the Agency (where required).
- (d) It is likely that the information is held in more than one document or series of documents, and suitable cross-referencing should be provided. For example, organisational structure and job descriptions are not usually in the same documentation as the detailed working procedures. In such cases, it is recommended that the documented procedures include an index of cross-references to all such other related information, and the related documentation should be readily available when required.

AMC1 ARO.GEN.200(a)(2) Management system

ED Decision 2017/006/R

QUALIFICATION AND TRAINING — GENERAL

- (a) It is essential that the competent authority has the full capability to adequately assess the continued competence of an organisation by ensuring that the whole range of activities is assessed by appropriately qualified personnel.
- (b) For each inspector, the competent authority should:
- (1) define the competencies required to perform the allocated certification and oversight tasks;
 - (2) define the associated minimum qualification requirements;
 - (3) establish initial and recurrent training programmes in order to maintain and to enhance inspector competency at the level necessary to perform the allocated tasks; and
 - (4) ensure that the training provided meets the established standards and is regularly reviewed and updated whenever necessary.
- (c) The competent authority may provide training through its own training organisation with qualified trainers or through another qualified training source.
- (d) When training is not provided through an internal training organisation, adequately experienced and qualified persons may act as trainers, provided their training skills have been assessed. If required, an individual training plan should be established covering specific training skills. Records should be kept of such training and the assessment, as appropriate.

AMC2 ARO.GEN.200(a)(2) Management system

ED Decision 2017/006/R

QUALIFICATION AND TRAINING — INSPECTORS

(a) Initial training programme:

The initial training programme for inspectors should include, as appropriate to their role, current knowledge, experience and skills in at least all of the following:

- (1) aviation legislation organisation and structure;
- (2) the Chicago Convention, relevant ICAO annexes and documents;
- (3) overview of Regulation (EC) No 216/2008, its implementing rules and the related AMC, CS, and GM;
- (4) Regulation (EU) No 965/2012 as well as other applicable requirements;
- (5) management systems, including the assessment of the effectiveness of a management system, in particular hazard identification and risk assessment, and non-punitive reporting techniques in the context of the implementation of a 'just culture';
- (6) auditing techniques;
- (7) competent authority procedures relevant to the inspectors' tasks;
- (8) human factors principles;
- (9) rights and obligations of inspecting personnel of the competent authority;
- (10) 'on-the-job' training, relevant to the inspector's tasks;
- (11) technical training, including training on aircraft-specific subjects, appropriate to the role and tasks of the inspector, in particular for those areas requiring approvals.

(b) Recurrent training programme:

Once qualified, the inspector should undergo training periodically as well as whenever deemed necessary by the competent authority in order to remain competent to perform the allocated tasks. The recurrent training programme for inspectors should include, as appropriate to their role, at least the following topics:

- (1) changes in aviation legislation, operational environment and technologies;
- (2) competent authority procedures relevant to the inspector's tasks;
- (3) technical training, including training on aircraft-specific subjects, appropriate to the role and tasks of the inspector; and
- (4) results from past oversight.

(c) An assessment of an inspector's competency should take place at regular intervals not exceeding three years.

AMC3 ARO.GEN.200(a)(2) Management system

ED Decision 2015/022/R

QUALIFICATION AND TRAINING — CREW RESOURCE MANAGEMENT (CRM)

For the oversight of the operator's CRM training, the inspectors of the competent authority should be qualified and trained as follows:

(a) Qualification

To fulfil the qualification provisions, inspectors should:

- (1) have adequate knowledge of the relevant flight operations;
- (2) have adequate knowledge of human performance and limitations (HPL);
- (3) have completed initial CRM training;
- (4) have received additional training in the fields of group management, group dynamics and personal awareness; and
- (5) have experience in the assessment of the effectiveness of training programmes and management systems.

(b) Training

The training of inspectors should be both theoretical and practical, and should include:

- (1) in-depth knowledge of the CRM training elements as laid down in Part-ORO; and
- (2) specific skills for the oversight of the operator's CRM training including the assessment of non-technical skills using proper techniques and methodologies.

AMC4 ARO.GEN.200(a)(2) Management system¹

ED Decision 2017/006/R

INSPECTOR QUALIFICATION FOR CAT OPERATIONS

(a) For CAT operations of aircraft with an MOPSC of more than 19 seats or with an MCTOM of more than 45 360 kg, an inspector who performs initial certification or oversight tasks relating to:

- (1) the flight crew operating procedures contained in Part B (e.g. Chapters B-2, B-3, and B-9) of the Operations Manual (OM), or
- (2) the aircraft/FSTD part of the flight crew training syllabi and checking programmes contained in Part D of the OM,

should have the following qualifications:

- (i) operational experience in air transport operations appropriate to the allocated tasks;
- (ii) experience in either operational management within an air transport operation; or as an examiner; or as an instructor; and
- (iii) hold or have held a valid type rating on the aircraft type concerned; or a class rating as appropriate; or a rating on aircraft types/classes with similar technical and operational characteristics.

(b) For CAT operations with an MOPSC of 19 seats or less, the authority should establish the inspector qualifications required to perform the allocated initial certification and oversight tasks. The assigned inspector should undergo theoretical training on aircraft systems and operations.

¹ Please note that this AMC shall not apply to inspecting staff already qualified as inspector to perform oversight tasks, as per Article 3 of EASA [ED Decision 2017/006/R](#).

- (c) For in-flight inspections of CAT operations, the inspector should have relevant knowledge of the route and area.

AMC5 ARO.GEN.200(a)(2) Management system

ED Decision 2017/006/R

FATIGUE RISK MANAGEMENT INSPECTOR TRAINING

An inspector involved in the approval process of operator's flight time specification schemes and fatigue risk management (FRM) should receive the following training:

- (a) Initial training
- (1) Theory and effects of fatigue
 - (2) Human factors related to fatigue
 - (3) Typical hazards and risks related to fatigue, their possible mitigation measures, and the maturity of hazard identification models (reactive, proactive and predictive)
 - (4) FRM training and promotion methodologies and how to support ongoing development of FRM
 - (5) Data collection and analysis methods related to FRM
 - (6) Integration of FRM into the Management System
 - (7) Fatigue management documentation, implementation and assurance methodologies
 - (8) Regulatory framework and current best practices
 - (9) Auditing and assessment of the effectiveness of an operator's FRM
- (b) Recurrent training (at least every 3 years)
- (1) Review of FRM implementation issues
 - (2) Recent incidents related to fatigue
 - (3) New FRM developments
 - (4) Review of changes in legislation, and best practices.

GM1 ARO.GEN.200(a)(2) Management System

ED Decision 2017/006/R

SUFFICIENT PERSONNEL

- (a) This GM on the determination of the required personnel is limited to the performance of certification, authorisation and oversight tasks, excluding personnel required to perform tasks subject to any national regulatory requirements.
- (b) The elements to be considered when determining required personnel and planning their availability may be divided into quantitative and qualitative elements:
- (1) Quantitative elements:
 - (i) the estimated number of initial certificates to be issued;
 - (ii) the number of organisations certified by the competent authority;
 - (iii) the number of persons to whom the competent authority has issued a licence, certificate, rating, authorisation or attestation;

- (iv) the estimated number of persons and organisations, as well as the estimated number of subcontracted organisations used by those persons and organisations, exercising their activity within the territory of the Member State and established or residing in another Member State;
 - (v) the number of organisations having declared their activity to the competent authority;
 - (vi) the number of organisations holding a specialised operations authorisation issued by the competent authority.
- (2) Qualitative elements:
- (i) the size, nature and complexity of activities of certified, authorised and declared organisations (cf. [AMC1 ORO.GEN.200\(b\)](#)), taking into account:
 - (A) privileges of the organisation;
 - (B) type of approval, scope of approval, multiple certification, authorisation and declared activities;
 - (C) possible certification to industry standards;
 - (D) types of aircraft/flight simulation training devices (FSTDs) operated;
 - (E) number of personnel; and
 - (F) organisational structure, existence of subsidiaries;
 - (ii) the safety priorities identified;
 - (iii) the results of past oversight activities, including audits, inspections and reviews, in terms of risks and regulatory compliance, taking into account:
 - (A) number and level of findings;
 - (B) timeframe for implementation of corrective actions; and
 - (C) maturity of management systems implemented by organisations and their ability to effectively manage safety risks, taking into account also information provided by other competent authorities related to activities in the territory of the Member States concerned; and
 - (iv) the size and complexity of the Member State's aviation industry and the potential growth of activities in the field of civil aviation, which may be an indication of the number of new applications and changes to existing certificates and authorisations to be expected.
- (c) Based on existing data from previous oversight planning cycles and taking into account the situation within the Member State's aviation industry, the competent authority may estimate:
- (1) the standard working time required for processing applications for new certificates (for persons and organisations) and authorisations;
 - (2) the number of new declarations or changed declarations;
 - (3) the number of new certificates and authorisations to be issued for each planning period; and
 - (4) the number of changes to existing certificates and authorisations to be processed for each planning period.

-
- (d) In line with the competent authority's oversight policy, the following planning data should be determined specifically for each type of organisation certified by the competent authority as well as for declared organisations, including those being authorised:
- (1) standard number of audits to be performed per oversight planning cycle;
 - (2) standard duration of each audit;
 - (3) standard working time for audit preparation, on-site audit, reporting and follow-up, per inspector;
 - (4) standard number of ramp and unannounced inspections to be performed;
 - (5) standard duration of inspections, including preparation, reporting and follow-up, per inspector;
 - (6) minimum number and required qualification of inspectors for each audit/inspection.
- (e) Standard working time could be expressed either in working hours per inspector or in working days per inspector. All planning calculations should then be based on the same unit (hours or working days).
- (f) It is recommended to use a spreadsheet application to process data defined under (c) and (d), to assist in determining the total number of working hours/days per oversight planning cycle required for certification, authorisation, oversight and enforcement activities. This application could also serve as a basis for implementing a system for planning the availability of personnel.
- (g) For each type of organisation certified or high risk commercial specialised operation authorised by the competent authority, the number of working hours/days per planning period for each qualified inspector that may be allocated for certification, authorisation, oversight and enforcement activities should be determined, taking into account:
- (1) purely administrative tasks not directly related to oversight and certification/authorisation;
 - (2) training;
 - (3) participation in other projects;
 - (4) planned absence; and
 - (5) the need to include a reserve for unplanned tasks or unforeseeable events.
- (h) The determination of working time available for certification, authorisation, oversight and enforcement activities should also consider:
- (1) the possible use of qualified entities; and
 - (2) possible cooperation with other competent authorities for approvals or authorisations involving more than one Member State.
- (i) Based on the elements listed above, the competent authority should be able to:
- (1) monitor dates when audits and inspections are due and when they have been carried out;
 - (2) implement a system to plan the availability of personnel; and
 - (3) identify possible gaps between the number and qualification of personnel and the required volume of certification/authorisation and oversight.

Care should be taken to keep planning data up-to-date in line with changes in the underlying planning assumptions, with particular focus on risk-based oversight principles.

GM2 ARO.GEN.200(a)(2) Management system

ED Decision 2017/006/R

INSPECTOR COMPETENCY

- (a) Competency is a combination of individual skills, practical and theoretical knowledge, attitude, training, and experience.
- (b) An inspector should, by his/her qualifications and competencies, command the professional respect of the inspected personnel.

GM3 ARO.GEN.200(a)(2) Management system

ED Decision 2016/006/R

SPECIFIC FLIGHT OPERATIONS INSPECTOR QUALIFICATION

- (a) The following characteristics should be considered in order to establish aircraft types/classes with similar technical and operational characteristics:
 - (1) Engine technology;
 - (2) Certification basis;
 - (3) Level of automation;
 - (4) Flight controls logic (e.g. fly-by-wire, conventional, etc.); and
 - (5) Size and mass of the aircraft (e.g. maximum take-off mass, wake turbulence category, etc.).
- (b) The following factors should be considered with regard to knowledge of the route and area:
 - (1) Climatological conditions, e.g. exceptionally cold weather;
 - (2) Availability of adequate aerodromes and their specific features, e.g. high elevation, poor English/communication capability, exceptional approach procedures;
 - (3) Navigational procedures, including PBN requirements, ETOPS and extended diversion time requirements;
 - (4) Communication procedures, including required communication performance, any specific and contingency procedures, e.g. loss of communication, drift down, oxygen escape; and
 - (5) Equipment requirements related to search and rescue, e.g. polar, desert operations, oceanic, remote areas.

GM4 ARO.GEN.200(a)(2) Management system

ED Decision 2017/006/R

INSPECTOR TRAINING PROGRAMMES

- (a) The competent authority may adapt the duration and depth of the individual training programme of an inspector, provided the required competencies are achieved and maintained.
- (b) The following documents, as appropriate to the role of the inspector, are relevant for the initial training programme for inspectors referred to in [AMC2 ARO.GEN.200\(a\)\(2\)](#):

- (1) The Chicago Convention and relevant ICAO annexes and documents
- (2) Regulation (EU) No 376/2014 (Occurrences in civil aviation)
- (3) Regulation (EC) No 216/2008, and related implementing rules such as:
 - (i) Regulation (EU) No 1178/2011 (Air Crew Regulation);
 - (ii) Regulation (EU) No 1332/2011;(Part-AUR);
 - (iii) Regulation (EU) No 923/2012 (Part-SERA);
 - (iv) Regulation (EU) No 748/2012 (OSD); and
 - (v) Regulation (EU) No 1321/2014 (Part-M, Part-145).
- (c) The duration of the on-the-job training should take into account the scope and complexity of the inspector's tasks. The competent authority should assess whether the required competence has been achieved before an inspector is authorised to perform a task without supervision.

GM5 ARO.GEN.200(a)(2) Management system

ED Decision 2017/006/R

FATIGUE RISK MANAGEMENT INSPECTOR TRAINING

'Theory and effects of fatigue' refers to:

- (a) sleep;
- (b) circadian rhythm;
- (c) adaptation (acclimatisation) after time-jet zone crossing (westbound and eastbound) and jet lag;
- (d) shift work;
- (e) bio-mathematical fatigue models; and
- (f) measurement of fatigue.

GM6 ARO.GEN.200(a)(2) Management system

ED Decision 2017/006/R

FATIGUE RISK MANAGEMENT INSPECTOR TRAINING

Guidance on training for inspectors on fatigue risk management is contained in ICAO Doc 9966 (Manual for the Oversight of Fatigue Management Approaches).

GM7 ARO.GEN.200(a)(2) Management system

ED Decision 2017/006/R

INSPECTOR EXPERIENCE IN EITHER OPERATIONAL MANAGEMENT WITHIN AN AIR TRANSPORT OPERATION OR AS AN INSTRUCTOR OR AS AN EXAMINER

The inspector assigned to certification and oversight tasks should have sufficient experience in roles that enable a thorough understanding of the operational processes.

- (a) Experience in operational management refers to previous appointments in functions of organisational relevance, such as in any of the areas below:
 - (1) flight operations and operational control;

- (2) flight crew training; and
- (3) management system.

Such appointments should not be limited to senior management functions such as nominated persons in accordance with point (b) of [ORO.GEN.210](#). It is important that the inspector assigned to certification and oversight tasks in accordance with [AMC4 ARO.GEN.200\(a\)\(2\)](#) have sufficient experience which enables a thorough understanding of the operational processes within air transport operations.

- (b) In the context of the approval and oversight of aircraft specific flight crew training and checking, the inspector should have experience as an instructor.

AMC1 ARO.GEN.200(d) Management system

ED Decision 2014/025/R

PROCEDURES AVAILABLE TO THE AGENCY

- (a) Copies of the procedures related to the competent authority's management system and their amendments to be made available to the Agency for the purpose of standardisation should provide at least the following information:
 - (1) Regarding continuing oversight functions undertaken by the competent authority, the competent authority's organisational structure with description of the main processes. This information should demonstrate the allocation of responsibilities within the competent authority, and that the competent authority is capable of carrying out the full range of tasks regarding the size and complexity of the Member State's aviation industry. It should also consider overall proficiency and authorisation scope of competent authority personnel.
 - (2) For personnel involved in oversight activities, the minimum professional qualification requirements and experience and principles guiding appointment (e.g. assessment).
 - (3) How the following are carried out: assessing applications and evaluating compliance, issuance of certificates and authorisations, performance of continuing oversight, follow-up of findings, enforcement measures and resolution of safety concerns.
 - (4) Principles of managing exemptions and derogations.
 - (5) Processes in place to disseminate applicable safety information for timely reaction to a safety problem.
 - (6) Criteria for planning continuing oversight (oversight programme), including adequate management of interfaces when conducting continuing oversight (air operations, flight crew licensing, continuing airworthiness management for example).
 - (7) Outline of the initial training of newly recruited oversight personnel (taking future activities into account), and the basic framework for continuation training of oversight personnel.
- (b) As part of the continuous monitoring of a competent authority, the Agency may request details of the working methods used, in addition to the copy of the procedures of the competent authority's management system (and amendments). These additional details are the procedures and related guidance material describing working methods for competent authority personnel conducting oversight.
- (c) Information related to the competent authority's management system may be submitted in electronic format.

ARO.GEN.205 Allocation of tasks to qualified entities

Regulation (EU) No 379/2014

- (a) Tasks related to the initial certification, specialised operation authorisation or continuing oversight of persons or organisations subject to Regulation (EC) No 216/2008 and its Implementing Rules shall be allocated by Member States only to qualified entities. When allocating tasks, the competent authority shall ensure that it has:
- (1) put a system in place to initially and continuously assess that the qualified entity complies with Annex V to Regulation (EC) No 216/2008.
This system and the results of the assessments shall be documented.
 - (2) established a documented agreement with the qualified entity, approved by both parties at the appropriate management level, which clearly defines:
 - (i) the tasks to be performed;
 - (ii) the declarations, reports and records to be provided;
 - (iii) the technical conditions to be met in performing such tasks;
 - (iv) the related liability coverage; and
 - (v) the protection given to information acquired in carrying out such tasks.
- (b) The competent authority shall ensure that the internal audit process and safety risk management process required by [ARO.GEN.200\(a\)\(4\)](#) covers all certification, authorisation or continuing oversight tasks performed on its behalf.

ARO.GEN.210 Changes in the management system

Regulation (EU) No 965/2012

- (a) The competent authority shall have a system in place to identify changes that affect its capability to perform its tasks and discharge its responsibilities as defined in Regulation (EC) No 216/2008 and its Implementing Rules. This system shall enable it to take action as appropriate to ensure that its management system remains adequate and effective.
- (b) The competent authority shall update its management system to reflect any change to Regulation (EC) No 216/2008 and its Implementing Rules in a timely manner, so as to ensure effective implementation.
- (c) The competent authority shall notify the Agency of changes affecting its capability to perform its tasks and discharge its responsibilities as defined in Regulation (EC) No 216/2008 and its Implementing Rules.

ARO.GEN.220 Record-keeping

Regulation (EU) 2015/140

- (a) The competent authority shall establish a system of record-keeping providing for adequate storage, accessibility and reliable traceability of:
- (1) the management system's documented policies and procedures;
 - (2) training, qualification and authorisation of its personnel;
 - (3) the allocation of tasks, covering the elements required by [ARO.GEN.205](#) as well as the details of tasks allocated;

- (4) certification processes and continuing oversight of certified organisations;
 - (4a) the process of authorisation of a high risk commercial specialised operation and continuing oversight of an authorisation holder;
 - (5) declaration processes and continuing oversight of declared organisations;
 - (6) details of training courses provided by certified organisations, and if applicable, records relating to FSTDs used for such training;
 - (7) oversight of persons and organisations exercising activities within the territory of the Member State, but overseen, certified or authorised by the competent authority of another Member State or the Agency, as agreed between these authorities;
 - (8) oversight of operations of other-than complex motor-powered aircraft by non-commercial operators;
 - (9) the evaluation and notification to the Agency of alternative means of compliance proposed by organisations subject to certification, or authorisation and the assessment of alternative means of compliance used by the competent authority itself;
 - (10) findings, corrective actions and date of action closure;
 - (11) enforcement measures taken;
 - (12) safety information and follow-up measures; and
 - (13) the use of flexibility provisions in accordance with Article 14 of Regulation (EC) No 216/2008.
- (b) The competent authority shall maintain a list of all organisation certificates and specialised operations authorisations it issued as well as declarations it received.
- (c) All records shall be kept for the minimum period specified in this Regulation. In the absence of such indication, records shall be kept for a minimum period of five years subject to applicable data protection law.

AMC1 ARO.GEN.220(a) Record-keeping

ED Decision 2014/025/R

GENERAL

- (a) The record-keeping system should ensure that all records are accessible whenever needed within a reasonable time. These records should be organised in a way that ensures traceability and retrievability throughout the required retention period.
- (b) Records should be kept in paper form or in electronic format or a combination of both media. Records stored on microfilm or optical disc form are also acceptable. The records should remain legible and accessible throughout the required retention period. The retention period starts when the record has been created.
- (c) Paper systems should use robust material, which can withstand normal handling and filing. Computer systems should have at least one backup system, which should be updated within 24 hours of any new entry. Computer systems should include safeguards against unauthorised alteration of data.
- (d) All computer hardware used to ensure data backup should be stored in a different location from that containing the working data and in an environment that ensures they remain in good condition. When hardware or software changes take place, special care should be taken that all

necessary data continue to be accessible at least through the full period specified in the relevant Subpart or by default in [ARO.GEN.220\(c\)](#).

AMC1 ARO.GEN.220(a)(1);(2);(3) Record-keeping

ED Decision 2014/025/R

COMPETENT AUTHORITY MANAGEMENT SYSTEM

Records related to the competent authority's management system should include, as a minimum and as applicable:

- (a) the documented policies and procedures;
- (b) the personnel files of competent authority personnel, with supporting documents related to training and qualifications;
- (c) the results of the competent authority's internal audit and safety risk management processes, including audit findings and corrective actions; and
- (d) the contract(s) established with qualified entities performing certification, authorisation or oversight tasks on behalf of the competent authority.

AMC1 ARO.GEN.220(a)(4);(4a) Record-keeping

ED Decision 2014/025/R

ORGANISATIONS

Records related to an organisation certified or operations authorised by or having declared its activity to the competent authority should include, as appropriate to the type of organisation:

- (a) the application for an organisation approval, a specialised operation authorisation or the declaration received;
- (b) the documentation based on which the approval or authorisation has been granted and any amendments to that documentation;
- (c) the organisation approval certificate or specialised operation authorisation, including any changes;
- (d) a copy of the continuing oversight programme listing the dates when audits are due and when such audits were carried out;
- (e) continuing oversight records, including all audit and inspection records;
- (f) copies of all relevant correspondence;
- (g) details of any exemption and enforcement actions;
- (h) any report from other competent authorities relating to the oversight of the organisation; and
- (i) a copy of any other document approved by the competent authority.

GM1 ARO.GEN.220(a)(4) Record-keeping

ED Decision 2014/025/R

ORGANISATIONS — DOCUMENTATION

Documentation to be kept as records in support of the approval includes the management system documentation, including any technical manuals, such as the operations manual, and training manual, that have been submitted with the initial application, and any amendments to these documents.

GM1 ARO.GEN.220(a)(4a) Record-keeping

ED Decision 2014/025/R

AUTHORISATION HOLDERS — DOCUMENTATION

Documentation to be kept as records in support of the authorisation of a high risk commercial specialised operation include the risk assessment documentation and related standard operating procedures (SOP), as well as a description of the management system of the proposed operation and a statement that all the documentation sent to the competent authority has been verified by the operator and found in compliance with the applicable requirements. Any amendments to these documents should be documented.

AMC1 ARO.GEN.220(a)(7) Record-keeping

ED Decision 2014/025/R

ACTIVITIES PERFORMED IN THE TERRITORY OF A MEMBER STATE BY PERSONS OR ORGANISATIONS ESTABLISHED OR RESIDING IN ANOTHER MEMBER STATE

- (a) Records related to the oversight of activities performed in the territory of a Member State by persons or organisations established or residing in another Member State should include, as a minimum:
- (1) oversight records, including all audit and inspection records and related correspondence;
 - (2) copies of all relevant correspondence to exchange information with other competent authorities relating to the oversight of such persons/organisations;
 - (3) details of any enforcement measures and penalties; and
 - (4) any report from other competent authorities relating to the oversight of these persons/organisations, including any notification of evidence showing non-compliance with the applicable requirements.
- (b) Records should be kept by the competent authority having performed the audit or inspection and should be made available to other competent authorities at least in the following cases:
- (1) serious incidents or accidents;
 - (2) findings through the oversight programme where organisations certified or authorised by another competent authority are involved, to determine the root cause;
 - (3) an organisation being certified, authorised or having approvals in several Member States.
- (c) When records are requested by another competent authority, the reason for the request should be clearly stated.
- (d) The records can be made available by sending a copy or by allowing access to them for consultation.

GM1 ARO.GEN.220 Record-keeping

ED Decision 2014/025/R

GENERAL

Records are required to document results achieved or to provide evidence of activities performed. Records become factual when recorded. Therefore, they are not subject to version control. Even when a new record is produced covering the same issue, the previous record remains valid.

SECTION III – OVERSIGHT, CERTIFICATION AND ENFORCEMENT

ARO.GEN.300 Oversight

Regulation (EU) 2019/1384

- (a) The competent authority shall verify:
- (1) compliance with the requirements applicable to organisations or type of operations prior to the issue of a certificate, approval or authorisation, as applicable;
 - (2) continued compliance with the applicable requirements of organisations it has certified, specialised operations it has authorised and organisations from which it received a declaration;
 - (3) continued compliance with the applicable requirements of non-commercial operators of other-than complex motor-powered aircraft; and
 - (4) implementation of appropriate safety measures mandated by the competent authority as defined in [ARO.GEN.135\(c\) and \(d\)](#).
- (b) This verification shall:
- (1) be supported by documentation specifically intended to provide personnel responsible for safety oversight with guidance to perform their functions;
 - (2) provide the persons and organisations concerned with the results of safety oversight activity;
 - (3) be based on audits and inspections, including ramp and unannounced inspections; and
 - (4) provide the competent authority with the evidence needed in case further action is required, including the measures foreseen by [ARO.GEN.350](#) and [ARO.GEN.355](#).
- (c) The scope of oversight defined in (a) and (b) shall take into account the results of past oversight activities and the safety priorities.
- (d) Without prejudice to the competences of the Member States and to their obligations as set out in ARO.RAMP, the scope of the oversight of activities performed in the territory of a Member State by persons or organisations established or residing in another Member State shall be determined on the basis of the safety priorities, as well as of past oversight activities.
- (e) Where the activity of a person or organisation involves more than one Member State or the Agency, the competent authority responsible for the oversight under (a) may agree to have oversight tasks performed by the competent authority(ies) of the Member State(s) where the activity takes place or by the Agency. Any person or organisation subject to such agreement shall be informed of its existence and of its scope.
- (f) The competent authority shall collect and process any information deemed useful for oversight, including for ramp and unannounced inspections.

AMC1 ARO.GEN.300(a);(b);(c) Oversight

ED Decision 2017/006/R

GENERAL

The competent authority should assess the organisation and monitor its continued competence to conduct safe operations in compliance with the applicable requirements. The competent authority should ensure that accountability for assessing organisations is clearly defined. This accountability

may be delegated or shared, in whole or in part. Where more than one competent authority is involved, a responsible person should be appointed under whose personal authority organisations are assessed.

AMC2 ARO.GEN.300(a);(b);(c) Oversight

ED Decision 2014/025/R

EVALUATION OF OPERATIONAL SAFETY RISK ASSESSMENT

As part of the initial certification or the continuing oversight of an operator, the competent authority should normally evaluate the operator's safety risk assessment processes related to hazards identified by the operator as having an interface with its operations. These safety risk assessments should be identifiable processes of the operator's management system.

As part of its continuing oversight, the competent authority should also remain satisfied as to the effectiveness of these safety risk assessments.

(a) General methodology for operational hazards

The competent authority should establish a methodology for evaluating the safety risk assessment processes of the operator's management system.

When related to operational hazards, the competent authority's evaluation under its normal oversight process should be considered satisfactory if the operator demonstrates its competence and capability to:

- (1) understand the hazards and their consequences on its operations;
- (2) be clear on where these hazards may exceed acceptable safety risk limits;
- (3) identify and implement mitigations, including suspension of operations where mitigation cannot reduce the risk to within safety risk limits;
- (4) develop and execute effectively robust procedures for the preparation and the safe operation of the flights subject to the hazards identified;
- (5) assess the competence and currency of its staff in relation to the duties necessary for the intended operations and implement any necessary training; and
- (6) ensure sufficient numbers of qualified and competent staff for such duties.

The competent authority should take into account that:

- (1) the operator's recorded mitigations for each unacceptable risk identified are in place;
- (2) the operational procedures specified by the operator with the most significance to safety appear to be robust; and
- (3) the staff on which the operator depends in respect of those duties necessary for the intended operations are trained and assessed as competent in the relevant procedures.

EVALUATION OF OPERATORS' VOLCANIC ASH SAFETY RISK ASSESSMENT

In addition to the general methodology for operational hazards, the competent authority's evaluation under its normal oversight process should also assess the operator's competence and capability to:

- (a) choose the correct information sources to use to interpret the information related to volcanic ash contamination forecast and to resolve correctly any conflicts among such sources; and

- (b) take account of all information from its type certificate holders (TCHs) concerning volcanic ash-related airworthiness aspects of the aircraft it operates, and the related pre-flight, in-flight and post flight precautions to be observed.

GM1 ARO.GEN.300(a);(b);(c) Oversight

ED Decision 2017/006/R

GENERAL

- (a) Responsibility for the conduct of safe operations lies with the organisation. Under these provisions a positive move is made towards devolving upon the organisation a share of the responsibility for monitoring the safety of operations. The objective cannot be attained unless organisations are prepared to accept the implications of this policy, including that of committing the necessary resources to its implementation. Crucial to the success of the policy is the content of Part-ORO, which requires the establishment of a management system by the organisation.
- (b) The competent authority should continue to assess the organisation's compliance with the applicable requirements, including the effectiveness of the management system. If the management system is judged to have failed in its effectiveness, then this in itself is a breach of the requirements which may, among others, call into question the validity of a certificate, if applicable.
- (c) The accountable manager is accountable to the competent authority as well as to those who may appoint him/her. It follows that the competent authority cannot accept a situation in which the accountable manager is denied sufficient funds, manpower or influence to rectify deficiencies identified by the management system.
- (d) Oversight of the organisation includes a review and assessment of the qualifications of nominated persons.

GM2 ARO.GEN.300(a);(b);(c) Oversight

ED Decision 2014/025/R

VOLCANIC ASH SAFETY RISK ASSESSMENT — ADDITIONAL GUIDANCE

Further guidance on the assessment of an operator's volcanic ash safety risk assessment is given in ICAO Doc 9974 (Flight safety and volcanic ash — Risk management of flight operations with known or forecast volcanic ash contamination).

GM3 ARO.GEN.300(a);(b);(c) Oversight

ED Decision 2015/022/R

CHECKLIST FOR CRM TRAINING OVERSIGHT

The following list includes the major elements for the monitoring of the operator's CRM training:

- (a) development of CRM training considering the operator's management system;
- (b) content of the CRM training syllabus;
- (c) qualification of CRM trainer;
- (d) training facilities:
 - (1) classroom;
 - (2) flight simulation training device (FSTD);

- (3) aircraft; and
- (4) cabin training device;
- (e) training methods:
 - (1) classroom training (instructions, presentations and behavioural exercises);
 - (2) computer-based training (CBT);
 - (3) line-oriented flight training (LOFT); and
 - (4) check or test;
- (f) training analysis:
 - (1) pre-course reading and study;
 - (2) integration of the different training methods;
 - (3) competence and performance of the trainer or instructor;
 - (4) assessment of flight crew members; and
 - (5) effectiveness of training.

GM4 ARO.GEN.300(a);(b);(c) Oversight

ED Decision 2016/008/R

OVERSIGHT OF AN OPERATOR CONVERSION COURSE (OCC) FOR MULTI-CREW PILOT LICENCE (MPL) HOLDERS

As part of the initial certification or the continuing oversight of an operator, the competent authority should include the assessment of the OCC provided to MPL holders, who undertake their first conversion course on a new type or at an operator other than the one that was involved in their training for the MPL.

The assessment of the OCC should evaluate whether the operator, in the process of development of the OCC, took the following aspects into account:

- the time elapsed after completion of the initial training, between base training and hiring, and the Line Flying Under Supervision (LIFUS);
- the necessary feedback loop between the Approved Training Organisation (ATO) and the operator involved in the licence training.

AMC1 ARO.GEN.300(a)(2) Oversight

ED Decision 2014/025/R

OPERATIONAL APPROVALS ISSUED BY NON-EU STATE OF REGISTRY

When verifying continued compliance of non-commercial operators using an aircraft registered in a third country holding operational approvals for operations in PBN, MNPS and RVSM airspace issued by a non-EU State of Registry, the competent authority should at least assess if:

- (a) the State of registry has established an equivalent level of safety, considering any differences notified to the ICAO Standards for RVSM, RNP, MNPS and MEL; or
- (b) there are reservations on the safety oversight capabilities and records of the State of registry; or
- (c) operators of the State of registry are subject to an operating ban pursuant Regulation (EC) No 2111/2005; or

- (d) relevant findings on the State of registry from audits carried out under international conventions exist; or
- (e) relevant findings on the State of registry from other safety assessment programmes of States exist.

GM1 ARO.GEN.300(d) Oversight

ED Decision 2014/025/R

ACTIVITIES WITHIN THE TERRITORY OF THE MEMBER STATE

- (a) Activities performed in the territory of the Member State by persons or organisations established or residing in another Member State include:
 - (1) activities of:
 - (i) organisations certified or authorised by or declaring their activity to the competent authority of any other Member State or the Agency; or
 - (ii) persons performing operations with other-than-complex motor-powered aircraft; and
 - (2) activities of persons holding a licence, certificate, rating, or attestation issued by the competent authority of any other Member State.
- (b) Audits and inspections of such activities, including ramp and unannounced inspections, should be prioritised towards those areas of greater safety concern, as identified through the analysis of data on safety hazards and their consequences in operations.

ARO.GEN.305 Oversight programme

Regulation (EU) 2015/140

- (a) The competent authority shall establish and maintain an oversight programme covering the oversight activities required by [ARO.GEN.300](#) and by ARO.RAMP.
- (b) For organisations certified by the competent authority, the oversight programme shall be developed taking into account the specific nature of the organisation, the complexity of its activities, the results of past certification and/or oversight activities required by ARO.GEN and ARO.RAMP and shall be based on the assessment of associated risks. It shall include within each oversight planning cycle:
 - (1) audits and inspections, including ramp and unannounced inspections as appropriate; and
 - (2) meetings convened between the accountable manager and the competent authority to ensure both remain informed of significant issues.
- (c) For organisations certified by the competent authority an oversight planning cycle not exceeding 24 months shall be applied.

The oversight planning cycle may be reduced if there is evidence that the safety performance of the organisation has decreased.

The oversight planning cycle may be extended to a maximum of 36 months if the competent authority has established that, during the previous 24 months:

- (1) the organisation has demonstrated an effective identification of aviation safety hazards and management of associated risks;

- (2) the organisation has continuously demonstrated under [ORO.GEN.130](#) that it has full control over all changes;
- (3) no level 1 findings have been issued; and
- (4) all corrective actions have been implemented within the time period accepted or extended by the competent authority as defined in [ARO.GEN.350\(d\)\(2\)](#).

The oversight planning cycle may be further extended to a maximum of 48 months if, in addition to the above, the organisation has established, and the competent authority has approved, an effective continuous reporting system to the competent authority on the safety performance and regulatory compliance of the organisation itself.

- (d) For organisations declaring their activity to the competent authority, the oversight programme shall be based on the specific nature of the organisation, the complexity of its activities and the data of past oversight activities and the assessment of risks associated with the type of activity carried out. It shall include audits and inspections, including ramp and unannounced inspections, as appropriate.
- (d1) For organisations holding a specialised operations authorisation, the oversight programme shall be established in accordance with (d) and shall also take into account the past and current authorisation process and the validity period of the authorisation.
- (e) For persons holding a licence, certificate, rating, or attestation issued by the competent authority the oversight programme shall include inspections, including unannounced inspections, as appropriate.
- (f) The oversight programme shall include records of the dates when audits, inspections and meetings are due and when such audits, inspections and meetings have been carried out.

AMC1 ARO.GEN.305(b);(d);(d1) Oversight programme

ED Decision 2017/006/R

SPECIFIC NATURE AND COMPLEXITY OF THE ORGANISATION, RESULTS OF PAST OVERSIGHT

- (a) When determining the oversight programme for an organisation, the competent authority should consider in particular the following elements, as applicable:
 - (1) the implementation by the organisation of industry standards, directly relevant to the organisation's activity subject to this Regulation;
 - (2) the procedure applied for and scope of changes not requiring prior approval;
 - (3) specific approvals held by the organisation;
 - (4) specific procedures implemented by the organisation related to any alternative means of compliance used; and
 - (5) number of subcontractors.
- (b) For the purpose of assessing the complexity of an organisation's management system, [AMC1 ORO.GEN.200\(b\)](#) should be used.
- (c) Regarding results of past oversight, the competent authority should also take into account relevant results of ramp inspections of organisations it has certified or authorised, persons and other organisation having declared their activity or persons performing operations with other-than-complex motor-powered aircraft that were performed in other Member States in accordance with ARO.RAMP.

AMC2 ARO.GEN.305(b) Oversight programme

ED Decision 2019/019/R

PROCEDURES FOR OVERSIGHT OF OPERATIONS

- (a) Each organisation to which a certificate has been issued should have an inspector specifically assigned to it. Several inspectors should be required for the larger companies with widespread or varied types of operation. This does not prevent a single inspector being assigned to several companies. Where more than one inspector is assigned to an organisation, one of them should be nominated as having overall responsibility for supervision of, and liaison with, the organisation's management, and be responsible for reporting on compliance with the requirements for its operations as a whole.
- (b) Audits and inspections, on a scale and frequency appropriate to the operation, should cover at least:
- (1) infrastructure,
 - (2) manuals,
 - (3) training,
 - (4) crew records,
 - (5) equipment,
 - (6) release of flight/dispatch,
 - (7) dangerous goods,
 - (8) organisation's management system.
- (c) The following types of inspections should be included, as part of the oversight programme:
- (1) flight inspection,
 - (2) ground inspection (e.g. documents and records),
 - (3) training inspection (e.g. ground, aircraft/FSTD),
 - (4) ramp inspection.
- The inspection should be a 'deep cut' through the items selected, and all findings should be recorded. Inspectors should review the root cause(s) identified by the organisation for each confirmed finding.
- The competent authority should be satisfied that the root cause(s) identified and the corrective actions taken are adequate to correct the non-compliance and to prevent re-occurrence.
- (d) Audits and inspections may be conducted separately or in combination. Audits and inspections may, at the discretion of the competent authority, be conducted with or without prior notice to the organisation.
- (e) Where it is apparent to an inspector that an organisation has permitted a breach of the applicable requirements, with the result that air safety has, or might have, been compromised, the inspector should ensure that the responsible person within the competent authority is informed without delay.
- (f) In the first few months of a new operation, inspectors should carry out oversight activities with a particular focus on the operator's procedures, facilities, equipment, operational control and management system. They should also carefully examine any conditions that may indicate a significant deterioration in the organisation's financial management. When any financial

difficulties are identified, inspectors should increase technical surveillance of the operation with particular emphasis on the upholding of safety standards.

- (g) The number or the magnitude of the non-compliances identified by the competent authority will serve to support the competent authority's continuing confidence in the organisation's competence or, alternatively, may lead to an erosion of that confidence. In the latter case, the competent authority should review any identifiable shortcomings of the management system.

GM1 ARO.GEN.305(b) Oversight programme

ED Decision 2014/025/R

FINANCIAL MANAGEMENT

Examples of trends that may indicate problems in a new organisation's financial management are:

- (a) significant lay-offs or turnover of personnel;
- (b) delays in meeting payroll;
- (c) reduction of safe operating standards;
- (d) decreasing standards of training;
- (e) withdrawal of credit by suppliers;
- (f) inadequate maintenance of aircraft;
- (g) shortage of supplies and spare parts;
- (h) curtailment or reduced frequency of revenue flights; and
- (i) sale or repossession of aircraft or other major equipment items.

GM1 ARO.GEN.305(b);(c);(d);(d1) Oversight programme

ED Decision 2017/006/R

STORAGE PERIODS OF RECORDS

If the organisation's oversight cycle has been extended, the minimum storage periods for records should be aligned with the extended oversight cycle to ensure that the competent authority has access to all relevant records.

AMC1 ARO.GEN.305(b)(1) Oversight programme

ED Decision 2014/025/R

AUDIT

- (a) The oversight programme should indicate which aspects of the approval will be covered with each audit.
- (b) Part of an audit should concentrate on the organisation's compliance monitoring reports produced by the compliance monitoring personnel to determine if the organisation is identifying and correcting its problems.
- (c) At the conclusion of the audit, an audit report should be completed by the auditing inspector, including all findings raised.

AMC2 ARO.GEN.305(b)(1) Oversight programme

ED Decision 2014/025/R

RAMP INSPECTIONS

- (a) When conducting a ramp inspection of aircraft used by organisations under its regulatory oversight, the competent authority should, as far as possible, comply with the requirements defined in ARO.RAMP.
- (b) When conducting ramp inspections on other-than-suspected aircraft, the competent authority should take into account the following elements:
 - (1) repeated inspections should be avoided of those organisations for which previous inspections have not revealed safety deficiencies;
 - (2) the oversight programme should enable the widest possible sampling rate of aircraft flying into their territory; and
 - (3) there should be no discrimination on the basis of the organisation's nationality, the type of operation or type of aircraft, unless such criteria can be linked to an increased risk.
- (c) For aircraft other than those used by organisations under its regulatory oversight, when conducting a risk assessment, the competent authority should consider aircraft that have not been ramp inspected for more than 6 months.

AMC1 ARO.GEN.305(b);(c);(d);(d1) Oversight programme

ED Decision 2014/025/R

INDUSTRY STANDARDS

- (a) For organisations having demonstrated compliance with industry standards, the competent authority may adapt its oversight programme, in order to avoid duplication of specific audit items.
- (b) Demonstrated compliance with industry standards should not be considered in isolation from the other elements to be considered for the competent authority's risk-based oversight.
- (c) In order to be able to credit any audits performed as part of certification in accordance with industry standards, the following should be considered:
 - (1) the demonstration of compliance is based on certification auditing schemes providing for independent and systematic verification;
 - (2) the existence of an accreditation scheme and accreditation body for certification in accordance with the industry standards has been verified;
 - (3) certification audits are relevant to the requirements defined in Annex III (Part-ORO) and other Annexes to this Regulation as applicable;
 - (4) the scope of such certification audits can easily be mapped against the scope of oversight in accordance with Annex III (Part-ORO);
 - (5) audit results are accessible to the competent authority and open to exchange of information in accordance with Article 15(1) of Regulation (EC) No 216/2008; and
 - (6) the audit planning intervals of certification audits i.a.w. industry standards are compatible with the oversight planning cycle.

AMC1 ARO.GEN.305(c) Oversight programme

ED Decision 2014/025/R

OVERSIGHT PLANNING CYCLE

- (a) When determining the oversight planning cycle and defining the oversight programme, the competent authority should assess the risks related to the activity of each organisation and adapt the oversight to the level of risk identified and to the organisation's ability to effectively manage safety risks.
- (b) The competent authority should establish a schedule of audits and inspections appropriate to each organisation's business. The planning of audits and inspections should take into account the results of the hazard identification and risk assessment conducted and maintained by the organisation as part of the organisation's management system. Inspectors should work in accordance with the schedule provided to them.
- (c) When the competent authority, having regard to an organisation's safety performance, varies the frequency of an audit or inspection, it should ensure that all aspects of the operation are audited and inspected within the applicable oversight planning cycle.
- (d) The section(s) of the oversight programme dealing with ramp inspections should be developed based on geographical locations, taking into account aerodrome activity, and focusing on key issues that can be inspected in the time available without unnecessarily delaying the operations.

AMC2 ARO.GEN.305(c) Oversight programme

ED Decision 2017/006/R

OVERSIGHT PLANNING CYCLE

- (a) For each organisation certified by the competent authority all processes should be completely audited at periods not exceeding the applicable oversight planning cycle. The beginning of the first oversight planning cycle is normally determined by the date of issue of the first certificate. If the competent authority wishes to align the oversight planning cycle with the calendar year, it should shorten the first oversight planning cycle accordingly.
- (b) The interval between two audits for a particular process should not exceed the interval of the applicable oversight planning cycle.
- (c) Audits should include at least one on-site audit within each oversight planning cycle. For organisations exercising their regular activity at more than one site, the determination of the sites to be audited should consider the results of past oversight, the volume of activity at each site, as well as main risk areas identified.
- (d) For organisations holding more than one certificate, the competent authority may define an integrated oversight schedule to include all applicable audit items. In order to avoid duplication of audits, credit may be granted for specific audit items already completed during the current oversight planning cycle, subject to four conditions:
 - (1) the specific audit item should be the same for all certificates under consideration;
 - (2) there should be satisfactory evidence on record that such specific audit items were carried out and that all corrective actions have been implemented to the satisfaction of the competent authority;
 - (3) the competent authority should be satisfied that there is no evidence that standards have deteriorated in respect of those specific audit items being granted a credit;

- (4) the interval between two audits for the specific item being granted a credit should not exceed the applicable oversight planning cycle.

AMC1 ARO.GEN.305(d) Oversight programme

ED Decision 2014/025/R

OVERSIGHT DECLARED ORGANISATIONS

- (a) When determining the oversight programme of organisations having declared their activity, the competent authority should make a selection of operators to be inspected/audited based on the elements specified in [ARO.GEN.305\(d\)](#).
- (b) For each selected operator an inspection is a sample inspection of the pre-defined inspection criteria on the basis of key risk elements and the applicable requirements.
- (c) The results of past oversight activities should include information from approval activities, e.g. SPA or from other survey programmes such as ACAM.
- (d) The oversight programme should also include a certain percentage of unannounced inspections.
- (e) The oversight programme should be developed on a yearly basis. All operators should be considered for inclusion into the programme not later than 12 months after the date of the first declaration received. At least one inspection should be performed within each 48-month cycle starting with the date of the first declaration received.
- (f) Additional audit/inspections to specific operators may be included in the oversight programme on the basis of the assessment of associated risks carried out within the occurrences reporting scheme(s).

AMC1 ARO.GEN.305(d1) Oversight programme

ED Decision 2014/025/R

OVERSIGHT OF AUTHORISATION HOLDERS

- (a) When determining the oversight programme of high risk commercial specialised operators holding an authorisation specialised operations authorisation holders, the competent authority should assess the risks related to the type of activity carried out by each organisation and adapt the oversight to the level of risk identified and to the organisation's ability to effectively manage safety risks.
- (b) An oversight cycle not exceeding 24 months should be applied. The oversight planning cycle may be extended to a maximum of 48 months if the competent authority has established that during the previous 24 months the organisation has been able to effectively manage safety risks.
- (c) The competent authority should establish a schedule of audits and/or inspections, including unannounced inspections, appropriate to each organisation's business. The planning of audits and inspections should take into account the results of the hazard identification and risk assessment conducted and maintained by the organisation as part of the organisation's management system. Inspectors should work in accordance with the schedule provided to them.
- (d) If the specialised operations authorisation is time limited, the competent authority should adapt the schedule of audits and inspections to the duration of the specialised operation authorisation. Audits or inspections may not be necessary if an authorisation is issued for a single flight or event.

- (e) When scheduling audits and inspections, the competent authority should also take into account the activity conducted by authorised organisations in other Member States. In this case the competent authority should coordinate the audit and inspection schedule with the authority of the Member State in which territory the activity is taking place.
- (f) Additional audits or inspections to specific operators may be included in the oversight programme on the basis of the assessment of associated risks carried out within the occurrences reporting scheme(s).

GM1 ARO.GEN.305(d1) Oversight programme

ED Decision 2014/025/R

OVERSIGHT OF AUTHORISATION HOLDERS

Past and current authorisation process refers to relevant results of past and current authorisation and oversight activities.

AMC1 ARO.GEN.305(e) Oversight programme

ED Decision 2014/025/R

PERSONS HOLDING A LICENCE, CERTIFICATE, RATING OR ATTESTATION

The oversight of persons holding a licence, certificate, rating or attestation should normally be ensured as part of the oversight of organisations. Additionally, the competent authority should verify compliance with applicable requirements when endorsing or renewing ratings.

To properly discharge its oversight responsibilities, the competent authority should perform a certain number of unannounced verifications.

ARO.GEN.310 Initial certification procedure – organisations

Regulation (EU) No 965/2012

- (a) Upon receiving an application for the initial issue of a certificate for an organisation, the competent authority shall verify the organisation's compliance with the applicable requirements. This verification may take into account the statement referred to in [ORO.AOC.100\(b\)](#).
- (b) When satisfied that the organisation is in compliance with the applicable requirements, the competent authority shall issue the certificate(s), as established in Appendices I and II. The certificate(s) shall be issued for an unlimited duration. The privileges and scope of the activities that the organisation is approved to conduct shall be specified in the terms of approval attached to the certificate(s).
- (c) To enable an organisation to implement changes without prior competent authority approval in accordance with [ORO.GEN.130](#), the competent authority shall approve the procedure submitted by the organisation defining the scope of such changes and describing how such changes will be managed and notified.

AMC1 ARO.GEN.310(a) Initial certification procedure – organisations

ED Decision 2017/006/R

VERIFICATION OF COMPLIANCE

- (a) Upon receipt of an application for an air operator certificate (AOC), the competent authority should:

- (1) assess the management system and processes, including the operator's organisation and operational control system;
 - (2) review the operations manual and any other documentation provided by the organisation; and
 - (3) for the purpose of verifying the organisation's compliance with the applicable requirements, conduct an audit at the organisation's facilities. The competent authority should require the conduct of one or more demonstration flights operated as if they were commercial flights, or an in-flight inspection should be conducted at the earliest opportunity.
- (b) The competent authority should ensure that the following steps are taken:
- (1) The organisation's written application for an AOC should be submitted at least 90 days before the date of intended operation, except that the operations manual may be submitted later, but not less than 60 days before the date of intended operation. The application form should be printed in language(s) of the competent authority's choosing.
 - (2) An individual should be nominated by the responsible person of the competent authority to oversee, to become the focal point for all aspects of the organisation certification process and to coordinate all necessary activity. The nominated person should be responsible to the responsible person of the competent authority for confirming that all appropriate audits and inspections have been carried out. He/she should also ensure that the necessary specific or prior approvals required by (b)(3) are issued in due course. Of particular importance on initial application is a careful review of the qualifications of the organisations' nominated persons. Account should be taken of the relevance of the nominee's previous experience and known record.
 - (3) Submissions that require the competent authority's specific or prior approval should be referred to the appropriate department of the competent authority. Submissions should include, where relevant, the associated qualification requirements and training programmes.
- (c) The ability of the applicant to secure, in compliance with the applicable requirements and the safe operation of aircraft, all necessary training and, where required, licensing of personnel, should be assessed. This assessment should also include the areas of responsibility and the numbers of those allocated by the applicant to key management tasks.
- (d) In order to verify the organisation's compliance with the applicable requirements, the competent authority should conduct an audit of the organisation, including interviews of personnel and inspections carried out at the organisation's facilities.
- The competent authority should only conduct such an audit after being satisfied that the application shows compliance with the applicable requirements.
- (e) The audit should focus on the following areas:
- (1) detailed management structure, including names and qualifications of personnel required by [ORO.GEN.210](#) and adequacy of the organisation and management structure;
 - (2) personnel:
 - (i) adequacy of number and qualifications with regard to the intended terms of approval and associated privileges;
 - (ii) validity of licences, ratings, certificates or attestations as applicable;

- (3) processes for safety risk management and compliance monitoring;
 - (4) facilities — adequacy with regard to the organisation's scope of work;
 - (5) documentation based on which the certificate should be granted (organisation documentation as required by Part-ORO, including technical manuals, such as operations manual or training manual).
- (f) In case of non-compliance, the applicant should be informed in writing of the corrections that are required.
- (g) When the verification process is complete, the person with overall responsibility, nominated in accordance with (b)(2), should present the application to the person responsible for the issue of an AOC together with a written recommendation and evidence of the result of all investigations or assessments which are required before the operator certificate is issued. Approvals required should be attached to the recommendation. The competent authority should inform the applicant of its decision concerning the application within 60 days of receipt of all supporting documentation. In cases where an application for an organisation certificate is refused, the applicant should be informed of the right of appeal as exists under national law.

ARO.GEN.330 Changes — organisations

Regulation (EU) No 965/2012

- (a) Upon receiving an application for a change that requires prior approval, the competent authority shall verify the organisation's compliance with the applicable requirements before issuing the approval.
- The competent authority shall prescribe the conditions under which the organisation may operate during the change, unless the competent authority determines that the organisation's certificate needs to be suspended.
- When satisfied that the organisation is in compliance with the applicable requirements, the competent authority shall approve the change.
- (b) Without prejudice to any additional enforcement measures, when the organisation implements changes requiring prior approval without having received competent authority approval as defined in (a), the competent authority shall suspend, limit or revoke the organisation's certificate.
- (c) For changes not requiring prior approval, the competent authority shall assess the information provided in the notification sent by the organisation in accordance with [ORO.GEN.130](#) to verify compliance with the applicable requirements. In case of any non-compliance, the competent authority shall:
- (1) notify the organisation about the non-compliance and request further changes;
 - (2) in case of level 1 or level 2 findings, act in accordance with [ARO.GEN.350](#).

AMC1 ARO.GEN.330 Changes – organisations

ED Decision 2019/019/R

AOC HOLDERS

- (a) Changes to personnel specified in Part-ORO:
- (1) Any changes to the accountable manager specified in [ORO.GEN.210\(a\)](#) that affect the certificate or terms of approval/approval schedule attached to it, require prior approval under [ARO.GEN.330\(a\)](#) and [ORO.GEN.130\(a\) and \(b\)](#).
 - (2) When an organisation submits the name of a new nominee for any of the persons nominated as per [ORO.GEN.210\(b\)](#) or for a safety manager as defined under [AMC1 ORO.GEN.200\(a\)\(1\)](#), the competent authority should require the organisation to produce a written résumé of the proposed person's qualifications. The competent authority should reserve the right to interview the nominee or call for additional evidence of his or her suitability before deciding upon his or her acceptability.
- (b) A simple management system documentation status sheet should be maintained, which contains information on when an amendment was received by the competent authority and when it was approved.
- (c) The organisation should provide each management system documentation amendment to the competent authority, including for the amendments that do not require prior approval by the competent authority. Where the amendment requires competent authority approval, the competent authority, when satisfied, should indicate its approval in writing. Where the amendment does not require prior approval, the competent authority should acknowledge receipt in writing within 10 working days.
- (d) For changes requiring prior approval, in order to verify the organisation's compliance with the applicable requirements, the competent authority should conduct an audit of the organisation, limited to the extent of the changes. If required for verification, the audit should include interviews and inspections carried out at the organisation's facilities.

GM1 ARO.GEN.330 Changes – organisations

ED Decision 2014/025/R

CHANGE OF NAME OF THE ORGANISATION

- (a) On receipt of the application and the relevant parts of the organisation's documentation as required by Part-ORO, the competent authority should re-issue the certificate.
- (b) A name change alone does not require the competent authority to audit the organisation, unless there is evidence that other aspects of the organisation have changed.

ARO.GEN.345 Declaration – organisations

Regulation (EU) 2018/1975

- (a) Upon receiving a declaration from an organisation carrying out or intending to carry out activities for which a declaration is required, the competent authority shall verify that the declaration contains all the information required:
- (1) pursuant to [ORO.DEC.100](#) of Annex III (Part-ORO) to this Regulation; or
 - (2) for balloon operators pursuant to BOP.ADD.100 of Annex II (Part-BOP) to Regulation (EU) 2018/395; or

- (3) for sailplane operators pursuant to SAO.DEC.100 of Annex II (Part-SAO) to Implementing Regulation (EU) 2018/1976.

After having verified the required information, the competent authority shall acknowledge receipt of the declaration to the organisation.

- (b) If the declaration does not contain the required information, or contains information that indicates non-compliance with applicable requirements, the competent authority shall notify the organisation about the non-compliance and request further information. If deemed necessary the competent authority shall carry out an inspection of the organisation. If the non-compliance is confirmed, the competent authority shall take action as defined in [ARO.GEN.350](#).

AMC1 ARO.GEN.345 Declaration – organisations

ED Decision 2014/025/R

ACKNOWLEDGEMENT OF RECEIPT

The competent authority should acknowledge receipt of the declaration in writing within 10 working days.

GM1 ARO.GEN.345 Declaration – organisations

ED Decision 2014/025/R

VERIFICATION — DECLARATION

The verification made by the competent authority upon receipt of a declaration does not imply an inspection. The aim is to check whether what is declared complies with applicable regulations.

ARO.GEN.350 Findings and corrective actions – organisations

Regulation (EU) 2019/1384

- (a) The competent authority for oversight in accordance with [ARO.GEN.300\(a\)](#) shall have a system to analyse findings for their safety significance.
- (b) A level 1 finding shall be issued by the competent authority when any significant non-compliance is detected with the applicable requirements of Regulation (EC) No 216/2008 and its Implementing Rules, with the organisation's procedures and manuals or with the terms of an approval, certificate, specialised operation authorisation or with the content of a declaration which lowers safety or seriously hazards flight safety.

The level 1 findings shall include:

- (1) failure to give the competent authority access to the facilities of the organisation in accordance with point [ORO.GEN.140](#) of Annex III (Part-ORO) to this Regulation, or for balloons operators in accordance with points BOP.ADD.015 and BOP.ADD.035 of Annex II (Part-BOP) to Regulation (EU) 2018/395, during normal operating hours and after two written requests;
- (2) obtaining or maintaining the validity of the organisation certificate or specialised operations authorisation by falsification of submitted documentary evidence;
- (3) evidence of malpractice or fraudulent use of the organisation certificate or specialised operations authorisation; and
- (4) the lack of an accountable manager.

- (c) A level 2 finding shall be issued by the competent authority when any non-compliance is detected with the applicable requirements of Regulation (EC) No 216/2008 and its Implementing Rules, with the organisation's procedures and manuals or with the terms of an approval, certificate, specialised operation authorisation or with the content of a declaration which could lower safety or hazard flight safety.
- (d) When a finding is detected during oversight or by any other means, the competent authority shall, without prejudice to any additional action required by Regulation (EC) No 216/2008 and its Implementing Rules, communicate the finding to the organisation in writing and request corrective action to address the non-compliance(s) identified. Where relevant, the competent authority shall inform the State in which the aircraft is registered.
- (1) In the case of level 1 findings the competent authority shall take immediate and appropriate action to prohibit or limit activities, and if appropriate, it shall take action to revoke the certificate, specialised operations authorisation or specific approval or to limit or suspend it in whole or in part, depending upon the extent of the level 1 finding, until successful corrective action has been taken by the organisation.
 - (2) In the case of level 2 findings, the competent authority shall:
 - (i) grant the organisation a corrective action implementation period appropriate to the nature of the finding that in any case initially shall not be more than three months. At the end of this period, and subject to the nature of the finding, the competent authority may extend the three-month period subject to a satisfactory corrective action plan agreed by the competent authority; and
 - (ii) assess the corrective action and implementation plan proposed by the organisation and, if the assessment concludes that they are sufficient to address the non-compliance(s), accept these.
 - (3) Where an organisation fails to submit an acceptable corrective action plan, or to perform the corrective action within the time period accepted or extended by the competent authority, the finding shall be raised to a level 1 finding and action taken as laid down in (d)(1).
 - (4) The competent authority shall record all findings it has raised or that have been communicated to it in accordance with point (e) and, where applicable, the enforcement measures it has applied, as well as all corrective actions and date of action closure for findings.
- (e) Without prejudice to any additional enforcement measures, when the authority of a Member State acting under the provisions of [ARO.GEN.300\(d\)](#) identifies any non-compliance with the applicable requirements of Regulation (EC) No 216/2008 and its Implementing Rules by an organisation certified by, or authorised by or declaring its activity to the competent authority of another Member State or the Agency, it shall inform that competent authority and provide an indication of the level of finding.

GM1 ARO.GEN.350 Findings and corrective actions – organisations

ED Decision 2014/025/R

TRAINING

For a level 1 finding it may be necessary for the competent authority to ensure that further training by the organisation is carried out and audited by the competent authority before the activity is resumed, dependent upon the nature of the finding.

GM2 ARO.GEN.350(d) Findings and corrective actions – organisations

ED Decision 2017/006/R

CORRECTIVE ACTION IMPLEMENTATION PERIOD

The 3-month period should commence from the date of the communication of the finding to the organisation in writing and requesting corrective action to address the non-compliance(s) identified.

ARO.GEN.355 Findings and enforcement measures – persons

Regulation (EU) No 379/2014

- (a) If, during oversight or by any other means, evidence is found by the competent authority responsible for oversight in accordance with [ARO.GEN.300\(a\)](#) that shows a non-compliance with the applicable requirements by a person holding a licence, certificate, rating or attestation issued in accordance with Regulation (EC) No 216/2008 and its Implementing Rules, the competent authority shall act in accordance with ARA.GEN.355(a) to (d) of Annex VI (Part-ARA) to Commission Regulation (EU) No 1178/2011¹.
- (b) If, during oversight or by any other means, evidence is found showing a non-compliance with the applicable requirements by a person subject to the requirements laid down in Regulation (EC) No 216/2008 and its Implementing Rules and not holding a licence, certificate, rating or attestation issued in accordance with that Regulation and its Implementing Rules, the competent authority that identified the non-compliance shall take any enforcement measures necessary to prevent the continuation of that non-compliance.

GM1 ARO.GEN.355(b) Findings and enforcement measures – persons

ED Decision 2014/025/R

GENERAL

This provision is necessary to ensure that enforcement measures will be taken also in cases where the competent authority may not act on the licence, certificate or attestation. The type of enforcement measure will depend on the applicable national law and may include for example the payment of a fine or the prohibition from exercising.

It covers two cases:

- (a) persons subject to the requirements laid down in Regulation (EC) No 216/2008 and its Implementing Rules who are not required to hold a licence, certificate or attestation; and
- (b) persons who are required to hold a licence, rating, certificate or attestation, but who do not hold the appropriate licence, rating, certificate or attestation as required for the activity they perform.

ARO.GEN.360 Findings and enforcement measures – all operators

Regulation (EU) No 379/2014

If, during oversight or by any other means, evidence is found showing a non-compliance with the applicable requirements by an operator subject to the requirements laid down in Regulation (EC)

¹ OJ L 100, 5.4.2012, p. 1.

No 216/2008 and its Implementing Rules, the competent authority that identified the non-compliance shall take any enforcement measures necessary to prevent the continuation of that non-compliance.

SUBPART OPS: AIR OPERATIONS

SECTION I – CERTIFICATION OF COMMERCIAL AIR TRANSPORT OPERATORS

ARO.OPS.100 Issue of the air operator certificate

Regulation (EU) No 379/2014

- (a) The competent authority shall issue the air operator certificate (AOC) when satisfied that the operator has demonstrated compliance with the elements required in [ORO.AOC.100](#).
- (b) The certificate shall include the associated operations specifications.
- (c) The competent authority may determine specific operational limitations. Such limitations shall be documented in the operations specifications.

GM1 ARO.OPS.100(b) Issue of the air operator certificate

ED Decision 2017/006/R

AREA OF OPERATION

- (a) If the area of operation within the operational specifications of [Appendix II](#) to Part-ARO is not defined as 'worldwide' or 'with no geographical limit', the competent authority should describe the boundaries of a permissible area of operation by listing for example:
 - (1) a continuous line between a list of coordinates (Lat./Long.);
 - (2) the national boundary of the State of issuance of the AOC;
 - (3) a flight information region (FIR) boundary;
 - (4) a combination of adjacent FIR boundaries;
 - (5) ICAO region(s) as per ICAO Doc 7030; and
 - (6) operations in the Inter-Tropical Convergence Zone (ICTZ).
- (b) The following factors should be taken into account when deciding the area of operation for CAT operations:
 - (1) The adequacy of the operational control and maintenance arrangements within the proposed area of operation.
 - (2) The general suitability of the aircraft which are to be used and in particular:
 - (i) the performance capability of the aircraft with regard to the terrain;
 - (ii) the need for any special equipment;
 - (iii) the aircraft systems and the level of redundancy of those systems, with regard to extremes of weather or climate; and
 - (iv) the need for any special dispatch minima with regard to the content of the MEL.
 - (3) Any special training required for:
 - (i) weather or climatic conditions likely to be encountered; and
 - (ii) compliance with specific approvals under Part-SPA (MNPS, RVSM, etc.).

- (4) The need for the flight crew to comply with non-standard ATC requirements such as the use of:
 - (i) non-standard phraseology;
 - (ii) altitude clearances in metres; and
 - (iii) altimeter settings in inches of mercury, wind speed in metres/sec, visibility in miles, etc.
- (5) The navigation and communication facilities available over the routes proposed and the associated equipment of the aircraft.
- (6) The adequacy of aerodromes or operating sites available within the proposed area, and the availability of current maps, charts, associated documents or equivalent data.
- (7) The availability of adequate search and rescue facilities, and the need to carry special survival equipment and the need for training in the use of the survival equipment.
- (8) Survival equipment available for the operator and installed in the aircraft used.

ARO.OPS.105 Code-share arrangements

Regulation (EU) No 965/2012

In considering the safety of a code-share agreement involving a third-country operator, the competent authority shall:

- (1) satisfy itself, following the verification by the operator as set out in [ORO.AOC.115](#), that the third-country operator complies with the applicable ICAO standards;
- (2) liaise with the competent authority of the State of the third-country operator as necessary.

AMC1 ARO.OPS.105 Code-share arrangements

ED Decision 2014/025/R

SAFETY OF A CODE-SHARE AGREEMENT

- (a) When evaluating the safety of a code-share agreement, the competent authority should check that the:
 - (1) documented information provided by the applicant in accordance with [ORO.AOC.115](#) is complete and shows compliance with the applicable ICAO standards; and
 - (2) operator has established a code-share audit programme for monitoring continuous compliance of the third country operator with the applicable ICAO standards.
- (b) The competent authority should request the applicant to make a declaration covering the above items.
- (c) In case of non-compliance, the applicant should be informed in writing of the corrections which are required.

AMC2 ARO.OPS.105 Code-share arrangements

ED Decision 2014/025/R

AUDITS PERFORMED BY A THIRD PARTY PROVIDER

When audits are performed by a third party provider, the competent authority should verify if the third party provider meets the criteria established in [AMC2 ORO.AOC.115\(b\)](#).

ARO.OPS.110 Lease agreements for aeroplanes and helicopters

Regulation (EU) 2019/138484

- (a) The competent authority shall approve a lease agreement when satisfied that the operator certified in accordance with Annex III (Part-ORO) complies with:
- (1) [ORO.AOC.110\(d\)](#), for dry leased-in third country aircraft;
 - (2) [ORO.AOC.110\(c\)](#), for wet lease-in of an aircraft from a third country operator;
 - (3) [ORO.AOC.110\(e\)](#), for dry lease-out of an aircraft to any operator, except for the cases specified in point ORO.GEN.310 of Annex III;
 - (4) relevant requirements of continuing airworthiness and air operations, for dry lease-in of an aircraft registered in the EU and wet lease-in of an aircraft from an EU operator.
- (b) The approval of a wet lease-in agreement shall be suspended or revoked whenever:
- (1) the AOC of the lessor or lessee is suspended or revoked;
 - (2) the lessor is subject to an operating ban pursuant to Regulation (EC) No 2111/2005¹ of the European Parliament and of the Council²;
 - (3) the authorisation issued in accordance with Commission Regulation (EU) No 452/2014³ has been suspended, revoked or surrendered.
- (c) The approval of a dry lease-in agreement shall be suspended or revoked whenever:
- (1) the certificate of airworthiness of the aircraft is suspended or revoked;
 - (2) the aircraft is included in the list of operators subject to operational restrictions or it is registered in a State of which all operators under its oversight are subject to an operating ban pursuant to Regulation (EC) No 2111/2005.
- (d) When asked for the prior approval of a dry-lease out agreement in accordance with [ORO.AOC.110\(e\)](#), the competent authority shall ensure:
- (1) proper coordination with the competent authority responsible for the continuing oversight of the aircraft, in accordance with Commission Regulation (EU) No 1321/2014⁴, or for the operation of the aircraft, if it is not the same authority;
 - (2) that the aircraft is timely removed from the operator's AOC except for the cases specified in point [ORO.GEN.310](#) of Annex III.
- (e) When asked for prior approval of a dry lease-in agreement in accordance with point [ORO.AOC.110\(d\)](#), the competent authority shall ensure proper coordination with the State of Registry of the aircraft as necessary to exercise the oversight responsibilities of the aircraft.

¹ Regulation (EC) No 2111/2005 of the European Parliament and of the Council of 14 December 2005 on the establishment of a Community list of air carriers subject to an operating ban within the Community and on informing air transport passengers of the identity of the operating air carrier, and repealing Article 9 of Directive 2004/36/EC (OJ L 344, 27.12.2005, p. 15).

² OJ L 344, 27.12.2005, p. 15.

³ Commission Regulation (EU) No 452/2014 of 29 April 2014 laying down technical requirements and administrative procedures related to air operations of third country operators pursuant to Regulation (EC) No 216/2008 of the European Parliament and of the Council (OJ L 133, 6.5.2014, p. 12).

⁴ Commission Regulation (EU) No 1321/2014 of 26 November 2014 on the continuing airworthiness of aircraft and aeronautical products, parts and appliances, and on the approval of organisations and personnel involved in these tasks (OJ L 362, 17.12.2014, p. 1).

AMC1 ARO.OPS.110 Lease agreements for aeroplanes and helicopters

ED Decision 2018/003/R

WET LEASE-IN

- (a) Before approving a wet lease-in agreement, the competent authority of the lessee should assess available reports on ramp inspections performed on aircraft of the lessor.
- (b) The competent authority should only approve a wet lease-in agreement if the routes intended to be flown are contained within the authorised areas of operations specified in the AOC of the lessor.

AMC2 ARO.OPS.110 Lease agreements for aeroplanes and helicopters

ED Decision 2018/003/R

SHORT TERM WET LEASE-IN

The competent authority of the lessee may approve third country operators individually or a framework contract with more than one third country operator in anticipation of operational needs or to overcome operational difficulties taking into account the conditions defined in Article 13(3) of Regulation (EC) No 1008/2008.

GM1 ARO.OPS.110 Lease agreements for aeroplanes and helicopters

ED Decision 2018/003/R

APPROVAL

- (a) Except for wet lease-out, approval for an EU operator to lease an aircraft of another operator should be issued by the competent authority of the lessee and the competent authority of the lessor.
- (b) When an EU operator leases an aircraft of an undertaking or person other than an operator, the competent authority of the lessee should issue the approval.

GM2 ARO.OPS.110 Lease agreements for aeroplanes and helicopters

ED Decision 2019/019/R

DRY LEASE-OUT

The purpose of the requirement for the competent authority to ensure proper coordination with the authority that is responsible for the oversight of the continuing airworthiness of the aircraft in accordance with Commission Regulation (EU) No 1321/2014¹ is to ensure that appropriate arrangements are in place to allow:

- (a) the transfer of regulatory oversight over the aircraft, if relevant; or
- (b) continued compliance of the aircraft with the requirements of Commission Regulation (EU) No 1321/2014.

¹ OJ L 362, 17.12.2014, p.1.

GM3 ARO.OPS.110 Lease agreement

ED Decision 2019/019/R

LONG-TERM WET LEASE-IN AGREEMENTS BETWEEN OPERATORS REGISTERED IN DIFFERENT EU MEMBER STATES

In case of a long-term wet lease-in agreement between operators having their principal place of business in different EU Member States, the competent authorities of the lessee and the competent authority of the lessor may consider a mutual exchange of all necessary information in accordance with [ARO.GEN.200\(c\)](#).

SECTION IA – AUTHORISATION OF HIGH RISK COMMERCIAL SPECIALISED OPERATIONS

ARO.OPS.150 Authorisation of high risk commercial specialised operations

Regulation (EU) 2019/1384

- (a) Upon receiving an application for the issue of a high risk commercial specialised operations authorisation, the competent authority of the operator shall review the operator's risk assessment documentation and standard operating procedures (SOP), related to one or more planned operations and developed in accordance with the relevant requirements of Annex VIII (Part-SPO).
- (b) When satisfied with the risk assessment and SOP, the competent authority of the operator shall issue the authorisation, as established in [Appendix IV](#). The authorisation may be issued for a limited or for unlimited duration. The conditions under which an operator is authorised to conduct one or more high risk commercial specialised operations shall be specified in the authorisation.
- (c) Upon receiving an application for a change to the authorisation, the competent authority of the operator shall comply with (a) and (b). It shall prescribe the conditions under which the operator may operate during the change, unless the competent authority determines that the authorisation needs to be suspended.
- (d) Upon receiving an application for the renewal of the authorisation, the competent authority of the operator shall comply with (a) and (b). It may take into account the past authorisation process and oversight activities.
- (e) Without prejudice to any additional enforcement measures, when the operator implements changes without having submitted an amended risk assessment and SOP, the competent authority of the operator shall suspend, limit or revoke the authorisation.
- (f) Upon receiving an application for the issue of an authorisation for a cross-border high risk commercial specialised operation, the competent authority of the operator shall review the operator's risk assessment documentation and standard operating procedures (SOP) in coordination with the competent authority of the place where the operation is planned to be conducted. When both authorities are satisfied with the risk assessment and SOP, the competent authority of the operator shall issue the authorisation.

AMC1 ARO.OPS.150 Authorisation of high risk commercial specialised operations

ED Decision 2014/025/R

GENERAL

The competent authority should make publicly available a list of activities of high risk commercial specialised operations so that operators are informed when to apply for an authorisation.

AMC1 ARO.OPS.150(a);(b) Authorisation of high risk commercial specialised operations

ED Decision 2014/025/R

VERIFICATION OF COMPLIANCE

- (a) For the purpose of verifying the operator's standard operating procedures (SOPs), the competent authority may conduct an audit at the operator's facilities or require the conduct of one or more demonstration flights operated as if they were high risk commercial specialised operations.
- (b) An individual should be nominated by the competent authority to become the focal point for all aspects of the authorisation process and to coordinate all necessary activity. This nominated person should confirm to the responsible person of the competent authority issuing the authorisation that all appropriate audits and inspections have been carried out.
- (c) When the verification process is complete, the person, nominated in accordance with (b), should present the application to the person responsible for the issuance of an authorisation together with a written recommendation and evidence of the result of the review of the operator's risk assessment documentation and SOPs, which is required before the authorisation is issued. The competent authority should inform the applicant of its decision concerning the application. In cases where an application for an authorisation is refused, the applicant should be informed of the right of appeal as exists under national law.

GM1 ARO.OPS.150(b) Authorisation of high risk commercial specialised operations

ED Decision 2014/025/R

LIMITATIONS

The competent authority may issue the authorisation for a limited duration, e.g. for a single event or a defined series of flights, or limit the operating area.

GM1 ARO.OPS.150(c) Authorisation of high risk commercial specialised operations

ED Decision 2014/025/R

CHANGE OF NAME OF THE ORGANISATION

- (a) Upon receipt of the application for a change of the authorisation, the competent authority should re-issue the authorisation.
- (b) A name change alone does not require the competent authority to re-assess the risk assessment and SOPs, unless there is evidence that other aspects of the operation have changed.

AMC1 ARO.OPS.150(f) Authorisation of high risk commercial specialised operations

ED Decision 2014/025/R

AUTHORISATION OF CROSS-BORDER HIGH RISK COMMERCIAL SPECIALISED OPERATION

- (a) An authorisation for cross-border high risk commercial specialised operations should be issued by the competent authority, when both the competent authority itself and the competent authority of the place where the operation is planned to be conducted are satisfied that the risk assessment and SOPs are appropriate for the area overflown.
- (b) The authorisation should be amended to include those areas for which the operator has received the authorisation to conduct cross-border high risk commercial specialised operation.

GM1 ARO.OPS.150(f) Authorisation of high risk commercial specialised operations

ED Decision 2014/025/R

AUTHORISATION OF CROSS-BORDER HIGH RISK COMMERCIAL SPECIALISED OPERATION

Cross-border high risk commercial specialised operation means a high risk commercial specialised operation in a territory other than the Member State than where the operator has its principle place of business.

ARO.OPS.155 Lease agreements

Regulation (EU) No 379/2014

- (a) The competent authority shall approve a lease agreement involving a third country registered aircraft or a third country operator when the SPO operator has demonstrated compliance with [ORO.SPO.100](#).
- (b) The approval of a dry lease-in agreement shall be suspended or revoked whenever the certificate of airworthiness of the aircraft is suspended or revoked.

GM1 ARO.OPS.155 Lease agreements

ED Decision 2014/025/R

WET LEASE-IN

Since ICAO has not stipulated globally harmonised standards for specialised operators and their operation, the applicable requirements involving a third country registered aircraft of a third country operator will be of a local or national nature. Therefore, the competent authority approving a wet lease-in agreement is encouraged to collect information on the oversight system of the state of the operator or state of registry, if applicable, in order to have a better understanding of the operation.

GM2 ARO.OPS.155 Lease agreements

ED Decision 2014/025/R

LEASE AGREEMENTS BETWEEN OPERATORS REGISTERED IN AN EU MEMBER STATE

No approval is required for any lease agreements between operators having their principle place of business in an EU Member State.

SECTION II – APPROVALS

ARO.OPS.200 Specific approval procedure

Regulation (EU) 2019/1384

- (a) Upon receiving an application for the issue of a specific approval or changes thereof, the competent authority shall assess the application in accordance with the relevant requirements of Annex V (Part-SPA) and conduct, where relevant, an appropriate inspection of the operator.
- (b) When satisfied that the operator has demonstrated compliance with the applicable requirements, the competent authority shall issue or amend the approval. The approval shall be specified in:
 - (1) the operations specifications, as established in [Appendix II](#), for commercial air transport operations; or
 - (2) the list of specific approvals, as established in [Appendix III](#), for non-commercial operations and specialised operations.

AMC1 ARO.OPS.200 Specific approval procedure

ED Decision 2014/025/R

PROCEDURES FOR THE APPROVAL OF CARRIAGE OF DANGEROUS GOODS

When verifying compliance with the applicable requirements of [SPA.DG.100](#), the competent authority should check that:

- (a) the procedures specified in the operations manual are sufficient for the safe transport of dangerous goods;
- (b) operations personnel are properly trained in accordance with the ICAO Technical Instructions for the *Safe Transport of Dangerous Goods by Air* (ICAO Doc 9284-AN/905); and
- (c) a reporting scheme is in place.

AMC2 ARO.OPS.200 SPECIFIC APPROVAL PROCEDURE

ED Decision 2014/025/R

PROCEDURES FOR THE APPROVAL FOR REDUCED VERTICAL SEPARATION MINIMA (RVSM) OPERATIONS

- (a) When verifying compliance with the applicable requirements of Subpart D of Annex V (SPA.RVSM), the competent authority should verify that:
 - (1) each aircraft holds an adequate RVSM airworthiness approval;
 - (2) procedures for monitoring and reporting height keeping errors have been established;
 - (3) a training programme for the flight crew involved in these operations has been established; and
 - (4) operating procedures have been established.
- (b) Demonstration flight(s)

The content of the RVSM application may be sufficient to verify the aircraft performance and procedures. However, the final step of the approval process may require a demonstration flight. The competent authority may appoint an inspector for a flight in RVSM airspace to verify that

all relevant procedures are applied effectively. If the performance is satisfactory, operation in RVSM airspace may be permitted.

(c) Form of approval documents

Each aircraft group for which the operator is granted approval should be listed in the approval.

(d) Airspace monitoring

For airspace, where a numerical target level of safety is prescribed, monitoring of aircraft height keeping performance in the airspace by an independent height monitoring system is necessary to verify that the prescribed level of safety is being achieved. However, an independent monitoring check of an aircraft is not a prerequisite for the grant of an RVSM approval.

(1) Suspension, revocation and reinstatement of RVSM approval

The incidence of height keeping errors that can be tolerated in an RVSM environment is small. It is expected of each operator to take immediate action to rectify the conditions that cause an error. The operator should report an occurrence involving poor height keeping to the competent authority within 72 hours. The report should include an initial analysis of causal factors and measures taken to prevent repeat occurrences. The need for follow-up reports should be determined by the competent authority. Occurrences that should be reported and investigated are errors of:

- (i) total vertical error (TVE) equal to or greater than ± 90 m (± 300 ft);
- (ii) altimeter system error (ASE) equal to or greater than ± 75 m (± 245 ft); and
- (iii) assigned altitude deviation equal to or greater than ± 90 m (± 300 ft).

Height keeping errors fall into two broad categories:

- errors caused by malfunction of aircraft equipment; and
- operational errors.

(2) An operator that consistently experiences errors in either category should have approval for RVSM operations suspended or revoked. If a problem is identified that is related to one specific aircraft type, then RVSM approval may be suspended or revoked for that specific type within that operator's fleet.

(3) Operators' actions:

The operator should make an effective, timely response to each height keeping error. The competent authority may consider suspending or revoking RVSM approval if the operator's responses to height keeping errors are not effective or timely. The competent authority should consider the operator's past performance record in determining the action to be taken.

(4) Reinstatement of approval:

The operator should satisfy the competent authority that the causes of height keeping errors are understood and have been eliminated and that the operator's RVSM programmes and procedures are effective. At its discretion and to restore confidence, the competent authority may require an independent height monitoring check of affected aircraft to be performed.

AMC3 ARO.OPS.200 Specific approval procedure

ED Decision 2016/022/R

APPROVAL OF HELICOPTER OFFSHORE OPERATIONS

(a) Approval

When verifying compliance with the applicable requirements of Subpart K of Annex V (Part-SPA) to Regulation (EU) No 965/2012, the competent authority should ensure prior to issuing an approval that:

- (1) the hazard identification, risk assessment and risk mitigation processes are in place;
- (2) operating procedures have been established applicable to the area of operation;
- (3) helicopters are appropriately certified and equipped for the area of operation;
- (4) flight crew involved in these operations are trained and checked in accordance with the training and checking programmes established by the operator; and
- (5) all requirements of Part-SPA, Subpart K are met.

(b) Demonstration flight(s)

The final step of the approval process may require a demonstration flight performed in the area of operation. The competent authority may appoint an inspector for a flight to verify that all relevant procedures are applied effectively. If the performance is satisfactory, helicopter offshore operations may be approved.

AMC4 ARO.OPS.200 Specific approval procedure

ED Decision 2017/004/R

PROCEDURES FOR THE APPROVAL OF COMMERCIAL AIR TRANSPORT OPERATIONS WITH SINGLE-ENGINE TURBINE AEROPLANES AT NIGHT OR IN INSTRUMENT METEOROLOGICAL CONDITIONS (SET-IMC)

(a) When verifying compliance with the applicable requirements of Subpart L (SET-IMC) of Annex V (Part-SPA) to Regulation (EU) No 965/2012, the competent authority should check that:

- (1) the aeroplane is eligible for SET-IMC operations;
- (2) the maintenance and operational procedures are adequate;
- (3) a training programme for the flight crew involved in these operations has been established; and
- (4) the operator has adequately assessed the risks of the intended operations.

In particular, the competent authority should assess the operator's safety performance, experience and flight crew training, as reflected in the data provided by the operator with its application, to ensure that the intended safety level is achieved.

With regard to the operator's specific SET-IMC flight crew training, the competent authority should ensure that it complies with the applicable requirements of Subpart FC (FLIGHT CREW) of Annex III (Part-ORO) and Subpart L (SET-IMC) of Annex V (Part-SPA) to Regulation (EU) No 965/2012, and that it is appropriate to the operations envisaged.

The competent authority should assess the operator's ability to achieve and maintain an acceptable level of power plant reliability by reviewing its engine-trend-monitoring programme and propulsion reliability programme, which are established in accordance with Annex I (Part-M) to Regulation (EU) No 1321/2014.

- (b) The competent authority may impose temporary restrictions to the operations (e.g. limitation to specific routes) until the operator is able to demonstrate that it has the capability to operate safely in compliance with all the applicable requirements.
- (c) When issuing the approval, the competent authority should specify:
 - (1) the particular engine-airframe combination;
 - (2) the identification by registration of the individual aeroplanes designated for single-engined turbine aeroplane operations at night and/or in IMC; and
 - (3) the authorised areas and/or routes of operation.

VALIDATION OF OPERATIONAL CAPABILITY

Observation by the competent authority of a validation flight, simulating the proposed operation in the aeroplane, should be carried out before an approval is granted. This should include flight planning and preflight procedures, as well as a demonstration of the following simulated emergency procedures in simulated IMC/night:

- (a) total failure of the propulsion system; and
- (b) total loss of normally generated electrical power.

In order to mitigate the risks associated with the conduct of such emergency procedures, the following should be ensured:

- (a) in case of planned single-pilot operations, the crew should be composed of the commander using view-limiting devices for the purpose of simulating IMC/night and a second rated pilot whose responsibility is to help maintain visual separation from other aircraft, clouds, and terrain;
- (b) the flight should be conducted in visual meteorological conditions (VMC) by day, and additional, more restrictive weather minima may be established for the demonstration of the procedures involving higher risks; and
- (c) touch drills should be used when simulating a total failure of the propulsion system.

AMC5 ARO.OPS.200 Specific approval procedure

ED Decision 2022/012/R

PROCEDURES FOR THE APPROVAL OF LOW-VISIBILITY OPERATIONS

Before issuing an approval for low-visibility operations (LVOs), the competent authority should verify that the applicant has:

- (a) taken account of the relevant airworthiness requirements and limitations;
- (b) established the relevant aerodrome operating minima;
- (c) established and documented the relevant operating procedures;
- (d) established and conducted adequate training and checking programmes;
- (e) adopted the minimum equipment list (MEL) for the LVOs to be undertaken;
- (f) processes to ensure that only runways and instrument procedures suitable for the intended operations are used; and
- (g) established and conducted the relevant risk assessment and monitoring programmes.

GM1 ARO.OPS.200 Specific approval procedure

ED Decision 2016/022/R

LIMITATIONS FOR HELICOPTER OFFSHORE OPERATIONS

The competent authority may impose limitations related to routes and areas of operation for offshore helicopter operations. Such limitations may be specified in the operations specifications (OPSSPEC) or specific approved documents or in the aeronautical information publication (AIP) or by other means.

For operations over sea areas, limitations may include a maximum significant wave height under which there is a good prospect of recovery of survivors. This should be linked with the available search and rescue capabilities in the different sea areas.

GM2 ARO.OPS.200 Specific approval procedure

ED Decision 2019/019/R

SPECIFIC APPROVALS FOR TRAINING ORGANISATIONS

The specific approvals, as established in [Appendix III](#), for non-commercial operations and specialised operations, also apply to training organisations with a principal place of business in a Member State.

GM3 ARO.OPS.200 Specific approval procedure

ED Decision 2019/019/R

INSERTION OF RELEVANT INFORMATION INTO THE OPERATIONS SPECIFICATIONS

When issuing the operations specifications in accordance with [Appendix II](#), where the operation does not include helicopter operations, the helicopter-related elements contained in the operations specifications may be omitted.

GM4 ARO.OPS.200 Specific approval procedure

ED Decision 2022/012/R

SPA.PinS-VFR APPROVAL PROCEDURE

When issuing an approval for helicopter PinS approaches and departures with reduced VFR minima, the competent authority may use the 'OTHERS' box of [Appendix II](#) (EASA Form 139).

ARO.OPS.205 Minimum equipment list approval

Regulation (EU) No 965/2012

- (a) When receiving an application for initial approval of a minimum equipment list (MEL) or an amendment thereof from an operator, the competent authority shall assess each item affected, to verify compliance with the applicable requirements, before issuing the approval.
- (b) The competent authority shall approve the operator's procedure for the extension of the applicable rectification intervals B, C and D, if the conditions specified in [ORO.MLR.105\(f\)](#) are demonstrated by the operator and verified by the competent authority.
- (c) The competent authority shall approve, on a case-by-case basis, the operation of an aircraft outside the constraints of the MEL but within the constraints of the master minimum equipment list (MMEL), if the conditions specified in [ORO.MLR.105](#) are demonstrated by the operator and verified by the competent authority.

GM1 ARO.OPS.205 Minimum equipment list approval

ED Decision 2014/025/R

EXTENSION OF RECTIFICATION INTERVALS

The competent authority should verify that the operator does not use the extension of rectification intervals as a means to reduce or eliminate the need to rectify MEL defects in accordance with the established category limit. The extension of rectification intervals should only be considered valid and justifiable when events beyond the operator's control have precluded rectification.

ARO.OPS.210 Determination of distance or local area

Regulation (EU) No 965/2012

The competent authority may determine a distance or local area for the purpose of operations.

GM1 ARO.OPS.210 Determination of local area

ED Decision 2014/025/R

GENERAL

The distance or local area should reflect the local environment and operating conditions.

ARO.OPS.215 Approval of helicopter operations over a hostile environment located outside a congested area

Regulation (EU) No 965/2012

- (a) The Member State shall designate those areas where helicopter operations may be conducted without an assured safe forced landing capability, as described in [CAT.POL.H.420](#).
- (b) Before issuing the approval referred to in [CAT.POL.H.420](#) the competent authority shall have considered the operator's substantiation precluding the use of the appropriate performance criteria.

AMC1 ARO.OPS.215 Approval of helicopter operations over a hostile environment located outside a congested area

ED Decision 2014/025/R

APPROVALS THAT REQUIRE ENDORSEMENT

- (a) Whenever the operator applies for an approval in accordance with [CAT.POL.H.420](#) for which an endorsement from another State is required, the competent authority should only grant the approval once endorsement of that other State has been received.
- (b) The Operations Specification should be amended to include those areas for which endorsement was received.

AMC2 ARO.OPS.215 Approval of helicopter operations over a hostile environment located outside a congested area

ED Decision 2014/025/R

ENDORSEMENT BY ANOTHER STATE

- (a) Whenever the operator applies for an endorsement to operate over hostile environment located outside a congested area in another State in accordance with [CAT.POL.H.420](#), the competent authority of that other State should only grant the endorsement once it is satisfied that:
- (1) the safety risk assessment is appropriate to the area overflown; and
 - (2) the operator's substantiation that preclude the use of the appropriate performance criteria are appropriate for the area overflown.
- (b) The competent authority of that other State should inform the competent authority of the Member State responsible for issuing the approval.

ARO.OPS.220 Approval of helicopter operations to or from a public interest site

Regulation (EU) No 965/2012

The approval referred to in [CAT.POL.H.225](#) shall include a list of the public interest site(s) specified by the operator to which the approval applies.

AMC1 ARO.OPS.220 Approval of helicopter operations to or from a public interest site

ED Decision 2014/025/R

APPROVALS THAT REQUIRE ENDORSEMENT

Whenever the operator applies for an approval in accordance with [CAT.POL.H.225](#) to conduct operations to or from a public interest site (PIS) for which an endorsement from another State is required, the competent authority should only grant such an approval once endorsement of that other State has been received.

AMC2 ARO.OPS.220 Approval of helicopter operations to or from a public interest site

ED Decision 2014/025/R

ENDORSEMENT BY ANOTHER STATE

- (a) Whenever the operator applies for an endorsement to operate to/from a public interest site in another State in accordance with [CAT.POL.H.225](#), the competent authority of that other State should only grant the endorsement once it is satisfied that:
- (1) the conditions of [CAT.POL.H.225\(a\)\(1\)](#) through (5) can be met by the operator at those sites for which endorsement is requested; and
 - (2) the operations manual includes the procedures to comply with [CAT.POL.H.225\(b\)](#) for these sites for which endorsement is requested.

- (b) The competent authority of that other State should inform the competent authority of the Member State responsible for issuing the approval.

ARO.OPS.225 Approval of fuel/energy schemes

Regulation (EU) 2021/1296

- (a) The competent authority shall approve the fuel/energy scheme proposed by a CAT operator if the operator demonstrates compliance with all applicable requirements laid down in this Regulation related to fuel/energy for aeroplanes or helicopters involved in CAT.
- (b) The competent authority shall assess and oversee the fuel/energy planning and in-flight re-planning, selection of aerodrome and, in-flight fuel/energy management policies associated with the fuel/energy schemes, together with the processes supporting the implementation of these fuel/energy schemes.
- (c) In addition to points (a) and (b), when approving individual fuel/energy schemes, the competent authority shall:
- (1) verify that the operator has demonstrated the baseline safety performance of the current fuel/energy scheme;
 - (2) assess the capability of the operator to support the implementation of the proposed individual fuel/energy scheme; the following elements shall be considered as a minimum:
 - (i) the operator's management system,
 - (ii) the operator's operational capabilities;
 - (3) verify that the operator's safety risk assessment that supports the proposed individual fuel/energy scheme achieves an equivalent level of safety to that of the current fuel/energy scheme; and
 - (4) establish an oversight plan to carry out periodic assessments of the approved individual fuel/energy scheme to verify compliance of the scheme or decide whether the scheme should be amended or revoked.
- (d) The approval referred to in point [CAT.OP.MPA.182 \(d\)\(2\)](#) shall include a list of the isolated aerodromes that are specified by the operator for each aircraft type to which the approval applies.
- (e) Without prejudice to points [ARO.GEN.120 \(d\) and \(e\)](#), the competent authority shall notify the Agency of the start of the evaluation of an alternative means of compliance related to fuel/energy schemes.

AMC1 ARO.OPS.225 Approval of fuel/energy schemes

ED Decision 2022/005/R

OVERSIGHT — VERIFICATION OF COMPLIANCE OF FUEL SCHEMES FOR CAT OPERATIONS WITH AEROPLANES

- (a) When approving a basic fuel scheme, the competent authority should be satisfied that the operator fulfils the applicable criteria of point [CAT.OP.MPA.180\(a\)\(3\)\(i\)](#), taking into account the elements contained in the AMC applicable to the basic fuel scheme.
- (b) When approving a basic fuel scheme with variations, the competent authority should be satisfied that the operator fulfils the applicable criteria of point [CAT.OP.MPA.180\(a\)\(3\)\(ii\)](#), taking into account the elements contained in the AMC applicable to the variation.

- (c) When approving an individual fuel scheme that deviates, fully or partly, from the basic fuel scheme, the competent authority should be satisfied that the operator fulfils the applicable criteria of point [CAT.OP.MPA.180\(a\)\(3\)\(iii\)](#), taking into account the elements contained in the AMC applicable to the individual fuel scheme.

Before issuing the approval of an individual fuel scheme, the competent authority should verify the following:

- (1) the maturity, capability, and suitability of the operator's management system;
- (2) the adequacy of this system for exercising operational control;
- (3) the adequacy of the operator's SOPs;
- (4) the resolution of significant findings in the areas that support the application of the individual fuel scheme;
- (5) the suitability of the communications and navigation equipment of the aircraft fleet to which the individual fuel scheme will apply;
- (6) the areas of operation where the individual fuel scheme will be used;
- (7) the operator's ability to provide reliable and accurate aircraft-specific fuel data;
- (8) the suitability of the relevant training programmes, including those for flight crew and operational control personnel;
- (9) the experience of the personnel concerned, particularly of the flight crew, in the use of the procedures and systems that support the individual fuel scheme;
- (10) any low-fuel events (including emergency fuel conditions) in the operator's safety records; and
- (11) the maintenance of the fleet in terms of reliability of the fuel system, including the accuracy of the fuel-measurement systems.

GM1 ARO.OPS.225 Approval of fuel/energy schemes

ED Decision 2022/005/R

OPERATIONS TO AN ISOLATED AERODROME — GENERAL

The use of an isolated aerodrome exposes both the aircraft and passengers to a greater risk than in operations where a destination alternate aerodrome is available. The competent authority should, therefore, assess whether all possible means are applied to mitigate that greater risk.

GM2 ARO.OPS.225 Approval of fuel/energy schemes

ED Decision 2022/005/R

ASSESSMENT AND OVERSIGHT OF POLICIES ASSOCIATED WITH FUEL SCHEMES

The competent authority's assessment and oversight of:

- the fuel planning and in-flight re-planning policy;
- the selection-of-aerodromes policy; and
- the in-flight fuel management policy

may follow a two-step process: firstly, assess and oversee each policy individually, and secondly, and more importantly, assess and oversee all the policies together.

The competent authority should be satisfied with regard to the following:

- the robustness of the operator's management system, particularly with regard to safety risk management; and
- in case of basic fuel schemes with variations and individual fuel schemes, the operator's processes for performance monitoring and measurement.

AMC1 ARO.OPS.225(c) Approval of fuel/energy schemes

ED Decision 2022/005/R

APPROVAL OF INDIVIDUAL FUEL SCHEMES — QUALIFICATION OF PERSONNEL

- (a) In accordance with point [ARO.GEN.200\(a\)\(2\)](#), the competent authority is required to have qualified personnel to perform the tasks under their responsibility. To approve individual fuel schemes, the competent authority's inspectors should have the necessary knowledge and expertise to understand, monitor, and validate the criteria of point (c) of [AMC1 ARO.OPS.225](#).
- (b) For this purpose, the inspectors should be able to understand the relevance and meaningfulness of the operator's safety performance indicators (SPIs), targets, and means by which these targets are achieved.
- (c) The competent authority should develop guidance to be used by its inspectors when approving and verifying individual fuel schemes.

AMC2 ARO.OPS.225(c) Approval of fuel/energy schemes

ED Decision 2022/005/R

APPROVAL OF INDIVIDUAL FUEL SCHEMES — APPLICATION OF INDIVIDUAL FUEL SCHEMES — GUIDANCE TO PERSONNEL

According to points [ARO.GEN.115](#) and [ARO.GEN.200\(a\)\(1\)](#), the competent authority is required to develop guidance on the application of individual fuel schemes to be used by its inspectors. Such guidance should cover the following:

- (a) the operator's responsibilities:
 - (1) operational control systems (organisational control over internal processes);
 - (2) policies and procedures;
 - (3) qualified personnel:
 - (i) competence and experience of both flight crew and operational control personnel; and
 - (ii) their training;
 - (4) SOP compliance and suitability;
 - (5) monitoring of the effectiveness of individual fuel scheme processes; and
 - (6) continuous improvement;
- (b) operational characteristics:
 - (1) of the aircraft: current aircraft-specific data derived from a fuel consumption monitoring system; and

- (2) of the area of operations:
 - (i) aerodrome technologies;
 - (ii) meteorological information capabilities;
 - (iii) ATM infrastructure; and
 - (iv) aerodrome capabilities and ATS characteristics;
 - (3) a suitable computerised flight plan;
 - (4) flight monitoring or flight watch capabilities, as applicable;
 - (5) communications systems: ground-based and airborne systems;
 - (6) navigation systems: ground-based and airborne systems; and
 - (7) reliable meteorological and aerodrome information; and
- (c) safety risk management:
- (1) agreed SPIs;
 - (2) risk register;
 - (3) identification of hazards;
 - (4) risk monitoring; and
 - (5) compliance monitoring.

When collecting statistically relevant data, the competent authority inspectors should consider the specificities of the operations of each operator. As a minimum, the data should be collected for a period of 2 years.

Note: Further guidance is provided in ICAO Doc 9976 Flight Planning and Fuel Management (FPFM) Manual, Appendix 7 to Chapter 5 A performance-based approach job-aid for an approving authority (1st Edition, 2015).

GM1 ARO.OPS.225(c) Approval of fuel/energy schemes

ED Decision 2022/005/R

INDIVIDUAL FUEL SCHEMES — RESOLUTION OF SIGNIFICANT FINDINGS

The approval of an individual fuel scheme may be rejected, suspended or revoked when the operator has not resolved the relevant findings, or when there are unacceptable open findings that affect the areas that support individual fuel schemes (e.g. operational control, safety management system, safety risk assessment processes, availability of data, SPIs, pilot training, etc.).

ARO.OPS.226 Approval and oversight of evidence-based training programmes

Regulation (EU) 2020/2036

- (a) Where a competent authority grants an approval for EBT programmes, inspectors must receive qualification and training in EBT principles, application, approval processes and continuing oversight.
- (b) The competent authority shall assess and oversee the EBT programme, together with the processes that support the implementation of the EBT programme and its effectiveness.

- (c) Upon receiving an application for the approval of an EBT programme, the competent authority shall:
- (1) ensure the resolution of level 1 findings in the areas that will support the application of the EBT programme;
 - (2) assess the capability of the operator to support the implementation of the EBT programme. The following elements shall be considered as a minimum:
 - (i) the maturity and capability of the operator's management system in the areas that will support the application of the EBT programme — in particular, flight crew training;
 - (ii) the operator's EBT programme suitability — the EBT programme shall correspond to the size of the operator, and the nature and complexity of its activities, taking into account the hazards and associated risks inherent in those activities;
 - (iii) the adequacy of the operator's record-keeping system, in particular with regard to flight crew training, checking and qualifications records in particular [ORO.GEN.220](#) and [ORO.MLR.115](#) points (c) and (d);
 - (iv) the suitability of the operator's grading system to assess the pilot competencies;
 - (v) the competence and the experience of the instructors and other personnel involved in the EBT programme in the use of the processes and procedures that support the implementation of the EBT programme; and
 - (vi) the operator's EBT implementation plan and a safety risk assessment supporting the EBT programme in order to demonstrate how an equivalent level of safety to that of the current training programme can be achieved.
- (d) The competent authority shall grant an EBT programme approval when the assessment concludes that the compliance with at least [ORO.FC.146](#), [ORO.FC.231](#), and [ORO.FC.232](#) is ensured.
- (e) Without prejudice to [ARO.GEN.120](#) (d) and (e), the competent authority shall notify the Agency when it starts the evaluation of an alternative means of compliance related to EBT.

AMC1 ARO.OPS.226(a) Approval and oversight of evidence-based training programmes

ED Decision 2021/002/R

QUALIFICATION AND TRAINING — INSPECTORS

- (a) For the initial approval and oversight of an operator's EBT programme, the inspector of the competent authority should undertake EBT training as part of their required technical training (see AMC2 ARO.GEN.200(a)(2)). At the conclusion of the inspector training, the inspector should:
- (1) know the principles of EBT, including the following underlying principles:
 - (i) competency-based training;
 - (ii) learning from positive performance;
 - (iii) building resilience; and;
 - (iv) data-driven training;

- (2) know the structure of an EBT module;
 - (3) know the method of training delivery for each phase of an EBT module;
 - (4) know the principles of adult learning and how they relate to EBT;
 - (5) recognise effective observations based on a competency framework, and document evidence of observed performance;
 - (6) recognise and relate specific performance observations of competencies;
 - (7) recognise trainee performance to determine competency-based training needs and recognise strengths;
 - (8) understand methods for the evaluation of performance using a competency-based grading system;
 - (9) recognise appropriate teaching styles during simulator training to accommodate trainee learning needs;
 - (10) recognise facilitated trainee learning, focusing on specific competency-based training needs; and
 - (11) understand how to conduct a debrief using facilitation techniques.
- (b) The objective of such training is to ensure that the inspector:
- (1) attains the adequate level of knowledge in the principles of approval and oversight of the EBT programmes; and
 - (2) acquires the ability to recognise the EBT programme suitability.

GM1 ARO.OPS.226(a) Approval and oversight of evidence-based training programmes

ED Decision 2021/002/R

QUALIFICATION AND TRAINING — PRINCIPLES OF EBT — DATA-DRIVEN TRAINING

EBT is a data-driven programme and proper oversight requires the inspector to have a good understanding of all features where data plays an important role in the EBT programme:

- (a) Flight crew training data
 - (1) Data related to grading of competencies (level 1), data related to OBs (level 2) and how it can be used to drive the design of the operator's EBT programme. Other training data (level 3) and how it is used in the contextualisation of an example scenario element.
 - (2) Individual flight crew training data — understand how it is used:
 - (i) in regard to licence revalidation and renewal; and
 - (ii) to provide tailored training and additional FSTD training.
- (b) Data from the management system — understand how it may be used for the selection of the example scenario element(s) and the contextualisation of the example scenario element(s).
- (c) Instructor standardisation and concordance data
 - (1) How the EBT data is used to standardise the instructor and how, at the same time, the operator ensures the necessary just culture and a non-jeopardy environment for the instructors (referred to in the instructor concordance assurance programme).

- (2) Understand the importance of quality in the data – the feedback loop of the EBT programme.

GM2 ARO.OPS.226(a) Approval and oversight of evidence-based training programmes

ED Decision 2021/002/R

QUALIFICATION AND TRAINING — OPERATOR'S EBT PROGRAMME SUITABILITY

To recognise and evaluate the suitability of an operator's EBT programme, the inspector's training programme may include those features as training objectives. AMC1 ORO.FC.231(a) provides the list of features of a suitable EBT programme.

AMC1 ARO.OPS.226(c) Approval and oversight of evidence-based training programmes

ED Decision 2021/002/R

INITIAL APPROVAL — VERIFICATION OF COMPLIANCE

When approving an EBT programme, the competent authority should ensure that the operator fulfils all the applicable criteria of ORO.FC.231 and its associated AMC. In particular, it should recognise the suitability of the operator's EBT programme (AMC1 ORO.FC.231(a)).

AMC2 ARO.OPS.226(c) Approval and oversight of evidence-based training programmes

ED Decision 2021/002/R

EBT PROGRAMME SUITABILITY

As regards the suitability of the EBT programme, please refer to AMC1 ORO.FC.231(a).

AMC1 ARO.OPS.226(d) Approval and oversight of evidence-based training programmes

ED Decision 2021/002/R

OVERSIGHT PLAN — PERIODIC ASSESSMENT TO VERIFY THE COMPLIANCE OF THE EBT PROGRAMME

- (a) After issuing the approval of the operator's EBT programme, the competent authority should have a process to verify the operator's continuing compliance.
- (b) Each organisation to which an EBT approval has been issued should have an inspector (or inspectors) assigned to it who is (are) trained and qualified for EBT (see AMC1 ARO.OPS.226(a)).
- (c) Audits and inspections, on a scale and frequency appropriate to the operation, should cover at least:
 - (1) management supervision of the EBT programme;
 - (2) ongoing identification of operational risks and inclusion into the operator's EBT programme;
 - (3) relevance of the operator's EBT programme to address its operational and training needs;

- (4) effectiveness of the operator's EBT programme to improve pilot competencies. When there is an ineffective programme, the competent authority should examine the operator processes which identify the lack of effective results;
- (5) compliance with all requirements of ORO.FC.231;
- (6) delivery of instructor initial training in accordance with AMC1 ORO.FC.146(c), including inspections of the training delivery;
- (7) conduct of assessments of competence for EBT instructors, including periodic inspections of FSTD training;
- (8) maintenance of crew records;
- (9) administration of programme enrolment and compliance with the requirements of Annex I (Part-FCL) for licence revalidation and renewal;
- (10) continuing standardisation of EBT instructors; and
- (11) inspection of the training delivery.

GM1 ARO.OPS.226(d) Approval and oversight of evidence-based training programmes

ED Decision 2021/002/R

EFFECTIVENESS OF THE OPERATOR'S EBT PROGRAMME

- (a) The effectiveness of the operator's EBT programme can be determined by periodically reviewing pilot competencies across several domains, such as role, fleet (e.g. CPT/FO, A320, B737) and airline so that the continuing improvement of the EBT programme is linked to an improvement of the pilot competencies.
- (b) The analysis of the pilot competencies across the domains should also take into account the operator's experience in the EBT programme and the level of difficulty contained within the scenario elements of the programme, which may result in variations of the grading results and those variations may be acceptable.

GM2 ARO.OPS.226(d) Approval and oversight of evidence-based training programmes

ED Decision 2021/002/R

STANDARDISATION OF EBT INSTRUCTORS — ACCEPTABLE INSTRUCTOR CONCORDANCE

The authority may require a minimum acceptable level of concordance. This may be a non-exhaustive list:

- (a) Set a minimum acceptable level of concordance per aircraft fleet or by group of instructors.
- (b) Set a minimum acceptable level of concordance per competency.
- (c) Set a minimum acceptable level of concordance for all operators under its oversight, or a minimum acceptable level of concordance per operator (or type of operator) based on the risk of the operator.

ARO.OPS.230 Determination of disruptive schedules

Regulation (EU) No 83/2014

For the purpose of flight time limitations, the competent authority shall determine, in accordance with the definitions of “early type” and “late type” of disruptive schedules in point [ORO.FTL.105](#) of Annex III, which of those two types of disruptive schedules shall apply to all CAT operators under its oversight.

ARO.OPS.235 Approval of individual flight time specification schemes

Regulation (EU) No 83/2014

- (a) The competent authority shall approve flight time specification schemes proposed by CAT operators if the operator demonstrates compliance with Regulation (EC) No 216/2008 and Subpart FTL of Annex III to this Regulation.
- (b) Whenever a flight time specification scheme proposed by an operator deviates from the applicable certification specifications issued by the Agency, the competent authority shall apply the procedure described in Article 22(2) of Regulation (EC) No 216/2008.
- (c) Whenever a flight time specification scheme proposed by an operator derogates from applicable implementing rules, the competent authority shall apply the procedure described in Article 14(6) of Regulation (EC) No 216/2008.
- (d) Approved deviations or derogations shall be subject, after being applied, to an assessment to determine whether such deviations or derogations should be confirmed or amended. The competent authority and the Agency shall conduct an independent assessment based on information provided by the operator. The assessment shall be proportionate, transparent and based on scientific principles and knowledge.

GM1 ARO.OPS.235(b);(c) Approval of individual flight time specification schemes

ED Decision 2017/006/R

ICAO DOC 9966 (MANUAL FOR THE OVERSIGHT OF FATIGUE MANAGEMENT APPROACHES)

Further guidance on fatigue risk management processes, appropriate fatigue management, the underlying scientific principles and operational knowledge may be found in ICAO Doc 9966 (Manual for the Oversight of Fatigue Management Approaches).

ARO.OPS.240 Specific approval of RNP AR APCH

Regulation (EU) 2016/1199

- (a) When compliance with the requirements in [SPA.PBN.105](#) has been demonstrated by the applicant, the competent authority shall grant a generic specific approval or a procedure-specific approval for RNP AR APCH.
- (b) In the case of a procedure-specific approval, the competent authority shall:
 - (1) list the approved instrument approach procedures at specific aerodromes in the PBN approval;
 - (2) establish coordination with the competent authorities for these aerodromes, if appropriate; and

- (3) take into account possible credits stemming from RNP AR APCH specific approvals already issued to the applicant.

GM1 ARO.OPS.240 Specific approval of RNP AR APCH

ED Decision 2016/014/R

TEMPORARY LIMITATION ON RVR

Where operators are new to RNP AR APCH operations and their initial application is for RNP < 0.3, it is appropriate to establish a temporary limitation for RVR minima, until operational experience is gained. This period could be based upon time (e.g. 90 days) and a number of conducted operations, as agreed by the competent authority and the operator.

GM2 ARO.OPS.240 Specific approval of RNP AR APCH

ED Decision 2016/014/R

REFERENCES

Additional guidance material for the specific approval of PBN operations, when required, can be found in ICAO Doc 9997 Performance-Based Navigation (PBN) Operational Approval Manual. In particular, a job aid can be found in paragraph 4.7 therein for assessment of applications for RNP AR APCH.

SECTION III – OVERSIGHT OF OPERATIONS

ARO.OPS.300 Introductory flights

Regulation (EU) No 965/2012

The competent authority may establish additional conditions for introductory flights carried out in accordance with Part-NCO in the territory of the Member State. Such conditions shall ensure safe operations and be proportionate.

AMC1 ARO.OPS.300 Introductory flights

ED Decision 2014/025/R

MARGINAL ACTIVITY

The competent authority should publish criteria specifying to which extent it considers an activity marginal and how this is being overseen.

GM1 ARO.OPS.300 Introductory flights

ED Decision 2014/025/R

ADDITIONAL CONDITIONS

For introductory flights carried out in the territory of the Member State, the competent authority may establish additional conditions such as defined area of the operation, time period during which such operations are to be conducted, safety risk assessments to be accomplished, aircraft to be used, specific operating procedures, notification requirements, maximum distance flown, pilot qualification, maximum number of passengers on-board, further restrictions on the maximum take-off mass.

SUBPART RAMP: RAMP INSPECTIONS OF AIRCRAFT OF OPERATORS UNDER THE REGULATORY OVERSIGHT OF ANOTHER STATE

ARO.RAMP.005 Scope

Regulation (EU) No 965/2012

This Subpart establishes the requirements to be followed by the competent authority or the Agency when exercising its tasks and responsibilities regarding the performance of ramp inspections of aircraft used by third country operators or used by operators under the regulatory oversight of another Member State when landed at aerodromes located in the territory subject to the provisions of the Treaty.

GM1 ARO.RAMP.005 Scope

ED Decision 2019/007/R

RAMP INSPECTION MANUAL

The following information may be found in the ramp inspection manual established by the Agency:

- (a) Additional guidance and best practices, in the manual and its attachments;
- (b) Additional provisions which are referenced in AMCs to this subpart, in its appendices.

ARO.RAMP.100 General

Regulation (EU) No 965/2012

- (a) Aircraft, as well as their crew, shall be inspected against the applicable requirements.
- (b) In addition to conducting ramp inspections included in its oversight programme established in accordance with [ARO.GEN.305](#), the competent authority shall perform a ramp inspection of an aircraft suspected of not being compliant with the applicable requirements.
- (c) Within the development of the oversight programme established in accordance with [ARO.GEN.305](#), the competent authority shall establish an annual programme for the conduct of ramp inspections of aircraft. This programme shall:
 - (1) be based on a calculation methodology that takes into account historical information on the number and nature of operators and their number of landings at its aerodromes, as well as safety risks; and
 - (2) enable the competent authority to give priority to the inspections of aircraft on the basis of the list referred to in [ARO.RAMP.105\(a\)](#).
- (d) When it so deems necessary, the Agency, in cooperation with the Member States in whose territory the inspection shall take place, shall conduct ramp inspections of aircraft to verify compliance with the applicable requirements for the purpose of:
 - (1) certification tasks assigned to the Agency by Regulation (EC) No 216/2008;
 - (2) standardisation inspections of a Member State; or

- (3) inspections of an organisation to verify compliance with the applicable requirements in potentially unsafe situations.

AMC1 ARO.RAMP.100(b) General

ED Decision 2019/007/R

SUSPECTED AIRCRAFT

In determining whether an aircraft is suspected of not being compliant with the applicable requirements, the following should be taken into account:

- (a) information regarding poor maintenance of, or obvious damage or defects to an aircraft;
- (b) reports that an aircraft has performed abnormal manoeuvres that give rise to serious safety concerns in the airspace of a Member State;
- (c) a previous ramp inspection that has revealed deficiencies indicating that the aircraft does not comply with the applicable requirements and where the competent authority suspects that these deficiencies have not been corrected;
- (d) lists, referred to in [ARO.RAMP.105](#), indicating that the operator or the State of the operator has been suspected of non-compliance;
- (e) evidence that the State in which an aircraft is registered is not exercising proper safety oversight;
- (f) concerns about the operator of the aircraft that have arisen from occurrence reporting information and non-compliance recorded in a ramp inspection report on any other aircraft used by that operator;
- (g) information received from EASA Third-Country Operator (TCO) monitoring activities; or
- (h) any relevant information collected pursuant to [ARO.RAMP.110](#).

AMC1 ARO.RAMP.100(c) General

ED Decision 2019/007/R

ANNUAL RAMP INSPECTION PROGRAMME

- (a) The competent authority should establish an annual ramp inspection programme and determine the number of inspections for the upcoming calendar year.
- (b) To establish the annual ramp inspection programme, the competent authority should consider layer 1 and layer 2 operators as defined in [AMC1 ARO.RAMP.150\(b\)\(4\)\(iii\)](#).
- (c) For layer 1 operators, the annual ramp inspection programme should meet the target numbers of inspections as assigned by the Agency for the Member State territories in ICAO EUR region.

The assigned targets for layer 1 operators may be exceeded in the following cases:

- (1) operators recently considered in the lists provided by the Agency as per [ARO.RAMP.105\(a\)](#); or
- (2) safety reasons that were not identified in the annual programme.

The competent authority should keep records of the reasons leading to such over-inspections on layer 1 operators.

- (d) For layer 2 operators, the total planned number of inspections as defined in the annual ramp inspection programme should not be less than the layer 2 operators target assigned by the Agency for the Member State territories in ICAO EUR region.
- (e) The annual ramp inspection programme should take seasonal traffic patterns into account and, as far as possible, evenly distribute the inspections over the year.
- (f) The competent authority should ensure that the annual ramp inspection programme leaves appropriate time and resources to enable the inspections of aircraft operated by layer 2 operators suspected of not being compliant with the applicable requirements.
- (g) The competent authority should ensure that layer 2 operators, including unforeseen ones which cannot be a part of the established annual programme, receive inspections proportionate to the traffic pattern in the State. The following priority criteria should be considered before deciding to inspect the aircraft:
 - (1) prioritised ramp inspections as per [ARO.RAMP.105\(a\)](#);
 - (2) aircraft suspected of not being compliant with the applicable requirements; and
 - (3) inspection of an operator which was not inspected in accordance with ARO.RAMP in any State in the previous 12 months;
- (h) The competent authority should amend the annual ramp inspection programme as necessary to the extent possible:
 - (1) when new targets are assigned by the Agency;
 - (2) when new layer 2 operators start operations; or
 - (3) following the identification of a significant increase of the safety risks level as per [ARO.RAMP.100\(c\)\(1\)](#).

ARO.RAMP.105 Prioritisation criteria

Regulation (EU) 2019/1384

- (a) The Agency shall provide competent authorities with a list of operators or aircraft identified as presenting a potential risk, for the prioritisation of ramp inspections.
- (b) This list shall include:
 - (1) operators of aircraft identified on the basis of the analysis of available data in accordance with [ARO.RAMP.150\(b\)\(4\)](#);
 - (2) operators or aircraft communicated to the Agency by the European Commission and identified on the basis of:
 - (i) an opinion expressed by the Air Safety Committee (ASC) within the context of the implementation of Regulation (EC) No 2111/2005 that further verification of effective compliance with relevant safety standards through systematic ramp inspections is necessary; or
 - (ii) information obtained by the European Commission from the Member States pursuant to Article 4(3) of Regulation (EC) No 2111/2005;

- (3) aircraft operated into the territory subject to the provisions of the Treaty by operators included in Annex B of the list of operators subject to an operating ban pursuant to Regulation (EC) No 2111/2005;
 - (4) aircraft operated by operators certified in a State exercising regulatory oversight over operators included in the list referred to in (3);
 - (5) aircraft used by a third-country operator that operates into, within or out of the territory subject to the provisions of the Treaty for the first time or whose authorisation issued in accordance with Regulation (EU) No 452/2014 is limited or reinstated after suspension or revocation.
- (c) The list shall be produced, in accordance with procedures established by the Agency, after every update of the Community list of operators subject to an operating ban pursuant to Regulation (EC) No 2111/2005, and in any case at least once every four months.

ARO.RAMP.106 Alcohol testing

Regulation (EU) 2020/745

- (a) The competent authority shall carry out alcohol testing on flight and cabin crew.
- (b) The Agency shall provide competent authorities with a list of Union and third-country operators for the prioritisation of alcohol testing within the ramp inspection programme in accordance with [ARO.RAMP.105](#) based on a risk assessment performed by the Agency, taking into account the robustness and effectiveness of existing psychoactive testing programmes.
- (c) When selecting operators for alcohol testing of flight and cabin crew, the competent authority shall use the list established in accordance with point (b).
- (d) Whenever data concerning alcohol tests is included in the centralised database in accordance with point (b) of point [ARO.RAMP.145](#), the competent authority shall ensure that such data excludes any personal data of the crew member concerned.
- (e) In case of a reasonable cause or suspicion, alcohol tests may be carried out at any time.
- (f) The alcohol testing methodology shall apply recognised quality standards that ensure accurate testing results.
- (g) A flight crew or cabin crew member who refuses to cooperate during tests or who has been identified to be under the influence of alcohol after a positive test shall not be allowed to continue his or her duty.

AMC1 ARO.RAMP.106 Alcohol testing

ED Decision 2018/012/R

GENERAL — ALCOHOL TESTING METHODOLOGY

- (a) If alcohol testing is carried out by RAMP inspectors under the RAMP inspection programme, the following alcohol testing methodology should be used to ensure accurate testing results.
 - (1) The alcohol test should be carried out with an appropriate and approved testing device in accordance with national requirements on alcohol testing of individuals.
 - (2) The ramp inspector that carries out the alcohol test should be adequately trained and qualified.

- (3) After an initial positive alcohol test, a further confirmation test should be carried out in accordance with national requirements on alcohol testing of individuals.
- (4) Testing procedures should specify the following:
 - (1) Handling of test results, in order to determine a true positive test
 - (2) The process to be followed in case of a confirmed positive test result, including how to inform the crew member concerned about the actual testing result
- (b) Initial alcohol test
 - (1) The initial alcohol test should be carried out using a breath alcohol analyser to ensure that initial alcohol testing is non-invasive.
 - (2) The breath alcohol concentration (BrAC), measured by a breath alcohol analyser during the initial alcohol test, should not exceed a level equivalent to 0.2 grams of blood alcohol concentration (BAC) per litre of blood or the lower of the national statutory limits, whichever is the lower.
- (c) During a confirmation alcohol test, the BAC should not exceed a level equivalent to 0.2 grams per litre of blood or the lower of the national statutory limits, whichever is the lower.
- (d) In case of a positive alcohol test following a confirmation alcohol test or in case of a refusal by the crew member to cooperate during an alcohol test, the competent authority should inform the crew member concerned, as well as the competent authority and the authority responsible for the crew concerned.
- (e) A refusal by a crew member to cooperate during an alcohol test should be regarded in the same way as a positive test and as such should be regarded as a refusal to grant access in accordance with [ORO.GEN.140](#) in the case of an EU operator or in accordance with TCO.115 of Commission Regulation (EU) No 452/2014 in the case of a third-country operator.
- (f) The competent authority should provide information on its alcohol testing procedures in an easily accessible format.

GM1 ARO.RAMP.106 Alcohol testing

ED Decision 2018/012/R

CONDUCT OF THE ALCOHOL TEST

- (a) An alcohol test may be carried out at any time during a ramp inspection.
- (b) In order to ensure sufficient time in case of a confirmation test, following an initial test, the alcohol test should, where possible, be carried out at the start of the inspection.
- (c) At all times when carrying out an alcohol test, the inspector should ensure a testing environment as discreet as possible.

GM2 ARO.RAMP.106 Alcohol testing

ED Decision 2018/012/R

GUIDANCE ON CARRYING OUT A CONFIRMATION ALCOHOL TEST

- (a) The written information after a positive confirmation test provided to the crew member concerned contains information on the time and date of the alcohol test, the equipment used, as well as the actual result of the alcohol test.
- (b) A further confirmation test may be carried out at least 15 minutes, but not more than 30 minutes, after the completion of the initial test. During this time, the inspector should observe that the flight and cabin crew member does not eat or drink or ingest something into their mouth, in order to prevent any accumulation of alcohol in the mouth from leading to an artificially high reading.

GM3 ARO.RAMP.106 Alcohol testing

ED Decision 2018/012/R

INFORMATION ON ALCOHOL TESTING

The information by the competent authority on its alcohol testing procedures should include information on the applicable national statutory limit.

ARO.RAMP.110 Collection of information

Regulation (EU) No 965/2012

The competent authority shall collect and process any information deemed useful for conducting ramp inspections.

AMC1 ARO.RAMP.110 Collection of information

ED Decision 2014/025/R

COLLECTION OF INFORMATION

The information should include:

- (a) important safety information available, in particular, through:
 - (1) pilot reports;
 - (2) maintenance organisation report;
 - (3) incident reports;
 - (4) reports from other organisations, independent from the inspection authorities;
 - (5) complaints; and
 - (6) information received from whistleblowers (such as, but not limited to, ground handling or maintenance personnel) regarding poor maintenance, obvious damage or defects, incorrect loading, etc.

- (b) information on action(s) taken subsequent to a ramp inspection, such as:
 - (1) aircraft grounded;
 - (2) aircraft or operator banned from the Member State pursuant to Article 6 of Regulation (EC) No 2111/2005 of the European Parliament and of the Council¹;
 - (3) corrective action required;
 - (4) contacts with the operator's competent authority; and
 - (5) restrictions on flight operations.
- (c) follow-up information concerning the operator, such as:
 - (1) implementation of corrective action(s); and
 - (2) recurrence of non-compliance.

ARO.RAMP.115 Qualification of ramp inspectors

Regulation (EU) 2019/1384

- (a) The competent authority and the Agency shall have qualified inspectors to conduct ramp inspections.
- (b) Ramp inspectors shall:
 - (1) possess the necessary aeronautical education or practical knowledge relevant to their area(s) of inspection;
 - (2) have successfully completed:
 - (i) appropriate specific theoretical and practical training, in one or more of the following areas of inspection:
 - (A) flight deck;
 - (B) cabin safety;
 - (C) aircraft condition;
 - (D) cargo;
 - (ii) appropriate on-the-job training delivered by a senior ramp inspector appointed by the competent authority or the Agency;
 - (3) maintain the validity of their qualification by undergoing recurrent training and by performing a minimum of 12 inspections per calendar year.
- (c) The training in (b)(2)(i) shall be delivered by the competent authority or by any training organisation approved in accordance with [ARO.RAMP.120\(a\)](#).
- (d) The Agency shall develop and maintain training syllabi and promote the organisation of training courses and workshops for inspectors to improve the understanding and uniform implementation of this Subpart.

¹ Regulation (EC) No 2111/2005 of the European Parliament and of the Council of 14 December 2005 on the establishment of a Community list of air carriers subject to an operating ban within the Community and on informing air transport passengers of the identity of the operating air carrier, and repealing Article 9 of Directive 2004/36/EC (OJ L 344, 27.12.2005, p. 15).

- (e) The Agency shall facilitate and coordinate an inspector exchange programme aimed at allowing inspectors to obtain practical experience and contributing to the harmonisation of procedures.

AMC1 ARO.RAMP.115(a)(b) Qualification of ramp inspectors

ED Decision 2019/007/R

ELIGIBILITY CRITERIA

- (a) The candidate should be considered eligible to become a ramp inspector provided he/she meets the following criteria:
- (1) has good knowledge of the English language attested by a certificate, unless English was used as a medium of instruction during secondary or higher education; and
 - (2) relevant education or training and appropriate recent work experience (over the previous 5 years) in accordance with one of the following items:
 - (i) has successfully completed 3 years of post-secondary education followed by 2 years aeronautical experience in the field of aircraft operations and/or maintenance, and/or personnel licensing;
 - (ii) has or has had a commercial/airline transport pilot licence and carried out such duties;
 - (iii) has or has had a flight engineer licence and carried out such duties;
 - (iv) has been a cabin crew member and carried out such duties in commercial air transport;
 - (v) has been licensed as maintenance personnel and exercised the privileges of such a licence;
 - (vi) has successfully completed professional training in the field of air transport of dangerous goods, followed by experience in this field; or
 - (vii) has successfully completed post-secondary aeronautical education with a duration of at least 3 years, followed by aeronautical experience.

AMC2 ARO.RAMP.115(a)(b) Qualification of ramp inspectors

ED Decision 2019/007/R

QUALIFICATION PROCESS

- (a) The competent authority should ensure that its inspectors meet, at all times, the qualification criteria with regard to training and recent experience.
- (b) Any competent authority or ramp inspection training organisation (RITO) approved in accordance with [ARO.RAMP.120\(a\)](#) may provide the initial theoretical and practical training.
- (c) The senior ramp inspectors delivering the on-the-job training may be appointed by any competent authority.
- (d) The initial theoretical and practical training, as well as the on-the-job training as per [ARO.RAMP.115\(b\)\(2\)](#), should be completed within 12 months. If the qualification of the candidate is not completed within 12 months, the entire process should be re-initiated.

- (e) The competent authority should issue a formal qualification statement, including the inspection privileges, for each candidate who has successfully completed the initial theoretical, practical, and on-the-job-training, as demonstrated by:
- (1) for theoretical and practical trainings, a satisfactory evaluation by the competent authority or by the RITO which has delivered the training;
 - (2) for on-the-job training, the positive assessment, made by the senior ramp inspectors who have provided the training, of the candidate's ability to effectively perform ramp inspections in an operational environment;
 - (3) a final assessment of the inspector's competency performed at the end of the initial training process by the competent authority.

AMC3 ARO.RAMP.115(a)(b) Qualification of ramp inspectors

ED Decision 2019/007/R

INITIAL THEORETICAL AND PRACTICAL TRAINING

- (a) The initial theoretical and practical training for ramp inspectors should be developed on the basis of the syllabi that are established by the Agency and which are included as appendixes of the ramp inspection manual.
- (b) The duration of the initial theoretical training should be no less than 3 training days, except for cases when previous training can be credited to the candidate, following an assessment made by the competent authority.

In case of an integrated training course, intended to transfer both technical and specific ramp inspection knowledge, the duration of the course should be extended accordingly.

- (c) The duration of the initial practical training should be not less than 1 day. The competent authority of the candidate may decide to lengthen or shorten the training taking into account the level of expertise of the candidate.

AMC4 ARO.RAMP.115(a)(b) Qualification of ramp inspectors

ED Decision 2019/007/R

ON-THE-JOB TRAINING

- (a) The on-the-job training (OJT) should be conducted within the scope defined by [ARO.RAMP.005](#).
- (b) The content of the OJT should be established on the basis of the list of elements to be covered, which is included in appendixes of the ramp inspection manual.
- (c) The competent authority should ensure that only the candidates that have successfully completed the initial theoretical and practical trainings are undertaking the OJT.
- (d) The OJT should comprise 2 phases:
- (1) Observation:
During this phase, the candidate should accompany and observe a senior ramp inspector performing a series of ramp inspections (including the preparation of the inspection and post-inspection activities such as reporting).

The senior inspector should also provide details on applicable follow-up activities.

- (2) Under supervision:
- During this phase, the candidate should perform ramp inspections under the supervision and guidance of a senior ramp inspector.
- (e) The duration of the OJT should be customised to the individual training needs of each candidate. As a minimum, the OJT should include at least 6 observed ramp inspections and 6 ramp inspections performed under the supervision of a senior ramp inspector, over a period of maximum of 6 months. Notwithstanding (a), up to 3 of these observed ramp inspections and 3 of these inspections under supervision may be performed on national operators, as long as they are performed in accordance with ARO.RAMP.
- (f) The OJT should cover in each phase all inspection items that the inspector will be privileged with, and it should be delivered by senior ramp inspectors who are privileged with the same items.
- (g) The OJT should be documented by the senior ramp inspectors who have provided the training, using OJT forms detailing the training content.
- (h) Certain OJT items may be replaced by alternative training using representative examples when no operational environment is required (e.g. documents, dangerous goods).

AMC5 ARO.RAMP.115(a)(b) Qualification of ramp inspectors

ED Decision 2019/007/R

EXTENSION OF THE RAMP INSPECTOR PRIVILEGES

- (a) The competent authority may extend the privileges of a ramp inspector provided that the following conditions are met:
- (1) the relevant knowledge of the ramp inspector has been satisfactorily complemented by additional theoretical and/or practical training relevant to the scope of the extension; and
 - (2) the ramp inspector has received OJT on the new inspection items that will be added to his/her privileges.
- (b) The competent authority should determine the necessary number of ramp inspections of the OJT on a case-by-case basis, taking into account both the complexity and the criticality of the new items to be covered during this training, as well as the inspector's aeronautical education and practical knowledge.
- (c) Certain OJT items may be replaced by alternative training using representative examples when no operational environment is required (e.g. document inspections, dangerous goods).

AMC6 ARO.RAMP.115(a)(b) Qualification of ramp inspectors

ED Decision 2019/007/R

RECENT EXPERIENCE AND REQUALIFICATION

- (a) The minimum number of inspections to be performed by a ramp inspector to meet the recent experience requirement should be 12 per calendar year.
- (b) Up to half of these ramp inspections may be performed on national operators, as long as they are performed in accordance with ARO.RAMP.

- (c) In the calendar year during which the ramp inspector is qualified, the minimum number of inspections to meet the recent experience requirement should be determined on a pro rata basis.
- (d) When qualification is lost as a result of failure to perform the minimum number of inspections, the ramp inspector may be requalified by the competent authority after having performed at least half of the missing inspections under supervision of a senior inspector within the following calendar year. These inspections under supervision should not be counted for the recent experience requirements for that calendar year. Up to half of these inspections may be performed on national operators, as long as they are performed in accordance with ARO.RAMP.
- (e) If the ramp inspector cannot regain the qualification following the process described in (d), he/she should perform a complete OJT during the calendar year that follows.
- (f) If the ramp inspector fails to regain the qualification following the process described in (e), the conditions for initial qualification should apply.

AMC7 ARO.RAMP.115(a)(b) Qualification of ramp inspectors

ED Decision 2019/007/R

RECURRENT TRAINING

- (a) The competent authority should ensure that all ramp inspectors undergo recurrent training at least once every 3 calendar years.
- (b) In addition, the competent authority should ensure that additional training is provided to all ramp inspectors when information is received from the Agency about the necessity for ad hoc training. In developing such training, the competent authority should take into account any Agency instructions related to the training content and the associated timeframe for implementation. This ad-hoc training may be considered as recurrent training.
- (c) Recurrent training should be delivered by a competent authority, by a ramp inspection training organisation approved in accordance with [ARO.RAMP.120\(a\)](#) or by the Agency.
- (d) The recurrent training should cover at least the following elements:
 - (1) regulatory and procedural developments;
 - (2) operational practices;
 - (3) articulation with other European processes and regulations; and
 - (4) standardisation and harmonisation issues including those communicated by the Agency.

AMC8 ARO.RAMP.115(a)(b) Qualification of ramp inspectors

ED Decision 2019/007/R

SENIOR RAMP INSPECTORS

- (a) The competent authority may appoint senior ramp inspectors provided the appointees meet the following criteria:
 - (1) the appointee has been a qualified ramp inspector over the 36 months preceding his/her appointment; and

- (2) during the period under (1), the appointee has performed a minimum of 72 ramp inspections, with no less than 24 ramp inspections during the last 12 months;
- (b) Senior ramp inspectors should maintain their seniority only if performing at least 24 ramp inspections during each calendar year. Up to 6 of these ramp inspections may be performed on national operators, as long as they are performed in accordance with ARO.RAMP.
- (c) For the calendar year during which the senior inspector was appointed, the recent experience requirements should be applied on a pro rata basis.
- (d) When seniority is lost, but not the ramp inspector qualification, as a result of failure to perform the minimum number of ramp inspections, it can be regained if:
- (1) the inspector performs 2 ramp inspections under the supervision of a senior ramp inspector; or
 - (2) the inspector performs the missing number of ramp inspections.
- These inspections should be performed within the following year, and should not be counted for the recent experience requirements for that year.
- The above provision should not be used for two consecutive years.
- (e) If the senior ramp inspector cannot regain his/her seniority following the provisions under (d), the conditions under (a)(2) apply.
- (f) For each appointed senior ramp inspector, the competent authority should establish, based on his/her experience, the privileges for which he/she may deliver OJT.

ARO.RAMP.120 Approval of training organisations

Regulation (EU) No 965/2012

- (a) The competent authority shall approve a training organisation, having its principal place of business in the territory of the respective Member State, when satisfied that the training organisation:
- (1) has nominated a head of training possessing sound managerial capability to ensure that the training provided is in compliance with the applicable requirements;
 - (2) has available training facilities and instructional equipment suitable for the type of training provided;
 - (3) provides training in accordance with the syllabi developed by the Agency in accordance with [ARO.RAMP.115\(d\)](#);
 - (4) uses qualified training instructors.
- (b) If so requested by the competent authority, the verification of compliance and continuous compliance with the requirements referred to in (a) shall be performed by the Agency.
- (c) The training organisation shall be approved to provide one or more of the following types of training:
- (1) initial theoretical training;
 - (2) initial practical training;
 - (3) recurrent training.

AMC1 ARO.RAMP.120(a) Approval of training organisations

ED Decision 2019/007/R

APPROVAL OF A RAMP INSPECTION TRAINING ORGANISATION BY THE COMPETENT AUTHORITY

- (a) When evaluating the ramp inspection training organisation's capability to deliver training, the competent authority should verify that the training organisation:
- (1) Has established a detailed description of:
 - (i) the organisational structure;
 - (ii) the facilities and office accommodation;
 - (iii) the instructional equipment;
 - (iv) the instructor recruitment and maintenance of their continuing competence;
 - (v) the record keeping system;
 - (vi) the process for the development of the training course material and its continuous update; and
 - (vii) additional means and methods used to fulfil its tasks,

The documents and information specified above may be included into an organisation manual.
 - (2) Has developed the training course materials adequate for all types of training to be delivered;
 - (3) Ensures compliance with its own procedures on adequate control of the training development, preparation, delivery process and records keeping, as well as compliance with the legal requirements. The training organisation should evaluate the effectiveness of the training provided, based upon written feedbacks collected from course participants after each training delivery.
 - (4) Conducts the training in English with the aim to train trainees in the jargon used during ramp inspections;
- (b) The competent authority should issue the approval for an unlimited duration.

AMC2 ARO.RAMP.120(a) Approval of training organisations

ED Decision 2019/007/R

OVERSIGHT OF APPROVED RAMP INSPECTION TRAINING ORGANISATION

- (a) The oversight programme of ramp inspection training organisations should be developed taking into account the scope of the approval, the size of the organisation, and the results of past certification and/or oversight activities.
- (b) An oversight cycle not exceeding 24 months should be applied. The oversight planning cycle may be extended to a maximum of 48 months if the competent authority has established that during the previous 24 months:
- (1) all corrective actions have been implemented within the time period accepted or extended by the competent authority; and
 - (2) no level 1 findings as described in [ARO.GEN.350](#) have been issued.

AMC1 ARO.RAMP.120(a)(4) Approval of training organisations

ED Decision 2019/007/R

TRAINING INSTRUCTORS

- (a) The competent authority should verify that:
- (1) the training organisation has a sufficient number of instructors with at least adequate:
 - (i) aviation knowledge and experience;
 - (ii) knowledge of the EU ramp inspection programme;
 - (iii) knowledge of training delivery techniques; and
 - (iv) English language communication skills.
 - (b) Instructors delivering training on inspection items and/or delivering practical training should:
 - (1) have been a qualified ramp inspector for 36 months before being nominated as instructors and have performed a minimum of 72 ramp inspections during this period;
 - (2) have conducted at least 24 inspections as qualified ramp inspectors in the calendar year prior to the year in which the training is delivered; and
 - (3) deliver training only on those inspection items which they are entitled to inspect;
 - (c) Notwithstanding (a), for the delivery of the theoretical and practical training on Dangerous Goods, the competent authority may accept instructors who are certified in accordance with the Technical Instructions for the latest effective edition of the Safe Transport of Dangerous Goods by Air (ICAO Doc 9284-AN/905), provided that they possess adequate English language communication skills.

ARO.RAMP.125 Conduct of ramp inspections

Regulation (EU) 2019/1384

- (a) Ramp inspections shall be performed in a standardised manner.
- (b) When performing a ramp inspection, the inspector(s) shall make all possible efforts to avoid an unreasonable delay of the aircraft inspected.
- (c) On completion of the ramp inspection, the pilot-in-command or, in his/her absence, another flight crew member or a representative of the operator shall be informed of the ramp inspection's results.

**AMC1 ARO.RAMP.125 Conduct of Ramp Inspections &
ARO.RAMP.130 Categorisation of findings**

ED Decision 2019/007/R

INSPECTION INSTRUCTIONS ON THE CATEGORISATION OF FINDINGS

Inspectors should follow the inspection instructions as defined in the ramp inspection manual on the categorisation of findings established by the Agency for inspections performed on aircraft used by third country operators (SAFA) and on aircraft used by operators under the regulatory oversight of another Member State (SACA).

AMC1 ARO.RAMP.125(b) Conduct of ramp inspections

ED Decision 2019/007/R

GENERAL

- (a) The competent authority should put in place appropriate procedures to allow the inspecting team unrestricted access to the aircraft to be inspected. In this respect ramp inspectors should possess adequate credentials.
- (b) The inspection should start as soon as possible and be as comprehensive as possible within the time and resources available. This means that if only a limited amount of time or resources is available, not all inspection items but a reduced number of them, may be verified. According to the time and resources available for a ramp inspection, the items that are to be inspected should be selected accordingly, in conformity with the objectives of the ramp inspection programme. Items not being inspected may be inspected during a next inspection.
- (c) During the inspection, ramp inspectors should verify the rectification of previously identified non-compliances. Whenever the time available does not permit a full inspection, the items affected by such non-compliances should be prioritised over other items.
- (d) Ramp inspectors should not open by themselves any hatches, doors or panels, which are not intended to be operated by passengers during normal operations, nor should they operate or interfere with any aircraft controls or equipment. When such actions are required for the scope of the inspection, the ramp inspectors should request the assistance of the operator's personnel (flight crew, cabin crew, ground crew).
- (e) During an inspection prior to departure, the competent authority should inform the operator of any potential non-compliance with manufacturer's standards after the crew has confirmed that the pre-flight inspection has been performed.
- (f) The items to be inspected should be selected from the Proof of Inspection (POI).
- (g) Items which have been inspected, as well as any possible findings and observations, should be recorded on the POI and in the ramp inspection tool.

AMC1 ARO.RAMP.125(c) Conduct of ramp inspections

ED Decision 2019/007/R

PROOF OF INSPECTION

- (a) On completion of the ramp inspection, information about its results should be provided to the pilot-in-command/commander or, in his/her absence, to another member of the flight crew or a representative of the operator, using the Proof of Inspection (POI) form provided as an appendix to the ramp inspection manual, regardless of whether or not findings have been identified. When completing the Proof of Inspection (POI), the following should be taken into account:
 - (1) Only the remarks mentioned in the POI should be reported as findings in the final ramp inspection report. Any other relevant information which was not included in the POI should only be reported in the final report as a general remark under 'G' or in the additional information box.
 - (2) When handing over the POI to the pilot-in-command/commander or operator representative, the inspector should ask him/her to sign the POI whilst explaining that the signature does in no way imply acceptance of the listed findings. The signature only

confirms that the POI has been received by the pilot-in-command/operator representative, and that the aircraft has been inspected on the date and at the place indicated. A refusal to sign by the recipient should be recorded in the document.

- (b) POIs may be completed electronically, including the required signatures, and may be printed on site or delivered electronically (e.g. by e-mail).

ARO.RAMP.130 Categorisation of findings

Regulation (EU) No 965/2012

For each inspection item, three categories of possible non-compliance with the applicable requirements are defined as findings. Such findings shall be categorised as follows:

- (1) a category 3 finding is any detected significant non-compliance with the applicable requirements or the terms of a certificate that has a major influence on safety;
- (2) a category 2 finding is any detected non-compliance with the applicable requirements or the terms of a certificate that has a significant influence on safety;
- (3) a category 1 finding is any detected non-compliance with the applicable requirements or the terms a certificate that has a minor influence on safety.

ARO.RAMP.135 Follow-up actions on findings

Regulation (EU) No 965/2012

- (a) For a category 2 or 3 finding the competent authority, or where relevant the Agency, shall:
- (1) communicate the finding in writing to the operator, including a request for evidence of corrective actions taken; and
 - (2) inform the competent authority of the State of the operator and, where relevant, the State in which the aircraft is registered and where the licence of the flight crew was issued. Where appropriate, the competent authority or Agency shall request confirmation of their acceptance of the corrective actions taken by the operator in accordance with [ARO.GEN.350](#) or [ARO.GEN.355](#).
- (b) In addition to (a), in the case of a category 3 finding, the competent authority shall take immediate steps by:
- (1) imposing a restriction on the aircraft flight operation;
 - (2) requesting immediate corrective actions;
 - (3) grounding the aircraft in accordance with [ARO.RAMP.140](#); or
 - (4) imposing an immediate operating ban in accordance with Article 6 of Regulation (EC) No 2111/2005.
- (c) When the Agency has raised a category 3 finding, it shall request the competent authority where the aircraft is landed to take the appropriate measures in accordance with (b).

AMC1 ARO.RAMP.135(a) Follow-up actions on findings

ED Decision 2019/007/R

FOLLOW-UP ACTIONS FOR CATEGORY 2 OR 3 FINDINGS

- (a) Exceptionally, where multiple category 2 findings have been raised and the accumulation of these findings or their interaction justifies corrective action before the flight takes place, the class of action may be increased to the actions foreseen by [ARO.RAMP.135\(b\)](#).
- (b) When communicating findings to the operator, the inspecting authority should:
 - (1) use the ramp inspection tool as the primary communication channel with the operator and limit communication via other channels;
 - (2) request evidence of corrective actions taken, or alternatively the submission of a corrective action plan followed by evidence that planned corrective actions have been taken;
 - (3) inform the operator's competent authority and the operator no later than 15 calendar days after the inclusion of the report in the ramp inspection tool in order to permit appropriate action to be taken, as well as to confirm to the operator the findings raised;
 - (4) upload in the ramp inspection tool information on actions taken and responses provided by the operator following the RAMP inspection and send a communication to the operator only if the operator's actions have not been satisfactory;
 - (5) give the operator a period of 30 calendar days to reply. If the operator does not react to the initial communication within this period, a second request should be sent, including a period of another 30 calendar days to reply whilst copying the operator's competent authority. If the second attempt is also unsuccessful, the operator's competent authority should be requested to encourage the operator to reply. The inspecting authority should indicate in such request that no reaction from the operator could be interpreted as a 'lack of ability and/or willingness of an operator to address safety deficiencies' under Regulation (EC) No 2111/2005.

AMC1 ARO.RAMP.135(b) Follow-up actions on findings

ED Decision 2019/007/R

CLASSES OF ACTIONS FOR CATEGORY 3 FINDINGS

- (a) Whenever restrictions on the aircraft flight operation (Class 3a action) have been imposed, the competent authority should conduct appropriate verification of adherence to such restrictions.
- (b) Whenever the operator is required to take corrective actions before departure (Class 3b action), inspectors should verify that the operator has taken such actions. Depending on the circumstances, this verification may take place after the departure.
- (c) Whenever a category 3 finding is raised, the aircraft should be grounded only (Class 3c action) if the crew refuses to take the necessary corrective actions or to respect imposed restrictions on the aircraft flight operation. However, grounding might be appropriate if an operator refuses to grant access in accordance with [ORO.GEN.140](#) (in case of an EU operator) or contrary to Regulation (EU) 452/2014 (in case of a third country operator). The inspecting authority should then ensure that the aircraft will not depart as long as the reasons for the grounding remain. Any records of communication undertaken pursuant to [ARO.RAMP.140\(b\)](#), as well as other evidences, should be collected and kept as evidential material.

- (d) If inspectors have imposed any restrictions and/or corrective actions, these should be mentioned in the ramp inspection report.

ARO.RAMP.140 Grounding of aircraft

Regulation (EU) 2019/1384

- (a) In the case of a category 3 finding where it appears that the aircraft is intended or is likely to be flown without completion by the operator or owner of the appropriate corrective action, the competent authority shall:
- (1) notify the pilot-in-command/commander or the operator that the aircraft is not permitted to commence the flight until further notice; and
 - (2) ground that aircraft.
- (b) The competent authority of the State where the aircraft is grounded shall immediately inform the competent authority of the State of the operator and of the State in which the aircraft is registered, if relevant, and the Agency in the case of a grounded aircraft used by a third-country operator.
- (c) The competent authority shall, in coordination with the State of the operator or the State of Registry, prescribe the necessary conditions under which the aircraft can be allowed to take-off.
- (d) If the non-compliance affects the validity of the certificate of airworthiness of the aircraft, the grounding shall only be lifted by the competent authority when the operator shows evidence that:
- (1) compliance with the applicable requirements has been re-established;
 - (2) it has obtained a permit-to-fly in accordance with Regulation (EU) No 748/2012, for aircraft registered in a Member State;
 - (3) a permit-to-fly or equivalent document of the State of Registry or the State of the operator for aircraft registered in a third country and operated by an EU or a third country operator; and
 - (4) permission from third countries which will be overflown, if applicable.

ARO.RAMP.145 Reporting

Regulation (EU) No 965/2012

- (a) Information collected in accordance with [ARO.RAMP.125\(a\)](#) shall be entered into the centralised database referred to in [ARO.RAMP.150\(b\)\(2\)](#), within 21 calendar days after the inspection.
- (b) The competent authority or the Agency shall enter into the centralised database any information useful for the application of Regulation (EC) No 216/2008 and its Implementing Rules and for the accomplishment by the Agency of the tasks assigned to it by this Annex, including the relevant information referred to in [ARO.RAMP.110](#).
- (c) Whenever the information as referred to in [ARO.RAMP.110](#) shows the existence of a potential safety threat, such information shall also be communicated to each competent authority and the Agency without delay.

- (d) Whenever information concerning aircraft deficiencies is given by a person to the competent authority, the information referred to in [ARO.RAMP.110](#) and [ARO.RAMP.125\(a\)](#) shall be de-identified regarding the source of such information.

AMC1 ARO.RAMP.145 Safety reports

ED Decision 2019/007/R

IMPORTANT SAFETY INFORMATION

- (a) When the competent authority receives safety-related information that could be of interest to the entire RAMP community, it should create a 'safety report' and insert it into the ramp inspection tool pursuant to [ARO.RAMP.110](#).
- (b) Safety-related information should be verified by the reporting authority, as far as possible, before insertion in the ramp inspection tool.
- (c) If available, any relevant information contained in documents and pictures should be attached to the 'safety report'.

ARO.RAMP.150 Agency coordination tasks

Regulation (EU) 2019/1384

- (a) The Agency shall manage and operate the tools and procedures necessary for the storage and exchange of:
- (1) the information referred to in [ARO.RAMP.145](#);
 - (2) the information provided by third countries or international organisations with whom appropriate agreements have been concluded with the EU, or organisations with whom the Agency has concluded appropriate arrangements in accordance with Article 27(2) of Regulation (EC) No 216/2008.
- (b) This management shall include the following tasks:
- (1) store data from the Member States relevant to the safety information on aircraft landing at aerodromes located in the territory subject to the provisions of the Treaty;
 - (2) develop, maintain and continuously update a centralised database containing all the information referred to in (a)(1) and (2);
 - (3) provide necessary changes and enhancements to the database application;
 - (4) analyse the centralised database and other relevant information concerning the safety of aircraft and of air operators and, on that basis:
 - (i) advise the Commission and the competent authorities on immediate actions or follow-up policy;
 - (ii) report potential safety problems to the Commission and to the competent authorities;
 - (iii) propose coordinated actions to the Commission and to the competent authorities, when necessary on safety grounds, and ensure coordination at the technical level of such actions;

- (5) liaise with other European institutions and bodies, international organisations and third country competent authorities on information exchange.

AMC1 ARO.RAMP.150(b)(4)(iii) Agency coordination tasks

ED Decision 2019/007/R

SYSTEM-WIDE COORDINATION OF RAMP INSPECTIONS

In order to ensure a coordinated approach in establishing a risk-based number of ramp inspections for operators, the Agency should establish annual targets. When doing so, the following should be taken into account:

- (a) Such targets should only be established for operators flying to Member States' territories located in the ICAO EUR region;
- (b) The targets for the upcoming year should be distributed to the Member States at the latest by 1 December and updated at least once during the upcoming year; and
- (c) The targets should be established per Member State for two layers of operators as follows:
 - (1) a target number of inspections for each operator for which the average number of commercial flights for the previous 12 months in each Member State is beyond a threshold defined by the Agency, based on an assessment of the safety risks and the number of flights ('layer 1');
 - (2) an overall target number of inspections for those operators not covered by (1) ('layer 2').

ARO.RAMP.155 Annual report

Regulation (EU) No 965/2012

The Agency shall prepare and submit to the Commission an annual report on the ramp inspection system containing at least the following information:

- (a) status of the progress of the system;
- (b) status of the inspections performed in the year;
- (c) analysis of the inspection results with indication of the categories of findings;
- (d) actions taken during the year;
- (e) proposals for further improving the ramp inspection system; and
- (f) annexes containing lists of inspections sorted out by State of operation, aircraft type, operator and ratios per item.

ARO.RAMP.160 Information to the public and protection of information

Regulation (EU) No 965/2012

- (a) Member States shall use the information received by them pursuant to [ARO.RAMP.105](#) and [ARO.RAMP.145](#) solely for the purpose of Regulation (EC) No 216/2008 and its implementing rules and shall protect it accordingly.

- (b) The Agency shall publish an aggregated information report annually that shall be available to the public containing the analysis of the information received in accordance with [ARO.RAMP.145](#). The report shall be simple and easy to understand, and the source of the information shall be de-identified.

Appendix I to Annex II (Part-ARO)

Regulation (EU) 2019/1384

AIR OPERATOR CERTIFICATE (Approval schedule for air transport operators)		
Types of operation: Commercial air transport (CAT) <input type="checkbox"/> Passengers; <input type="checkbox"/> Cargo; <input type="checkbox"/> Other ⁽¹⁾ :		
(4)	State of the Operator ⁽²⁾ <hr/> Issuing Authority ⁽³⁾	(5)
AOC # ⁽⁶⁾ :	Operator Name ⁽⁷⁾ Dba Trading Name ⁽⁸⁾ Operator address ⁽¹⁰⁾ : Telephone ⁽¹¹⁾ : Fax: E-mail:	Operational Points of Contact: ⁽⁹⁾ Contact details, at which operational management can be contacted without undue delay, are listed in ⁽¹²⁾ .
This certificate certifies that ⁽¹³⁾ is authorised to perform commercial air operations, as defined in the attached operations specifications, in accordance with the operations manual, Annex V to Regulation (EU) 2018/1139 and its delegated and implementing acts.		
Date of issue ⁽¹⁴⁾ :	Name and Signature ⁽¹⁵⁾ : Title:	
(1) Other type of transportation to be specified. (2) Replaced by the name of the State of the operator. (3) Replaced by the identification of the issuing competent authority. (4) For use of the competent authority. (5) For use of the competent authority. (6) Approval reference, as issued by the competent authority. (7) Replaced by the operator's registered name. (8) Operator's trading name, if different. Insert "Dba" (for "Doing business as") before the trading name. (9) The contact details include the telephone and fax numbers, including the country code, and the email address (if available) at which operational management can be contacted without undue delay for issues related to flight operations, airworthiness, flight and cabin crew members' competency, dangerous goods and other matters as appropriate. (10) Operator's principal place of business address. (11) Operator's principal place of business telephone and fax details, including the country code. Email to be provided if available. (12) Insertion of the controlled document, carried on board, in which the contact details are listed, with the appropriate paragraph or page reference. E.g.: "Contact details ... are listed in the operations manual, gen/basic, chapter 1, 1.1"; or "... are listed in the operations specifications, page 1"; or "... are listed in an attachment to this document". (13) Operator's registered name. (14) Issue date of the AOC (dd-mm-yyyy). (15) Title, name and signature of the competent authority representative. In addition, an official stamp may be applied on the AOC.		

Appendix II to Annex II (Part-ARO)

Regulation (EU) 2021/2237

OPERATIONS SPECIFICATIONS (subject to the approved conditions in the operations manual)				
Issuing authority contact details Telephone ⁽¹⁾ : _____; Fax: _____; Email: _____				
AOC ⁽²⁾ :	Operator name ⁽³⁾ :	Date ⁽⁴⁾ :	Signature:	
Db a trading name				
Operations specifications #:				
Aircraft model ⁽⁵⁾ :				
Registration marks ⁽⁶⁾ :				
Types of operations: Commercial air transport				
<input type="checkbox"/> Passengers	<input type="checkbox"/> Cargo	<input type="checkbox"/> Others ⁽⁷⁾ : _____		
Area of operation ⁽⁸⁾ :				
Special limitations ⁽⁹⁾ :				
Specific approvals:	Yes	No	Specification ⁽¹⁰⁾	Remarks
Dangerous goods:	<input type="checkbox"/>	<input type="checkbox"/>		
Low-visibility operations				
Take-off	<input type="checkbox"/>	<input type="checkbox"/>	RVR ⁽¹¹⁾ :... m	
Approach and landing	<input type="checkbox"/>	<input type="checkbox"/>	CAT ⁽¹²⁾ DA/H: ft, RVR:... m	
Operational credits	<input type="checkbox"/>	<input type="checkbox"/>	CAT ⁽¹³⁾DA/H: ft, RVR:... m	
RVSM ⁽¹⁴⁾ <input type="checkbox"/> N/A	<input type="checkbox"/>	<input type="checkbox"/>	<input type="checkbox"/>	
ETOPS ⁽¹⁵⁾ <input type="checkbox"/> N/A	<input type="checkbox"/>	<input type="checkbox"/>	<input type="checkbox"/> Maximum diversion time ⁽¹⁶⁾ : min.	
Complex navigation specifications for PBN operations ⁽¹⁷⁾	<input type="checkbox"/>	<input type="checkbox"/>		⁽¹⁸⁾
Minimum navigation performance specification	<input type="checkbox"/>	<input type="checkbox"/>		
Operations of single-engined turbine aeroplane at night or in IMC (SET-IMC)	<input type="checkbox"/>	<input type="checkbox"/>	⁽¹⁹⁾	
Helicopter operations with the aid of night vision imaging systems	<input type="checkbox"/>	<input type="checkbox"/>		
Helicopter hoist operations	<input type="checkbox"/>	<input type="checkbox"/>		
Helicopter emergency medical service operations	<input type="checkbox"/>	<input type="checkbox"/>		
Helicopter offshore operations	<input type="checkbox"/>	<input type="checkbox"/>		
Cabin crew training ⁽²⁰⁾	<input type="checkbox"/>	<input type="checkbox"/>		
Issue of CC attestation ⁽²¹⁾	<input type="checkbox"/>	<input type="checkbox"/>		
Use of type B EFB applications	<input type="checkbox"/>	<input type="checkbox"/>	⁽²²⁾	
Continuing airworthiness	<input type="checkbox"/>	<input type="checkbox"/>	⁽²³⁾	
Others ⁽²⁴⁾				

- (1) Telephone contact details of the competent authority, including the country code. Email to be provided as well as fax if available.
- (2) Insertion of associated air operator certificate (AOC) number.
- (3) Insertion of the operator's registered name and the operator's trading name, if different. Insert 'Dba' before the trading name (for 'Doing business as').
- (4) Issue date of the operations specifications (dd-mm-yyyy) and signature of the competent authority representative.
- (5) Insertion of ICAO designation of the aircraft make, model and series, or master series, if a series has been designated (e.g. Boeing-737-3K2 or Boeing-777-232).
- (6) The registration marks are listed either in the operations specifications or in the operations manual. In the latter case, the related operations specifications must make a reference to the related page in the operations manual. In case not all specific approvals apply to the aircraft model, the registration marks of the aircraft may be entered in the remark column to the related specific approval.
- (7) Other type of transportation to be specified (e.g. emergency medical service).
- (8) Listing of geographical area(s) of authorised operation (by geographical coordinates or specific routes, flight information region or national or regional boundaries).
- (9) Listing of applicable special limitations (e.g. VFR only, Day only, etc.).
- (10) List in this column the most permissive criteria for each approval or the approval type (with appropriate criteria).
- (11) Insertion of approved minimum take-off RVR in metres. One line per approval may be used if different approvals are granted.
- (12) Insertion of applicable precision approach category: CAT II or CAT III. Insertion of minimum RVR in metres and DH in feet. One line is used per listed approach category.
- (13) Insertion of applicable operational credit: SA CAT I, SA CAT II, EFVS, etc. Insertion of minimum RVR in metres and DH in feet. One line is used per listed operational credit.
- (14) The Not Applicable (N/A) box may be checked only if the aircraft maximum ceiling is below FL290.
- (15) Extended range operations (ETOPS) currently applies only to two-engined aircraft. Therefore, the Not Applicable (N/A) box may be checked if the aircraft model has less or more than two engines.
- (16) The threshold distance may also be listed (in NM), as well as the engine type.
- (17) Performance-based navigation (PBN): one line is used for each complex PBN specific approval (e.g. RNP AR APCH), with appropriate limitations listed in the 'Specifications' or 'Remarks' columns, or in both. Procedure-specific approvals of specific RNP AR APCH procedures may be listed in the operations specifications or in the operations manual. In the latter case, the related operations specifications must have a reference to the related page in the operations manual.
- (18) Specify if the specific approval is limited to certain runway ends or aerodromes, or both.
- (19) Insertion of the particular airframe or engine combination.
- (20) Approval to conduct the training course and examination to be completed by applicants for a cabin crew attestation as specified in Annex V (Part-CC) to [Regulation \(EU\) No 1178/2011](#).
- (21) Approval to issue cabin crew attestations as specified in Annex V (Part-CC) to [Regulation \(EU\) No 1178/2011](#).
- (22) Insertion of the list of type B EFB applications together with the reference of the EFB hardware (for portable EFBs). This list is contained either in the operations specifications or in the operations manual. In the latter case, the related operations specifications must make a reference to the related page in the operations manual.
- (23) The name of the person or organisation responsible for ensuring that the continuing airworthiness of the aircraft is maintained and a reference to the regulation that requires the work, i.e. Subpart G of Annex I (Part-M) to [Regulation \(EU\) No 1321/2014](#).
- (24) Other approvals or data may be entered here, using one line (or one multi-line block) per authorisation (e.g. short landing operations, steep approach operations, reduced required landing distance, helicopter operations to or from a public interest site, helicopter operations over a hostile environment located outside a congested area, helicopter operations without a safe forced landing capability, operations with increased bank angles, maximum distance from an adequate aerodrome for two-engined aeroplanes without an ETOPS approval).

EASA Form 139 Issue 7

Appendix III to Annex II (Part-ARO)

Regulation (EU) 2019/1384

List of specific approvals
Non-commercial operations

Specialised operations
(subject to the conditions specified in the approval and contained in the operations manual or pilot's operating handbook)

Issuing Authority ⁽¹⁾ :		
List of Specific Approvals # ⁽²⁾ :		
Name of Operator:		
Date ⁽³⁾ :		
Signature:		
Aircraft Model and Registration Marks ⁽⁴⁾ :		
Types of specialised operation (SPO), if applicable: <input type="checkbox"/> ⁽⁵⁾ ...		
Specific Approvals ⁽⁶⁾ :	Specification ⁽⁷⁾	Remarks
...		
...		
...		
...		
<p>⁽¹⁾ Insertion of name and contact details.</p> <p>⁽²⁾ Insertion of the associated number.</p> <p>⁽³⁾ Issue date of the specific approvals (dd-mm-yyyy) and signature of the competent authority representative.</p> <p>⁽⁴⁾ Insertion of the Commercial Aviation Safety Team (CAST)/ICAO designation of the aircraft make, model and series, or master series, if a series has been designated (e.g. Boeing-737-3K2 or Boeing-777-232). The CAST/ICAO taxonomy is available at: http://www.intlaviationstandards.org/</p> <p>The registration marks shall be either listed in the list of specific approvals or in the operations manual. In the latter case the list of specific approvals shall refer to the related page in the operation manual.</p> <p>⁽⁵⁾ Specify the type of operation, e.g., agriculture, construction, photography, surveying, observation and patrol, aerial advertisement, maintenance check flights.</p> <p>⁽⁶⁾ List in this column any approved operations, e.g., dangerous goods, LVO, RVSM, PBN, MNPS, HOFO.</p> <p>⁽⁷⁾ List in this column the most permissive criteria for each approval, e.g. the decision height and RVR minima for CAT II.</p>		

EASA FORM 140 Issue 2

Appendix IV to Annex II (Part-ARO)

Regulation (EU) 2019/1384

AUTHORISATION OF HIGH RISK COMMERCIAL SPECIALISED OPERATIONS	
Issuing Authority: ⁽¹⁾	
Authorisation no: ⁽²⁾	
Operator name: ⁽³⁾ Operator address: ⁽⁴⁾ Telephone: ⁽⁵⁾ Fax: E-mail:	
Aircraft model and registration marks: ⁽⁶⁾	
Authorised specialised operation: ⁽⁷⁾	
Authorised area or site of operation: ⁽⁸⁾	
Special limitations: ⁽⁹⁾	
This is to confirm that is authorised to perform high risk commercial specialised operation(s) in accordance with this authorisation, operator's Standard Operating Procedures, Annex V to Regulation (EU) 2018/1139 and its delegated and implementing acts.	
Date of issue ⁽¹⁰⁾ :	Name and Signature ⁽¹¹⁾ : Title:
<p>⁽¹⁾ Name and contact details of the competent authority.</p> <p>⁽²⁾ Insertion of associated authorisation number.</p> <p>⁽³⁾ Insertion of the operator's registered name and the operator's trading name, if different. Insert "Dba" before the trading name (for "Doing business as").</p> <p>⁽⁴⁾ Operator's principal place of business address.</p> <p>⁽⁵⁾ Operator's principal place of business telephone and fax details, including the country code. Email to be provided if available.</p> <p>⁽⁶⁾ Insertion of the Commercial Aviation Safety Team (CAST)/ICAO designation of the aircraft make, model and series, or master series, if a series has been designated (e.g. Boeing-737-3K2 or Boeing-777-232). The CAST/ICAO taxonomy is available at: http://www.intlaviationstandards.org/. The registration marks shall be either listed in the list of specific approvals or in the operations manual. In the latter case the list of specific approvals shall refer to the related page in the operation manual.</p> <p>⁽⁷⁾ Specify the type of operation, e.g., agriculture, construction, photography, surveying, observation and patrol, aerial advertisement, maintenance check flights.</p> <p>⁽⁸⁾ Listing of geographical area(s) or site(s) of authorised operation (by geographical coordinates or flight information region or national or regional boundaries).</p> <p>⁽⁹⁾ Listing of applicable special limitations (e.g. VFR only, Day only, etc.).</p> <p>⁽¹⁰⁾ Issue date of the authorisation (dd-mm-yyyy).</p> <p>⁽¹¹⁾ Title, name and signature of the competent authority representative. In addition, an official stamp may be applied on the authorisation.</p>	

EASA FORM 151 Issue 2

ANNEX III (PART-ORO)

ORO.GEN.005 Scope

Regulation (EU) No 379/2014

This Annex establishes requirements to be followed by an air operator conducting:

- (a) commercial air transport operations (CAT);
- (b) commercial specialised operations;
- (c) non-commercial operations with complex motor-powered aircraft;
- (d) non-commercial specialised operations with complex motor-powered aircraft.

SUBPART GEN: GENERAL REQUIREMENTS

SECTION 1 – GENERAL

ORO.GEN.105 Competent authority

Regulation (EU) No 379/2014

For the purpose of this Annex, the competent authority exercising oversight over operators subject to a certification or declaration obligation or specialised operation authorisation shall be for operators having their principal place of business in a Member State, the authority designated by that Member State.

ORO.GEN.110 Operator responsibilities

Regulation (EU) 2019/1384

- (a) The operator is responsible for the operation of the aircraft in accordance with Annex IV to Regulation (EC) No 216/2008, as applicable, the relevant requirements of this Annex and its air operator certificate (AOC) or specialised operation authorisation (SPO authorisation) or declaration.
- (b) Every flight shall be conducted in accordance with the provisions of the operations manual.
- (c) The operator shall establish and maintain a system for exercising operational control over any flight operated under the terms of its certificate, SPO authorisation or declaration.
- (d) The operator shall ensure that its aircraft are equipped and its crews are qualified as required for the area and type of operation.
- (e) The operator shall ensure that all personnel assigned to, or directly involved in, ground and flight operations are properly instructed, have demonstrated their abilities in their particular duties and are aware of their responsibilities and the relationship of such duties to the operation as a whole.
- (f) The operator shall establish procedures and instructions for the safe operation of each aircraft type, containing ground staff and crew member duties and responsibilities, for all types of operation on the ground and in flight. Those procedures and instructions shall not require crew members to perform any activities during critical phases of flight other than those required for the safe operation of the aircraft. Procedures and instructions for a sterile flight crew compartment shall also be included.
- (g) The operator shall ensure that all personnel are made aware that they shall comply with the laws, regulations and procedures of those States in which operations are conducted and that are pertinent to the performance of their duties.
- (h) The operator shall establish a checklist for each aircraft type to be used by crew members in all phases of flight under normal, abnormal and emergency conditions in order to ensure that the operating procedures in the operations manual are followed. The design and the usage of checklists shall observe human factors principles and take into account the latest relevant documentation from the design approval holder.
- (i) The operator shall specify flight planning procedures to provide for the safe conduct of the flight based on considerations of aircraft performance, other operating limitations and relevant

expected conditions on the route to be followed and at the aerodromes or operating sites concerned. These procedures shall be included in the operations manual.

- (j) The operator shall establish and maintain dangerous goods training programmes for personnel as required by the technical instructions. Such training programmes shall be commensurate with the responsibilities of personnel. Training programmes of operators performing CAT, whether they transport dangerous goods or not, and of operators conducting operations other than CAT referred to in points (b), (c) and (d) of point [ORO.GEN.005](#) that transport dangerous goods shall be subject to review and approval by the competent authority.
- (k) Notwithstanding point (j), operators conducting commercial operations with either of the following aircraft shall ensure that the flight crew has received an appropriate dangerous goods training or briefing, to enable them to recognise undeclared dangerous goods brought on board by passengers or as cargo:
 - (1) a single-engined propeller-driven aeroplane having an MCTOM of 5 700 kg or less and a MOPSC of 5 or less, operated in a flight taking off and landing at the same aerodrome or operating site, under VFR by day;
 - (2) an other-than-complex motor-powered helicopter, single-engined, with an MOPSC of 5 or less, operated in a flight taking off and landing at the same aerodrome or operating site, under VFR by day.

AMC1 ORO.GEN.110(a) Operator responsibilities

ED Decision 2015/005/R

SECURITY TRAINING PROGRAMME FOR CREW MEMBERS — CAT OPERATIONS

Without prejudice to Regulation (EC) No 300/2008, the CAT operator should establish and maintain a security training programme for crew members, including theoretical and practical elements. This training should be provided at the time of operator conversion training and thereafter at intervals not exceeding three years. The content and duration of the training should be adapted to the security threats of the individual operator and should ensure that crew members act in the most appropriate manner to minimise the consequences of acts of unlawful interference. This programme should include the following elements:

- (a) determination of the seriousness of the occurrence;
- (b) crew communication and coordination;
- (c) appropriate self-defence responses;
- (d) use of non-lethal protective devices assigned to crew members whose use is authorised by the Member State;
- (e) understanding of behaviour of terrorists so as to facilitate the ability of crew members to cope with hijacker behaviour and passenger responses;
- (f) in case where cabin crew are required, live situational training exercises regarding various threat conditions;
- (g) flight crew compartment procedures to protect the aircraft;
- (h) aircraft search procedures, in accordance with Regulation (EC) No 300/2008, including identification of prohibited articles; and
- (i) guidance on the least risk bomb locations.

AMC2 ORO.GEN.110(a) Operator responsibilities

ED Decision 2015/005/R

SECURITY TRAINING PROGRAMME FOR GROUND PERSONNEL — CAT OPERATIONS

In accordance with Regulation (EC) No 300/2008, the CAT operator should establish and maintain a security training programme for ground personnel to acquaint appropriate employees with preventive measures and techniques in relation to passengers, baggage, cargo, mail, equipment, stores and supplies intended for carriage so that they contribute to the prevention of acts of sabotage or other forms of unlawful interference.

GM1 ORO.GEN.110(a) Operator responsibilities

ED Decision 2015/005/R

SECURITY TRAINING PROGRAMME FOR CREW MEMBERS

ICAO Security Manual Doc 9811 (restricted access) contains guidance on the development of training programmes.

AMC1 ORO.GEN.110(c) Operator responsibilities

ED Decision 2014/017/R

OPERATIONAL CONTROL

The organisation and methods established to exercise operational control should be included in the operations manual and should cover at least a description of responsibilities concerning the initiation, continuation and termination or diversion of each flight.

GM1 ORO.GEN.110(c) Operator responsibilities

ED Decision 2022/005/R

OPERATIONAL CONTROL

- (a) Point [ORO.GEN.110\(c\)](#) does not imply a requirement for licensed flight operations officers/flight dispatchers.
- (b) If the operator uses flight operations officers (FOOs)/flight dispatchers (FDs) in conjunction with a method of operational control, training for that personnel should be based on the relevant parts of ICAO Annex 1 and ICAO Documents 10106 and 9868. This training should be described in the OM.

AMC1 ORO.GEN.110(c)&(e) Operator responsibilities

ED Decision 2022/005/R

PERSONNEL RESPONSIBILITIES — OPERATIONAL CONTROL PERSONNEL THAT PERFORM TASKS RELATED TO FLIGHT MONITORING AND FLIGHT WATCH — TRAINING PROGRAMME

- (a) When a CAT operator uses flight monitoring or flight watch as functions of a system for exercising operational control, FOOs/FDs should perform those functions.
- (b) The CAT operator should develop a training programme, based on the relevant parts of ICAO Annex 1, ICAO Documents 10106 and 9868, for FOOs/FDs that perform those functions.
- (c) The training programme specified above should be detailed in the OM of the CAT operator and should be delivered by an instructor for operational control personnel.

INITIAL TRAINING

- (d) The initial training should include, where relevant to the intended operation, the following elements that should be tailored to the specific duties assigned to each person:
- (1) air law:
 - rules and regulations relevant to the task assignment, appropriate ATS practices and procedures;
 - (2) aircraft general knowledge:
 - (i) principles of operation of aeroplane engines/systems/instruments;
 - (ii) operating limitations of aeroplanes and engines; and
 - (iii) MEL and configuration deviation list (CDL);
 - (3) flight performance calculation, planning procedures, and loading:
 - (i) effects of loading and mass distribution on aircraft performance and flight characteristics; mass and balance calculations;
 - (ii) operational flight planning; fuel consumption and endurance calculations; alternate aerodrome selection procedures; en-route cruising control; extended range operation;
 - (iii) preparation and filing of ATS flight plans; and
 - (iv) basic principles of computer-assisted planning systems;
 - (4) human performance:

human performance related to operational control duties, including principles of threat and error management (TEM); guidance material on how to design training programmes on human performance, including on TEM, is provided in ICAO Doc 9683 Human Factors Training Manual;
 - (5) meteorology:
 - (A) aeronautical meteorology; movement of pressure systems; structure of fronts; origin and characteristics of significant weather phenomena that affect take-off, en-route, and landing conditions;
 - (B) interpretation and application of aeronautical meteorological reports, charts, and forecasts; codes and abbreviations; use of, and procedures for, obtaining meteorological information;
 - (C) effects of meteorological conditions on aircraft operation and on radio reception in the aircraft that is used by the operator; and
 - (D) all-weather operations;
 - (6) navigation:
 - (A) principles of air navigation with particular reference to IFR; and
 - (B) navigation and radio equipment in the aircraft that is used by the operator;

- (7) operational procedures:
 - (A) use of aeronautical documentation and SOPs;
 - (B) procedures for operations beyond 60 minutes from an adequate aerodrome, including, if applicable, extended-diversion-time operations (EDTOs);
 - (C) operational procedures for the carriage of cargo and dangerous goods;
 - (D) de-icing/anti-icing;
 - (E) procedures related to aircraft accidents and incidents; emergency flight procedures; and
 - (F) security procedures related to unlawful interference and sabotage of aircraft;
- (8) principles of flight:

principles of flight related to the appropriate category of aircraft;
- (9) radio communications:

procedures for communicating with other aircraft and ground stations; and
- (10) special aerodromes.

OPERATOR-SPECIFIC TRAINING

- (e) In addition to the initial training, FOOs/FDs should receive training in the specific duties, responsibilities, and tools that are associated with the operational control system of the operator.

RECURRENT TRAINING

- (f) When the recurrent training is conducted within the last 12 months of a 36-month validity period, the next 36-month validity period should be calculated from the original expiry date of the previous assessment.
- (g) Notwithstanding the 36-month interval of point (f), recurrent training may also be performed at shorter intervals and adjusted to the needs identified after an assessment of the training needs conducted by the operator.

KNOWLEDGE, SKILLS, AND QUALIFICATIONS FOR INSTRUCTORS OF OPERATIONAL CONTROL PERSONNEL

- (h) Unless otherwise required by the relevant national regulations, instructors for operational control personnel should:
 - (1) be able to prove that they are current in the subjects covered by the training programme for FOOs/FDs, including the operator-specific elements, or otherwise successfully complete an FOO/FD training programme;
 - (2) have adequate instructional skills or attend instructor training; if more than 24 months have passed since the delivery of the last FOO/FD course, they should attend recurrent instructor training before delivering the next course; and
 - (3) have relevant work experience in the areas of the training that they provide.
- (i) The CAT operator should include in the OM the required knowledge, skills, and qualifications of the instructors for operational control personnel.

AMC1 ORO.GEN.110(e) Operator responsibilities

ED Decision 2017/007/R

MEL TRAINING PROGRAMME

- (a) The operator should develop a training programme for ground personnel dealing with the use of the MEL and detail such training in the continuing airworthiness maintenance exposition CAME and OM as appropriate. Such training programme should include:
- (1) the scope, extent and use of the MEL;
 - (2) placarding of inoperative equipment;
 - (3) deferral procedures;
 - (4) dispatching; and
 - (5) any other operator's MEL related procedures.
- (b) The operator should develop a training programme for crew members and detail such training in the Operations Manual. Such training programme should include:
- (1) the scope, extent and use of the MEL;
 - (2) the operator's MEL procedures;
 - (3) elementary maintenance procedures in accordance with Commission Regulation (EU) No 1321/2014; and
 - (4) pilot-in-command/commander responsibilities.

AMC2 ORO.GEN.110(e) Operator responsibilities

ED Decision 2015/005/R

GROUND OPERATIONS WITH PASSENGERS ON BOARD IN THE ABSENCE OF FLIGHT CREW

For ground operations, whenever passengers are embarking, on board or disembarking in the absence of flight crew members, the operator should:

- (a) establish procedures to alert the aerodrome services in the event of ground emergency or urgent need; and
- (b) ensure that at least one person on board the aircraft is qualified to apply these procedures and ensure proper coordination between the aircraft and the aerodrome services.

GM1 ORO.GEN.110(e) Operator responsibilities

ED Decision 2014/017/R

GROUND PERSONNEL

For the purpose of the MEL training programme referred to in [AMC1 ORO.GEN.110\(e\)](#) ground personnel include maintenance personnel, flight dispatchers and operations officers.

GM2 ORO.GEN.110(e) Operator responsibilities

ED Decision 2015/005/R

AERODROME SERVICES

Aerodrome services refer to units available at an aerodrome that could be of assistance in responding to an urgent need or an emergency, such as rescue and firefighting services, medical and ambulance services, air traffic services, security services, police, aerodrome operations, air operators.

AMC1 ORO.GEN.110(f) Operator responsibilities

ED Decision 2015/005/R

STERILE FLIGHT CREW COMPARTMENT

- (a) Sterile flight crew compartment procedures should ensure that:
 - (1) flight crew activities are restricted to essential operational activities; and
 - (2) cabin crew and technical crew communications to flight crew or entry into the flight crew compartment are restricted to safety or security matters.
- (b) The sterile flight crew compartment procedures should be applied:
 - (1) during critical phases of flight;
 - (2) during taxiing (aeroplanes);
 - (3) below 10 000 feet above the aerodrome of departure after take-off and the aerodrome of destination before landing, except for cruise flight; and
 - (4) during any other phases of flight as determined by the pilot-in-command or commander.
- (c) All crew members should be trained on sterile flight crew compartment procedures established by the operator, as appropriate to their duties.

AMC2 ORO.GEN.110(f) Operator responsibilities

ED Decision 2022/005/R

INSTRUCTIONS ABOUT DUTIES AND RESPONSIBILITIES OF PERSONNEL — BRIEFING OF FLIGHT OPERATIONS OFFICERS/FLIGHT DISPATCHERS BEFORE ASSUMING DUTIES

In the context of an ongoing flight-following, flight-monitoring, or flight-watch activity, an FOO/FD, before assuming duties, should be briefed on the elements related to the safety of the operations the FOO/FD will be performing as part of the operational control.

GM1 ORO.GEN.110(f) Operator responsibilities

ED Decision 2015/005/R

STERILE FLIGHT CREW COMPARTMENT

- (a) Establishment of procedures

The operator should establish procedures for flight, cabin, and technical crew that emphasise the objectives and importance of the sterile flight crew compartment. These procedures should also emphasise that, during periods of time when the sterile flight deck compartment procedures are applied, cabin crew and technical crew members should call the flight crew or enter the flight crew compartment only in cases related to safety or security matters. In such cases, information should be timely and accurate.

(b) Flight crew activities

When sterile flight crew compartment procedures are applied, flight crew members are focused on their essential operational activities without being disturbed by non-safety related matters. Examples of activities that should not be performed are:

- (1) radio calls concerning passenger connections, fuel loads, catering, etc.;
- (2) non-critical paperwork; and
- (3) mass and balance corrections and performance calculations, unless required for safety reasons.

(c) Communication to the flight crew

Cabin crew and technical crew use their own discretion to determine whether the situation is related to safety or security matters and whether to call the flight crew. Situations requiring information to the flight crew may include:

- (1) any outbreak of fire inside the cabin or in an engine;
- (2) a burning smell in the cabin or presence of smoke inside or outside;
- (3) fuel or fluid leakage;
- (4) exit door unable to be armed or disarmed;
- (5) localised extreme cabin temperature changes;
- (6) evidence of airframe icing;
- (7) cabin/galley equipment or furniture malfunction/breakage posing a hazard to the occupants;
- (8) suspicious object;
- (9) disruptive passenger;
- (10) security threat;
- (11) abnormal vibration or noise;
- (12) medical emergency;
- (13) general drop-down of the oxygen masks in the cabin; and
- (14) any other condition deemed relevant by a cabin crew or technical crew member.

GM2 ORO.GEN.110(f) Operator responsibilities*ED Decision 2022/014/R***ELEMENTS OF THE BRIEFING GIVEN TO FLIGHT OPERATIONS OFFICERS/FLIGHT DISPATCHERS BEFORE ASSUMING DUTIES**

Before commencing their shift, the FOO/FD should be briefed on relevant safety information such as:

- (a) weather charts;
- (b) weather reports;
- (c) NOTAMs;
- (d) operational restrictions in force;

- (e) flights in the air and flights for which operational flight plans have been issued but which have not yet started and for which the FOO/FD will be responsible;
- (f) the forecast flight schedule; and
- (g) other relevant safety information as listed in [GM28 Annex I 'Definitions for terms used in Annexes II to VIII'](#).

AMC1 ORO.GEN.110(f)(h) Operator responsibilities

ED Decision 2019/019/R

ESTABLISHMENT OF PROCEDURES

- (a) An operator should establish procedures to be followed by cabin crew covering at least:
 - (1) arming and disarming of slides;
 - (2) operation of cabin lights, including emergency lighting;
 - (3) prevention and detection of cabin, galley and toilet fires;
 - (4) actions to be taken when turbulence is encountered;
 - (5) actions to be taken in the event of an emergency and/or an evacuation; and
 - (6) safety aspects of the in-flight entertainment (IFE) system, if installed.
- (b) When establishing procedures and a checklist system for cabin crew with respect to the aircraft cabin, the operator should take into account at least the following duties:

Duties	Pre-take off	In-flight	Pre-landing	Post-landing
(1) Briefing of cabin crew by the senior cabin crew member prior to commencement of a flight or series of flights	x			
(2) Check of safety and emergency equipment in accordance with operator's policies and procedures	x			
(3) Security checks as applicable	x			x
(4) Passenger embarkation and disembarkation	x			x
(5) Securing of passenger cabin (e.g. seat belts, cabin cargo/baggage, IFE system)	x		x	
(6) Securing of galleys and stowage of equipment	x	if required	x	
(7) Arming of door/exit slides	x			
(8) Safety briefing/information to passengers	x	x	x	x
(9) 'Cabin secure' report to flight crew	x	if required	x	
(10) Operation of cabin lights	x	if required	x	x
(11) Safety aspects of the IFE system (if installed)	x	x	x	x
(12) Cabin crew at assigned crew stations	x	if required	x	x
(13) Surveillance of passenger cabin	x	x	x	x

Duties	Pre-take off	In-flight	Pre-landing	Post-landing
(14) Prevention and detection of fire in the cabin (including the combi-cargo area, crew rest areas, galleys, lavatories and any other cabin remote areas) and instructions for actions to be taken	x	x	x	x
(15) Actions to be taken when turbulence is encountered		x		
(16) Actions to be taken in case of in-flight incidents (e.g. medical emergency)		x		
(17) Actions to be taken in the event of emergency situations	x	x	x	x
(18) Disarming of door/exit slides				x
(19) Reporting of any deficiency and/or un-serviceability of equipment and/or any incident	x	x	x	x

- (c) The operator should specify the contents of safety briefings for all cabin crew members prior to the commencement of a flight or series of flights.

ORO.GEN.115 Application for an AOC

Regulation (EU) No 379/2014

- (a) The application for an air operator certificate or an amendment to an existing certificate shall be made in a form and manner established by the competent authority, taking into account the applicable requirements of Regulation (EC) No 216/2008 and its Implementing Rules.
- (b) Applicants for an initial certificate shall provide the competent authority with documentation demonstrating how they will comply with the requirements established in Regulation (EC) No 216/2008 and its Implementing Rules. Such documentation shall include a procedure describing how changes not requiring prior approval will be managed and notified to the competent authority.

ORO.GEN.120 Means of compliance

Regulation (EU) No 379/2014

- (a) Alternative means of compliance to those adopted by the Agency may be used by an operator to establish compliance with Regulation (EC) No 216/2008 and its Implementing Rules.
- (b) When an operator subject to certification wishes to use an alternative means of compliance to the acceptable means of compliance (AMC) adopted by the Agency to establish compliance with Regulation (EC) No 216/2008 and its Implementing Rules, it shall, prior to implementing it, provide the competent authority with a full description of the alternative means of compliance. The description shall include any revisions to manuals or procedures that may be relevant, as well as an assessment demonstrating that the Implementing Rules are met.

The operator may implement these alternative means of compliance subject to prior approval by the competent authority and upon receipt of the notification as prescribed in [ARO.GEN.120\(d\)](#).

- (c) An operator required to declare its activity shall notify to the competent authority the list of alternative means of compliance it uses to establish compliance with Regulation (EC) No 216/2008 and its Implementing Rules.
- (d) When an operator subject to SPO authorisation wishes to use alternative means of compliance, it shall comply with (b) whenever such alternative means of compliance affects the standard operating procedures that are part of the authorisation and with (c) for the declared part of its organisation and operation.

AMC1 ORO.GEN.120(a) Means of compliance

ED Decision 2014/017/R

DEMONSTRATION OF COMPLIANCE

In order to demonstrate that the Implementing Rules are met, a risk assessment should be completed and documented. The result of this risk assessment should demonstrate that an equivalent level of safety to that established by the Acceptable Means of Compliance (AMC) adopted by the Agency is reached.

ORO.GEN.125 Terms of approval and privileges of an AOC holder

Regulation (EU) No 379/2014

A certified operator shall comply with the scope and privileges defined in the operations specifications attached to the operator's certificate.

AMC1 ORO.GEN.125 Terms of approval and privileges of an AOC holder

ED Decision 2014/017/R

MANAGEMENT SYSTEM DOCUMENTATION

The management system documentation should contain the privileges and detailed scope of activities for which the operator is certified, as relevant to the applicable requirements. The scope of activities defined in the management system documentation should be consistent with the terms of approval.

ORO.GEN.130 Changes related to an AOC holder

Regulation (EU) No 379/2014

- (a) Any change affecting:
 - (1) the scope of the certificate or the operations specifications of an operator; or
 - (2) any of the elements of the operator's management system as required in [ORO.GEN.200\(a\)\(1\) and \(a\)\(2\)](#),shall require prior approval by the competent authority.
- (b) For any changes requiring prior approval in accordance with Regulation (EC) No 216/2008 and its Implementing Rules, the operator shall apply for and obtain an approval issued by the competent authority. The application shall be submitted before any such change takes place, in order to enable the competent authority to determine continued compliance with Regulation (EC) No 216/2008 and its Implementing Rules and to amend, if necessary, the operator certificate and related terms of approval attached to it.

The operator shall provide the competent authority with any relevant documentation.

The change shall only be implemented upon receipt of formal approval by the competent authority in accordance with [ARO.GEN.330](#).

The operator shall operate under the conditions prescribed by the competent authority during such changes, as applicable.

- (c) All changes not requiring prior approval shall be managed and notified to the competent authority as defined in the procedure approved by the competent authority in accordance with [ARO.GEN.310\(c\)](#).

AMC1 ORO.GEN.130 Changes related to an AOC holder

ED Decision 2019/019/R

APPLICATION TIME FRAMES

- (a) The application for the amendment of an air operator certificate (AOC) should be submitted at least 30 days before the date of the intended changes.
- (b) In the case of a planned change of a nominated person in accordance with [ORO.GEN.210\(b\)](#) or of a safety manager as defined under [AMC1 ORO.GEN.200\(a\)\(1\)](#), the operator should inform the competent authority at least 20 days before the date of the proposed change.
- (c) Unforeseen changes should be notified at the earliest opportunity, in order to enable the competent authority to determine continued compliance with the applicable requirements and to amend, if necessary, the AOC and related terms of approval.

GM1 ORO.GEN.130(a) Changes related to an AOC holder

ED Decision 2017/007/R

GENERAL

- (a) Typical examples of changes that may affect the AOC or the operations specifications or the operator's management system, as required in [ORO.GEN.200\(a\)\(1\)](#) and [\(a\)\(2\)](#), are listed below:
 - (1) the name of the operator;
 - (2) a change of legal entity;
 - (3) the operator's principal place of business;
 - (4) the operator's scope of activities;
 - (5) additional locations of the operator;
 - (6) the accountable manager referred to in [ORO.GEN.210\(a\)](#);
 - (7) reporting lines between the accountable manager and the nominated person;
 - (8) the operator's documentation, as required by this Annex, safety policy and procedures;
 - (9) the facilities.
- (b) Prior approval by the competent authority is required for any changes to the operator's procedure describing how changes not requiring prior approval will be managed and notified to the competent authority.
- (c) Changes requiring prior approval may only be implemented upon receipt of formal approval by the competent authority.

GM2 ORO.GEN.130(a) Changes related to an AOC holder

ED Decision 2014/017/R

CHANGE OF NAME

A change of name requires the operator to submit a new application as a matter of urgency.

Where this is the only change to report, the new application can be accompanied by a copy of the documentation previously submitted to the competent authority under the previous name, as a means of demonstrating how the operator complies with the applicable requirements.

AMC1 ORO.GEN.130(b) Changes related to an AOC holder

ED Decision 2017/007/R

MANAGEMENT OF CHANGES REQUIRING PRIOR APPROVAL

For changes requiring prior approval, the operators should conduct a safety risk assessment and provide it to the competent authority upon request.

GM1 ORO.GEN.130(b) Changes related to an AOC holder

ED Decision 2022/012/R

CHANGES REQUIRING PRIOR APPROVAL

The following GM is a non-exhaustive checklist of items that require prior approval by the competent authority as specified in the applicable Implementing Rules:

- (a) alternative means of compliance;
- (b) procedures regarding items to be notified to the competent authority;
- (c) cabin crew:
 - (1) conduct of the training, examination and checking required by Annex V (Part-CC) to [Commission Regulation \(EU\) No 1178/2011](#)¹ and issue of cabin crew attestations;
 - (2) procedures for cabin crew to operate on four aircraft types;
 - (3) training programmes, including syllabi;
- (d) leasing agreements;
- (e) procedure for the use of aircraft included in an AOC by other operators for NCC, NCO and specialised operations, as required by [ORO.GEN.310](#);
- (f) specific approvals in accordance with Annex V (Part-SPA);
- (g) dangerous goods training programmes;
- (h) flight crew:
 - (1) alternative training and qualification programmes (ATQPs);
 - (2) procedures for flight crew to operate on more than one type or variant;
 - (3) training and checking programmes, including syllabi and use of flight simulation training devices (FSTDs);

¹ Commission Regulation (EU) No 1178/2011 of 3 November 2011 laying down technical requirements and administrative procedures related to civil aviation aircrew pursuant to Regulation (EC) No 216/2008 of the European Parliament and of the Council (OJ L 311, 25.11.2011, p. 1).

- (i) fuel schemes and special refuelling or defuelling of aeroplanes;
- (j) helicopter operations:
 - (1) over a hostile environment located outside a congested area, unless the operator holds an approval to operate according to [Subpart J HELICOPTER EMERGENCY MEDICAL SERVICE OPERATIONS](#) of Annex V (Part-SPA);
 - (2) to/from a public interest site;
 - (3) without an assured safe forced landing capability; and
 - (4) during refuelling with rotors turning;
- (k) mass and balance: standard masses for load items other than standard masses for passengers and checked baggage;
- (l) minimum equipment list (MEL):
 - (1) MEL;
 - (2) operating other than in accordance with the MEL, but within the constraints of the master minimum equipment list (MMEL);
 - (3) rectification interval extension (RIE) procedures;
- (m) minimum flight altitudes:
 - (1) the method for establishing minimum flight altitudes;
 - (2) descent procedures to fly below specified minimum altitudes;
- (n) performance:
 - (1) increased bank angles at take-off (for performance class A aeroplanes);
 - (2) short landing operations (for performance class A and B aeroplanes);
 - (3) steep approach operations (for performance class A and B aeroplanes);
 - (4) reduced required landing distance operations (for performance class A and B aeroplanes);
- (o) isolated aerodrome: using an isolated aerodrome as destination aerodrome for operations with aeroplanes;
- (p) method used to establish aerodrome operating minima;
- (q) approach flight technique:
 - (1) all approaches not flown as stabilised approaches for a particular approach to a particular runway;
 - (2) non-precision approaches not flown with the continuous descent final approach (CDFA) technique for each particular approach/runway combination;
- (r) maximum distance from an adequate aerodrome for two-engined aeroplanes without an extended range operations with two-engined aeroplanes (ETOPS) approval:
 - (1) air operations with two-engined performance class A aeroplanes with a maximum operational passenger seating configuration (MOPSC) of 19 or less and a maximum take-off mass less than 45 360 kg, over a route that contains a point further than 120 minutes from an adequate aerodrome, under standard conditions in still air;

- (s) aircraft categories:
 - (1) Applying a lower landing mass than the maximum certified landing mass for determining the indicated airspeed at threshold (VAT).
- (t) commercial air transport operations with single-engined turbine aeroplanes in instrument meteorological conditions or at night (CAT SET-IMC).

ORO.GEN.135 Continued validity of an AOC

Regulation (EU) 2019/1384

- (a) The operator's certificate shall remain valid subject to all of the following:
 - (1) the operator remaining in compliance with the relevant requirements of Regulation (EU) 2018/1139 and its delegated and implementing acts, taking into account the provisions related to the handling of findings as specified under [ORO.GEN.150](#) of this Annex;
 - (2) the competent authority being granted access to the operator as defined in point [ORO.GEN.140](#) of this Annex to determine continued compliance with the relevant requirements of Regulation (EU) 2018/1139 and its delegated and implementing acts;
 - (3) the certificate not being surrendered or revoked.
- (b) Upon revocation or surrender the certificate shall be returned to the competent authority without delay.

ORO.GEN.140 Access

Regulation (EU) 2019/1384

- (a) For the purpose of determining compliance with the relevant requirements of Regulation (EU) 2018/1139 and its delegated and implementing acts, the operator shall grant access at any time to any facility, aircraft, document, records, data, procedures or any other material relevant to its activity subject to certification, SPO authorisation or declaration, whether it is contracted or not, to any person authorised by one of the following authorities:
 - (1) the competent authority defined in point [ORO.GEN.105](#) of Annex III to this Regulation;
 - (2) the authority acting under the provisions of points [ARO.GEN.300\(d\)](#), [ARO.GEN.300\(e\)](#) or Subpart ARO.RAMP of Annex II to this Regulation.
- (b) Access to the aircraft mentioned under (a) shall, in the case of CAT, include the possibility to enter and remain in the aircraft during flight operations unless otherwise decided by the commander for the flight crew compartment in accordance with [CAT.GEN.MPA.135](#) in the interest of safety.

ORO.GEN.150 Findings

Regulation (EU) No 965/2012

After receipt of notification of findings, the operator shall:

- (a) identify the root cause of the non-compliance;
- (b) define a corrective action plan; and
- (c) demonstrate corrective action implementation to the satisfaction of the competent authority within a period agreed with that authority as defined in [ARO.GEN.350\(d\)](#).

AMC1 ORO.GEN.150(b) Findings

ED Decision 2014/017/R

GENERAL

The corrective action plan defined by the operator should address the effects of the non-compliance, as well as its root cause.

GM1 ORO.GEN.150 Findings

ED Decision 2014/017/R

GENERAL

- (a) Preventive action is the action to eliminate the cause of a potential non-compliance or other undesirable potential situation.
- (b) Corrective action is the action to eliminate or mitigate the root cause(s) and prevent recurrence of an existing detected non-compliance or other undesirable condition or situation. Proper determination of the root cause is crucial for defining effective corrective actions to prevent reoccurrence.
- (c) Correction is the action to eliminate a detected non-compliance.

ORO.GEN.155 Immediate reaction to a safety problem

Regulation (EU) No 965/2012

The operator shall implement:

- (a) any safety measures mandated by the competent authority in accordance with [ARO.GEN.135\(c\)](#); and
- (b) any relevant mandatory safety information issued by the Agency, including airworthiness directives.

ORO.GEN.160 Occurrence reporting

Regulation (EU) 2019/1384

- (a) The operator shall report to the competent authority, and to any other organisation required to be informed by the State of the operator, any accident, serious incident and occurrence as defined in Regulation (EU) No 996/2010 of the European Parliament and of the Council¹ and Regulation (EU) No 376/2014.
- (b) Without prejudice to point (a) the operator shall report to the competent authority and to the organisation responsible for the design of the aircraft any incident, malfunction, technical defect, exceeding of technical limitations or occurrence that would highlight inaccurate, incomplete or ambiguous information contained in the operational suitability data established in accordance with Regulation (EU) No 748/2012 or other irregular circumstance that has or may have endangered the safe operation of the aircraft and that has not resulted in an accident or serious incident.
- (c) Without prejudice to Regulation (EU) No 996/2010 and Regulation (EU) No 376/2014, the reports referred in points (a) and (b) shall be made in a form and manner established by the

¹ Regulation (EU) No 996/2010 of the European Parliament and of the Council of 20 October 2010 on the investigation and prevention of accidents and incidents in civil aviation and repealing Directive 94/56/EC (OJ L 295, 12.11.2010, p. 35).

competent authority and shall contain all pertinent information about the conditions known to the operator.

- (d) Reports shall be made as soon as practicable, but in any case within 72 hours of the operator identifying the condition to which the report relates, unless exceptional circumstances prevent this.
- (e) Where relevant, the operator shall produce a follow-up report to provide details of actions it intends to take to prevent similar occurrences in the future, as soon as these actions have been identified. This report shall be produced in a form and manner established by the competent authority.

AMC1 ORO.GEN.160 Occurrence reporting

ED Decision 2019/019/R

GENERAL

- (a) The operator should report all occurrences defined in AMC 20-8, and as required by the applicable national rules implementing Regulation (EU) No 376/2014 on occurrence reporting in civil aviation.
- (b) In addition to the reports required by AMC 20-8 and Regulation (EU) No 376/2014, the operator should report volcanic ash clouds encountered during flight.

AMC2 ORO.GEN.160 Occurrence reporting

ED Decision 2016/019/R

REPORTABLE EVENTS OF PBN OPERATIONS

- (a) A reportable event should be an event that adversely affects the safety of the operation and may be caused by actions or events external to the functioning of the aircraft navigation system.
- (b) Technical defects and the exceedance of technical limitations, including:
 - (1) significant navigation errors attributed to incorrect data or a database coding error;
 - (2) unexpected deviations in lateral/vertical flight path not caused by flight crew input or erroneous operation of equipment;
 - (3) significant misleading information without a failure warning;
 - (4) total loss or multiple navigation equipment failure; and
 - (5) loss of integrity, e.g. RAIM function, whereas integrity was predicted to be available during preflight planning,should be considered a reportable event.
- (c) The operator should have in place a system for investigating a reportable event to determine if it is due to an improperly coded procedure or a navigation database error. The operator should initiate corrective actions for such an event.

AMC3 ORO.GEN.160 Occurrence reporting

ED Decision 2022/012/R

REPORTABLE EVENTS OF LVOs

- (a) A reportable event should include:
- (1) significant deviations from the flight path not caused by flight crew input;
 - (2) misleading information without flight deck alerts;
 - (3) loss of airborne navigation equipment functions necessary for the operation;
 - (4) loss of functions or facilities at the aerodrome necessary for the operation, including aerodrome operating procedures, ATC operation, navigation facilities, visual aids and electrical power supply;
 - (5) loss of other functions related to external infrastructure necessary for the operation; and
 - (6) any other event causing the approach or landing to be abandoned if occurring repeatedly.
- (b) The reports should be submitted to the aerodrome involved when relevant and in addition to the recipients prescribed in [ORO.GEN.160\(b\)](#).

GM1 ORO.GEN.160 Occurrence reporting

ED Decision 2022/012/R

REPORTABLE EVENTS OF LVOs — OTHER EVENTS OCCURRING REPEATEDLY

- (a) The purpose of point (a)(6) of [AMC3 ORO.GEN.160](#) is to share the information with aviation stakeholders other than the operator of the aircraft to identify yet unknown systematic safety-related issues. The main focus is thus on a series of similar events rather than an isolated single event.
- (b) Other events causing the approach or landing to be abandoned may include but are not limited to:
- (1) erroneous or inadequate flight crew action or aircraft handling; or
 - (2) meteorological phenomena or human-made disturbances (e.g. road crossing final approach in an EFVS approach, laser strikes, etc.) or emissions from infrastructures (e.g. 5G) which require flight crews to take corrective action to an extent to which the LVO cannot be terminated successfully or completed as planned, leading to a go-around, a balked landing or an unplanned manual intervention by the pilot during the landing manoeuvre.
- (c) Possible causes may be human-factor-related issues when employing newly introduced LVO equipment technologies or procedures or when changes take place in the runway environment or aerodrome vicinity.

SECTION 2 – MANAGEMENT

ORO.GEN.200 Management system

Regulation (EU) No 965/2012

- (a) The operator shall establish, implement and maintain a management system that includes:
- (1) clearly defined lines of responsibility and accountability throughout the operator, including a direct safety accountability of the accountable manager;
 - (2) a description of the overall philosophies and principles of the operator with regard to safety, referred to as the safety policy;
 - (3) the identification of aviation safety hazards entailed by the activities of the operator, their evaluation and the management of associated risks, including taking actions to mitigate the risk and verify their effectiveness;
 - (4) maintaining personnel trained and competent to perform their tasks;
 - (5) documentation of all management system key processes, including a process for making personnel aware of their responsibilities and the procedure for amending this documentation;
 - (6) a function to monitor compliance of the operator with the relevant requirements. Compliance monitoring shall include a feedback system of findings to the accountable manager to ensure effective implementation of corrective actions as necessary; and
 - (7) any additional requirements that are prescribed in the relevant Subparts of this Annex or other applicable Annexes.
- (b) The management system shall correspond to the size of the operator and the nature and complexity of its activities, taking into account the hazards and associated risks inherent in these activities.

AMC1 ORO.GEN.200(a)(1);(2);(3);(5) Management system

ED Decision 2017/007/R

NON-COMPLEX OPERATORS — GENERAL

- (a) Safety risk management may be performed using hazard checklists or similar risk management tools or processes, which are integrated into the activities of the operator.
- (b) The operator should manage safety risks related to a change. The management of change should be a documented process to identify external and internal change that may have an adverse effect on safety. It should make use of the operator's existing hazard identification, risk assessment and mitigation processes.
- (c) The operator should identify a person who fulfils the role of safety manager and who is responsible for coordinating the safety-management-related processes and tasks. This person may be the accountable manager or a person with an operational role within the operator.
- (d) Within the operator, responsibilities should be identified for hazard identification, risk assessment and mitigation.
- (e) The safety policy should include a commitment to improve towards the highest safety standards, comply with all applicable legal requirements, meet all applicable standards, consider best practices and provide appropriate resources.

- (f) The operator should, in cooperation with other stakeholders, develop, coordinate and maintain an emergency response plan (ERP) that ensures orderly and safe transition from normal to emergency operations and return to normal operations. The ERP should provide the actions to be taken by the operator or specified individuals in an emergency and reflect the size, nature and complexity of the activities performed by the operator.

AMC1 ORO.GEN.200(a)(1) Management system

ED Decision 2019/019/R

COMPLEX OPERATORS — ORGANISATION AND ACCOUNTABILITIES

The management system of an operator should encompass safety by including a safety manager and a safety review board in the organisational structure.

- (a) Safety manager
- (1) The safety manager should act as the focal point and be responsible for the development, administration and maintenance of an effective safety management system.
 - (2) The functions of the safety manager should be to:
 - (i) facilitate hazard identification, risk analysis and management;
 - (ii) monitor the implementation of actions taken to mitigate risks, as listed in the safety action plan;
 - (iii) provide periodic reports on safety performance;
 - (iv) ensure maintenance of safety management documentation;
 - (v) ensure that there is safety management training available and that it meets acceptable standards;
 - (vi) provide advice on safety matters; and
 - (vii) ensure initiation and follow-up of internal occurrence/accident investigations.
 - (3) If more than one person is designated for the safety management function, the accountable manager should identify the person who acts as the unique focal point (i.e. the 'safety manager').
- (b) Safety review board
- (1) The safety review board should be a high level committee that considers matters of strategic safety in support of the accountable manager's safety accountability.
 - (2) The board should be chaired by the accountable manager and be composed of heads of functional areas.
 - (3) The safety review board should monitor:
 - (i) safety performance against the safety policy and objectives;
 - (ii) that any safety action is taken in a timely manner; and
 - (iii) the effectiveness of the operator's safety management processes.
- (c) The safety review board should ensure that appropriate resources are allocated to achieve the established safety performance.

- (d) The safety manager or any other relevant person may attend, as appropriate, safety review board meetings. He/she may communicate to the accountable manager all information, as necessary, to allow decision making based on safety data.

GM1 ORO.GEN.200(a)(1) Management system

ED Decision 2019/019/R

SAFETY MANAGER

- (a) Depending on the size of the operator and the nature and complexity of its activities, the safety manager may be assisted by additional safety personnel for the performance of all safety management related tasks.
- (b) Regardless of the organisational set-up it is important that the safety manager remains the unique focal point as regards the development, administration and maintenance of the operator's safety management system.

COMPETENCIES OF THE SAFETY MANAGER

- (c) The safety manager as defined under [AMC1 ORO.GEN.200\(a\)\(1\)](#) is expected to support, facilitate and lead the implementation and maintenance of the safety management system, fostering an organisational culture for an effective safety management, risk management and occurrence reporting. The competencies for a safety manager should thus include, but not be limited to, the following:
- (1) Knowledge of:
 - (i) ICAO standards and European requirements and provisions on safety management;
 - (ii) basic safety investigation techniques; and
 - (iii) human factors in aviation.
 - (2) Relevant and documented work experience, preferably in a comparable position, in:
 - (i) management systems including compliance monitoring systems and safety management;
 - (ii) risk management; and
 - (iii) the operations of the organisation.
 - (3) Other suitable competencies
 - (i) the promotion of a positive safety culture;
 - (ii) interpersonal, influencing and leadership skills;
 - (iii) oral and written communication skills;
 - (iv) data management, analytical and problem-solving skills;
 - (v) professional integrity.

GM2 ORO.GEN.200(a)(1) Management system

ED Decision 2017/007/R

COMPLEX OPERATORS — SAFETY ACTION GROUP

- (a) A safety action group may be established as a standing group or as an ad-hoc group to assist or act on behalf of the safety review board.
- (b) More than one safety action group may be established depending on the scope of the task and specific expertise required.
- (c) The safety action group should report to and take strategic direction from the safety review board and should be comprised of managers, supervisors and personnel from operational areas.
- (d) The safety action group should:
 - (1) monitor operational safety;
 - (2) define actions to mitigate the identified safety risks;
 - (3) assess the impact on safety of operational changes; and
 - (4) ensure that safety actions are implemented within agreed timescales.
- (e) The safety action group should review the effectiveness of previous safety recommendations and safety promotion.

GM3 ORO.GEN.200(a)(1) Management system

ED Decision 2017/007/R

MEANING OF THE TERMS 'ACCOUNTABILITY' AND 'RESPONSIBILITY'

In the English language, the notion of accountability is different from the notion of responsibility. Whereas 'accountability' refers to an obligation which cannot be delegated, 'responsibility' refers to an obligation that can be delegated.

AMC1 ORO.GEN.200(a)(2) Management system

ED Decision 2014/017/R

COMPLEX OPERATORS — SAFETY POLICY

- (a) The safety policy should:
 - (1) be endorsed by the accountable manager;
 - (2) reflect organisational commitments regarding safety and its proactive and systematic management;
 - (3) be communicated, with visible endorsement, throughout the operator; and
 - (4) include safety reporting principles.
- (b) The safety policy should include a commitment:
 - (1) to improve towards the highest safety standards;
 - (2) to comply with all applicable legislation, meet all applicable standards and consider best practices;
 - (3) to provide appropriate resources;
 - (4) to enforce safety as one primary responsibility of all managers; and

- (5) not to blame someone for reporting something which would not have been otherwise detected.
- (c) Senior management should:
 - (1) continually promote the safety policy to all personnel and demonstrate their commitment to it;
 - (2) provide necessary human and financial resources for its implementation; and
 - (3) establish safety objectives and performance standards.

GM1 ORO.GEN.200(a)(2) Management system

ED Decision 2014/017/R

SAFETY POLICY

The safety policy is the means whereby the operator states its intention to maintain and, where practicable, improve safety levels in all its activities and to minimise its contribution to the risk of an aircraft accident as far as is reasonably practicable.

The safety policy should state that the purpose of safety reporting and internal investigations is to improve safety, not to apportion blame to individuals.

AMC1 ORO.GEN.200(a)(3) Management system

ED Decision 2014/017/R

COMPLEX OPERATORS — SAFETY RISK MANAGEMENT

- (a) Hazard identification processes
 - (1) Reactive and proactive schemes for hazard identification should be the formal means of collecting, recording, analysing, acting on and generating feedback about hazards and the associated risks that affect the safety of the operational activities of the operator.
 - (2) All reporting systems, including confidential reporting schemes, should include an effective feedback process.
- (b) Risk assessment and mitigation processes
 - (1) A formal risk management process should be developed and maintained that ensures analysis (in terms of likelihood and severity of occurrence), assessment (in terms of tolerability) and control (in terms of mitigation) of risks to an acceptable level.
 - (2) The levels of management who have the authority to make decisions regarding the tolerability of safety risks, in accordance with (b)(1), should be specified.
- (c) Internal safety investigation
 - (1) The scope of internal safety investigations should extend beyond the scope of occurrences required to be reported to the competent authority.
- (d) Safety performance monitoring and measurement
 - (1) Safety performance monitoring and measurement should be the process by which the safety performance of the operator is verified in comparison to the safety policy and objectives.

(2) This process should include:

- (i) safety reporting, addressing also the status of compliance with the applicable requirements;
- (ii) safety studies, that is, rather large analyses encompassing broad safety concerns;
- (iii) safety reviews including trends reviews, which would be conducted during introduction and deployment of new technologies, change or implementation of procedures, or in situations of structural change in operations;
- (iv) safety audits focussing on the integrity of the operator's management system, and periodically assessing the status of safety risk controls; and
- (v) safety surveys, examining particular elements or procedures of a specific operation, such as problem areas or bottlenecks in daily operations, perceptions and opinions of operational personnel and areas of dissent or confusion.

(e) The management of change

The operator should manage safety risks related to a change. The management of change should be a documented process to identify external and internal change that may have an adverse effect on safety. It should make use of the operator's existing hazard identification, risk assessment and mitigation processes.

(f) Continuous improvement

The operator should continuously seek to improve its safety performance. Continuous improvement should be achieved through:

- (1) proactive and reactive evaluations of facilities, equipment, documentation and procedures through safety audits and surveys;
- (2) proactive evaluation of individuals' performance to verify the fulfilment of their safety responsibilities; and
- (3) reactive evaluations in order to verify the effectiveness of the system for control and mitigation of risk.

(g) The emergency response plan (ERP)

- (1) An ERP should be established that provides the actions to be taken by the operator or specified individuals in an emergency. The ERP should reflect the size, nature and complexity of the activities performed by the operator.
- (2) The ERP should ensure:
 - (i) an orderly and safe transition from normal to emergency operations;
 - (ii) safe continuation of operations or return to normal operations as soon as practicable; and
 - (iii) coordination with the emergency response plans of other organisations, where appropriate.

GM1 ORO.GEN.200(a)(3) Management system

ED Decision 2017/007/R

INTERNAL SAFETY REPORTING SCHEME

- (a) The overall purpose of the internal safety reporting scheme is to use reported information to improve the level of the safety performance of the operator and not to attribute blame.
- (b) The objectives of the scheme are to:
 - (1) enable an assessment to be made of the safety implications of each relevant incident and accident, including previous similar occurrences, so that any necessary action can be initiated; and
 - (2) ensure that knowledge of relevant incidents and accidents is disseminated, so that other persons and operators may learn from them.
- (c) The scheme is an essential part of the overall monitoring function and it is complementary to the normal day-to-day procedures and 'control' systems and is not intended to duplicate or supersede any of them. The scheme is a tool to identify those instances where routine procedures have failed.
- (d) All occurrence reports judged reportable by the person submitting the report should be retained as the significance of such reports may only become obvious at a later date.

GM2 ORO.GEN.200(a)(3) Management system

ED Decision 2017/007/R

RISK MANAGEMENT OF FLIGHT OPERATIONS WITH KNOWN OR FORECAST VOLCANIC ASH CONTAMINATION

- (a) Responsibilities

The operator is responsible for the safety of its operations, including within an area with known or forecast volcanic ash contamination.

The operator should complete this assessment of safety risks related to known or forecast volcanic ash contamination as part of its management system before initiating operations into airspace forecast to be or aerodromes/operating sites known to be contaminated with volcanic ash.

This process is intended to ensure the operator takes account of the likely accuracy and quality of the information sources it uses in its management system and to demonstrate its own competence and capability to interpret data from different sources in order to achieve the necessary level of data integrity reliably and correctly resolve any conflicts among data sources that may arise.

In order to decide whether or not to operate into airspace forecast to be or aerodromes/operating sites known to be contaminated with volcanic ash, the operator should make use of the safety risk assessment within its management system, as required by [ORO.GEN.200](#).

The operator's safety risk assessment should take into account all relevant data including data from the type certificate holders (TCHs) regarding the susceptibility of the aircraft they operate to volcanic cloud-related airworthiness effects, the nature and severity of these effects and the related pre-flight, in-flight and post-flight precautions to be observed by the operator.

The operator should ensure that personnel required to be familiar with the details of the safety risk assessments receives all relevant information (both pre-flight and in-flight) in order to be in a position to apply appropriate mitigation measures as specified by the safety risk assessments.

(b) Procedures

The operator should have documented procedures for the management of operations into airspace forecast to be or aerodromes/operating sites known to be contaminated with volcanic ash.

These procedures should ensure that, at all times, flight operations remain within the accepted safety boundaries as established through the management system allowing for any variations in information sources, equipment, operational experience or organisation. Procedures should include those for flight crew, flight planners, dispatchers, operations, continuing airworthiness personnel such that they are in a position to evaluate correctly the risk of flights into airspace forecast to be contaminated by volcanic ash and to plan accordingly.

Continuing airworthiness personnel should be provided with procedures allowing them to correctly assess the need for and to execute relevant continuing airworthiness interventions.

The operator should retain sufficient qualified and competent staff to generate well supported operational risk management decisions and ensure that its staff are appropriately trained and current. It is recommended that the operator make the necessary arrangements for its relevant staff to take up opportunities to be involved in volcanic ash exercises conducted in their areas of operation.

(c) Volcanic activity information and operator's potential response

Before and during operations, information valuable to the operator is generated by various volcano agencies worldwide. The operator's risk assessment and mitigating actions need to take account of, and respond appropriately to, the information likely to be available during each phase of the eruptive sequence from pre-eruption through to end of eruptive activity. It is nevertheless noted that eruptions rarely follow a deterministic pattern of behaviour. A typical operator's response may consist of the following:

(1) Pre-eruption

The operator should have in place a robust mechanism for ensuring that it is constantly vigilant for any alerts of pre-eruption volcanic activity relevant to its operations. The staff involved need to understand the threat to safe operations that such alerts represent.

An operator whose routes traverse large, active volcanic areas for which immediate International Airways Volcano Watch (IAVW) alerts may not be available, should define its strategy for capturing information about increased volcanic activity before pre-eruption alerts are generated. For example, an operator may combine elevated activity information with information concerning the profile and history of the volcano to determine an operating policy, which could include re-routing or restrictions at night. This would be useful when dealing with the 60% of volcanoes which are unmonitored.

Such an operator should also ensure that its crews are aware that they may be the first to observe an eruption and so need to be vigilant and ready to ensure that this information is made available for wider dissemination as quickly as possible.

(2) Start of an eruption

Given the likely uncertainty regarding the status of the eruption during the early stages of an event and regarding the associated volcanic cloud, the operator's procedures

should include a requirement for crews to initiate re-routes to avoid the affected airspace.

The operator should ensure that flights are planned to remain clear of the affected areas and that consideration is given to available aerodromes/operating sites and fuel requirements.

It is expected that the following initial actions will be taken by the operator:

- (i) determine if any aircraft in flight could be affected, alert the crew and provide advice on re-routing and available aerodromes/operating sites as required;
 - (ii) alert management;
 - (iii) for flight departures, brief flight crew and revise flight and fuel planning in accordance with the safety risk assessment;
 - (iv) alert flight crew and operations staff to the need for increased monitoring of information (e.g. special air report (AIREP), volcanic activity report (VAR), significant weather information (SIGMET), NOTAMs and company messages);
 - (v) initiate the gathering of all data relevant to determining the risk; and
 - (vi) apply mitigations identified in the safety risk assessment.
- (3) On-going eruption

As the eruptive event develops, the operator can expect the responsible Volcanic Ash Advisory Centre (VAAC) to provide volcanic ash advisory messages (VAA/VAGs) defining, as accurately as possible, the vertical and horizontal extent of areas and layers of volcanic clouds. As a minimum, the operator should monitor, and take account of, this VAAC information as well as of relevant SIGMETs and NOTAMs.

Other sources of information are likely to be available such as VAR/AIREPs, satellite imagery and a range of other information from State and commercial organisations. The operator should plan its operations in accordance with its safety risk assessment taking into account the information that it considers accurate and relevant from these additional sources.

The operator should carefully consider and resolve differences or conflicts among the information sources, notably between published information and observations (pilot reports, airborne measurements, etc.).

Given the dynamic nature of the volcanic hazards, the operator should ensure that the situation is monitored closely and operations adjusted to suit changing conditions.

The operator should be aware that the affected or danger areas may be established and presented in a different way than the one currently used in Europe, as described in EUR Doc 019-NAT Doc 006.

The operator should require reports from its crews concerning any encounters with volcanic emissions. These reports should be passed immediately to the appropriate air traffic services (ATS) unit and to the operator's competent authority.

For the purpose of flight planning, the operator should treat the horizontal and vertical limits of the temporary danger area (TDA) or airspace forecast to be contaminated by volcanic ash as applicable, to be overflowed as it would mountainous terrain, modified in accordance with its safety risk assessment. The operator should take account of the risk of cabin depressurisation or engine failure resulting in the inability to maintain level flight

above a volcanic cloud, especially when conducting ETOPS operations. Additionally, minimum equipment list (MEL) provisions should be considered in consultation with the TCHs.

Flying below volcanic ash contaminated airspace should be considered on a case-by-case basis. It should only be planned to reach or leave an aerodrome/operating site close to the boundary of this airspace or where the ash contamination is very high and stable. The establishment of Minimum Sector Altitude (MSA) and the availability of aerodromes/operating sites should be considered.

(d) Safety risk assessment

When directed specifically at the issue of intended flight into airspace forecast to be or aerodromes/operating sites known to be contaminated with volcanic ash, the process should involve the following:

(1) Identifying the hazards

The generic hazard, in the context of this document, is airspace forecast to be or aerodromes/operating sites known to be contaminated with volcanic ash, and whose characteristics are harmful to the airworthiness and operation of the aircraft.

This GM is referring to volcanic ash contamination since it is the most significant hazard for flight operations in the context of a volcanic eruption. Nevertheless, it might not be the only hazard and therefore the operator should consider additional hazards which could have an adverse effect on aircraft structure or passengers safety such as gases.

Within this generic hazard, the operator should develop its own list of specific hazards taking into account its specific aircraft, experience, knowledge and type of operation, and any other relevant data stemming from previous eruptions.

(2) Considering the severity and consequences of the hazard occurring (i.e. the nature and actual level of damage expected to be inflicted on the particular aircraft from exposure to that volcanic ash cloud).

(3) Evaluating the likelihood of encountering volcanic ash clouds with characteristics harmful to the safe operation of the aircraft.

For each specific hazard within the generic hazard, the likelihood of adverse consequences should be assessed, either qualitatively or quantitatively.

(4) Determining whether the consequent risk is acceptable and within the operator's risk performance criteria.

At this stage of the process, the safety risks should be classified as acceptable or unacceptable. The assessment of tolerability will be subjective, based on qualitative data and expert judgement, until specific quantitative data are available in respect of a range of parameters.

(5) Taking action to reduce the safety risk to a level that is acceptable to the operator's management.

Appropriate mitigation for each unacceptable risk identified should then be considered in order to reduce the risk to a level acceptable to the operator's management.

(e) Procedures to be considered when identifying possible mitigations actions

When conducting a volcanic ash safety risk assessment, the operator should consider the following non-exhaustive list of procedures and processes as mitigation:

(1) Type certificate holders

Obtaining advice from the TCHs and other engineering sources concerning operations in potentially contaminated airspace and/or aerodromes/operating sites contaminated by volcanic ash.

This advice should set out:

- (i) the features of the aircraft that are susceptible to airworthiness effects related to volcanic ash;
- (ii) the nature and severity of these effects;
- (iii) the effect of volcanic ash on operations to/from contaminated aerodromes/operating sites, including the effect on take-off and landing aircraft performance;
- (iv) the related pre-flight, in-flight and post-flight precautions to be observed by the operator including any necessary amendments to aircraft operating manuals, aircraft maintenance manuals, master minimum equipment list/dispatch deviation or equivalents; and
- (v) the recommended inspections associated with operations in volcanic ash potentially contaminated airspace and operations to/from volcanic ash contaminated aerodromes/operating sites; this may take the form of instructions for continuing airworthiness or other advice.

(2) Operator/contracted organisations' personnel

Definition of procedures for flight planning, operations, engineering and maintenance ensuring that:

- (i) personnel responsible for flight planning are in a position to evaluate correctly the risk of encountering volcanic ash contaminated airspace, or aerodromes/operating sites, and can plan accordingly;
- (ii) flight planning and operational procedures enable crews to avoid areas and aerodromes/operating sites with unacceptable volcanic ash contamination;
- (iii) flight crew are aware of the possible signs of entry into a volcanic ash cloud and execute the associated procedures;
- (iv) continuing airworthiness personnel are able to assess the need for and to execute any necessary maintenance or other required interventions; and
- (v) crews are provided with appropriate aircraft performance data when operating to/from aerodromes/operating sites contaminated with volcanic ash.

(3) Provision of enhanced flight watch

This should ensure:

- (i) close and continuous monitoring of VAA, VAR/AIREP, SIGMET, NOTAM, ASHTAM and other relevant information, and information from crews, concerning the volcanic ash cloud hazard;
- (ii) access to plots of the affected areas from SIGMETs, NOTAMs and relevant company information for crews and personnel responsible for the management and the supervision of the flight operations; and

- (iii) communication of the latest information to crews and personnel responsible for the management and the supervision of the flight operations in a timely fashion.
- (4) Flight planning
 - Flexibility of the process to allow re-planning at short notice should conditions change.
- (5) Departure, destination and alternate aerodromes
 - For the airspace to be traversed, or the aerodromes/operating sites in use, parameters to evaluate and take account of:
 - (i) the probability of contamination;
 - (ii) any additional aircraft performance requirements;
 - (iii) required maintenance considerations;
 - (iv) fuel requirements for re-routeing and extended holding.
- (6) Routing policy
 - Parameters to evaluate and take account of:
 - (i) the shortest period in and over the forecast contaminated area;
 - (ii) the hazards associated with flying over the contaminated area;
 - (iii) drift down and emergency descent considerations;
 - (iv) the policy for flying below the contaminated airspace and the associated hazards.
- (7) Diversion policy
 - Parameters to evaluate and take account of:
 - (i) maximum allowed distance from a suitable aerodrome/operating site;
 - (ii) availability of aerodromes/operating sites outside the forecast contaminated area;
 - (iii) diversion policy after an volcanic ash encounter.
- (8) Minimum equipment list (MEL)
 - Additional provisions in the MEL for dispatching aircraft with unserviceabilities that might affect the following non-exhaustive list of systems:
 - (i) air conditioning packs;
 - (ii) engine bleeds;
 - (iii) pressurisation system;
 - (iv) electrical power distribution system;
 - (v) air data system;
 - (vi) standby instruments;
 - (vii) navigation systems;
 - (viii) de-icing systems;
 - (ix) engine-driven generators;
 - (x) auxiliary power unit (APU);
 - (xi) airborne collision avoidance system (ACAS);

- (xii) terrain awareness warning system (TAWS);
 - (xiii) autoland systems;
 - (xiv) provision of crew oxygen;
 - (xv) supplemental oxygen for passengers.
- (9) Standard operating procedures
- Crew training to ensure they are familiar with normal and abnormal operating procedures and particularly any changes regarding but not limited to:
- (i) pre-flight planning;
 - (ii) in-flight monitoring of volcanic ash cloud affected areas and avoidance procedures;
 - (iii) diversion;
 - (iv) communications with ATC;
 - (v) in-flight monitoring of engine and systems potentially affected by volcanic ash cloud contamination;
 - (vi) recognition and detection of volcanic ash clouds and reporting procedures;
 - (vii) in-flight indications of a volcanic ash cloud encounter;
 - (viii) procedures to be followed if a volcanic ash cloud is encountered;
 - (ix) unreliable or erroneous airspeed;
 - (x) non-normal procedures for engines and systems potentially affected by volcanic ash cloud contamination;
 - (xi) engine-out and engine relight;
 - (xii) escape routes; and
 - (xiii) operations to/from aerodromes/operating sites contaminated with volcanic ash.
- (10) Provision for aircraft technical log
- This should ensure:
- (i) systematic entry in the aircraft technical log related to any actual or suspected volcanic ash encounter whether in-flight or at an aerodrome/operating site; and
 - (ii) checking, prior to flight, of the completion of maintenance actions related to an entry in the aircraft technical log for a volcanic ash cloud encounter on a previous flight.
- (11) Incident reporting
- Crew requirements for:
- (i) reporting an airborne volcanic ash cloud encounter (VAR);
 - (ii) post-flight volcanic ash cloud reporting (VAR);
 - (iii) reporting non-encounters in airspace forecast to be contaminated; and
 - (iv) filing a mandatory occurrence report in accordance with [ORO.GEN.160](#).

(12) Continuing airworthiness procedures

Procedures when operating in or near areas of volcanic ash cloud contamination:

- (i) enhancement of vigilance during inspections and regular maintenance and appropriate adjustments to maintenance practices;
- (ii) definition of a follow-up procedure when a volcanic ash cloud encounter has been reported or suspected;
- (iii) thorough investigation for any sign of unusual or accelerated abrasions or corrosion or of volcanic ash accumulation;
- (iv) reporting to TCHs and the relevant authorities observations and experiences from operations in areas of volcanic ash cloud contamination;
- (v) completion of any additional maintenance recommended by the TCH or by the Competent Authority.

(f) Reporting

The operator should ensure that reports are immediately submitted to the nearest ATS unit using the VAR/AIREP procedures followed up by a more detailed VAR on landing together with, as applicable, a report, as defined in Commission Regulation (EU) No 996/2010 and Regulation (EU) No 376/2014, and an aircraft technical log entry for:

- (1) any incident related to volcanic clouds;
- (2) any observation of volcanic ash activity; and
- (3) any time that volcanic ash is not encountered in an area where it was forecast to be.

(g) References

Further guidance on volcanic ash safety risk assessment is given in ICAO Doc. 9974 (Flight safety and volcanic ash — Risk management of flight operations with known or forecast volcanic ash contamination).

GM3 ORO.GEN.200(a)(3) Management system

ED Decision 2014/017/R

SAFETY RISK ASSESSMENT — RISK REGISTER

The results of the assessment of the potential adverse consequences or outcome of each hazard may be recorded by the operator in a risk register, an example of which is provided below.

Hazard		Incident Sequence Description	Existing Controls	Outcome (Pre-Mitigation)			Additional Mitigation required	Outcome (Post-Mitigation)			Actions and Owners	Monitoring and Review Requirements
No.	Description			Severity	Likelihood	Risk		Severity	Likelihood	Risk		

GM4 ORO.GEN.200(a)(3) Management system

ED Decision 2017/007/R

COMPLEX ORGANISATIONS — SAFETY RISK MANAGEMENT — INTERFACES BETWEEN ORGANISATIONS

- (a) Hazard identification and risk assessment start with an identification of all parties involved in the arrangement, including independent experts and non-approved organisations. It extends to the overall control structure, assessing, in particular, the following elements across all subcontract levels and all parties within such arrangements:
- (1) coordination and interfaces between the different parties;
 - (2) applicable procedures;
 - (3) communication between all parties involved, including reporting and feedback channels;
 - (4) task allocation responsibilities and authorities; and
 - (5) qualifications and competency of key personnel.
- (b) Safety risk management focuses on the following aspects:
- (1) clear assignment of accountability and allocation of responsibilities;
 - (2) only one party is responsible for a specific aspect of the arrangement — no overlapping or conflicting responsibilities, in order to eliminate coordination errors;
 - (3) existence of clear reporting lines, both for occurrence reporting and progress reporting;
 - (4) possibility for staff to directly notify the operator of any hazard suggesting an obviously unacceptable safety risk as a result of the potential consequences of this hazard.

AMC1 ORO.GEN.200(a)(4) Management system

ED Decision 2014/017/R

TRAINING AND COMMUNICATION ON SAFETY

- (a) Training
- (1) All personnel should receive safety training as appropriate for their safety responsibilities.
 - (2) Adequate records of all safety training provided should be kept.
- (b) Communication
- (1) The operator should establish communication about safety matters that:
 - (i) ensures that all personnel are aware of the safety management activities as appropriate for their safety responsibilities;
 - (ii) conveys safety critical information, especially relating to assessed risks and analysed hazards;
 - (iii) explains why particular actions are taken; and
 - (iv) explains why safety procedures are introduced or changed.
 - (2) Regular meetings with personnel where information, actions and procedures are discussed may be used to communicate safety matters.

GM1 ORO.GEN.200(a)(4) Management system

ED Decision 2014/017/R

TRAINING AND COMMUNICATION ON SAFETY

The safety training programme may consist of self-instruction via the media (newsletters, flight safety magazines), classroom training, e-learning or similar training provided by training service providers.

AMC1 ORO.GEN.200(a)(5) Management system

ED Decision 2014/017/R

MANAGEMENT SYSTEM DOCUMENTATION — GENERAL

- (a) The operator's management system documentation should at least include the following information:
 - (1) a statement signed by the accountable manager to confirm that the operator will continuously work in accordance with the applicable requirements and the operator's documentation, as required by this Annex;
 - (2) the operator's scope of activities;
 - (3) the titles and names of persons referred to in [ORO.GEN.210\(a\) and \(b\)](#);
 - (4) an operator chart showing the lines of responsibility between the persons referred to in [ORO.GEN.210](#);
 - (5) a general description and location of the facilities referred to in [ORO.GEN.215](#);
 - (6) procedures specifying how the operator ensures compliance with the applicable requirements;
 - (7) the amendment procedure for the operator's management system documentation.
- (b) The operator's management system documentation may be included in a separate manual or in (one of) the manual(s), as required by the applicable subpart(s). A cross-reference should be included.

AMC2 ORO.GEN.200(a)(5) Management system

ED Decision 2014/017/R

COMPLEX OPERATORS — SAFETY MANAGEMENT MANUAL

- (a) The safety management manual (SMM) should be the key instrument for communicating the approach to safety for the whole of the operator. The SMM should document all aspects of safety management, including the safety policy, objectives, procedures and individual safety responsibilities.
- (b) The contents of the safety management manual should include all of the following:
 - (1) scope of the safety management system;
 - (2) safety policy and objectives;
 - (3) safety accountability of the accountable manager;
 - (4) safety responsibilities of key safety personnel;
 - (5) documentation control procedures;
 - (6) hazard identification and risk management schemes;

- (7) safety action planning;
 - (8) safety performance monitoring;
 - (9) incident investigation and reporting;
 - (10) emergency response planning;
 - (11) management of change (including organisational changes with regard to safety responsibilities);
 - (12) safety promotion.
- (c) The SMM may be contained in (one of) the manual(s) of the operator.

GM1 ORO.GEN.200(a)(5) Management system

ED Decision 2017/007/R

MANAGEMENT SYSTEM DOCUMENTATION — GENERAL

- (a) It is not required to duplicate information in several manuals. The information may be contained in any of the operator manuals (e.g. operations manual), which may also be combined.
- (b) The operator may also choose to document some of the information required to be documented in separate documents (e.g. procedures). In this case, it should ensure that manuals contain adequate references to any document kept separately. Any such documents are then to be considered an integral part of the operator's management system documentation.

AMC1 ORO.GEN.200(a)(6) Management system

ED Decision 2019/019/R

COMPLIANCE MONITORING — GENERAL

- (a) Compliance monitoring

The implementation and use of a compliance monitoring function should enable the operator to monitor compliance with the relevant requirements of this Annex and other applicable Annexes.

 - (1) The operator should specify the basic structure of the compliance monitoring function applicable to the activities conducted.
 - (2) The compliance monitoring function should be structured according to the size of the operator and the complexity of the activities to be monitored.
- (b) Organisations should monitor compliance with the procedures they have designed to ensure safe activities. In doing so, they should as a minimum, and where appropriate, monitor compliance with the following:
 - (1) privileges of the operator;
 - (2) manuals, logs, and records;
 - (3) training standards;
 - (4) management system procedures and manuals;
 - (5) activities of the organisation carried out under the supervision of the nominated persons in accordance with [ORO.GEN.210\(b\)](#); and

-
- (6) any outsourced activities in accordance with [ORO.GEN.205](#), for compliance with the contract.
- (c) Organisational set up
- (1) To ensure that the operator continues to meet the requirements of this Part and other applicable Parts, the accountable manager should designate a compliance monitoring manager. The role of the compliance monitoring manager is to ensure that the activities of the operator are monitored for compliance with the applicable regulatory requirements, and any additional requirements as established by the operator, and that these activities are carried out properly under the supervision of the relevant head of functional area.
 - (2) The compliance monitoring manager should be responsible for ensuring that the compliance monitoring programme is properly implemented, maintained and continually reviewed and improved.
 - (3) The compliance monitoring manager should:
 - (i) have direct access to the accountable manager;
 - (ii) not be one of the other persons referred to in [ORO.GEN.210\(b\)](#);
 - (iii) be able to demonstrate relevant knowledge, background and appropriate experience related to the activities of the operator, including knowledge and experience in compliance monitoring; and
 - (iv) have access to all parts of the operator, and as necessary, any contracted operator.
 - (4) In the case of a non-complex operator, this task may be exercised by the accountable manager provided he/she has demonstrated having the related competence as defined in (c)(3)(iii).
 - (5) In the case the same person acts as compliance monitoring manager and as safety manager, the accountable manager, with regards to his/her direct accountability for safety, should ensure that sufficient resources are allocated to both functions, taking into account the size of the operator and the nature and complexity of its activities.
 - (6) The independence of the compliance monitoring function should be established by ensuring that audits and inspections are carried out by personnel not responsible for the function, procedure or products being audited.
 - (7) If more than one person is designated for the compliance monitoring function, the accountable manager should identify the person who acts as the unique focal point (i.e. the 'compliance monitoring manager').
- (d) Compliance monitoring documentation
- (1) Relevant documentation should include the relevant part(s) of the operator's management system documentation.
 - (2) In addition, relevant documentation should also include the following:
 - (i) terminology;
 - (ii) specified activity standards;
 - (iii) a description of the operator;
 - (iv) the allocation of duties and responsibilities;

- (v) procedures to ensure regulatory compliance;
 - (vi) the compliance monitoring programme, reflecting:
 - (A) schedule of the monitoring programme;
 - (B) audit procedures including an audit plan that is implemented, maintained, and continually reviewed and improved;
 - (C) reporting procedures;
 - (D) follow-up and corrective action procedures; and
 - (E) recording system.
 - (vii) the training syllabus referred to in (e)(2);
 - (viii) document control.
- (e) Training
- (1) Correct and thorough training is essential to optimise compliance in every operator. In order to achieve significant outcome of such training, the operator should ensure that all personnel understand the objectives as laid down in the operator's management system documentation.
 - (2) Those responsible for managing the compliance monitoring function should receive training on this task. Such training should cover the requirements of compliance monitoring, manuals and procedures related to the task, audit techniques, reporting and recording.
 - (3) Time should be provided to train all personnel involved in compliance management and for briefing the remainder of the personnel.
 - (4) The allocation of time and resources should be governed by the volume and complexity of the activities concerned.

GM1 ORO.GEN.200(a)(6) Management system

ED Decision 2014/017/R

COMPLIANCE MONITORING — GENERAL

- (a) The organisational set-up of the compliance monitoring function should reflect the size of the operator and the nature and complexity of its activities. The compliance monitoring manager may perform all audits and inspections himself/herself or appoint one or more auditors by choosing personnel having the related competence as defined in [AMC1 ORO.GEN.200\(a\)\(6\)](#) point (c)(3)(iii), either from, within or outside the operator.
- (b) Regardless of the option chosen it must be ensured that the independence of the audit function is not affected, in particular in cases where those performing the audit or inspection are also responsible for other functions for the operator.
- (c) In case external personnel are used to perform compliance audits or inspections:
 - (1) any such audits or inspections are performed under the responsibility of the compliance monitoring manager; and
 - (2) the operator remains responsible to ensure that the external personnel has relevant knowledge, background and experience as appropriate to the activities being audited or inspected; including knowledge and experience in compliance monitoring.

- (d) The operator retains the ultimate responsibility for the effectiveness of the compliance monitoring function, in particular for the effective implementation and follow-up of all corrective actions.

GM2 ORO.GEN.200(a)(6) Management system

ED Decision 2014/017/R

COMPLEX OPERATORS — COMPLIANCE MONITORING PROGRAMME

- (a) Typical subject areas for compliance monitoring audits and inspections for operators should be, as applicable:
- (1) actual flight operations;
 - (2) ground de-icing/anti-icing;
 - (3) flight support services;
 - (4) load control;
 - (5) technical standards.
- (b) Operators should monitor compliance with the operational procedures they have designed to ensure safe operations, airworthy aircraft and the serviceability of both operational and safety equipment. In doing so, they should, where appropriate, additionally monitor the following:
- (1) operational procedures;
 - (2) flight safety procedures;
 - (3) operational control and supervision;
 - (4) aircraft performance;
 - (5) all weather operations;
 - (6) communications and navigational equipment and practices;
 - (7) mass, balance and aircraft loading;
 - (8) instruments and safety equipment;
 - (9) ground operations;
 - (10) flight and duty time limitations, rest requirements, and scheduling;
 - (11) aircraft maintenance/operations interface;
 - (12) use of the MEL;
 - (13) flight crew;
 - (14) cabin crew;
 - (15) dangerous goods;
 - (16) security.

GM3 ORO.GEN.200(a)(6) Management system

ED Decision 2014/017/R

NON-COMPLEX OPERATORS — COMPLIANCE MONITORING

- (a) Compliance monitoring audits and inspections may be documented on a ‘Compliance Monitoring Checklist’, and any findings recorded in a ‘Non-compliance Report’. The following documents may be used for this purpose.

COMPLIANCE MONITORING CHECKLIST			
Year:			
Subject	Date checked	Checked by	Comments/Non-compliance Report No.
Flight Operations			
Aircraft checklists checked for accuracy and validity			
Minimum five flight plans checked and verified for proper and correct information			
Flight planning facilities checked for updated manuals, documents and access to relevant flight information			
Incident reports evaluated and reported to the appropriate competent authority			
Ground Handling			
Contracts with ground handling organisations established and valid, if applicable			
Instructions regarding fuelling and de-icing issued, if applicable			
Instructions regarding dangerous goods issued and known by all relevant personnel, if applicable			
Mass & Balance			
Min. five load sheets checked and verified for proper and correct information, if applicable			
Aircraft fleet checked for valid weight check, if applicable			
Minimum one check per aircraft of correct loading and distribution, if applicable			
Training			
Training records updated and accurate			
All pilot licenses checked for currency, correct ratings and valid medical check			
All pilots received recurrent training			
Training facilities & Instructors approved			
All pilots received daily inspection (DI) training			
Documentation			
All issues of operations manual (OM) checked for correct amendment status			
AOC checked for validity and appropriate operations specifications, if applicable			

Aviation requirements applicable and updated			
Crew flight and duty time record updated, if applicable			
Flight documents record checked and updated			
Compliance monitoring records checked and updated			

— NON-COMPLIANCE REPORT — No:	
To Compliance Monitoring Manager	Reported by: _____ Date: _____
Category Flight Operations <input type="checkbox"/> Ground Handling <input type="checkbox"/> Mass & Balance <input type="checkbox"/> Training <input type="checkbox"/> Documentation <input type="checkbox"/> Other <input type="checkbox"/>	
Description: _____	Reference: _____
Level of finding: _____	
Root-cause of non-compliance: _____	
Suggested correction: _____	
Compliance Monitoring Manager: <input type="checkbox"/> Corrective action required <input type="checkbox"/> Corrective action not required	
Responsible Person: _____	Time limitation: _____
Corrective action: _____	Reference: _____
Signature Responsible Person: _____	Date: _____
Compliance Monitoring Manager <input type="checkbox"/> Correction and corrective action verified <input type="checkbox"/> Report Closed	
Signature Compliance Monitoring Manager: _____	Date: _____

GM4 ORO.GEN.200(a)(6) Management system

ED Decision 2014/017/R

AUDIT AND INSPECTION

- (a) 'Audit' means a systematic, independent and documented process for obtaining evidence and evaluating it objectively to determine the extent to which requirements are complied with.
- (b) 'Inspection' means an independent documented conformity evaluation by observation and judgement accompanied as appropriate by measurement, testing or gauging, in order to verify compliance with applicable requirements.

AMC1 ORO.GEN.200(b) Management system

ED Decision 2017/004/R

SIZE, NATURE AND COMPLEXITY OF THE ACTIVITY

- (a) An operator should be considered as complex when it has a workforce of more than 20 full time equivalents (FTEs) involved in the activity subject to Regulation (EC) No 216/2008¹ and its Implementing Rules.
- (b) Operators with up to 20 FTEs involved in the activity subject to Regulation (EC) No 216/2008² and its Implementing Rules may also be considered complex based on an assessment of the following factors:
 - (1) in terms of complexity, the extent and scope of contracted activities subject to the approval;
 - (2) in terms of risk criteria, the extent of the following:
 - (i) operations requiring a specific approval;
 - (ii) high-risk commercial specialised operations;
 - (iii) operations with different types of aircraft used; and
 - (iv) operations in challenging environment (offshore, mountainous area, etc.).

ORO.GEN.205 Contracted activities

Regulation (EU) 2019/1384

- (a) When contracting or purchasing any services or products as a part of its activities, the operator shall ensure all of the following:
 - (1) that the contracted or purchased services or products comply with the applicable requirements;
 - (2) that any aviation safety hazards associated with contracted or purchased services or products are considered by the operator's management system.
- (b) When the certified operator or the SPO authorisation holder contracts any part of its activity to an organisation that is not itself certified or authorised in accordance with this Part to carry out

¹ Regulation (EC) No 216/2008 of the European Parliament and of the Council of 20 February 2008 on common rules in the field of civil aviation and establishing a European Aviation Safety Agency, and repealing Council Directive 91/670/EEC, Regulation (EC) No 1592/2002 and Directive 2004/36/EC. OJ L 79, 19.3.2008, p. 1.

² Regulation (EC) No 216/2008 of the European Parliament and of the Council of 20 February 2008 on common rules in the field of civil aviation and establishing a European Aviation Safety Agency, and repealing Council Directive 91/670/EEC, Regulation (EC) No 1592/2002 and Directive 2004/36/EC. OJ L 79, 19.3.2008, p. 1.

such activity, the contracted organisation shall work under the approval of the operator. The contracting organisation shall ensure that the competent authority is given access to the contracted organisation, to determine continued compliance with the applicable requirements.

AMC1 ORO.GEN.205 Contracted activities

ED Decision 2014/017/R

RESPONSIBILITY WHEN CONTRACTING ACTIVITIES

- (a) The operator may decide to contract certain activities to external organisations.
- (b) A written agreement should exist between the operator and the contracted organisation clearly defining the contracted activities and the applicable requirements.
- (c) The contracted safety-related activities relevant to the agreement should be included in the operator's safety management and compliance monitoring programmes.
- (d) The operator should ensure that the contracted organisation has the necessary authorisation or approval when required, and commands the resources and competence to undertake the task.

AMC2 ORO.GEN.205 Contracted activities

ED Decision 2019/019/R

THIRD-PARTY PROVIDERS

- (a) The initial audit and/or the continuous monitoring of contracted organisations may be performed by a third-party provider on behalf of the operator when it is demonstrated that:
 - (1) a documented arrangement has been established with the third-party provider;
 - (2) the audit standards applied by the third-party provider address the scope of this Regulation in sufficient detail;
 - (3) the third-party provider uses an evaluation system, designed to assess the operational, management and control systems of the contracted organisation;
 - (4) the independence of the third-party provider, its evaluation system as well as the impartiality of the auditors is ensured;
 - (5) the auditors are appropriately qualified and have sufficient knowledge, experience and training, including on-the-job training, to perform their allocated tasks;
 - (6) audits are performed on-site;
 - (7) access to the relevant data and facilities is granted to the level of detail necessary to verify compliance with the applicable requirements;
 - (8) access to the full audit report is granted;
 - (9) procedures have been established for monitoring continuous compliance of the contracted organisation with the applicable requirements; and
 - (10) procedures have been established to notify the contracted organisation of any non-compliance with the applicable requirements, the corrective actions to be taken, the follow-up of these corrective actions, and closure of findings.

- (b) The use of a third-party provider for the initial audit or the monitoring of continuous compliance of the contracted organisation does not exempt the operator from its responsibility under the applicable requirements.
- (c) The operator should maintain a list of the contracted organisations monitored by the third-party provider. This list and the full audit report prepared by the third-party provider should be made available to the competent authority upon request.

GM1 ORO.GEN.205 Contracted activities

ED Decision 2014/017/R

CONTRACTING — GENERAL

- (a) Operators may decide to contract certain activities to external organisations for the provision of services related to areas such as:
 - (1) ground de-icing/anti-icing;
 - (2) ground handling;
 - (3) flight support (including performance calculations, flight planning, navigation database and dispatch);
 - (4) training; and
 - (5) manual preparation.
- (b) Contracted activities include all activities within the operator's scope of approval that are performed by another organisation either itself certified or authorised to carry out such activity or if not certified or authorised, working under the operator's approval.
- (c) The ultimate responsibility for the product or service provided by external organisations should always remain with the operator.

GM2 ORO.GEN.205 Contracted activities

ED Decision 2014/017/R

RESPONSIBILITY WHEN CONTRACTING ACTIVITIES

- (a) Regardless of the approval status of the contracted organisation, the contracting operator is responsible for ensuring that all contracted activities are subject to hazard identification and risk management, as required by [ORO.GEN.200\(a\)\(3\)](#), and to compliance monitoring, as required by ORO.GEN.200(a)(6).
- (b) When the contracted organisation is itself certified or authorised to carry out the contracted activities, the operator's compliance monitoring should at least check that the approval effectively covers the contracted activities and that it is still valid.

ORO.GEN.210 Personnel requirements

Regulation (EU) No 965/2012

- (a) The operator shall appoint an accountable manager, who has the authority for ensuring that all activities can be financed and carried out in accordance with the applicable requirements. The accountable manager shall be responsible for establishing and maintaining an effective management system.

- (b) A person or group of persons shall be nominated by the operator, with the responsibility of ensuring that the operator remains in compliance with the applicable requirements. Such person(s) shall be ultimately responsible to the accountable manager.
- (c) The operator shall have sufficient qualified personnel for the planned tasks and activities to be performed in accordance with the applicable requirements.
- (d) The operator shall maintain appropriate experience, qualification and training records to show compliance with point (c).
- (e) The operator shall ensure that all personnel are aware of the rules and procedures relevant to the exercise of their duties.

AMC1 ORO.GEN.210(a) Application for an air operator certificate

ED Decision 2017/007/R

INFORMATION ON THE ACCOUNTABLE MANAGER

As part of being granted an air operator certificate (AOC), the operator should provide the competent authority with the following detailed information regarding the accountable manager:

- (a) name of the accountable manager;
- (b) position within the organisation;
- (c) information on means to ensure that all activities can be financed and carried out;
- (d) qualification relevant to the position; and
- (e) work experience relevant to the position.

GM1 ORO.GEN.210(a) Personnel requirements

ED Decision 2017/007/R

FUNCTION OF THE ACCOUNTABLE MANAGER

- (a) The accountable manager should have the overall responsibility for running the organisation.
- (b) When the accountable manager is not the chief executive officer, the competent authority should be assured that the accountable manager has direct access to the chief executive officer and has the necessary air operations funding allocation.

ORO.GEN.215 Facility requirements

Regulation (EU) No 965/2012

The operator shall have facilities allowing the performance and management of all planned tasks and activities in accordance with the applicable requirements.

ORO.GEN.220 Record-keeping

Regulation (EU) No 965/2012

- (a) The operator shall establish a system of record-keeping that allows adequate storage and reliable traceability of all activities developed, covering in particular all the elements indicated in [ORO.GEN.200](#).
- (b) The format of the records shall be specified in the operator's procedures.
- (c) Records shall be stored in a manner that ensures protection from damage, alteration and theft.

AMC1 ORO.GEN.220(b) Record-keeping

ED Decision 2014/017/R

GENERAL

- (a) The record-keeping system should ensure that all records are accessible whenever needed within a reasonable time. These records should be organised in a way that ensures traceability and retrievability throughout the required retention period.
- (b) Records should be kept in paper form or in electronic format or a combination of both. Records stored on microfilm or optical disc format are also acceptable. The records should remain legible throughout the required retention period. The retention period starts when the record has been created or last amended.
- (c) Paper systems should use robust material which can withstand normal handling and filing. Computer systems should have at least one backup system which should be updated within 24 hours of any new entry. Computer systems should include safeguards against the ability of unauthorised personnel to alter the data.
- (d) All computer hardware used to ensure data backup should be stored in a different location from that containing the working data and in an environment that ensures they remain in good condition. When hardware or software changes take place, special care should be taken that all necessary data continues to be accessible at least through the full period specified in the relevant subpart. In the absence of such indication, all records should be kept for a minimum period of 5 years.

GM1 ORO.GEN.220(b) Record-keeping

ED Decision 2014/017/R

RECORDS

Microfilming or optical storage of records may be carried out at any time. The records should be as legible as the original record and remain so for the required retention period.

SECTION 3 – ADDITIONAL ORGANISATIONAL REQUIREMENTS

ORO.GEN.310 Use of aircraft listed on an AOC for non-commercial operations and specialised operations

Regulation (EU) 2019/1387

- (a) Aircraft listed on an operator's AOC may remain on the AOC if it is operated in any of the following situations:
 - (1) by the AOC holder itself, for specialised operations in accordance with Annex VIII (Part-SPO);
 - (2) by other operators, for non-commercial operations with motor-powered aircraft or for specialised operations performed in accordance with Annex VI (Part-NCC), Annex VII (Part-NCO) or Annex VIII (Part-SPO), provided that the aircraft is used for a continuous period not exceeding 30 days.
- (b) When the aircraft is used in accordance with point (a)(2), the AOC holder providing the aircraft and the operator using the aircraft shall establish a procedure:

- (1) clearly identifying which operator is responsible for the operational control of each flight and to describe how the operational control is transferred between them;
- (2) describing the handover procedure of the aircraft upon its return to the AOC holder.

That procedure shall be included in the operations manual of each operator or in a contract between the AOC holder and the operator using the aircraft in accordance with point (a)(2). The AOC holder shall establish a template of such contract. Point [ORO.GEN.220](#) shall apply to the record-keeping of those contracts.

The AOC holder and the operator using the aircraft in accordance with point (a)(2) shall ensure that the procedure is communicated to the relevant personnel.

- (c) The AOC holder shall submit to the competent authority the procedure referred to in point (b) for prior approval. The AOC holder shall agree with the competent authority on the means and on the frequency of providing it with information about transfers of operational control in accordance with point [ORO.GEN.130\(c\)](#).
- (d) The continuing airworthiness of the aircraft used in accordance with point (a) shall be managed by the organisation responsible for the continuing airworthiness of the aircraft included in the AOC, in accordance with Regulation (EU) No 1321/2014.
- (e) The AOC holder providing the aircraft in accordance with point (a) shall:
 - (1) indicate in its operations manual the registration marks of the provided aircraft and the type of operations conducted with those aircraft;
 - (2) remain informed at all times and keep record of each operator that holds the operational control of the aircraft at any given moment until the aircraft is returned to the AOC holder;
 - (3) ensure that its hazard identification, risk assessment and mitigation measures address all the operations conducted with those aircraft.
- (f) For operations under Annex VI (Part-NCC) and Annex VIII (Part-SPO), the operator using the aircraft in accordance with point (a) shall ensure all of the following:
 - (1) that every flight conducted under its operational control is recorded in the aircraft technical log system;
 - (2) that no changes to the aircraft systems or configuration are made;
 - (3) that any defect or technical malfunction occurring while the aircraft is under its operational control is reported to the organisation referred to in point (d);
 - (4) that the AOC holder receives a copy of any occurrence report related to the flights performed with the aircraft, completed in accordance with Regulation (EU) No 376/2014 and Commission Implementing Regulation (EU) 2015/1018¹.

¹ Commission Implementing Regulation (EU) 2015/1018 of 29 June 2015 laying down a list classifying occurrences in civil aviation to be mandatorily reported according to Regulation (EU) No 376/2014 of the European Parliament and of the Council (OJ L 163, 30.6.2015, p. 1).

GM1 ORO.GEN.310 Use of aircraft listed on an AOC for non-commercial operations and specialised operations

ED Decision 2019/019/R

EXAMPLES OF POSSIBLE SCENARIOS FOR THE USE OF AIRCRAFT LISTED ON AN AOC

'Aircraft listed on an AOC' means any aircraft included in the AOC certification process, to which the privileges of the AOC apply. The registration marks of these aircraft are indicated either in the operations specifications form or in the operations manual of the AOC holder.

The following examples provide possible scenarios with organisations and operators to which this rule applies:

- (a) The same AOC holder providing the aircraft, using the aircraft either:
 - (1) as a declared operator for SPO (commercial or non-commercial, including high-risk SPO) in accordance with Part-ORO and Part-SPO for operations with complex motor-powered aircraft. In such a case, the provisions of Part-SPO and Part-ORO apply. This implies that the operator submits a declaration for its SPO activities and applies for an authorisation if it performs high-risk SPO; or
 - (2) as a training organisation (approved training organisation (ATO) or declared training organisation (DTO)) for operations performed in accordance with Part-NCC or Part-NCO.
- (b) Another AOC holder:
 - (1) as a declared operator, using complex motor-powered aircraft for NCC operations in accordance with Part-ORO and Part-NCC or for SPO activities (commercial or non-commercial), including high-risk SPO in accordance with Part-ORO and Part-SPO;
 - (2) as a training organisation (ATO or DTO), using the aircraft for operations performed in accordance with Part-NCC or Part-NCO; or
 - (3) using other than complex motor-powered aircraft for NCO operations.
- (c) An NCC operator or a SPO operator, for operations performed in accordance with Part-ORO and Part-NCC or in accordance with Part-ORO and Part-SPO (commercial or non-commercial), including high-risk SPO.
- (d) An NCO operator or a SPO operator conducting non-commercial operations with other than complex motor-powered aircraft in accordance with Part-NCO.
- (e) A training organisation (ATO or DTO), commercial or non-commercial, conducting operations in accordance with Part-NCC or Part-NCO.

GM2 ORO.GEN.310 Use of aircraft listed on an AOC for non-commercial operations and specialised operations

ED Decision 2019/019/R

SPECIFIC APPROVALS

- (a) *Specific approvals (SPA) of the AOC holder using its aircraft for non-commercial operations and specialised operations*
 - (1) When the AOC holder performs operations in accordance with Part-NCC or Part-NCO, the SPA granted for the AOC extend over these operations, as in such cases the provisions of [ORO.AOC.125](#) apply.

- (2) When the AOC holder performs operations in accordance with Part-SPO, as a declared operator, either:
- (i) the SPA applicable to its SPO activities for the same aircraft are already granted within its AOC. In this case, the operator does not need to apply for them again; or
 - (ii) the SPA applicable to its SPO activities for the same aircraft are partially different from the SPA already granted within its AOC. In this case, the specific approval will cover all the different aspects involved in SPO operation or training of relevant personnel; or
 - (iii) the SPA are not granted within its AOC. In this case, the operator applies for the relevant SPA to its competent authority, in accordance with Part-SPA. This means that all the elements required for a SPA will be provided to the competent authority: evidence of the relevant airworthiness approval, specific equipment approval, operational procedures, and training programme specific for each of the SPA applied for.
- (b) *SPA of any other operator, regardless of whether it also holds an AOC, using the aircraft as a declared operator or as a(n) ATO/DTO*

The declared operator performing NCC operations or SPO or the ATO/DTO has to comply with Part-SPA and apply for the SPA required for the type of operation it intends to conduct with that aircraft.

MINIMUM EQUIPMENT LIST (MEL)

The operator that uses the aircraft listed on the AOC of another operator is still responsible for obtaining the approval of the MEL for its own operations, to cover all the aircraft that it operates.

GM1 ORO.GEN.310(a)(2) Use of aircraft listed on an AOC for non-commercial operations and specialised operations

ED Decision 2019/019/R

EXCEEDING 30 DAYS OF CONTINUOUS OPERATION

When the other operator uses or intends to use the aircraft without returning it to the AOC holder for a duration that exceeds 30 days, then the provisions of [ORO.GEN.310](#) no longer apply; instead, the provisions of [ORO.AOC.110](#) apply and the AOC holder has to remove that aircraft from its AOC.

AMC1 ORO.GEN.310(b);(e) Use of aircraft listed on an AOC for non-commercial operations and specialised operations

ED Decision 2019/019/R

RESPONSIBILITIES OF THE AOC HOLDER

- (a) The AOC holder providing the aircraft should include the following information in the respective parts of its operations manual:
- (1) how the relevant personnel are informed about which of the operators is responsible for the operational control of each flight;
 - (2) when possible, which of the aircraft are used by the AOC holder itself, when conducting operations as a different operator (SPO operator, ATO or DTO), or by other operators;

- (3) when possible, the name of the other operators using the aircraft for operations performed in accordance with [ORO.GEN.310](#);
 - (4) when possible, the frequency with which the aircraft is used by the other operators;
 - (5) the means of instructing the relevant personnel on the continuing airworthiness procedure covering the use of the aircraft by other operators; and
 - (6) a customised list of occurrences that the other operators have to report to the AOC holder when using the aircraft in accordance with [ORO.GEN.310](#). This list may be adjusted to fit the aircraft used by the other operators, as well as the type of operation for which it is used. The AOC holder should communicate this list to the other operators.
- (b) The AOC holder should ensure that the operations specifications form of the respective aircraft is not carried on board when that aircraft is used by other operators for their NCC, NCO or SPO operations.

GM1 ORO.GEN.310(d) Use of aircraft listed on an AOC for non-commercial operations and specialised operations

ED Decision 2019/019/R

CONTINUING AIRWORTHINESS MANAGEMENT

In accordance with Annex I (Part-M) and Annex Vb (Part-ML) to Regulation (EU) No 1321/2014, the management of the continuing airworthiness of the aircraft by the continuing airworthiness management organisation (CAMO) or the combined airworthiness organisation (CAO) of the AOC holder means that the other operator has established a written contract as per Appendix I to Part-M or Appendix I to Part-ML with this CAMO or CAO.

AMC1 ORO.GEN.310(b);(d);(f) Use of aircraft listed on an AOC for non-commercial operations and specialised operations

ED Decision 2019/019/R

RESPONSIBILITIES OF THE OTHER OPERATOR

The other operator using the aircraft listed on an AOC for operations under [ORO.GEN.310](#) should include the following elements in its procedure:

- (a) a description of the way in which the shifting of operational control is communicated, including how, when and to whom the information is communicated;
- (b) a description of the specific responsibilities resulting from having the operational control of the flight performed with the aircraft listed on the AOC;
- (c) a description of the means to ensure that the relevant personnel are instructed to:
 - (1) contact the organisation responsible for the management of continuing airworthiness of the aircraft of the AOC holder (CAMO or CAO) for any defect or technical malfunction which occurs before or during the operation.

The information about any defect or malfunction should be transmitted to the CAMO or CAO of the AOC holder before the aircraft is used for the next flight. The same information should be confirmed by the entries in the aircraft technical log system; and
 - (2) report any occurrence in accordance with the applicable rules and the internal procedures; and

- (d) a customised list of occurrences, as developed by the AOC holder, which the other operator should use when informing the AOC holder of any safety-relevant issue or event that occurred while the aircraft was under its operational control.

SUBPART AOC: AIR OPERATOR CERTIFICATION

ORO.AOC.100 Application for an air operator certificate

Regulation (EU) 2015/1329

- (a) Without prejudice to Regulation (EC) No 1008/2008 of the European Parliament and the Council¹, prior to commencing commercial air transport operations, the operator shall apply for and obtain an air operator certificate (AOC) issued by the competent authority.
- (b) The operator shall provide the following information to the competent authority:
- (1) the official name and business name, address, and mailing address of the applicant;
 - (2) a description of the proposed operation, including the type(s), and number of aircraft to be operated;
 - (3) a description of the management system, including organisational structure;
 - (4) the name of the accountable manager;
 - (5) the names of the nominated persons required by [ORO.AOC.135\(a\)](#) together with their qualifications and experience;
 - (6) a copy of the operations manual required by [ORO.MLR.100](#);
 - (7) a statement that all the documentation sent to the competent authority have been verified by the applicant and found in compliance with the applicable requirements.
- (c) Applicants shall demonstrate to the competent authority that:
- (1) they comply with all the requirements of annex IV to Regulation (EC) No 216/2008, this Annex (Part-ORO), Annex IV (Part-CAT) and Annex V (Part-SPA) to this Regulation and Annex I (Part 26) to Regulation (EU) 2015/640²;
 - (2) all aircraft operated have a certificate of airworthiness (CofA) in accordance with Regulation (EU) No 748/2012 or are dry-leased in accordance with [ORO.AOC.110\(d\)](#); and
 - (3) its organisation and management are suitable and properly matched to the scale and scope of the operation.

AMC1 ORO.AOC.100 Application for an AOC

ED Decision 2014/017/R

APPLICATION TIME FRAMES

The application for the initial issue of an AOC should be submitted at least 90 days before the intended start date of operation. The operations manual may be submitted later, but in any case not later than 60 days before the intended start date of operation.

¹ OJ L 293, 31.10.2008, p. 3.

² Commission Regulation (EU) 2015/640 of 23 April 2015 on additional airworthiness specifications for a given type of operations and amending Regulation (EU) No 965/2012 (OJ L 106, 24.4.2015, p. 18).

AMC1 ORO.AOC.100(a) Application for an air operator certificate

ED Decision 2015/005/R

OPERATOR SECURITY PROGRAMME

In accordance with Regulation (EC) No 300/2008, as part of granting the AOC, the CAT operator should provide the competent authority with the operator's security programme, including security training. The security programme should be adapted to the type and area of operation, as well as to the aircraft operated.

GM1 ORO.AOC.100(c) Application for an air operator certificate

ED Decision 2017/007/R

MEANING OF CERTIFICATE OF AIRWORTHINESS

A certificate of airworthiness means either a certificate of airworthiness issued in accordance with Part-21.B.326 or a restricted certificate of airworthiness issued in accordance with Part-21.B.327.

ORO.AOC.105 Operations specifications and privileges of an AOC holder

Regulation (EU) No 965/2012

The privileges of the operator, including those granted in accordance with Annex V (Part-SPA), shall be specified in the operations specifications of the certificate.

ORO.AOC.110 Leasing agreement

Regulation (EU) 2019/1384

Any lease-in

- (a) Without prejudice to Regulation (EC) No 1008/2008, any lease agreement concerning aircraft used by an operator certified in accordance with this Part shall be subject to prior approval by the competent authority.
- (b) The operator certified in accordance with this Part shall not lease-in aircraft included in the list of operators subject to operational restrictions, registered in a State of which all operators under its oversight are subject to an operating ban or from an operator that is subject to an operating ban pursuant to Regulation (EC) No 2111/2005.

Wet lease-in

- (c) The applicant for the approval of the wet lease-in of an aircraft from a third-country operator shall demonstrate to the competent authority all of the following:
 - (1) that the third country operator holds a valid AOC issued in accordance with Annex 6 to the Convention on International Civil Aviation;
 - (2) that the safety standards of the third country operator with regard to continuing airworthiness and air operations are equivalent to the applicable requirements established by Regulation (EU) No 1321/2014 and this Regulation;
 - (3) that the aircraft has a standard CofA issued in accordance with Annex 8 to the Convention on International Civil Aviation.

Dry lease-in

- (d) An applicant for the approval of the dry lease-in of an aircraft registered in a third country shall demonstrate to the competent authority that:
- (1) an operational need has been identified that cannot be satisfied through leasing an aircraft registered in the EU;
 - (2) the duration of the dry lease-in does not exceed seven months in any 12 consecutive month period;
 - (3) compliance with the applicable requirements of Regulation (EU) No 1321/2014 is ensured; and
 - (4) the aircraft is equipped in accordance with the EU regulations for Air Operations.

Dry lease-out

- (e) The operator certified in accordance with this Part intending to dry lease-out one of its aircraft shall apply for prior approval by the competent authority. The application shall be accompanied by copies of the intended lease agreement or description of the lease provisions, except financial arrangements, and all other relevant documentation.

Wet lease-out

- (f) Prior to the wet lease-out of an aircraft, the operator certified in accordance with this Part shall notify the competent authority.

AMC1 ORO.AOC.110 Leasing agreement

ED Decision 2019/019/R

GENERAL

- (a) The operator intending to lease-in an aircraft should provide the competent authority with the following information:
- (1) the aircraft type, registration markings and serial number, as soon as available;
 - (2) the name and address of the registered owner;
 - (3) a copy of the valid certificate of airworthiness;
 - (4) a copy of the lease agreement or description of the lease provisions, except financial arrangements; and
 - (5) duration of the lease.
- (b) In case of wet lease-in, a copy of the AOC of the third-country operator and the areas of operation.
- (c) The information mentioned above should be accompanied by a statement signed by the lessee that the parties to the lease agreement fully understand their respective responsibilities under the applicable regulations.

AMC1 ORO.AOC.110(c) Leasing agreement

ED Decision 2019/019/R

WET LEASE-IN AGREEMENT WITH A THIRD-COUNTRY OPERATOR

If the operator is not intending to apply EU safety requirements for air operations and continuing airworthiness when wet leasing-in an aircraft registered in a third country, it should demonstrate to the competent authority that the standards complied with are equivalent to the following requirements:

- (a) Annex IV (Part-CAT);
- (b) Part-ORO:
 - (1) [ORO.GEN.110](#) and Section 2 of Subpart GEN;
 - (2) ORO.MLR, excluding [ORO.MLR.105](#);
 - (3) ORO.FC;
 - (4) ORO.CC, excluding [ORO.CC.200](#) and [ORO.CC.210\(a\)](#);
 - (5) ORO.TC;
 - (6) ORO.FTL, including related CS-FTL; and
 - (7) ORO.SEC;
- (c) Annex V (Part-SPA), if applicable;
- (d) for continuing airworthiness management of the third-country operator, Part-M¹ Subpart-B, Subpart-C and Subpart-G, excluding M.A.707, and M.A.710;
- (e) for the maintenance organisation used by the third-country operator during the lease period: Part-145²;
- (f) retroactive airworthiness requirements in accordance with Part-26; and
- (g) the operator should provide the competent authority with a full description of the flight time limitation scheme(s), operating procedures and safety assessment demonstrating compliance with the safety objectives set out in points (b)(1)-(6).

AMC2 ORO.AOC.110(c) Leasing agreement

ED Decision 2014/017/R

WET LEASE-IN

The lessee should maintain a record of occasions when lessors are used, for inspection by the State that issued its AOC.

¹ Commission Regulation (EC) No 2042/2003 of 20 November 2003 on the continuing airworthiness of aircraft and aeronautical products, parts and appliances, and on the approval of organisations and personnel involved in these tasks (OJ L 315, 28.11.2003, p. 1). Regulation as last amended by Commission Regulation (EU) No 1149/2011 of 21 October 2011 (OJ L 298, 16.11.2011, p. 1).

² Commission Regulation (EC) No 2042/2003 of 20 November 2003 on the continuing airworthiness of aircraft and aeronautical products, parts and appliances, and on the approval of organisations and personnel involved in these tasks (OJ L 315, 28.11.2003, p. 1). Regulation as last amended by Commission Regulation (EU) No 1149/2011 of 21 October 2011 (OJ L 298, 16.11.2011, p. 1).

GM1 ORO.AOC.110(c) Leasing agreement

ED Decision 2019/019/R

SHORT-TERM WET LEASE-IN WITH A THIRD-COUNTRY OPERATOR

In anticipation of an operational need the operator may enter into a framework agreement with more than one third-country operator provided that these operators comply with [ORO.AOC.110\(c\)](#). These third-country operators should be placed in a list maintained by the lessee.

AMC1 ORO.AOC.110(f) Leasing agreement

ED Decision 2014/017/R

WET LEASE-OUT

When notifying the competent authority, the operator intending to wet lease-out an aircraft should provide the competent authority with the following information:

- (a) the aircraft type, registration markings and serial number;
- (b) the name and address of the lessee;
- (c) a copy of the lease agreement or description of the lease provisions, except financial arrangements; and
- (d) the duration of the lease agreement.

ORO.AOC.115 Code-share agreements

Regulation (EU) No 965/2012

- (a) Without prejudice to applicable EU safety requirements for third country operators and aircraft, an operator certified in accordance with this Part shall enter into a code-share agreement with a third country operator only after:
 - (1) having verified that the third country operator complies with the applicable ICAO standards; and
 - (2) having provided the competent authority with documented information enabling such authority to comply with [ARO.OPS.105](#).
- (b) When implementing the code-share agreement the operator shall monitor and regularly assess the ongoing compliance of the third country operator with the applicable ICAO standards.
- (c) The operator certified in accordance with this Part shall not sell and issue tickets for a flight operated by a third country operator when the third country operator is subject to an operating ban pursuant to Regulation (EC) No 2111/2005 or is failing to maintain compliance with the applicable ICAO standards.

AMC1 ORO.AOC.115(a)(1) Code share agreements

ED Decision 2014/017/R

INITIAL VERIFICATION OF COMPLIANCE

- (a) In order to verify the third country operator's compliance with the applicable ICAO standards, in particular ICAO Annexes 1, 2, 6, Part I and III, as applicable, 8 and 18, the EU operator should conduct an audit of the third country operator, including interviews of personnel and inspections carried out at the third country operator's facilities.
- (b) The audit should focus on the operational, management and control systems of the operator.

AMC1 ORO.AOC.115(b) Code-share arrangements

ED Decision 2014/017/R

CODE-SHARE AUDIT PROGRAMME

- (a) Operators should establish a code-share audit programme for monitoring continuous compliance of the third country operator with the applicable ICAO standards. Such a code-share audit programme should include:
- (1) the audit methodology (audit report + compliance statements);
 - (2) details of the specific operational areas to audit;
 - (3) criteria for defining satisfactory audit results;
 - (4) a system for reporting and correcting findings;
 - (5) a continuous monitoring system;
 - (6) auditor qualification and authorisation; and
 - (7) the frequency of audits.
- (b) The third country code-share operator should be audited at periods not exceeding 24 months. The beginning of the first 24-month oversight planning cycle is determined by the date of the first audit and should then determine the start and end dates of the recurrent 24-month planning cycle. The interval between two audits should not exceed 24 months.
- (c) The EU operator should ensure a renewal audit of each third country code-share operator prior to the audit expiry date of the previous audit. The audit expiry date for the previous audit becomes the audit effective date for the renewal audit provided the closing meeting for the renewal audit is within 150 days prior to the audit expiry date for the previous audit. If the closing meeting for the renewal audit is more than 150 days prior to the audit expiry date from the previous audit, then the audit effective date for the renewal audit is the day of the closing meeting of the renewal audit. Renewal audits are valid for 24 consecutive months beginning with the audit effective date and ending with the audit expiry date.
- (d) A code-share audit could be shared by several operators. In case of a shared audit, the report should be made available for review by all duly identified sharing operators by any means.
- (e) After closure of all findings identified during the audit, the EU operator should submit an audit compliance statement to the competent authority demonstrating that the third country operator meets all the applicable safety standards.

AMC2 ORO.AOC.115(b) Code-share agreements

ED Decision 2019/019/R

THIRD-PARTY PROVIDERS

- (a) The initial audit and/or the continuous monitoring may be performed by a third-party provider on behalf of the EU operator in accordance with [AMC2 ORO.GEN.205](#) on contracted activities.
- (b) The use of a third-party provider for the initial audit or the monitoring of continuous compliance of the third-country code-share operator does not exempt the EU operator from its responsibility under [ORO.AOC.115](#).
- (c) The EU operator should maintain a list of the third country code-share operators monitored by the third-party provider. This list and the full audit report prepared by the third-party provider should be made available to the competent authority upon request.

ORO.AOC.120 Approvals to provide cabin crew training and to issue cabin crew attestations

Regulation (EU) No 965/2012

- (a) When intending to provide the training course required in Annex V (Part-CC) to Regulation (EU) No 1178/2011, the operator shall apply for and obtain an approval issued by the competent authority. For this purpose, the applicant shall demonstrate compliance with the requirements for the conduct and content of training course established in CC.TRA.215 and CC.TRA.220 of that Annex and shall provide the competent authority with:
- (1) the date of intended commencement of activity;
 - (2) the personal details and qualifications of the instructors as relevant to the training elements to be covered;
 - (3) the name(s) and address(es) of the training site(s) at which the training is to be conducted;
 - (4) a description of the facilities, training methods, manuals and representative devices to be used; and
 - (5) the syllabi and associated programmes for the training course.
- (b) If a Member State decides, in accordance with ARA.CC.200 of Annex VI (Part-ARA) to Regulation (EU) No 1178/2011, that operators may be approved to issue cabin crew attestations, the applicant shall, in addition to (a):
- (1) demonstrate to the competent authority that:
 - (i) the organisation has the capability and accountability to perform this task;
 - (ii) the personnel conducting examinations are appropriately qualified and free from conflict of interest; and
 - (2) provide the procedures and the specified conditions for:
 - (i) conducting the examination required by CC.TRA.220;
 - (ii) issuing cabin crew attestations; and
 - (iii) supplying the competent authority with all relevant information and documentation related to the attestations it will issue and their holders, for the purpose of record-keeping, oversight and enforcement actions by that authority.
- (c) The approvals referred to in (a) and (b) shall be specified in the operations specifications.

ORO.AOC.125 Non-commercial operations of an AOC holder with aircraft listed on its AOC

Regulation (EU) 2019/1384

- (a) The AOC holder may conduct non-commercial operations in accordance with Annex VI (Part-NCC) or Annex VII (Part-NCO) with aircraft listed in the operations specifications of its AOC or in its operations manual, provided that the AOC holder describes such operations in detail in the operations manual, including the following:
- (1) an identification of the applicable requirements:

- (2) a description of any differences between operating procedures used when conducting CAT operations and non-commercial operations;
 - (3) means of ensuring that all personnel involved in the operations are fully familiar with the associated procedures;
- (b) An AOC holder shall comply with:
- (1) Annex VIII (Part-SPO) when conducting maintenance check flights with complex motor-powered aircraft;
 - (2) Annex VII (Part-NCO) when conducting maintenance check flights with other than complex motor-powered aircraft.
- (c) An AOC holder conducting operations referred to in points (a) and (b) shall not be required to submit a declaration in accordance with this Annex.
- (d) The AOC holder shall specify the type of flight, as listed in its operations manual, in the flight-related documents (operational flight plan, loadsheet and other equivalent documents).

AMC1 ORO.AOC.125(a) Non-commercial operations of an AOC holder with aircraft listed on its AOC

ED Decision 2019/019/R

FLIGHT AND DUTY TIME LIMITATIONS AND REST REQUIREMENTS

When aircrew members are assigned to perform a series of flights that combine several types of operation (CAT, NCC/NCO), the operator should:

- (a) comply at any time with the provisions of [ORO.FTL.210](#) 'Flight times and duty periods' or, as applicable, the provisions of Council Regulation (EEC) No 3922/91 (EU-OPS, Subpart Q), to ensure compliance with Subpart FTL for any CAT operation; and
- (b) include any combination of types of operation in its safety risk management process to ensure that the fatigue risks arising from such operations do not affect the CAT operation.

AMC2 ORO.AOC.125(a) Non-commercial operations of an AOC holder with aircraft listed on its AOC

ED Decision 2019/019/R

APPLICABLE REQUIREMENTS

An AOC holder should apply either of the options below to its non-commercial operations:

- (a) the same operational procedures as those used for its CAT operations. In this case, the AOC holder should state this option in the operations manual and ensure that the procedures comply with Part-CAT. No further descriptions are required; or
- (b) different operational procedures from those used for its CAT operations. In this case, the procedures should comply with Part-ORO, except for Subpart-DEC, and Part-NCC for complex motor-powered aircraft or with Part-NCO for other than complex motor-powered aircraft, as appropriate.

AMC1 ORO.AOC.125(a)(2) Non-commercial operations of an AOC holder with aircraft listed on its AOC

ED Decision 2019/019/R

DIFFERENT OPERATING PROCEDURES FOR NON-COMMERCIAL OPERATIONS

When developing operating procedures for non-commercial operations that are different from the ones used for its CAT operations, the AOC holder should identify the hazards and assess and mitigate the risks associated with each specific non-commercial operation, as part of the safety risk management process in compliance with [ORO.GEN.200](#).

This process should consider at least the following elements:

- (a) Flight profile (including manoeuvres to be performed, any simulated abnormal situations in flight, duties and responsibilities of the crew members);
- (b) Continuing airworthiness, as applicable. This includes the case when the aircraft is returned to the AOC holder after having been used by another operator for operations in accordance with [ORO.GEN.310](#);
- (c) Levels of functional equipment and systems (MEL, CDL);
- (d) Operating procedures, minima, and dispatch criteria;
- (e) Operating a flight with a double purpose (e.g. a relocation flight used as a line training flight or a maintenance check flight used as a line training flight);
- (f) Specific approvals held by the AOC holder;
- (g) Flight and duty time limitations and rest requirements and cumulative fatigue;
- (h) Selection, composition, and training of flight crew and cabin crew;
- (i) Multi-pilot operation as per Part-CAT vs single-pilot operation when operating according to Part-NCC or Part-NCO;
- (j) Flights performed with aircrew that includes aircrew members of another operator, who have not completed a familiarisation training and who may not be familiar with the AOC holder's operational procedures;
- (k) Categories of passengers on board, including when non-commercial operations are performed with no cabin crew.

AMC2 ORO.AOC.125(a)(2) Non-commercial operations of an AOC holder with aircraft listed on its AOC

ED Decision 2019/019/R

PLANNING FLIGHTS WITH AN INCREASED LEVEL OF RISK

- (a) Significant aspects such as the ones below should be addressed in the risk assessment and risk mitigation process by any operator conducting such flights:
 - (1) which pilots are involved in their operation;
 - (2) what is the purpose of the flight; and
 - (3) how it is to be accomplished — what flight procedures are to be applied.
- (b) The AOC holder should prepare the non-commercial operations with an increased level of risk taking into consideration the following elements, as applicable:

- (1) pre-flight briefing;
- (2) duties and responsibilities of the flight crew members involved, task sharing;
- (3) special operating procedures;
- (4) manoeuvres to be performed in flight, minimum and maximum speeds and altitudes for all portions of the flight;
- (5) operational limitations;
- (6) potential risks and contingency plans;
- (7) adequate available airspace and coordination with the air traffic control (ATC);
- (8) selection of flight crew members; and
- (9) additional flight crew training at regular intervals to ensure recency (considering also a flight of a similar risk profile in the simulator, if needed).

GM1 ORO.AOC.125(a)(2) Non-commercial operations of an AOC holder with aircraft listed on an AOC

ED Decision 2019/019/R

EXAMPLES OF DIFFERENT OPERATING PROCEDURES APPLIED TO NON-COMMERCIAL OPERATIONS

The provisions of [ORO.AOC.125](#) enable an AOC holder to apply the most appropriate requirements when conducting non-commercial operations, based on the risk assessment and risk mitigation processes.

Below is a non-exhaustive list of elements that an AOC holder may identify and describe as being different in its non-commercial operations from those used for its CAT operation and for which the provisions of Part-ORO and Part-NCC or the provisions of Part-NCO should apply as appropriate:

- (a) Qualification, training and experience of aircrew members, including aerodrome and route competence requirements.
- (b) Flight crew and cabin crew composition requirements
 - (1) CAT operations contain more stringent requirements for aircrew members, e.g. multi-pilot vs single-pilot requirements.
 - (2) The AOC holder should specify the minimum number of flight crew and cabin crew and the applicable aircrew composition.
- (c) Fuel requirements
- (d) Performance requirements
- (e) Serviceable instruments, data and equipment and MEL considerations
- (f) Non-ETOPS/ETOPS

ETOPS are applicable to CAT operations only and thus a flight operated according to Part-NCC/Part-NCO may be performed without the ETOPS restrictions.
- (g) Non-commercial flights with no cabin crew (see [ORO.CC.100\(d\)](#) and the associated AMC).

ORO.AOC.130 Flight data monitoring – aeroplanes

Regulation (EU) 2015/1329

- (a) The operator shall establish and maintain a flight data monitoring programme, which shall be integrated in its management system, for aeroplanes with a maximum certificated take-off mass of more than 27 000 kg.
- (b) The flight data monitoring programme shall be non-punitive and contain adequate safeguards to protect the source(s) of the data.

AMC1 ORO.AOC.130 Flight data monitoring – aeroplanes

ED Decision 2021/005/R

FLIGHT DATA MONITORING (FDM) PROGRAMME

- (a) The safety manager, as defined under [AMC1-ORO.GEN.200\(a\)\(1\)](#), should be responsible for the identification and assessment of issues and their transmission to the manager(s) responsible for the process(es) concerned. The latter should be responsible for taking appropriate and practicable safety action within a reasonable period of time that reflects the severity of the issue.
- (b) An FDM programme should allow an operator to:
 - (1) identify areas of operational risk and quantify current safety margins;
 - (2) identify and quantify operational risks by highlighting occurrences of non-standard, unusual or unsafe circumstances;
 - (3) use the FDM information on the frequency of such occurrences, combined with an estimation of the level of severity, to assess the safety risks and to determine which may become unacceptable if the discovered trend continues;
 - (4) put in place appropriate procedures for remedial action once an unacceptable risk, either actually present or predicted by trending, has been identified; and
 - (5) confirm the effectiveness of any remedial action by continued monitoring.
- (c) FDM analysis techniques should comprise the following:
 - (1) Exceedance detection: searching for deviations from aircraft flight manual limits and standard operating procedures. A set of core events should be selected to cover the main areas of interest to the operator and as much as possible, the most significant risks identified by the operator. The event definitions should be continuously reviewed to reflect the operator's current operating procedures.
 - (2) All flights measurement: a system defining what is normal practice. This may be accomplished by retaining various snapshots of information from each flight.
 - (3) Statistics — a series of data collected to support the analysis process: this technique should include the number of flights flown per aircraft and sector details sufficient to generate rate and trend information.
- (d) FDM analysis, assessment and process control tools: the effective assessment of information obtained from digital flight data should be dependent on the provision of appropriate information technology tool sets.

-
- (e) Education and publication: sharing safety information should be a fundamental principle of aviation safety in helping to reduce accident rates. The operator should pass on the lessons learnt to all relevant personnel and, where appropriate, industry.
- (f) Accident and incident data requirements specified in [CAT.GEN.MPA.195](#) take precedence over the requirements of an FDM programme. In these cases the FDR data should be retained as part of the investigation data and may fall outside the de-identification agreements.
- (g) Every crew member should be responsible for reporting events. Significant risk-bearing incidents detected by FDM should therefore normally be the subject of mandatory occurrence reporting by the crew. If this is not the case, then they should submit a retrospective report that should be included under the normal process for reporting and analysing hazards, incidents and accidents.
- (h) The data recovery strategy should ensure a sufficiently representative capture of flight information to maintain an overview of operations. Data analysis should be performed sufficiently frequently to enable action to be taken on significant safety issues.
- (i) The data retention strategy should aim at providing the greatest safety benefits practicable from the available data. A full dataset should be retained until the action and review processes are complete; thereafter, a reduced dataset relating to closed issues should be maintained for longer-term trend analysis. Programme managers may wish to retain samples of de-identified full-flight data for various safety purposes (detailed analysis, training, benchmarking, etc.).
- (j) The data access and security policy should restrict information access to authorised persons. When data access is required for airworthiness and maintenance purposes, a procedure should be in place to prevent disclosure of crew identity.
- (k) The procedure to prevent disclosure of crew identity should be written in a document, which should be signed by all parties (airline management, flight crew member representatives nominated either by the union or the flight crew themselves). This procedure should, as a minimum, define:
- (1) the aim of the FDM programme;
 - (2) a data access and security policy that should restrict access to information to specifically authorised persons identified by their position;
 - (3) the method to obtain de-identified crew feedback on those occasions that require specific flight follow-up for contextual information; where such crew contact is required the authorised person(s) need not necessarily be the programme manager or safety manager, but could be a third party (broker) mutually acceptable to unions or staff and management;
 - (4) the data retention policy and accountability, including the measures taken to ensure the security of the data;
 - (5) the conditions under which advisory briefing or remedial training should take place; this should always be carried out in a constructive and non-punitive manner;
 - (6) the conditions under which the confidentiality may be withdrawn for reasons of gross negligence or significant continuing safety concern;
 - (7) the participation of flight crew member representative(s) in the assessment of the data, the action and review process and the consideration of recommendations; and
 - (8) the policy for publishing the findings resulting from FDM.

- (l) Airborne systems and equipment used to obtain FDM data should range from a quick access recorder (QAR) in an aircraft with digital systems, to a crash-protected flight recorder in an older or less sophisticated aircraft. The analysis potential of the reduced data set available in the latter case may reduce the safety benefits obtainable. The operator should ensure that FDM use does not adversely affect the serviceability of equipment required for accident investigation.

GM1 ORO.AOC.130 Flight data monitoring – aeroplanes

ED Decision 2021/005/R

IMPLEMENTATION OF AN FDM PROGRAMME

Flight data monitoring is defined in Annex I to this Regulation. It should be noted that the requirement to establish a FDM programme is applicable to all individual aircraft in the scope of [ORO.AOC.130](#), not to a subset selected by the operator.

- (a) FDM analysis techniques
- (1) Exceedance detection
- (i) FDM programmes are used for detecting exceedances, such as deviations from flight manual limits, standard operating procedures (SOPs), or good airmanship. Typically, a set of core events establishes the main areas of interest that are based on a prior assessment of the most significant risks by the operator. In addition, it is advisable to consider the following risks: risk of runway excursion or abnormal runway contact at take-off or landing, risk of loss of control in flight, risk of airborne collision, and risk of collision with terrain.
- Examples: low or high lift-off rotation rate, stall warning, ground proximity warning system (GPWS) warning, flap limit speed exceedance, fast approach, high or low on glideslope, heavy landing.
- (ii) Trigger logic expressions may be simple exceedances such as redline values. The majority, however, are composites that define a certain flight mode, aircraft configuration or payload-related condition. Analysis software can also assign different sets of rules dependent on airport or geography. For example, noise sensitive airports may use higher than normal glideslopes on approach paths over populated areas. In addition, it might be valuable to define several levels of exceedance severity (such as low, medium and high).
- (iii) Exceedance detection provides useful information, which can complement that provided in crew reports.
- Examples: reduced flap landing, emergency descent, engine failure, rejected take-off, go-around, airborne collision avoidance system (ACAS) or GPWS warning, and system malfunctions.
- (iv) The operator may also modify the standard set of core events to account for unique situations they regularly experience, or the SOPs they use.
- Example: to avoid nuisance exceedance reports from a non-standard instrument departure.
- (v) The operator may also define new events to address specific problem areas.
- Example: restrictions on the use of certain flap settings to increase component life.

(2) All-flights measurements

FDM data are retained from all flights, not just the ones producing significant events. A selection of parameters is retained that is sufficient to characterise each flight and allow a comparative analysis of a wide range of operational variability. Emerging trends and tendencies may be identified and monitored before the trigger levels associated with exceedances are reached.

Examples of parameters monitored: take-off weight, flap setting, temperature, rotation and lift-off speeds versus scheduled speeds, maximum pitch rate and attitude during rotation, and gear retraction speeds, heights and times.

Examples of comparative analyses: pitch rates from high versus low take-off weights, good versus bad weather approaches, and touchdowns on short versus long runways.

(3) Statistics

Series of data are collected to support the analysis process: these usually include the numbers of flights flown per aircraft and sector details sufficient to generate rate and trend information.

(4) Investigation of incidents flight data

Recorded flight data provide valuable information for follow-up to incidents and other technical reports. They are useful in adding to the impressions and information recalled by the flight crew. They also provide an accurate indication of system status and performance, which may help in determining cause and effect relationships.

Examples of incidents where recorded data could be useful:

- high cockpit workload conditions as corroborated by such indicators as late descent, late localizer and/or glideslope interception, late landing configuration;
- unstabilised and rushed approaches, glide path excursions, etc.;
- exceedances of prescribed operating limitations (such as flap limit speeds, engine overtemperatures); and
- wake vortex encounters, turbulence encounters or other vertical accelerations.

It should be noted that recorded flight data have limitations, e.g. not all the information displayed to the flight crew is recorded, the source of recorded data may be different from the source used by a flight instrument, the sampling rate or the recording resolution of a parameter may be insufficient to capture accurate information.

(5) Continuing airworthiness

Data of all-flight measurements and exceedance detections can be utilised to assist the continuing airworthiness function. For example, engine-monitoring programmes look at measures of engine performance to determine operating efficiency and predict impending failures.

Examples of continuing airworthiness uses: engine thrust level and airframe drag measurements, avionics and other system performance monitoring, flying control performance, and brake and landing gear usage.

(b) FDM equipment

(1) General

FDM programmes generally involve systems that capture flight data, transform the data into an appropriate format for analysis, and generate reports and visualisation to assist in assessing the data. Typically, the following equipment capabilities are needed for effective FDM programmes:

- (i) an on-board device to capture and record data on a wide range of in-flight parameters;
- (ii) a means to transfer the data recorded on board the aircraft to a ground-based processing station;
- (iii) a ground-based computer system to analyse the data, identify deviations from expected performance, generate reports to assist in interpreting the read-outs, etc.; and
- (iv) optional software for a flight animation capability to integrate all data, presenting them as a simulation of in-flight conditions, thereby facilitating visualisation of actual events.

(2) Airborne equipment

- (i) The flight parameters and recording capacity required for flight data recorders (FDR) to support accident investigations may be insufficient to support an effective FDM programme. Other technical solutions are available, including the following:
 - (A) Quick access recorders (QARs). QARs are installed in the aircraft and record flight data onto a low-cost removable medium.
 - (B) Some systems automatically download the recorded information via secure wireless systems when the aircraft is in the vicinity of the gate. There are also systems that enable the recorded data to be analysed on board while the aircraft is airborne.
- (ii) Fleet composition, route structure and cost considerations will determine the most cost-effective method of removing the data from the aircraft.

(3) Ground replay and analysis equipment

- (i) Data are downloaded from the aircraft recording device into a ground-based processing station, where the data are held securely to protect this sensitive information.
- (ii) FDM programmes generate large amounts of data requiring specialised analysis software.
- (iii) The analysis software checks the downloaded flight data for abnormalities.
- (iv) The analysis software may include: annotated data trace displays, engineering unit listings, visualisation for the most significant incidents, access to interpretative material, links to other safety information and statistical presentations.

(c) FDM in practice

(1) FDM process

Typically, operators follow a closed-loop process in applying an FDM programme, for example:

- (i) Establish a baseline: initially, operators establish a baseline of operational parameters against which changes can be detected and measured.

Examples: rate of unstable approaches or hard landings.

- (ii) Highlight unusual or unsafe circumstances: the user determines when non-standard, unusual or basically unsafe circumstances occur; by comparing them to the baseline margins of safety, the changes can be quantified.

Example: increases in unstable approaches (or other unsafe events) at particular locations.

- (iii) Identify unsafe trends: based on the frequency and severity of occurrence, trends are identified. Combined with an estimation of the level of severity, the risks are assessed to determine which may become unacceptable if the trend continues.

Example: a new procedure has resulted in high rates of descent that are nearly triggering GPWS warnings.

- (iv) Mitigate risks: once an unacceptable risk has been identified, appropriate risk mitigation actions are decided on and implemented.

Example: having found high rates of descent, the SOPs are changed to improve aircraft control for optimum/maximum rates of descent.

- (v) Monitor effectiveness: once a remedial action has been put in place, its effectiveness is monitored, confirming that it has reduced the identified risk and that the risk has not been transferred elsewhere.

Example: confirm that other safety measures at the aerodrome with high rates of descent do not change for the worse after changes in approach procedures.

(2) Analysis and follow-up

- (i) FDM data are typically compiled every month or at shorter intervals. The data are then reviewed to identify specific exceedances and emerging undesirable trends and to disseminate the information to flight crews.

- (ii) If deficiencies in pilot handling technique are evident, the information is usually de-identified in order to protect the identity of the flight crew. The information on specific exceedances is passed to a person (safety manager, agreed flight crew representative, honest broker) assigned by the operator for confidential discussion with the pilot. The person assigned by the operator provides the necessary contact with the pilot in order to clarify the circumstances, obtain feedback and give advice and recommendations for appropriate action. Such appropriate action could include re-training for the pilot (carried out in a constructive and non-punitive way), revisions to manuals, changes to ATC and airport operating procedures.

- (iii) Follow-up monitoring enables the effectiveness of any corrective actions to be assessed. Flight crew feedback is essential for the identification and resolution of safety problems and could be collected through interviews, for example by asking the following:

-
- (A) Are the desired results being achieved soon enough?
 - (B) Have the problems really been corrected, or just relocated to another part of the system?
 - (C) Have new problems been introduced?
 - (iv) All events are usually archived in a database. The database is used to sort, validate and display the data in easy-to-understand management reports. Over time, this archived data can provide a picture of emerging trends and hazards that would otherwise go unnoticed.
 - (v) Lessons learnt from the FDM programme may warrant inclusion in the operator's safety promotion programmes. Safety promotion media may include newsletters, flight safety magazines, highlighting examples in training and simulator exercises, periodic reports to industry and the competent authority. Care is required, however, to ensure that any information acquired through FDM is de-identified before using it in any training or promotional initiative.
 - (vi) All successes and failures are recorded, comparing planned programme objectives with expected results. This provides a basis for review of the FDM programme and the foundation for future programme development.
- (d) Preconditions for an effective FDM programme
- (1) Protection of FDM data

The integrity of FDM programmes rests upon protection of the FDM data. Any disclosure for purposes other than safety management can compromise the voluntary provision of safety data, thereby compromising flight safety.
 - (2) Essential trust

The trust established between management and flight crew is the foundation for a successful FDM programme. This trust can be facilitated by:

 - (i) early participation of the flight crew representatives in the design, implementation and operation of the FDM programme;
 - (ii) a formal agreement between management and flight crew, identifying the procedures for the use and protection of data; and
 - (iii) data security, optimised by:
 - (A) adhering to the agreement;
 - (B) the operator strictly limiting data access to selected individuals;
 - (C) maintaining tight control to ensure that identifying data is kept securely; and
 - (D) ensuring that operational problems are promptly addressed by management.
 - (3) Requisite safety culture

Indicators of an effective safety culture typically include:

 - (i) top management's demonstrated commitment to promoting a proactive safety culture;
 - (ii) a non-punitive operator policy that covers the FDM programme;

- (iii) FDM programme management by dedicated staff under the authority of the safety manager, with a high degree of specialisation and logistical support;
 - (iv) involvement of persons with appropriate expertise when identifying and assessing the risks (for example, pilots experienced on the aircraft type being analysed);
 - (v) monitoring fleet trends aggregated from numerous operations, not focusing only on specific events;
 - (vi) a well-structured system to protect the confidentiality of the data; and
 - (vii) an efficient communication system for disseminating hazard information (and subsequent risk assessments) internally and to other organisations to permit timely safety action.
- (e) Implementing an FDM programme
- (1) General considerations
 - (i) Typically, the following steps are necessary to implement an FDM programme:
 - (A) implementation of a formal agreement between management and flight crew;
 - (B) establishment and verification of operational and security procedures;
 - (C) installation of equipment;
 - (D) selection and training of dedicated and experienced staff to operate the programme; and
 - (E) commencement of data analysis and validation.
 - (ii) An operator with no FDM experience may need a year to achieve an operational FDM programme. Another year may be necessary before any safety and cost benefits appear. Improvements in the analysis software, or the use of outside specialist service providers, may shorten these time frames.
 - (2) Aims and objectives of an FDM programme
 - (i) As with any project there is a need to define the direction and objectives of the work. A phased approach is recommended so that the foundations are in place for possible subsequent expansion into other areas. Using a building block approach will allow expansion, diversification and evolution through experience.

Example: with a modular system, begin by looking at basic safety-related issues only. Add engine health monitoring, etc. in the second phase. Ensure compatibility with other systems.
 - (ii) A staged set of objectives starting from the first week's replay and moving through early production reports into regular routine analysis will contribute to a sense of achievement as milestones are met.

Examples of short-term, medium-term and long-term goals:
 - (A) Short-term goals:
 - establish data download procedures, test replay software and identify aircraft defects;
 - validate and investigate exceedance data; and

-
- establish a user-acceptable routine report format to highlight individual exceedances and facilitate the acquisition of relevant statistics.
- (B) Medium-term goals:
- produce an annual report — include key performance indicators;
 - add other modules to the analysis (e.g. continuing airworthiness); and
 - plan for the next fleet to be added to programme.
- (C) Long-term goals:
- network FDM information across all of the operator's safety information systems;
 - ensure FDM provision for any proposed alternative training and qualification programme (ATQP); and
 - use utilisation and condition monitoring to reduce spares holdings.
- (iii) Initially, focusing on a few known areas of interest will help prove the system's effectiveness. In contrast to an undisciplined 'scatter-gun' approach, a focused approach is more likely to gain early success.
- Examples: rushed approaches, or rough runways at particular aerodromes. Analysis of such known problem areas may generate useful information for the analysis of other areas.
- (3) The FDM team
- (i) Experience has shown that the 'team' necessary to run an FDM programme could vary in size from one person for a small fleet, to a dedicated section for large fleets. The descriptions below identify various functions to be fulfilled, not all of which need a dedicated position.
- (A) Team leader: it is essential that the team leader earns the trust and full support of both management and flight crew. The team leader acts independently of others in line management to make recommendations that will be seen by all to have a high level of integrity and impartiality. The individual requires good analytical, presentation and management skills.
- (B) Flight operations interpreter: this person is usually a current pilot (or perhaps a recently retired senior captain or instructor), who knows the operator's route network and aircraft. This team member's in-depth knowledge of SOPs, aircraft handling characteristics, aerodromes and routes is used to place the FDM data in a credible context.
- (C) Technical interpreter: this person interprets FDM data with respect to the technical aspects of the aircraft operation and is familiar with the power plant, structures and systems departments' requirements for information and any other engineering monitoring programmes in use by the operator.
- (D) Gate-keeper: this person provides the link between the fleet or training managers and flight crew involved in events highlighted by FDM. The position requires good people skills and a positive attitude towards safety education. The person is typically a representative of the flight crew association or an 'honest broker' and is the only person permitted to

connect the identifying data with the event. It is essential that this person earns the trust of both management and flight crew.

- (E) Engineering technical support: this person is usually an avionics specialist, involved in the supervision of mandatory serviceability requirements for FDR systems. This team member is knowledgeable about FDM and the associated systems needed to run the programme.
 - (F) Replay operative and administrator: this person is responsible for the day-to-day running of the system, producing reports and analysis.
- (ii) All FDM team members need appropriate training or experience for their respective area of data analysis. Each team member is allocated a realistic amount of time to regularly spend on FDM tasks.

GM2 ORO.AOC.130 Flight data monitoring — aeroplanes

ED Decision 2021/005/R

EXAMPLES OF FDM EVENTS

The following table provides examples of FDM events that may be further developed using operator and aeroplane specific limits. The table is considered illustrative and not exhaustive. Other examples may be found in the documents published by the [European Operators Flight Data Monitoring \(EOFDM\) forum](#).

Event Group	Description
Rejected take-off	High speed rejected take-off
Take-off pitch	Pitch rate low or high on take-off
	Pitch attitude high during take-off
Unstick speeds	Unstick speed high
	Unstick speed low
Height loss in climb-out	Initial climb height loss 20 ft above ground level (AGL) to 400 ft above aerodrome level (AAL)
	Initial climb height loss 400 ft to 1 500 ft AAL
Slow climb-out	Excessive time to 1 000 ft AAL after take-off
Climb-out speeds	Climb-out speed high below 400 ft AAL
	Climb-out speed high 400 ft AAL to 1 000 ft AAL
	Climb-out speed low 35 ft AGL to 400 ft AAL
	Climb-out speed low 400 ft AAL to 1 500 ft AAL
High rate of descent	High rate of descent below 2 000 ft AGL
Missed approach	Missed approach below 1 000 ft AAL
	Missed approach above 1 000 ft AAL
Low approach	Low on approach
Glideslope	Deviation under glideslope
	Deviation above glideslope (below 600 ft AGL)
Approach power	Low power on approach
Approach speeds	Approach speed high within 90 seconds of touchdown
	Approach speed high below 500 ft AAL
	Approach speed high below 50 ft AGL
	Approach speed low within 2 minutes of touchdown
Landing flap	Late land flap (not in position below 500 ft AAL)

Event Group	Description
	Reduced flap landing
	Flap load relief system operation
Landing pitch	Pitch attitude high on landing
	Pitch attitude low on landing
Bank angles	Excessive bank below 100 ft AGL
	Excessive bank 100 ft AGL to 500 ft AAL
	Excessive bank above 500 ft AGL
	Excessive bank near ground (below 20 ft AGL)
Normal acceleration	High normal acceleration on ground
	High normal acceleration in flight flaps up (+/- increment)
	High normal acceleration in flight flaps down(+/- increment)
	High normal acceleration at landing
Abnormal configuration	Take-off configuration warning
	Early configuration change after take-off (flap)
	Speed brake with flap
	Speed brake on approach below 800 ft AAL
	Speed brake not armed below 800 ft AAL
Ground proximity warning	Ground proximity warning system (GPWS) operation - hard warning
	GPWS operation — soft warning
	GPWS operation — windshear warning
	GPWS operation — false warning
Airborne collision avoidance system (ACAS II) warning	ACAS operation — Resolution Advisory
Margin to stall/buffet	Stick shake
	False stick shake
	Reduced lift margin except near ground
	Reduced lift margin at take-off
	Low buffet margin (above 20 000 ft)
Aircraft flight manual limitations	Maximum operating speed limit (V _{MO}) exceedance
	Maximum operating speed limit (M _{MO}) exceedance
	Flap placard speed exceedance
	Gear down speed exceedance
	Gear selection up/down speed exceedance
	Flap/slat altitude exceedance
	Maximum operating altitude exceedance

GM3 ORO.AOC.130 Flight data monitoring – aeroplanes

ED Decision 2021/005/R

GUIDANCE AND INDUSTRY GOOD PRACTICE

- (a) Additional guidance material for the establishment of flight data monitoring may be found in:
- (1) International Civil Aviation Organization (ICAO) Doc 10000 ‘Manual on Flight Data Analysis Programmes (FDAP)’; and

- (2) UK Civil Aviation Authority CAP 739 (Flight Data Monitoring), second edition dated June 2013.
- (b) Examples of industry good practice for the establishment of flight data monitoring may be found in the documents published by the [European Operators Flight Data Monitoring \(EOFD\) forum](#).

ORO.AOC.135 Personnel requirements

Regulation (EU) 2019/1384

- (a) In accordance with point [ORO.GEN.210\(b\)](#), the operator shall nominate persons responsible for the management and supervision of the following areas:
- (1) flight operations;
 - (2) crew member training;
 - (3) ground operations;
 - (4) continuing airworthiness or for the continuing airworthiness management contract in accordance with Regulation (EU) No 1321/2014, as the case may be.
- (b) *Adequacy and competency of personnel*
- (1) The operator shall employ sufficient personnel for the planned ground and flight operations.
 - (2) All personnel assigned to, or directly involved in, ground and flight operations shall:
 - (i) be properly trained;
 - (ii) demonstrate their capabilities in the performance of their assigned duties; and
 - (iii) be aware of their responsibilities and the relationship of their duties to the operation as a whole.
- (c) *Supervision of personnel*
- (1) The operator shall appoint a sufficient number of personnel supervisors, taking into account the structure of the operator's organisation and the number of personnel employed.
 - (2) The duties and responsibilities of these supervisors shall be defined, and any other necessary arrangements shall be made to ensure that they can discharge their supervisory responsibilities.
 - (3) The supervision of crew members and personnel involved in the operation shall be exercised by individuals with adequate experience and the skills to ensure the attainment of the standards specified in the operations manual.

AMC1 ORO.AOC.135(a) Personnel requirements

ED Decision 2014/017/R

NOMINATED PERSONS

- (a) The person may hold more than one of the nominated posts if such an arrangement is considered suitable and properly matched to the scale and scope of the operation.
- (b) A description of the functions and the responsibilities of the nominated persons, including their names, should be contained in the operations manual.

- (c) The holder of an AOC should make arrangements to ensure continuity of supervision in the absence of nominated persons.
- (d) The person nominated by the holder of an AOC should not be nominated by another holder of an AOC, unless agreed with the competent authorities concerned.
- (e) Persons nominated should be contracted to work sufficient hours to fulfil the management functions associated with the scale and scope of the operation.

AMC2 ORO.AOC.135(a) Personnel requirements

ED Decision 2014/017/R

COMBINATION OF NOMINATED PERSONS RESPONSIBILITIES

- (a) The acceptability of a single person holding several posts, possibly in combination with being the accountable manager, should depend upon the nature and scale of the operation. The two main areas of concern should be competence and an individual's capacity to meet his/her responsibilities.
- (b) As regards competence in different areas of responsibility, there should not be any difference from the requirements applicable to persons holding only one post.
- (c) The capacity of an individual to meet his/her responsibilities should primarily be dependent upon the scale of the operation. However, the complexity of the organisation or of the operation may prevent, or limit, combinations of posts which may be acceptable in other circumstances.
- (d) In most circumstances, the responsibilities of a nominated person should rest with a single individual. However, in the area of ground operations, it may be acceptable for responsibilities to be split, provided that the responsibilities of each individual concerned are clearly defined.

AMC1 ORO.AOC.135(a)(4) Personnel requirements

ED Decision 2022/017/R

NOMINATED PERSON RESPONSIBLE FOR THE MANAGEMENT AND SUPERVISION OF THE CONTRACT WITH A CAMO PURSUANT TO POINT M.A.201(ea)

If the operator concludes a contract with a CAMO pursuant to point M.A.201(ea) of Annex I (Part-M) to [Regulation \(EU\) No 1321/2014](#), the person nominated by the operator in accordance with point [ORO.AOC.135\(a\)\(4\)](#) is responsible for the management and supervision of the continuing airworthiness management contract that is required by Appendix I to Part-M. This person should not be employed by the contracted CAMO to avoid conflict of interest. In addition, this person should have the following:

- (a) practical experience and expertise in the application of aviation safety standards and safe operating practices;
- (b) comprehensive knowledge of:
 - (i) the relevant parts of operational requirements and procedures;
 - (ii) the air operator certificate (AOC) holder's operations specifications;
 - (iii) the relevant parts of the AOC holder's operations manual; and
 - (iv) the relevant parts of the continuing airworthiness management exposition (CAME) of the contracted CAMO;

- (c) knowledge of:
 - (i) human factors (HF) principles; and
 - (ii) safety management system (SMS) based on the EU management system requirements (including compliance monitoring) and International Civil Aviation Organization (ICAO) Annex 19;
- (d) 5 years of relevant work experience, of which at least 2 years in an appropriate position in the aeronautical industry;
- (e) a relevant engineering or technical degree, or an aircraft maintenance technician qualification with additional education that is acceptable to the competent authority; this condition may be replaced by 3 years of experience in addition to those specified in point (d); those 3 years should include an appropriate combination of experience in tasks related to aircraft maintenance and/or continuing airworthiness management and/or surveillance of such tasks;
- (f) thorough knowledge of:
 - (i) the continuing airworthiness management contract;
 - (ii) the organisation's management systems' interfaces; and
 - (iii) the way of achieving harmonisation of those management systems;
- (g) knowledge of a relevant sample of the type(s) of aircraft operated by the organisation, which is gained through a formalised training course; such a course should be at least at a level equivalent to Part-66 (Annex III to [Regulation \(EU\) No 1321/2014](#)), Appendix III, Level 1 'General Familiarisation' and may be provided by a Part-147 (Annex IV to [Regulation \(EU\) No 1321/2014](#)) organisation, by the manufacturer, by the CAMO, or by any other organisation that is accepted by the competent authority; 'relevant sample' means that the related course should cover typical aircraft and aircraft systems that are operated by the organisation; and
- (h) knowledge of [Regulation \(EU\) No 1321/2014](#).

GM1 ORO.AOC.135(a) Personnel requirements

ED Decision 2014/017/R

NOMINATED PERSONS

The smallest organisation that can be considered is the one-man organisation where all of the nominated posts are filled by the accountable manager, and audits are conducted by an independent person.

GM2 ORO.AOC.135(a) Personnel requirements

ED Decision 2022/017/R

COMPETENCE OF NOMINATED PERSONS

- (a) Nominated persons in accordance with [ORO.AOC.135](#) should be expected to possess the experience and meet the qualification provisions of (b) to (f) respectively. Exceptionally, in particular cases, where the nominated person does not meet these provisions in full, the nominee should have comparable experience and also the ability to perform effectively the functions associated with the post and with the scale of the operation.

- (b) Nominated persons for flight operations, crew training and ground operations should have:
- (1) practical experience and expertise in the application of aviation safety standards and safe operating practices;
 - (2) comprehensive knowledge of:
 - (i) the applicable EU safety regulations and any associated requirements and procedures;
 - (ii) the AOC holder's operations specifications; and
 - (iii) the need for, and content of, the relevant parts of the AOC holder's operations manual;
 - (3) familiarity with management systems preferably in the area of aviation;
 - (4) appropriate management experience, preferably in a comparable organisation; and
 - (5) 5 years of relevant work experience of which at least 2 years should be from the aeronautical industry in an appropriate position.
- (c) Flight operations. The nominated person should hold or have held a valid flight crew licence and the associated ratings appropriate to a type of operation conducted under the AOC. In case the nominated person's licence and ratings are not current, his/her deputy should hold a valid flight crew licence and the associated ratings.
- (d) Crew training. The nominated person or his/her deputy should be a current type rating instructor on a type/class operated under the AOC. The nominated person should have a thorough knowledge of the AOC holder's crew training concept for flight, cabin and when relevant other crew.
- (e) Ground operations. The nominated person should have a thorough knowledge of the AOC holder's ground operations concept.
- (f) Continuing airworthiness. The nominated person for continuing airworthiness or for the continuing airworthiness management contract, as the case may be, should have the relevant knowledge, background and experience in accordance with [Regulation \(EU\) No 1321/2014](#). If a continuing airworthiness management organisation (CAMO) is contracted by the operator pursuant to point M.A.201(ea) of Annex I (Part-M) to [Regulation \(EU\) No 1321/2014](#), please refer to [AMC1 ORO.AOC.135\(a\)\(4\)](#).

GM1 ORO.AOC.135(a)(4) Personnel requirements

ED Decision 2022/017/R

NOMINATED PERSON RESPONSIBLE FOR THE MANAGEMENT AND SUPERVISION OF THE CONTRACT WITH A CAMO PURSUANT TO POINT M.A.201(ea)

If the operator concludes a contract with a CAMO pursuant to point M.A.201(ea) of Annex I (Part-M) to [Regulation \(EU\) No 1321/2014](#), the person nominated by the operator in accordance with point [ORO.AOC.135\(a\)\(4\)](#) is responsible for ensuring that both the operator and CAMO fulfil their obligations as specified in the contract (which is established in accordance with Appendix I to Part-M). In the particular context of a single air carrier business grouping, that person is expected to apply critical thinking, to be impartial, and not complacent about the fact that the CAMO belongs to that business grouping.

ORO.AOC.140 Facility requirements

Regulation (EU) No 965/2012

In accordance with [ORO.GEN.215](#), the operator shall:

- (a) make use of appropriate ground handling facilities to ensure the safe handling of its flights;
- (b) arrange operational support facilities at the main operating base, appropriate for the area and type of operation; and
- (c) ensure that the available working space at each operating base is sufficient for personnel whose actions may affect the safety of flight operations. Consideration shall be given to the needs of ground crew, personnel concerned with operational control, the storage and display of essential records and flight planning by crews.

GM1 ORO.AOC.140(b);(c) Facility requirements

ED Decision 2014/017/R

VFR DAY OPERATIONS WITH AEROPLANES WITH A MOPSC OF LESS THAN 7 AND HELICOPTERS WITH A MOPSC OF LESS THAN 5 TAKING OFF AND LANDING AT THE SAME AERODROME OR OPERATING SITE

Taking into account the size of the operator and the type of operations, appropriate facilities may consist in arrangements for:

- (a) suitable office accommodation for the nominated person(s), as requested by [ORO.AOC.135](#), and
- (b) adequate working space for the flight preparation to be performed by the flight crew.

ORO.AOC.150 Documentation requirements

Regulation (EU) No 965/2012

- (a) The operator shall make arrangements for the production of manuals and any other documentation required and associated amendments.
- (b) The operator shall be capable of distributing operational instructions and other information without delay.

SUBPART DEC: DECLARATION

ORO.DEC.100 Declaration

Regulation (EU) No 379/2014

The operator of complex motor-powered aircraft engaged in non-commercial operations or non-commercial specialised operations, and the commercial specialised operator shall:

- (a) provide the competent authority with all relevant information prior to commencing operations, using the form contained in [Appendix I](#) to this Annex;
- (b) notify to the competent authority a list of the alternative means of compliance used;
- (c) maintain compliance with the applicable requirements and with the information given in the declaration;
- (d) notify the competent authority without delay of any changes to its declaration or the means of compliance it uses through submission of an amended declaration using the form contained in [Appendix I](#) to this Annex; and
- (e) notify the competent authority when it ceases operation.

GM1 ORO.DEC.100 Declaration

ED Decision 2014/017/R

GENERAL

The intent of the declaration is to:

- (a) have the operator acknowledge its responsibilities under the applicable safety regulations and that it holds all necessary approvals;
- (b) inform the competent authority of the existence of an operator; and
- (c) enable the competent authority to fulfil its oversight responsibilities in accordance with [ARO.GEN.300](#) and 305.

MANAGED OPERATIONS

When the non-commercial operation of a complex motor-powered aircraft is managed by a third party on behalf of the owner, that party may be the operator in the sense of Article 3(h) of Regulation (EC) No 216/2008, and therefore has to declare its capability and means to discharge the responsibilities associated with the operation of the aircraft to the competent authority.

In such a case, it should also be assessed whether the third party operator undertakes a commercial operation in the sense of Article 3(i) of Regulation (EC) 216/2008.

AMC1 ORO.DEC.100(a);(d) Declaration

ED Decision 2022/012/R

RELEVANT INFORMATION PRIOR TO COMMENCING OPERATION, AND NOTIFICATION OF ANY CHANGES TO DECLARATION — EFVS 200 OPERATIONS

Declarations involving EFVS 200 operations (under [NCC.OP.235](#) or [SPO.OP.235](#)) should be submitted at least 60 days before the new declaration or any change becomes effective, and indicate the date as of which they would apply.

GM1 ORO.DEC.100(a);(d) Declaration

ED Decision 2022/012/R

RELEVANT INFORMATION PRIOR TO COMMENCING OPERATION, AND NOTIFICATION OF ANY CHANGES TO DECLARATION — EFVS 200 OPERATIONS

- (a) When a declaration involves EFVS 200 operations in accordance with [NCC.OP.235](#) or [SPO.OP.235](#), the competent authority should be enabled to fulfil its responsibilities in accordance with [ARO.GEN.345](#) prior to starting these operations or implementing changes to such EFVS 200 operations.
- (b) In accordance with [ORO.DEC.100](#) points (a) and (d), the operator shall provide all relevant information and notify any changes. In relation to EFVS 200, this may be but is not limited to:
- (1) AFM or additional data from the TC/STC holder;
 - (2) established relevant aerodrome operating minima;
 - (3) documented operating procedures;
 - (4) training and checking programmes;
 - (5) minimum equipment list (MEL) for the operations to be undertaken; and
 - (6) processes to ensure that only runways and instrument procedures suitable for the intended operations are used.

AMC1 ORO.DEC.100(d) Declaration

ED Decision 2014/017/R

CHANGES

The new declaration should be submitted before the change becomes effective indicating the date as of which the change would apply.

SUBPART SPO: COMMERCIAL SPECIALISED OPERATIONS

ORO.SPO.100 Common requirements for commercial specialised operators

Regulation (EU) 2019/1384

- (a) A commercial specialised operator shall in addition to [ORO.DEC.100](#) also comply with [ORO.AOC.135](#), [ORO.AOC.140](#) and [ORO.AOC.150](#).
- (b) Aircraft shall have a certificate of airworthiness (CofA) in accordance with Regulation (EU) No 748/2012 or shall be leased-in in accordance with (c).
- (c) A commercial specialised operator shall obtain prior approval of the competent authority and comply with the following conditions:
 - (1) for wet leasing-in an aircraft of a third-country operator:
 - (i) that the safety standards of a third-country operator with regard to continuing airworthiness and air operations are equivalent to the applicable requirements established by Regulation (EU) No 1321/2014¹ and this Regulation;
 - (ii) that the aircraft of a third-country operator has a standard CofA issued in accordance with Annex 8 to the Convention on International Civil Aviation;
 - (iii) that the duration of the wet lease-in does not exceed seven months in any 12 consecutive month period;
 - (2) for dry leasing-in an aircraft registered in a third country:
 - (i) that an operational need that cannot be satisfied through leasing an aircraft registered in the Union has been identified;
 - (ii) that the duration of the dry lease-in does not exceed seven months in any 12 consecutive month period;
 - (iii) that the safety standards of the third-country aircraft with regard to continuing airworthiness are equivalent to the applicable requirements established by Regulation (EU) No 1321/2014;
 - (iv) that the aircraft is equipped in accordance with Annex VIII (Part SPO).

AMC1 ORO.SPO.100(a) Personnel requirements

ED Decision 2014/017/R

NOMINATED PERSONS

- (a) The person may hold more than one of the nominated posts if such an arrangement is considered suitable and properly matched to the scale and scope of the commercial specialised operation.
- (b) A description of the functions and the responsibilities of the nominated persons, including their names, should be contained in the operations manual.

¹ Commission Regulation (EU) No 1321/2014 of 26 November 2014 on the continuing airworthiness of aircraft and aeronautical products, parts and appliances, and on the approval of organisations and personnel involved in these tasks (OJ L 362, 17.12.2014, p. 1).

- (c) A commercial specialised operator should make arrangements to ensure continuity of supervision in the absence of nominated persons.
- (d) The person nominated by a commercial specialised operator should normally not be nominated by another commercial specialised operator.
- (e) Persons nominated should be contracted to work sufficient hours to fulfil the management functions associated with the scale and scope of the commercial specialised operation.

AMC2 ORO.SPO.100(a) Personnel requirements

ED Decision 2014/017/R

COMBINATION OF NOMINATED PERSONS RESPONSIBILITIES

- (a) The acceptability of a single person holding several posts, possibly in combination with being the accountable manager, should depend upon the nature and scale of the commercial specialised operation. The two main areas of concern should be competence and an individual's capacity to meet his/her responsibilities.
- (b) As regards competence in different areas of responsibility, there should not be any difference from the requirements applicable to persons holding only one post.
- (c) The capacity of an individual to meet his/her responsibilities should primarily be dependent upon the scale of the commercial specialised operation. However, the complexity of the organisation or of the operation may prevent, or limit, combinations of posts which may be acceptable in other circumstances.
- (d) In most circumstances, the responsibilities of a nominated person should rest with a single individual. However, in the area of ground operations, it may be acceptable for responsibilities to be split, provided that the responsibilities of each individual concerned are clearly defined.

GM1 ORO.SPO.100(a) Personnel requirements

ED Decision 2014/017/R

NOMINATED PERSONS

The smallest organisation that can be considered is the one-man organisation where all of the nominated posts are filled by the accountable manager, and audits are conducted by an independent person.

GM2 ORO.SPO.100(a) Personnel requirements

ED Decision 2014/017/R

COMPETENCE OF NOMINATED PERSONS

- (a) Nominated persons in accordance with [ORO.AOC.135](#) should normally be expected to possess the experience and meet the licensing provisions that are listed in (b) to (f). There may be exceptional cases where not all of the provisions can be met. In that circumstance, the nominee should have comparable experience and also the ability to perform effectively the functions associated with the post and with the scale of the specialised operation.
- (b) Nominated persons should have:
 - (1) practical experience and expertise in the application of aviation safety standards and safe operating practices;

- (2) comprehensive knowledge of:
 - (i) the applicable EU safety regulations and any associated requirements and procedures;
 - (ii) the operator's high-risk specialised operation authorisation, if applicable; and
 - (iii) the need for, and content of, the relevant parts of the commercial specialised operator's operations manual;
 - (3) familiarity with management systems preferably in the area of aviation;
 - (4) appropriate management experience, preferably in a comparable organisation; and
 - (5) 5 years of relevant work experience of which at least 2 years should be from the aeronautical industry in an appropriate position.
- (c) Flight operations. The nominated person should hold or have held a valid flight crew licence and the associated ratings appropriate to the type of commercial specialised operations conducted by the operator. In case the nominated person's licence and ratings are not current, his/her deputy should hold a valid flight crew licence and the associated ratings.
- (d) Crew training. The nominated person or his/her deputy should be a current type rating instructor on a type/class operated by the commercial specialised operator. The nominated person should have a thorough knowledge of the operator's crew training concept for flight crew and when relevant other crew.
- (e) Ground operations. The nominated person should have a thorough knowledge of the commercial specialised operator's ground operations concept.
- (f) Continuing airworthiness. The nominated person should have the relevant knowledge and appropriate experience requirements related to aircraft continuing airworthiness as detailed in Part-M¹.

AMC1 ORO.SPO.100(c) Common requirements for commercial specialised operators

ED Decision 2012/017/R

LEASING OF THIRD COUNTRY OPERATOR OR AIRCRAFT — INFORMATION TO BE PROVIDED TO THE COMPETENT AUTHORITY

The operator intending to lease-in an aircraft or operator should provide the competent authority with the following information:

- (a) the aircraft type, registration markings and serial number;
- (b) the name and address of the registered owner;
- (c) a copy of the valid certificate of airworthiness;
- (d) a copy of the lease agreement or description of the lease provisions, except financial arrangements;
- (e) duration of the lease.

¹ Commission Regulation (EC) No 2042/2003 of 20 November 2003 on the continuing airworthiness of aircraft and aeronautical products, parts and appliances, and on the approval of organisations and personnel involved in these tasks (OJ L 315, 28.11.2003, p. 1). Regulation as last amended by Commission Regulation (EU) No 1149/2011 of 21 October 2011 (OJ L 298, 16.11.2011, p. 1).

The information mentioned above should be accompanied by a statement signed by the lessee that the parties to the lease agreement fully understand their respective responsibilities under the applicable regulations.

GM1 ORO.SPO.100(c) Common requirements for commercial specialised operators

ED Decision 2014/017/R

LEASE AGREEMENTS BETWEEN OPERATORS REGISTERED IN AN EU MEMBER STATE

No approval is required for any lease agreements between operators having their principle place of business in an EU Member State.

AMC1 ORO.SPO.100(c)(1) Common requirements for commercial specialised operators

ED Decision 2014/017/R

WET LEASE-IN OF AN AIRCRAFT REGISTERED IN A THIRD COUNTRY

If the operator is not intending to apply EU safety requirements for air operations and continuing airworthiness when wet leasing-in an aircraft registered in a third country, it should demonstrate to the competent authority that the standards complied with are equivalent to the following requirements:

- (a) Annex VIII (Part-SPO);
- (b) Part-ORO:
 - (1) [ORO.GEN.110](#) and Section 2 of Subpart GEN;
 - (2) ORO.MLR, excluding [ORO.MLR.105](#);
 - (3) ORO.FC;
- (c) Annex V (Part-SPA), if applicable;
- (d) for continuing airworthiness management of the third country operator, Part-M¹ Subpart-B, Subpart-C and Subpart-G, excluding M.A.707, and M.A.710;
- (e) for the maintenance organisation used by the third country operator during the lease period: Part-145²; and
- (f) the operator should provide the competent authority with a full description of the operating procedures and safety assessment demonstrating compliance with the requirements safety objectives set out in points (b) (1)-(3).

¹ Commission Regulation (EC) No 2042/2003 of 20 November 2003 on the continuing airworthiness of aircraft and aeronautical products, parts and appliances, and on the approval of organisations and personnel involved in these tasks (OJ L 315, 28.11.2003, p. 1). Regulation as last amended by Commission Regulation (EU) No 1149/2011 of 21 October 2011 (OJ L 298, 16.11.2011, p. 1).

² Commission Regulation (EC) No 2042/2003 of 20 November 2003 on the continuing airworthiness of aircraft and aeronautical products, parts and appliances, and on the approval of organisations and personnel involved in these tasks (OJ L 315, 28.11.2003, p. 1). Regulation as last amended by Commission Regulation (EU) No 1149/2011 of 21 October 2011 (OJ L 298, 16.11.2011, p. 1).

AMC2 ORO.SPO.100(c)(1) Common requirements for commercial specialised operators

ED Decision 2014/017/R

WET LEASE-IN

The lessee should maintain a record of occasions when lessors are used, for inspection by the competent authority.

GM1 ORO.SPO.100(c)(1) Common requirements for commercial specialised operators

ED Decision 2014/017/R

SHORT-TERM WET LEASE-IN

In anticipation of an operational need the operator may enter into a framework agreement with more than one third country operator provided that these operators comply with [ORO.SPO.110\(c\)](#). These third country operators should be placed in a list maintained by the lessee.

ORO.SPO.110 Authorisation of high risk commercial specialised operations

Regulation (EU) No 379/2014

- (a) A commercial specialised operator shall apply for and obtain an authorisation issued by the competent authority of the operator prior to commencing a high risk commercial specialised operation:
- (1) that is carried out over an area where the safety of third parties on the ground is likely to be endangered in the event of an emergency, or
 - (2) that, as determined by the competent authority of the place where the operation is conducted, due to its specific nature and the local environment in which it is conducted, poses a high risk, in particular to third parties on the ground.
- (b) The operator shall provide the following information to the competent authority:
- (1) the official name and business name, address, and mailing address of the applicant;
 - (2) a description of the management system, including organisational structure;
 - (3) a description of the proposed operation, including the type(s), and number of aircraft to be operated;
 - (4) the risk assessment documentation and related standard operating procedures, required by [SPO.OP.230](#);
 - (5) a statement that all the documentation sent to the competent authority has been verified by the operator and found in compliance with the applicable requirements.
- (c) The application for an authorisation or its amendment shall be made in a form and manner established by the competent authority, taking into account the applicable requirements of Regulation (EC) No 216/2008 and its Implementing Rules.

GM1 ORO.SPO.110(a) Authorisation of high-risk commercial specialised operations

ED Decision 2014/017/R

DECLARATION/AUTHORISATION

Any commercial specialised operator should declare its activity to its competent authority, as required by [ORO.DEC.100](#).

GM2 ORO.SPO.110(a) Authorisation of high-risk commercial specialised operations

ED Decision 2014/017/R

VALIDITY OF THE AUTHORISATION

The operator may submit an application to its competent authority for a single event, a defined series of flights or for an unlimited duration, depending on the type of operations foreseen.

ORO.SPO.115 Changes

Regulation (EU) No 379/2014

- (a) Any change affecting the scope of the authorisation or the authorised operations shall require prior approval of the competent authority. Any change not covered by the initial risk assessment, shall require the submission of an amended risk assessment and SOP to the competent authority.
- (b) The application for approval of a change shall be submitted before any such change takes place, in order to enable the competent authority to determine continued compliance with Regulation (EC) No 216/2008 and its Implementing Rules and to amend, if necessary, the authorisation. The operator shall provide the competent authority with any relevant documentation.
- (c) The change shall only be implemented upon receipt of formal approval by the competent authority in accordance with [ARO.OPS.150](#).
- (d) The operator shall operate under the conditions prescribed by the competent authority during such changes, as applicable.

GM1 ORO.SPO.115(a) Changes

ED Decision 2014/017/R

GENERAL

Any change to information contained in the authorisation, but not leading to an amendment of the SOPs or the operator's risk assessment should be notified by the commercial specialised operator to its competent authority which should amend the authorisation.

ORO.SPO.120 Continued validity

Regulation (EU) No 379/2014

- (a) An operator holding a specialised operation authorisation shall comply with the scope and privileges defined in the authorisation.

- (b) The operator's authorisation shall remain valid subject to:
- (1) the operator remaining in compliance with the relevant requirements of Regulation (EC) No 216/2008 and its Implementing Rules, taking into account the provisions related to the handling of findings as specified under [ORO.GEN.150](#);
 - (2) the competent authority being granted access to the operator as defined in [ORO.GEN.140](#) to determine continued compliance with the relevant requirements of Regulation (EC) No 216/2008 and its Implementing Rules; and
 - (3) the authorisation not being surrendered or revoked.
- (c) Upon revocation or surrender the authorisation shall be returned to the competent authority without delay.

SUBPART MLR: MANUALS, LOGS AND RECORDS

ORO.MLR.100 Operations manual – general

Regulation (EU) No 379/2014

- (a) The operator shall establish an operations manual (OM) as specified under 8.b of Annex IV to Regulation (EC) No 216/2008.
- (b) The content of the OM shall reflect the requirements set out in this Annex, Annex IV (Part-CAT), Annex V (Part-SPA), Annex VI (Part-NCC) and Annex VIII (Part-SPO), as applicable, and shall not contravene the conditions contained in the operations specifications to the air operator certificate (AOC), the SPO authorisation or the declaration and the list of specific approvals, as applicable.
- (c) The OM may be issued in separate parts.
- (d) All operations personnel shall have easy access to the portions of the OM that are relevant to their duties.
- (e) The OM shall be kept up to date. All personnel shall be made aware of the changes that are relevant to their duties.
- (f) Each crew member shall be provided with a personal copy of the relevant sections of the OM pertaining to their duties. Each holder of an OM, or appropriate parts of it, shall be responsible for keeping their copy up to date with the amendments or revisions supplied by the operator.
- (g) For AOC holders:
 - (1) for amendments required to be notified in accordance with [ORO.GEN.115\(b\)](#) and [ORO.GEN.130\(c\)](#), the operator shall supply the competent authority with intended amendments in advance of the effective date; and
 - (2) for amendments to procedures associated with prior approval items in accordance with [ORO.GEN.130](#), approval shall be obtained before the amendment becomes effective.
- (g1) For SPO authorisation holders, any amendment associated with the authorised standard operating procedures, prior approval shall be obtained before the amendment becomes effective.
- (h) Notwithstanding (g) and (g1), when immediate amendments or revisions are required in the interest of safety, they may be published and applied immediately, provided that any approval required has been applied for.
- (i) The operator shall incorporate all amendments and revisions required by the competent authority.
- (j) The operator shall ensure that information taken from approved documents, and any amendment thereof, is correctly reflected in the OM. This does not prevent the operator from publishing more conservative data and procedures in the OM.
- (k) The operator shall ensure that all personnel are able to understand the language in which those parts of the OM which pertain to their duties and responsibilities are written. The content of the OM shall be presented in a form that can be used without difficulty and observes human factors principles.

AMC1 ORO.MLR.100 Operations manual – general

ED Decision 2014/017/R

GENERAL

- (a) The operations manual (OM) may vary in detail according to the complexity of the operation and of the type and number of aircraft operated.
- (b) The OM or parts thereof may be presented in any form, including electronic form. In all cases, the accessibility, usability and reliability should be assured.
- (c) The OM should be such that:
 - (1) all parts of the manual are consistent and compatible in form and content;
 - (2) the manual can be readily amended; and
 - (3) the content and amendment status of the manual is controlled and clearly indicated.
- (d) The OM should include a description of its amendment and revision process specifying:
 - (1) the person(s) who may approve amendments or revisions;
 - (2) the conditions for temporary revisions and/or immediate amendments or revision required in the interest of safety; and
 - (3) the methods by which operator personnel are advised of the changes.
- (e) The OM content may be based on, or may refer to, industry codes of practice.
- (f) When compiling an OM, the operator may take advantage of the contents of other relevant documents. Material produced by the operator for the type-related part of the OM may be supplemented with, or substituted by, applicable parts of the aircraft flight manual (AFM) or, where such a document exists, by an aircraft operating manual produced by the manufacturer of the aircraft.
- (g) In the case of commercial operations with other-than-complex motor-powered aircraft or non-commercial operations, a 'pilot operating handbook' (POH), or equivalent document, may be used as the type-related part of the OM, provided that the POH covers the normal and abnormal/emergency operating procedures.
- (h) For the route and aerodrome part of the OM, material produced by the operator may be supplemented with or substituted by applicable route guide material produced by a specialist company.
- (i) If the operator chooses to use material from another source in the OM, either the applicable material should be copied and included directly in the relevant part of the OM, or the OM should contain a reference to the appropriate section of that applicable material.
- (j) If the operator chooses to make use of material from another source (e.g. a route manual producer, an aircraft manufacturer or a training organisation), this does not absolve the operator from the responsibility of verifying the applicability and suitability of this material. Any material received from an external source should be given its status by a statement in the OM.

AMC2 ORO.MLR.100 Operations manual – General

ED Decision 2017/007/R

CONTENTS OF THE OPERATIONS MANUAL FOR CERTAIN TYPES OF OPERATION

For non-commercial operations with complex motor-powered aircraft, or CAT operations with either single-engined propeller-driven aeroplanes with an MOPSC of 5 or less, or single-engined non-complex helicopters with an MOPSC of 5 or less, taking off and landing at the same aerodrome or operating site, under VFR by day, the OM should contain at least the following information, where applicable:

- (a) Table of contents;
- (b) Amendment control status and list of effective pages or paragraphs, unless the entire manual is re-issued and the manual has an effective date on it;
- (c) Duties, responsibilities and succession of management and operating personnel;
- (d) Description of the management system;
- (e) Operational control system;
- (f) Flight time limitations;
- (g) Standard operating procedures (SOPs);
- (h) Weather limitations;
- (i) Emergency procedures;
- (j) Accidents/incidents considerations;
- (k) Security procedures;
- (l) Minimum equipment list (MEL);
- (m) Personnel qualifications and training;
- (n) Record-keeping;
- (o) Normal flight operations;
- (p) Performance operating limitations;
- (q) Procedures for the preservation of recordings of the flight recorders in order to prevent inadvertent reactivation, repair or reinstallation of the flight recorders following an accident or a serious incident or when this preservation is directed by the investigating authority;
- (r) Handling of dangerous goods.

AMC3 ORO.MLR.100 Operations manual – general

ED Decision 2022/005/R

CONTENTS — CAT OPERATIONS

- (a) The OM should contain at least the following information, where applicable, as relevant for the area and type of operation:

A GENERAL/BASIC**0 ADMINISTRATION AND CONTROL OF THE OPERATIONS MANUAL****0.1 Introduction:**

- (a) A statement that the manual complies with all applicable regulations and with the terms and conditions of the applicable AOC.
- (b) A statement that the manual contains operational instructions that are to be complied with by the relevant personnel.
- (c) A list and brief description of the various parts, their contents, applicability and use.
- (d) Explanations and definitions of terms and words needed for the use of the manual.

0.2 System of amendment and revision:

- (a) Details of the person(s) responsible for the issuance and insertion of amendments and revisions.
- (b) A record of amendments and revisions with insertion dates and effective dates.
- (c) A statement that handwritten amendments and revisions are not permitted, except in situations requiring immediate amendment or revision in the interest of safety.
- (d) A description of the system for the annotation of pages or paragraphs and their effective dates.
- (e) A list of effective pages or paragraphs.
- (f) Annotation of changes (in the text and, as far as practicable, on charts and diagrams).
- (g) Temporary revisions.
- (h) A description of the distribution system for the manuals, amendments and revisions.

1 ORGANISATION AND RESPONSIBILITIES

1.1 Organisational structure. A description of the organisational structure, including the general organogram and operations departments' organograms. The organogram should depict the relationship between the operations departments and the other departments of the operator. In particular, the subordination and reporting lines of all divisions, departments, etc., which pertain to the safety of flight operations, should be shown.

1.2 Nominated persons. The name of each nominated person responsible for flight operations, crew training and ground operations, as prescribed in [ORO.AOC.135](#). A description of their function and responsibilities should be included.

1.3 Responsibilities and duties of operations management personnel. A description of the duties, responsibilities and authority of operations

management personnel pertaining to the safety of flight operations and the compliance with the applicable regulations.

- 1.4 Authority, duties and responsibilities of the pilot-in-command/commander. A statement defining the authority, duties and responsibilities of the pilot-in-command/commander.
- 1.5 Duties and responsibilities of crew members other than the pilot-in-command/commander.

2 OPERATIONAL CONTROL AND SUPERVISION

2.1 Supervision of the operation by the operator. A description of the system for supervision of the operation by the operator (see [ORO.GEN.110\(c\)](#)). This should show how the safety of flight operations and the qualifications of personnel are supervised. In particular, the procedures related to the following items should be described:

- (a) licence and qualification validity,
- (b) competence of operations personnel,
- (c) control, analysis and storage of the required records.

2.2 System and responsibility for promulgation of additional operational instructions and information. A description of any system for promulgating information which may be of an operational nature, but which is supplementary to that in the OM. The applicability of this information and the responsibilities for its promulgation should be included.

2.3 Operational control. A description of the procedures and responsibilities necessary to exercise operational control with respect to flight safety.

2.4 Powers of the authority. A description of the powers of the competent authority and guidance to staff on how to facilitate inspections by authority personnel.

3 MANAGEMENT SYSTEM

A description of the management system, including at least the following:

- (a) safety policy;
- (b) the process for identifying safety hazards and for evaluating and managing the associated risks;
- (c) compliance monitoring system;
- (d) allocation of duties and responsibilities;
- (e) documentation of all key management system processes.

4 CREW COMPOSITION

4.1 Crew composition. An explanation of the method for determining crew compositions, taking account of the following:

- (a) the type of aircraft being used;
- (b) the area and type of operation being undertaken;
- (c) the phase of the flight;

- (d) the minimum crew requirement and flight duty period planned;
 - (e) experience (total and on type), recency and qualification of the crew members;
 - (f) the designation of the pilot-in-command/commander and, if necessitated by the duration of the flight, the procedures for the relief of the pilot-in-command/commander or other members of the flight crew (see [ORO.FC.105](#));
 - (g) the designation of the senior cabin crew member and, if necessitated by the duration of the flight, the procedures for the relief of the senior cabin crew member and any other member of the cabin crew.
- 4.2 Designation of the pilot-in-command/commander. The rules applicable to the designation of the pilot-in-command/commander.
- 4.3 Flight crew incapacitation. Instructions on the succession of command in the event of flight crew incapacitation.
- 4.4 Operation on more than one type. A statement indicating which aircraft are considered as one type for the purpose of:
- (a) flight crew scheduling; and
 - (b) cabin crew scheduling.
- 5 QUALIFICATION REQUIREMENTS
- 5.1 A description of the required licence, rating(s), qualification/competency (e.g. for routes and aerodromes), experience, training, checking and recency for operations personnel to conduct their duties. Consideration should be given to the aircraft type, kind of operation and composition of the crew.
- 5.2 Flight crew:
- (a) pilot-in-command/commander,
 - (b) pilot relieving the pilot-in-command/commander,
 - (c) co-pilot,
 - (d) pilot relieving the co-pilot,
 - (e) pilot under supervision,
 - (f) system panel operator,
 - (g) operation on more than one type or variant.
- 5.3 Cabin crew:
- (a) senior cabin crew member,
 - (b) cabin crew member:
 - (i) required cabin crew member,
 - (ii) additional cabin crew member and cabin crew member during familiarisation flights,
 - (c) operation on more than one type or variant.

-
- 5.4 Training, checking and supervision personnel:
- (a) for flight crew; and
 - (b) for cabin crew.
- 5.5 Other operations personnel (including technical crew and crew members other than flight, cabin and technical crew).
- 6 CREW HEALTH PRECAUTIONS
- 6.1 Crew health precautions. The relevant regulations and guidance to crew members concerning health, including the following:
- (a) alcohol and other intoxicating liquids,
 - (b) narcotics,
 - (c) drugs,
 - (d) sleeping tablets,
 - (e) anti-depressants,
 - (f) pharmaceutical preparations,
 - (g) immunisation,
 - (h) deep-sea diving,
 - (i) blood/bone marrow donation,
 - (j) meal precautions prior to and during flight,
 - (k) sleep and rest,
 - (l) surgical operations.
- 7 FLIGHT TIME LIMITATIONS
- 7.1 Flight and duty time limitations and rest requirements.
- 7.2 Exceedance of flight and duty time limitations and/or reductions of rest periods. Conditions under which flight and duty time may be exceeded or rest periods may be reduced, and the procedures used to report these modifications.
- 7.3 A description of the fatigue risk management, including at least the following:
- (a) the philosophy and principles;
 - (b) documentation of processes;
 - (c) scientific principles and knowledge;
 - (d) hazard identification and risk assessment processes;
 - (e) risk mitigation process;
 - (f) FRM safety assurance processes; and
 - (g) FRM promotion processes.

8 OPERATING PROCEDURES

8.1 Flight preparation instructions. As applicable to the operation:

8.1.1 Minimum flight altitudes. A description of the method of determination and application of minimum altitudes including:

- (a) a procedure to establish the minimum altitudes/flight levels for visual flight rules (VFR) flights; and
- (b) a procedure to establish the minimum altitudes/flight levels for instrument flight rules (IFR) flights.

8.1.2 Criteria and responsibilities for determining the adequacy of aerodromes to be used.

8.1.3 Methods and responsibilities for establishing aerodrome operating minima. Reference should be made to procedures for the determination of the visibility and/or runway visual range (RVR) and for the applicability of the actual visibility observed by the pilots, the reported visibility and the reported RVR.

8.1.4 En-route operating minima for VFR flights or VFR portions of a flight and, where single-engined aircraft are used, instructions for route selection with respect to the availability of surfaces that permit a safe forced landing.

8.1.5 Presentation and application of aerodrome and en-route operating minima.

8.1.6 Interpretation of meteorological information. Explanatory material on the decoding of meteorological (MET) forecasts and MET reports relevant to the area of operations, including the interpretation of conditional expressions.

8.1.7 Determination of the quantities of fuel, oil and water methanol carried. The methods by which the quantities of fuel, oil and water methanol to be carried are determined and monitored in-flight. This section should also include instructions on the measurement and distribution of the fluid carried on board. Such instructions should take account of all circumstances likely to be encountered on the flight, including the possibility of in-flight re-planning and of failure of one or more of the aircraft's power plants. The system for maintaining fuel and oil records should also be described.

8.1.8 Mass and centre of gravity. The general principles of mass and centre of gravity including the following:

- (a) definitions;
- (b) methods, procedures and responsibilities for preparation and acceptance of mass and centre of gravity calculations;
- (c) the policy for using standard and/or actual masses;
- (d) the method for determining the applicable passenger, baggage and cargo mass;

- (e) the applicable passenger and baggage masses for various types of operations and aircraft type;
 - (f) general instructions and information necessary for verification of the various types of mass and balance documentation in use;
 - (g) last-minute changes procedures;
 - (h) specific gravity of fuel, oil and water methanol;
 - (i) seating policy/procedures;
 - (j) for helicopter operations, standard load plans.
- 8.1.9 Air traffic services (ATS) flight plan. Procedures and responsibilities for the preparation and submission of the ATS flight plan. Factors to be considered include the means of submission for both individual and repetitive flight plans.
- 8.1.10 Operational flight plan. Procedures and responsibilities for the preparation and acceptance of the operational flight plan. The use of the operational flight plan should be described, including samples of the operational flight plan formats in use.
- 8.1.11 Operator's aircraft technical log. The responsibilities and the use of the operator's aircraft technical log should be described, including samples of the format used.
- 8.1.12 List of documents, forms and additional information to be carried.
- 8.1.13 For commercial air transport operations with single-engined turbine aeroplanes in instrument meteorological conditions or at night (CAT SET-IMC) approved in accordance with Subpart L (SET-IMC) of Annex V (Part-SPA) to Regulation (EU) No 965/2012:
- (a) the procedure for route selection with respect to the availability of surfaces, which permits a safe forced landing;
 - (b) the instructions for the assessment of landing sites (elevation, landing direction, and obstacles in the area); and
 - (c) the instructions for the assessment of the weather conditions at those landing sites.
- 8.2 Ground handling instructions. As applicable to the operation:
- 8.2.1 Fuelling procedures. A description of fuelling procedures, including:
- (a) safety precautions during refuelling and defuelling including when an aircraft auxiliary power unit is in operation or, for helicopters, when rotors are turning or, for aeroplanes, when an engine is running;
 - (b) refuelling and defuelling when passengers are embarking, on board or disembarking; and
 - (c) precautions to be taken to avoid mixing fuels.

8.2.2 Aircraft, passengers and cargo handling procedures related to safety. A description of the handling procedures to be used when allocating seats, embarking and disembarking passengers and when loading and unloading the aircraft. Further procedures, aimed at achieving safety whilst the aircraft is on the ramp, should also be given. Handling procedures should include:

- (a) special categories of passengers, including children/infants, persons with reduced mobility, inadmissible passengers, deportees and persons in custody;
- (b) permissible size and weight of hand baggage;
- (c) loading and securing of items in the aircraft;
- (d) positioning of ground equipment;
- (e) operation of aircraft doors;
- (f) safety on the aerodrome/operating site, including fire prevention and safety in blast and suction areas;
- (g) start-up, ramp departure and arrival procedures, including, for aeroplanes, push-back and towing operations;
- (h) servicing of aircraft;
- (i) documents and forms for aircraft handling;
- (j) special loads and classification of load compartments; and
- (k) multiple occupancy of aircraft seats.

8.2.3 Procedures for the refusal of embarkation. Procedures to ensure that persons who appear to be intoxicated, or who demonstrate by manner or physical indications that they are under the influence of drugs, are refused embarkation. This does not apply to medical patients under proper care.

8.2.4 De-icing and anti-icing on the ground. A description of the de-icing and anti-icing policy and procedures for aircraft on the ground. These should include descriptions of the types and effects of icing and other contaminants on aircraft whilst stationary, during ground movements and during take-off. In addition, a description of the fluid types used should be given, including the following:

- (a) proprietary or commercial names,
- (b) characteristics,
- (c) effects on aircraft performance,
- (d) hold-over times,
- (e) precautions during usage.

8.3 Flight Procedures:

8.3.1 VFR/IFR Policy. A description of the policy for allowing flights to be made under VFR, or for requiring flights to be made under IFR, or for changing from one to the other.

- 8.3.2 Navigation Procedures. A description of all navigation procedures, relevant to the type(s) and area(s) of operation. Special consideration should be given to:
- (a) standard navigational procedures, including policy for carrying out independent cross-checks of keyboard entries where these affect the flight path to be followed by the aircraft; and
 - (b) required navigation performance (RNP), minimum navigation performance specification (MNPS) and polar navigation and navigation in other designated areas;
 - (c) in-flight re-planning;
 - (d) procedures in the event of system degradation; and
 - (e) reduced vertical separation minima (RVSM), for aeroplanes.
- 8.3.3 Altimeter setting procedures, including, where appropriate, use of:
- (a) metric altimetry and conversion tables; and
 - (b) QFE operating procedures.
- 8.3.4 Altitude alerting system procedures for aeroplanes or audio voice alerting devices for helicopters.
- 8.3.5 Ground proximity warning system (GPWS)/terrain avoidance warning system (TAWS), for aeroplanes. Procedures and instructions required for the avoidance of controlled flight into terrain, including limitations on high rate of descent near the surface (the related training requirements are covered in OM-D 2.1).
- 8.3.6 Policy and procedures for the use of traffic collision avoidance system (TCAS)/airborne collision avoidance system (ACAS) for aeroplanes and, when applicable, for helicopters.
- 8.3.7 Policy and procedures for in-flight fuel management.
- 8.3.8 Adverse and potentially hazardous atmospheric conditions. Procedures for operating in, and/or avoiding, adverse and potentially hazardous atmospheric conditions, including the following:
- (a) thunderstorms,
 - (b) icing conditions,
 - (c) turbulence,
 - (d) windshear,
 - (e) jet stream,
 - (f) volcanic ash clouds,
 - (g) heavy precipitation,
 - (h) sand storms,
 - (i) mountain waves,
 - (j) significant temperature inversions.

- 8.3.9 Wake turbulence. Wake turbulence separation criteria, taking into account aircraft types, wind conditions and runway/final approach and take-off area (FATO) location. For helicopters, consideration should also be given to rotor downwash.
- 8.3.10 Crew members at their stations. The requirements for crew members to occupy their assigned stations or seats during the different phases of flight or whenever deemed necessary in the interest of safety and, for aeroplane operations, including procedures for controlled rest in the flight crew compartment.
- 8.3.11 Use of restraint devices for crew and passengers. The requirements for crew members and passengers to use safety belts and/or restraint systems during the different phases of flight or whenever deemed necessary in the interest of safety.
- 8.3.12 Admission to flight crew compartment. The conditions for the admission to the flight crew compartment of persons other than the flight crew. The policy regarding the admission of inspectors from an authority should also be included.
- 8.3.13 Use of vacant crew seats. The conditions and procedures for the use of vacant crew seats.
- 8.3.14 Incapacitation of crew members. Procedures to be followed in the event of incapacitation of crew members in-flight. Examples of the types of incapacitation and the means for recognising them should be included.
- 8.3.15 Cabin safety requirements. Procedures:
- (a) covering cabin preparation for flight, in-flight requirements and preparation for landing, including procedures for securing the cabin and galleys;
 - (b) to ensure that passengers are seated where, in the event that an emergency evacuation is required, they may best assist and not hinder evacuation from the aircraft;
 - (c) to be followed during passenger embarkation and disembarkation;
 - (d) when refuelling/defuelling with passengers embarking, on board or disembarking;
 - (e) covering the carriage of special categories of passengers;
 - (f) covering smoking on board;
 - (g) covering the handling of suspected infectious diseases.
- 8.3.16 Passenger briefing procedures. The contents, means and timing of passenger briefing in accordance with Annex IV (Part-CAT).
- 8.3.17 Procedures for aircraft operated whenever required cosmic or solar radiation detection equipment is carried.
- 8.3.18 Policy on the use of autopilot and autothrottle for aircraft fitted with these systems.

-
- 8.4 Low visibility operations (LVO). A description of the operational procedures associated with LVO.
- 8.5 Extended-range operations with two-engined aeroplanes (ETOPS). A description of the ETOPS operational procedures. (Refer to EASA AMC 20-6)
- 8.6 Use of the minimum equipment and configuration deviation list(s).
- 8.7 Non-commercial operations. Information as required by [ORO.AOC.125](#) for each type of non-commercial flight performed by the AOC holder. A description of the differences from CAT operations. Procedures and limitations, for example, for the following:
- (a) training flights,
 - (b) flights at the end of lease or upon transfer of ownership,
 - (c) delivery flights,
 - (d) ferry flights,
 - (e) demonstration flights,
 - (f) positioning flights,
 - (g) other non-commercial flights.
- 8.8 Oxygen requirements:
- 8.8.1 An explanation of the conditions under which oxygen should be provided and used.
- 8.8.2 The oxygen requirements specified for the following persons:
- (a) flight crew;
 - (b) cabin crew;
 - (c) passengers.
- 8.9 Procedures related to the use of type B EFB applications.
- 9 DANGEROUS GOODS AND WEAPONS
- 9.1 Information, instructions and general guidance on the transport of dangerous goods, in accordance with Subpart G of Annex V (SPA.DG), including:
- (a) operator's policy on the transport of dangerous goods;
 - (b) guidance on the requirements for acceptance, labelling, handling, stowage and segregation of dangerous goods;
 - (c) special notification requirements in the event of an accident or occurrence when dangerous goods are being carried;
 - (d) procedures for responding to emergency situations involving dangerous goods;
 - (e) duties of all personnel involved; and
 - (f) instructions on the carriage of the operator's personnel on cargo aircraft when dangerous goods are being carried.

9.2 The conditions under which weapons, munitions of war and sporting weapons may be carried.

10 SECURITY

Security instructions, guidance, procedures, training and responsibilities, taking into account Regulation (EC) No 300/2008¹. Some parts of the security instructions and guidance may be kept confidential.

11 HANDLING, NOTIFYING AND REPORTING ACCIDENTS, INCIDENTS AND OCCURRENCES AND USING THE CVR RECORDING

Procedures for handling, notifying and reporting accidents, incidents and occurrences. This section should include the following:

- (a) definition of accident, incident and occurrence and of the relevant responsibilities of all persons involved;
- (b) illustrations of forms to be used for reporting all types of accident, incident and occurrence (or copies of the forms themselves), instructions on how they are to be completed, the addresses to which they should be sent and the time allowed for this to be done;
- (c) in the event of an accident, descriptions of which departments, authorities and other organisations have to be notified, how this will be done and in what sequence;
- (d) procedures for verbal notification to air traffic service units of incidents involving ACAS resolution advisories (RAs), bird hazards, dangerous goods and hazardous conditions;
- (e) procedures for submitting written reports on air traffic incidents, ACAS RAs, bird strikes, dangerous goods incidents or accidents, and unlawful interference;
- (f) reporting procedures. These procedures should include internal safety-related reporting procedures to be followed by crew members, designed to ensure that the pilot-in-command/commander is informed immediately of any incident that has endangered, or may have endangered, safety during the flight, and that the pilot-in-command/commander is provided with all relevant information.
- (g) Procedures for the preservation of recordings of the flight recorders following an accident or a serious incident or when so directed by the investigating authority. These procedures should include:
 - (1) a full quotation of point (a) of [CAT.GEN.MPA.195](#); and
 - (2) instructions and means to prevent inadvertent reactivation, repair or reinstallation of the flight recorders by personnel of the operator or of third parties, and to ensure that flight recorder recordings are preserved for the needs of the investigating authority.

¹ OJ L 97, 11.3.2008, p. 72.

- (h) Procedures required by [CAT.GEN.MPA.195](#) for using the CVR recording or its transcript without prejudice to Regulation (EU) No 996/210, when applicable.

12 RULES OF THE AIR

- (a) Visual and instrument flight rules,
- (b) Territorial application of the rules of the air,
- (c) Communication procedures, including communication-failure procedures,
- (d) Information and instructions relating to the interception of civil aircraft,
- (e) The circumstances in which a radio listening watch is to be maintained,
- (f) Signals,
- (g) Time system used in operation,
- (h) ATC clearances, adherence to flight plan and position reports,
- (i) Visual signals used to warn an unauthorised aircraft flying in or about to enter a restricted, prohibited or danger area,
- (j) Procedures for flight crew observing an accident or receiving a distress transmission,
- (k) The ground/air visual codes for use by survivors, and description and use of signal aids,
- (l) Distress and urgency signals.

13 LEASING/CODE-SHARE

A description of the operational arrangements for leasing and code-share, associated procedures and management responsibilities.

B AIRCRAFT OPERATING MATTERS — TYPE RELATED

Taking account of the differences between types/classes, and variants of types, under the following headings:

0 GENERAL INFORMATION AND UNITS OF MEASUREMENT

- 0.1 General information (e.g. aircraft dimensions), including a description of the units of measurement used for the operation of the aircraft type concerned and conversion tables.

1 LIMITATIONS

- 1.1 A description of the certified limitations and the applicable operational limitations should include the following:
 - (a) certification status (e.g. EASA (supplemental) type certificate, environmental certification, etc.);
 - (b) passenger seating configuration for each aircraft type, including a pictorial presentation;
 - (c) types of operation that are approved (e.g. VFR/IFR, CAT II/III, RNP, flights in known icing conditions, etc.);
 - (d) crew composition;

- (e) mass and centre of gravity;
- (f) speed limitations;
- (g) flight envelope(s);
- (h) wind limits, including operations on contaminated runways;
- (i) performance limitations for applicable configurations;
- (j) (runway) slope;
- (k) for aeroplanes, limitations on wet or contaminated runways;
- (l) airframe contamination;
- (m) system limitations.

2 NORMAL PROCEDURES

The normal procedures and duties assigned to the crew, the appropriate checklists, the system for their use and a statement covering the necessary coordination procedures between flight and cabin/other crew members. The normal procedures and duties should include the following:

- (a) pre-flight,
- (b) pre-departure,
- (c) altimeter setting and checking,
- (d) taxi, take-off and climb,
- (e) noise abatement,
- (f) cruise and descent,
- (g) approach, landing preparation and briefing,
- (h) VFR approach,
- (i) IFR approach,
- (j) visual approach and circling,
- (k) missed approach,
- (l) normal landing,
- (m) post-landing,
- (n) for aeroplanes, operations on wet and contaminated runways.

3 ABNORMAL AND/OR EMERGENCY PROCEDURES

The abnormal and/or emergency procedures and duties assigned to the crew, the appropriate checklists, the system for their use and a statement covering the necessary coordination procedures between flight and cabin/other crew members. The abnormal and/or emergency procedures and duties should include the following:

- (a) crew incapacitation,
- (b) fire and smoke drills,
- (c) for aeroplanes, un-pressurised and partially pressurised flight,

- (d) for aeroplanes, exceeding structural limits such as overweight landing,
- (e) lightning strikes,
- (f) distress communications and alerting ATC to emergencies,
- (g) engine/burner failure,
- (h) system failures,
- (i) guidance for diversion in case of serious technical failure,
- (j) ground proximity warning, including for helicopters audio voice alerting device (AVAD) warning,
- (k) ACAS/TCAS warning for aeroplanes/audio voice alerting device (AVAD) warning for helicopters,
- (l) windshear,
- (m) emergency landing/ditching,
- (n) for aeroplanes, departure contingency procedures.

4 PERFORMANCE

4.0 Performance data should be provided in a form that can be used without difficulty.

4.1 Performance data. Performance material that provides the necessary data for compliance with the performance requirements prescribed in Annex IV (Part-CAT). For aeroplanes, this performance data should be included to allow the determination of the following:

- (a) take-off climb limits — mass, altitude, temperature;
- (b) take-off field length (for dry, wet and contaminated runway conditions);
- (c) net flight path data for obstacle clearance calculation or, where applicable, take-off flight path;
- (d) the gradient losses for banked climb-outs;
- (e) en-route climb limits;
- (f) approach climb limits;
- (g) landing climb limits;
- (h) landing field length (for dry, wet and contaminated runway conditions) including the effects of an in-flight failure of a system or device, if it affects the landing distance;
- (i) brake energy limits;
- (j) speeds applicable for the various flight stages (also considering dry, wet and contaminated runway conditions).

4.1.1 Supplementary data covering flights in icing conditions. Any certified performance related to an allowable configuration, or configuration deviation, such as anti-skid inoperative.

- 4.1.2 If performance data, as required for the appropriate performance class, are not available in the AFM, then other data should be included. The OM may contain cross-reference to the data contained in the AFM where such data are not likely to be used often or in an emergency.
- 4.2 Additional performance data for aeroplanes. Additional performance data, where applicable, including the following:
- (a) all engine climb gradients,
 - (b) drift-down data,
 - (c) effect of de-icing/anti-icing fluids,
 - (d) flight with landing gear down,
 - (e) for aircraft with 3 or more engines, one-engine-inoperative ferry flights,
 - (f) flights conducted under the provisions of the configuration deviation list (CDL).
- 5 FLIGHT PLANNING
- 5.1 Data and instructions necessary for pre-flight and in-flight planning including, for aeroplanes, factors such as speed schedules and power settings. Where applicable, procedures for engine(s)-out operations, ETOPS (particularly the one-engine-inoperative cruise speed and maximum distance to an adequate aerodrome determined in accordance with Annex IV (Part-CAT)) and flights to isolated aerodromes should be included.
- 5.2 The method for calculating fuel needed for the various stages of flight.
- 5.3 When applicable, for aeroplanes, performance data for ETOPS critical fuel reserve and area of operation, including sufficient data to support the critical fuel reserve and area of operation calculation based on approved aircraft performance data. The following data should be included:
- (a) detailed engine(s)-inoperative performance data, including fuel flow for standard and non-standard atmospheric conditions and as a function of airspeed and power setting, where appropriate, covering:
 - (i) drift down (includes net performance), where applicable;
 - (ii) cruise altitude coverage including 10 000 ft;
 - (iii) holding;
 - (iv) altitude capability (includes net performance); and
 - (v) missed approach;
 - (b) detailed all-engine-operating performance data, including nominal fuel flow data, for standard and non-standard atmospheric conditions and as a function of airspeed and power setting, where appropriate, covering:
 - (i) cruise (altitude coverage including 10 000 ft); and
 - (ii) holding;

- (c) details of any other conditions relevant to ETOPS operations which can cause significant deterioration of performance, such as ice accumulation on the unprotected surfaces of the aircraft, ram air turbine (RAT) deployment, thrust-reverser deployment, etc.; and
- (d) the altitudes, airspeeds, thrust settings, and fuel flow used in establishing the ETOPS area of operations for each airframe-engine combination should be used in showing the corresponding terrain and obstruction clearances in accordance with Annex IV (Part-CAT).

6 MASS AND BALANCE

Instructions and data for the calculation of the mass and balance, including the following:

- (a) calculation system (e.g. index system);
- (b) information and instructions for completion of mass and balance documentation, including manual and computer generated types;
- (c) limiting masses and centre of gravity for the types, variants or individual aircraft used by the operator;
- (d) dry operating mass and corresponding centre of gravity or index.

7 LOADING

Procedures and provisions for loading and unloading and securing the load in the aircraft.

8 CONFIGURATION DEVIATION LIST

The CDL(s), if provided by the manufacturer, taking account of the aircraft types and variants operated, including procedures to be followed when an aircraft is being dispatched under the terms of its CDL.

9 MINIMUM EQUIPMENT LIST (MEL)

The MEL for each aircraft type or variant operated and the type(s)/area(s) of operation. The MEL should also include the dispatch conditions associated with operations required for a specific approval (e.g. RNAV, RNP, RVSM, ETOPS). Consideration should be given to using the ATA number system when allocating chapters and numbers.

10 SURVIVAL AND EMERGENCY EQUIPMENT INCLUDING OXYGEN

- 10.1 A list of the survival equipment to be carried for the routes to be flown and the procedures for checking the serviceability of this equipment prior to take-off. Instructions regarding the location, accessibility and use of survival and emergency equipment and its associated checklist(s) should also be included.
- 10.2 The procedure for determining the amount of oxygen required and the quantity that is available. The flight profile, number of occupants and possible cabin decompression should be considered.

11 EMERGENCY EVACUATION PROCEDURES

11.1 Instructions for preparation for emergency evacuation, including crew coordination and emergency station assignment.

11.2 Emergency evacuation procedures. A description of the duties of all members of the crew for the rapid evacuation of an aircraft and the handling of the passengers in the event of a forced landing, ditching or other emergency.

12 AIRCRAFT SYSTEMS

A description of the aircraft systems, related controls and indications and operating instructions. Consideration should be given to use the ATA number system when allocating chapters and numbers.

C ROUTE/ROLE/AREA AND AERODROME/OPERATING SITE INSTRUCTIONS AND INFORMATION

1 Instructions and information relating to communications, navigation and aerodromes/operating sites, including minimum flight levels and altitudes for each route to be flown and operating minima for each aerodrome/operating site planned to be used, including the following:

- (a) minimum flight level/altitude;
- (b) operating minima for departure, destination and alternate aerodromes;
- (c) communication facilities and navigation aids;
- (d) runway/final approach and take-off area (FATO) data and aerodrome/operating site facilities;
- (e) approach, missed approach and departure procedures including noise abatement procedures;
- (f) communication-failure procedures;
- (g) search and rescue facilities in the area over which the aircraft is to be flown;
- (h) a description of the aeronautical charts that should be carried on board in relation to the type of flight and the route to be flown, including the method to check their validity;
- (i) availability of aeronautical information and MET services;
- (j) en-route communication/navigation procedures;
- (k) aerodrome/operating site categorisation for flight crew competence qualification;
- (l) special aerodrome/operating site limitations (performance limitations and operating procedures, etc.).

(2) Information related to landing sites available for operations approved in accordance with Subpart L (SET-IMC) of Annex V (Part-SPA) to Regulation (EU) No 965/2012, including:

- (a) a description of the landing site (position, surface, slope, elevation, etc.);
- (b) the preferred landing direction; and

(c) obstacles in the area.

D TRAINING

- 1 Description of scope: Training syllabi and checking programmes for all operations personnel assigned to operational duties in connection with the preparation and/or conduct of a flight.
- 2 Content: Training syllabi and checking programmes should include the following:
 - 2.1 for flight crew, all relevant items prescribed in Annex IV (Part-CAT), Annex V (Part-SPA) and ORO.FC;
 - 2.2 for cabin crew, all relevant items prescribed in Annex IV (Part-CAT), Annex V (Part-CC) of Commission Regulation (EU) 1178/2011 and ORO.CC;
 - 2.3 for technical crew, all relevant items prescribed in Annex IV (Part-CAT), Annex V (Part-SPA) and ORO.TC;
 - 2.4 for operations personnel concerned, including crew members:
 - (a) all relevant items prescribed in SPA.DG Subpart G of Annex IV (SPA.DG); and
 - (b) all relevant items prescribed in Annex IV (Part-CAT) and ORO.SEC; and
 - 2.5 for operations personnel other than crew members (e.g. dispatcher, handling personnel, etc.), all other relevant items prescribed in Annex IV (Part-CAT) and in this Annex pertaining to their duties.
- 3 Procedures:
 - 3.1 Procedures for training and checking.
 - 3.2 Procedures to be applied in the event that personnel do not achieve or maintain the required standards.
 - 3.3 Procedures to ensure that abnormal or emergency situations requiring the application of part or all of the abnormal or emergency procedures, and simulation of instrument meteorological conditions (IMC) by artificial means are not simulated during CAT operations.
- 4 Description of documentation to be stored and storage periods.
 - (b) Notwithstanding (a), an OM that is compiled in accordance with JAR-OPS 3 amendment 5 may be considered to be compliant.
 - (c) If there are sections that, because of the nature of the operation, do not apply, it is recommended that operators maintain the numbering system described in [ORO.MLR.101](#) and above and insert 'Not applicable' or 'Intentionally blank' where appropriate.

AMC4 ORO.MLR.100 Operations manual – General

ED Decision 2015/030/R

CONTENTS – NON-COMMERCIAL SPECIALISED OPERATIONS WITH COMPLEX MOTOR-POWERED AIRCRAFT AND COMMERCIAL SPECIALISED OPERATIONS

- (a) The OM should contain at least the following information, where applicable, as relevant to the area and type of operation:

A GENERAL/BASIC

For chapters 0-7 refer to [AMC3 ORO.MLR.100](#).

In addition:

- 6.2 The relevant regulations and guidance to crew members concerning dangerous goods used for specialised tasks (pesticides and chemicals, etc.).

8 OPERATING PROCEDURES

8.1 Flight preparation instructions. As applicable to the operation:

8.1.1 General procedures;

8.1.2 Minimum flight altitudes. A description of the method of determination and application of minimum altitudes, including a procedure to establish the minimum altitudes/flight levels;

8.1.3 Criteria and responsibilities for determining the adequacy of aerodromes/operating sites to be used;

8.1.4 Interpretation of meteorological information. Explanatory material on the decoding of MET forecasts and MET reports relevant to the area of operations, including the interpretation of conditional expressions;

8.1.5 Determination of the quantities of fuel, oil and water methanol carried. The methods by which the quantities of fuel, oil and water methanol to be carried are determined and monitored in-flight. The system for maintaining fuel and oil records should also be described;

8.1.6 Procedure for the determination of the mass of loads, the calculation of performance margins and the centre of gravity;

8.1.7 Emergency procedures, e.g. load, fuel or chemical jettison (to include the actions of all personnel);

8.1.8 System for supply of NOTAMS, meteorological and other safety-critical information both at base and in field locations;

8.1.9 Mandatory equipment for specific tasks (mirror, cargo sling, load cell, special radio equipment, radar altimeters, etc.);

8.1.10 Guidance on the CDL and MEL;

8.1.11 Policy on completion and carriage of documents including operator's aircraft technical log and journey log, or equivalent;

8.1.12 Any task-specific standard operating procedures not covered above.

8.2 Ground handling instructions. As applicable to the operation:

8.2.1 Briefing requirements for in-flight and ground task specialists;

8.2.2 Decontamination procedures;

8.2.3 Fuelling procedures, including safety precautions during refuelling and defuelling including quality checks required in the field location, precautions against spillage and environmental damage;

8.2.4 De-icing and anti-icing on the ground. A description of the de-icing and anti-icing policy and procedures for aircraft on the ground.

-
- 8.3 Flight procedures. As applicable to the operation:
 - 8.3.1 Procedures relevant to the aircraft type, specific task and area;
 - 8.3.2 Altimeter setting procedures;
 - 8.3.3 Actions following alerts from audio warning devices;
 - 8.3.4 GPWS/TAWS for aeroplanes. Procedures and instructions required for the avoidance of controlled flight into terrain, including limitations on high rate of descent near the surface (the related training requirements are covered in OM-D 2.1);
 - 8.3.5 Policy and procedures for the use of TCAS/ACAS for aeroplanes and, when applicable, for helicopters;
 - 8.3.6 Policy and procedures for in-flight fuel management;
 - 8.3.7 Procedures for operating in adverse and potentially hazardous atmospheric conditions;
 - 8.3.8 Wake turbulence and rotor downwash for helicopters;
 - 8.3.9 Use of restraint devices;
 - 8.3.10 Policy on use of vacant seats;
 - 8.3.11 Cabin safety requirements including smoking.
 - 8.4 Task-specific weather limitations.
 - 8.5 Use of the minimum equipment and configuration deviation list(s).
 - 8.6 Oxygen requirements. An explanation of the conditions under which oxygen should be provided and used (altitude, exposure times, night etc.).
 - 9 DANGEROUS GOODS AND WEAPONS
 - 9.1 Information, instruction and general guidance on the transport of dangerous goods as internal or external loads, including:
 - 9.1.1 The operator's policy on the transport of dangerous goods;
 - 9.1.2 Guidance on the requirements for acceptance, labelling, handling, stowage, and segregation of dangerous goods;
 - 9.1.3 Procedures for responding to emergency situations involving dangerous goods;
 - 9.1.4 Duties of all personnel involved; and
 - 9.1.5 Instructions on carriage of the operator's personnel on cargo aircraft when dangerous goods are being carried.
 - 9.2 The conditions under which weapons, munitions of war and sporting weapons may be carried.
 - 10 SECURITY

Security instructions, guidance, procedures, training and responsibilities, taking into account Regulation (EC) No 300/2008. Some parts of the security instructions and guidance may be kept confidential.

11 HANDLING, NOTIFYING AND REPORTING ACCIDENTS, INCIDENTS AND OCCURRENCES, AND USING THE CVR RECORDINGS

Procedures for handling, notifying and reporting accidents, incidents and occurrences. This section should include:

- 11.1 Definitions of accidents and occurrences and responsibilities of all persons involved;
- 11.2 Reporting procedures (including any mandatory forms);
- 11.3 Special notification when dangerous goods are carried; and
- 11.4 Procedures for the preservation of recordings of the flight recorders in order to prevent inadvertent reactivation, repair or reinstallation of the flight recorders following an accident or a serious incident or when this preservation is directed by the investigating authority.

12 RULES OF THE AIR

In addition to the items referred to in [AMC3 ORO.MLR.100](#), territorial procedures for obtaining permissions and exemptions, e.g. for underslung loads and lowflying clearances.

13 LEASING

Refer to [AMC3 ORO.MLR.100](#).

B AIRCRAFT OPERATING MATTERS — TYPE RELATED

For chapters 0-1 refer to [AMC3 ORO.MLR.100](#).

2 NORMAL PROCEDURES

The normal procedures and duties assigned to the crew, the appropriate checklists and the system for their use, including any task or specific role equipment procedures not contained in the AFM.

3 ABNORMAL AND/OR EMERGENCY PROCEDURES

The abnormal and/or emergency procedures and duties assigned to the crew, the appropriate checklists and the system for their use, including any task or specific role equipment emergency procedures not contained in the AFM.

4 PERFORMANCE

- 4.1 Performance data should be provided in a form in which it can be used without difficulty.
- 4.2 Performance data. Performance material which provides the necessary data for compliance with the performance requirements prescribed in Part-SPO.

5 FLIGHT PLANNING

- 5.1 Data and instructions necessary for pre-flight and in-flight planning.
- 5.2 Procedures for specialised tasks.

6 MASS AND BALANCE

Instructions and data for the calculation of the mass and balance, including:

- 6.1 Calculation system (e.g. index system);

-
- 6.2 Information and instructions for completion of mass and balance documentation; and
 - 6.3 Limitations.
 - 7 LOADING
 - Refer to [AMC3 ORO.MLR.100](#).
 - 8 CONFIGURATION DEVIATION LIST (CDL)
 - Refer to [AMC3 ORO.MLR.100](#).
 - 9 MINIMUM EQUIPMENT LIST (MEL)
 - The MEL for each aircraft type or variant operated and the type(s)/area(s) of operation. It should also contain procedures to be followed when an aircraft is being dispatched with one or more inoperative items, in accordance with the MEL.
 - 10 SURVIVAL AND EMERGENCY EQUIPMENT INCLUDING OXYGEN
 - 10.1 A list of the survival equipment to be carried, taking into account the nature of the area of operation, such as a hostile or a non-hostile environment.
 - 10.2 A checklist for assessing the serviceability of the equipment and instructions for its use prior to take-off.
 - 10.3 The procedure for determining the amount of oxygen required and the quantity that is available.
 - 11 EMERGENCY EVACUATION PROCEDURES
 - 11.1 Emergency evacuation procedures, crew coordination and occupant handling in the event of a forced landing, ditching or other emergency.
 - 12 AIRCRAFT SYSTEMS
 - A description of the aircraft systems and all equipment specific to the tasks. Additional equipment, systems or fitting, related special procedures including any supplements to the AFM.
 - C TASKS AND OPERATING AREAS INSTRUCTIONS AND INFORMATION
 - Specific instructions related to the specialised tasks and operating areas in accordance with [AMC3 ORO.MLR.100](#).
 - D TRAINING
 - 1 Training syllabi and checking programmes for all operations personnel assigned to operational duties in connection with the preparation and/or conduct of a flight.
 - 2 Training syllabi and checking programmes should include:
 - 2.1 For flight crew, all relevant items prescribed in Part-SPO, Part-SPA and this Part;
 - 2.2 For other crew members, all relevant items prescribed in Part-SPO and this Part, as applicable;
 - 2.3 For in-flight and ground task specialists concerned, including crew members:
 - a. All relevant items prescribed in SPA.DG; and
 - b. All relevant items prescribed in Part-SPO and ORO.SEC; and

- 2.4 For operations personnel other than crew members, all other relevant items pertaining to their duties prescribed in Part-SPO and this Part.
 - 3 Procedures:
 - 3.1 Procedures for training and checking.
 - 3.2 Procedures to be applied in the event that personnel do not achieve or maintain the required standards.
 - 3.3 A system for tracking expiry dates for qualifications, checks, tests, recency and licences.
 - 4 Description of documentation to be stored and storage periods.
- (b) If there are sections that, because of the nature of the operation, do not apply, it is recommended that operators maintain the numbering system described in [ORO.MLR.101](#) and above and insert 'Not applicable' or 'Intentionally blank' where appropriate.

AMC5 ORO.MLR.100 Operations manual — general

ED Decision 2021/005/R

CROSSWIND LIMITATIONS IN THE OPERATIONS MANUAL (OM)

When publishing operational crosswind limitations in Part B of the OM in accordance with [AMC3 ORO.MLR.100](#), operators should consider:

- (a) the following manufacturer's information:
 - (1) values published in the 'Limitations' Section of the AFM;
 - (2) maximum demonstrated crosswind values, when more limiting values are not published in the 'Limitations' Section of the AFM;
 - (3) gust values; and
 - (4) additional guidance or recommendations;
- (b) operational experience; and
- (c) operating-environment factors such as:
 - (1) runway width;
 - (2) runway surface condition; and
 - (3) prevailing weather conditions.

GM1 ORO.MLR.100(k) Operations manual – general

ED Decision 2014/017/R

HUMAN FACTORS PRINCIPLES

Guidance material on the application of human factors principles can be found in the ICAO Human Factors Training Manual (Doc 9683).

ORO.MLR.101 Operations manual – structure for commercial air transport

Regulation (EU) 2018/1975

Except for operations with single-engined propeller-driven aeroplanes with an MOPSC of 5 or less or single-engined non-complex helicopters with an MOPSC of 5 or less, taking off and landing at the same aerodrome or operating site, under VFR by day, the main structure of the OM shall be as follows:

- (a) Part A: General/Basic, comprising all non-type-related operational policies, instructions and procedures;
- (b) Part B: Aircraft operating matters, comprising all type-related instructions and procedures, taking into account differences between types/classes, variants or individual aircraft used by the operator;
- (c) Part C: Commercial air transport operations, comprising route/role/area and aerodrome/operating site instructions and information;
- (d) Part D: Training, comprising all training instructions for personnel required for a safe operation.

ORO.MLR.105 Minimum equipment list

Regulation (EU) 2015/140

- (a) A minimum equipment list (MEL) shall be established as specified under point 8.a.3 of Annex IV to Regulation (EC) No 216/2008, based on the relevant master minimum equipment list (MMEL) as defined in the data established in accordance with Regulation (EU) No 748/2012. If an MMEL has not been established as part of the operational suitability data, the MEL may be based on the relevant MMEL accepted by the State of Operator or Registry as applicable.
- (b) The MEL and any amendment thereto shall be approved by the competent authority.
- (c) The operator shall amend the MEL after any applicable change to the MMEL within the acceptable timescales.
- (d) In addition to the list of items, the MEL shall contain:
 - (1) a preamble, including guidance and definitions for flight crews and maintenance personnel using the MEL;
 - (2) the revision status of the MMEL upon which the MEL is based and the revision status of the MEL;
 - (3) the scope, extent and purpose of the MEL.
- (e) The operator shall:
 - (1) establish rectification intervals for each inoperative instrument, item of equipment or function listed in the MEL. The rectification interval in the MEL shall not be less restrictive than the corresponding rectification interval in the MMEL;
 - (2) establish an effective rectification programme;
 - (3) only operate the aircraft after expiry of the rectification interval specified in the MEL when:
 - (i) the defect has been rectified; or
 - (ii) the rectification interval has been extended in accordance with (f).

-
- (f) Subject to approval of the competent authority, the operator may use a procedure for the one time extension of category B, C and D rectification intervals, provided that:
- (1) the extension of the rectification interval is within the scope of the MMEL for the aircraft type;
 - (2) the extension of the rectification interval is, as a maximum, of the same duration as the rectification interval specified in the MEL;
 - (3) the rectification interval extension is not used as a normal means of conducting MEL item rectification and is used only when events beyond the control of the operator have precluded rectification;
 - (4) a description of specific duties and responsibilities for controlling extensions is established by the operator;
 - (5) the competent authority is notified of any extension of the applicable rectification interval; and
 - (6) a plan to accomplish the rectification at the earliest opportunity is established.
- (g) The operator shall establish the operational and maintenance procedures referenced in the MEL taking into account the operational and maintenance procedures referenced in the MMEL. These procedures shall be part of the operator's manuals or the MEL.
- (h) The operator shall amend the operational and maintenance procedures referenced in the MEL after any applicable change to the operational and maintenance procedures referenced in the MMEL.
- (i) Unless otherwise specified in the MEL, the operator shall complete:
- (1) the operational procedures referenced in the MEL when planning for and/or operating with the listed item inoperative; and
 - (2) the maintenance procedures referenced in the MEL prior to operating with the listed item inoperative.
- (j) Subject to a specific case-by-case approval by the competent authority, the operator may operate an aircraft with inoperative instruments, items of equipment or functions outside the constraints of the MEL but within the constraints of the MMEL, provided that:
- (1) the concerned instruments, items of equipment or functions are within the scope of the MMEL as defined in point (a);
 - (2) the approval is not used as a normal means of conducting operations outside the constraints of the approved MEL and is used only when events beyond the control of the operator have precluded the MEL compliance;
 - (3) a description of specific duties and responsibilities for controlling the operation of the aircraft under such approval is established by the operator; and
 - (4) a plan to rectify the inoperative instruments, items of equipment or functions or to return operating the aircraft under the MEL constraints at the earliest opportunity is established.

GM1 ORO.MLR.105(a) Minimum equipment list

ED Decision 2014/017/R

GENERAL

- (a) The Minimum Equipment List (MEL) is a document that lists the equipment that may be temporarily inoperative, subject to certain conditions, at the commencement of flight. This document is prepared by the operator for their own particular aircraft taking account of their aircraft configuration and all those individual variables that cannot be addressed at MMEL level, such as operating environment, route structure, geographic location, aerodromes where spare parts and maintenance capabilities are available, etc., in accordance with a procedure approved by the competent authority.
- (b) The MMEL, as defined in the mandatory part of the operational suitability data established in accordance with Commission Regulation (EU) No 748/2012, is developed in compliance with CS-MMEL or CS-GEN-MMEL. These Certification Specifications contain, among other, guidance intended to standardise the level of relief granted in MMELs, in particular for items that are subject to operational requirements. If a MMEL established as part of the operational suitability data is not available and items subject to operational requirements are listed in the available MMEL without specific relief or dispatch conditions but only with a reference to the operational requirements, the operator may refer to CS-MMEL or CS-GEN-MMEL guidance material, as applicable, to develop the relevant MEL content for such items.

NON-SAFETY-RELATED EQUIPMENT

- (a) Most aircraft are designed and certified with a significant amount of equipment redundancy, such that the airworthiness requirements are satisfied by a substantial margin. In addition, aircraft are generally fitted with equipment that is not required for safe operation under all operating conditions, e.g. instrument lighting in day VMC.
- (b) All items related to the airworthiness, or required for the safe operation, of the aircraft and not included in the list are automatically required to be operative.
- (c) Equipment, such as entertainment systems or galley equipment, may be installed for passenger convenience. If this non-safety-related equipment does not affect the airworthiness or operation of the aircraft when inoperative, it does not require a rectification interval, and need not be listed in the operator's MEL, if it is not addressed in the MMEL. The exceptions to this are as follows:
 - (1) Where non-safety-related equipment serves a second function, such as movie equipment being used for cabin safety briefings, operators should develop and include operational contingency procedures in the MEL in case of an equipment malfunction.
 - (2) Where non-safety-related equipment is part of another aircraft system, for example the electrical system, procedures should be developed and included in the MEL for deactivating and securing in case of malfunction. In these cases, the item should be listed in the MEL, with compensating provisions and deactivation instructions if applicable. The rectification interval will be dependent on the secondary function of the item and the extent of its effect on other systems.
- (d) If the operator chooses to list non-safety-related equipment in the MEL, not listed in the MMEL, they should include a rectification interval category. These items may be given a 'D' category rectification interval provided any applicable (M) procedure (in the case of electrically supplied items) is applied.

- (e) Operators should establish an effective decision making process for failures that are not listed to determine if they are related to airworthiness and required for safe operation. In order for inoperative installed equipment to be considered non-safety-related, the following criteria should be considered:
- (1) the operation of the aircraft is not adversely affected such that standard operating procedures related to ground personnel, and crew members are impeded;
 - (2) the condition of the aircraft is not adversely affected such that the safety of passengers and/or personnel is jeopardised;
 - (3) the condition of the aircraft is configured to minimise the probability of a subsequent failure that may cause injury to passengers/personnel and/or cause damage to the aircraft;
 - (4) the condition does not include the use of required emergency equipment and does not impact emergency procedures such that personnel could not perform them.

AMC1 ORO.MLR.105(c) Minimum equipment list

ED Decision 2014/017/R

AMENDMENTS TO THE MEL FOLLOWING CHANGES TO THE MMEL — APPLICABLE CHANGES AND ACCEPTABLE TIMESCALES

- (a) The following are applicable changes to the MMEL that require amendment of the MEL:
- (1) a reduction of the rectification interval;
 - (2) change of an item, only when the change is applicable to the aircraft or type of operations and is more restrictive.
- (b) An acceptable timescale for submitting the amended MEL to the competent authority is 90 days from the effective date specified in the approved change to the MMEL.
- (c) Reduced timescales for the implementation of safety-related amendments may be required if the Agency and/or the competent authority consider it necessary.

AMC1 ORO.MLR.105(d) Minimum equipment list

ED Decision 2014/017/R

MEL FORMAT

- (a) The MEL format and the presentation of items and dispatch conditions should reflect those of the MMEL.
- (b) The ATA 100/2200 Specification numbering system for MEL items is preferred.
- (c) Other formats and item numbering systems may be used provided they are clear and unambiguous.

AMC1 ORO.MLR.105(d)(1) Minimum equipment list

ED Decision 2014/017/R

MEL PREAMBLE

The MEL preamble should:

- (a) reflect the content of the MMEL preamble as applicable to the MEL scope and extent;

- (b) contain terms and definitions used in the MEL;
- (c) contain any other relevant specific information for the MEL scope and use that is not originally provided in the MMEL;
- (d) provide guidance on how to identify the origin of a failure or malfunction to the extent necessary for appropriate application of the MEL;
- (e) contain guidance on the management of multiple unserviceabilities, based on the guidance given in the MMEL; and
- (f) contain guidance on placarding of inoperative items to inform crew members of equipment condition, as appropriate. In particular, when such items are accessible to the crew during flight, the control(s) and indicator(s) related to inoperative unit(s) should be clearly placarded.

AMC1 ORO.MLR.105(d)(3) Minimum equipment list

ED Decision 2019/019/R

SCOPE OF THE MEL

The MEL should include:

- (a) The dispatch conditions associated with flights conducted in accordance with specific approvals held by the operator in accordance with Part-SPA.
- (b) Specific provision for particular types of operations carried out by the operator in accordance with [ORO.GEN.310](#) and with [ORO.AOC.125](#).

AMC2 ORO.MLR.105(d)(3) Minimum equipment list

ED Decision 2014/017/R

EXTENT OF THE MEL

The operator should include guidance in the MEL on how to deal with any failures that occur between the commencement of the flight and the start of the take-off. If a failure occurs between the commencement of the flight and the start of the take-off, any decision to continue the flight should be subject to pilot judgement and good airmanship. The pilot-in-command/commander may refer to the MEL before any decision to continue the flight is taken.

GM1 ORO.MLR.105(d)(3) Minimum equipment list

ED Decision 2019/019/R

SCOPE OF THE MEL

- (a) Examples of special approvals in accordance with Part-SPA may be:
 - (1) RVSM,
 - (2) ETOPS,
 - (3) LVO.
- (b) Different types of operations carried out by the operator in accordance with [ORO.GEN.310](#) and with [ORO.AOC.125](#):
 - (1) crew training,
 - (2) positioning flights,

- (3) demonstration flights.
- (c) When an aircraft has installed equipment which is not required for the operations conducted, the operator may wish to delay rectification of such items for an indefinite period. Such cases are considered to be out of the scope of the MEL, therefore modification of the aircraft is appropriate and deactivation, inhibition or removal of the item should be accomplished by an appropriate approved modification procedure.

GM2 ORO.MLR.105(d)(3) Minimum equipment list

ED Decision 2014/017/R

PURPOSE OF THE MEL

The MEL is an alleviating document having the purpose to identify the minimum equipment and conditions to operate safely an aircraft having inoperative equipment. Its purpose is not, however, to encourage the operation of aircraft with inoperative equipment. It is undesirable for aircraft to be dispatched with inoperative equipment and such operations are permitted only as a result of careful analysis of each item to ensure that the acceptable level of safety, as intended in the applicable airworthiness and operational requirements is maintained. The continued operation of an aircraft in this condition should be minimised.

GM1 ORO.MLR.105(e);(f) Minimum equipment list

ED Decision 2014/017/R

RECTIFICATION INTERVAL (RI)

The definitions and categories of rectification intervals are provided in CS-MMEL.

AMC1 ORO.MLR.105(f) Minimum equipment list

ED Decision 2014/017/R

RECTIFICATION INTERVAL EXTENSION (RIE) — OPERATOR PROCEDURES FOR THE APPROVAL BY THE COMPETENT AUTHORITY AND NOTIFICATION TO THE COMPETENT AUTHORITY

- (a) The operator's procedures to address the extension of rectification intervals and ongoing surveillance to ensure compliance should provide the competent authority with details of the name and position of the nominated personnel responsible for the control of the operator's rectification interval extension (RIE) procedures and details of the specific duties and responsibilities established to control the use of RIEs.
- (b) Personnel authorising RIEs should be adequately trained in technical and/or operational disciplines to accomplish their duties. They should have necessary operational knowledge in terms of operational use of the MEL as alleviating documents by flight crew and maintenance personnel and engineering competence. The authorising personnel should be listed by appointment and name.
- (c) The operator should notify the competent authority within 1 month of the extension of the applicable rectification interval or within the appropriated timescales specified by the approved procedure for the RIE.
- (d) The notification should be made in a form determined by the competent authority and should specify the original defect, all such uses, the reason for the RIE and the reasons why rectification was not carried out within the original rectification interval.

GM1 ORO.MLR.105(f) Minimum equipment list

ED Decision 2014/017/R

RECTIFICATION INTERVAL EXTENSION (RIE)

Procedures for the extension of rectification intervals should only be applied under certain conditions, such as a shortage of parts from manufacturers or other unforeseen situations (e.g. inability to obtain equipment necessary for proper troubleshooting and repair), in which case the operator may be unable to comply with the specified rectification intervals.

AMC1 ORO.MLR.105(g) Minimum equipment list

ED Decision 2017/007/R

OPERATIONAL AND MAINTENANCE PROCEDURES

- (a) The operational and maintenance procedures referenced in the MEL should be based on the operational and maintenance procedures referenced in the MMEL. Modified procedures may, however, be developed by the operator when they provide the same level of safety, as required by the MMEL. Modified maintenance procedures should be developed in accordance with Commission Regulation (EU) No 1321/2014.
- (b) Providing appropriate operational and maintenance procedures referenced in the MEL, regardless of who developed them, is the responsibility of the operator.
- (c) Any item in the MEL requiring an operational or maintenance procedure to ensure an acceptable level of safety should be so identified in the 'remarks' or 'exceptions' column/part/section of the MEL. This will normally be '(O)' for an operational procedure, or '(M)' for a maintenance procedure. '(O)(M)' means both operational and maintenance procedures are required.
- (d) The satisfactory accomplishment of all procedures, regardless of who performs them, is the responsibility of the operator.

GM1 ORO.MLR.105(g) Minimum equipment list

ED Decision 2017/007/R

OPERATIONAL AND MAINTENANCE PROCEDURES

- (a) Operational and maintenance procedures are an integral part of the compensating conditions needed to maintain an acceptable level of safety, enabling the competent authority to approve the MEL. The competent authority may request presentation of fully developed (O) and/or (M) procedures in the course of the MEL approval process.
- (b) Normally, operational procedures are accomplished by the flight crew; however, other personnel may be qualified and authorised to perform certain functions.
- (c) Normally, maintenance procedures are accomplished by the maintenance personnel; however, other personnel may be qualified and authorised to perform certain functions in accordance with Commission Regulation (EU) No 1321/2014.
- (d) Operator's manuals may include the OM, the continued airworthiness management organisation manual (CAME) or other documents. Operational and maintenance procedures, regardless of the document where they are contained, should be readily available for use when needed for the application of the MEL.

- (e) Unless specifically permitted by a maintenance procedure, an inoperative item may not be removed from the aircraft.

AMC1 ORO.MLR.105(h) Minimum equipment list

ED Decision 2015/005/R

OPERATIONAL AND MAINTENANCE PROCEDURES — APPLICABLE CHANGES

- (a) Changes to the operational and maintenance procedures referenced in the MMEL are considered applicable and require the amendment of the maintenance and operating procedures referenced in the MEL when:
- (1) the modified procedure is applicable to the operator's MEL; and
 - (2) the purpose of this change is to improve compliance with the intent of the associated MMEL dispatch condition.
- (b) An acceptable timescale for the amendments of maintenance and operating procedures, as defined in (a), should be 90 days from the date when the amended procedures referenced in the MMEL are made available. Reduced timescales for the implementation of safety related amendments may be required if the competent authority considers it necessary.

AMC1 ORO.MLR.105(j) Minimum equipment list

ED Decision 2014/017/R

OPERATION OF AN AIRCRAFT WITHIN THE CONSTRAINTS OF THE MMEL — OPERATOR'S PROCEDURES FOR THE APPROVAL BY THE COMPETENT AUTHORITY

- (a) The operator's procedures to address the operation of an aircraft outside the constraints of the MEL but within the constraints of the MMEL and ongoing surveillance to ensure compliance should provide the competent authority with details of the name and position of the nominated personnel responsible for the control of the operations under such conditions and details of the specific duties and responsibilities established to control the use of the approval.
- (b) Personnel authorising operations under such approval should be adequately trained in technical and operational disciplines to accomplish their duties. They should have the necessary operational knowledge in terms of operational use of the MEL as alleviating documents by flight crew and maintenance personnel and engineering competence. The authorising personnel should be listed by appointment and name.

GM1 ORO.MLR.105(j) Minimum equipment list

ED Decision 2014/017/R

OPERATION OF AN AIRCRAFT WITHIN THE CONSTRAINTS OF THE MMEL — OPERATOR'S PROCEDURES FOR THE APPROVAL BY THE COMPETENT AUTHORITY

Procedures for the operation of an aircraft outside the constraints of the MEL but within the constraints of the MMEL should only be applied under certain conditions, such as a shortage of parts from manufacturers or other unforeseen situations (e.g. inability to obtain equipment necessary for proper troubleshooting and repair), in which case the operator may be unable to comply with the constraints specified in the MEL.

ORO.MLR.110 Journey log

Regulation (EU) No 379/2014

Particulars of the aircraft, its crew and each journey shall be retained for each flight, or series of flights, in the form of a journey log, or equivalent.

AMC1 ORO.MLR.110 Journey log

ED Decision 2014/017/R

GENERAL

- (a) The aircraft journey log, or equivalent, should include the following items, where applicable:
- (1) aircraft nationality and registration,
 - (2) date,
 - (3) name(s) of crew member(s),
 - (4) duty assignments of crew member(s),
 - (5) place of departure,
 - (6) place of arrival,
 - (7) time of departure,
 - (8) time of arrival,
 - (9) hours of flight,
 - (10) nature of flight (scheduled or non-scheduled),
 - (11) incidents, observations, if any,
 - (12) signature of person in charge.
- (b) The information, or parts thereof, may be recorded in a form other than on printed paper. Accessibility, usability and reliability should be assured.
- (c) 'Journey log, or equivalent' means that the required information may be recorded in documentation other than a log book, such as the operational flight plan or the aircraft technical log.
- (d) 'Series of flights' means consecutive flights, which begin and end:
- (1) within a 24-hour period;
 - (2) at the same aerodrome or operating site or remain within a local area specified in the operations manual; and
 - (3) with the same pilot-in-command/commander of the aircraft.

GM1 ORO.MLR.110 Journey log

ED Decision 2014/017/R

SERIES OF FLIGHTS

The term 'series of flights' is used to facilitate a single set of documentation.

ORO.MLR.115 Record-keeping

Regulation (EU) No 379/2014

- (a) The following records shall be stored for at least 5 years.
 - (1) for CAT operators, records of the activities referred to in [ORO.GEN.200](#);
 - (2) for declared operators, a copy of the operator’s declaration, details of approvals held and operations manual;
 - (3) for SPO authorisation holders, in addition to (a)(2), records related to the risk assessment conducted in accordance with [SPO.OP.230](#) and related standard operating procedures.
- (b) The following information used for the preparation and execution of a flight, and associated reports, shall be stored for three months:
 - (1) the operational flight plan, if applicable;
 - (2) route-specific notice(s) to airmen (NOTAM) and aeronautical information services (AIS) briefing documentation, if edited by the operator;
 - (3) mass and balance documentation;
 - (4) notification of special loads, including written information to the commander/pilot-in-command about dangerous goods, if applicable;
 - (5) the journey log, or equivalent; and
 - (6) flight report(s) for recording details of any occurrence, or any event that the commander/pilot-in-command deems necessary to report or record;
- (c) Personnel records shall be stored for the periods indicated below:

Flight crew licence and cabin crew attestation	As long as the crew member is exercising the privileges of the licence or attestation for the aircraft operator
Crew member training, checking and qualifications	3 years
Records on crew member recent experience	15 months
Crew member route and aerodrome/task and area competence, as appropriate	3 years
Dangerous goods training, as appropriate	3 years
Training/qualification records of other personnel for whom a training programme is required	Last 2 training records

- (d) The operator shall:
 - (1) maintain records of all training, checking and qualifications of each crew member, as prescribed in Part-ORO; and
 - (2) make such records available, on request, to the crew member concerned.
- (e) The operator shall preserve the information used for the preparation and execution of a flight and personnel training records, even if the operator ceases to be the operator of that aircraft or the employer of that crew member, provided this is within the timescales prescribed in (c).
- (f) If a crew member becomes a crew member for another operator, the operator shall make the crew member’s records available to the new operator, provided this is within the timescales prescribed in (c).

AMC1 ORO.MLR.115 Record-keeping

ED Decision 2014/017/R

TRAINING RECORDS

A summary of training should be maintained by the operator to show every crew member's completion of each stage of training and checking.

GM1 ORO.MLR.115(c) Record-keeping

ED Decision 2017/007/R

PERSONNEL RECORDS

'Personnel records' in [ORO.MLR.115\(c\)](#) means detailed crew member training, checking and qualification records. These records include detailed examination records.

GM1 ORO.MLR.115(d) Record-keeping

ED Decision 2017/007/R

TRAINING, CHECKING AND QUALIFICATION RECORDS

Training, checking and qualification records include records of all training, checking and qualifications of each crew member, as prescribed in Part-ORO.

SUBPART SEC: SECURITY

ORO.SEC.100 Flight crew compartment security – aeroplanes

Regulation (EU) 2019/1387

- (a) In an aeroplane which is equipped with a secure flight crew compartment door, that door shall be capable of being locked, and means shall be provided by which the cabin crew can notify the flight crew in the event of suspicious activity or security breaches in the cabin.
- (b) All passenger-carrying aeroplanes that are engaged in the commercial transportation of passengers shall be equipped with an approved secure flight crew compartment door that is capable of being locked and unlocked from either pilot's station and designed to meet the applicable airworthiness requirements, where such airplanes fall within any of the following categories:
 - (1) aeroplanes with an MCTOM that exceeds 54 500 kg;
 - (2) aeroplanes with an MCTOM that exceeds 45 500 kg and have an MOPSC of more than 19; or
 - (3) aeroplanes with an MOPSC of more than 60.
- (c) In all aeroplanes which are equipped with a secure flight crew compartment door in accordance with point (b):
 - (1) that door shall be closed prior to engine start for take-off and shall be locked when required so by security procedures or by the pilot-in-command until engine shutdown after landing, except when deemed to be necessary for authorised persons to access or egress in compliance with national civil aviation security programmes;
 - (2) means shall be provided for monitoring from either pilot's station the entire door area outside the flight crew compartment to identify persons that request to enter and to detect suspicious behaviour or potential threat.

ORO.SEC.105 Flight crew compartment security – helicopters

Regulation (EU) No 379/2014

If installed, the flight crew compartment door on a helicopter operated for the purpose of carrying passengers shall be capable of being locked from within the flight crew compartment in order to prevent unauthorised access.

SUBPART FC: FLIGHT CREW

ORO.FC.005 Scope

Regulation (EU) 2018/1975

This Subpart establishes requirements to be met by the operator related to flight crew training, experience and qualification and comprises:

- (a) SECTION 1 specifying common requirements applicable to both non-commercial operations of complex motor-powered aircraft and any commercial operation;
- (b) SECTION 2 specifying additional requirements applicable to commercial air transport operations, with the exception of commercial air transport operations of passengers conducted under VFR by day, starting and ending at the same aerodrome or operating site and within a local area specified by the competent authority, with:
 - (1) single-engined propeller-driven aeroplanes having an MCTOM of 5 700 kg or less and an MOPSC of 5 or less; or
 - (2) other-than-complex motor-powered helicopters, single-engined, with an MOPSC of 5 or less.
- (c) SECTION 3 specifying additional requirements for commercial specialised operations and for those referred to in b(1) and (2).

SECTION 1 – COMMON REQUIREMENTS

ORO.FC.100 Composition of flight crew

Regulation (EU) 2021/2237

- (a) The composition of the flight crew and the number of flight crew members at designated crew stations shall be not less than the minimum specified in the aircraft flight manual or operating limitations prescribed for the aircraft.
- (b) The flight crew shall include additional flight crew members when required by the type of operation and shall not be reduced below the number specified in the operations manual.
- (c) All flight crew members shall hold a licence and ratings issued or accepted in accordance with [Commission Regulation \(EU\) No 1178/2011](#)¹ and appropriate to the duties assigned to them.
- (d) The flight crew member may be relieved in flight of his or her duties at the controls by another suitably qualified flight crew member.
- (e) When engaging the services of flight crew members who are working on a freelance or part-time basis, the operator shall verify that all applicable requirements of this Subpart and the relevant elements of Annex I (Part-FCL) to [Regulation \(EU\) No 1178/2011](#), including the requirements on recent experience, are complied with, taking into account all services rendered by the flight crew member to other operator(s) to determine in particular:
 - (1) the total number of aircraft types or variants operated; and
 - (2) the applicable flight and duty time limitations and rest requirements.

¹ OJ L 311, 25.11.2011, p. 1.

(f) Specific requirements for helicopter operations

If the helicopter is operated with a crew of two pilots, each pilot shall either:

- (1) hold a certificate of satisfactory completion of a multi-crew cooperation (MCC) course in helicopters in accordance with [Regulation \(EU\) No 1178/2011](#); or
- (2) have at least 500 hours of flight time as a pilot in multi-pilot operations.

GM1 ORO.FC.100(c) Composition of flight crew

ED Decision 2022/014/R

LICENCE AND RATINGS IN ACCORDANCE WITH COMMISSION REGULATION (EU) No 1178/2011

When determining the composition of the crew, and monitoring whether the flight crew holds the appropriate licence and ratings, the operator needs to take into account any limitations prescribed in [Regulation \(EU\) No 1178/2011](#) applicable to the flight crew members such as, but not limited to, recent experience and operational multi-pilot limitation.

ORO.FC.105 Designation as pilot-in-command/commander

Regulation (EU) 2021/2237

- (a) In accordance with point 8.6 of Annex V to [Regulation \(EU\) 2018/1139](#), one pilot amongst the flight crew, qualified as pilot-in-command in accordance with Annex I (Part-FCL) to [Regulation \(EU\) No 1178/2011](#), shall be designated by the operator as pilot-in-command or, for commercial air transport operations, as commander.
- (b) The operator shall only designate a flight crew member to act as pilot-in-command/commander if all of the following apply:
 - (1) the flight crew member has the minimum level of experience specified in the operations manual;
 - (2) the flight crew member has adequate knowledge of the route or area to be flown and of the aerodromes, including alternate aerodromes, facilities and procedures to be used;
 - (3) in the case of multi-crew operations, the flight crew member has completed an operator's command course if upgrading from co-pilot to pilot-in-command/commander.
- (c) In the case of commercial operations of aeroplanes and helicopters, the pilot-in-command/commander or the pilot to whom the conduct of the flight may be delegated shall have had initial familiarisation training on the route or area to be flown and on the aerodromes, facilities and procedures to be used and shall maintain this knowledge as follows:
 - (1) The validity of the aerodrome knowledge shall be maintained by operating at least once on the aerodrome within a 12 calendar months' period.
 - (2) The route or area knowledge shall be maintained by operating at least once to the route or area within a 36 months' period. In addition, refresher training is required regarding route or area knowledge if not operating on a route or area for 12 months within the 36-month period.
- (d) Notwithstanding point (c), in the case of operations under VFR by day with performance class B and C aeroplanes and helicopters, familiarisation training on the route and aerodromes may be replaced by area familiarisation training.

**AMC1 ORO.FC.105(b)(2);(c)
pilot-in-command/commander****Designation****as**

ED Decision 2022/014/R

GENERAL

The operator should comply with the national training and checking requirements published in the aeronautical information publication (AIP).

ROUTE, AREA AND AERODROME KNOWLEDGE FOR COMMERCIAL OPERATIONS

The experience of the route or area to be flown and of the aerodrome facilities and procedures to be used should include the following:

- (a) Area and route knowledge
 - (1) An objective of the area and route training should be to ensure that the pilot has knowledge of:
 - (i) terrain and minimum safe altitudes;
 - (ii) seasonal meteorological conditions;
 - (iii) meteorological, communication and air traffic facilities, services and procedures;
 - (iv) search and rescue procedures where available; and
 - (v) navigational facilities associated with the area or route along which the flight is to take place.
 - (2) Another objective of the area and route training should be to ensure that the pilots are aware of the most significant underlying risks and threats of a route or an area that could affect their operations following the 'threat and error management model' or an alternative risk model agreed with the authority.
 - (3) The area and route familiarisation training should:
 - (i) be based on an assessment by the operator of the underlying risks and threats of a route or an area using:
 - (A) internal evidence;
 - (B) external evidence;
 - (ii) be conducted:
 - (A) as an initial training before operating to a route and area;
 - (B) as a refresher training after not operating to a route and area for 12 months.
 - (4) The area and route familiarisation training should be delivered using different methods and tools.
 - (i) The selection of the method and tools should result from a combination of the learning objectives and the type of risk or threat that needs to be trained.
 - (ii) The selection of the appropriate method and tool should be driven by the desired outcome in terms of adequate knowledge and awareness.
 - (iii) The methods and tools employed should include one or more of the following: Training in a flight simulation training device (FSTD), computer-based training, familiarisation flight as a pilot in-command/commander or co-pilot under

supervision or an observer, video training, virtual reality training, familiarisation by self-briefing with route documentation and audio training.

(b) Aerodrome knowledge

- (1) Aerodrome familiarisation training should include knowledge of obstructions, physical layout, lighting, approach aids and arrival, departure, holding and instrument approach procedures, applicable operating minima and ground movement considerations.
- (2) The operations manual should describe the method of categorisation of aerodromes and, in the case of CAT operations, provide a list of those aerodromes categorised as B or C.
- (3) All aerodromes to which an operator operates should be categorised in one of these three categories:
 - (i) category A — an aerodrome that meets all the following conditions:
 - (A) a straight-in 3D instrument approach procedure with a glide path angle of not more than 3.5 degrees to each runway expected to be used for landing;
 - (B) at least one runway with no performance-limited procedure for take-off and/or landing, such as no requirement to follow a contingency procedure for obstacle clearance in the event of an engine failure on take-off from any runway expected to be used for departure; and
 - (C) night operations capability.
 - (ii) category B — an aerodrome that does not meet the category A conditions or which requires extra considerations due to:
 - (A) non-standard approach aids and/or approach patterns, such as restrictions on the availability of straight-in instrument approach procedures;
 - (B) unusual local weather conditions, such as environmental features that can give rise to turbulence, windshear or unusual wind conditions;
 - (C) unusual characteristics or performance limitations, such as unusual runway characteristics in length, width, slope, markings or lighting that present an atypical visual perspective on approach;
 - (D) any other relevant considerations, including obstructions, physical layout, lighting, etc., such as restrictions on circling in certain sectors due to obstacles in the circling area;
 - (E) training or flight crew experience requirements stipulated by the competent authority responsible for the aerodrome that do not include instruction in an FSTD or visiting the aerodrome.
 - (iii) category C — an aerodrome:
 - (A) that requires additional considerations to those of a category B aerodrome; or
 - (B) for which flight crew experience or qualification requirements stipulated by the competent authority responsible for the aerodrome include instruction in an FSTD or visiting the aerodrome.

Offshore installations may be categorised as category B or C aerodromes, taking into account the limitations determined in accordance with [AMC1 SPA.HOFO.115](#) 'Use of offshore locations'.

- (c) Prior to operating to a category B aerodrome (planned destination or required alternate), the pilot-in-command/commander should:
- (1) comply with any requirements stipulated by the competent authority responsible for the aerodrome; and
 - (2) be briefed, or self-brief by means of programmed instruction, about the additional considerations applicable to operations to that category B aerodrome. The completion of the briefing should be recorded. This recording may be accomplished after completion or confirmed by the pilot-in-command/commander before departure on a flight involving category B aerodrome(s) as destination or alternate aerodromes.
- (d) Prior to operating to a category C aerodrome (planned destination or required alternate), the pilot-in-command/commander should:
- (1) comply with any requirements stipulated by the competent authority responsible for the aerodrome; and
 - (2) be briefed or self-brief by means of programmed instruction, about the additional considerations applicable to operations to that category C aerodrome; and
 - (3) visit the aerodrome as an observer and/or undertake instruction in a suitable FSTD. The observer should occupy an observer's seat where installed. If an observer's seat is not available and cannot be installed, the pilot-in-command/commander may occupy a pilot seat to conduct the aerodrome visit with a suitably qualified commander nominated by the category C aerodrome operator.

The completion of the briefing, visit and/or instruction should be recorded.

AMC2 ORO.FC.105(b)(2);(c) Designation as pilot-in-command/commander

ED Decision 2022/014/R

GENERAL

The operator should comply with the national training and checking requirements published in the AIP.

ROUTE, AREA AND AERODROME KNOWLEDGE FOR NON-COMMERCIAL OPERATIONS

The knowledge of the route and area to be flown and of the aerodrome facilities and procedures to be used should include the following:

- (a) Area and route knowledge
- (1) The objective of the area and route familiarisation should be to ensure that the pilot has knowledge of:
 - (i) terrain and minimum safe altitudes;
 - (ii) seasonal meteorological conditions;
 - (iii) meteorological, communication and air traffic facilities, services and procedures;
 - (iv) search and rescue procedures where available; and
 - (v) navigational facilities associated with the area or route along which the flight is to take place.

- (2) The operations manual should describe appropriate methods of familiarisation depending on the complexity of the area or route and the experience of the pilot-in-command.
- (b) Aerodrome knowledge
- (1) Aerodrome familiarisation should include knowledge of obstructions, physical layout, lighting, approach aids and arrival, departure, holding and instrument approach procedures, applicable operating minima and ground movement considerations.
- (2) The operator's manual should describe appropriate methods of familiarisation depending on the complexity of the aerodrome.
- (3) If the competent authority of the aerodrome or area requires specific training or familiarisation, the operator should maintain all records of this training or familiarisation in accordance with [ORO.GEN.220](#).
- (4) For offshore installations, the limitations determined in accordance with [AMC1 SPA.HOFO.115](#) should be taken into account.

[applicable from 26 March 2023]

GM1 ORO.FC.105(b)(2) Route and aerodrome knowledge

ED Decision 2015/012/R

ENVIRONMENTAL KNOWLEDGE RELATED TO THE PREVENTION OF AEROPLANE UPSETS

The knowledge should include understanding of:

- (a) the relevant environmental hazards, such as:
- Clear Air Turbulence (CAT),
 - Intertropical Convergence Zone (ITCZ),
 - thunderstorms,
 - microbursts,
 - wind shear,
 - icing,
 - mountain waves,
 - wake turbulence, and
 - temperature changes at high altitude;
- (b) the evaluation and management of the associated risks of the relevant hazards in (a); and
- (c) the available mitigating procedures for the relevant hazards in (a) related to the specific route, route area, or aerodrome used by the operator.

GM2 ORO.FC.105(b)(2) Designation as pilot-in-command/commander

ED Decision 2022/014/R

AERODROME KNOWLEDGE FOR NON-COMMERCIAL OPERATIONS

The operator may, based on complexity, categorise all aerodromes in one of the following three categories:

- (a) category A — an aerodrome that meets all the following conditions:
 - (1) an approved instrument approach procedure;
 - (2) at least one runway with no performance-limited procedure for take-off and/or landing;
 - (3) published circling minima not higher than 1 000 ft above aerodrome level; and
 - (4) night operations capability.
- (b) category B — an aerodrome that does not meet the category A conditions or which requires extra considerations due to:
 - (1) non-standard approach aids and/or approach patterns;
 - (2) unusual local weather conditions;
 - (3) unusual characteristics or performance limitations;
 - (4) any other relevant considerations, including obstacles, physical layout, lighting, etc.
- (c) category C — an aerodrome that requires additional considerations to those of a category B aerodrome.

Offshore installations may be categorised as category B or C aerodromes, taking into account the limitations determined in accordance with [AMC1 SPA.HOFO.115](#) 'Use of offshore locations'.

[applicable from 26 March 2023]

AMC1 ORO.FC.105(b)(3) Designation as pilot-in-command/commander

ED Decision 2022/014/R

OPERATOR'S COMMAND COURSE FOR NON-COMMERCIAL OPERATIONS WITH COMPLEX MOTOR-POWERED AIRCRAFT (NCC)

- (a) For aeroplane and helicopter operations, when upgrading from co-pilot to pilot-in-command, the flight crew member should be trained at least on the following elements, as part of the command course:
 - (1) command responsibilities training;
 - (2) demonstration of competence operating as pilot-in-command.
- (b) Demonstration of competence operating as pilot-in-command may be achieved by:
 - (1) completing a proficiency check in the role of pilot-in-command; or
 - (2) operating at least one flight under the supervision and to the satisfaction of a suitably qualified pilot-in-command nominated by the operator.

[applicable from 26 March 2023]

AMC1 ORO.FC.105(c) Designation as pilot-in-command/commander

ED Decision 2022/014/R

ROUTE/AREA AND AERODROME REGENCY

- (a) The 12-month period should be counted from the last day of the month:
- (1) when the familiarisation training was undertaken; or
 - (2) of the latest operation on the route or area to be flown and of the aerodromes, facilities and procedures to be used.
- (b) The 36-month period should be counted from the last day of the month:
- (1) when the familiarisation training was undertaken; or
 - (2) when the latest operation on the route or area was flown.

AMC2 ORO.FC.105(c) Designation as pilot-in-command/commander

ED Decision 2014/017/R

ROUTE/AREA AND AERODROME REGENCY — PERFORMANCE CLASS B AEROPLANES OPERATED UNDER VFR BY NIGHT OR IFR IN CAT OPERATIONS AND COMMERCIAL OPERATIONS OTHER THAN CAT

In the case of CAT operations with performance class B aeroplanes operating under visual flight rules (VFR) by night or instrument flight rules (IFR), or commercial operations other than CAT, the knowledge should be maintained as follows:

- (a) except for operations to the most demanding aerodromes, by completion of at least 10 flight sectors within the area of operation during the preceding 12 months in addition to any required self-briefing;
- (b) operations to the most demanding aerodromes may be performed only if:
- (1) the pilot-in-command/commander has been qualified at the aerodrome within the preceding 36 months by a visit as an operating flight crew member or as an observer;
 - (2) the approach is performed in visual meteorological conditions (VMC) from the applicable minimum sector altitude; and
 - (3) an adequate self-briefing has been made prior to the flight.

GM1 ORO.FC.105(c) Designation as pilot-in-command/commander

ED Decision 2022/014/R

AREA AND ROUTE FAMILIARISATION TRAINING DELIVERY

When developing the area and route familiarisation training, the operator may apply the following methodology:

- (a) Internal evidence
- (1) Operator assessment by conducting an operational risk evaluation according to the following criteria:
 - (i) terrain and minimum safe altitudes;
 - (ii) seasonal meteorological conditions;
 - (iii) meteorological, communication and air traffic facilities, services and procedures;
 - (iv) search and rescue procedures where available; and

- (v) navigational facilities associated with the area or route along which the flight is to take place.
- (2) Operator-specific evidence gathered through the safety management process in accordance with ORO.GEN.200.
- (b) External evidence
 - (1) notices to airmen (NOTAMs);
 - (2) AIP.
- (c) When selecting the method and tool, operators should be driven by the objective of reaching the optimum in terms of the desired outcome, which is the maximum possible knowledge increase. This methodology intends that such selection is based on the type of the underlying risks of a route / area as determined in accordance with (a) and (b) and the learning objectives. For example: for the less complex areas or routes, familiarisation by self-briefing with route documentation, or by means of programmed instruction; and for the more complex areas or routes, in-flight familiarisation as a pilot-in-command/commander or co-pilot under supervision or an observer, or familiarisation in a flight simulation training device (FSTD) using a database appropriate to the route concerned.

AMC1 ORO.FC.105(d) Designation as pilot-in-command/commander

ED Decision 2022/014/R

AREA FAMILIARISATION TRAINING THAT INCLUDES ROUTE /AERODROME FAMILIARISATION — HELICOPTERS

- (a) The area familiarisation training for day VFR should ensure that a pilot is capable of selecting aerodromes and operating sites from the ground and from the air, and of establishing a safe flight path for landing and take-off.

AREA FAMILIARISATION TRAINING

- (b) The following areas and conditions should require specific area familiarisation training:
 - (1) mountain environment;
 - (2) offshore environment;
 - (3) complex airspace;
 - (4) areas that are regularly covered by snow and are prone to white-out phenomena during the cruise or landing phase; and
 - (5) other challenging areas or conditions.

GM1 ORO.FC.105(d) Designation as pilot-in-command/commander

ED Decision 2014/017/R

PERFORMANCE CLASS B AEROPLANES OPERATED UNDER VFR BY DAY IN CAT OPERATIONS

For CAT operations under VFR by day with performance class B aeroplanes, the operator should take account of any requirement that might be stipulated in specific cases by the State of the aerodrome.

ORO.FC.110 Flight engineer

Regulation (EU) No 965/2012

When a separate flight engineer station is incorporated in the design of an aeroplane, the flight crew shall include one crew member who is suitably qualified in accordance with applicable national rules.

ORO.FC.115 Crew resource management (CRM) training

Regulation (EU) No 965/2012

- (a) Before operating, the flight crew member shall have received CRM training, appropriate to his/her role, as specified in the operations manual.
- (b) Elements of CRM training shall be included in the aircraft type or class training and recurrent training as well as in the command course.

AMC1 ORO.FC.115 Crew resource management (CRM) training

ED Decision 2021/002/R

CRM TRAINING — MULTI-PILOT OPERATIONS

(a) General

(1) Training environment

CRM training should be conducted in the non-operational environment (classroom and computer-based) and in the operational environment (flight simulation training device (FSTD) including other training solutions described in CS-FSTD when available and aircraft. Tools such as group discussions, team task analysis, team task simulation and feedback should be used.

(2) Classroom training

Whenever possible, classroom training should be conducted in a group session away from the pressures of the usual working environment, so that the opportunity is provided for flight crew members to interact and communicate in an environment conducive to learning.

(3) Computer-based training (CBT)

Computer-based training should not be conducted as a stand-alone training method but may be conducted as a complementary training method.

Complementary training method in the context of EBT: advanced CBT following the aviation blended learning environment, such as virtual reality, chatbots, interactive scenario trainers, etc. may serve as the principal method to deliver training in the non-operational environment. In such case, the classroom training may be the complementary method.

(4) Flight simulation training devices (FSTDs)

Whenever practicable, parts of the CRM training should be conducted in FSTDs that reproduce a realistic operational environment and permit interaction. This includes but is not limited to line-oriented flight training (LOFT) scenarios.

[applicable until 25 March 2023 — ED Decision 2022/014/R]

- (4) Flight simulation training devices (FSTDs)
- (i) Whenever practicable, parts of the CRM training should be conducted in FSTDs that reproduce a realistic operational environment and permit interaction. This includes but is not limited to line-oriented flight training (LOFT) scenarios.
 - (ii) If the operator proficiency check is conducted in a FSTD, it should include a line-oriented flight during which a complementary CRM assessment should take place, in conditions that reproduce a realistic operational environment.

[applicable from 26 March 2023 — ED Decision 2022/014/R]

(5) Integration into flight crew training

CRM principles should be integrated into relevant parts of flight crew training and operations including checklists, briefings, abnormal and emergency procedures.

(6) Combined CRM training for flight crew, cabin crew and technical crew

- (i) Operators should provide combined training for flight crew, cabin crew and technical crew during recurrent CRM training.
- (ii) The combined training should address at least:
 - (A) effective communication, coordination of tasks and functions of flight crew, cabin crew and technical crew; and
 - (B) mixed multinational and cross-cultural flight crew, cabin crew and technical crew, and their interaction, if applicable.
- (iii) The combined training should be expanded to include medical passengers, if applicable to the operation.
- (iv) Combined CRM training should be conducted by flight crew CRM trainer or cabin crew CRM trainer.
- (v) There should be an effective liaison between flight crew, cabin crew and technical crew training departments. Provision should be made for transfer of relevant knowledge and skills between flight crew, cabin crew and technical crew CRM trainers.

(7) Management system

CRM training should address hazards and risks identified by the operator's management system described in [ORO.GEN.200](#).

(8) Competency-based CRM training

- (i) Whenever practicable, the compliance-based approach concerning CRM training may be substituted by a competency-based approach such as evidence-based training. In this context, CRM training should be characterised by a performance orientation, with emphasis on standards of performance and their measurement, and the development of training to the specified performance standards.
- (ii) CRM training should be an essential element of the alternative training and qualification programme (ATQP) described in [ORO.FC.A.245](#), when the operator applies ATQP.

(9) Contracted CRM training

If the operator chooses not to establish its own CRM training, another operator, a third party or a training organisation may be contracted to provide the training in accordance with [ORO.GEN.205](#). In case of contracted CRM training, the operator should ensure that the content of the course covers the specific culture, the type of operations and the associated procedures of the operator. When crew members from different operators attend the same course, the CRM training should be specific to the relevant flight operations and to the trainees concerned.

(b) Initial operator's CRM training

(1) The flight crew member should complete the initial operator's CRM training once. When the type of operation of a new operator is not different, the new operator should not be required to provide the initial operator's CRM training to this flight crew member a second time.

(2) The initial training should cover all elements specified in Table 1 of (g).

(c) Operator conversion course — CRM training

When the flight crew member undertakes a conversion course with a change of aircraft type or change of operator, elements of CRM training should be integrated into all appropriate phases of the operator's conversion course, as specified in Table 1 of (g).

[applicable until 25 March 2023 — ED Decision 2022/014/R]

When the flight crew member undertakes a conversion course with a change of aircraft type or when joining an operator, elements of CRM training should be integrated into all appropriate phases of the operator's conversion course, as specified in Table 1 of (g).

[applicable from 26 March 2023 — ED Decision 2022/014/R]

(d) Annual recurrent CRM training

(1) Annual recurrent CRM training should be provided in such a way that all CRM training elements specified for the annual recurrent training in Table 1 of (g) are covered over a period not exceeding 3 years.

(2) Operators should update their CRM recurrent training programme over a period not exceeding 3 years. The revision of the programme should take into account information from the operator's management system including the results of the CRM assessment.

(e) Command course — CRM training

The operator should ensure that elements of CRM training are integrated into the command course, as specified in Table 1 of (g).

(f) Training elements

The CRM training elements to be covered are specified in Table 1 of (g). The operator should ensure that the following aspects are addressed:

(1) Automation and philosophy on the use of automation

(i) The CRM training should include training in the use and knowledge of automation, and in the recognition of systems and human limitations associated with the use of automation. The operator should, therefore, ensure that the flight crew member receives training on:

- (A) the application of the operations policy concerning the use of automation as stated in the operations manual; and
 - (B) system and human limitations associated with the use of automation, giving special attention to issues of mode awareness, automation surprises and over-reliance including false sense of security and complacency.
- (ii) The objective of this training should be to provide appropriate knowledge, skills and attitudes for managing and operating automated systems. Special attention should be given to how automation increases the need for crews to have a common understanding of the way in which the system performs, and any features of automation that make this understanding difficult.
- (iii) If conducted in an FSTD, the training should include automation surprises of different origin (system- and pilot-induced).
- (2) Monitoring and intervention
- Flight crew should be trained in CRM-related aspects of operation monitoring before, during and after flight, together with any associated priorities. This CRM training should include guidance to the pilot monitoring on when it would be appropriate to intervene, if felt necessary, and how this should be done in a timely manner. Reference should be made to the operator procedures for structured intervention as specified in the operations manual.
- (3) Resilience development
- CRM training should address the main aspects of resilience development. The training should cover:
- (i) Mental flexibility
- Flight crew should be trained to:
- (A) understand that mental flexibility is necessary to recognise critical changes;
 - (B) reflect on their judgement and adjust it to the unique situation;
 - (C) avoid fixed prejudices and over-reliance on standard solutions; and
 - (D) remain open to changing assumptions and perceptions.
- (ii) Performance adaptation
- Flight crew should be trained to:
- (A) mitigate frozen behaviours, overreactions and inappropriate hesitation; and
 - (B) adjust actions to current conditions.
- (4) Surprise and startle effect
- CRM training should address unexpected, unusual and stressful situations. The training should cover:
- (i) surprises and startle effects; and
 - (ii) management of abnormal and emergency situations, including:
 - (A) the development and maintenance of the capacity to manage crew resources;

- (B) the acquisition and maintenance of adequate automatic behavioural responses; and
 - (C) recognising the loss and re-building situation awareness and control.
- (5) Cultural differences

CRM training should cover cultural differences of multinational and cross-cultural crews. This includes recognising that:

 - (i) different cultures may have different communication specifics, ways of understanding and approaches to the same situation or problem;
 - (ii) difficulties may arise when crew members with different mother tongue communicate in a common language which is not their mother tongue; and
 - (iii) cultural differences may lead to different methods for identifying a situation and solving a problem.
- (6) Operator's safety culture and company culture

CRM training should cover the operator's safety culture, its company culture, the type of operations and the associated procedures of the operator. This should include areas of operations that may lead to particular difficulties or involve unusual hazards.
- (7) Case studies
 - (i) CRM training should cover aircraft type-specific case studies, based on the information available within the operator's management system, including:
 - (A) accident and serious incident reviews to analyse and identify any associated non-technical causal and contributory factors, and instances or examples of lack of CRM; and
 - (B) analysis of occurrences that were well managed.
 - (ii) If relevant aircraft type-specific or operator-specific case studies are not available, the operator should consider other case studies relevant to the scale and scope of its operations.
- (g) CRM training syllabus

Table 1 below specifies which CRM training elements should be covered in each type of training. The levels of training in Table 1 can be described as follows:

 - (1) 'Required' means training that should be instructional or interactive in style to meet the objectives specified in the CRM training programme or to refresh and strengthen knowledge gained in a previous training.
 - (2) 'In-depth' means training that should be instructional or interactive in style taking full advantage of group discussions, team task analysis, team task simulation, etc., for the acquisition or consolidation of knowledge, skills and attitudes. The CRM training elements should be tailored to the specific needs of the training phase being undertaken.

Table 1: Flight crew CRM training

CRM training elements	Initial operator's CRM training	Operator conversion course when changing aircraft type	Operator conversion course when changing operator	Annual recurrent training	Command course
General principles					
Human factors in aviation; General instructions on CRM principles and objectives; Human performance and limitations; Threat and error management.	In-depth	Required	Required	Required	Required
Relevant to the individual flight crew member					
Personality awareness, human error and reliability, attitudes and behaviours, self-assessment and self-critique; Stress and stress management; Fatigue and vigilance; Assertiveness, situation awareness, information acquisition and processing.	In-depth	Not required	Not required	Required	In-depth
Relevant to the flight crew					
Automation and philosophy on the use of automation	Required	In-depth	In-depth	In-depth	In-depth
Specific type-related differences	Required	In-depth	Not required	Required	Required
Monitoring and intervention	Required	In-depth	In-depth	Required	Required
Relevant to the entire aircraft crew					
Shared situation awareness, shared information acquisition and processing; Workload management; Effective communication and coordination inside and outside the flight crew compartment; Leadership, cooperation, synergy, delegation, decision-making, actions; Resilience development; Surprise and startle effect; Cultural differences.	In-depth	Required	Required	Required	In-depth
Relevant to the operator and the organisation					
Operator's safety culture and company culture, standard operating procedures (SOPs), organisational factors, factors linked to the type of operations; Effective communication and coordination with other operational personnel and ground services.	In-depth	Required	In-depth	Required	In-depth
Case studies	In-depth	In-depth	In-depth	In-depth	In-depth

[Table 1 applicable until 25 March 2023 — ED Decision 2022/014/R]

CRM training elements	Initial operator's CRM training	Operator conversion course when changing aircraft type	Operator conversion course when joining an operator	Annual recurrent training	Command course
General principles					
Human factors in aviation; General instructions on CRM principles and objectives; Human performance and limitations; Threat and error management.	In-depth	Not required	Required	Required	Required
Relevant to the individual flight crew member					
Personality awareness, human error and reliability, attitudes and behaviours, self-assessment and self-critique; Stress and stress management; Fatigue and vigilance; Assertiveness, situation awareness, information acquisition and processing.	In-depth	Not required	Required	Required	In-depth
Relevant to the flight crew					
Automation and philosophy on the use of automation	Required	In-depth	In-depth	In-depth	In-depth
Specific type-related differences	Required	In-depth	Not required	Required	Required
Monitoring and intervention	Required	In-depth	In-depth	Required	Required
Relevant to the entire aircraft crew					
Shared situation awareness, shared information acquisition and processing; Workload management; Effective communication and coordination inside and outside the flight crew compartment; Leadership, cooperation, synergy, delegation, decision-making, actions; Resilience development; Surprise and startle effect; Cultural differences.	In-depth	Required	Required	Required	In-depth
Relevant to the operator and the organisation					
Operator's safety culture and company culture, standard operating procedures (SOPs), organisational factors, factors linked to the type of operations; Effective communication and coordination with other operational personnel and ground services.	In-depth	Required	In-depth	Required	In-depth
Case studies	In-depth	In-depth	In-depth	In-depth	In-depth

[Table 1 applicable from 26 March 2023 — ED Decision 2022/014/R]

- (h) Assessment of CRM skills
- (1) Assessment of CRM skills is the process of observing, recording, interpreting and debriefing crews and crew member's performance using an accepted methodology in the context of the overall performance.
 - (2) The flight crew member's CRM skills should be assessed in the operational environment, but not during CRM training in the non-operational environment. Nevertheless, during training in the non-operational environment, feedback from the flight crew CRM trainer or from trainees on individual and crew performance may be given to the crew members concerned.
 - (3) The assessment of CRM skills should:
 - (i) include debriefing the crew and the individual crew member;
 - (ii) serve to identify additional training, where needed, for the crew or the individual crew member; and
 - (iii) be used to improve the CRM training system by evaluating de-identified summaries of all CRM assessments.
 - (4) Prior to the introduction of CRM skills assessment, a detailed description of the CRM methodology, including the required CRM standards and the terminology used for the assessment, should be published in the operations manual.
 - (5) Methodology of CRM skills assessment

The assessment should be based on the following principles:

 - (i) only observable behaviours are assessed;
 - (ii) the assessment should positively reflect any CRM skills that result in enhanced safety; and
 - (iii) assessments should include behaviour that results in an unacceptable reduction in safety margin.
 - (6) Operators should establish procedures, including additional training, to be applied in the event that flight crew members do not achieve or maintain the required CRM standards.

AMC2 ORO.FC.115 Crew resource management (CRM) training

ED Decision 2022/014/R

CRM TRAINING — SINGLE-PILOT OPERATIONS

- (a) For single-pilot helicopter operations with technical crew, [AMC1 ORO.FC.115](#) should be applied.
- (b) For single-pilot operations other than those specified in (a), [AMC1 ORO.FC.115](#) should be applied with the following differences:
 - (1) Relevant training

Training should cover the relevant CRM training, i.e. initial operator's training, the operator conversion course and recurrent training.
 - (2) Relevant training elements

CRM training should focus on the elements specified in Table 1 of (g) of [AMC1 ORO.FC.115](#) which are relevant to single-pilot operations. Therefore, single-pilot CRM training should include, among others:

- (i) situation awareness;
 - (ii) workload management;
 - (iii) decision-making;
 - (iv) resilience development;
 - (v) surprise and startle effect; and
 - (vi) effective communication and coordination with other operational personnel and ground services.
- (3) Virtual classroom training
- Notwithstanding (a)(2) of [AMC1.ORO.FC.115](#), classroom training may take place remotely, using a videoconferencing tool. The tool should permit real-time interaction between the trainees and the trainer, including speech and elements of body language. It should also be capable of transmitting any document to the trainee that the trainer wishes to present. The CRM trainer should establish the list of trainees in advance. Their numbers should be limited to 6 to ensure a sufficient level of interaction during the training session.
- (4) Operation with ELA2 aircraft.
- Notwithstanding (1) and (2), for operations with ELA2 aircraft the relevant CRM training and its duration should be determined by the operator, based on the aircraft type and the complexity of the operation.

AMC3 ORO.FC.115 Crew resource management (CRM) training

ED Decision 2015/022/R

FLIGHT CREW CRM TRAINER

(a) Applicability

The provisions described herein:

- (1) should be fulfilled by flight crew CRM trainers responsible for classroom CRM training; and
- (2) are not applicable to:
 - (i) instructors, holding a certificate in accordance with Commission Regulation (EU) No 1178/2011, who conduct CRM training in the operational environment; and
 - (ii) trainers or instructors conducting training other than CRM training, but integrating CRM elements into this training.

(b) Qualification of flight crew CRM trainer

- (1) A training and standardisation programme for flight crew CRM trainers should be established.
- (2) A flight crew CRM trainer, in order to be suitably qualified, should:
 - (i) have adequate knowledge of the relevant flight operations;
 - (ii) have adequate knowledge of human performance and limitations (HPL), whilst:
 - (A) having obtained a commercial pilot licence in accordance with Commission Regulation (EU) No 1178/2011; or

- (B) having followed a theoretical HPL course covering the whole syllabus of the HPL examination;
 - (iii) have completed flight crew initial operator's CRM training;
 - (iv) have received training in group facilitation skills;
 - (v) have received additional training in the fields of group management, group dynamics and personal awareness; and
 - (vi) have demonstrated the knowledge, skills and credibility required to train the CRM training elements in the non-operational environment, as specified in Table 1 of [AMC1 ORO.FC.115](#).
- (3) The following qualifications and experiences are also acceptable for a flight crew CRM trainer in order to be suitably qualified:
- (i) A flight crew member holding a recent qualification as a flight crew CRM trainer may continue to be a flight crew CRM trainer after the cessation of active flying duties if he/she maintains adequate knowledge of the relevant flight operations.
 - (ii) A former flight crew member may become a flight crew CRM trainer if he/she maintains adequate knowledge of the relevant flight operations and fulfils the provisions of (2)(ii) to (2)(vi).
 - (iii) An experienced CRM trainer may become a flight crew CRM trainer if he/she demonstrates adequate knowledge of the relevant flight operations and fulfils the provisions of (2)(ii) to (2)(vi).
- (c) Training of flight crew CRM trainer
- (1) Training of flight crew CRM trainers should be both theoretical and practical. Practical elements should include the development of specific trainer skills, particularly the integration of CRM into line operations.
 - (2) The basic training of flight crew CRM trainers should include the training elements for flight crew, as specified in Table 1 of [AMC1 ORO.FC.115](#). In addition, the basic training should include the following:
 - (i) introduction to CRM training;
 - (ii) operator's management system;
 - (iii) characteristics, as applicable:
 - (A) of the different types of CRM trainings (initial, recurrent, etc.);
 - (B) of combined training; and
 - (C) related to the type of aircraft or operation; and
 - (iv) assessment.
 - (3) The refresher training of flight crew CRM trainers should include new methodologies, procedures and lessons learned.
 - (4) Instructors, holding a certificate in accordance with Commission Regulation (EU) No 1178/2011, who are also CRM trainers, may combine the CRM trainer refresher training with instructor refresher training.

- (5) Instructors for other-than complex motor-powered aircraft should be qualified as flight crew CRM trainers for this aircraft category with no additional training, as specified in (2) and (3) when:
 - (i) holding a certificate in accordance with Commission Regulation (EU) No 1178/2011; and
 - (ii) fulfilling the provisions of (b)(2) or (b)(3).
 - (6) The training of flight crew CRM trainers should be conducted by flight crew CRM trainers with a minimum of 3 years' experience. Assistance may be provided by experts in order to address specific areas.
- (d) Assessment of flight crew CRM trainer
- (1) A flight crew CRM trainer should be assessed by the operator when conducting the first CRM training course. This first assessment should be valid for a period of 3 years.
 - (2) The operator should ensure that the process for the assessment is included in the operations manual describing methods for observing, recording, interpreting and debriefing the flight crew CRM trainer. All personnel involved in the assessment must be credible and competent in their role.
- (e) Recency and renewal of qualification as flight crew CRM trainer
- (1) For recency of the 3-year validity period, the flight crew CRM trainer should:
 - (i) conduct at least 2 CRM training events in any 12-month period;
 - (ii) be assessed within the last 12 months of the 3-year validity period by the operator; and
 - (iii) complete CRM trainer refresher training within the 3-year validity period.
 - (2) The next 3-year validity period should start at the end of the previous period.
 - (3) For renewal, i.e. when a flight crew CRM trainer does not fulfil the provisions of (1), he/she should, before resuming as flight crew CRM trainer:
 - (i) comply with the qualification provisions of (b) and (d); and
 - (ii) complete CRM trainer refresher training.

[applicable until 25 March 2023 — ED Decision 2022/014/R]

GM1 ORO.FC.115 Crew resource management (CRM) training

ED Decision 2015/022/R

GENERAL

- (a) CRM is the effective utilisation of all available resources (e.g. crew members, aircraft systems, supporting facilities and persons) to achieve safe and efficient operation.
- (b) The objective of CRM is to enhance the communication and management skills of the flight crew member concerned. Emphasis is placed on the non-technical knowledge, skills and attitudes of flight crew performance.

GM2 ORO.FC.115 Crew resource management (CRM) training

ED Decision 2015/022/R

TRAINING ENVIRONMENT, TRAINERS AND INSTRUCTORS

- (a) Flight crew CRM training can be separated as follows:
 - (1) training in the non-operational environment:
 - (i) classroom; and
 - (ii) computer-based;
 - (2) training in the operational environment:
 - (i) flight simulation training device (FSTD); and
 - (ii) aircraft.
- (b) In general, CRM training is provided as follows:
 - (1) classroom training by a flight crew CRM trainer;
 - (2) training in the operational environment by an instructor holding a certificate in accordance with Commission Regulation (EU) No 1178/2011;
 - (3) computer-based training as a self-study training method. If needed, directions concerning CRM-related issues are provided by a flight crew CRM trainer or by an instructor holding a certificate in accordance with Commission Regulation (EU) No 1178/2011.

GM3 ORO.FC.115 Crew resource management (CRM) training

ED Decision 2022/014/R

MINIMUM TRAINING TIMES

- (a) The following minimum training times are appropriate:
 - (1) multi-pilot operations:
 - (i) combined CRM training: 6 training hours over a period of 3 years, or, for EBT operators, a minimum of 3 training hours within 3 years; and
 - (ii) initial operator's CRM training: 18 training hours with a minimum of 12 training hours in classroom training;
 - (2) initial operator's CRM training for single-pilot operations: 6 training hours; and
 - (3) flight crew CRM trainer:
 - (i) basic training:
 - (A) 18 training hours for trainees holding an instructor certificate for complex motor-powered aircraft, as specified in Commission Regulation (EU) No 1178/2011, which includes 25-hour training in teaching and learning; or
 - (B) 30 training hours for trainees who do not hold an instructor certificate as specified in (A); and
 - (ii) refresher training: 6 training hours.

- (b) 'Training hours' means actual training time excluding breaks and assessment.

GM4 ORO.FC.115 Crew resource management (CRM) training

ED Decision 2015/022/R

DESIGN, IMPLEMENTATION AND EVALUATION OF CRM TRAINING

The checklist in Table 1 provides guidance on the design, implementation and evaluation of CRM training, and on their incorporation into the operator's safety culture. Elements of the operator's management systems and the competency-based approach are incorporated in the checklist.

Table 1 — Checklist for design, implementation, evaluation and incorporation of CRM training

Step No	Description	Element
1	Needs analysis	Determine the necessary CRM competencies
		Develop CRM training goals
		Ensure the organisation is ready for CRM training
2	Design	Develop CRM training objectives
		Determine what to measure and how to measure it
3	Development	Describe the CRM learning environment
		Develop full-scale prototype of training
		Validate and modify CRM training
4	Implementation	Prepare trainees and environment
		Set a climate for learning (e.g. practice and feedback)
		Implement the CRM training programme
5	Evaluation	Determine training effectiveness
		Evaluate CRM training at multiple levels
		Revise the CRM training programme to improve effectiveness
6	Incorporation	Establish an environment where CRM training is positively recognised
		Reinforce CRM behaviours in daily work
		Provide recurrent CRM training

GM5 ORO.FC.115 Crew resource management (CRM) training

ED Decision 2015/022/R

RESILIENCE DEVELOPMENT

- (a) The main aspects of resilience development can be described as the ability to:
- (1) learn ('knowing what has happened');
 - (2) monitor ('knowing what to look for');
 - (3) anticipate ('finding out and knowing what to expect'); and
 - (4) respond ('knowing what to do and being capable of doing it').
- (b) Operational safety is a continuous process of evaluation of and adjustment to existing and future conditions. In this context, and following the description in (a), resilience development involves an ongoing and adaptable process including situation assessment, self-review, decision and action. Training in resilience development enables crew members to draw the right conclusions from both positive and negative experiences. Based on those experiences, crew

members are better prepared to maintain or create safety margins by adapting to dynamic complex situations.

- (c) The training topics in (f)(3) of [AMC1 ORO.FC.115](#) are to be understood as follows:
- (1) Mental flexibility
 - (i) The phrase ‘understand that mental flexibility is necessary to recognise critical changes’ means that crew members are prepared to respond to situations for which there is no set procedure.
 - (ii) The phrase ‘reflect on their judgement and adjust it to the unique situation’ means that crew members learn to review their judgement based on the unique characteristics of the given circumstances.
 - (iii) The phrase ‘avoid fixed prejudices and over-reliance on standard solutions’ means that crew members learn to update solutions and standard response sets, which have been formed on prior knowledge.
 - (iv) The phrase ‘remain open to changing assumptions and perceptions’ means that crew members constantly monitor the situation, and are prepared to adjust their understanding of the evolving conditions.
 - (2) Performance adaptation
 - (i) The phrase ‘mitigate frozen behaviours, overreactions and inappropriate hesitation’ means that crew members correct improper actions with a balanced response.
 - (ii) The phrase ‘adjust actions to current conditions’ means that crew members’ responses are in accordance with the actual situation.

GM6 ORO.FC.115 Crew resource management (CRM) training

ED Decision 2015/022/R

NON-TECHNICAL SKILLS ASSESSMENT

- (a) NOTECHS (non-technical skills) is a validated method for assessing flight crew CRM skills.

The NOTECHS framework consists of four main categories:

- (1) Cooperation: Cooperation is the ability to work effectively in a crew.
 - (2) Leadership and managerial skills: Effective leadership and managerial skills help to achieve joint task completion within a motivated, fully functioning team through coordination and persuasiveness.
 - (3) Situation awareness: Situation awareness relates to one’s ability to accurately perceive what is in the flight crew compartment and outside the aircraft. It is also one’s ability to comprehend the meaning of different elements in the environment and the projection of their status in the near future.
 - (4) Decision-making: Decision-making is the process of reaching a judgement or choosing an option.
- (b) Each of the four categories is subdivided into elements and behavioural markers. The elements are specified in Table 1 with examples of behavioural markers (effective behaviour). The behavioural markers are assessed by a rating scale to be established by the operator.

Table 1 – Categories, elements and behavioural markers of NOTECBS

Category	Element	Behavioural marker (examples)
Cooperation	Team building and maintaining	Establishes atmosphere for open communication and participation
	Considering others	Takes condition of other crew members into account
	Supporting others	Helps other crew members in demanding situations
	Conflict solving	Concentrates on what is right rather than who is right
Leadership and managerial skills	Use of authority and assertiveness	Takes initiative to ensure crew involvement and task completion
	Maintaining standards	Intervenes if task completion deviates from standards
	Planning and coordination	Clearly states intentions and goals
	Workload management	Allocates adequate time to complete tasks
Situation awareness	Awareness of aircraft systems	Monitors and reports changes in systems' states
	Awareness of external environment	Collects information about environment (position, weather and traffic)
	Anticipation	Identifies possible future problems
Decision-making	Problem definition and diagnosis	Reviews causal factors with other crew members
	Option generation	States alternative courses of action
		Asks other crew members for options
	Risk assessment and option selection	Considers and shares estimated risk of alternative courses of action
Outcome review	Checks outcome against plan	

GM7 ORO.FC.115 Crew resource management (CRM) training

ED Decision 2015/022/R

FLIGHT CREW CRM TRAINER ASSESSMENT

- (a) For assessing flight crew CRM trainers, the operator may nominate experienced flight crew CRM trainers who have demonstrated continued compliance with the provisions for a flight crew CRM trainer and capability in that role for at least 3 years.
- (b) An operator that does not have the resources to conduct the assessment may employ a contractor. The standard as regards the assessment is confirmed on a 3-year basis by the operator.
- (c) The checklist in Table 1 provides guidance on the assessment of a flight crew CRM trainer. If a flight crew CRM trainer is competent in his/her role, the response to the questions in Table 1 should be 'yes'. When answering the questions in Table 1, justifications and examples related to the responses given should be provided.

Table 1 – Flight crew CRM trainer assessment checklist

Questions to assess a flight crew CRM trainer	Response yes/no
Did the CRM trainer demonstrate the knowledge required for the role?	
Did the CRM trainer support CRM concepts?	
Did the CRM trainer encourage trainees to participate, share their experiences and self-analyse?	

Did the CRM trainer identify and respond to the trainees' needs relative to expertise/experience?	
Did the CRM trainer show how CRM is integrated in technical training and line operations?	
Did the CRM trainer incorporate company CRM standards when appropriate?	
Did the CRM trainer identify and discuss the non-technical reasons involved in accidents, incidents and events included in case studies?	
Did the CRM trainer regularly check for understanding and resolve ambiguities?	
Did the CRM trainer demonstrate effective instruction and facilitation skills?	

GM8 ORO.FC.115 Crew resource management (CRM) training

ED Decision 2022/014/R

VIRTUAL CLASSROOM TRAINING — SINGLE-PILOT OPERATIONS

- (a) A successful virtual classroom training relies on the ability of the trainer to make best use of the associated technologies in the context of CRM training. The flight crew CRM trainer may need to receive appropriate training covering the following:
- (1) learning style;
 - (2) teaching method associated with virtual classroom instruction, such as videoconferencing, and a familiarisation with the virtual classroom instruction system in use, including management of time, training media and equipment and tools.
- (b) The assessment of CRM skills may be used by the operator to improve the CRM training system by evaluating de-identified summaries of all CRM assessments.
- (c) The requirement of [ORO.GEN.140](#) for the operator to grant access to the competent authority also applies to the virtual classroom training.
- (d) More information on virtual classroom training is provided in the EASA Guidance for allowing virtual classroom instruction and distance learning.

ORO.FC.120 Operator conversion training

Regulation (EU) No 965/2012

- (a) In the case of aeroplane or helicopter operations, the flight crew member shall complete the operator conversion training course before commencing unsupervised line flying:
- (1) when changing to an aircraft for which a new type or class rating is required;
 - (2) when joining an operator.
- (b) The operator conversion training course shall include training on the equipment installed on the aircraft as relevant to flight crew members' roles.

AMC1 ORO.FC.120 Operator conversion training

ED Decision 2022/014/R

OPERATOR CONVERSION TRAINING FOR NON-COMMERCIAL OPERATIONS WITH COMPLEX MOTOR-POWERED AIRCRAFT (NCC)

- (a) General
- (1) The operator conversion training should include:

- (i) ground training, including the following:
 - (A) aircraft systems;
 - (B) normal procedures, which include flight planning, ground-handling and flight operations, including performance, mass and balance, fuel schemes, selection of alternates, and ground de-icing/anti-icing;
 - (C) abnormal and emergency procedures, which include pilot incapacitation, as applicable;
 - (D) a review of relevant samples of accidents/incidents and occurrences to increase awareness of the occurrences that may be relevant for the intended operation;
 - (ii) emergency and safety equipment training and checking, including survival equipment training (completed before operating on any passenger-carrying flight);
 - (iii) passenger handling for operations where no cabin crew is carried; and
 - (iv) a minimum number of sectors and/or flight hours operated under the supervision of a flight crew member nominated by the operator, to demonstrate the standard of qualification specified in the operator's manual.
- (2) The operator conversion course may be combined with a new type rating course, as required by [Commission Regulation \(EU\) No 1178/2011](#).
- (3) The conversion training should ensure that each flight crew member:
- (i) has been trained to competency on the emergency and safety equipment installed on the aircraft they are to operate; and
 - (ii) is competent in the operating procedures and the use of checklists used by the operator.
- (b) Emergency and safety equipment training should:
- (1) take place in conjunction with cabin crew and technical crew as far as practicable. Emphasis should be placed on the importance of effective coordination and two-way communication between crew members in various emergency situations;
 - (2) address the operational procedures of rescue and emergency services; and
 - (3) cover the items of point (a)(2) of [AMC1 ORO.FC.130](#).

[applicable from 26 March 2023 — ED Decision 2022/014/R]

AMC2 ORO.FC.120 Operator conversion training

ED Decision 2022/014/R

FORM OF OPERATIONS — SINGLE-PILOT HELICOPTERS

The training for conversion from single-pilot operations to multi-pilot operations and vice versa on a given helicopter type, as specified in point FCL.725(d)(2) of Annex I (Part-FCL) to [Regulation \(EU\) No 1178/2011](#), should take into account all of the following:

- (a) the SOPs of the operator;
- (b) the flight crew member's previous trainings and experience.

AMC3 ORO.FC.120 Operator conversion training

ED Decision 2022/014/R

SPO OPERATOR CONVERSION COURSE — GROUND TRAINING

(a) General

The operator conversion training should include ground training and checking, including all of the following:

- (1) aircraft systems,
- (2) normal procedures, which include flight planning ground-handling and flight operations, including performance, mass and balance, fuel schemes selection of alternates, and ground de-icing/anti-icing;
- (3) abnormal and emergency procedures, which include pilot incapacitation as applicable;
- (4) a review of relevant samples of accident/incident and occurrences to increase awareness of the occurrences that may be relevant for the intended operation.

SPECIALISED OPERATIONS

If a flight crew member undergoes training with regard to SOPs related to a specialised operation, either as part of an equipment and procedure training or a conversion training, the following should apply:

(b) Initial training for a given specialised operation

- (1) In-depth training should achieve competence in carrying out normal, abnormal and emergency procedures, covering the SOPs associated with the specialised task.
- (2) The training should include ground training associated with the specialised task, completed before any flight training in an aircraft commences.
- (3) If one or more task specialists are on board, the training should include emergency and safety equipment training, completed before any flight training in an aircraft commences. The training should ensure that all emergency equipment can be used timely and efficiently, that an emergency evacuation and first aid can be conducted, taking into account the training and operating procedures of the task specialist(s).
- (4) Unless the flight crew member has significant experience in similar specialised operations as defined in the operations manual, the training should include aircraft/FSTD training associated with the specialised task.

(c) Initial training and experience for any level of HEC and HESLO operations: [AMC1 SPO.SPEC.HEC.100](#) and [AMC1 SPO.SPEC.HESLO.100](#) should apply in combination with point (b) above.

(d) Training when changing operators

- (1) The training should focus on the elements of the SOPs that are specific to the operator.
- (2) The operator should determine the amount of training required in the operator's conversion course in accordance with the standards of qualification and experience specified in the operations manual, taking into account the flight crew member's previous training and experience in the given specialised operation and in similar operations.

(e) Training when changing specialised operations within the same operator, with previous experience of the specialised operation: point (d) above should apply.

- (f) Training when changing types or variants: The training should focus on the elements of the SOPs that are specific to the type or variant. The operator should assess whether the flight crew should require ground training, aircraft/FSTD training or both, when changing type or variants within the framework of the same specialised operations. The assessment should take the following into account:
- (1) the validity of the flight crew type rating;
 - (2) the experience and recency of the flight crew on the type or variant;
 - (3) whether any type or variant specific procedures exist;
 - (4) differences in equipment related to the specialised operations;
 - (5) differences in limitations or procedures related to the specialised operations.

[applicable from 26 March 2023 — ED Decision 2022/014/R]

GM1 ORO.FC.120 Operator conversion training

ED Decision 2022/014/R

STANDARD OPERATING PROCEDURES FOR MULTI-PILOT OPERATIONS — SINGLE-PILOT HELICOPTERS

MCC training is generic to all types. A pilot holding a certificate of completion of MCC training requires additional training to implement the multi-pilot SOPs of a given helicopter type.

AMC1 ORO.FC.120&130 Operator conversion training and checking & recurrent training and checking

ED Decision 2019/005/R

FLIGHT PATH MANAGEMENT (MANUAL OR AUTOMATIC, AS APPROPRIATE) DURING UNRELIABLE AIRSPEED INDICATION AND OTHER FAILURES AT HIGH ALTITUDE IN AEROPLANES WITH A MAXIMUM CRUISING ALTITUDE ABOVE FL300

For the operation of aeroplanes with a maximum cruising altitude above FL300, training elements from the following table should be integrated into:

- (a) operator conversion training; and
- (b) recurrent training at least every 12 calendar months, such that all elements are covered over a period not exceeding 3 years:

Element	Theoretical Knowledge	Practical training
Basic flight physics principles concerning flight at high altitude, with a particular emphasis on the relative proximity of the critical Mach number and the stall, pitch behaviour, and an understanding of the reduced stall angle of attack when compared with low-altitude flight.	•	•
Interaction of the automation (autopilot, flight director, auto-throttle/auto-thrust) and the consequences of failures inducing disconnection of the automation.	•	•
Consequences of an unreliable airspeed indication and other failures at high altitude and the need for the flight crew to promptly identify the failure and react with appropriate (minimal) control inputs to keep the aircraft in a safe envelope.	•	•

Degradation of fly-by-wire (FBW) flight control laws/modes and its consequence on aircraft stability and flight envelope protections, including stall warnings.	•	•
Practical training, using appropriate simulators, on manual handling at high altitude in normal and non-normal flight control laws/modes, with particular emphasis on pre-stall buffet, the reduced stall angle of attack when compared with low-altitude flight and the effect of pitch inputs on the aircraft trajectory and energy state.		•
The requirement to promptly and accurately apply the stall recovery procedure, as provided by the aircraft manufacturer, at the first indication of an impending stall. Differences between high-altitude and low-altitude stalls must be addressed.	•	•
Procedures for taking over and transferring manual control of the aircraft, especially for FBW aeroplanes with independent side-sticks.	•	•
Task sharing and crew coordination in high workload/stress conditions with appropriate call-out and acknowledgement to confirm changes to the aircraft flight control law/mode.	•	•

ORO.FC.125 Differences training, familiarisation, equipment and procedure training

Regulation (EU) 2021/2237

- (a) Flight crew members shall complete differences training or familiarisation when required by Annex I (Part- FCL) to [Regulation \(EU\) No 1178/2011](#).
- (b) Flight crew members shall complete equipment and procedure training when changing equipment or changing procedures requiring additional knowledge on types or variants currently operated.
- (c) The operations manual shall specify when such differences training or familiarisation or equipment and procedure training is required.

AMC1 ORO.FC.125 Differences training, familiarisation, equipment and procedure training

ED Decision 2022/014/R

GENERAL

- (a) Differences training requires additional knowledge and training on the aircraft or an appropriate training device. It should be carried out:
 - (1) in the case of aeroplanes, when operating another variant of an aeroplane of the same type or another type of the same class currently operated; or
 - (2) in the case of helicopters, when operating a variant of a helicopter currently operated.
- (b) Familiarisation requires only the acquisition of additional knowledge. It should be carried out when operating another helicopter or aeroplane of the same type.

AMC2 ORO.FC.125 Differences training, familiarisation, equipment and procedure training

ED Decision 2022/014/R

OPERATOR DIFFERENCE REQUIREMENTS (ODRs)

When defining the needs for differences training, familiarisation or equipment training, the operator should make use of the concept of ODRs and of the methodology described in [AMC1 ORO.FC.140\(a\)](#), including the ODRs tables.

FORM OF OPERATIONS — SINGLE-PILOT HELICOPTERS

If the differences training, familiarisation, equipment or procedure training includes the conversion from single-pilot operations to multi-pilot operations and vice versa, it should take into account all elements described in [AMC2 ORO.FC.120](#).

GM1 ORO.FC.125 Differences training, familiarisation, equipment and procedure training

ED Decision 2022/014/R

OPERATOR DIFFERENCE REQUIREMENTS (ODRs)

The ODRs tables may result in different training programmes, depending on the training needs, regardless of the 'base aircraft' used to establish the table (e.g. the trainee may know the 'other aircraft' and be trained towards the 'base aircraft').

AMC1 ORO.FC.125(b) Differences training, familiarisation, equipment and procedure training

ED Decision 2022/014/R

SPECIALISED OPERATIONS

If the differences training, familiarisation, equipment and procedure training includes training for SOPs related to a specialised operation, points (b) to (f) of [AMC3 ORO.FC.120](#) should apply.

[applicable from 26 March 2023]

GM1 ORO.FC.125(b) Differences training, familiarisation, equipment and procedure training

ED Decision 2022/014/R

GENERAL

Introducing a change of equipment and/or procedures on types or variants currently operated may require additional knowledge or additional training on the aircraft, or an appropriate training device, or both.

GM2 ORO.FC.125(b) Differences training, familiarisation, equipment and procedure training

ED Decision 2022/014/R

PROCEDURE TRAINING — STANDARD OPERATING PROCEDURES FOR MULTI-PILOT OPERATIONS — SINGLE-PILOT HELICOPTERS

MCC training is generic to all types. A pilot holding a certificate of completion of MCC training requires additional procedures training to implement the multi-pilot SOPs of a given single-pilot helicopter type.

ORO.FC.130 Recurrent training and checking

Regulation (EU) 2021/2237

- (a) Each flight crew member shall complete annual recurrent flight and ground training relevant to the type or variant, and associated equipment of aircraft on which he or she operates, including training on the location and use of all emergency and safety equipment carried on board the aircraft.
- (b) Each flight crew member shall be periodically checked to demonstrate competence in carrying out normal, abnormal and emergency procedures.

AMC1 ORO.FC.130 Recurrent training and checking

ED Decision 2022/014/R

RECURRENT TRAINING AND CHECKING TO DEMONSTRATE COMPETENCE FOR NON-COMMERCIAL OPERATIONS WITH COMPLEX MOTOR-POWERED AIRCRAFT (NCC)

- (a) Recurrent training
 - Recurrent training should comprise the following:
 - (1) Ground training
 - The ground training programme should include:
 - (i) aircraft systems;
 - (ii) normal procedures, which include flight planning, ground-handling and flight operations, including performance, mass and balance, fuel schemes, selection of alternates, and ground de-icing/anti-icing;
 - (iii) abnormal and emergency procedures, which include pilot incapacitation as applicable;
 - (iv) a review of relevant samples of accidents/incidents and occurrences to increase awareness of the occurrences that may be relevant for the intended operation;
 - (2) Emergency and safety equipment training
 - (i) Emergency and safety equipment training may be combined with emergency and safety equipment checking and should be conducted in an aircraft or a suitable alternative training device.
 - (ii) Every year the emergency and safety equipment training programme should include the following:
 - (A) actual donning of a life jacket, where fitted;

- (B) actual donning of protective breathing equipment, where fitted;
 - (C) actual handling of fire extinguishers of the type used;
 - (D) instruction on the location and use of all emergency and safety equipment carried on the aircraft; and
 - (E) instruction on the location and use of all types of exits.
- (3) Elements of CRM as specified in Table 1 of [AMC1 ORO.FC.115](#) should be integrated into all appropriate phases of recurrent training.
- (4) Aircraft/FSTD training
- (i) The aircraft/FSTD training programme should be established in such a way that all the major failures of aircraft systems and associated procedures will have been covered in the preceding 3-year period.
 - (ii) When engine-out manoeuvres are carried out in an aircraft, the engine failure should be simulated.
 - (iii) When an FSTD is not available or accessible, the operator should establish mitigating measures to ensure that an adequate level of safety is maintained when conducting the training or checking in an aircraft. If one or more of the major failures cannot be practised in the aircraft because of their associated risks or because of environmental considerations, the failure(s) may be partially replicated for crew training purposes using pre-briefed, risk-assessed measures that avoid degrading the aircraft's performance below a predetermined level, and which permit immediate reversion to normal operating conditions.
- (b) Periodic check to demonstrate competence
- (1) Each flight crew member should complete the periodic check as part of the normal crew complement.
 - (2) Periodic demonstrations of competence should be conducted every 12 months and may be combined with the proficiency check required by [Commission Regulation \(EU\) No 1178/2011](#).

[applicable from 26 March 2023]

GM1 ORO.FC.130 Recurrent training and checking

ED Decision 2022/014/R

PERIODIC CHECKS

- (a) For CAT operations, the operator proficiency checks and the line checks are both part of the periodic checks. For EBT operators, the EBT module and the line evaluations of competence are both part of the periodic checks.
- (b) For SPO operations, the operator proficiency checks are part of the periodic checks.
- (c) For non-CAT operations, the periodic checks may include a line check.

AMC1 ORO.FC.130(a) Recurrent training and checking

ED Decision 2022/014/R

OPERATIONS WITH VARIATIONS IN AIRCRAFT CONFIGURATION

[AMC1 ORO.FC.140\(a\)](#) should be used to determine the recurrent ground training and checking relevant to variations in aircraft configuration, if all of the following apply:

- (a) the pilot operates variations in aircraft configuration;
- (b) the aircraft operated do not all belong to the same group of types defined under [ORO.FC.140\(b\)](#); and
- (c) credit (as defined in point (a)(4) of [AMC1 ORO.FC.140\(a\)](#)) is sought.

ORO.FC.135 Pilot qualification to operate in either pilot's seat

Regulation (EU) No 965/2012

Flight crew members who may be assigned to operate in either pilot's seat shall complete appropriate training and checking as specified in the operations manual.

AMC1 ORO.FC.135 Pilot qualification to operate in either pilot's seat

ED Decision 2022/014/R

GENERAL

The training and checking for pilot qualification to operate in either pilot's seat should include any safety-critical items as specified in the operations manual where the action to be taken by the pilot is different depending on which seat they occupy.

NON-COMMERCIAL OPERATIONS WITH COMPLEX MOTOR-POWERED AIRCRAFT (NCC)

Training should be arranged so that all such items will have been covered in the preceding 3-year period.

[applicable from 26 March 2023]

ORO.FC.140 Operation on more than one type or variant

Regulation (EU) No 2021/2237

- (a) Flight crew members that operate more than one type or variant of aircraft shall comply with the requirements prescribed in this Subpart for each type or variant, unless credits related to the training, checking, and recent experience requirements are defined in the mandatory part of the operational suitability data established in accordance with [Regulation \(EU\) No 748/2012](#) for the relevant types or variants.
- (b) The operator may define groups of single-engined helicopter types. An operator proficiency check on one type shall be valid for all the other types within the group if both of the following conditions are met:
 - (1) the group either includes only single-engined turbine helicopters operated under VFR or it includes only single-engined piston helicopters operated under VFR;
 - (2) for CAT operations, at least two operator proficiency checks per type shall be conducted within a 3-year cycle.
- (c) For specialised operations, elements of the aircraft/FSTD training and operator proficiency check that cover the relevant aspects associated with the specialised task and are not related

to the type or group of types may be credited towards the other groups or types, based on a risk assessment performed by the operator.

- (d) For operations on more than one helicopter type or variant that are used for conducting sufficiently similar operations, if line checks rotate between types or variants, each line check shall revalidate the line check for the other helicopter types or variants.
- (e) Appropriate procedures and any operational restrictions shall be specified in the operations manual for any operation on more than one type or variant.

GM1 ORO.FC.140 Operation on more than one type or variant

ED Decision 2022/014/R

GENERAL

- (a) The concept of operating more than one type or variant depends on the experience, knowledge and ability of the operator and the flight crew concerned.
- (b) The first consideration is whether operations on one aircraft type or variant allow the safe operation of all other types and variants.
- (c) The second consideration is whether and how adequate training to address potential confusion and increased workload caused by the operation of several types or variants is achieved.

AMC1 ORO.FC.140(a) Operation on more than one type or variant

ED Decision 2022/014/R

GENERAL

- (a) Terminology

The terms used in the context of operation on more than one type or variant have the following meaning:

- (1) 'Base aircraft' refers to an aircraft used as a reference to compare differences with another aircraft.
- (2) 'Variant' refers to an aircraft or a group of aircraft within the same pilot type or class rating that has differences with the base aircraft and requires differences training or familiarisation.
- (3) A 'variation in aircraft configuration' refers to an aircraft or a group of aircraft within the same variant that has differences with the base aircraft and requires equipment and procedure training.
- (4) 'Credit' refers to the recognition of recurrent training, checking or recent experience based on commonalities between aircraft.
- (5) 'Operator difference requirements (ODRs)' refer to a formal description of differences between types or variants or aircraft configurations flown by a particular operator.
- (6) 'Training' refers to differences training, familiarisation and equipment training.
- (7) 'Currency' refers to the recurrent training on types and variants.

- (b) Scope of ODRs

The operator should use the ODRs methodology, a means of evaluating aircraft differences and similarities, in order to define the training and checking in the following cases:

- (1) for the introduction of a change of equipment on a type or variant currently operated;
 - (2) for the introduction of a new variant within a type or class currently operated;
 - (3) for the recurrent training and checking of variations in aircraft configuration. The operator may define credit based on ODRs tables;
 - (4) for the operation of more than one type or variant when credit is sought, in which case all of the following should apply:
 - (i) All training, checking and currency requirements should be completed independently for each type or variant unless credits have been established by using ODRs tables.
 - (ii) All recent experience requirements should be completed independently for each type unless credits have been established by using ODRs tables.
 - (iii) The operator may define credit based on ODRs tables that should not be less restrictive than the OSD.
- (c) ODRs methodology
- (1) The operator should conduct a detailed evaluation of the differences or similarities of the aircraft concerned in order to establish appropriate procedures or operational restrictions. This evaluation should be based on the OSD for the relevant types or variants and should be adapted to the operator's specific variations in aircraft configuration. This evaluation should take into account all of the following:
 - (i) the level of technology;
 - (ii) operational procedures; and
 - (iii) handling characteristics.
 - (2) ODRs tables

The operator should first nominate one aircraft as the base aircraft from which to show differences with the second aircraft type or variant or variation in aircraft configuration, the 'difference aircraft', in terms of technology (systems), procedures, pilot handling and aircraft management. These differences, known as ODRs, preferably presented in tabular format, constitute part of the justification for operating more than one type or variant and also the basis for the associated differences/familiarisation or reduced type rating training for the flight crew.
 - (3) The ODRs tables should be presented as follows:

GENERAL OPERATOR DIFFERENCE REQUIREMENTS TABLE										
DIFFERENCE AIRCRAFT: BASE AIRCRAFT:				COMPLIANCE METHOD						
				TRAINING					CHECKING/ CURRENCY	
General	Differences	Flt char	Proc chg	A	B	C	D	E	FLT CHK	CURR ENCY
GENERAL	Range ETOPS certified	No	Yes		CBT					
DIMENSIONS	Configuration per AFM, FCOM	Yes	No		CBT					

SYSTEM OPERATOR DIFFERENCE REQUIREMENTS TABLE										
DIFFERENCE AIRCRAFT: BASE AIRCRAFT:				COMPLIANCE METHOD						
				TRAINING					CHECKING/ CURRENCY	
System	Differences	Flt char	Proc chg	A	B	C	D	E	FLT CHK	CURR ENCY
21 – AIR CONDITIONING	CONTROLS AND INDICATORS: - Panel layout	No	Yes	HO						
21 – AIR CONDITIONING	PACKS: - Switch type - Automatically controlled - Reset switch for both packs	No	Yes		CBT					

MANOEUVRE OPERATOR DIFFERENCE REQUIREMENTS TABLE										
DIFFERENCE AIRCRAFT: BASE AIRCRAFT:				COMPLIANCE METHOD						
				TRAINING					CHECKING/ CURRENCY	
Manoeuvre	Differences	Flt char	Proc chg	A	B	C	D	E	FLT CHK	CURR ENCY
Exterior Preflight	Minor differences	No	No	HO						
Preflight	Differences due to systems, ECL	No	Yes		CBT	FTD				
Normal take-off	FBW handling v conventional; AFDS TAKE-OFF: Autothrottle engagement FMA indications	No	Yes		CBT			FFS		

(4) Compilation of ODRs tables

(i) ODRs 1: General

The general characteristics of the candidate aircraft are compared with the base aircraft with regard to:

- (A) general dimensions and aircraft design (number and type of rotors, wing span or category);
 - (B) flight deck general design;
 - (C) cabin layout;
 - (D) engines (number, type and position);
 - (E) limitations (flight envelope).
- (ii) ODRs 2: Systems
- Consideration is given to differences in design between the candidate aircraft and the base aircraft. For this comparison, the Air Transport Association (ATA) 100 index is used. This index establishes a system and subsystem classification and then an analysis is performed for each index item with respect to the main architectural, functional and operations elements, including controls and indications on the systems control panel.
- (iii) ODRs 3: Manoeuvres
- Operational differences encompass normal, abnormal and emergency situations and include any change in aircraft handling and flight management. It is necessary to establish a list of operational items for consideration on which an analysis of differences can be made.
- The operational analysis should take the following into account:
- (A) flight deck dimensions (size, cut-off angle and pilot eye height);
 - (B) differences in controls (design, shape, location and function);
 - (C) additional or altered function (flight controls) in normal or abnormal conditions;
 - (D) handling qualities (including inertia) in normal and in abnormal configurations;
 - (E) aircraft performance in specific manoeuvres;
 - (F) aircraft status following failure;
 - (G) management (e.g. ECAM, EICAS, navaid selection, automatic checklists).
- (iv) Once the differences for ODRs 1, ODRs 2 and ODRs 3 have been established, the consequences of differences evaluated in terms of flight characteristics (FLT CHAR) and change of procedures (PROC CHNG) should be entered into the appropriate columns.
- (v) Difference levels — crew training, checking and currency
- (A) In order to operate more than one type or variant, the operator should establish crew training, checking and currency requirements. This may be done by applying the coded difference levels from the table in point (d)(2) to the compliance method column of the ODRs tables.
 - (B) Differences identified in the ODRs tables as impacting flight characteristics or procedures, should be analysed in the corresponding ATA section of the ODRs manoeuvres. Normal, abnormal and emergency situations should be addressed accordingly.

(d) Difference levels

(1) Difference levels — general

Difference levels are used to identify the extent of a difference between a base and a candidate aircraft with reference to the elements described in the ODRs tables. These levels are proportionate to the differences between a base and a candidate aircraft. A range of five difference levels in order of increasing requirements, identified as A through E, are each specified for training, checking, and currency.

Difference levels apply when a difference with the potential to affect flight safety exists between a base and a candidate aircraft. Differences may also affect the knowledge, skills, or abilities required from a pilot. If no differences exist, or if differences exist but do not affect flight safety, or if differences exist but do not affect knowledge, skills or abilities, then difference levels are neither assigned nor applicable to pilot qualification. When difference levels apply, each level is based on a scale of differences related to design features, systems, or manoeuvres. In assessing the effects of differences, both flight characteristics and procedures are considered since flight characteristics address handling qualities and performance, while procedures include normal, non-normal and emergency items.

Levels for training, checking, and currency are assigned independently, but are linked depending on the differences between a base and candidate aircraft. Training at level E usually identifies that the candidate aircraft is a different type from the base aircraft.

(2) Difference levels are summarised in the table below regarding training, checking, and currency.

DIFFERENCE LEVEL	TRAINING	CHECKING	CURRENCY
A	Self-instruction	Not applicable or integrated with next proficiency check	Not applicable
B	Aided instruction	Task or system check	Self-review
C	System devices	Partial proficiency check using qualified device	Designated system
D	Manoeuvre training devices ¹ or aircraft to accomplish specific manoeuvres	Partial proficiency check using qualified device ¹	Designated manoeuvre(s) ¹
E	FSTDs ² or aircraft	Proficiency check using FSTDs ² or aircraft	As per regulation, using FSTDs ² or aircraft

Footnote (1):

- Aeroplane: FTD level 2, or FFS, or aeroplane
- Helicopter: FTD levels 2 and 3, or FFS, or helicopter

Footnote (2):

- Aeroplane: FFS level C or D, or aeroplane
- Helicopter: FSTDs having dual qualification: FFS level B and FTD level 3, or FFS level C or D, or helicopter

Training levels A and B require knowledge, levels C and D require additional skills. Training level E means that the differences are such that type rating training is required or, in the context of equipment and procedure training, aircraft/FSTD training and checking is required.

(3) Difference levels — training

The training difference levels specified represent the minimum requirements. Devices associated with a higher difference level may be used to satisfy a training differences requirement.

(i) Level A training

Level A differences training is applicable to aircraft with differences that can adequately be addressed through self-instruction. Level A training represents a knowledge requirement such that once appropriate information is provided, understanding and compliance can be assumed to be demonstrated.

Training needs not covered by level A training may require level B training or higher, depending on the outcome of the evaluations described in the aircraft evaluation process (CS FCD.420).

(ii) Level B training

Level B differences training is applicable to aircraft with system or procedure differences that can adequately be addressed through aided instruction.

At level B aided instruction, it is appropriate to ensure pilot understanding, emphasise issues, provide a standardised method of presentation of material, or to aid retention of material following training.

(iii) Level C training

Level C differences training can only be accomplished through the use of devices capable of systems training.

Level C differences training is applicable to variants having ‘part task’ differences that affect skills or abilities as well as knowledge. Training objectives focus on mastering individual systems, procedures, or tasks, as opposed to performing highly integrated flight operations and manoeuvres in ‘real time’. Level C may also require self-instruction or aided instruction of a pilot, but cannot be adequately addressed by a knowledge requirement alone. Training devices are required to supplement instruction to ensure attainment or retention of pilot skills and abilities to accomplish the more complex tasks, usually related to operation of particular aircraft systems.

The minimum acceptable training media for level C are interactive computer-based training, cockpit systems simulators, cockpit procedure trainers, part task trainers (such as inertial navigation system (INS), flight management system (FMS), or traffic collision avoidance system (TCAS) trainers), or similar devices.

(iv) Level D training

Level D differences training can only be accomplished with devices capable of performing flight manoeuvres and addressing full task differences affecting knowledge, skills, or abilities.

Devices capable of flight manoeuvres address full task performance in a dynamic 'real time' environment and enable integration of knowledge, skills and abilities in a simulated flight environment, involving combinations of operationally oriented tasks and realistic task loading for each relevant phase of flight. At level D, knowledge and skills to complete necessary normal, non-normal and emergency procedures are fully addressed for each variant.

Level D differences training requires mastery of interrelated skills that cannot be adequately addressed by separate acquisition of a series of knowledge areas or skills that are interrelated. However, the differences are not so significant that a full type rating training course is required. If demonstration of interrelationships between the systems was important, the use of a series of separate devices for systems training would not suffice. Training for level D differences requires a training device that has accurate, high-fidelity integration of systems and controls and realistic instrument indications. Level D training may also require manoeuvre visual cues, motion cues, dynamics, control loading or specific environmental conditions. Weather phenomena such as low-visibility conditions or wind shear may or may not be incorporated. Where simplified or generic characteristics of an aircraft type are used in devices to satisfy level D differences training, significant negative training should not occur as a result of the simplification.

Appropriate devices as described in CS FCD.415(a), satisfying level D differences training range from those where relevant elements of aircraft flight manoeuvring, performance, and handling qualities are incorporated. The use of a manoeuvre training device or aircraft is limited for the conduct of specific manoeuvres or handling differences, or for specific equipment or procedures.

(v) Level E training

Level E differences training is applicable to candidate aircraft that have such significant 'full task' differences that a full type rating training course or a type rating training course with credit for previous experience on similar aircraft types is required to meet the training objectives.

The training requires a 'high-fidelity' environment to attain or maintain knowledge, skills, or abilities that can only be satisfied by the use of FSTDs or the aircraft itself as mentioned in CS FCD.415(a). Level E training, if done in an aircraft, should be modified for safety reasons where manoeuvres can result in a high degree of risk.

When level E differences training is assigned, suitable credit or constraints may be applied for knowledge, skills or abilities related to other pertinent aircraft types. The training programme should specify the relevant subjects, procedures or manoeuvres.

(4) Difference levels — checking

Differences checking addresses any pertinent pilot testing or checking. Initial and recurrent checking levels are the same unless otherwise specified.

It may be possible to satisfactorily accomplish recurrent checking objectives in devices that do not meet the initial checking requirements. In such instances, the applicant may propose for revalidation checks the use of certain devices that do not meet the initial checking requirements.

- (i) Level A checking

Level A differences checking indicates that no check related to differences is required at the time of differences training. However, a pilot is responsible for knowledge of each variant flown.
 - (ii) Level B checking

Level B differences checking indicates that a 'task' or 'systems' check is required following initial and recurring training.
 - (iii) Level C checking

Level C differences checking requires a partial check using a suitable qualified device. A partial check is conducted relative to particular manoeuvres or systems.
 - (iv) Level D checking

Level D differences checking indicates that a partial proficiency check is required following both initial and recurrent training. In conducting the partial proficiency check, manoeuvres common to each variant may be credited and need not be repeated. The partial proficiency check covers the specified particular manoeuvres, systems or devices. Level D checking is performed using scenarios that represent a 'real-time' flight environment and uses qualified devices permitted for level D training or higher.
 - (v) Level E checking

Level E differences checking requires that a full proficiency check be conducted in FSTDs or in an aircraft as mentioned in CS FCD.415(a), following both initial and recurrent training. If appropriate, alternating Level E checking between relevant aircraft is possible and credit may be defined for procedures or manoeuvres based on commonality.

Assignment of level E checking requirements alone, or in conjunction with level E currency, does not necessarily result in assignment of a separate type rating.
- (5) Difference levels — currency
- Differences currency addresses any currency and re-currency levels. Initial and recurrent currency levels are the same unless otherwise specified.
- (i) Level A currency

Level A currency is common to each aircraft and does not require separate tracking. Maintenance of currency in any aircraft suffices for any other variant within the same type rating.
 - (ii) Level B currency

Level B currency is 'knowledge-related' currency, typically achieved through self-review by individual pilots.
 - (iii) Level C currency
 - (A) Level C currency is applicable to one or more designated systems or procedures and it relates to both skill and knowledge requirements. When level C currency applies, any pertinent lower-level currency is also to be addressed.
 - (B) Re-establishing level C currency

When currency is lost, it may be re-established by completing required items using a device equal to or higher than that specified for level C training and checking.

(iv) Level D currency

(A) Level D currency is related to designated manoeuvres and addresses knowledge and skills required for performing aircraft control tasks in real time with integrated use of associated systems and procedures. Level D currency may also address certain differences in flight characteristics including performance of any required manoeuvres and related normal, non-normal and emergency procedures. When level D is necessary, any pertinent lower-level currency is also to be addressed.

(B) Re-establishing level D currency

When currency is lost, currency may be re-established by completing pertinent manoeuvres using a device equal to or higher than that specified for level D differences training and checking.

(v) Level E currency

(A) Level E currency requires that recent experience requirements of Part-FCL and operational requirements be complied with in each aircraft separately. Level E currency may also specify other system, procedure, or manoeuvre currency item(s) necessary for safe operations and may require procedures or manoeuvres to be accomplished in FSTDs or in an aircraft as mentioned in CS FCD.415(a). Provisions are applied in a way which addresses the required system or manoeuvre experience.

When level E is assigned between aircraft of common characteristics, credit may be permitted. Assignment of level E currency requirements does not automatically lead to a determination on same or separate type rating. Level E currency is tracked by a means that is acceptable to the competent authority.

When common take-off and landing credit (CTL) is permitted, any credit or constraints applicable to using FSTDs, as mentioned in CS FCD.415(a), are also to be determined.

(B) Re-establishing level E currency

When currency is lost, currency may be re-established by completing pertinent manoeuvres using a device specified for level E differences training and checking.

(6) Competency regarding non-normal and emergency procedures — currency

Competency for non-normal and emergency manoeuvres or procedures is generally addressed by checking requirements. Particular non-normal and emergency manoeuvres or procedures may not be considered mandatory for checking or training. In this situation, it may be necessary to periodically practise or demonstrate those manoeuvres or procedures specifying currency requirements for those manoeuvres or procedures.

GM1 ORO.FC.140(a) Operation on more than one type or variant

ED Decision 2022/014/R

OPERATOR DIFFERENCE REQUIREMENTS (ODRS)

The ODRs tables may result in different training programmes, depending on the training needs, regardless of the 'base aircraft' used to establish the table (e.g. the trainee may know the 'other aircraft' and be trained towards the 'base aircraft').

AMC1 ORO.FC.140(b) Operation on more than one type or variant

ED Decision 2022/014/R

GROUPS OF SINGLE-ENGINEED PISTON HELICOPTER TYPES FOR THE REVALIDATION OF THE OPC

When establishing groups of single-engined helicopter types for the purpose of crediting of proficiency checks, the operator should only take into account the helicopter types considered for crediting in AMC1 FCL.740.H(a)(3).

AMC1 ORO.FC.140(d) Operation on more than one type or variant

ED Decision 2022/014/R

LINE CHECKS — HELICOPTERS

- (a) Prior to using a line check on one helicopter type or variant to revalidate the line check on other helicopter types or variants, the operator should consider whether the type of operations are sufficiently similar in terms of:
 - (1) use of aerodromes or operating sites;
 - (2) day VFR or night VFR;
 - (3) use of operational approvals and specific approvals;
 - (4) normal procedures, including flight preparation, take-off and landing procedures; and
 - (5) use of automation.
- (b) For IFR operations of helicopters, an operation should only be considered sufficiently similar to allow a line check on one type or variant to revalidate the line check for the other type or variant if such credits are defined in the operational suitability data established in accordance with [Commission Regulation \(EU\) No 748/2012](#)¹, as determined in point (a) of [ORO.FC.140](#).
- (c) Line check cross-crediting should be defined in the operations manual.

ORO.FC.145 Provision of training, checking and assessment

Regulation (EU) 2021/2237

- (a) All training, checking and assessment required in this Subpart shall be conducted in accordance with the training programmes and syllabi established by the operator in the operations manual;
- (b) When establishing the training programmes and syllabi, the operator shall include the relevant elements defined in the mandatory part of the operational suitability data established in accordance with [Regulation \(EU\) No 748/2012](#).

¹ OJ L 243, 27.9.2003, p. 6.

- (c) In the case of CAT operations, training and checking programmes, including syllabi and the use of the means to deliver the programme such as individual flight simulation training devices (FSTDs) and other training solutions, shall be approved by the competent authority.
- (d) The FSTD used to meet the requirements of this Subpart shall be qualified in accordance with [Regulation \(EU\) No 1178/2011](#) and it shall replicate the aircraft used by the operator, as far as practicable. Differences between the FSTD and the aircraft shall be described and addressed through a briefing or training, as appropriate.
- (e) The operator shall establish a system to adequately monitor changes to the FSTD and to ensure that those changes do not affect the adequacy of the training programmes.
- (f) The operator shall monitor the validity of each recurrent training and checking.
- (g) The validity periods required in this Subpart shall be counted from the end of the month in which the recency, training or check was completed.

AMC1 ORO.FC.145 Provision of training, checking and assessment

ED Decision 2022/014/R

ACCEPTANCE OF PREVIOUS TRAINING FOR NON-COMMERCIAL OPERATIONS WITH COMPLEX MOTOR-POWERED AIRCRAFT, INCLUDING NON-COMMERCIAL SPECIALISED OPERATIONS

- (a) If the operator chooses to make use of previous training received by the pilot, the operator should develop a policy for the crediting of such training. Details of such policy should be included in the operations manual.
- (b) The policy should as a minimum include measures to assess:
 - (1) the content of the previous training;
 - (2) whether the previous training was delivered by suitably qualified personnel or organisations;
 - (3) whether the aircraft, FSTD or other equipment used for the previous training was sufficiently similar to the aircraft and equipment the crew member will operate; and
 - (4) whether the operating procedures used during such previous training were sufficiently representative of the procedures used by the new operator.
- (c) Where previous training delivered by other suitably qualified personnel or organisations is found to satisfy all or some of the requirements in [ORO.FC.120](#), the training may be credited and an abbreviated conversion course may be used. Such an abbreviated course should cover all items not credited from previous training.
- (d) Where a pilot flies for more than one operator and the training delivered by that other operator is found to satisfy some of the requirements of [ORO.FC.130](#), then such training may be credited and an abbreviated recurrent training programme may be used. Such an abbreviated recurrent training programme should cover all items not credited from the training delivered by the other operator.
- (e) An aircraft operator remains responsible for all training required by this Part regardless of whether the training is conducted by the operator, another operator, a certified organisation or another subcontractor, as defined in [ORO.GEN.205](#).
- (f) An operator accepting any previous training should be satisfied that the flight crew member is competent to operate in accordance with that operator's procedures and to use the specific equipment installed on the aircraft to be operated.

- (g) Previous training needs to be formally documented.
- (h) The assessment under (b) and the documents referred to under (g) should be stored as part of the crew member training, checking and qualifications records.

GM1 ORO.FC.145 Provision of training, checking and assessment

ED Decision 2022/014/R

POLICY FOR ACCEPTANCE OF PREVIOUS TRAINING AND CHECKING FOR OTHER THAN COMMERCIAL AIR TRANSPORT OPERATIONS (NCC)

If the operator chooses to make use of previous training received by the pilot, in accordance with [AMC1 ORO.FC.145](#), the operator may wish to enter into arrangements with other operators in order to satisfy the requirements of [ORO.GEN.205](#) in relation to contracted training providers or other aircraft operators.

AMC1 ORO.FC.145(a) Provision of training, checking and assessment

ED Decision 2022/014/R

TRAINING AND CHECKING PROGRAMMES AND SYLLABI

- (a) Training and checking programmes and syllabi should include as a minimum:
 - (1) when training and checking take place during the same session, the distinction between the two;
 - (2) a list of the items covered;
 - (3) the minimum time allocation (duration);
 - (4) the means of delivery (e.g. FSTD, OTD, computer-based, VR, etc.);
 - (5) the personnel providing the training and conducting the checks.
- (b) Further details on the training and checking programmes and syllabi should be included in the operations manual depending on the complexity of the operations (e.g. further contextualisation of the training programme, details of the airport in which some items will be covered, time allocation to brief and debrief, whether the item to be trained is a legal requirement or an SMS item, etc.).

[applicable from 26 March 2023]

GM1 ORO.FC.145(a) Provision of training, checking and assessment

ED Decision 2022/014/R

TRAINING AND CHECKING PROGRAMMES AND SYLLABI

The syllabus lists the topics to be covered in a training and checking programme. A syllabus may include:

- the personnel providing the training and conducting the checks;
- a description of the content;
- the means of delivery (e.g. FSTD, aircraft, OTD, (virtual) classroom, computer-based training, VR, etc.);
- the minimum time allocation (duration);
- the prerequisites to be fulfilled before starting the training or checking;

- the standard of performance;
- the training objectives;
- a reference to training/checking material;
- the checking requirements, if any;
- when training and checking is combined, the distinction between trained and checked items.

[applicable from 26 March 2023]

AMC1 ORO.FC.145(b) Provision of training, checking and assessment

ED Decision 2022/014/R

NON-MANDATORY (RECOMMENDATION) ELEMENTS OF OPERATIONAL SUITABILITY DATA

When developing the training programmes and syllabi, the operator should include the non-mandatory (recommendation) elements for the relevant type that are provided in the operational suitability data established in accordance with [Commission Regulation \(EU\) No 748/2012](#).

AMC1 ORO.FC.145(d) Provision of training, checking and assessment

ED Decision 2022/014/R

FULL FLIGHT SIMULATORS (FFS)

The operator should classify any differences between the aircraft and FFS in accordance with the Air Transport Association (ATA) chapters as follows:

Compliance Levels

(a) Level A differences:

- (1) no influence on flight characteristics;
- (2) no influence on procedures (normal and/or abnormal);
- (3) differences in presentation; and
- (4) differences in operation.

Method: self-instruction via the operations manual or flight crew information.

(b) Level B differences:

- (1) no influence on flight characteristics;
- (2) influence on procedures (normal and/or abnormal); and
- (3) possible differences in presentation and operation.

Method: flight crew information, computer-based training, system device training or special instruction by instructor.

(c) Level C differences:

- (1) influence on flight characteristics;
- (2) influence on procedures (normal and/or abnormal); and
- (3) eventually differences in presentation and operation.

Method: special instruction by instructor, a selected partial training on another FSTD or aircraft or a waiver because of previous experience, special instruction or training programme.

- (d) Level D differences:
- (1) influence on flight characteristics; and/or
 - (2) influence on procedures (normal and/or abnormal); and/or
 - (3) differences in presentation and/or operation; and
 - (4) FSTD is level D qualified and is used for zero flight-time training (ZFTT).

Method: a specified partial training on another FSTD or aircraft or a waiver because of previous experience, special instruction or training programme.

AMC2 ORO.FC.145(d) Provision of training, checking and assessment

ED Decision 2022/014/R

FSTDs

- (a) Before the operator extracts the data from an FSTD that can be related to a pilot, it should develop a data access and security policy.
- (b) 'Availability' and 'accessibility' of FSTD used in this Subpart.
 - (1) 'Available FSTD' refers to any flight simulation training device (FSTD) that is vacant for use by the FSTD operator or by the customers irrespective of any time consideration.
 - (2) 'Accessible' refers to a device that can be used by the operator to conduct training or checking pertaining to this Subpart, and by the nominated person conducting the training or checking.

More information on these definitions can be found in Part-FCL of [Regulation \(EU\) No 1178/2011](#).

[applicable from 26 March 2023]

GM1 ORO.FC.145(d) Provision of training, checking and assessment

ED Decision 2022/014/R

CONFIDENTIALITY AND PROTECTION OF TRAINING DATA IN COMMERCIAL AIR TRANSPORT

- (a) Without prejudice to applicable national legislation on the protection of individuals with regard to the processing of personal data, for the training conducted in accordance with [ORO.FC.145](#) the operator may have a training data access and security policy (including the procedure to prevent disclosure of crew identity).
- (b) If the operator decides to have such a policy, it should:
 - (1) be agreed by all parties involved (airline management and flight crew member representatives nominated either by the union or the flight crew themselves);
 - (2) be in line with the organisation's safety policy in order to not make available or to not make use of the training data to attribute blame or liability.
- (c) The training data access and security policy may include a policy for access to information only to specifically authorised persons identified by their position in order to perform their duties.

[applicable from 26 March 2023]

AMC1 ORO.FC.145(g) Provision of training, checking and assessment

ED Decision 2022/014/R

VALIDITY PERIOD OF RECURRENT ASSESSMENT, TRAINING AND CHECKING

- (a) When the recency, training or check is completed within the last 3 months of the validity period, the new validity period should be counted from the original expiry date.
- (b) When the recency, training or check is completed before the last 3 months of the validity period, the new validity period should be counted from the end of the month when the recency, training or check was completed and not from the original expiry date.
- (c) Notwithstanding (a), the revalidation of CRM instructor and EBT instructor qualifications should follow [AMC2 ORO.FC.146](#) and [AMC2 ORO.FC.146\(c\)](#).

ORO.FC.146 Personnel providing training, checking and assessment

Regulation (EU) 2021/2237

- (a) All training, checking and assessment required in this Subpart shall be conducted by appropriately qualified personnel.
- (b) In the case of flight and flight simulation training, checking and assessment, the personnel that provide the training and conduct the checking or assessment shall be qualified in accordance with Annex I (Part- FCL) to [Regulation \(EU\) No 1178/2011](#). Additionally, the personnel providing training and conducting checking towards specialised operations shall be suitably qualified for the relevant operation.
- (c) For an EBT programme, the personnel that performs assessment and provides training shall:
 - (1) hold an Annex I (Part-FCL) instructor or examiner certificate;
 - (2) complete the operator's EBT instructor standardisation programme. This shall include an initial standardisation programme and a recurrent standardisation programme.
Completion of the operator's EBT initial standardisation will qualify the instructor to perform EBT practical assessment.
- (d) Notwithstanding point (b), the line evaluation of competence may be conducted by a suitably qualified commander nominated by the operator that is standardised in EBT concepts and the assessment of competencies (line evaluator).
- (e) Notwithstanding point (b), the aircraft/FSTD training and the operator proficiency check may be conducted by a suitably qualified commander holding a FI/TRI/SFI certificate and nominated by the operator for any of the following operations:
 - (1) CAT operations of helicopters meeting the criteria defined in point [ORO.FC.005\(b\)\(2\)](#);
 - (2) CAT operations of other than complex motor-powered helicopters by day and over routes navigated by reference to visual landmarks;
 - (3) CAT operations of performance class B aeroplanes that do not meet the criteria defined in point [ORO.FC.005\(b\)\(1\)](#).
- (f) Notwithstanding point (b), the aircraft/FSTD training and the demonstration of competence/operator proficiency check may be conducted by a suitably qualified pilot-in-command/commander nominated by the operator for any of the following operations:
 - (1) specialised operations;
 - (2) CAT operations of aeroplanes meeting the criteria defined in point [ORO.FC.005\(b\)\(2\)](#).

- (g) Notwithstanding point (b), the line check may be conducted by a suitably qualified commander nominated by the operator.
- (h) The operator shall inform the competent authority about the persons nominated under points (e) to (g).

AMC1 ORO.FC.146 Personnel providing training, checking and assessment

ED Decision 2022/014/R

PERSONNEL CONDUCTING TRAINING AND CHECKING — GENERAL

Training and checking should be provided by the following personnel:

- (a) Ground and refresher training by suitably qualified personnel;
- (b) Emergency and safety equipment training and checking by suitably qualified personnel as specified in the operator's manual;
- (c) CRM
 - (1) Integration of CRM elements into the different phases of training by all the personnel conducting the training, as per [AMC1](#) and [AMC2 ORO.FC.115](#).
 - (2) The operator should ensure that all personnel conducting such training are suitably qualified to integrate elements of CRM into this training.
 - (3) Classroom CRM training by at least one CRM trainer, qualified as specified in [AMC2 ORO.FC.146](#) who may be assisted by experts in order to address specific areas.

AMC2 ORO.FC.146 Personnel providing training, checking and assessment

ED Decision 2022/014/R

FLIGHT CREW CRM TRAINER

- (a) Applicability

The provisions described herein:

- (1) should be fulfilled by flight crew CRM trainers responsible for classroom CRM training; and
 - (2) are not applicable to:
 - (i) instructors, holding a certificate in accordance with [Commission Regulation \(EU\) No 1178/2011](#), when conducting CRM training in the operational environment; and
 - (ii) trainers or instructors when conducting training other than CRM training, but integrating CRM elements into this training.
- (b) Qualification of a flight crew CRM trainer
 - (1) Prerequisites. A flight crew CRM trainer should:
 - (i) have adequate knowledge of human performance and limitations (HPL), whilst:
 - (A) having obtained a commercial pilot licence in accordance with [Commission Regulation \(EU\) No 1178/2011](#); or

- (B) having followed a theoretical HPL course covering the whole syllabus of the HPL examination;
 - (ii) have completed flight crew initial operator's CRM training;
 - (iii) have received training in group facilitation skills, except for instructors holding a certificate in accordance with [Commission Regulation \(EU\) No 1178/2011](#).
- (2) In order to qualify as flight crew CRM trainer, a person meeting the prerequisites should:
 - (i) have adequate knowledge of the relevant flight operations at one operator, in accordance with (d);
 - (ii) receive the initial training in accordance with (c)(3); and
 - (iii) be assessed by that operator in accordance with (f).
- (3) In order to act as flight crew CRM trainer at an operator, a qualified and current flight crew CRM trainer should meet one of the following conditions:
 - (i) have adequate knowledge of the relevant flight operations at that operator, in accordance with (d); or
 - (ii) be part of a team of trainers in accordance with (e).
- (4) The period of validity of the flight crew CRM trainer qualification should be 3 years.
- (5) Recency and renewal of the flight crew CRM trainer qualification
 - (i) The flight crew CRM trainer should complete CRM trainer refresher training within the last 12 months of the 3-year validity period; and
 - (ii) The flight crew CRM trainer should meet one or both of the following conditions:
 - (A) conduct at least 3 CRM training events within the 3-year validity period;
 - (B) be assessed within the last 12 months of the 3-year validity period in accordance with (f); and
 - (iii) If the flight crew CRM trainer qualification has expired, it can be renewed if all of the conditions below are met. The validity should be 3 years after completion of (A) and (C) below, whichever comes first:
 - (A) complete CRM trainer refresher training;
 - (B) receive refresher training on knowledge of the relevant flight operations, as necessary;
 - (C) be assessed in accordance with (f).
- (c) Training of flight crew CRM trainer
 - (1) If the operator trains flight crew CRM trainers, the training syllabi should be described in the operations manual. The operator should ensure that the initial and refresher training of the flight crew CRM trainers are conducted by flight crew CRM trainers with a minimum of 3 years of experience.
 - (2) Training of flight crew CRM trainers should be both theoretical and practical. Practical elements should include the development of specific trainer skills, particularly the integration of CRM into line operations.

- (3) The initial training of flight crew CRM trainers should include the following:
- (i) introduction to CRM training and competencies for CRM trainers:
 - (A) ability to interact with and manage a group;
 - (B) ability to pre-plan an objective and timely training session;
 - (C) ability to deliver a good balance of ‘telling’, ‘selling’ and ‘facilitating’;
 - (D) ability to connect realistically poor and good CRM to the operations;
 - (E) ability to assess the performance, the progress and needs of trainees in a meaningful way;
 - (ii) operator’s management system as defined in point (a)(7) of [AMC1 ORO.FC.115](#); and
 - (iii) characteristics of the flight crew CRM training as defined in Table 1 of [AMC1 ORO.FC.115](#) and its integration into line operations:
 - (A) the different types of CRM trainings (initial, recurrent, etc.);
 - (B) combined training; and
 - (C) training related to the type of aircraft or operation.

Instructors holding a certificate in accordance with [Commission Regulation \(EU\) No 1178/2011](#) may be credited towards (i) and (ii) if they have completed the refresher training defined in (4).

- (4) The refresher training of flight crew CRM trainers should include new methodologies, procedures and lessons learned, as well as additional topics such as the following:
- (i) Group facilitation skills including team dynamics, moderation skills and use of questions
 - (ii) Course preparation, defining objectives and selecting methods to best convey knowledge (e.g. lecture, group work, case analysis, gamification, scenario-based training, individual research)
 - (iii) Safety culture and management systems
 - (iv) An example of an analysis of CRM factors in an accident or serious incident.
 - (v) New developments or research in human factors and CRM
 - (vi) TEM principles and their practical implementation in normal operations
- (5) Instructors, holding a certificate in accordance with [Commission Regulation \(EU\) No 1178/2011](#), who are also CRM trainers, may combine the CRM trainer refresher training with instructor refresher training if the instructor refresher training meets all of the conditions defined in (4).
- (6) Instructors for other-than complex motor-powered aeroplanes should be qualified as flight crew CRM trainers for this aircraft category with no additional training, as specified in (3) and (4) when:
- (i) holding a certificate in accordance with [Commission Regulation \(EU\) No 1178/2011](#); and
 - (ii) fulfilling the provisions of (b)(2) or (b)(5).

- (d) Knowledge of the relevant flight operations
- (1) The operator should evaluate the experience and knowledge of the flight crew CRM trainer. The evaluation of the operator should include at least:
 - (i) the operational experience of the flight crew CRM trainer as a flight crew member;
 - (ii) whether this experience as a flight crew member or a former flight crew member covers the aircraft category, the aircraft generation and the form of operations, as relevant to the operator.
 - (2) If the flight crew CRM trainer does not have the relevant knowledge of the relevant flight operation based on the evaluation in (1), the operator should provide training to the flight crew CRM trainer to provide the adequate knowledge.
 - (3) The operator should describe the assessment and training in the operations manual.
- (e) Team of CRM trainers
- If the flight crew CRM trainer is qualified in accordance with (b) but does not meet the conditions defined in (d), he or she may be assisted by a training assistant that has the knowledge of the relevant flight operations. The operator should ensure that all the following conditions are met:
- (1) The training assistant should meet the condition defined in (c) but needs not meet the conditions defined in (b). The training assistant should be an instructor or have experience in ground training.
 - (2) The flight crew CRM trainer and the training assistant should prepare the training session together and adapt it to the operational needs of the operator.
 - (3) If the flight crew CRM trainer and the training assistant have already provided training for the operator or for a similar operator, the operator may determine that condition (2) is met.
 - (4) The flight crew CRM trainer and the training assistant should provide the training together.
 - (5) The flight crew CRM trainer remains responsible for the training.
- (f) Assessment of a flight crew CRM trainer
- (1) The operator should ensure that the process for the assessment is included in the operations manual describing methods for observing, recording, interpreting and debriefing the flight crew CRM trainer. All personnel involved in the assessment must be credible and competent in their role.
 - (2) The assessment should enable the flight crew CRM trainer to demonstrate the knowledge and ability to train the CRM training elements in the non-operational environment. Special attention should be given to fields such as group management, group dynamics and personal awareness.
 - (3) The initial assessment of a flight crew CRM trainer by the operator may take place when conducting their first CRM training course.
 - (4) The assessment of flight crew CRM trainers should be conducted by flight crew CRM trainers with a minimum of 3 years of experience.
- (g) The operator should only select a qualified and current flight crew CRM trainer meeting the conditions defined in (d) or (e).

[applicable from 26 March 2023]

AMC1 ORO.FC.146(b) Personnel providing training, checking and assessment

ED Decision 2022/014/R

PERSONNEL PROVIDING AIRCRAFT/FSTD TRAINING AND CONDUCTING OPERATOR PROFICIENCY CHECKING AND QUALIFIED UNDER ANNEX I (PART-FCL) TO REGULATION (EU) No 1178/2011

Training and checking should be provided by the following personnel:

- (a) Flight training by a type rating instructor (TRI) or class rating instructor (CRI), flight instructor (FI) or, in the case of the FSTD content, a synthetic flight instructor (SFI). For commercial air transport, the FI, TRI, CRI or SFI should satisfy the operator's experience and knowledge requirements sufficiently to instruct on aircraft systems and operational procedures and requirements.
- (b) Operator proficiency check by a type rating examiner (TRE), class rating examiner (CRE) or, if the check is conducted in an FSTD, a synthetic flight examiner (SFE). The TRE, CRE or SFE should be trained in CRM concepts and the assessment of CRM skills.
- (c) For aircraft/FSTD training, line flying under supervision, operator proficiency checks and line checks, if the training or checking includes multi-pilot operations in helicopters, in addition to (a) and (b) the personnel conducting training or checking should have 350 hours flying experience in multi-pilot operations.
- (d) In the case of CAT operations in helicopters, the 350 hours flying experience in multi-pilot operations defined in (c) may be reduced on an individual basis, as part of the approval of the training and checking programmes. The operator may apply for such a reduced flying experience based on the unavailability of experienced pilots in both multi-pilot operations and in their types of operations. A FI/TRI/SFI rating and MCC training in helicopters should be a prerequisite for any reduced flying experience in multi-pilot operations. In addition, the operator should define mitigation measures after having performed a risk assessment. The following should be taken into account:
 - (1) flying experience criteria in single-pilot operations in the types of operations;
 - (2) any other training, checking, recency and experience criteria;
 - (3) robustness and maturity of multi-pilot SOPs.
- (e) In the case of training and checking towards the relevant aspects associated with a specialised operation, points (j)(2) to (j)(4) of [AMC1 ORO.FC.146\(e\);\(f\)&\(g\)](#) should apply.

AMC1 ORO.FC.146(c) Personnel providing training, checking and assessment

ED Decision 2022/014/R

EBT INSTRUCTOR — INITIAL STANDARDISATION PROGRAMME

- (a) Before delivering the operator's EBT programme, the instructor should complete an EBT instructor initial standardisation programme composed of:
 - (1) EBT instructor training; and
 - (2) EBT assessment of competence.

EBT INSTRUCTOR TRAINING

- (b) The EBT instructor training course should be delivered by at least one pilot who is or has been an EBT instructor, and who has demonstrated proficiency to train the elements specified in point (c) below.
- (c) The EBT instructor training course should comprise theoretical and practical training. At the completion of EBT instructor training, the instructor should:
 - (1) have knowledge of EBT, including the following underlying principles:
 - (i) competency-based training;
 - (ii) learning from positive performance;
 - (iii) building resilience; and
 - (iv) data-driven training;
 - (2) demonstrate knowledge of the structure of an EBT module;
 - (3) demonstrate knowledge of the method of training delivery for each phase of an EBT module;
 - (4) demonstrate knowledge of the principles of adult learning and how they relate to EBT;
 - (5) conduct objective observations based on a competency framework, and document evidence of observed performance;
 - (6) relate specific performance observations of competencies;
 - (7) analyse trainee performance to determine competency-based training needs and recognise strengths;
 - (8) evaluate performance using a competency-based grading system;
 - (9) apply appropriate teaching styles during simulator training to accommodate trainee learning needs;
 - (10) facilitate trainee learning, focusing on specific competency-based training needs; and
 - (11) conduct a debrief using facilitation techniques.
- (d) An instructor may be given credits for parts of point (c) if the instructor has demonstrated competencies in those topics.

EBT ASSESSMENT OF COMPETENCE

- (e) Prior to conducting assessment and training within an EBT programme, the EBT instructor should complete an EBT assessment of competence where the EBT instructor delivers:
 - (1) an evaluation phase (EVAL) and a manoeuvres training phase (MT); or
 - (2) a scenario-based training phase (SBT).
- (f) The assessment of competence has a validity period of 3 years.
- (g) The EBT assessment of competence should be conducted by a person nominated by the operator, who:
 - (1) is qualified in accordance with Annex I (Part-FCL) to [Regulation \(EU\) No 1178/2011](#) to conduct an assessment of competence; and
 - (2) has completed the EBT instructor standardisation.

- (h) The EBT assessment of competence may be combined with the assessment of competence required in Annex I (Part-FCL) to [Regulation \(EU\) No 1178/2011](#).

AMC2 ORO.FC.146(c) Personnel providing training, checking and assessment

ED Decision 2022/014/R

EBT INSTRUCTOR — RECURRENT STANDARDISATION PROGRAMME

The EBT instructor should:

- (a) conduct six EVAL or SBT phases of an EBT module (or a combination of both) every 36 months. One of the EVAL or SBT should take place in the period of 12 months immediately preceding the expiry date. The 36-month period should be counted from the end of the month the module was taken. If this has not been fulfilled, the EBT instructor should complete an EBT assessment of competence. When the module is undertaken within the last 12 months of the validity period, the new period should be counted from the original expiry date;
- (b) receive annual recurrent standardisation. The recurrent standardisation should include:
 - (1) refresher EBT training; and
 - (2) concordance training; and
- (c) complete an EBT assessment of competence every 3 years. When the assessment of competence is conducted within the 12 months preceding the expiry date, the next assessment of competence should be completed within 36 calendar months of the original expiry date of the previous assessment of competence.

GM1 ORO.FC.146(c) Personnel providing training, checking and assessment

ED Decision 2021/002/R

EBT INSTRUCTOR — INITIAL STANDARDISATION

- (a) The intent of the practical training is to ensure that EBT instructors have exposure to assessment of performance and root cause identification within an EBT programme.
- (b) EBT instructors receive practical assistance and guidance during standardisation in order to apply the learning from EBT instructor training. In particular, the focus should be on assessment of performance and the determination of root cause for remediation, plus facilitated debriefing based on root cause as a learning objective.
- (c) The pilot delivering the training may be supported by a subject matter expert (or experts). The personnel providing the EBT training is selected by the operator to assess the instructor capability in delivering EBT and provide effective feedback in order that instructor practice meets the expectations of the operator.
- (d) Practical EBT training includes the learning objective 'Evaluate performance using a competency-based grading system'. This may be done with videos and other multimedia. It means that EBT instructors are exposed to:
 - (1) different levels of pilot performance. This enables EBT instructors to distinguish between pilots performing lower than the minimum acceptable level of performance (e.g. grade 1) and those whose performance is at an acceptable level in all competencies (e.g. grade 2). This EBT training may also include other performance examples (e.g. 3, 4 and 5); and

- (2) different scenarios (e.g. complex to less complex) so that the instructor has exposure to assessments of competency in varying EBT scenarios.
- (e) The EBT instructor training course may be a minimum of 14 hours (EBT instructor training alone) and the recommended length is between 21 to 24 hours (EBT instructor training plus assessment of competence).

GM2 ORO.FC.146(c) Personnel providing training, checking and assessment

ED Decision 2021/002/R

EBT INSTRUCTOR — RECURRENT STANDARDISATION

- (a) Refresher EBT training

The intent of this training is to provide the framework for existing instructors to develop their competence to conduct EBT. Further guidance can be found in the EASA EBT manual.

- (b) Concordance training

This training is one of the elements to ensure concordance within the EBT instructor community. Those EBT instructors who do not demonstrate concordance may require further training. The operator’s instructor standardisation and concordance assurance programme provides insight in the areas that an instructor (or instructor population) requires concordance training. As such, concordance training varies in content and scale depending on the need for concordance improvement.

Instructor concordance training may include candidates grading the same controlled content (e.g. a video or paper case) followed by:

- (1) a subsequent comparison of intra-group variance; and
- (2) alignment of root-cause analyses between instructors.

GM3 ORO.FC.146(c) Personnel providing training, checking and assessment

ED Decision 2021/002/R

EBT INSTRUCTOR COMPETENCY FRAMEWORK

Pilot competencies ¹	
Description:	See pilot competency framework
Instructor observable behaviour (iOB)	See pilot competency framework

¹ For ground instructors, some competencies may not apply. For the instructor assessment of competence, these competencies may not be observed. A review of the records of the instructor may be sufficient.

Management of the learning environment	
Description:	Ensures that the instruction, assessment and evaluation are conducted in a suitable and safe environment
iOB 2.1	Applies TEM in the context of instruction/evaluation
iOB 2.2	Briefs on safety procedures for situations that are likely to develop during instruction/evaluation

iOB 2.3	Intervenes appropriately, at the correct time and level (e.g. progresses from verbal assistance to taking over control)
iOB 2.4	Resumes instruction/evaluation as practicable after any intervention
iOB 2.5	Plans and prepares training media, equipment and resources
iOB 2.6	Briefs on training devices or aircraft limitations that may influence training, when applicable
iOB 2.7	Creates and manages conditions (e.g. airspace, ATC, weather, time, etc.) to be suitable for the training objectives
iOB 2.8	Adapts to changes in the environment whilst minimising training disruptions
iOB 2.9	Manages time, training media and equipment to ensure that training objectives are met

Instruction	
Description:	Conducts training to develop the trainee's competencies
iOB 3.1	References approved sources (operations, technical and training manuals, standards and regulations)
iOB 3.2	States clearly the objectives and clarifies roles for the training
iOB 3.3	Follows the approved training programme
iOB 3.4	Applies instructional methods as appropriate (e.g. explanation, demonstration, learning by discovery, facilitation, in-seat instruction)
iOB 3.5	Sustains operational relevance and realism
iOB 3.6	Adapts the amount of instructor inputs to ensure that the training objectives are met
iOB 3.7	Adapts to situations that might disrupt a planned sequence of events
iOB 3.8	Continuously assesses the trainee's competencies (e.g. by including the root cause(s) of the deficiency(-ies) observed according to the competency framework)
iOB 3.9	Encourages the trainee to self-assess
iOB 3.10	Allows the trainee to self-correct in a timely manner
iOB 3.11	Applies trainee-centred feedback techniques (e.g. facilitation, etc.)
iOB 3.12	Provides positive reinforcement

Interaction with the trainees	
Description:	Supports the trainees' learning and development and demonstrates exemplary behaviour (role model)
iOB 4.1	Shows respect for the trainee (e.g. for culture, language and experience)
iOB 4.2	Shows patience and empathy (e.g. by actively listening, reading non-verbal messages and encouraging dialogue)
iOB 4.3	Manages trainees' barriers to learning
iOB 4.4	Encourages engagement and mutual support between the trainees
iOB 4.5	Coaches the trainees
iOB 4.6	Supports the goal and training policies of the operator/ATO and authority
iOB 4.7	Shows integrity (e.g. honesty and professional principles)
iOB 4.8	Demonstrates acceptable personal conduct, acceptable social practices, content expertise, a model for professional and interpersonal behaviour
iOB 4.9	Actively seeks and accepts feedback to improve own performance

Assessment and evaluation	
Description:	Assesses the competencies of the trainee and contributes to continuous training system improvement
iOB 5.1	Complies with operator/ATO and authority requirements
iOB 5.2	Ensures that the trainee understands the assessment process
iOB 5.3	Applies the competency standards and conditions
iOB 5.4	Assesses trainee's competency (-ies)
iOB 5.5	Performs grading
iOB 5.6	Provides recommendations based on the outcome of the assessment
iOB 5.7	Makes decisions based on the outcome of assessments
iOB 5.8	Provides clear feedback to the trainee
iOB 5.9	Reports strengths and weaknesses of the training system (e.g. training environment, curriculum, assessment/evaluation) including feedback from trainees
iOB 5.10	Suggests improvements for the training system
iOB 5.11	Produces reports using appropriate forms and media

The recommended competency assessment grading system methodology for instructor competencies should be the same as the one used for pilots. This is the Venn model. More information can be found in [ORO.FC.231 point \(d\)\(1\)](#) and the related AMC and GM, as well as in the EASA EBT manual.

AMC1 ORO.FC.146(e);(f)&(g) Personnel providing training, checking and assessment

ED Decision 2022/014/R

SUITABLY QUALIFIED PIC OR COMMANDER NOMINATED BY THE OPERATOR — GENERAL

- (a) The nominated PIC/commander conducting training should either be qualified as an instructor under [Regulation \(EU\) No 1178/2011](#) or receive training which should cover at least:
 - (1) techniques of briefing and debriefing;
 - (2) CRM concepts and CRM assessment;
 - (3) for SPO, which manoeuvres the nominated PIC/commander should not train or check unless qualified as an instructor.
- (b) In addition, the nominated PIC/commander conducting operator proficiency checks or line checks should either be qualified as an examiner under [Regulation \(EU\) No 1178/2011](#) or receive additional training which should cover at least:
 - (1) how to perform a check;
 - (2) flight techniques applicable to checks performed in flight;
 - (3) the assessment of CRM skills.
- (c) The nominated PIC/commander conducting aircraft/FSTD training, line flying under supervision, operator proficiency checks or line checks taking place under multi-pilot operations in helicopters should have 350 hours flying experience in multi-pilot operations.
- (d) The nominated PICs/commanders, or the criteria for nominating PICs/commanders, should be included in the operations manual.
- (e) The nominated PIC/commander should be type rated or class rated in the type or class where he or she provides the training, checking or assessment.

CAT — SUITABLY QUALIFIED COMMANDER OR INSTRUCTOR NOMINATED BY THE OPERATOR

- (f) For CAT operations under VFR by day, the minimum experience of the nominated commander should be more than 750 hours total flight time with at least 50 hours on the type, class or the aircraft variant.
- (g) For CAT operations in performance class B aeroplanes under night VFR or under IFR, the minimum experience of the nominated commander should be more than 1 000 hours total flight time with at least 100 hours on the type, class or the aircraft variant.
- (h) In the case of CAT operations in helicopters, the 350 hours flying experience in multi-pilot operations defined in (c) may be reduced on an individual basis, as part of the approval of the training and checking programmes. The operator may apply for such a reduced flying experience based on the unavailability of experienced pilots in both multi-pilot operations and in their types of operations. An FI/TRI/SFI rating and MCC training in helicopters should be a prerequisite for any reduced flying experience in multi-pilot operations. In addition, the operator should define mitigation measures after having performed a risk assessment. The following should be taken into account:
 - (1) flying experience criteria in single-pilot operations in the types of operations;
 - (2) any other training, checking, recency and experience criteria; and
 - (3) robustness and maturity of multi-pilot SOPs.
- (i) [ORO.FC.220\(f\)](#) allows the operator to develop a specific conversion course to address an operational circumstance, when the operator intends to have pilots temporarily joining the operator to conduct line checks. The content of the specific operator's conversion course is included in [AMC1 ORO.FC.220\(f\)](#).

SPO — SUITABLY QUALIFIED PIC OR INSTRUCTOR NOMINATED BY THE OPERATOR

- (j) For SPO, the person conducting the aircraft/FSTD training and the operator proficiency check should meet the following criteria:
 - (1) Training and checking covering normal, abnormal and emergency procedures relevant to the type or variant should be conducted in accordance with [AMC1 ORO.FC.146\(b\)](#).
 - (2) Training and checking covering the relevant aspects associated with HEC and HESLO should be conducted by a HEC or HESLO instructor as defined in [AMC1 SPO.SPEC.HEC.100](#) and [AMC1 SPO.SPEC.HESLO.100](#).
 - (3) Training and checking covering the relevant aspects associated with a specialised operation other than HEC and HESLO should be conducted by a nominated PIC with the following flight experience:
 - (i) at least 750 hours total flight time with at least 50 hours on the type, class or aircraft variant;
 - (ii) for specialised operations other than HEC and HESLO, either:
 - (A) at least 350 hours in the applicable specialised operation; or
 - (B) 800 hours in specialised operations and the number of hours in the applicable specialised operation as defined by the operator, based on a risk assessment, taking into account the complexity of the relevant aspects associated with the applicable specialised operation. Flight experience in HHO, firefighting flight experience and flight experience in the search component of search and rescue flights may be credited towards the 800

hours in specialised operations. In addition, up to 200 hours of experience in CAT operations (other than HHO) may be credited towards the 800 hours in specialised operations.

- (4) In addition to (2) and (3) above, flight training and checking of sensitive type-related manoeuvres in combination with the training and checking of the relevant aspects associated with a specialised task, should be conducted by a qualified instructor.
- (k) In addition to (j) above, if the SPO operator combines the operator proficiency check with a licence proficiency check, the person conducting the check should meet the requirements for licence proficiency checks.

SECTION 2 – ADDITIONAL REQUIREMENTS FOR COMMERCIAL AIR TRANSPORT OPERATIONS

ORO.FC.200 Composition of flight crew

Regulation (EU) 2021/2237

- (a) There shall not be more than one inexperienced flight crew member in any flight crew.
- (b) The commander may delegate the conduct of the flight to another pilot suitably qualified in accordance with Annex I (Part-FCL) to [Regulation \(EU\) No 1178/2011](#) provided that the requirements of [ORO.FC.105\(b\)\(1\)](#), (b)(2) and (c) are complied with.
- (c) Specific requirements for aeroplane operations under instrument flight rules (IFR) or at night.
 - (1) The minimum flight crew shall be two pilots for all turbo-propeller aeroplanes with a maximum operational passenger seating configuration (MOPSC) of more than nine and all turbojet aeroplanes.
 - (2) Aeroplanes other than those covered by (c)(1) shall be operated with a minimum crew of two pilots, unless the requirements of [ORO.FC.202](#) are complied with, in which case they may be operated by a single pilot.
- (d) Specific requirements for helicopter operations

For all operations of helicopters with an MOPSC of more than 19 and for operations under IFR of helicopters with an MOPSC of more than 9, the minimum flight crew shall be two pilots.

AMC1 ORO.FC.200(a) Composition of flight crew

ED Decision 2014/017/R

CREWING OF INEXPERIENCED FLIGHT CREW MEMBERS

The operator should establish procedures in the operations manual taking into account the following elements:

Aeroplanes

- (a) The operator should consider that a flight crew member is inexperienced, following completion of a type rating or command course, and the associated line flying under supervision, until he/she has achieved on the type either:
 - (1) 100 flight hours and flown 10 sectors within a consolidation period of 120 consecutive days; or

- (2) 150 flight hours and flown 20 sectors (no time limit).
- (b) A lesser number of flight hours or sectors, subject to any other conditions that the competent authority may impose, may be acceptable to the competent authority when one of the following applies:
- (1) a new operator is commencing operations;
 - (2) an operator introduces a new aeroplane type;
 - (3) flight crew members have previously completed a type conversion course with the same operator;
 - (4) credits are defined in the operational suitability data established in accordance with Commission Regulation (EU) No 748/2012; or
 - (5) the aeroplane has a maximum take-off mass of less than 10 tonnes or a maximum operational passenger seating configuration (MOPSC) of less than 20.

Helicopters

- (c) The operator should consider that, when two flight crew members are required, a flight crew member, following completion of a type rating or command course, and the associated line flying under supervision, is inexperienced until either:
- (1) he/she has achieved 50 flight hours on the type and/or in the role within a period of 60 days; or
 - (2) he/she has achieved 100 flight hours on the type and/or in the role (no time limit).
- (d) A lesser number of flight hours, on the type and/or in the role, and subject to any other conditions which the competent authority may impose, may be acceptable to the competent authority when one of the following applies:
- (1) a new operator is commencing operations;
 - (2) an operator introduces a new helicopter type;
 - (3) flight crew members have previously completed a type conversion course with the same operator (reconversion); or
 - (4) credits are defined in the operational suitability data established in accordance with Commission Regulation (EU) No 748/2012.

ORO.FC.A.201 In-flight relief of flight crew members

Regulation (EU) No 965/2012

- (a) The commander may delegate the conduct of the flight to:
- (1) another qualified commander; or
 - (2) for operations only above flight level (FL) 200, a pilot who complies with the following minimum qualifications:
 - (i) ATPL;
 - (ii) conversion training and checking, including type rating training, in accordance with [ORO.FC.220](#);
 - (iii) all recurrent training and checking in accordance with [ORO.FC.230](#) and [ORO.FC.240](#);

- (iv) route/area and aerodrome competence in accordance with [ORO.FC.105](#).
- (b) The co-pilot may be relieved by:
 - (1) another suitably qualified pilot;
 - (2) for operations only above FL 200, a cruise relief co-pilot that complies with the following minimum qualifications:
 - (i) valid commercial pilot licence (CPL) with an instrument rating;
 - (ii) conversion training and checking, including type rating training, in accordance with [ORO.FC.220](#) except the requirement for take-off and landing training;
 - (iii) recurrent training and checking in accordance with [ORO.FC.230](#) except the requirement for take-off and landing training.
- (c) A flight engineer may be relieved in flight by a crew member suitably qualified in accordance with applicable national rules.

ORO.FC.202 Single-pilot operations under IFR or at night

Regulation (EU) 2021/2237

In order to be able to fly under IFR or at night with a minimum flight crew of one pilot, the following shall be complied with:

- (a) The operator shall include in the operations manual a pilot's conversion and recurrent training programme that includes the additional requirements for a single-pilot operation. The pilot shall have undertaken training on the operator's procedures, in particular regarding:
 - (1) engine management and emergency handling;
 - (2) use of normal, abnormal and emergency checklist;
 - (3) air traffic control (ATC) communication;
 - (4) departure and approach procedures;
 - (5) autopilot management, if applicable;
 - (6) use of simplified in-flight documentation;
 - (7) single-pilot crew resource management.
- (b) INTENTIONALLY LEFT BLANK
- (c) For aeroplane operations under IFR the pilot shall have:
 - (1) a minimum of 50 hours flight time under IFR on the relevant type or class of aeroplane, of which 10 hours are as commander; and
 - (2) completed during the preceding 90 days on the relevant type or class of aeroplane:
 - (i) five IFR flights, including three instrument approaches, in a single-pilot role; or
 - (ii) an IFR instrument approach check.
- (d) For aeroplane operations at night the pilot shall have:
 - (1) a minimum of 15 hours flight time at night which may be included in the 50 hours flight time under IFR in (c)(1); and

- (2) completed during the preceding 90 days on the relevant type or class of aeroplane:
 - (i) three take-offs and landings at night in the single pilot role; or
 - (ii) a night take-off and landing check.
- (e) For helicopter operations under IFR the pilot shall have:
 - (1) 25 hours total IFR flight experience in the relevant operating environment; and
 - (2) 25 hours flight experience as a single pilot on the specific type of helicopter, approved for single-pilot IFR, of which 10 hours may be flown under supervision, including five sectors of IFR line flying under supervision using the single-pilot procedures; and
 - (3) completed during the preceding 90 days:
 - (i) five IFR flights as a single pilot, including three instrument approaches, carried out on a helicopter approved for this purpose; or
 - (ii) an IFR instrument approach check as a single pilot on the relevant type of helicopter, flight training device (FTD) or full flight simulator (FFS).

ORO.FC.205 Command course

Regulation (EU) No 965/2012

- (a) For aeroplane and helicopter operations, the command course shall include at least the following elements:
 - (1) training in an FSTD, which includes line oriented flight training (LOFT) and/or flight training;
 - (2) the operator proficiency check, operating as commander;
 - (3) command responsibilities training;
 - (4) line training as commander under supervision, for a minimum of:
 - (i) 10 flight sectors, in the case of aeroplanes; and
 - (ii) 10 hours, including at least 10 flight sectors, in the case of helicopters;
 - (5) completion of a line check as commander and demonstration of adequate knowledge of the route or area to be flown and of the aerodromes, including alternate aerodromes, facilities and procedures to be used; and
 - (6) crew resource management training.

AMC1 ORO.FC.205 Command course

ED Decision 2022/014/R

COMBINED UPGRADING AND CONVERSION COURSE — HELICOPTER

If a pilot is converting from one helicopter type to another when upgrading to commander:

- (a) the command course should also include a conversion course in accordance with [ORO.FC.220](#); and
- (b) additional flight sectors should be required for a pilot transitioning onto a new type of helicopter.

ORO.FC.215 Initial operator's crew resource management (CRM) training

Regulation (EU) No 965/2012

- (a) The flight crew member shall have completed an initial CRM training course before commencing unsupervised line flying.
- (b) Initial CRM training shall be conducted by at least one suitably qualified CRM trainer who may be assisted by experts in order to address specific areas.
- (c) If the flight crew member has not previously received theoretical training in human factors to the ATPL level, he/she shall complete, before or combined with the initial CRM training, a theoretical course provided by the operator and based on the human performance and limitations syllabus for the ATPL as established in Annex I (Part-FCL) to Regulation (EU) No 1178/2011.

AMC1 ORO.FC.215 Initial operator's crew resource management (CRM) training

ED Decision 2015/022/R

TRAINING ELEMENTS AND TRAINER QUALIFICATION

Initial operator's CRM training should:

- (a) cover the applicable provisions of [AMC1 ORO.FC.115](#), including the training elements as specified in Table 1 thereof; and
- (b) be conducted by a flight crew CRM trainer who is qualified as specified in [AMC3 ORO.FC.115](#).

[applicable until 25 March 2023 — ED Decision 2022/014/R]

- (b) be conducted by a flight crew CRM trainer who is qualified as specified in [AMC2 ORO.FC.146](#).

[applicable from 26 March 2023 — ED Decision 2022/014/R]

ORO.FC.220 Operator conversion training and checking

Regulation (EU) 2021/2237

- (a) CRM training shall be integrated into the operator conversion training course.
- (b) Once an operator conversion course has been commenced, the flight crew member shall not be assigned to flying duties on another type or class of aircraft until the course is completed or terminated. Crew members operating only performance class B aeroplanes may be assigned to flights on other types of performance class B aeroplanes during conversion courses to the extent necessary to maintain the operation. Crew members may be assigned to flights on single-engined helicopters during an operator conversion course on a single-engined helicopter, provided that the training is unaffected.
- (c) The amount of training required by the flight crew member for the operator's conversion course shall be determined in accordance with the standards of qualification and experience specified in the operations manual, taking into account his/her previous training and experience.
- (d) The flight crew member shall complete:
 - (1) the operator proficiency check and the emergency and safety equipment training and checking before commencing line flying under supervision (LIFUS); and

- (2) the line check upon completion of line flying under supervision. For performance class B aeroplanes, LIFUS may be performed on any aeroplane within the applicable class.
- (e) In the case of aeroplanes, pilots that have been issued a type rating based on a zero flight-time training ('ZFTT') course shall:
 - (1) commence line flying under supervision not later than 21 days after the completion of the skill test or after appropriate training provided by the operator. The content of that training shall be described in the operations manual;
 - (2) complete six take-offs and landings in an FSTD not later than 21 days after the completion of the skill test under the supervision of a type rating instructor for aeroplanes ('TRI(A)') occupying the other pilot seat. The number of take-offs and landings may be reduced when credits are defined in the mandatory part of the operational suitability data established in accordance with [Regulation \(EU\) No 748/2012](#). If those take-offs and landings have not been performed within 21 days, the operator shall provide refresher training the content of which shall be described in the operations manual;
 - (3) conduct the first four take-offs and landings of the LIFUS in the aeroplane under the supervision of a TRI(A) occupying the other pilot seat. The number of take-offs and landings may be reduced when credits are defined in the mandatory part of the operational suitability data established in accordance with [Regulation \(EU\) No 748/2012](#).
- (f) If operational circumstances, such as applying for a new AOC or adding a new aircraft type or class to the fleet, do not allow the operator to comply with the requirements in (d), the operator may develop a specific conversion course, to be used temporarily for a limited number of pilots.

AMC1 ORO.FC.220 Operator conversion training and checking

ED Decision 2015/022/R

OPERATOR CONVERSION TRAINING SYLLABUS

- (a) General
 - (1) The operator conversion training should include, in the following order:
 - (i) ground training and checking, including aircraft systems, and normal, abnormal and emergency procedures;
 - (ii) emergency and safety equipment training and checking, (completed before any flight training in an aircraft commences);
 - (iii) flight training and checking (aircraft and/or FSTD); and
 - (iv) line flying under supervision and line check.
 - (2) When the flight crew member has not previously completed an operator's conversion course, he/she should undergo general first-aid training and, if applicable, ditching procedures training using the equipment in water.
 - (3) Where the emergency drills require action by the non-handling pilot, the check should additionally cover knowledge of these drills.
 - (4) The operator's conversion may be combined with a new type/class rating training, as required by Commission Regulation (EU) No 1178/2011.

-
- (5) The operator should ensure that:
- (i) applicable elements of CRM training, as specified in Table 1 of [AMC1 ORO.FC.115](#), are integrated into all appropriate phases of the conversion training; and
 - (ii) the personnel integrating elements of CRM into conversion training are suitably qualified, as specified in [AMC3 ORO.FC.115](#).
- (b) Ground training
- (1) Ground training should comprise a properly organised programme of ground instruction supervised by training staff with adequate facilities, including any necessary audio, mechanical and visual aids. Self-study using appropriate electronic learning aids, computer-based training (CBT), etc., may be used with adequate supervision of the standards achieved. However, if the aircraft concerned is relatively simple, unsupervised private study may be adequate if the operator provides suitable manuals and/or study notes.
 - (2) The course of ground instruction should incorporate formal tests on such matters as aircraft systems, performance and flight planning, where applicable.
- (c) Emergency and safety equipment training and checking
- (1) Emergency and safety equipment training should take place in conjunction with cabin/technical crew undergoing similar training with emphasis on coordinated procedures and two-way communication between the flight crew compartment and the cabin.
 - (2) On the initial conversion course and on subsequent conversion courses as applicable, the following should be addressed:
 - (i) Instruction on first-aid in general (initial conversion course only); instruction on first-aid as relevant to the aircraft type of operation and crew complement, including those situations where no cabin crew is required to be carried (initial and subsequent).
 - (ii) Aero-medical topics, including:
 - (A) hypoxia;
 - (B) hyperventilation;
 - (C) contamination of the skin/eyes by aviation fuel or hydraulic or other fluids;
 - (D) hygiene and food poisoning; and
 - (E) malaria.
 - (iii) The effect of smoke in an enclosed area and actual use of all relevant equipment in a simulated smoke-filled environment.
 - (iv) Actual fire fighting, using equipment representative of that carried in the aircraft on an actual or simulated fire except that, with Halon extinguishers, an alternative extinguisher may be used.
 - (v) The operational procedures of security, rescue and emergency services.
 - (vi) Survival information appropriate to their areas of operation (e.g. polar, desert, jungle or sea) and training in the use of any survival equipment required to be carried.

- (vii) A comprehensive drill to cover all ditching procedures where flotation equipment is carried. This should include practice of the actual donning and inflation of a life-jacket, together with a demonstration or audio-visual presentation of the inflation of life-rafts and/or slide-rafts and associated equipment. This practice should, on an initial conversion course, be conducted using the equipment in water, although previous certified training with another operator or the use of similar equipment will be accepted in lieu of further wet-drill training.
 - (viii) Instruction on the location of emergency and safety equipment, correct use of all appropriate drills, and procedures that could be required of flight crew in different emergency situations. Evacuation of the aircraft (or a representative training device) by use of a slide where fitted should be included when the operations manual procedure requires the early evacuation of flight crew to assist on the ground.
- (d) Flight training
- (1) Flight training should be conducted to familiarise the flight crew member thoroughly with all aspects of limitations and normal, abnormal and emergency procedures associated with the aircraft and should be carried out by suitably qualified class and type rating instructors and/or examiners. For specific operations, such as steep approaches, ETOPS, or operations based on QFE, additional training should be carried out, based on any additional elements of training defined for the aircraft type in the operational suitability data in accordance with Commission Regulation (EU) No 748/2012, where they exist.
 - (2) In planning flight training on aircraft with a flight crew of two or more, particular emphasis should be placed on the practice of LOFT with emphasis on CRM, and the use of crew coordination procedures, including coping with incapacitation.
 - (3) Normally, the same training and practice in the flying of the aircraft should be given to co-pilots as well as commanders. The 'flight handling' sections of the syllabus for commanders and co-pilots alike should include all the requirements of the operator proficiency check required by [ORO.FC.230](#).
 - (4) Unless the type rating training programme has been carried out in an FSTD usable for ZFTT, the training should include at least three take-offs and landings in the aircraft.
- (e) Line flying under supervision (LIFUS)
- (1) Following completion of flight training and checking as part of the operator's conversion course, each flight crew member should operate a minimum number of sectors and/or flight hours under the supervision of a flight crew member nominated by the operator.
 - (2) The minimum flight sectors/hours should be specified in the operations manual and should be determined by the following:
 - (i) previous experience of the flight crew member;
 - (ii) complexity of the aircraft; and
 - (iii) the type and area of operation.
 - (3) For performance class B aeroplanes, the amount of LIFUS required is dependent on the complexity of the operations to be performed.
- (f) Passenger handling for operations where no cabin crew is required
- Other than general training on dealing with people, emphasis should be placed on the following:

- (1) advice on the recognition and management of passengers who appear or are intoxicated with alcohol, under the influence of drugs or aggressive;
 - (2) methods used to motivate passengers and the crowd control necessary to expedite an aircraft evacuation; and
 - (3) the importance of correct seat allocation with reference to aircraft mass and balance. Particular emphasis should also be given on the seating of special categories of passengers.
- (g) Discipline and responsibilities, for operations where no cabin crew is required
- Emphasis should be placed on discipline and an individual's responsibilities in relation to:
- (1) his/her ongoing competence and fitness to operate as a crew member with special regard to flight and duty time limitation (FTL) requirements; and
 - (2) security procedures.
- (h) Passenger briefing/safety demonstrations, for operations where no cabin crew is required
- Training should be given in the preparation of passengers for normal and emergency situations.

[AMC1 ORO.FC.220 applicable until 25 March 2023 — ED Decision 2022/014/R]

AMC1 ORO.FC.220 Operator conversion training and checking

ED Decision 2022/014/R

OPERATOR CONVERSION TRAINING SYLLABUS

- (a) General
- (1) The operator conversion training should include, in the following order:
 - (i) ground training and checking, including all of the following:
 - (A) aircraft systems;
 - (B) normal procedures, which include flight planning and ground-handling and flight operations, including performance, mass and balance, fuel schemes, selection of alternates, and ground de-icing/anti-icing;
 - (C) abnormal and emergency procedures, which include pilot incapacitation as applicable;
 - (D) a review of relevant samples of accident/incident and occurrences to increase awareness of the occurrences that may be relevant for the intended operation;
 - (ii) emergency and safety equipment training and checking (completed before any flight training in an aircraft commences);
 - (iii) flight training and checking (aircraft and/or FSTD); and
 - (iv) line flying under supervision and line check.
 - (2) When the flight crew member has not previously completed an operator's conversion course, he/she should undergo general first-aid training and, if applicable, ditching procedures training using the equipment in water.
 - (3) Where the emergency drills require action by the non-handling pilot, the check should additionally cover knowledge of these drills.

-
- (4) The operator's conversion may be combined with a new type/class rating training, as required by [Commission Regulation \(EU\) No 1178/2011](#).
 - (5) The operator should ensure that:
 - (i) applicable elements of CRM training, as specified in Table 1 of [AMC1 ORO.FC.115](#), are integrated into all appropriate phases of the conversion training; and
 - (ii) the personnel integrating elements of CRM into conversion training are suitably qualified, as specified in [AMC2 ORO.FC.146](#).
- (b) Ground training
- (1) Ground training should comprise a properly organised programme of ground instruction supervised by training staff with adequate facilities, including any necessary audio, mechanical and visual aids. Self-study using appropriate electronic learning aids, computer-based training (CBT), etc., may be used with adequate supervision of the standards achieved. However, if the aircraft concerned is relatively simple, unsupervised private study may be adequate if the operator provides suitable manuals and/or study notes.
 - (2) The course of ground instruction should incorporate formal tests.
- (c) Emergency and safety equipment training and checking
- (1) Emergency and safety equipment training should take place in conjunction with cabin/technical crew undergoing similar training with emphasis on coordinated procedures and two-way communication between the flight crew compartment and the cabin.
 - (2) On the initial conversion course and on subsequent conversion courses as applicable, the following should be addressed:
 - (i) Instruction on first-aid in general (initial conversion course only); instruction on first-aid as relevant to the aircraft type of operation and crew complement, including those situations where no cabin crew is required to be carried (initial and subsequent).
 - (ii) Aero-medical topics, including:
 - (A) hypoxia;
 - (B) hyperventilation;
 - (C) contamination of the skin/eyes by aviation fuel or hydraulic or other fluids;
 - (D) hygiene and food poisoning; and
 - (E) malaria.
 - (iii) The effect of smoke in an enclosed area and actual use of all relevant equipment in a simulated smoke-filled environment.
 - (iv) Actual fire fighting, using equipment representative of that carried in the aircraft on an actual or simulated fire except that, with Halon extinguishers, an alternative extinguisher may be used.
 - (v) The operational procedures of security, rescue and emergency services.

- (vi) Survival information appropriate to their areas of operation (e.g. polar, desert, jungle or sea) and training in the use of any survival equipment required to be carried.
 - (vii) A comprehensive drill to cover all ditching procedures where flotation equipment is carried. This should include practice of the actual donning and inflation of a life-jacket, together with a demonstration or audio-visual presentation of the inflation of life-rafts and/or slide-rafts and associated equipment. This practice should, on an initial conversion course, be conducted using the equipment in water, although previous certified training with another operator or the use of similar equipment will be accepted in lieu of further wet-drill training.
 - (viii) Instruction on the location of emergency and safety equipment, correct use of all appropriate drills, and procedures that could be required of flight crew in different emergency situations. Evacuation of the aircraft (or a representative training device) by use of a slide where fitted should be included when the operations manual procedure requires the early evacuation of flight crew to assist on the ground.
- (3) Operations where no cabin crew is required
- (i) Passenger handling

Other than general training on dealing with people, emphasis should be placed on the following:

 - (A) advice on the recognition and management of passengers who appear or are intoxicated with alcohol, under the influence of drugs or aggressive;
 - (B) methods used to motivate passengers and the crowd control necessary to expedite an aircraft evacuation; and
 - (C) the importance of correct seat allocation with reference to aircraft mass and balance. Particular emphasis should also be given on the seating of special categories of passengers.
 - (ii) Discipline and responsibilities

Emphasis should be placed on discipline and an individual's responsibilities in relation to:

 - (A) his or her ongoing competence and fitness to operate as a crew member with special regard to flight and duty time limitation (FTL) requirements; and
 - (B) security procedures.
 - (iii) Passenger briefing/safety demonstrations

Training should be given in the preparation of passengers for normal and emergency situations.
- (d) Flight training
- (1) Flight training should be conducted to familiarise the flight crew member thoroughly with all aspects of limitations and normal, abnormal and emergency procedures associated with the aircraft and should be carried out by suitably qualified class and type rating instructors and/or examiners. For specific operations, such as steep approaches, ETOPS, or operations based on QFE, additional training should be carried out, based on any

additional elements of training defined for the aircraft type in the operational suitability data in accordance with [Commission Regulation \(EU\) No 748/2012](#), where they exist.

- (2) In planning flight training on aircraft with a flight crew of two or more, particular emphasis should be placed on the practice of LOFT with emphasis on CRM, and the use of crew coordination procedures, including coping with incapacitation.
 - (3) Normally, the same training and practice in the flying of the aircraft should be given to co-pilots as well as commanders. The 'flight handling' sections of the syllabus for commanders and co-pilots alike should include all the requirements of the operator proficiency check required by [ORO.FC.230](#).
 - (4) Unless the type rating training programme has been carried out in an FSTD usable for ZFTT, the training should include at least three take-offs and landings in the aircraft.
- (e) Operator proficiency check
- (1) For aeroplanes, the operator proficiency check that is part of the operator's conversion checking should follow the provisions in [AMC1 ORO.FC.230](#). For EBT, the operator should include either an EBT module in accordance with [ORO.FC.231](#) or an OPC in accordance with [AMC1 ORO.FC.230](#).
 - (2) For helicopters, the operator proficiency check that is part of the operator's conversion checking should include at least the following emergency/abnormal procedures as relevant to the helicopter and operations:
 - (i) engine fire;
 - (ii) interior helicopter fire or smoke;
 - (iii) emergency operation of undercarriage;
 - (iv) hydraulic failure;
 - (v) electrical failure;
 - (vi) flight and engine control system malfunctions;
 - (vii) recovery from unusual attitudes;
 - (viii) landing with one or more engine(s) inoperative;
 - (ix) instrument meteorological conditions (IMC) autorotation techniques;
 - (x) autorotation to a designated area;
 - (xi) pilot incapacitation;
 - (xii) directional control failures and malfunctions; and
 - (xiii) engine failure and if relevant, relight;and for multi-engined helicopters:
 - (xiv) engine failure during take-off before decision point;
 - (xv) engine failure during take-off after decision point;
 - (xvi) engine failure during landing before decision point; and
 - (xvii) engine failure during landing after decision point.
 - (3) For helicopter pilots required to engage in IFR operations, the proficiency check should include the following additional normal/abnormal/emergency procedures:

- (i) 3D approach operation to minima;
 - (ii) go-around on instruments;
 - (iii) 2D approach operation to minima;
 - (iv) if relevant, at least one of the 3D or 2D approach operations should be an RNP APCH or RNP AR APCH operation;
 - (v) in the case of multi-engined helicopters, a simulated failure of one engine to be included in either the 3D or 2D approach operation to minima; and
 - (vi) where appropriate to the helicopter type, approach with flight control system/flight director system malfunctions, flight instrument and navigation equipment failures.
- (4) For helicopters, the flight crew should be assessed on their CRM skills in accordance with the methodology described in [AMC1 ORO.FC.115](#) and as specified in the operations manual.
- (5) The use of FSTDs, composition of the flight crew, and the possible combinations with training or with the licence proficiency check should be defined as per [AMC1 ORO.FC.230](#).
- (f) Line flying under supervision (LIFUS)
- (1) Following completion of flight training and checking as part of the operator's conversion course, each flight crew member should operate a minimum number of sectors and/or flight hours under the supervision of a flight crew member nominated by the operator.
 - (2) The minimum flight sectors/hours should be specified in the operations manual and should be determined by the following:
 - (i) previous experience of the flight crew member;
 - (ii) complexity of the aircraft; and
 - (iii) the type and area of operation.
 - (3) For performance class B aeroplanes, the amount of LIFUS required is dependent on the complexity of the operations to be performed.

[AMC1 ORO.FC.220 applicable from 26 March 2023]

AMC2 ORO.FC.220 Operator conversion training and checking

ED Decision 2014/017/R

OPERATOR CONVERSION TRAINING SYLLABUS — FLIGHT ENGINEERS

- (a) Operator conversion training for flight engineers should approximate to that of pilots.
- (b) If the flight crew includes a pilot with the duties of a flight engineer, he/she should, after training and the initial check in these duties, operate a minimum number of flight sectors under the supervision of a nominated additional flight crew member. The minimum figures should be specified in the operations manual and should be selected after due note has been taken of the complexity of the aircraft and the experience of the flight crew member.

AMC3 ORO.FC.220 Operator conversion training and checking

ED Decision 2022/014/R

TRAINING PROGRAMMES

The operator should ensure that training programmes include the relevant de-identified feedback from the management system, including occurrence reporting and flight data monitoring programmes.

[applicable from 26 March 2023]

AMC1 ORO.FC.220(b) Operator conversion training and checking

ED Decision 2022/014/R

ASSIGNMENT TO FLIGHTS DURING AN OPERATOR CONVERSION COURSE — HELICOPTERS

- (a) A group of helicopter types should include either only single-engined turbine helicopters operated only under VFR or only single-engined piston helicopters operated only under VFR.
- (b) The flight crew member should only be assigned to flights on a helicopter within the same group of helicopter types as the type used for the operator conversion training and checking.
- (c) Once an operator conversion course has been commenced, the flight crew member should not start another operator conversion course on another helicopter type until that course is completed or terminated.

GM1 ORO.FC.220(b) Operator conversion training and checking

ED Decision 2014/017/R

COMPLETION OF AN OPERATOR'S CONVERSION COURSE

- (a) The operator conversion course is deemed to have started when the flight training has begun. The theoretical element of the course may be undertaken ahead of the practical element.
- (b) Under certain circumstances the course may have started and reached a stage where, for unforeseen reasons, it is not possible to complete it without a delay. In these circumstances, the operator may allow the pilot to revert to the original type.
- (c) Before the resumption of the operator conversion course, the operator should evaluate how much of the course needs to be repeated before continuing with the remainder of the course.

GM1 ORO.FC.220(c) Operator conversion training and checking

ED Decision 2016/008/R

OPERATOR CONVERSION COURSE (OCC) FOR MULTI-CREW PILOT LICENCE (MPL) HOLDERS

When defining the amount of training for MPL holders, who undertake their first conversion course on a new type or at an operator other than the one that was involved in their training for the MPL, the operator should put a process in place to ensure that corrective action can be taken if post-MPL licence training evaluation indicates the need to do so.

GM1 ORO.FC.220(d) Operator conversion training and checking

ED Decision 2014/017/R

LINE FLYING UNDER SUPERVISION

- (a) Line flying under supervision provides the opportunity for a flight crew member to carry into practice the procedures and techniques he/she has been made familiar with during the ground and flight training of an operator conversion course. This is accomplished under the supervision of a flight crew member specifically nominated and trained for the task. At the end of line flying under supervision the respective crew member should be able to perform a safe and efficient flight conducted within the tasks of his/her crew member station.
- (b) A variety of reasonable combinations may exist with respect to:
 - (1) a flight crew member's previous experience;
 - (2) the complexity of the aircraft concerned; and
 - (3) the type of route/role/area operations.

(c) Aeroplanes

The following minimum figures for details to be flown under supervision are guidelines for operators to use when establishing their individual requirements:

- (1) turbo-jet aircraft
 - (i) co-pilot undertaking first operator conversion course:
 - (A) total accumulated 100 hours or minimum 40 flight sectors;
 - (ii) co-pilot upgrading to commander:
 - (A) minimum 20 flight sectors when converting to a new type;
 - (B) minimum 10 flight sectors when already qualified on the aeroplane type.

AMC1 ORO.FC.220(f) Operator conversion training and checking

ED Decision 2022/014/R

SPECIFIC CONVERSION COURSE — SUITABLY QUALIFIED COMMANDER NOMINATED BY THE OPERATOR — PILOTS WHO TEMPORARILY JOIN THE OPERATOR AND WILL BE NOMINATED TO CONDUCT LINE CHECKS

- (a) In some cases, operational circumstances may require the operator to develop a specific conversion course to nominate pilots as suitably qualified commanders to conduct line checks in accordance with the requirements of [ORO.FC.146](#). In this case, the operator conversion training should include training as follows:
 - (1) normal procedures, which include flight planning and ground-handling and flight operations, including performance, mass and balance, fuel schemes, selection of alternates, and ground de-icing/anti-icing;
 - (2) abnormal and emergency procedures, which include pilot incapacitation as applicable.
- (b) The operator should ensure that the line checker is familiar with:
 - (1) the operating procedures and the use of checklists used by the operator;
 - (2) the emergency and safety equipment installed or carried on the operated aircraft.

- (c) After the completion of the specific conversion course, the following apply:
 - (1) The line checker should not exercise duties at the controls of the aircraft.
 - (2) The line checker should only conduct recurrent line checks of pilots whose previous line check has not expired, in accordance with [ORO.FC.230](#).
- (d) The validity of the specific conversion course should be limited to 6 months.

GM1 ORO.FC.220(f) Operator conversion training and checking

ED Decision 2022/014/R

SPECIF CONVERSION COURSE TO BE USE TEMPORARILY FOR A LIMITED NUMBER OF PILOTS — NEW AOC OR ADDITION OF A NEW AIRCRAFT TYPE OR CLASS TO THE FLEET

For a new AOC or for the addition of a new aircraft type or class to the fleet, the operator may contact the competent authority to agree on a specific conversion course to be included in the operations manual (CAT requires approval in accordance with [ORO.FC.145 point \(c\)](#)) to be used temporarily for a limited number of pilots. The specific course may include an agreement on the minimum experience of the pilots, the required experience of the line supervisor and line checkers amongst others.

AMC1 ORO.FC.220&230 Operator conversion training and checking & recurrent training and checking

ED Decision 2019/025/R

UPSET PREVENTION AND RECOVERY TRAINING (UPRT) FOR COMPLEX MOTOR-POWERED AEROPLANES WITH A MAXIMUM OPERATIONAL PASSENGER SEATING CONFIGURATION (MOPSC) OF MORE THAN 19

- (a) Upset prevention training should:
 - (1) consist of ground training and flight training in an FSTD or an aeroplane;
 - (2) include upset prevention elements from Table 1 for the conversion training course; and
 - (3) include upset prevention elements in Table 1 for the recurrent training programme at least every 12 calendar months, such that all the elements are covered over a period not exceeding 3 years.

Table 1: Elements and respective components of upset prevention training

Elements and components		Ground training	FSTD/ Aeroplane training
A.	Aerodynamics		
1.	General aerodynamic characteristics	•	
2.	Aeroplane certification and limitations	•	
3.	Aerodynamics (high and low altitudes)	•	•
4.	Aeroplane performance (high and low altitudes)	•	•
5.	Angle of attack (AOA) and stall awareness	•	•
6.	Stick shaker or other stall-warning device activation (as applicable)	•	•
7.	Stick pusher (as applicable)	•	•
8.	Mach effects (if applicable to the aeroplane type)	•	•
9.	Aeroplane stability	•	•
10.	Control surface fundamentals	•	•

Elements and components		Ground training	FSTD/ Aeroplane training
11.	Use of trims	•	•
12.	Icing and contamination effects	•	•
13.	Propeller slipstream (as applicable)	•	•
B.	Causes of and contributing factors to upsets		
1.	Environmental	•	
2.	Pilot-induced	•	
3.	Mechanical (aeroplane systems)	•	
C.	Safety review of accidents and incidents relating to aeroplane upsets		
1.	Safety review of accidents and incidents relating to aeroplane upsets	•	
D.	g-load awareness and management		
1.	Positive/negative/increasing/decreasing g-loads	•	•
2.	Lateral g awareness (sideslip)	•	•
3.	g-load management	•	•
E.	Energy management		
1.	Kinetic energy vs potential energy vs chemical energy (power)	•	•
F.	Flight path management		
1.	Relationship between pitch, power and performance	•	•
2.	Performance and effects of differing power plants (if applicable)	•	•
3.	Manual and automation inputs for guidance and control	•	•
4.	Type-specific characteristics	•	•
5.	Management of go-arounds from various stages during the approach	•	•
6.	Automation management	•	•
7.	Proper use of rudder	•	•
G.	Recognition		
1.	Type-specific examples of physiological, visual and instrument clues during developing and developed upsets	•	•
2.	Pitch/power/roll/yaw	•	•
3.	Effective scanning (effective monitoring)	•	•
4.	Type-specific stall protection systems and cues	•	•
5.	Criteria for identifying stalls and upsets	•	•
H.	System malfunction (including immediate handling and subsequent operational considerations, as applicable)		
1.	Flight control defects	•	•
2.	Engine failure (partial or full)	•	•
3.	Instrument failures	•	•
4.	Loss of reliable airspeed	•	•
5.	Automation failures	•	•
6.	Fly-by-wire protection degradations	•	•
7.	Stall protection system failures including icing alerting systems	•	•
I.	Manual handling skills (no autopilot, no autothrust/autothrottle and, where possible, without flight directors)		
1.	Flight at different speeds, including slow flight, and altitudes within the full normal flight envelope		•

Elements and components		Ground training	FSTD/ Aeroplane training
2.	Procedural instrument flying and manoeuvring including instrument departure and arrival		•
3.	Visual approach		•
4.	Go-arounds from various stages during the approach (refer to point (d) of GM1 to Appendix 9 to Part-FCL ¹ for further guidance on go-around training)	•	•
5.	Steep turns		•

- (b) Upset recovery training should:
- (1) consist of ground training and flight training in an FFS qualified for the training task;
 - (2) be completed from each seat in which a pilot's duties require him/her to operate; and
 - (3) include the recovery exercises in Table 2 for the recurrent training programme, such that all the exercises are covered over a period not exceeding 3 years.

Table 2: Exercises for upset recovery training

Exercises		Ground training	FFS training
A.	Recovery from developed upsets		
1.	Timely and appropriate intervention	•	•
2.	Recovery from stall events, in the following configurations; <ul style="list-style-type: none"> — take-off configuration, — clean configuration low altitude, — clean configuration near maximum operating altitude, and — landing configuration during the approach phase. 	•	•
3.	Recovery from nose high at various bank angles	•	•
4.	Recovery from nose low at various bank angles	•	•
5.	Consolidated summary of aeroplane recovery techniques	•	•

- (c) The operator should ensure that personnel providing FSTD UPRT are competent and current to deliver the training, and understand the capabilities and limitations of the device used.
- (d) An FFS that is used for the training referred to in point (b)(1) should be qualified in accordance with the special evaluation requirements set out in CS-FSTD(A) (Issue 2 or later).

¹ Please refer to [ED Decision 2011/016/R](#).

AMC2 ORO.FC.220&230 Operator conversion training and checking & recurrent training and checking

ED Decision 2019/025/R

UPSET PREVENTION AND RECOVERY TRAINING (UPRT) FOR COMPLEX MOTOR-POWERED AEROPLANES WITH A MAXIMUM OPERATIONAL PASSENGER SEATING CONFIGURATION (MOPSC) OF 19 OR LESS

- (a) Upset prevention training should:
- (1) consist of ground training and flight training in an FSTD or an aeroplane;
 - (2) include upset prevention elements in Table 1 of [AMC1 ORO.FC.220&230](#) for the conversion training course; and
 - (3) include upset prevention elements in Table 1 of [AMC1 ORO.FC.220&230](#) for the recurrent training programme at least every 12 calendar months, such that all the elements are covered over a period not exceeding 3 years.
- (b) Upset recovery training should:
- (1) consist of ground training and flight training in an FFS qualified for the training task, if available;
 - (2) be completed from each seat in which a pilot's duties require him/her to operate; and
 - (3) include the recovery exercises in Table 2 of [AMC1 ORO.FC.220&230](#) for the recurrent training programme, such that all the exercises are covered over a period not exceeding 3 years.
- (c) The operator should ensure that personnel providing FSTD UPRT are competent and current to deliver the training, and understand the capabilities and limitations of the device used.
- (d) An FFS that is used for the training referred to in point (b)(1) should be qualified in accordance with the special evaluation requirements set out in CS-FSTD(A) (Issue 2 or later).

GM1 ORO.FC.220&230 Operator conversion training and checking & recurrent training and checking

ED Decision 2019/005/R

UPSET PREVENTION AND RECOVERY TRAINING (UPRT) FOR COMPLEX MOTOR-POWERED AEROPLANES

The objective of the UPRT is to help flight crew acquire the required competencies in order to prevent or recover from a developing or developed aeroplane upset. Prevention training prepares flight crew to avoid incidents whereas recovery training prepares flight crew to prevent an accident once an upset condition has developed.

HUMAN FACTORS

Threat and Error Management (TEM) and Crew Resource Management (CRM) principles should be integrated into the UPRT. In particular, the surprise and startle effect, and the importance of resilience development should be emphasised.

Training should also emphasise that an actual upset condition may expose flight crew to significant physiological and psychological challenges, such as visual illusions, spatial disorientation and unusual g-forces, with the objective to develop strategies to deal with such challenges.

USE OF FSTD FOR UPRT

The use of an FSTD provides valuable training without the risks associated with aeroplane training. The training envelope (envelope within which all training exercises will be carried out) should be specified by the operator in terms of the range of attitudes, speed and g-loads that can be used for training, taking into account:

- (1) the training environment;
- (2) the capabilities of the instructors; and
- (3) in the case of training in FSTDs, the limitations of the FSTD (as per [GM15 to Annex I](#) (Definitions) to Commission Regulation (EU) No 965/2012 for the FSTD training envelope); and
- (4) in the case of training in aeroplanes, the capabilities and certification of the aeroplane, while considering a margin of safety in order to ensure that unintentional deviations from the training envelope will not exceed aeroplane limitations. Different training envelopes may be specified for different aeroplane types even within a single training course.

ADDITIONAL GUIDANCE

Specific guidance to the UPRT elements and exercises contained in the AMC is available from the latest revision of the ICAO Document 10011 ('Manual on UPRT').

Further guidance is available in:

- Revision 2 (as regards training scenarios for UPRT) and Revision 3 of the Aeroplane Upset Recovery Training Aid (AURTA (Revision 2) / AUPRTA (Revision 3)); and
- the Flight Safety Foundation Publication ('A Practical Guide for Improving Flight Path Monitoring'), November 2014.

GM2 ORO.FC.220&230 Operator conversion training and checking & recurrent training and checking

ED Decision 2019/005/R

UPSET PREVENTION TRAINING FOR COMPLEX MOTOR-POWERED AEROPLANES

The recurrent training should prioritise the upset prevention elements and respective components according to the operator's safety risk assessment.

Upset prevention training should use a combination of manoeuvre-based and scenario-based training. Scenario-based training may be used to introduce flight crew to situations which, if not correctly managed, could lead to an upset condition. Relevant TEM and CRM aspects should be included in scenario-based training and the flight crew should understand the limitations of the FSTD in replicating the physiological and psychological aspects of exposure to upset prevention scenarios.

In order to avoid negative training and negative transfer of training, operators should ensure that the selected upset prevention scenarios and exercises take into consideration the limitations of the FSTD and the extent to which it represents the handling characteristics of the actual aeroplane. If it is determined that the FSTD is not suitable, the operator should ensure that the required training outcome can be achieved by other means.

GO-AROUNDS FROM VARIOUS STAGES DURING THE APPROACH

Guidance on go-around training is provided in point (d) of GM1 to Appendix 9 to Part-FCL.

GM3 ORO.FC.220&230 Operator conversion training and checking & Recurrent training and checking

ED Decision 2019/025/R

UPSET RECOVERY TRAINING FOR COMPLEX MOTOR-POWERED AEROPLANES

The upset recovery training exercises should be manoeuvre-based, which enables flight crew to apply their handling skills and recovery strategy whilst leveraging CRM principles to return the aeroplane from an upset condition to a stabilised flight path.

The flight crew should understand the limitations of the FFS in replicating the physiological and psychological aspects of upset recovery exercises.

In order to avoid negative training and negative transfer of training, operators should ensure that the selected upset recovery exercises take into consideration the limitations of the FFS.

STALL EVENT RECOVERY TRAINING

It is of utmost importance that stall event recovery training takes into account the capabilities of the FFS used. To deliver stall event recovery training, the FFS should be qualified against the relevant UPRT elements of CS-FSTD(A) (Issue 2 or later). Stall event recovery training should include training up to the stall (approach-to-stall). Post-stall training may be delivered, provided the device has been qualified against the relevant optional elements of CS-FSTD(A) (Issue 2 or later) and the operator demonstrates that negative training or negative transfer of training is avoided. A ‘stall event’ is defined as an occurrence whereby the aeroplane experiences one or more conditions associated with an approach-to-stall or stall.

Stall event recovery training should emphasise the requirement to reduce the angle of attack (AOA) whilst accepting the resulting altitude loss. High-altitude stall event training should be included so that flight crew appreciate the aeroplane control response, the significant altitude loss during the recovery, and the increased time required. The training should also emphasise the risk of triggering a secondary stall event during the recovery.

Recovery from a stall event should always be in accordance with the stall event recovery procedures of the OEMs. If an OEM-approved recovery procedure does not exist, operators should develop and train the aeroplane-specific stall recovery procedure based on the template in Table 1 below.

Refer to Revision 3 of the Airplane Upset Prevention and Recovery Training Aid (AUPRTA) for a detailed explanation and rationale on the stall event recovery template as recommended by the OEMs.

Table 1: Recommended Stall Event Recovery Template

Stall Event Recovery Template		
Pilot Flying - Immediately do the following at first indication of a stall (aerodynamic buffeting, reduced roll stability and aileron effectiveness, visual or aural cues and warnings, reduced elevator (pitch) authority, inability to maintain altitude or arrest rate of descent, stick shaker activation (if installed).) – during any flight phases <i>except at lift-off</i> .		
Pilot Flying (PF)		Pilot Monitoring (PM)
1.	AUTOPILOT – DISCONNECT (A large out-of-trim condition could be encountered when the autopilot is disconnected.)	MONITOR airspeed and attitude throughout the

2.	AUTOTHRUST/AUTOTHROTTLE – OFF	recovery and ANNOUNCE any continued divergence
3.	a) NOSE DOWN PITCH CONTROL apply until stall warning is eliminated b) NOSE DOWN PITCH TRIM (as needed) (Reduce the angle of attack (AOA) whilst accepting the resulting altitude loss.)	
4.	BANK – WINGS LEVEL	
5.	THRUST – ADJUST (as needed) (Thrust reduction for aeroplanes with underwing mounted engines may be needed)	
6.	SPEEDBRAKES/SPOILERS - RETRACT	
7.	When airspeed is sufficiently increasing - RECOVER to level flight (Avoid the secondary stall due premature recovery or excessive g-loading.)	

NOSE HIGH AND NOSE LOW RECOVERY TRAINING

Nose-high and nose-low recovery training should be in accordance with the strategies recommended by the OEMs contained in the Tables 2 and 3 below. As the OEM procedures always take precedence over the recommendations, operators should consult their OEM on whether any approved type-specific recovery procedures are available prior to using the templates.

Refer to Revision 3 of the Airplane Upset Prevention and Recovery Training Aid (AUPRTA) for a detailed explanation and rationale on the nose high and nose low recovery strategies as recommended by the OEMs.

Table 2: Recommended Nose High Recovery Strategy Template

Nose HIGH Recovery Strategy		
Either pilot - Recognise and confirm the developing situation by announcing: 'Nose High'		
	PF	PM
1.	AUTOPILOT – DISCONNECT (A large out of trim condition could be encountered when the AP is disconnected.)	MONITOR airspeed and attitude throughout the recovery and ANNOUNCE any continued divergence
2.	AUTOTHRUST/AUTOTHROTTLE – OFF	
3.	APPLY as much nose-down control input as required to obtain a nose-down pitch rate	
4.	THRUST – ADJUST (if required) (Thrust reduction for aeroplanes with underwing mounted engines may be needed.)	
5.	ROLL – ADJUST (if required) (Avoid exceeding 60 degrees bank.)	
6.	When airspeed is sufficiently increasing - RECOVER to level flight (Avoid the secondary stall due premature recovery or excessive g-loading.)	
NOTE:		
1)	Recovery to level flight may require use of pitch trim.	
2)	If necessary, consider reducing thrust in aeroplanes with underwing-mounted engines to aid in achieving nose-down pitch rate.	
3)	WARNING: Excessive use of pitch trim or rudder may aggravate the upset situation or may result in high structural loads.	

Table 3: Recommended Nose Low Recovery Strategy Template

Nose LOW Recovery Strategy Template		
Either pilot - Recognise and confirm the developing situation by announcing: 'Nose Low' (If the autopilot or autothrust/autothrottle is responding correctly, it may not be appropriate to decrease the level of automation while assessing if the divergence is being stopped.)		
PF		PM
1.	AUTOPILOT – DISCONNECT (A large out of trim condition could be encountered when the AP is disconnected.)	MONITOR airspeed and attitude throughout the recovery and ANNOUNCE any continued divergence
2.	AUTOTHRUST/AUTOTHROTTLE – OFF	
3.	RECOVERY from stall if required	
4.	ROLL in the shortest direction to wings level. (It may be necessary to reduce the g-loading by applying forward control pressure to improve roll effectiveness)	
5.	THRUST and DRAG – ADJUST (if required)	
6.	RECOVER to level flight. (Avoid the secondary stall due premature recovery or excessive g-loading.)	
NOTE:		
1)	Recovery to level flight may require use of pitch trim.	
2)	WARNING: Excessive use of pitch trim or rudder may aggravate the upset situation or may result in high structural loads.	

GM4 ORO.FC.220&230 Operator conversion training and checking & recurrent training and checking

ED Decision 2015/012/R

(deleted)

GM5 ORO.FC.220&230 Operator conversion training and checking & recurrent training and checking

ED Decision 2019/005/R

PERSONNEL PROVIDING FSTD UPSET PREVENTION AND RECOVERY TRAINING (UPRT)

It is of paramount importance that personnel providing UPRT in FSTDs have the specific competence to deliver such training, which may not have been demonstrated during previous instructor qualification training. Operators should, therefore, have a comprehensive training and standardisation programme in place, and may need to provide FSTD instructors with additional training to ensure such instructors have and maintain complete knowledge and understanding of the UPRT operating environment, and skill sets.

Standardisation and training should ensure that personnel providing FSTD UPRT:

- (1) are able to demonstrate the correct upset recovery techniques for the specific aeroplane type;
- (2) understand the importance of applying type-specific Original Equipment Manufacturers (OEMs) procedures for recovery manoeuvres;
- (3) are able to distinguish between the applicable SOPs and the OEMs recommendations (if available);
- (4) understand the capabilities and limitations of the FSTD used for UPRT, based on the applicable FSTD training envelope;

- (5) are aware of the potential of negative transfer of training that may exist when training outside the capabilities of the FSTD;
- (6) understand and are able to use the IOS of the FSTD in the context of effective UPRT delivery;
- (7) understand and are able to use the FSTD instructor tools available for providing accurate feedback on flight crew performance;
- (8) understand the importance of adhering to the FSTD UPRT scenarios that have been validated by the training programme developer; and
- (9) understand the missing critical human factor aspects due to the limitations of the FSTD and convey this to the flight crew receiving the training.

ORO.FC.230 Recurrent training and checking

Regulation (EU) 2021/2237

- (a) **Each flight crew member shall complete recurrent training and checking relevant to the type or variant, and associated equipment of aircraft on which they operate.**
- (b) **Operator proficiency check**
 - (1) Each flight crew member shall complete operator proficiency checks as part of the normal crew complement.
 - (2) When the flight crew member will be required to operate under IFR, the operator proficiency check shall be conducted without external visual reference, as appropriate.
 - (3) The validity period of the operator proficiency check shall be 6 calendar months. For operations under VFR by day of performance class B aeroplanes that are conducted during seasons not longer than 8 consecutive months, one operator proficiency check shall be sufficient. The proficiency check shall be undertaken before commencing CAT operations.
- (c) **Line check**

Each flight crew member shall complete a line check on the aircraft. The validity period of the line check shall be 12 calendar months.
- (d) **Emergency and safety equipment training and checking**

Each flight crew member shall complete recurrent training and checking on the location and use of all emergency and safety equipment carried on board the aircraft. The validity period of an emergency and safety equipment training and checking shall be 12 calendar months.
- (e) **CRM training**
 - (1) Elements of CRM shall be integrated into all appropriate phases of the recurrent training.
 - (2) Each flight crew member shall undergo specific modular CRM training. All major topics of CRM training shall be covered by distributing modular training sessions as evenly as possible over each 3-year period.
- (f) **Each flight crew member shall undergo ground training and flight training in an FSTD or an aircraft, or a combination of FSTD and aircraft training, at least every 12 calendar months.**

AMC1 ORO.FC.230 Recurrent training and checking

ED Decision 2016/019/R

RECURRENT TRAINING SYLLABUS

(a) Recurrent training

Recurrent training should comprise the following:

(1) Ground training

(i) The ground training programme should include:

- (A) aircraft systems;
- (B) operational procedures and requirements, including ground de-icing/anti-icing and pilot incapacitation; and
- (C) accident/incident and occurrence review.

(ii) Knowledge of the ground training should be verified by a questionnaire or other suitable methods.

(iii) When the ground training is conducted within 3 calendar months prior to the expiry of the 12 calendar months period, the next ground and refresher training should be completed within 12 calendar months of the original expiry date of the previous training.

(2) Emergency and safety equipment training

(i) Emergency and safety equipment training may be combined with emergency and safety equipment checking and should be conducted in an aircraft or a suitable alternative training device.

(ii) Every year the emergency and safety equipment training programme should include the following:

- (A) actual donning of a life-jacket, where fitted;
- (B) actual donning of protective breathing equipment, where fitted;
- (C) actual handling of fire extinguishers of the type used;
- (D) instruction on the location and use of all emergency and safety equipment carried on the aircraft;
- (E) instruction on the location and use of all types of exits;
- (F) security procedures.

(iii) Every 3 years the programme of training should include the following:

- (A) actual operation of all types of exits;
- (B) demonstration of the method used to operate a slide where fitted;
- (C) actual fire-fighting using equipment representative of that carried in the aircraft on an actual or simulated fire except that, with Halon extinguishers, an alternative extinguisher may be used;
- (D) the effects of smoke in an enclosed area and actual use of all relevant equipment in a simulated smoke-filled environment;
- (E) actual handling of pyrotechnics, real or simulated, where applicable;

- (F) demonstration in the use of the life-rafts where fitted. In the case of helicopters involved in extended over water operations, demonstration and use of the life-rafts.

Helicopter water survival training

Where life-rafts are fitted for helicopter extended overwater operations (such as sea pilot transfer, offshore operations, regular, or scheduled, coast-to-coast overwater operations), a comprehensive wet drill to cover all ditching procedures should be practised by aircraft crew. This wet drill should include, as appropriate, practice of the actual donning and inflation of a life-jacket, together with a demonstration or audio-visual presentation of the inflation of life-rafts. Crews should board the same (or similar) life-rafts from the water whilst wearing a life-jacket. Training should include the use of all survival equipment carried on board life-rafts and any additional survival equipment carried separately on board the aircraft;

consideration should be given to the provision of further specialist training such as underwater escape training. Where operations are predominately conducted offshore, operators should conduct 3-yearly helicopter underwater escape training at an appropriate facility;

wet practice drill should always be given in initial training unless the crew member concerned has received similar training provided by another operator;

- (G) particularly in the case where no cabin crew is required, first-aid, appropriate to the aircraft type, the kind of operation and crew complement.
- (iv) The successful resolution of aircraft emergencies requires interaction between flight crew and cabin/technical crew and emphasis should be placed on the importance of effective coordination and two-way communication between all crew members in various emergency situations.
- (v) Emergency and safety equipment training should include joint practice in aircraft evacuations so that all who are involved are aware of the duties other crew members should perform. When such practice is not possible, combined flight crew and cabin/technical crew training should include joint discussion of emergency scenarios.
- (vi) Emergency and safety equipment training should, as far as practicable, take place in conjunction with cabin/technical crew undergoing similar training with emphasis on coordinated procedures and two-way communication between the flight crew compartment and the cabin.
- (3) CRM
- Elements of CRM training, as specified in Table 1 of [AMC1 ORO.FC.115](#), should be integrated into all appropriate phases of recurrent training.

-
- (4) Aircraft/FSTD training
- (i) General
- (A) The aircraft/FSTD training programme should be established in a way that all major failures of aircraft systems and associated procedures will have been covered in the preceding 3 year period.
- (B) When engine-out manoeuvres are carried out in an aircraft, the engine failure should be simulated.
- (C) Aircraft/FSTD training may be combined with the operator proficiency check.
- (D) When the aircraft/FSTD training is conducted within 3 calendar months prior to the expiry of the 12 calendar months period, the next aircraft/FSTD training should be completed within 12 calendar months of the original expiry date of the previous training.
- (ii) Helicopters
- (A) Where a suitable FSTD is available, it should be used for the aircraft/FSTD training programme. If the operator is able to demonstrate, on the basis of a compliance and risk assessment, that using an aircraft for this training provides equivalent standards of training with safety levels similar to those achieved using an FSTD, the aircraft may be used for this training to the extent necessary.
- (B) The recurrent training should include the following additional items, which should be completed in an FSTD:
- settling with power and vortex ring;
 - loss of tail rotor effectiveness.
- (5) For operations with other-than-complex motor-powered aeroplanes, all training and checking should be relevant to the type of operation and class of aeroplane on which the flight crew member operates with due account taken of any specialised equipment used.
- (b) Recurrent checking
- Recurrent checking should comprise the following:
- (1) Operator proficiency checks
- (i) Aeroplanes
- Where applicable, operator proficiency checks should include the following manoeuvres as pilot flying:
- (A) rejected take-off when an FSTD is available to represent that specific aeroplane, otherwise touch drills only;
- (B) take-off with engine failure between V_1 and V_2 (take-off safety speed) or, if carried out in an aeroplane, at a safe speed above V_2 ;
- (C) 3D approach operation to minima with, in the case of multi-engine aeroplanes, one-engine-inoperative;
- (D) 2D approach operation to minima;

- (E) at least one of the 3D or 2D approach operations should be an RNP APCH or RNP AR APCH operation;
 - (F) missed approach on instruments from minima with, in the case of multi-engined aeroplanes, one-engine-inoperative;
 - (G) landing with one-engine-inoperative. For single-engine aeroplanes a practice forced landing is required.
- (ii) Helicopters
- (A) Where applicable, operator proficiency checks should include the following abnormal/emergency procedures:
 - engine fire;
 - fuselage fire;
 - emergency operation of under carriage;
 - fuel dumping;
 - engine failure and relight;
 - hydraulic failure;
 - electrical failure;
 - engine failure during take-off before decision point;
 - engine failure during take-off after decision point;
 - engine failure during landing before decision point;
 - engine failure during landing after decision point;
 - flight and engine control system malfunctions;
 - recovery from unusual attitudes;
 - landing with one or more engine(s) inoperative;
 - instrument meteorological conditions (IMC) autorotation techniques;
 - autorotation to a designated area;
 - pilot incapacitation;
 - directional control failures and malfunctions.
 - (B) For pilots required to engage in IFR operations, proficiency checks include the following additional abnormal/emergency procedures:
 - 3D approach operation to minima;
 - go-around on instruments from minima with, in the case of multi-engined helicopters, a simulated failure of one engine;
 - 2D approach operation to minima;
 - at least one of the 3D or 2D approach operations should be an RNP APCH or RNP AR APCH operation;
 - in the case of multi-engined helicopters, a simulated failure of one engine to be included in either the 3D or 2D approach operation to minima;

- landing with a simulated failure of one or more engines;
 - where appropriate to the helicopter type, approach with flight control system/flight director system malfunctions, flight instrument and navigation equipment failures.
- (C) Before a flight crew member without a valid instrument rating is allowed to operate in VMC at night, he/she should be required to undergo a proficiency check at night. Thereafter, each second proficiency check should be conducted at night.
- (iii) Once every 12 months the checks prescribed in (b)(1)(ii)(A) may be combined with the proficiency check for revalidation or renewal of the aircraft type rating.
- (iv) Operator proficiency checks should be conducted by a type rating examiner (TRE) or a synthetic flight examiner (SFE), as applicable.
- (2) Emergency and safety equipment checks
- The items to be checked should be those for which training has been carried out in accordance with (a)(2).
- (3) Line checks
- (i) Line checks should establish the ability to perform satisfactorily a complete line operation, including pre-flight and post-flight procedures and use of the equipment provided, as specified in the operations manual. The route chosen should be such as to give adequate representation of the scope of a pilot's normal operations. When weather conditions preclude a manual landing, an automatic landing is acceptable. The commander, or any pilot who may be required to relieve the commander, should also demonstrate his/her ability to 'manage' the operation and take appropriate command decisions.
- (ii) The flight crew should be assessed on their CRM skills in accordance with the methodology described in [AMC1 ORO.FC.115](#) and as specified in the operations manual.
- (iii) CRM assessment should not be used as a reason for a failure of the line check, unless the observed behaviour could lead to an unacceptable reduction in safety margin.
- (iv) When pilots are assigned duties as pilot flying and pilot monitoring, they should be checked in both functions.
- (v) Line checks should be conducted by a commander nominated by the operator. The operator should inform the competent authority about the persons nominated. The person conducting the line check should occupy an observer's seat where installed. His/her CRM assessments should solely be based on observations made during the initial briefing, cabin briefing, flight crew compartment briefing and those phases where he/she occupies the observer's seat.
- (A) For aeroplanes, in the case of long haul operations where additional operating flight crew are carried, the person may fulfil the function of a cruise relief pilot and should not occupy either pilot's seat during take-off, departure, initial cruise, descent, approach and landing.
- (vi) Where a pilot is required to operate as pilot flying and pilot monitoring, he/she should be checked on one flight sector as pilot flying and on another flight sector

as pilot monitoring. However, where the operator's procedures require integrated flight preparation, integrated cockpit initialisation and that each pilot performs both flying and monitoring duties on the same sector, then the line check may be performed on a single flight sector.

- (4) When the operator proficiency check, line check or emergency and safety equipment check are undertaken within the final 3 calendar months of validity of a previous check, the period of validity of the subsequent check should be counted from the expiry date of the previous check.
 - (5) In the case of single-pilot operations with helicopters, the recurrent checks referred to in (b)(1), (2) and (3) should be performed in the single-pilot role on a particular helicopter type in an environment representative of the operation.
- (c) Flight crew incapacitation training, except single-pilot operations
- (1) Procedures should be established to train flight crew to recognise and handle flight crew incapacitation. This training should be conducted every year and can form part of other recurrent training. It should take the form of classroom instruction, discussion, audio-visual presentation or other similar means.
 - (2) If an FSTD is available for the type of aircraft operated, practical training on flight crew incapacitation should be carried out at intervals not exceeding 3 years.
- (d) Personnel providing training and checking
- Training and checking should be provided by the following personnel:
- (1) ground and refresher training by suitably qualified personnel;
 - (2) flight training by a flight instructor (FI), type rating instructor (TRI) or class rating instructor (CRI) or, in the case of the FSTD content, a synthetic flight instructor (SFI), providing that the FI, TRI, CRI or SFI satisfies the operator's experience and knowledge requirements sufficient to instruct on the items specified in paragraphs (a)(1)(i)(A) and (B);
 - (3) emergency and safety equipment training by suitably qualified personnel;
 - (4) CRM:
 - (i) integration of CRM elements into all the phases of the recurrent training by all the personnel conducting recurrent training. The operator should ensure that all personnel conducting recurrent training are suitably qualified to integrate elements of CRM into this training;
 - (ii) classroom CRM training by at least one CRM trainer, qualified as specified in [AMC3 ORO.FC.115](#) who may be assisted by experts in order to address specific areas.
 - (5) recurrent checking by the following personnel:
 - (i) operator proficiency check by a type rating examiner (TRE), class rating examiner (CRE) or, if the check is conducted in an FSTD, a TRE, CRE or a synthetic flight examiner (SFE), trained in CRM concepts and the assessment of CRM skills.
 - (ii) emergency and safety equipment checking by suitably qualified personnel.

- (e) Use of FSTD
- (1) Training and checking provide an opportunity to practice abnormal/emergency procedures that rarely arise in normal operations and should be part of a structured programme of recurrent training. This should be carried out in an FSTD whenever possible.
 - (2) The line check should be performed in the aircraft. All other training and checking should be performed in an FSTD, or, if it is not reasonably practicable to gain access to such devices, in an aircraft of the same type or in the case of emergency and safety equipment training, in a representative training device. The type of equipment used for training and checking should be representative of the instrumentation, equipment and layout of the aircraft type operated by the flight crew member.
 - (3) Because of the unacceptable risk when simulating emergencies such as engine failure, icing problems, certain types of engine(s) (e.g. during continued take-off or go-around, total hydraulic failure), or because of environmental considerations associated with some emergencies (e.g. fuel dumping) these emergencies should preferably be covered in an FSTD. If no FSTD is available, these emergencies may be covered in the aircraft using a safe airborne simulation, bearing in mind the effect of any subsequent failure, and the exercise must be preceded by a comprehensive briefing.

[AMC1 ORO.FC.230 applicable until 25 March 2023 — ED Decision 2022/014/R]

AMC1 ORO.FC.230 Recurrent training and checking

ED Decision 2022/014/R

RECURRENT TRAINING AND CHECKING SYLLABUS

(a) Recurrent training

Recurrent training should comprise the following:

- (1) Ground training
 - (i) The ground training programme should include:
 - (A) aircraft systems;
 - (B) normal procedures, which include flight planning and ground-handling and flight operations, including performance, mass and balance, fuel schemes, selection of alternates, and ground de-icing/anti-icing;
 - (C) abnormal and emergency procedures, which include pilot incapacitation as applicable;
 - (D) a review of relevant samples of accident/incident and occurrences to increase awareness of the occurrences that may be relevant for the intended operation.
 - (ii) Knowledge of the ground training should be verified by a questionnaire or other suitable methods.
- (2) Emergency and safety equipment training
 - (i) Emergency and safety equipment training may be combined with emergency and safety equipment checking and should be conducted in an aircraft or a suitable alternative training device.

- (ii) Every year the emergency and safety equipment training programme should include the following:
 - (A) actual donning of a life-jacket, where fitted;
 - (B) actual donning of protective breathing equipment, where fitted;
 - (C) actual handling of fire extinguishers of the type used;
 - (D) instruction on the location and use of all emergency and safety equipment carried on the aircraft;
 - (E) instruction on the location and use of all types of exits;
 - (F) security procedures.
- (iii) Every 3 years the programme of training should include the following:
 - (A) actual operation of all types of exits;
 - (B) demonstration of the method used to operate a slide where fitted;
 - (C) actual fire-fighting using equipment representative of that carried in the aircraft on an actual or simulated fire except that, with Halon extinguishers, an alternative extinguisher may be used;
 - (D) the effects of smoke in an enclosed area and actual use of all relevant equipment in a simulated smoke-filled environment;
 - (E) actual handling of pyrotechnics, real or simulated, where applicable;
 - (F) demonstration in the use of the life-rafts where fitted. In the case of helicopters involved in extended over water operations, demonstration and use of the life-rafts.

Helicopter water survival training

Where life-rafts are fitted for helicopter extended overwater operations (such as sea pilot transfer, offshore operations, regular, or scheduled, coast-to-coast overwater operations), a comprehensive wet drill to cover all ditching procedures should be practised by aircraft crew. This wet drill should include, as appropriate, practice of the actual donning and inflation of a life-jacket, together with a demonstration or audio-visual presentation of the inflation of life-rafts. Crews should board the same (or similar) life-rafts from the water whilst wearing a life-jacket. Training should include the use of all survival equipment carried on board life-rafts and any additional survival equipment carried separately on board the aircraft;

- consideration should be given to the provision of further specialist training such as underwater escape training. Where operations are predominately conducted offshore, operators should conduct 3-yearly helicopter underwater escape training at an appropriate facility;
- wet practice drill should always be given in initial training unless the crew member concerned has received similar training provided by another operator;

- (G) particularly in the case where no cabin crew is required, first-aid, appropriate to the aircraft type, the kind of operation and crew complement.
 - (iv) The successful resolution of aircraft emergencies requires interaction between flight crew and cabin/technical crew and emphasis should be placed on the importance of effective coordination and two-way communication between all crew members in various emergency situations.
 - (v) Emergency and safety equipment training should include joint practice in aircraft evacuations so that all who are involved are aware of the duties other crew members should perform. When such practice is not possible, combined flight crew and cabin/technical crew training should include joint discussion of emergency scenarios.
 - (vi) Emergency and safety equipment training should, as far as practicable, take place in conjunction with cabin/technical crew undergoing similar training with emphasis on coordinated procedures and two-way communication between the flight crew compartment and the cabin.
- (3) CRM
- Elements of CRM training, as specified in Table 1 of [AMC1 ORO.FC.115](#), should be integrated into all appropriate phases of recurrent training.
- (4) Aircraft/FSTD training
- (i) General
 - (A) The aircraft/FSTD training programme should be established in a way that all major failures of aircraft systems and associated procedures will have been trained in the preceding 3-year period.
 - (B) When engine-out manoeuvres are carried out in an aircraft, the engine failure should be simulated.
 - (C) The recurrent aircraft/FSTD training of a single task or manoeuvre should be separate from, and should not take place at the same time as, an operator proficiency check of the item.
 - (ii) Helicopters
 - (A) If the operator is able to demonstrate, on the basis of a compliance and risk assessment, that alternating the use of an FSTD with the use of an aircraft for this training provides equivalent standards of training with safety levels similar to those achieved using an FSTD, the aircraft may be used (alternating with the use of an FSTD) for this training to the extent necessary.
 - (B) Where a suitable FSTD is available and accessible, it should be used to complete the following additional items:
 - settling with power and vortex ring;
 - loss of tail rotor effectiveness.
- (5) For operations with other-than-complex motor-powered aeroplanes, all training and checking should be relevant to the type of operation and class of aeroplane on which the flight crew member operates with due account taken of any specialised equipment used.

(b) Recurrent checking

Recurrent checking should comprise the following:

(1) Operator proficiency checks

(i) Aeroplanes

Operator proficiency checks should take place as part of the normal crew complement and should include, where applicable, the following manoeuvres as pilot flying:

- (A) rejected take-off when an FSTD is available to represent that specific aeroplane, otherwise touch drills only;
- (B) take-off with engine failure between V1 and V2 (take-off safety speed) or, if carried out in an aeroplane, at a safe speed above V2;
- (C) 3D approach operation to minima with, in the case of multi-engined aeroplanes, one-engine-inoperative;
- (D) 2D approach operation to minima;
- (E) at least one of the 3D or 2D approach operations should be an RNP APCH or RNP AR APCH operation;
- (F) missed approach on instruments from minima with, in the case of multi-engined aeroplanes, one-engine-inoperative;
- (G) landing with one-engine-inoperative. For single-engined aeroplanes, a practice forced landing is required.

(ii) Helicopters

- (A) The aircraft/FSTD checking programme should be established in a way that all major failures of aircraft systems and associated procedures will have been checked in the preceding 3-year period.

The operator should define which failures are major for the purpose of the operator proficiency check based on a risk assessment, taking the following into account:

- (a) cautions or warnings associated with the failure;
- (b) the criticality of the situation or failure;
- (c) the outcome of the procedure (land immediately or as soon as possible as opposed to land as soon as practical);
- (d) when available, manufacturer documentation; and
- (e) the list of abnormal/emergency procedures described in [point \(e\)\(1\) of AMC1 ORO.FC.220](#).

In addition, for single-engined helicopters, each operator proficiency check should include at least the following procedures:

- (f) engine failure;
- (g) directional control failures and malfunctions; and
- (h) hydraulic failure as applicable.

- (B) When a group of single-engine turbine or single-engine piston helicopter types is defined for the purpose of extending the validity of the operator proficiency check, all major system failures should nevertheless be checked on every type within a 3-year cycle unless credits related to the training, checking and recent experience requirements are defined in the operational suitability data established in accordance with [Commission Regulation \(EU\) No 748/2012](#) for the relevant types or variants.
- (C) For pilots required to engage in IFR operations, proficiency checks include the following additional normal/abnormal/emergency procedures:
- 3D approach operation to minima;
 - go-around on instruments;
 - 2D approach operation to minima;
 - if relevant, at least one of the 3D or 2D approach operations should be an RNP APCH or RNP AR APCH operation;
 - in the case of multi-engined helicopters, a simulated failure of one engine to be included in either the 3D or 2D approach operation to minima;
 - where appropriate to the helicopter type, approach with flight control system/flight director system malfunctions, flight instrument and navigation equipment failures.
- (D) Before a flight crew member without a valid instrument rating is allowed to operate in VMC at night, they should be required to undergo a proficiency check at night. Thereafter, each second proficiency check should be conducted at night.
- (E) Operator proficiency checks should be conducted with two qualified pilots in multi-pilot operations, and one qualified pilot in single-pilot operations. A pilot flying both single-pilot and multi-pilot operations should be checked in multi-pilot conditions with the essential malfunctions or manoeuvres below being also checked in the single-pilot role:
- (a) at least two abnormal or emergency manoeuvres relevant to the type based on a risk assessment;
 - (b) one instrument approach for IFR operations.
- (F) The flight crew should be assessed on their CRM skills in accordance with the methodology described in [AMC1](#) and [AMC2 ORO.FC.115](#) and as specified in the operations manual.
- (G) If the operator is able to demonstrate, on the basis of a compliance and risk assessment, that alternating the use of an FSTD with the use of an aircraft for this training provides equivalent standards of checking with safety levels similar to those achieved using an FSTD, the aircraft may be used (alternating with the use of an FSTD) for this checking to the extent necessary.
- (iii) The checks prescribed in (b)(1) may be combined with the skill test or proficiency check required for the issue, the revalidation or renewal of the aircraft type rating and with the skill test required for the issue of the ATPL licence.

(2) Emergency and safety equipment checks

The items to be checked should be those for which training has been carried out in accordance with (a)(2).

(3) Line checks

- (i) A line check should establish the ability to perform satisfactorily a complete line operation, including pre-flight and post-flight procedures and use of the equipment provided, as specified in the operations manual. The route chosen should be such as to give adequate representation of the scope of a pilot's normal operations. When weather conditions preclude a manual landing, an automatic landing is acceptable. The commander, or any pilot who may be required to relieve the commander, should also demonstrate their ability to 'manage' the operation and take appropriate command decisions.
- (ii) The flight crew should be assessed on their CRM skills in accordance with the methodology described in [AMC1 ORO.FC.115](#) and as specified in the operations manual.
- (iii) CRM assessment should not be used as a reason for a failure of the line check, unless the observed behaviour could lead to an unacceptable reduction in safety margin.
- (iv) When pilots are assigned duties as pilot flying and pilot monitoring, they should be checked in both functions.
- (v) A line check should be conducted by a commander nominated by the operator. The operator should maintain a list of nominated commanders and inform the competent authority about the persons nominated. The person conducting the line check should occupy an observer's seat where installed.
 - (A) For aeroplanes, in the case of long-haul operations where additional operating flight crew are carried, the person conducting the line check may fulfil the function of a cruise relief pilot and should not occupy either pilot's seat during take-off, departure, initial cruise, descent, approach and landing.
 - (B) If an observer's seat is not installed but a forward-facing passenger seat allows a good view and sound of the cockpit and the crew, this seat should be used as an observer's seat.
 - (C) If an observer's seat is not available and cannot be installed, the commander nominated by the operator should occupy a pilot seat to conduct the line check.
- (vi) CRM assessment during the line check
 - (A) The CRM assessment taking place during the line check should be solely based on observations made during the initial briefing, cabin briefing, flight crew compartment briefing and those phases where the line checker occupies the observer's seat.
 - (B) If an observer's seat is not available and cannot be installed, then the operator should define the best way to assess CRM taking into account the CRM principles above.

(vii) Complementary CRM assessment

If a suitable FSTD is available and accessible for operator proficiency checks or FSTD training, then a CRM assessment should take place in a line-oriented flight scenario (LOFT or line-oriented section of the OPC) of an FSTD session. This assessment complements the CRM assessment taking place during the line check, but is not part of the line check.

(viii) Where a pilot is required to operate as pilot flying and pilot monitoring, they should be checked on one flight sector as pilot flying and on another flight sector as pilot monitoring.

(4) In the case of single-pilot operations, the recurrent checks referred to in (b)(1) and (3) should be performed in the single-pilot role in an environment representative of the operation.

(c) Flight crew incapacitation training, except single-pilot operations

(1) Procedures should be established to train flight crew to recognise and handle flight crew incapacitation. This training should be conducted every year and can form part of other recurrent training. It should take the form of classroom instruction, discussion, audio-visual presentation or other similar means.

(2) If an FSTD is available for the type of aircraft operated, practical training on flight crew incapacitation should be carried out at intervals not exceeding 3 years.

(d) Use of FSTD

(1) Training and checking provide an opportunity to practise abnormal/emergency procedures that rarely arise in normal operations and should be part of a structured programme of recurrent training. This should be carried out in an FSTD when available and accessible.

(2) The line check should be performed in the aircraft. All other training and checking should be performed in an FSTD, or, if it is not reasonably practicable to gain access to such devices, in an aircraft of the same type or in the case of emergency and safety equipment training, in a representative training device. The type of equipment used for training and checking should be representative of the instrumentation, equipment and layout of the aircraft type operated by the flight crew member.

(3) Because of the unacceptable risk when simulating emergencies such as engine failure, icing problems, certain types of engine(s) (e.g. during continued take-off or go-around, total hydraulic failure), or because of environmental considerations associated with some emergencies (e.g. fuel dumping) these emergencies should preferably be covered in an FSTD. If no FSTD is available, these emergencies may be covered in the aircraft using a safe airborne simulation, bearing in mind the effect of any subsequent failure, and the exercise must be preceded by a comprehensive briefing.

[AMC1 ORO.FC.230 applicable from 26 March 2023]

AMC2 ORO.FC.230 Recurrent training and checking

ED Decision 2014/017/R

FLIGHT ENGINEERS

(a) The recurrent training and checking for flight engineers should meet the requirements for pilots and any additional specific duties, omitting those items that do not apply to flight engineers.

- (b) Recurrent training and checking for flight engineers should, whenever possible, take place concurrently with a pilot undergoing recurrent training and checking.
- (c) The line check should be conducted by a commander or by a flight engineer nominated by the operator, in accordance with national rules, if applicable.

AMC3 ORO.FC.230 Recurrent training and checking

ED Decision 2022/014/R

TRAINING PROGRAMMES

The operator should ensure that training programmes include the relevant de-identified feedback from the management system, including occurrence reporting and flight data monitoring programmes.

[applicable from 26 March 2023]

GM1 ORO.FC.230 Recurrent training and checking

ED Decision 2014/017/R

LINE CHECK AND PROFICIENCY TRAINING AND CHECKING

- (a) Line checks, route and aerodrome knowledge and recent experience requirements are intended to ensure the crew member's ability to operate efficiently under normal conditions, whereas other checks and emergency and safety equipment training are primarily intended to prepare the crew member for abnormal/emergency procedures.
- (b) The line check is considered a particularly important factor in the development, maintenance and refinement of high operating standards, and can provide the operator with a valuable indication of the usefulness of his/her training policy and methods. Line checks are a test of a flight crew member's ability to perform a complete line operation, including pre-flight and post-flight procedures and use of the equipment provided, and an opportunity for an overall assessment of his/her ability to perform the duties required as specified in the operations manual. The line check is not intended to determine knowledge on any particular route.

[point (b) applicable until 25 March 2023 — ED Decision 2022/014/R]

- (b) The line check is considered a particularly important factor in the development, maintenance and refinement of high operating standards, and can provide the operator with a valuable indication of the usefulness of its training policy and methods. Line checks are a test of a flight crew member's ability to perform a complete line operation, including pre-flight and post-flight procedures and use of the equipment provided, and an opportunity for an overall assessment of their ability to perform the duties required as specified in the operations manual. The line check is not intended to determine knowledge on any particular route.

[point (b) applicable from 26 March 2023 — ED Decision 2022/014/R]

- (c) Proficiency training and checking

When an FSTD is used, the opportunity should be taken, where possible, to use LOFT.

MAJOR FAILURES — HELICOPTERS

- (d) The list of major failures as defined by the operator in [AMC1 ORO.FC.230](#) for the purpose of training may be more extensive than the list covered in the 3-yearly operator proficiency checking programme for the following reasons:
 - (1) It may happen that several training elements are covered by a single check; and

- (2) Certain complex system malfunctions are best explored under recurrent training, where the trainee will derive more benefit and training to proficiency is also employed.

[point (d) applicable from 26 March 2023 — ED Decision 2022/014/R]

GM1 ORO.FC.230(a);(b);(f) Recurrent training and checking

ED Decision 2021/002/R

MIXED EVIDENCE-BASED RECURRENT TRAINING AND CHECKING OF FLIGHT CREW CONDUCTED IN FLIGHT SIMULATION TRAINING DEVICES (FSTDs)

ICAO has developed Doc 9995 'Manual of Evidence-based Training', followed by the EASA EBT manual, which is intended to provide guidance to the competent authorities, operators and approved training organisations on the recurrent assessment and training of pilots by establishing a new methodology for the development and conduct of a recurrent assessment and training programme, titled evidence-based training (EBT).

ICAO Doc 9995 and the EASA EBT manual are the reference documents for operators seeking to implement mixed EBT. The purpose of this guidance material (GM) is to enable the implementation of mixed EBT according to the principles established in ICAO Doc 9995 and the EASA EBT manual in the context of the European regulatory framework.

In the current regulatory framework, it is possible to achieve mixed EBT implementation. Implementation of a mixed EBT programme means that some portion of the recurrent assessment and training is dedicated to the application of EBT. This includes the licence proficiency check (LPC) and the operator proficiency check (OPC).

As it is possible to combine LPC and OPC in ORO.FC, this GM is applicable to both checks. Therefore, the EBT programme described in this GM refers to the recurrent training and checking of flight crew, including LPCs and OPCs.

The EBT programme takes into account the differences between aircraft of different generations and the effect of these differences on training. The operator should acquire a thorough knowledge of ICAO Doc 9995 or the EASA EBT manual before implementing this GM. For applicability, see ICAO Doc 9995 or the EASA tables of applicable aeroplane/helicopter types by generation.

Mixed EBT programme

The operator may undertake implementation of the mixed EBT programme according to this GM. The ICAO table of assessment and training topics is defined in ICAO Doc 9995 Chapter 4.3.1 and in Appendices 2 to 7; the EASA EBT programme is defined in [AMC2 to AMC7 to ORO.FC.232](#).

The mixed EBT programme provides operators with the flexibility to adapt programmes according to their specific risks.

The operator should contact the competent authority in order for them to assess the application of the process described in ICAO Doc 9995 or the EBT manual.

Personnel providing training and checking in EBT (Refers to [AMC1 ORO.FC.230\(d\)](#))

ICAO Doc 9995 Chapter 6, or EASA [AMC1](#) and [AMC2 to ORO.FC.146\(c\)](#), contain(s) the guidance for the assessment and training of personnel involved in the conduct of EBT.

Equivalency of malfunctions (Refers to ICAO Doc 9995 Paragraph 3.8.3)

According to the concept of EASA and ICAO Doc 9995 Chapter 3.8.3, major failures reduce the capability of the aircraft or the ability of the crew to cope with operating conditions to the extent that

there would be a significant reduction in functional capabilities, significant increase in crew workload or in conditions impairing crew efficiency.

Clusters of major failures of aircraft systems are determined by reference to malfunction characteristics and the underlying elements of crew performance required to manage them. Equivalency of malfunctions may be used to guide the operator towards the implementation of a mixed EBT programme according to [AMC1 ORO.FC.230\(a\)\(4\)\(i\)\(A\)](#) and [ORO.FC.145\(d\)](#).

Conduct of licence and operator proficiency checks

The EASA EBT programme described in [ORO.FC.231](#) and the ICAO EBT programme described in ICAO Doc 9995 contains modules with three phases: the EVAL, the MT, and the SBT. In order to comply with the regulatory framework, in the mixed EBT programme the LPC and OPC requirements are fulfilled by a combination of the EVAL and the manoeuvres validation phase, which replaces the MT described in the EASA EBT programme or ICAO Doc 9995. The manoeuvres validation phase is defined in Section 2 below. This is a form of mixed EBT implementation, which is described as follows:

1. **Evaluation phase:** This includes check scenarios referred to in Part-FCL Appendix 9 within an approved mixed EBT programme.

In order to facilitate the provision of simple and realistic scenarios in accordance with ICAO Doc 9995 Chapters 3.8 and 7.4, the EVAL is not intended to be a comprehensive assessment of all Part-FCL Appendix 9 items; nevertheless, the list below includes the items that should be included in the EVAL only.

		Part-FCL or Part-ORO reference	Description
A E R O P L A N E S	H E L I C O P T E R S	Part-FCL Appendix 9 Paragraph 6	The examiner may choose between different skill test or proficiency check scenarios containing simulated relevant operations developed and approved by the competent authority. Full-flight simulators and other training devices, when available, shall be used, as established in this Part.
		Part-FCL Appendix 9 Paragraph 16 of section B	The test or check should be accomplished under instrument flight rules (IFRs), if instrument rating (IR) is included, and as far as possible be accomplished in a simulated commercial air transport environment. An essential element to be checked is the ability to plan and conduct the flight from routine briefing material.
		Part-FCL Appendix 9 Item 1.4	Use of checklist prior to starting engines, starting procedures, radio and navigation equipment check, selection and setting of navigation and communication frequencies.
		Part-FCL Appendix 9 Item 1.6	Before take-off checks.
		Part-FCL Appendix 9 Item 3.8.1*	Adherence to departure and arrival routes and ATC instructions. The starred item (*) shall be flown solely by reference to instruments. If this condition is not met during the skill

		test or proficiency check, the type rating will be restricted to VFR only.
H E L I C O P T E R S	Part-FCL Appendix 9 Paragraph 2 of section C	In case of proficiency check for an IR, the applicant shall pass section 5 of the proficiency check. Failure in more than three items will require the applicant to take the entire section 5 again. An applicant failing not more than three items shall take the failed items again. Failure in any item of the re-check or failure in any other items of section 5 already passed will require the applicant to take the entire check again.
	Part-FCL Appendix 9 Item 1.3.	Starting procedures, radio and navigation equipment check, selection and setting of navigation and communication frequencies
	Part-FCL Appendix 9 Item 1.4	Taxiing/air taxiing in compliance with air traffic control instructions or with instructions of an instructor
	Part-FCL Appendix 9 Item 1.5	Pre-take-off procedures and checks
	Part-FCL Appendix 9 Item 5.2*	Adherence to departure and arrival routes and ATC instructions The starred item (*) shall be flown solely by reference to instruments. If this condition is not met during the skill test or proficiency check, the type rating will be restricted to VFR only.

2. **Manoeuvres validation phase:** The purpose of the manoeuvres validation phase is to check the handling skills necessary to fly critical flight manoeuvres so that they are maintained to a defined level of proficiency. This replaces the MT described in ICAO Doc 9995 Chapter 7.5 and [ORO.FC.231\(a\)\(2\)\(iv\)\(B\)\(a\)](#). Manoeuvres in this context are not part of the line-orientated flight scenario; they are a sequence of deliberate actions to achieve a prescribed flight path or to perform a prescribed event to a prescribed outcome. All remaining items listed in Part-FCL Appendix 9, and not included in the EVAL, should be included here. The manoeuvres listed in Doc 9995 or the EASA table of assessment and training topics for the MT that do not form part of the Part-FCL Appendix 9 mandatory items may be trained after the manoeuvres validation phase.
3. **Scenario-based training phase:** The purpose of the SBT is to further develop pilot core competencies in a learning environment. This does not form part of any LPC or OPC requirement.

It should be noted that if the operator is following an alternative means of compliance to [ORO.FC.230\(b\)](#) Operator proficiency check, the equivalence of using EBT evaluation and manoeuvres validation phases may no longer exist.

Conduct of CRM assessment

The operator is advised to use the EBT grading system ([AMC1 ORO.FC.231\(d\)\(1\)](#)) and the EBT competencies ([AMC1 ORO.FC.231\(b\)](#)) for the non-technical skills assessment.

Additional guidance on mixed EBT implementation is available in the EASA checklist '[Oversight guidance for transition to Mixed EBT Implementation](#)'.

ORO.FC.231 Evidence-based training

Regulation (EU) 2020/2036

(a) EBT PROGRAMME

- (1) The operator may substitute the requirements of [ORO.FC.230](#) by establishing, implementing and maintaining a suitable EBT programme approved by the competent authority.

The operator shall demonstrate its capability to support the implementation of the EBT programme (including an implementation plan) and perform a safety risk assessment demonstrating how an equivalent level of safety is achieved.

- (2) The EBT programme shall:

- (i) correspond to the size of the operator, and the nature and complexity of its activities, taking into account the hazards and associated risks inherent in those activities;
- (ii) ensure pilot competence by assessing and developing pilot competencies required for a safe, effective and efficient operation of aircraft;
- (iii) ensure that each pilot is exposed to the assessment and training topics derived in accordance with [ORO.FC.232](#);
- (iv) include at least six EBT modules distributed across a 3-year programme; each EBT module shall consist of an evaluation phase and a training phase. The validity period of a EBT module shall be 12 months;
 - (A) The evaluation phase comprises a line-orientated flight scenario (or scenarios) to assess all competencies and identify individual training needs.
 - (B) The training phase comprises:
 - (a) the manoeuvres training phase, comprising training to proficiency in certain defined manoeuvres;
 - (b) the scenario-based training phase, comprising a line-orientated flight scenario (or scenarios) to develop competencies and address individual training needs.

The training phase shall be conducted in a timely manner after the evaluation phase.

- (3) The operator shall ensure that each pilot enrolled in the EBT programme completes:
- (i) a minimum of two EBT modules within the validity period of the type rating, separated by a period of not less than 3 months. The EBT module is completed when:
 - (A) the content of the EBT programme is completed for that EBT module (exposure of the pilot to the assessment and training topics); and
 - (B) an acceptable level of performance in all observed competencies has been demonstrated;
 - (ii) line evaluation(s) of competence; and
 - (iii) ground training.

-
- (4) The operator shall establish an EBT instructor standardisation and concordance assurance programme to ensure that the instructors involved in EBT are properly qualified to perform their tasks.
- (i) All instructors must be subject to this programme;
 - (ii) The operator shall use appropriate methods and metrics to assess concordance;
 - (iii) The operator shall demonstrate that the instructors have sufficient concordance.
- (5) The EBT programme may include contingency procedures for unforeseen circumstances that could affect the delivery of the EBT modules. The operator shall demonstrate the need for those procedures. The procedures shall ensure that a pilot does not continue line operations if the performance observed was below the minimum acceptable level. They may include:
- (i) a different separation period between EBT modules; and
 - (ii) different order of the phases of the EBT module.
- (b) **COMPETENCY FRAMEWORK**
- The operator shall use a competency framework for all aspects of assessment and training within an EBT programme. The competency framework shall:
- (1) be comprehensive, accurate, and usable;
 - (2) include observable behaviours required for safe, effective and efficient operations;
 - (3) include a defined set of competencies, their descriptions and their associated observable behaviours.
- (c) **TRAINING SYSTEM PERFORMANCE**
- (1) The EBT system performance shall be measured and evaluated through a feedback process in order to:
 - (i) validate and refine the operator's EBT programme;
 - (ii) ascertain that the operator's EBT programme develops pilot competencies.
 - (2) The feedback process shall be included in the operator's management system.
 - (3) The operator shall develop procedures governing the protection of EBT data.
- (d) **GRADING SYSTEM**
- (1) The operator shall use a grading system to assess the pilot competencies. The grading system shall ensure:
 - (i) a sufficient level of detail to enable accurate and useful measurements of individual performance;
 - (ii) a performance criterion and a scale for each competency, with a point on the scale which determines the minimum acceptable level to be achieved for the conduct of line operations. The operator shall develop procedures to address low performance of the pilot;
 - (iii) data integrity;
 - (iv) data security.

-
- (2) The operator shall verify at regular intervals the accuracy of the grading system against a criterion-referenced system.
- (e) **SUITABLE TRAINING DEVICES AND VOLUME OF HOURS TO COMPLETE THE OPERATOR'S EBT PROGRAMME**
- (1) Each EBT module shall be conducted in an FSTD with a qualification level adequate to ensure the correct delivery of the assessment and training topics.
- (2) The operator shall provide a sufficient volume of hours in the suitable training device for the pilot to complete the operator's EBT programme. The criteria to determine the volume of the EBT programme are as follows:
- (i) The volume corresponds to the size and complexity of the EBT programme;
- (ii) The volume is sufficient to complete the EBT programme;
- (iii) The volume ensures an effective EBT programme taking into account the recommendations provided by ICAO, the Agency, and the competent authority;
- (iv) The volume corresponds to the technology of the training devices used.
- (f) **EQUIVALENCY OF MALFUNCTIONS**
- (1) Each pilot shall receive assessment and training in the management of aircraft system malfunctions.
- (2) Aircraft system malfunctions that place a significant demand on a proficient crew shall be organised by reference to the following characteristics:
- (i) immediacy;
- (ii) complexity;
- (iii) degradation of aircraft control;
- (iv) loss of instrumentation;
- (v) management of consequences.
- (3) Each pilot shall be exposed to at least one malfunction for each characteristic at the frequency determined by the table of assessment and training topics.
- (4) Demonstrated proficiency in the management of one malfunction is considered equivalent to demonstrated proficiency in the management of other malfunctions with the same characteristics.
- (g) **EQUIVALENCY OF APPROACHES RELEVANT TO OPERATIONS**
- (1) The operator shall ensure that each pilot receives regular training in the conduct of approach types and approach methods relevant to operations.
- (2) This training shall include approaches that place an additional demand on a proficient crew.
- (3) This training shall include the approaches that require specific approval in accordance with Annex V (Part-SPA) to this Regulation.
- (h) **LINE EVALUATION OF COMPETENCE**
- (1) Each pilot shall periodically undertake a line evaluation of competence in an aircraft to demonstrate the safe, effective and efficient conduct of normal line operations described in the operations manual.

- (2) The validity period of a line evaluation of competence shall be 12 months.
 - (3) The operator approved for EBT may, with the approval of the competent authority, extend the validity of the line evaluation of competence to:
 - (i) either 2 years, subject to a risk assessment;
 - (ii) or 3 years, subject to a feedback process for the monitoring of line operations which identifies threats to the operations, minimises the risks of such threats, and implements measures to manage human error in the operations.
 - (4) For successful completion of the line evaluation of competence, the pilot shall demonstrate an acceptable level of performance in all observed competencies.
- (i) **GROUND TRAINING**
- (1) Every 12 calendar months, each pilot shall undergo:
 - (i) technical ground training;
 - (ii) assessment and training on the location and use of all emergency and safety equipment carried on the aircraft.
 - (2) The operator may, with the approval of the competent authority and subject to a risk assessment, extend the period of assessment and training on the location and use of all emergency and safety equipment carried on the aircraft to 24 months.

AMC1 ORO.FC.231(a) Evidence-based training

ED Decision 2021/002/R

EBT PROGRAMME SUITABILITY

An operator's EBT programme is one in which:

- (a) training is focused on development of competencies, rather than repetition of tasks;
- (b) the development of the programme is based on data-driven EBT training topics with a link to the operator's competency framework;
- (c) training needs are addressed through training based on underlying competencies;
- (d) the programme includes:
 - (1) an evaluation phase to identify training needs based on competencies and collect population-based data; to identify the training needs means, the root cause of the deficiency observed should be identified rather than the symptoms of the deficiency;
 - (2) a manoeuvres training phase (skill retention): to train skill-based manoeuvres (body memory actions). These manoeuvres should place a significant demand on a proficient pilot; and
 - (3) a scenario-based training phase to focus on identified training needs based on competencies rather than repetition of tasks;
- (e) the programme includes the conduct of objective observations based on a competency framework, and documents evidence of the behaviour observed;
- (f) there is a customisation of syllabi:
 - (1) The operator should describe in the operations manual the procedure to customise syllabi. It should include how to:

- (i) select the example scenario elements within a training topic that should be included in the EBT programme; and
 - (ii) contextualise the example scenario elements based on the operator's operational data (e.g. input from SMS, FDM programme, etc.) and training data.
- (2) This customisation should be based on evidence both internal and external to the operator;
- (g) performance is evaluated using a competency-based grading system;
 - (h) instructors grade competencies based on observable behaviours (OBs);
 - (i) instructors grade the pilot using a defined methodology — observe, record, classify and assess/evaluate (ORCA) is recommended;
 - (j) instructors have completed the EBT instructor standardisation;
 - (k) instructors have sufficient concordance based on defined criteria (instructor concordance assurance programme);
 - (l) the analysis of the pilot's performance is used to determine competency-based training needs;
 - (m) there is a range of teaching styles during simulator training to accommodate trainee learning needs; and
 - (n) facilitation techniques in debriefing are incorporated.

AMC2 ORO.FC.231(a) Evidence-based training

ED Decision 2021/002/R

UPSET PREVENTION AND RECOVERY TRAINING (UPRT) FOR COMPLEX MOTOR-POWERED AEROPLANES WITH A MAXIMUM OPERATIONAL PASSENGER SEATING CONFIGURATION (MOPSC) OF MORE THAN 19

Operators approved for EBT should follow the provisions for upset prevention and recovery training (UPRT) contained in [AMC1 ORO.FC.220&230](#) 'Operator conversion training and checking & recurrent training and checking'. These provisions should be included in the tables of assessment and training topics detailed in [ORO.FC.232](#).

AMC3 ORO.FC.231(a) Evidence-based training

ED Decision 2021/002/R

PERSONNEL CONDUCTING ASSESSMENT AND PROVIDING TRAINING

- (a) Ground and refresher training should be provided by suitably qualified personnel.
- (b) For non-EBT assessment and training: flight training should be provided by a flight instructor (FI), type rating instructor (TRI) or class rating instructor (CRI) or, in the case of the FSTD content, a synthetic flight instructor (SFI). The FI, TRI, CRI or SFI should satisfy the operator's standardisation, experience and knowledge requirements.
- (c) Emergency and safety equipment training should be provided by suitably qualified personnel.
- (d) CRM training should be provided by an EBT instructor or, for the classroom CRM training, a CRM trainer.
- (e) Additional personnel requirements are described in [ORO.FC.146](#) and [ORO.FC.231](#) and in the associated AMC and GM.

GM1 ORO.FC.231(a) Evidence-based training

ED Decision 2021/002/R

RECURRENT CREW RESOURCE MANAGEMENT (CRM)

Operators implementing EBT in accordance with [ORO.FC.231](#) may demonstrate compliance with [ORO.FC.115](#) by showing how the recurrent CRM requirements are integrated within the operator's EBT programme. An example of how this may be done is provided in the safety promotion material of EASA (e.g. 'EASA EBT manual').

GM2 ORO.FC.231(a) Evidence-based training

ED Decision 2021/002/R

EBT PROGRAMME — TRANSITION FROM MIXED EBT

The operator may agree with the competent authority the transition measures from mixed EBT to EBT baseline, which may include amongst others that the 3-year programme may include one or more modules in mixed EBT and one or more modules in EBT baseline, provided that all assessment and training topics in [ORO.FC.232](#) are completed in the 3-year programme.

GM3 ORO.FC.231(a) Evidence-based training

ED Decision 2022/014/R

CUSTOMISATION OF THE EBT PROGRAMME (SYLLABI)

- (a) Syllabi can be customised at three different steps:
- (1) The first step would be a syllabus for the whole pilots' population (customisation only at type rating level and/or aircraft generation level). At this step, the operator customises the example scenario elements based on relevant operational data (safety management system, state safety plan, OSD, occurrences, manufacturer data, etc.), and the training topics within the module are the same (same syllabus). At this level, it may be necessary to have a different example scenario element for the different crews within the same module to ensure that pilots are exposed to surprise and unexpected events and thus avoid pilots knowing all the details of the simulator session beforehand.
 - (2) The second step would be a different syllabus or part of it for the different populations of pilots. For example, some parts of the syllabus are different for the co-pilot and the captain, or the syllabus is different for the B747 pilots or for the Airbus pilots, etc. At this step, the module or part of the module is different for each population; this may include a different example scenario element for each population (or a different training topic; however, the customisation at training topic level is more difficult to control).
 - (3) The third step would be syllabi tailored to the individual pilot (pilot customisation — individual syllabus). This step is linked to the procedures established for the tailored training and the additional training of the pilots following the VENN model.
- (b) The procedure to describe the customisation of syllabi must be described in the OM. Customisation is based on evidence that can be gathered on three different levels, two from the inner loop, one from the outer loop.
- (1) Inner loop
 - (i) Individual evidence based on training data (e.g. grading metrics, training reports, questionnaires, etc.), analysed either for an individual pilot or a group of pilots (for example, all co-pilots, all B747 pilots, all pilots flying an Airbus model, etc.).

- (ii) Operator-specific evidence gathered through the safety management process in accordance with [ORO.GEN.200](#).
- (2) Outer loop
Evidence gathered from external sources such as authorities (e.g. state safety plan, etc.), OEMs (e.g. OEBs, OSD, safety documentation such as getting to grip, etc.

GM4 ORO.FC.231(a) Evidence-based training

ED Decision 2021/002/R

EBT PROGRAMME

Further guidance on the EBT programme can be found in the EASA EBT manual.

AMC1 ORO.FC.231(a)(1) Evidence-based training

ED Decision 2021/002/R

EXPERIENCE IN MIXED EBT TO SUBSTITUTE [ORO.FC.230](#)

- (a) The operator should have a minimum experience of 3 years of a mixed EBT programme. Note: More information on a mixed EBT programme is provided in [GM1 ORO.FC.230\(a\);\(b\);\(f\)](#) and in [GM2 ORO.FC.A.245](#).
- (b) The operator should demonstrate 2 years of an instructor concordance assurance programme.
- (c) The operator should demonstrate 1 year of a valid equivalency of malfunctions.
- (d) The operator should demonstrate 1 year of integration of the training data in the customisation of the EBT programme and SMS data for the contextualisation of the example scenario elements.
- (e) The operator should demonstrate that there is a verification of the grading system and feedback is provided to the training system performance and to the instructor standardisation concordance assurance.

SUBSTITUTION OF THE REQUIREMENTS OF [ORO.FC.230](#)

- (f) One complete EBT module substitutes one operator proficiency check (OPC).
- (g) The line evaluation of competence substitutes the line check.

AMC1 ORO.FC.231(a)(2) Evidence-based training

ED Decision 2021/002/R

EBT PROGRAMME AND ASSESMENT AND TRAINING TOPICS — RESILIENCE

- (a) Compliance with the table of assessment and training topics ensures that crews are presented with an array of realistic changing events that allow for resilience development purposes.
- (b) The EBT programme should be designed observing the following principles for resilience development:
 - (1) Resilience, surprise, and unexpected events
The EBT programme should be designed in such a way that in every cycle the simulator session (or part of it) allows variations so that the pilots are not familiar with the scenarios presented in the simulator session. Variations should be the focus of EBT programme

design, and should not be left to the discretion of individual instructors, in order to preserve programme integrity and fairness.

(2) Resilience and decision-making (dilemma)

The EBT programme should be designed in such a way that in every cycle the crews are exposed to a scenario where more than one possible and less than ideal solutions exist, with some unfavourable conditions attached to each solution.

AMC2 ORO.FC.231(a)(2) Evidence-based training

ED Decision 2021/002/R

VALIDITY OF THE EBT MODULE

- (a) The validity period should be counted from the end of the month when the module was completed. When the module is undertaken within the last 3 months of the validity period, the new validity period should be counted from the original expiry date.
- (b) In the context of [ORO.FC.130](#) point (a), the pilot should have a valid module.

GM1 ORO.FC.231(a)(2) Evidence-based training

ED Decision 2021/002/R

EBT PROGRAMME AND ASSESMENT AND TRAINING TOPICS — RESILIENCE

- (a) For resilience development, crews should be exposed to an array of realistic changing scenarios. The strategies developed by the crews whilst coping with different causes of action will create opportunities for resilience development.
- (b) Resilience and surprise

The operator may create a comprehensive list of scenarios to ensure that each crew is trained in different scenarios avoiding the same scenarios for all crews. This relates to training topic 'surprise' and to the customisation of the EBT programme.
- (c) Resilience and unexpected events

Exposing crews to rare, fortuitous, events may prepare crews to deal with other unexpected events. For instance, the table of assessment and training topics offers infrequent example scenario elements such as flying over 'no fly zone', etc. The operator may also take infrequent examples from occurrence reporting, or SMS, or manufacturer reports, etc. This relates to decision-making (PSD) — see OB 6.9 'Demonstrates resilience when encountering an unexpected event'.
- (d) Dilemma

The operator may create scenarios suitable for training of threat assessment, threat management processes and option generation, leading to an optimum decision-making process. At programme design, as in real life, one 'correct answer' should be avoided; instead, the EBT programme should offer the crews a number of less than ideal courses of actions; some with unfavourable conditions attached. This relates to decision-making (PSD) and to the contextualisation of the example scenario element.

GM2 ORO.FC.231(a)(2) Evidence-based training

ED Decision 2021/002/R

EBT PROGRAMME — TRAINING PHASE — IN-SEAT INSTRUCTION (ISI)

- (a) Effective monitoring and error detection are increasingly important when operating highly reliable automated aircraft.
- (b) In-seat instruction may be used as a valuable tool to maintain and develop the training objectives of some of the training topics, such as skills of monitoring, cross-checking, error management, and recognition of mismanaged aircraft state.

GM3 ORO.FC.231(a)(2) Evidence-based training

ED Decision 2022/014/R

EBT PROGRAMME — ORDER OF THE PHASES

The order of the phases is intended as follows:

- (a) First, the EVAL; and
- (b) Second, and in a timely manner after the EVAL, the training phases. The training phases are the MT and the SBT and may be delivered in any order.

Further guidance can be found in the EASA EBT manual.

AMC1 ORO.FC.231(a)(3) Evidence-based training

ED Decision 2021/002/R

EBT PROGRAMME — ENROLMENT

- (a) Enrolment is when a flight crew member commences the first EBT module.
- (b) A flight crew member is considered to leave the operator's EBT programme (de-enrolled) when the operator is no longer responsible for the administrative action for the flight crew's licence revalidation under an EBT programme.
- (c) The operator should inform the flight crew members who fail to demonstrate an acceptable level of competence and leave the operator's EBT programme (de-enrolled) that they should not exercise the privileges of that type rating.

GM1 ORO.FC.231(a)(3) Evidence-based training

ED Decision 2021/002/R

MODULE SEPARATION BY A PERIOD OF NOT LESS THAN 3 MONTHS

- (a) The separation begins when the first module finished (end of the training phase) and the second module begins (EVAL).
- (b) When the operator decides to do more than two modules during the validity period of the type rating (approximately 1 year), the operator may count the 3 months of separation between the first and the third module if it so wishes.
- (c) The separation of 3 months applies even between modules in different validity periods.

AMC1 ORO.FC.231(a)(4) Evidence-based training

ED Decision 2021/002/R

INSTRUCTOR CONCORDANCE ASSURANCE PROGRAMME (ICAP)

- (a) The ICAP should be able to identify areas of weak concordance to drive improvement in the quality and validity of the grading system.
- (b) The ICAP should be adapted to the size and complexity of the instructors' group and the complexity of the operator's EBT programme.
- (c) Complex operators should include an ICAP-specific data analysis, demonstrating:
 - (1) instructor-group assessment homogeneity (agreement);
 - (2) instructor assessment accuracy (alignment).
- (d) The operator should verify the concordance of the instructors:
 - (1) once every cycle;
 - (2) for a sufficient number of competency-grade combinations.
- (e) The operator should establish procedures to address those instructors who do not meet the standards required.
- (f) The operator should maintain a list with the EBT instructors qualified to deliver the EBT programme.

GM1 ORO.FC.231(a)(4) Evidence-based training

ED Decision 2021/002/R

INSTRUCTOR CONCORDANCE ASSURANCE PROGRAMME (ICAP)

- (a) Instructor concordance is a tool for continuous improvement of the EBT programme as data reliability results in a more accurate and effective training.
- (b) The operator may have a more frequent, or even a continuous, assessment of concordance as it provides more opportunities to improve.
- (c) Concordance standards are normally set by the operator; however, the competent authority may recommend criteria, as licences' revalidation is performed under EBT.
- (d) Individual instructor concordance may be verified:
 - (1) through uniform standardisation material where at least three different levels of performance are included and for all the competencies at a frequency of 72 months;
 - (2) by reference to the analysis of the data produced by the instructor every 12 months; normalisation may be necessary as there is no homogeneity of all EBT modules and the pilots that the instructor assessed; and
- (e) Instructor-group assessment homogeneity (agreement) may be inferred from instructors who have observed the same content.
- (f) Instructor assessment accuracy (alignment) may be inferred from comparing instructor assessments with an 'assessment standard' consisting of correctly identified competency(-ies) and correctly identified grade levels. Neither the competency(-ies) nor the grade level(s) may be communicated in advance to the instructors. The assessment standards may be set by consensus of a standards group, in order to guard against individual biases.

- (g) When the operator uses a small group of instructors (e.g. 10), the data-driven concordance assurance programme may be directly integrated into the annual refresher training, removing the need for the above guidance.
- (h) Operators with a complex group of instructors (e.g. a big rotation of instructors, subcontracted instructors, big number of instructors, many different fleets, etc.) may need to implement a more extensive concordance assessment system.

AMC1 ORO.FC.231(a)(5) Evidence-based training

ED Decision 2021/002/R

CONTINGENCY PROCEDURES FOR UNFORESEEN CIRCUMSTANCES THAT MAY AFFECT THE DELIVERY OF THE MODULE

- (a) The operator should detail in the EBT programme the contingency procedures in the event of unforeseen circumstances that may affect the delivery of the module (e.g. long-term sick pilot).
- (b) In case of unforeseen interruption of a module at any point, the missing parts of the module should be rescheduled.
 - (1) The pilot may continue line flying until the expiry of the validity period unless the performance observed was below the minimum acceptable level.
 - (2) If the interruption results in an instructor change, the operator should ensure that the instructor completing the module is provided with the details of the performance of the pilots.
- (c) In case the pilot misses modules and does not meet the requirements of recent experience (FCL.060):
 - (1) when the pilot misses one module out of the two modules required, the EVAL of the missing module should be rescheduled before the pilot can resume line operations. The MT and SBT phases of the missing module should be completed 30 days after the EVAL or before the expiry date, whichever occurs first;
 - (2) when the pilot misses one module in the preceding 12 months but the pilot's rating is expired by less than 3 months, the missing module should be rescheduled before the pilot can resume line operations;
 - (3) when the pilot misses one module in the preceding 12 months but the pilot's rating is expired by longer than 3 months but shorter than 1 year, the missing module should be rescheduled. The evaluation should be delivered by an EBT instructor (or instructors) with examiner privileges before the pilot can resume line operations;
 - (4) when the pilot misses two modules and the pilot's rating is valid:
 - (i) one module should be rescheduled before the pilot can resume line operations using an EBT instructor (or instructors) with examiner privileges; and
 - (ii) training topics B and C of the other module should be rescheduled before the expiry date.In such case, the 3-month separation requirement between modules may not apply;
 - (5) when the pilot misses two modules and the pilot's rating is expired by less than 1 year:
 - (i) one module should be rescheduled using an EBT instructor (or instructors) with examiner privileges; and

- (ii) training topics B and C of the other module should be rescheduled before the pilot can resume line operations.

In such case, the period of 3-month separation between modules may not apply; and

- (6) if the amount of time elapsed since the expiry of the rating is more than 1 year, the pilot is de-enrolled. AMC1 FCL.625(c) 'IR — Validity, revalidation and renewal' and AMC1 FCL.740(b)'Validity and renewal of class and type ratings' apply.
- (d) In the case of other situations not covered by points (b) or (c), point (a) applies.

GM1 ORO.FC.231(a)(5) Evidence-based training

ED Decision 2022/014/R

CONTINGENCY PROCEDURES — RATINGS RENEWAL

- (a) The renewal of ratings (e.g. type rating or instrument rating) in EBT follows the Annex I (Part-FCL) to the Aircrew Regulation provisions (IRs and AMC) and is complemented with the provisions covered in [AMC1 ORO.FC.231\(a\)\(5\)](#). The ATO or the operator will determine the amount of training following Part-FCL; however, as EBT combines assessment and training, the following guidance is applicable:
 - (1) Expiry shorter than 3 months may not require additional training in Part-FCL. In EBT, the missing module is rescheduled with an EBT instructor. Following that, the EBT manager for the type rating may renew the licence without extra training, as the EBT programme is now completed (at least two modules in the last 12 months).
 - (2) In Part-FCL, when the expiry is longer than 3 months but shorter than 1 year, there need to be two training sessions. In EBT, there are two cases:
 - (i) One module is missing: the pilot must complete the missing module (two simulator sessions) before resuming line operations. Following that, the EBT manager for the type rating may renew the licence in accordance with Appendix 10 as the EBT programme is now completed (two modules in the last 12 months).
 - (ii) Two modules are missing: the pilot must complete one module (two simulator sessions) and training topics B and C of the other missing module (an extra simulator session) with a total of three simulator sessions. Training data is gathered in a short time period; therefore, an EBT instructor with examiner privilege is involved to ensure the proficiency of the pilot.
- (b) In case of an expiry longer than 1 year, the requirements of Part-FCL will be followed and the proficiency checks will be performed in accordance with Appendix 9 as the EBT system may not have sufficient training data for the pilot.

Expiry longer than 1 year but shorter than 3 years: a minimum of three training sessions in which the most important malfunctions in the available system are covered plus a proficiency check in accordance with Appendix 9 to renew the licence.

AMC1 ORO.FC.231(b) Evidence-based training

ED Decision 2021/002/R

RECOMMENDED EBT COMPETENCIES (EASA COMPETENCY FRAMEWORK)

(a) The operator should include in its EBT programme at least the following competencies:

Application of knowledge (KNO)	
Description:	Demonstrates knowledge and understanding of relevant information, operating instructions, aircraft systems and the operating environment
OB 0.1	Demonstrates practical and applicable knowledge of limitations and systems and their interaction
OB 0.2	Demonstrates the required knowledge of published operating instructions
OB 0.3	Demonstrates knowledge of the physical environment, the air traffic environment and the operational infrastructure (including air traffic routings, weather, airports)
OB 0.4	Demonstrates appropriate knowledge of applicable legislation.
OB 0.5	Knows where to source required information
OB 0.6	Demonstrates a positive interest in acquiring knowledge
OB 0.7	Is able to apply knowledge effectively

Application of procedures and compliance with regulations (PRO)	
Description:	Identifies and applies appropriate procedures in accordance with published operating instructions and applicable regulations
OB 1.1	Identifies where to find procedures and regulations
OB 1.2	Applies relevant operating instructions, procedures and techniques in a timely manner
OB 1.3	Follows SOPs unless a higher degree of safety dictates an appropriate deviation
OB 1.4	Operates aircraft systems and associated equipment correctly
OB 1.5	Monitors aircraft systems status
OB 1.6	Complies with applicable regulations
OB 1.7	Applies relevant procedural knowledge

Communication (COM)	
Description:	Communicates through appropriate means in the operational environment, in both normal and non-normal situations
OB 2.1	Determines that the recipient is ready and able to receive information
OB 2.2	Selects appropriately what, when, how and with whom to communicate
OB 2.3	Conveys messages clearly, accurately and concisely
OB 2.4	Confirms that the recipient demonstrates understanding of important information
OB 2.5	Listens actively and demonstrates understanding when receiving information
OB 2.6	Asks relevant and effective questions
OB 2.7	Uses appropriate escalation in communication to resolve identified deviations
OB 2.8	Uses and interprets non-verbal communication in a manner appropriate to the organisational and social culture
OB 2.9	Adheres to standard radiotelephone phraseology and procedures
OB 2.10	Accurately reads, interprets, constructs and responds to datalink messages in English

Aeroplane flight path management — automation (FPA)	
Description:	Controls the flight path through automation
OB 3.1	Uses appropriate flight management, guidance systems and automation, as installed and applicable to the conditions
OB 3.2	Monitors and detects deviations from the intended flight path and takes appropriate action
OB 3.3	Manages the flight path to achieve optimum operational performance
OB 3.4	Maintains the intended flight path during flight using automation whilst managing other tasks and distractions
OB 3.5	Selects appropriate level and mode of automation in a timely manner considering phase of flight and workload
OB 3.6	Effectively monitors automation, including engagement and automatic mode transitions

Aeroplane flight path management — manual control (FPM)	
Description:	Controls the flight path through manual control
OB 4.1	Controls the aircraft manually with accuracy and smoothness as appropriate to the situation
OB 4.2	Monitors and detects deviations from the intended flight path and takes appropriate action
OB 4.3	Manually controls the aeroplane using the relationship between aeroplane attitude, speed and thrust, and navigation signals or visual information
OB 4.4	Manages the flight path to achieve optimum operational performance
OB 4.5	Maintains the intended flight path during manual flight whilst managing other tasks and distractions
OB 4.6	Uses appropriate flight management and guidance systems, as installed and applicable to the conditions
OB 4.7	Effectively monitors flight guidance systems including engagement and automatic mode transitions

Leadership & teamwork (LTW)	
Description:	Influences others to contribute to a shared purpose. Collaborates to accomplish the goals of the team
OB 5.1	Encourages team participation and open communication
OB 5.2	Demonstrates initiative and provides direction when required
OB 5.3	Engages others in planning
OB 5.4	Considers inputs from others
OB 5.5	Gives and receives feedback constructively
OB 5.6	Addresses and resolves conflicts and disagreements in a constructive manner
OB 5.7	Exercises decisive leadership when required
OB 5.8	Accepts responsibility for decisions and actions
OB 5.9	Carries out instructions when directed
OB 5.10	Applies effective intervention strategies to resolve identified deviations
OB 5.11	Manages cultural and language challenges, as applicable

Problem-solving — decision-making (PSD)	
Description:	Identifies precursors, mitigates problems, and makes decisions
OB 6.1	Identifies, assesses and manages threats and errors in a timely manner
OB 6.2	Seeks accurate and adequate information from appropriate sources
OB 6.3	Identifies and verifies what and why things have gone wrong, if appropriate
OB 6.4	Perseveres in working through problems whilst prioritising safety
OB 6.5	Identifies and considers appropriate options
OB 6.6	Applies appropriate and timely decision-making techniques
OB 6.7	Monitors, reviews and adapts decisions as required
OB 6.8	Adapts when faced with situations where no guidance or procedure exists
OB 6.9	Demonstrates resilience when encountering an unexpected event

Situation awareness and management of information (SAW)	
Description:	Perceives, comprehends and manages information and anticipates its effect on the operation
OB 7.1	Monitors and assesses the state of the aeroplane and its systems
OB 7.2	Monitors and assesses the aeroplane's energy state, and its anticipated flight path
OB 7.3	Monitors and assesses the general environment as it may affect the operation
OB 7.4	Validates the accuracy of information and checks for gross errors
OB 7.5	Maintains awareness of the people involved in or affected by the operation and their capacity to perform as expected
OB 7.6	Develops effective contingency plans based upon potential risks associated with threats and errors
OB 7.7	Responds to indications of reduced situation awareness

Workload management (WLM)	
Description:	Maintains available workload capacity by prioritising and distributing tasks using appropriate resources
OB 8.1	Exercises self-control in all situations
OB 8.2	Plans, prioritises and schedules appropriate tasks effectively
OB 8.3	Manages time efficiently when carrying out tasks
OB 8.4	Offers and gives assistance
OB 8.5	Delegates tasks
OB 8.6	Seeks and accepts assistance, when appropriate
OB 8.7	Monitors, reviews and cross-checks actions conscientiously
OB 8.8	Verifies that tasks are completed to the expected outcome
OB 8.9	Manages and recovers from interruptions, distractions, variations and failures effectively while performing tasks

AMC2 ORO.FC.231(b) Evidence-based training

ED Decision 2021/002/R

ADAPTED COMPETENCY MODEL

- (a) An operator seeking to develop an adapted competency model under [ORO.GEN.120](#) should:
 - (1) identify positive behaviours and use language that avoids ambiguity; and
 - (2) demonstrate equivalence to the recommended EBT competencies in [AMC1 ORO.FC.231\(b\)](#).
- (b) In order to demonstrate equivalence, the operator should map the competencies and observable behaviours to the recommended EBT competencies.
- (c) When the operator is translating [AMC1 ORO.FC.231\(b\)](#) into its common language, the application of [ORO.GEN.120](#) may not be necessary. The translation may not be literal.

GM1 ORO.FC.231(b) Evidence-based training

ED Decision 2021/002/R

ADAPTED COMPETENCY MODEL/POSITIVE OBSERVABLE BEHAVIOUR

- (a) OBs should describe behaviours that contribute to positive pilot performance.
- (b) The indicators should clearly describe how a competency is expected to be demonstrated by a crew member in the context of the operational environment.
- (c) If the operator makes small adjustments in the wording used to describe the OBs of the EASA competency framework in order to improve the understanding of the pilots while maintaining the same meaning, it may be considered as EASA competency framework and not as an adapted competency model.

AMC1 ORO.FC.231(c) Evidence-based training

ED Decision 2022/014/R

TRAINING SYSTEM PERFORMANCE — FEEDBACK PROCESS

- (a) Feedback process is the continuous process of collecting and analysing assessment and training data from an EBT programme.
- (b) The feedback process should use defined metrics to collect data in order to:
 - (1) identify trends and ensure corrective action where necessary;
 - (2) identify collective training needs;
 - (3) review, adjust and continuously improve the training programme;
 - (4) further develop the training system; and
 - (5) standardise the instructors (when the standardisation and concordance assurance programme is integrated into the training system performance).
- (c) The following defined metrics should be collected as a minimum:
 - (1) level 0 grading metrics (competent metrics): data metrics providing the information whether the pilot(s) is (are) competent or not;
 - (2) level 1 grading metrics (competency metrics): quantifiable data from the grading system — numeric grade of the competencies (e.g. 1 to 5);

- (3) level 2 grading metrics (observable behaviour metrics): the instructors record predetermined OBs during the session;
 - (4) level 3 grading metrics (other metrics): the instructors may record other data (e.g. abstract, specific tasks, actions, questions, etc.).
- (d) Alternatively, where a system for the measurement of training system performance already exists, the operator may use it and, if necessary, adapt it to meet the demands of EBT.

AMC2 ORO.FC.231(c) Evidence-based training

ED Decision 2021/002/R

FEEDBACK PROCESS — DATA PROTECTION — GRADING SYSTEM

- (a) The objective of protecting the EBT data is to avoid inappropriate use of it in order to ensure the continued availability of such data, to maintain and improve pilot competencies.
- (b) The data access and security policy should restrict information access to authorised persons.
- (c) The data access and security policy should include the measures to ensure the security of the data (e.g. information security standard).
- (d) The data access and security policy (including the procedure to prevent disclosure of crew identity) should be agreed by all parties involved (airline management and flight crew member representatives nominated either by the union or the flight crew themselves).
- (e) The data access and security policy should be in line with the organisation safety policy in order to not make available or to not make use of the EBT data to attribute blame or liability.
- (f) The operator may integrate the security policy within other management systems already in place (e.g. information security management).

GM1 ORO.FC.231(c) Evidence-based training

ED Decision 2021/002/R

TRAINING SYSTEM PERFORMANCE — FEEDBACK PROCESS — METRICS

- (a) Training metrics within the feedback process are a valuable source of data. Typical metrics may include but are not limited to:
 - (1) differences in success rates between training topics;
 - (2) the trainees' feedback (e.g. surveys), which provides a different perspective as to the quality and effectiveness of the training;
 - (3) instructor concordance assurance: this system is important to measure the effectiveness of the instructor calibration process. It is important to remind that the purpose of this system is not to spy on instructors or to pressure individuals to change their grading;
 - (4) level 0 grading metrics (competent metrics): Metrics examples: distribution of pilots not competent after the SBT, distribution of pilots not competent in the EVAL and competent after the SBT;
 - (5) level 1 grading metrics (competency metrics): Metrics examples:
 - (i) distribution of level of performance within the range of competencies;
 - (ii) differences in grades between aircraft types;

- (6) level 2 grading metrics (observable behaviour metrics): e.g. in specific example scenario elements. Metrics example: differences in displaying OBs between ranks of pilots;
 - (7) level 3 grading metrics (other metrics such as data based on tasks): for instance, did the pilot calculate the landing distance? Or, did the pilots make a call-out in a specific manoeuvre? This level is usually linked to data collection of the SMS or EBT feedback loop (e.g. was the call-out of the TCAS manoeuvre correct? 'TCAS I have control'). Metrics example: distribution of errors for various training scenarios and aircraft types.
 - (8) during the simulator session, the operator may consider the level of grading metrics that the instructor needs to collect, taking into consideration the workload of the instructor.
- (b) Training metrics are an invaluable component in supporting an EBT programme, but they must be placed in the context of operational data because only the latter can justify the importance of specific training. For this purpose, data from the line evaluation of competence is important to measure the effectiveness of the EBT programme in operations. It may include data from the process for the monitoring of line operations.
- (c) Complex operators may, in the context of their safety management system, establish a safety action group dedicated to training: 'training safety action group'. This may be a best practice to meet the implementing rule.

GM2 ORO.FC.231(c) Evidence-based training

ED Decision 2021/002/R

FEEDBACK PROCESS — DATA PROTECTION – GRADING SYSTEM

- (a) The data access and security policy may, as a minimum, define:
- (1) a policy for access to information only to specifically authorised persons identified by their position in order to perform their duties. The required authorised person(s) does (do) not need to be the EBT manager; it could be the EBT programme manager or a third party mutually acceptable to unions or staff and management. The third party may also be in charge of ensuring the correct application of the data access and security policy (e.g. the third party is the one activating the system to allow access to the authorised persons);
 - (2) the identified data retention policy and accountability;
 - (3) the measures to ensure that the security of the data includes the information security standard (e.g. information security management systems standard e.g. ISO 2700x-ISO 27001, NIST SP 800-53, etc.);
 - (4) the method to obtain de-identified crew feedback on those occasions that require specific follow-up; and
- (b) When there is a need for data protection, it is preferable to de-identify the data rather than anonymise it.

AMC1 ORO.FC.231(d)(1) Evidence-based training

ED Decision 2021/002/R

GRADING SYSTEM

- (a) The grading system should provide quantifiable data for the measurement of the training system performance.

- (b) The grading scale should be 1 to 5, where:
- (1) Grade 1 — NOT COMPETENT — determines that the minimum acceptable level of performance was not achieved for the conduct of line operations. An outcome of ADDITIONAL TRAINING REQUIRED and level 2 grading metrics should be recorded.
 - (2) Grade 2 to 5 determine an outcome of COMPETENT for the conduct of line operations.
 - (3) Grade 2 (below the average) determines that the minimum acceptable level was achieved for the conduct of line operations. Additionally, level 2 grading metrics should be recorded.

Minimum performance indicates a need for training (e.g. tailored or additional) to elevate performance. It includes:
 - (i) a competency graded continuously with 2 in multiple modules, or
 - (ii) the majority of competencies graded with 2 in a module.
 - (4) Grade 3 is the average.
 - (5) Grade 4 determines that the pilot is above the average.
 - (6) Grade 5 (exemplary) determines that the pilot is above the average and the outcome is enhanced safety, effectiveness and efficiency.
- (c) The operator should develop further grading guidance to the above points to help the instructors determine the grade of the pilots they assess.

AMC2 ORO.FC.231(d)(1) Evidence-based training

ED Decision 2021/002/R

GRADING SYSTEM — ALTERNATIVE SYSTEM

- (a) An operator seeking to develop an alternative grading system under [ORO.GEN.120](#) should:
- (1) provide quantifiable data for the measurement of the training system performance; and
 - (2) demonstrate equivalence to the recommended grading system in [AMC1 ORO.FC.231\(d\)\(1\)](#).
- (b) The grading scale for each competency should:
- (1) determine the grade at which the performance is considered:
 - (i) NOT COMPETENT for the conduct of line operations. An outcome of ADDITIONAL TRAINING REQUIRED and level 2 grading metrics should be recorded; and
 - (ii) COMPETENT for the conduct of line operations; and
 - (2) determine for the pilot whose performance is considered competent for the conduct of line operations:
 - (i) if the pilot needs more training (e.g. tailored or additional training) to elevate their performance to the operator specified norm;
 - (ii) if the pilot is at the operator specified norm;
 - (iii) if the pilot is above the average (it can be one or more grades e.g. above the average and exemplary).

- (c) The operator should develop further guidance to the above points to help the instructors determine the grade of the pilots they assess.

AMC3 ORO.FC.231(d)(1) Evidence-based training

ED Decision 2021/002/R

RECOMMENDED CONDUCT OF THE GRADING — ORCA

- (a) Grading the performance of flight crew members during an EBT module should include the following steps:
- (1) Observe performance (behaviours) during the simulator session.
 - (2) Record details of effective and ineffective performance (behaviours) observed during the simulator session ('record' in this context refers to instructors taking notes).
 - (3) Classify observations against the OBs and allocate the OBs to each competency (or competencies), using amongst others the facilitation technique.
 - (4) Assess and evaluate (grade): assess the performance by determining the root cause(s) according to the competency framework. Low performance would normally indicate the area of performance to be remediated in subsequent phases or modules. Evaluate (grade) the performance by determining a grade for each competency using a methodology defined by the operator.
- (b) As a minimum, the instructor should grade all the observed competencies at:
- (1) the end of the EVAL (de-briefing) by providing at least level 1 grading metrics;
 - (2) the end of the MT (de-briefing) by providing at least level 0 grading metrics; and
 - (3) at the end of the EBT module (de-briefing) by providing at least level 0 grading metrics (level 1 grading metrics are recommended).

AMC4 ORO.FC.231(d)(1) Evidence-based training

ED Decision 2022/014/R

RECOMMENDED GRADING SYSTEM METHODOLOGY — VENN MODEL

- (a) To grade a competency, the instructor should assess the associated OBs of each competency against the following dimensions by determining:
- (1) what was the outcome of the threat management, error management and undesired aircraft state management relating specifically to the competency being assessed;
 - (2) how well the flight crew member demonstrated the OB(s) when they were required. This includes:
 - (i) how many OBs the flight crew member demonstrated over the EBT phase (e.g. EVAL, MT, SBT) when they were required; and
 - (ii) how often the flight crew member demonstrated the OB(s) when they were required;

Abbreviated word picture VENN model				
	TEM	Observable behaviours		
Grading	OUTCOME (1)	HOW WELL (2) =	HOW MANY (i)+	HOW OFTEN (ii)
1	unsafe situation	ineffectively	few, hardly any	rarely
2	not an unsafe situation	minimally acceptable	some	occasionally
3	safe situation	adequately	many	regularly
4	safe situation	effectively	most	regularly
5	enhanced safety, effectiveness and efficiency	in an exemplary manner	all, almost all	always

- (b) Grades should be determined during each EBT module as follows:
- (1) EVAL — overall performance of the phase for each competency at level 1 grading metrics.
 - (2) MT — overall performance of the phase at level 0 grading metrics. When the phase is graded ‘not competent’, it requires level 2 grading metrics.
 Note: Only a limited number of competencies may be observed and graded in this phase (e.g. PRO, FPA, FPM); the others are ‘to be left in blank’.
 - (3) SBT — overall performance of the phase for each competency at level 1 grading metrics. Unless just culture and the necessary non-jeopardy environment during training may be compromised. In that case, level 0 grading metrics.
 Note: In-seat instruction (ISI) should not be included in any assessment.
- (c) Where any competency is graded below the minimum acceptable level of performance (grade 1 on a 5-point scale), an outcome of additional FSTD training is required.
- (1) Additional level 2 grading metrics must be recorded.
 - (2) The flight crew member should not be released to unsupervised line operations until each competency is demonstrated at or above the minimum acceptable level of performance.
- (d) Where all competencies are determined at or above the minimum acceptable level of performance (grade 2 on a 5-point scale), the outcome should be COMPETENT. Consistent grading below the average (2 on a 5-point scale) may indicate a need for training to elevate the performance to the average (grade 3 on a 5-point scale). As a minimum, the following conditions apply:
- (1) Any competency graded with 2 requires level 2 grading metrics.
 - (2) Any competency graded with 2 in any simulator session of the 1st module followed by a grade 2 in the same competency in the EVAL of the 2nd module requires individual tailored training in the SBT of the 2nd module. (First example: 1st Module SBT graded with 2, 2nd Module EVAL graded with 2 in the same competency, thus the 2nd SBT should be an individual tailored training on that competency. Second example: 1st module EVAL graded 2, 2nd module EVAL graded 2 on the same competency, thus the 2nd module SBT should be individual tailored training on that competency).
 - (3) Any competency graded with 2 in three consecutive modules requires individual tailored training. If at the end of the tailored training (3rd SBT) the competency continues being

graded with 2, additional FSTD training is required within the next 3 months. For instance, following the example above, the SBT in the 2nd Module was an individual tailored training. In the 3rd Module during the EVAL the same competency is graded with 2 and individual tailored training is applied. The SBT is graded with 2 again. The pilot may continue line operations but should receive additional FSTD training within the next 3 months.

- (4) The operator should not release a flight crew member to unsupervised line operations when more than four competencies (the majority of the competencies — five competencies or above) are graded with 2 in any single simulator session of the module.
 - (5) Any EVAL graded with 2 in more than three competencies requires individual tailored training in the SBT. If at the end of the module more than three competencies continue being graded with 2, the pilot may continue line operations but should receive additional FSTD training within the next 3 months.
- (e) ‘Individual tailored training’ refers to a simulator session tailored to the pilot’s individual training needs, which may require a different programme or syllabus. Normally, it may be done during the SBT and normally there is not an increase of FSTD volume (no extra simulator session). It may require an increased volume of training such as CBT, additional briefings, etc. Any individual tailored training may be substituted by additional FSTD training before the start of the next module.
- (f) ‘Additional FSTD training’ refers to the fact that in addition to the requirements of tailored training, there is an increase of FSTD volume (extra simulator session). It normally happens after individual tailored training.

GM1 ORO.FC.231(d)(1) Evidence-based training

ED Decision 2022/014/R

RECOMMENDED CONDUCT OF THE GRADING — ORCA

- (a) At the end of the EVAL, after the facilitated de-briefing, the instructor may, as a minimum, record level 1 grading metrics.
- (b) The instructor may conduct the simulator session of the EVAL following the principles of a summative assessment and the facilitated de-briefing following the principles of a formative assessment. The MT and SBT simulator sessions may be conducted as a formative assessment.
- (c) At the end of each training phase, it is recommended to record level 1 grading metrics unless just culture and the necessary non-jeopardy environment during training may be compromised. In that case, the following alternative may be recommended: level 0 grading metrics for all competencies may be recorded (exceptionally ‘not observed’ or ‘left in blank’ may be recorded) and de-identified level 1 grading metrics may be recorded for the data collection and analysis purposes.
- (d) A simple practice to classify the observations recorded during the simulator session is to classify the OB as positive, negative, neutral.

GM2 ORO.FC.231(d)(1) Evidence-based training

ED Decision 2022/014/R

RECOMMENDED GRADING SYSTEM METHODOLOGY — VENN MODEL

- (a) Grades may be determined during each EBT module as follows:
- (1) For each assigned grade:
 - (i) the observed performance should be identified with one or more OBs; and
 - (ii) the OB(s) should simply link the observed performance to the competency; they are not to be used as a checklist.
 - (2) At the completion of the EVAL, the grade should be the overall assessment of the performance of each competency during the EVAL. Although it is not recommended, if the instructor performs an overall grade (additional to level 1), it should be at level 0 grading metric (competent or not).
 - (3) The underlying philosophy of the individual tailored training and additional FSTD training is the identification of the pilot’s individual training needs during the EVAL or EVALs. However, there may be cases in which such an identification may be complemented using other phases or combination of phases along the EBT programme. Nevertheless, when this happens consistently to a large number of pilots, it may indicate a problem of instructor standardisation.
 - (4) At the completion of the MT, only a limited number of competencies can be graded. The others are to be left in blank. Note: The grade of a competency as ‘not observed’ is a relevant set of data to be used in the EBT programme (e.g. may be used for instructor concordance assurance programme, programme design, etc.), while ‘competency left in blank’ is stating the obvious, which is that MT is a skill retention phase and therefore it focuses on only some of the competencies which may provide NO opportunity to observe all the competencies.
 - (5) At the completion of the module, grades should be assigned for each competency, based on the overall assessment of training during the SBT.
 - (6) In exceptional occasions, the instructor may have been unable to assess one or two competencies in the EVAL or SBT. A ‘not observed’ may be graded. The training system performance and concordance assurance system may use these metrics to improve instructors’ standardisation and the EBT programme design. When the operator grades the MT alone (instead of grading the MT and EVAL together), a ‘not observed’ grading may be frequent. It also occurs when the instructor grades each one of the manoeuvres.
- (b) The word pictures are standardised according to the VENN model but may be simplified once instructors become familiar with the system.

Word picture VENN model

Application of procedures (PRO)

5	The pilot applied procedures in an exemplary manner, by always demonstrating almost all of the observable behaviours to a high standard when required, which enhanced safety, effectiveness and efficiency
4	The pilot applied procedures effectively, by regularly demonstrating most of the observable behaviours when required, which resulted in a safe operation

3	The pilot applied procedures adequately, by regularly demonstrating many of the observable behaviours when required, which resulted in a safe operation
2	The pilot applied procedures at the minimum acceptable level, by only occasionally demonstrating some of the observable behaviours when required, but which did not result in an unsafe situation
1	The pilot applied procedures ineffectively, by rarely demonstrating any of the observable behaviours when required, which resulted in an unsafe situation

Communication (COM)

5	The pilot communicated in an exemplary manner, by always demonstrating almost all of the observable behaviours to a high standard when required, which enhanced safety, effectiveness and efficiency
4	The pilot communicated effectively, by regularly demonstrating most of the observable behaviours when required, which resulted in a safe operation
3	The pilot communicated adequately, by regularly demonstrating many of the observable behaviours when required, which resulted in a safe operation
2	The pilot communicated at the minimum acceptable level, by only occasionally demonstrating some of the observable behaviours when required, but which did not result in an unsafe situation
1	The pilot communicated ineffectively, by rarely demonstrating any of the observable behaviours when required, which resulted in an unsafe situation

Flight path management — automation (FPA)

5	The pilot managed the automation in an exemplary manner, by always demonstrating almost all of the observable behaviours to a high standard when required, which enhanced safety, effectiveness and efficiency
4	The pilot managed the automation effectively, by regularly demonstrating most of the observable behaviours when required, which resulted in a safe operation
3	The pilot managed the automation adequately, by regularly demonstrating many of the observable behaviours when required, which resulted in a safe operation
2	The pilot managed the automation at the minimum acceptable level, by only occasionally demonstrating some of the observable behaviours when required, but which did not result in an unsafe situation
1	The pilot managed the automation ineffectively, by rarely demonstrating any of the observable behaviours when required, which resulted in an unsafe situation

Flight path management — manual control (FPM)

5	The pilot controlled the aircraft in an exemplary manner, by always demonstrating almost all of the observable behaviours to a high standard when required, which enhanced safety, effectiveness and efficiency
4	The pilot controlled the aircraft effectively, by regularly demonstrating most of the observable behaviours when required, which resulted in a safe operation

3	The pilot controlled the aircraft adequately, by regularly demonstrating many of the observable behaviours when required, which resulted in a safe operation
2	The pilot controlled the aircraft at the minimum acceptable level, by only occasionally demonstrating some of the observable behaviours when required, but which did not result in an unsafe situation
1	The pilot controlled the aircraft ineffectively, by rarely demonstrating any of the observable behaviours when required, which resulted in an unsafe situation

Application of knowledge (KNO)

5	The pilot showed exemplary knowledge, by always demonstrating almost all of the observable behaviours to a high standard when required, which enhanced safety, effectiveness and efficiency
4	The pilot showed adequate knowledge, by regularly demonstrating most of the observable behaviours when required, which resulted in a safe operation
3	The pilot showed adequate knowledge, by regularly demonstrating many of the observable behaviours when required, which resulted in a safe operation
2	The pilot showed knowledge at the minimum acceptable level, by only occasionally demonstrating some of the observable behaviours when required, but which did not result in an unsafe situation
1	The pilot showed inadequate knowledge, by rarely demonstrating any of the observable behaviours when required, which resulted in an unsafe situation

Leadership & teamwork (LTW)

5	The pilot led and worked as a team member in an exemplary manner, by always demonstrating almost all of the observable behaviours to a high standard when required, which enhanced safety, effectiveness and efficiency
4	The pilot led and worked as a team member effectively, by regularly demonstrating most of the observable behaviours when required, which resulted in a safe operation
3	The pilot led and worked as a team member adequately, by regularly demonstrating many of the observable behaviours when required, which resulted in a safe operation
2	The pilot led and worked as a team member at the minimum acceptable level, by only occasionally demonstrating some of the observable behaviours when required, but which did not result in an unsafe situation
1	The pilot led or worked as a team member ineffectively, by rarely demonstrating any of the observable behaviours when required, which resulted in an unsafe situation

Problem-solving & decision-making (PSD)

5	The pilot solved problems and made decisions in an exemplary manner, by always demonstrating almost all of the observable behaviours to a high standard when required, which enhanced safety, effectiveness and efficiency
---	--

4	The pilot solved problems and made decisions effectively, by regularly demonstrating most of the observable behaviours when required, which resulted in a safe operation
3	The pilot solved problems and made decisions adequately, by regularly demonstrating many of the observable behaviours when required, which resulted in a safe operation
2	The pilot solved problems and made decisions at the minimum acceptable level, by only occasionally demonstrating some of the observable behaviours when required, but which did not result in an unsafe situation
1	The pilot solved problems or made decisions ineffectively, by rarely demonstrating any of the observable behaviours when required, which resulted in an unsafe situation

Situation awareness (SAW)

5	The pilot's situation awareness was exemplary, by always demonstrating almost all of the observable behaviours to a high standard when required, which enhanced safety, effectiveness and efficiency
4	The pilot's situation awareness was good, by regularly demonstrating most of the observable behaviours when required, which resulted in a safe operation
3	The pilot's situation awareness was adequate, by regularly demonstrating many of the observable behaviours when required, which resulted in a safe operation
2	The pilot's situation awareness was at the minimum acceptable level, by only occasionally demonstrating some of the observable behaviours when required, but which did not result in an unsafe situation
1	The pilot's situation awareness was inadequate, by rarely demonstrating any of the observable behaviours when required, which resulted in an unsafe situation

Workload management (WLM)

5	The pilot managed the workload in an exemplary manner, by always demonstrating almost all of the observable behaviours to a high standard when required, which enhanced safety, effectiveness and efficiency
4	The pilot managed the workload effectively, by regularly demonstrating most of the observable behaviours when required, which resulted in a safe operation
3	The pilot managed the workload adequately, by regularly demonstrating many of the observable behaviours when required, which resulted in a safe operation
2	The pilot managed the workload at the minimum acceptable level, by only occasionally demonstrating some of the observable behaviours when required, but which did not result in an unsafe situation
1	The pilot managed the workload ineffectively, by rarely demonstrating any of the observable behaviours when required, which resulted in an unsafe situation

AMC1 ORO.FC.231(d)(2) Evidence-based training

ED Decision 2022/014/R

VERIFICATION OF THE ACCURACY OF THE GRADING SYSTEM

- (a) The purpose is to provide data to assess the accuracy of the grading system.
- (b) The items defined below are based on Part-FCL Appendix 9. They should be included in the EVAL and MT of the applicable module. The minimum items to be included are: rejected take-off, failure of critical engine between V1 & V2, 3D approaches down to a decision height (DH) not less than 60 m (200 ft), engine-out approach & go-around, 2D approach down to the MDH/A, engine-out approach & go-around, engine-out landing.
- (c) Instructors should record if the exercises are flown to proficiency using Appendix 9 references (define criteria). Note: Individual pilots' grading and assessment remains according to the EBT grading system and Appendix 10.
- (d) This verification should be performed once every 3 years.

GM1 ORO.FC.231(d)(2) Evidence-based training

ED Decision 2021/002/R

VERIFICATION OF THE ACCURACY OF THE GRADING SYSTEM

Items that may be included in a verification of the accuracy of the grading system:

Assessment and training topic	Flight phase for	Description (includes type of topic, being threat, error or focus)	Desired outcome (includes performance criteria OR training outcome)	Guidance material (GM) Example scenario elements	PRO	COM	EPA	EPM	LTW	PSD	SAW	WLM	KNO
Use of checklist prior to starting engines (1.4 AP9)	GN D	Use of checklist prior to starting engines, starting procedures, radio and navigation equipment check, selection and setting of navigation and communication frequencies	This element is not required	Intentionally left in blank									
Before take-off checks (1.6 AP9)	GN D		This element is not required	Intentionally left in blank									
Rejected take-off at a reasonable speed before reaching	TO	Engine failure after the application of take-off thrust and before reaching V1	PRO - demonstrate adequate knowledge of the technique and procedure for accomplishing a rejected take-off after power-plant/system(s) failure/warnings, including related safety factors; - take into account, prior to beginning the take-off, operational factors which could affect the manoeuvre, such as take-off warning inhibit systems or other	From initiation of take-off to complete stop (or as applicable to procedure)	x			x					

V1 (2.6 AP9)			<p>aeroplane characteristics, runway length, surface conditions, wind, obstructions that could affect take-off performance and could adversely affect safety;</p> <ul style="list-style-type: none"> - perform all required pre-take-off checks as required by the appropriate checklist items. <p>FPM</p> <ul style="list-style-type: none"> - align the aeroplane on the runway centreline; - reduce the power smoothly and promptly, if appropriate to the aeroplane, when power-plant failure is recognised. Maintain the aeroplane under control close to the runway centreline; - use spoilers, prop reverse, thrust reverse, wheel brakes, and other drag/braking devices, as appropriate, maintaining positive control in such a manner as to bring the aeroplane to a safe stop. Accomplish the appropriate power-plant failure or other procedures and/or checklists as set forth in the POH or AFM or SOPs. 																
3.8.1* Adherence to departure and arrival routes and ATC instructions	CL BA PP		This element is not required	Intentionally left in blank															
Take-off with engine failure between V1 and V2 (2.5.2 AP9)	T O	Failure of the critical engine from V1 and before reaching V2 in the lowest CAT I visibility conditions	<p>FPM</p> <ul style="list-style-type: none"> - establish a bank of approximately 5°, if required, or as recommended by the manufacturer, to maintain coordinated flight, and properly trim for that condition; maintain the operating engine within acceptable operating limits; - establish the best engine inoperative airspeed as appropriate to the aircraft and condition of flight; - establish and maintain the recommended flight attitude and configuration for the best performance for all manoeuvring necessary for the phase of flight; - maintain desired altitude within given limits, when a constant altitude is specified and is within the capability of the aeroplane; - maintain the desired airspeed and heading within given limits. 	<p>The manoeuvre is considered to be complete at a point when the aircraft is stabilised at normal engine-out climb speed with the correct pitch and lateral control, in trim condition and, as applicable, autopilot engagement.</p>	x														x

			<p>PRO</p> <ul style="list-style-type: none"> - recognise an engine failure or the need to shut down an engine as simulated by the examiner; - complete engine failure vital action checks from memory; - follow the prescribed aeroplane checklist, and verify the procedures for securing the inoperative engine; - demonstrate proper engine restart or shutdown procedures (whatever appropriate) in accordance with approved procedure/checklist or the manufacturer's recommended procedures and pertinent checklist items; and monitor all functions of the operating engine and make necessary adjustments. 	<p>The manoeuvre is considered to be complete at a point when the aircraft is stabilised in a clean configuration with engine-out procedures completed.</p>	x															
--	--	--	---	---	---	--	--	--	--	--	--	--	--	--	--	--	--	--	--	--

3.8.3* 3D operations to DH/A of 200 ft (60 m) or to higher minima if required by the approach procedure	AP P	Manually, with one engine simulated inoperative; engine failure has to be simulated during final approach before passing 1 000 ft above aerodrome level until touchdown or through the complete missed approach procedure.	<p>PRO</p> <ul style="list-style-type: none"> - select and comply with the ILS or LPV instrument approach procedure to be performed; - prior to final approach course, maintain declared or assigned altitudes within given limits without descending below applicable minimum altitudes and maintain headings within given limits; - select, tune, identify and confirm the operational status of ground and aircraft navigation equipment to be used for the approach procedure. <p>COM</p> <ul style="list-style-type: none"> - establish two-way communications with ATC using the proper communications phraseology and techniques, either personally, or, if appropriate, direct co-pilot/safety pilot to do so, as required for the phase of flight or approach segment; 	Intentionally left in blank	Intentionally left in blank
		Or Manually, with one engine simulated inoperative; engine failure has to be simulated during final approach after passing the outer marker (OM)	<p>FPA/FPM</p> <ul style="list-style-type: none"> - comply in a timely manner with all clearances, instructions, and procedures issued by ATC and advise accordingly if unable to comply. - establish the appropriate aircraft configuration and airspeed/V-speed considering turbulence, wind shear or other meteorological and operating conditions; - complete the aircraft checklist items appropriate to the phase of flight or approach segment, including engine out approach and landing checklist, as appropriate; 		

		<p>within a distance of not more than 4 NM until touchdown or through the complete missed approach procedure.</p>	<ul style="list-style-type: none"> - apply necessary adjustment to the published DH and visibility criteria for the aeroplane approach category when required, such as NOTAMs, inoperative aeroplane and ground navigation equipment, inoperative visual aids associated with the landing environment; - on final approach course, allow no more than ½ scale deflection of the localiser and/or glideslope indications; - maintain declared approach airspeeds within given limits; - maintain a stabilised descent to the DH to permit completion of the visual portion of the approach and landing with minimal manoeuvring; and - initiate the missed approach procedure, upon reaching the DH, when the required visual references for the intended runway are not obtained. <p>3D linear vertical deviations (e.g. RNP APCH (LNAV/VNAV) using BaroVNAV): not more than – 75 ft below the vertical profile at any time, and not more than + 75 ft above the vertical profile at or below 1 000 ft above aerodrome level.</p> <p>3D (LNAV/VNAV) ‘linear’ lateral deviations: cross-track error/deviation should normally be limited to ± ½ the RNP value associated with the procedure. Brief deviations from this standard up to a maximum of 1 time the RNP value are allowable.</p>		
2D operations down to the MDH/A (3.8.4 AP9)	AP P	Non-precision approach down to the MDH/A	<p>PRO</p> <ul style="list-style-type: none"> - select and comply with the PBN, VOR/ LOC/ LOC BC or NDB instrument approach procedure to be performed; - complete the aircraft checklist items appropriate to the phase of flight or approach segment, including engine out approach and landing checklist, as appropriate; - prior to final approach course, maintain declared altitudes in given limits without descending below applicable minimum altitudes, and maintain headings as given; - select, tune, identify, confirm and monitor the operational status of ground and aircraft navigation equipment to be used for the approach procedure. <p>COM</p> <ul style="list-style-type: none"> - establish two-way communications with ATC using the proper communications phraseology and techniques, either personally, or, if appropriate, direct co- 	Intentionally left in blank	Intentionally left in blank

			<p>pilot/safety pilot to do so, as required for the phase of flight or approach segment;</p> <ul style="list-style-type: none"> - comply in a timely manner with all clearances, instructions, and procedures issued by ATC and advise accordingly if unable to comply. <p>FPA/FPM</p> <ul style="list-style-type: none"> - apply necessary adjustment to the published minimum descent altitude (MDA) and visibility criteria for the aeroplane approach category when required, such as NOTAMs, inoperative aeroplane and ground navigation equipment, inoperative visual aids associated with the landing environment; - on the intermediate and final segments of the final approach course: <ul style="list-style-type: none"> a. maintain PBN, VOR/ LOC/ LOC BC tracking within ½ scale deflection of the course deviation indicator or within 5 degrees of the desired track in the case of an NDB approach; b. fly the approach in a stabilised manner without descending below the applicable minimum altitudes depicted on the approach chart (+as required/-0 feet); 2D (LNAV) 'linear' lateral deviations: cross-track error/deviation should normally be limited to $\pm \frac{1}{2}$ the RNP value associated with the procedure. Brief deviations from this standard up to a maximum of 1 time the RNP value are allowable. c. descend to and accurately maintain the MDA and track to the missed approach point (MAPt) or to the recommended minimum visibility that would permit completion of the visual portion of the approach with a normal rate of descent and minimal manoeuvring; d. maintain declared approach airspeeds (+10/-5 knots); e. initiate the missed approach procedure, if the required visual references for the intended runway are not obtained at the MAPt; f. execute a normal landing from a straight-in or circling approach as required. 		
--	--	--	---	--	--

Engine-out approach & go-around (4.4* AP9)	AP P	Manual go-around with the critical engine simulated inoperative after an instrument approach	Demonstrate manual aircraft control skills with smoothness and accuracy as appropriate to the situation; Detect deviations through instrument scanning; Maintain spare mental capacity during manual aircraft control; Maintain the aircraft within the flight envelope; Apply knowledge of the relationship between aircraft attitude, speed and thrust.	This manoeuvre should be flown from intercept to centreline until acceleration after go-around. The manoeuvre is	<table border="1" style="width: 100%; height: 100%;"> <tr> <td style="width: 10%; text-align: center;">x</td> <td style="width: 10%;"></td> <td style="width: 10%;"></td> <td style="width: 10%;"></td> <td style="width: 10%; text-align: center;">x</td> <td style="width: 10%;"></td> <td style="width: 10%;"></td> <td style="width: 10%;"></td> <td style="width: 10%;"></td> <td style="width: 10%;"></td> <td style="width: 10%;"></td> <td style="width: 10%;"></td> </tr> </table>	x				x							
x				x													

		on reaching DH, MDH or MAPt		considered to be complete at a point when the aircraft is stabilised at normal engine-out climb speed with the correct pitch and lateral control, in trim condition and, as applicable, autopilot engagement (describe generally critical part of manoeuvre)													
Engine-out landing (5.5 AP9)	LD G	Landing with the critical engine inoperative		Initiation in a stabilised engine-out configuration from not less than 3 NM final approach, until completion of roll-out	x				x								

GM2 ORO.FC.231(d)(2) Evidence-based training

ED Decision 2021/002/R

VERIFICATION OF THE ACCURACY OF THE GRADING SYSTEM — FEEDBACK PROCESS

The verification of the accuracy of the grading system provides valuable data for the training system performance and concordance assurance. Therefore, the verification is necessary from a systemic point of view and the intention is not to measure individual pilot against Appendix 9 criteria.

Concordance agreement between instructors may be high; however, the whole community of instructors may be grading too low or too high (accuracy).

The statistical result of the verification against Appendix 9 criteria can provide the operator with a criterion-referenced system to adjust the accuracy of the grading system. The verification does not require an examiner; EBT instructors may provide the necessary data.

Example 1: For the last 36 months, the operator has a rate of 3 % of pilots scoring 1 (assuming the data is statistically relevant). In this example, the rate of 3 % of the pilots scoring 1 is maintained across all the technical competencies. When the operator performs a verification, the rate of failure would have been only 0,5 %. This may indicate that instructors are rating too low in EBT and therefore some of the pilots scoring 1 should have been graded with a score higher than 1. This may be economically negative for the operator. On the other hand, it could be that the operator has decided to implement higher standards.

Example 2: The operator has an EBT programme with a negligible rate of pilots scoring 1 and a 1 % of pilots scoring 2 in two consecutive recurrent modules. The verification of the technical competencies against Appendix 9 criteria provides a rate of 5 % failure. The EBT manager should further investigate the reason behind this mismatch between EBT and Appendix 9 in the technical competencies. There may be factors influencing this mismatch (e.g. statistical issues, the events in the EBT modules are too benign compared to the events in Appendix 9), which may lead to a corrective action (e.g. redesign of the EBT modules). If the difficulty of the EBT scenarios is equivalent to Appendix 9 and the concordance is high between instructors, then the discrepancy in outcomes might be because the community of instructors are grading too high in the technical competencies (they are grading with 2 when they should have graded 1). Further instructor standardisation will be needed to address this.

The implementation of mixed EBT following GM1 ORO.FC.230(a);(b);(f) provides a good opportunity to fine-tune and verify the accuracy of the grading system because an Appendix 9 licence proficiency check is carried out every year. The authority may not allow full EBT unless the accuracy of the grading system is demonstrated.

Further guidance can be found in the EASA EBT manual.

AMC1 ORO.FC.231(e) Evidence-based training

ED Decision 2021/002/R

VOLUME AND FSTD QUALIFICATION LEVEL

- (a) The EBT programme has been developed to include a notional exemplar of 48 FSTD hours over a 3-year programme for each flight crew member.
- (b) Subject to ORO.GEN.120, the operator may reduce the number of FSTD hours provided that an equivalent level of safety is achieved. The programme should not be less than 36 FSTD hours.
- (c) Each EBT module should be conducted in an FSTD with a qualification level adequate to complete proficiency checks; therefore, it should be conducted in a full-flight simulator (FFS) level C or D.

AMC1 ORO.FC.231(f) Evidence-based training

ED Decision 2021/002/R

EQUIVALENCY OF MALFUNCTIONS — PROCESS

- (a) The equivalency of malfunctions process should be undertaken by subject matter experts (SMEs) who hold or have held a type rating on the aeroplane type.
- (b) Steps of the equivalency of malfunctions
 - Step 1: Look at (review) all aircraft system malfunctions provided by the OEM. For example, FCOM for Airbus, or AFM for other manufacturers, does not normally provide an exhaustive list of malfunctions.
 - Step 2: Determine and retain in a list only malfunctions that place a significant demand on a proficient crew, in isolation from an environmental or operational context.
 - Step 3: For each retained malfunction, determine the applicable characteristic or characteristics.
 - Step 4: Develop the EBT FSTD programme to incorporate malfunctions at the frequency specified in the table of assessment and training topics.
- (c) Malfunctions included in the equivalency of malfunctions but not included in the EBT FSTD programme require review and appropriate procedural knowledge training, conducted in a less qualified but suitable alternative environment (classroom, flight procedure training device, advance computer-based training, aviation blended learning environment (ABLE), etc.). Further guidance can be found in the EASA EBT manual.
- (d) The operator should establish procedures to determine what malfunctions should be included in the FSTD. This may include a different malfunction difficulty between the EVAL and the SBT.

AMC1 ORO.FC.231(f)(3) Evidence-based training

ED Decision 2021/002/R

CREW EXPOSURE TO AT LEAST ONE MALFUNCTION FOR EACH CHARACTERISTIC

- (a) Unless specified in the OSD, each crew member should be exposed to the characteristics of degraded control and loss of instrumentation in the role of pilot flying.
- (b) Notwithstanding point (a), for aircraft types with a limited number of malfunctions in the characteristic of degraded control or loss of instrumentation, the operator may use an alternative means of compliance in accordance with [ORO.GEN.120](#).

GM1 ORO.FC.231(f) Evidence-based training

ED Decision 2021/002/R

EQUIVALENCY OF MALFUNCTIONS — SIGNIFICANT DEMAND ON A PROFICIENT CREW

- (a) The criteria to determine that a malfunction places a significant demand on a proficient crew are the following:
 - (1) The procedure includes one or more action items and not only a set of information for crew awareness.
 - (2) The flight crew's cognitive load (resources required by the mental processes of perception, memory, judgement, and reasoning) significantly increases during or after the application of the associated abnormal or emergency procedure. The cognitive load

is considered to be significantly increased when it is well above the cognitive load induced by the application of the normal standard operating procedures.

- (3) The flight crew's workload significantly increases during or after the application of the associated abnormal or emergency procedure. The workload is considered to be significantly increased when it is well above the workload induced by the application of the normal standard operating procedures.
 - (4) The aircraft handling perceived by the pilot when flying in abnormal conditions is different compared to the aircraft handling in normal conditions; e.g. the symmetry of the flight is affected.
- (b) The criteria to determine that a malfunction places a significant demand on a proficient crew allow the identification of:
- (1) the pilot competencies that are specifically challenged during the management of the related procedure, and
 - (2) the characteristic of the aircraft system malfunction procedure.

Note: The identification of the pilot competencies allows a consistent assessment to determine the proficiency of the crew member.

Criteria in (a)	Definition	Challenged Competency	Example of procedure characteristics
(1)	The procedure includes one or more action items and not only a set of information for crew awareness.	PRO KNO	multiple paths within the procedure (e.g. decision trees) multiple inoperative or degraded systems
(2)	The flight crew's cognitive load (resources required by the mental processes of perception, memory, judgement, and reasoning) significantly increases, during, or after, the application of the abnormal/emergency procedure. The cognitive load is considered to be significantly increased when it is well above the cognitive load induced by the application of the normal standard operating procedures.	SAW PSD	multiple paths within the procedure (e.g. decision trees) multiple inoperative or degraded systems a high potential for undetected errors (e.g. removal of flight protections)
(3)	The flight crew's workload significantly increases, during, or after, the application of the abnormal/emergency procedure. The workload is considered to be significantly increased when it is well above the workload induced by the application of the normal standard operating procedures.	WLM	time criticality; multiple paths within the procedure (e.g. decision trees); multiple inoperative or degraded systems; a high potential for undetected errors (e.g. removal of flight protections); and a significant increase in workload (e.g. removal of automation).

(4)	The aircraft handling perceived by the pilot when flying in abnormal conditions is different compared to the aircraft handling in normal conditions; e.g. the symmetry of the flight is affected.	FPM FPA	multiple inoperative or degraded systems a high potential for undetected errors (e.g. removal of flight protections)
-----	---	------------	---

- (c) When a malfunction is placing a significant demand on a proficient crew, it means it has one or more of the malfunction characteristics (see more in [GM2.ORO.FC.231\(f\)](#)).

GM2 ORO.FC.231(f) Evidence-based training

ED Decision 2021/002/R

EQUIVALENCY OF MALFUNCTIONS — MALFUNCTION CHARACTERISTICS

The following may be considered suitable definitions for each of the characteristics:

- (a) ‘Immediacy’: System malfunctions that require immediate and urgent crew intervention or decision (e.g. malfunctions with memory items, loss of pressurisation at high altitude, brake failure during landing).
- (b) ‘Complexity’: System malfunctions that require recovery procedures with multiple options to analyse and/or multiple decision paths to apply (e.g. multiple hydraulic system failures, smoke and fumes procedures).
- (c) ‘Degradation of aircraft control’: System malfunctions that result in significant degradation of flight controls in combination with abnormal handling characteristics, such as modification of the normal pitch attitude during approach and landing or reconfiguration of the flight control laws or modes (e.g. jammed stabiliser, flaps/slats inoperative)
- (d) ‘Loss of instrumentation’: System malfunctions that require monitoring and management of the flight path using degraded or alternative displays such as temporary or permanent loss of any flight-path-related parameter displayed on the primary flight display (PFD), head-up display (HUD) or navigation display (ND), including loss of any setting capability of one of these indications. It includes primary instrumentation to monitor and manage primary aircraft systems (e.g. FLAPS indication, loss of fuel indications, etc.).
- (e) ‘Management of consequences’: System malfunctions that affect significantly the flight crew standard task sharing and/or the workload management and/or the decision-making process during an extensive period after the management of the malfunction itself (e.g. fuel leak or fuel not usable, altitude/speed limitations, malfunctions with ‘deferred’ items in later flight phases).

Note: Equivalency of malfunctions may be undertaken in consultation with the aircraft OEM. The objective of the OEM consultation is to review the operator analysis regarding the OEM operational certification (e.g. OSD) documents and the general OEM operation and training policy.

GM3 ORO.FC.231(f) Evidence-based training

ED Decision 2021/002/R

EQUIVALENCY OF MALFUNCTIONS — ISOLATION FROM AN ENVIRONMENTAL OR OPERATIONAL CONTEXT

When considering significant demand on a proficient crew, SMEs may consider that there are no significant environmental and operational threats. For example, the aircraft is close to a suitable aerodrome with environmental conditions permitting all published approaches to be made, with no pre-existing malfunctions and sufficient fuel for several hours (e.g. A320 or B737 overhead Ibiza - Spain, at FL350 with visible moisture at 30 000 ft, at the aerodrome wind calm, CAVOK, ISA).

GM4 ORO.FC.231(f) Evidence-based training

ED Decision 2021/002/R

EQUIVALENCY OF MALFUNCTIONS PROCESS — DELPHI

- (a) The operator reviews/looks at aircraft system malfunctions provided in the official documentation of the OEM — for example, FCOM for Airbus, or AFM for other manufacturers.
- (b) Before launching the equivalency of malfunctions survey and when the aircraft system malfunctions list is very long, the operator may slightly shorten the list by removing the malfunctions that surely will not place a significant demand of a proficient crew (see GM on SIGNIFICANT DEMAND ON A PROFICIENT CREW).
- (c) A group of EBT instructors statistically relevant will be selected to perform the equivalency of malfunctions survey. 50 % of the instructors' community will be used as a reference. In small instructors' communities, it may be necessary to refer to 100 %. In operators with large instructors' communities, the number of instructors statistically relevant may be less than 50 %.
- (d) The group of instructors selected in point (c) will rate each of the malfunctions listed in points (a) and (b)
 - (1) Each instructor will rate each one of the 5 characteristics in each malfunction listed in point (b).
 - (2) The rate will be 0 when the malfunction does not have the characteristic (the characteristic does not appear in the malfunction).
 - (3) The rate will be 1 to 5 when the characteristic appears in the malfunction. Rating 1 when the characteristic is not relevant for the malfunction and rate 5 when the characteristic is very relevant.
 - (4) The instructors will rate individually (e.g. home, classroom, etc.) to avoid exchange of opinions with other instructors.
- (e) An average rate of the whole instructors' community as a result of point (d) will be calculated for each characteristic of each malfunction.
- (f) A second round of survey will be performed with the same instructors and the same list. This time the operator will provide the average calculated in point (e) and ask them if in light of the average they would like to change their rating. Group discussion may substitute or complement the second survey.
- (g) When an instructor changes their rating, the old rate will be discarded.
- (h) A new average will be calculated for each characteristic of each malfunction at the end of the second survey. The final average will be rounded to the closest integer number.
- (i) The operator may select an average rate of the characteristics (e.g. rate 2 or 3) at which or above which the characteristic is considered to be present in the malfunction, thus it places a significant demand on a proficient crew.
- (j) The operator may use the rates of the characteristics to determine the difficulty of the malfunction. As SBT is a developing phase, the operator may select a higher difficulty of the malfunctions selected in this phase. Further guidance can be found in the EASA EBT manual.
- (k) The operator may refer to an aircraft OEM malfunction analysis to support all the steps of the session.

- (l) A simpler version of the process may be acceptable provided that:
- (1) the aircraft manufacturer provides equivalency of malfunction documentation;
 - (2) there is a minimum of three EBT instructors who have a deep knowledge of aircraft systems; and
 - (3) the instructors referred to in (2) above are properly standardised. The standardisation is based on the EBT programme design knowledge and in particular the concept, definitions and process of the equivalency of malfunctions. The simplified process may or may not use a survey and use either a two-point scale (0 and 1), three-point scale (1, 2 and 3) or five-point scale (1 to 5).

AMC1 ORO.FC.231(g) Evidence-based training

APPROACHES THAT PLACE AN ADDITIONAL DEMAND ON A PROFICIENT CREW

- (a) In order to identify approaches that place an additional demand on a proficient crew, an operator should:
- (1) review its operational network;
 - (2) select approaches with one or more of the following characteristics:
 - (i) unusual design;
 - (ii) low frequency of exposure; and
 - (iii) degraded approach guidance;
 - (3) select at least one approach of each type and method and include them in the EBT programme at the frequency given in the table of assessment and training topics; and
 - (4) ensure the approaches selected in (3) cover all the characteristics at the frequency given in the table of assessment and training topics.
- Note: The approaches listed within Section 2 of the table of assessment and training topics should be selected in this process.
- (b) Any approach that is required to be flown in the PF role specifically should be classified as 'skills retention' and may be trained in the MT.

AMC2 ORO.FC.231(g) Evidence-based training

ED Decision 2021/002/R

EQUIVALENCY OF APPROACHES RELEVANT TO OPERATIONS — SPECIFIC APPROVAL

The operator may extend the interval for recurrent training and checking of approaches that require specific approval as defined in the AMC to Part-SPA (e.g. SPA.LVO) to the frequency given in the EBT programme.

GM1 ORO.FC.231(g) Evidence-based training

ED Decision 2021/002/R

EQUIVALENCY OF APPROACHES RELEVANT TO OPERATIONS — APPROACH CHARACTERISTICS

The following may be considered suitable examples for each of the approach characteristics:

- (a) Design
 - (1) Unusual approach design feature — for example, offset final approach track or steep approach, etc.
 - (2) Unusual runway design feature — for example, non-standard lighting or marking
- (b) Frequency
 - (1) Infrequently visited airfields — for example, alternate airfields
 - (2) Infrequently flown approaches at commonly visited airfields — for example, circling approach, CAT 2, SA CATI
- (c) Degraded guidance
 - (1) Degraded internal guidance or aircraft equipment — for example, head-up display (HUD) failure
 - (2) Degraded external guidance or ground equipment — for example, GPS signal failure

GM2 ORO.FC.231(g) Evidence-based training

ED Decision 2021/002/R

SELECTED APPROACHES AT THE FREQUENCY GIVEN IN THE EBT PROGRAMME

The table of assessment and training topics for each generation provides the type of approach, flight method and frequency for the crew.

AMC1 ORO.FC.231(h) Evidence-based training

ED Decision 2021/002/R

LINE EVALUATION OF COMPETENCE

- (a) The purpose of the line evaluation of competence is to verify the capability of the flight crew member(s) to undertake line operations, including preflight and post-flight activities as specified in the operations manual. Therefore, the line evaluation of competence should be performed in the aircraft. The route should be representative of typical sectors undertaken in normal operations. The commander, or any pilot who may be required to relieve the commander, should also demonstrate their competency in the role.
- (b) Each flight crew member should be assessed according to the competency framework and grading system approved for their operator's EBT programme.
- (c) Flight crew members should be assessed in duties as pilot flying and pilot monitoring; they should be evaluated in each role. Therefore, they should be checked on one flight sector as pilot flying and on another flight sector as pilot monitoring.
- (d) The operator should maintain a list and inform the competent authority about the line evaluators suitably qualified to undertake line evaluations of competence.
- (e) The person that conducts the line evaluation of competence should occupy an observer's seat. For aeroplanes, in the case of long-haul operations where additional operating flight crew

members are carried, the person that conducts the line evaluation of competence may fulfil the function of a cruise relief pilot and should not occupy either pilot's seat during take-off, departure, initial cruise, descent, approach and landing.

- (f) The validity period should be counted from the end of the month when the line evaluation of competence was undertaken. When the line evaluation of competence is undertaken within the last 3 months of the validity period, the new validity period should be counted from the original expiry date.

AMC2 ORO.FC.231(h) Evidence-based training

ED Decision 2021/002/R

LINE EVALUATION OF COMPETENCE — LINE EVALUATOR

- (a) The line evaluator should have a valid line evaluation of competence.
- (b) The line evaluator should receive an acceptable training based on the EBT instructor training. The EBT assessment of competence is not required.

AMC1 ORO.FC.231(h)(3) Evidence-based training

ED Decision 2021/002/R

LINE EVALUATION OF COMPETENCE — EXTENSION OF THE VALIDITY

In order to extend the validity of the line evaluation of competence to:

- (a) 2 years, in every cycle, one EVAL for each pilot should be conducted by an EBT instructor (EBT instructors) who has (have) a valid line evaluation of competence in the same operator;
- (b) 3 years, in addition to point (a) above, the operator should have a feedback process for the monitoring of line operations which:
 - (1) identifies threats in the airline's operating environment;
 - (2) identifies threats within the airline's operations;
 - (3) assesses the degree of transference of training to the line operations;
 - (4) checks the quality and usability of procedures;
 - (5) identifies design problems in the human-machine interface;
 - (6) understands pilots' shortcuts and workarounds; and
 - (7) assesses safety margins.

GM1 ORO.FC.231(h) Evidence-based training

ED Decision 2021/002/R

LINE EVALUATION OF COMPETENCE

- (a) Line evaluation of competence, route and aerodrome knowledge, and recent experience requirements are intended to verify the capability of the flight crew member(s) to operate safely, effectively and efficiently under line operating conditions, including preflight and post-flight activities as specified in the operations manual. Other EBT assessments, legacy checks and emergency and safety equipment training are primarily intended to prepare flight crew members for abnormal/emergency procedures.

- (b) The line evaluation of competence is considered a particularly important factor in the development, maintenance and refinement of high operating standards, and can provide the operator with a valuable indication of the usefulness of its training policy and methods.

GM1 ORO.FC.231(h)(4) Evidence-based training

ED Decision 2021/002/R

LINE EVALUATOR

- (a) [AMC1.ORO.FC.146\(c\)](#) 'EBT instructor training' provides some learning objectives which may be used to qualify the commander nominated by the operator to perform line evaluation of competence. The training may be a minimum of 7 hours, where 1 hour may be done outside the classroom. The use of advance training environments such as advance computer-based training or ABLE may reduce further the need of classroom training. The assessment of competence may not be required. Further guidance can be found in the EASA EBT manual.
- (b) The line evaluator training may be included in the EBT instructor standardisation and concordance programme. This option is however limited due to the limited number of line evaluations of competence that are required (every 2 or 3 years), the difficulties in observing the whole range of performance of competencies and the lack of control of the environment during a line evaluation of competence. Therefore, the operator may need to use EBT instructors to maintain an acceptable level of standardisation.

AMC1 ORO.FC.231(i) Evidence-based training

ED Decision 2021/002/R

PERFORMANCE-BASED CONTINUOUS TECHNICAL GROUND TRAINING

- (a) Technical ground training programme
- (1) The objective of the technical ground training programme is to ensure that pilots have adequate:
- (i) knowledge of:
 - (A) the aircraft systems; and
 - (B) the operational procedures and requirements; and
 - (ii) awareness of:
 - (A) the most significant accidents or incidents that could affect their operations following the 'threat and error management model' or an alternative risk model agreed with the authority; and
 - (B) the occurrences in the airline or occurrences from other airlines that may be relevant for their operations, accident/incident and occurrence review.
- (2) The technical ground training should:
- (i) be conducted as part of a 3-year programme;
 - (ii) allow a customisation of syllabi. The operator should describe in the operations manual the procedure to determine the customisation of syllabi. This customisation should be based on evidence both internal and external to the operator.

- (iii) as a minimum, allow the pilot to receive technical ground training every 12 months. The validity period should be counted from the end of the month. When this training is conducted within the last 3 months of the validity period, the new validity period should be counted from the original expiry date.
 - (3) The technical ground training syllabi should be delivered using different methods and tools.
 - (i) The selection of the method and tool results from a combination of the learning objectives and the target group receiving the training (WHAT needs to be trained and WHO needs to be trained).
 - (ii) The selection of the appropriate method and tool should be driven by the desired outcome in terms of adequate knowledge.
 - (iii) The delivery of the technical ground training syllabi should include the methods or tools to verify if the pilot has acquired the objective of the technical ground training programme. This may be achieved by means a questionnaire, assessment of application of the competency 'knowledge' (KNO) or other suitable methods.
 - (4) The measurement and evaluation of the training system performance through the feedback process should include the performance of the technical ground training.
- (b) Emergency and safety equipment training
- (1) Training on the location and use of all emergency and safety equipment should be conducted in an aircraft or a suitable alternative training device.
 - (2) Every year the emergency and safety equipment training programme should include the following:
 - (i) actual donning of a life jacket, where fitted;
 - (ii) actual donning of protective breathing equipment, where fitted;
 - (iii) actual handling of fire extinguishers of the type used;
 - (iv) instruction on the location and use of all emergency and safety equipment carried on the aircraft;
 - (v) instruction on the location and use of all types of exits; and
 - (vi) security procedures.
 - (3) Every 3 years the programme of training should include the following:
 - (i) actual operation of all types of exits;
 - (ii) demonstration of the method used to operate a slide, where fitted;
 - (iii) actual firefighting using equipment representative of that carried on the aircraft on an actual or simulated fire except that, with Halon extinguishers, an alternative extinguisher may be used;
 - (iv) the effects of smoke in an enclosed area and actual use of all relevant equipment in a simulated smoke-filled environment;
 - (v) actual handling of pyrotechnics, real or simulated, where applicable;
 - (vi) demonstration in the use of the life rafts, where fitted; and

- (vii) particularly in the case where no cabin crew is required, first aid appropriate to the aircraft type, the kind of operation and the crew complement.
 - (4) The successful resolution of aircraft emergencies requires interaction between flight crew and cabin/technical crew and emphasis should be placed on the importance of effective coordination and two-way communication between all crew members in various emergency situations.
 - (5) Emergency and safety equipment training should include joint practice in aircraft evacuations so that all who are involved are aware of the duties other crew members should perform. When such practice is not possible, combined flight crew and cabin/technical crew training should include joint discussion of emergency scenarios.
 - (6) Emergency and safety equipment training should, as far as practicable, take place in conjunction with cabin/technical crew undergoing similar training with emphasis on coordinated procedures and two-way communication between the flight crew compartment and the cabin.
 - (7) The emergency and safety equipment training should include a pilot's assessment of the training received; as a minimum, by means of a questionnaire, or computer-based exercises, or other suitable methods.
 - (8) When the emergency and safety equipment training is conducted within 3 calendar months prior to the expiry of the 12-calendar-month period, the next emergency and safety equipment training should be completed within 12 calendar months of the original expiry date of the previous training.
- (c) Emergency and safety equipment training — extension of period of training
- (1) The emergency and safety equipment training programme should establish and maintain at least an equivalent level of proficiency achieved by complying with the provisions of (b). The level of flight crew proficiency in the use of emergency and safety equipment should be demonstrated prior to being granted approval to extend the period of training by the competent authority.
 - (2) The operator applying for an approval to extend the period of emergency and safety equipment training should provide the competent authority with an implementation plan, including a description of the level of flight crew proficiency to be achieved in the use of emergency and safety equipment. The implementation plan should comprise the following:
 - (i) A safety case which should:
 - (A) demonstrate that the required or equivalent level of proficiency in the use of emergency and safety equipment is maintained;
 - (B) incorporate the programme of implementation, to include controls and validity checks;
 - (C) minimise risk during all phases of the programme's implementation and operation; and
 - (D) include oversight, including review and audits.
 - (ii) The measurement and evaluation of the training system performance through the feedback process should include the performance of the emergency and safety equipment training. The feedback should be used as a tool to validate that the emergency and safety equipment training is correctly implemented; this enables

substantiation of the emergency and safety equipment training and ensures that objectives have been met.

- (iii) Documentation that details the scope and requirements of the programme, including the following:
 - (A) the operator's training needs and established operational and training objectives;
 - (B) a description of the process for designing and obtaining approval for the operator's emergency and safety equipment training programmes. This should include quantified operational and training objectives identified by the operator's internal monitoring programmes. External sources may also be used; and
 - (C) a description of how the programme will develop a support and feedback process to form a self-correcting training system.
- (3) When the emergency and safety equipment training is conducted within 6 calendar months prior to the expiry of the 24-calendar-month period, the next emergency and safety equipment training should be completed within 24 calendar months of the original expiry date of the previous training.

GM1 ORO.FC.231(i) Evidence-based training

ED Decision 2021/002/R

PERFORMANCE-BASED CONTINUOUS GROUND TRAINING — INTERNAL AND EXTERNAL EVIDENCE

- (a) Operator evidence (inner loop)
 - (1) Pilot data (individual or group);
 - (2) Population-based data according to the training metrics determined in the training system performance;
 - (3) Evidence identified or recognised through the safety management process covered in [ORO.GEN.200](#).
- (b) External evidence from the authority and manufacturers (external loop)
 - (1) Revision of existing rules and regulations, updated versions of the EBT data report, state safety plan;
 - (2) Training needs derived from updated OSD (if appropriate for ground training), etc.
- (c) The evidence drives the selection of the methods and tools.

GM2 ORO.FC.231(i) Evidence-based training

ED Decision 2021/002/R

PERFORMANCE-BASED CONTINUOUS GROUND TRAINING — METHODS AND TOOLS

This is a non-exhaustive list of methods and tools to deliver ground training:

- classroom, presentations,
- web-based training,
- self-learning instructions,

- advance CBT such as virtual reality, chatbots, interactive scenario trainers.

ORO.FC.232 EBT programme assessment and training topics

Regulation (EU) 2020/2036

- (a) The operator shall ensure that each pilot is exposed to the assessment and training topics.
- (b) The assessment and training topics shall be:
 - (1) derived from safety and operational data that are used to identify the areas for improvement and prioritisation of pilot training to guide in the construction of suitable EBT programmes;
 - (2) distributed across a 3-year period at a defined frequency;
 - (3) relevant to the type or variant of aircraft on which the pilot operates.

AMC1 ORO.FC.232 EBT programme assessment and training topics

ED Decision 2021/002/R

ASSESSMENT AND TRAINING TOPICS

Each table of assessment and training topics is specific to the aeroplane generation specified in the title. The component elements in the column headings of the matrix are as follows:

- (a) Assessment and training topic. A topic or grouping of topics derived from threats, errors or findings from data analysis, to be considered for assessment and mitigation by training.
- (b) Frequency. The priority of the topic to be considered in an EBT programme, according to the evidence derived from a large-scale analysis of operational data, is linked to a recommended frequency. There are three levels of frequency:
 - (1) A — assessment and training topic to be included with defined scenario elements during every EBT module;
 - (2) B — assessment and training topic to be included with defined scenario elements during every cycle;
 - (3) C — assessment and training topic to be included with defined scenario elements at least once in the 3-year period of the EBT programme.
- (c) Flight phase for activation. The flight phase for the realisation of the critical threat or error in the assessment and training scenario.
- (d) Description (includes type of topic, being threat, error or focus). A description of the training topic.
- (e) Desired outcome (includes performance criteria or training outcome). Simple evaluative statements on the desired outcome.
- (f) Example scenario elements (guidance material). The example scenario elements address the training topic and detail the threat and/or error that the crew are exposed to.
- (g) Competency map. Competencies marked are those considered critical in managing the scenario.

AMC2 ORO.FC.232 EBT programme assessment and training topics

ED Decision 2022/014/R

GENERATION 4 (JET) — TABLE OF ASSESSMENT AND TRAINING TOPICS

Assessment and training topic		Frequency	Description (includes type of topic, being threat, error or focus)	Desired outcome (includes performance criteria OR training outcome)	Flight phase activation	Guidance material (GM) Example scenario elements	PRO	COM	FPA	FPM	LTW	PSD	SAW	WLM	KNO
Generation 4 Jet — Recurrent assessment and training matrix							Competency map								
Section 1 — Skill retention. Manoeuvres training phase (MT)															
MT	Rejected take-off	B	Rejected take-off after the application of take-off thrust and before reaching V1 (CAT I or above)	Demonstrate manual aircraft control skills with smoothness and accuracy as appropriate to the situation. Detect deviations through instrument scanning. Maintain spare mental capacity during manual aircraft control. Maintain the aircraft within the flight envelope. Apply knowledge of the relationship between aircraft attitude, speed and thrust.	TO	From initiation of take-off to complete stop (or as applicable to the procedure)	x			x					
	Failure of the critical engine between V1 and V2	B	Failure of the critical engine (if applicable) from V1 and before reaching V2 in the lowest CAT I visibility or in LVO meteorological (MET) conditions.		TO	The manoeuvre is complete at a point when the aircraft is stabilised at normal engine-out climb speed with the correct pitch and lateral control, in trim condition and, as applicable, autopilot engagement. Only one failure of the critical engine between V1 and V2 a year may be done in LVO conditions.	x			x					
	Failure of one engine on take-off	B	Failure of one engine from V1 and before reaching V2 in the lowest CAT I visibility or in LVO MET conditions.		TO	The manoeuvre is complete at a point when the aircraft is stabilised in a clean configuration with engine-out procedures completed. Only one failure of the critical engine between V1 and V2 a year may be done in LVO conditions.	x			x					
			Failure of one engine above V2 (any segment of the TO)			The manoeuvre is complete at a point when the aircraft is stabilised in a clean	x		x	x					

			in the lowest CAT I visibility or in LVO MET conditions.		configuration with engine-out procedures completed.											
Emergency descent	C		Initiation of emergency descent from normal cruise altitude	CRZ	The manoeuvre is complete once the aircraft is stabilised in emergency descent configuration (and profile). However, if the EBT programme does not include the example scenario element ‘emergency descent’ in the training topic ‘automation management’, the emergency descent procedures should be completed and should not stop once the aircraft is stabilised in emergency descent configuration.	x		x	x							
Engine-out approach & landing	B		With the critical engine (if applicable) failed, normal landing	LDG	Initiation in a stabilised engine-out configuration from not less than 3 NM final approach, until completion of roll-out	x			x							
Engine-out approach & go-around	B		With the critical engine (if applicable) failed, manually flown normal precision approach to DA, followed by a manual go-around – the whole manoeuvre to be flown without visual reference	APP	This manoeuvre should be flown from intercept to centreline until acceleration after go-around. The manoeuvre is complete at a point when the aircraft is stabilised at normal engine-out climb speed with the correct pitch and lateral control, in trim condition and, as applicable, autopilot engagement (describe generally the critical part of the manoeuvre).	x			x							
Go-around	A		Go-around, all engines operative	APP	High energy, initiation during the approach at 150 to 300 m (500 to 1 000 ft) below the missed approach level-off altitude	x		x	x							
					Initiation of a go-around from DA followed by visual circuit and landing	x		x	x							
					During flare/rejected landing	x		x	x							

	Pilot qualification to operate in either pilot's seat	B	As per ORO.FC.235		APP	Complete the manoeuvres mandated in ORO.FC.235.	Intentionally left in blank.
--	---	---	-------------------	--	-----	---	------------------------------

Assessment and training topic	Frequency	Description (includes type of topic, being threat, error or focus)	Desired outcome (includes performance criteria OR training outcome)	Flight phase activation	Guidance material (GM) Example scenario elements	PRO	COM	FPA	FPM	LTW	PSD	SAW	WLM	KNO
Generation 4 Jet — Recurrent assessment and training matrix						Competency map								
Section 2 — Equivalency of approaches relevant to operations. Evaluation phase, manoeuvres training phase or scenario-based training phase (EVAL, MT or SBT)														
MT	Approach type A or B	B	Approach type A or B flight method 3D	See equivalency of approaches relevant to operations that place an additional demand on a proficient crew	APP	See equivalency of approaches relevant to operations	x		x	x			x	X
	Approach type A	B	Approach type A flight method 2D	See equivalency of approaches relevant to operations that place an additional demand on a proficient crew	APP	See equivalency of approaches relevant to operations	x		x	x			x	X
EVAL or SBT	Approach type A	B	Approach type A flight method 3D or 2D	See equivalency of approaches relevant to operations that place an additional demand on a proficient crew	APP	See equivalency of approaches relevant to operations	x		x	x			x	X
	Approach type B	B	Approach type B flight method 3D	See equivalency of approaches relevant to operations that place an additional demand on a proficient crew	APP	See equivalency of approaches relevant to operations	x		x	x			x	X

Section 3 – Equivalency of approaches under specific approvals and take-off under specific approvals. Evaluation phase, manoeuvres training phase or scenario-based training phase (EVAL, MT or SBT)													
MT	SPA approach(es)	B	Approach requiring specific approval	See equivalency of approaches relevant to operations — specific approval	APP	Approaches flown from FAF to landing or go-around	x		x	x			
EVAL or SBT	SPA approach(es)	B	Approach requiring specific approval	See equivalency of approaches relevant to operations — specific approval	APP	Approaches flown from FAF to landing or go-around	x		x	x			
EVAL, MT or SBT	SPA rejected take-off (RTO)	B	<p>Engine failure after the application of take-off thrust and before reaching V1 (in low-visibility MET conditions, preferably in the lowest approved visibility) Low-visibility RTO is not required under Part SPA but instead in Appendix 9 Section 6.</p> <p>Note: AMC1 SPA.LVO.120 point (f) does not require a low-visibility RTO.</p> <p>RTO is required only in the initial LVO course (point (g)(1)(iii) of AMC1 SPA.LVO.120).</p>	<p>Demonstrate manual aircraft control skills with smoothness and accuracy as appropriate to the situation. Detect deviations through instrument scanning. Maintain spare mental capacity during manual aircraft control. Maintain the aircraft within the flight envelope. Apply knowledge of the relationship between aircraft attitude, speed and thrust.</p>	TO	RTO — can be combined with the assessment and training topic ‘surprise’ in EVAL or SBT	x			x			

EVAL, MT or SBT	LVTO	B	Notwithstanding AMC1 SPA.LVO120 point (f)(1) AMC1 SPA.LVO.120 requires SPA manoeuvres in the frequency of the OPC, as OPC is substituted in the EBT programme. Thus, the frequency in EBT is determined in every cycle (B). Low-visibility take-off, preferably in the lowest approved visibility.	TO	The manoeuvre is complete at a point when the aircraft is stabilised at normal climb speed with the correct pitch and lateral control, in trim condition and, as applicable, autopilot engagement.	x					x							

Assessment and training topic	Frequency	Flight phase activation	Description (includes type of topic, being threat, error or focus)	Desired outcome (includes performance criteria OR training outcome)	Guidance material (GM) Example scenario elements	PRO	COM	FPA	FPM	LTW	PSD	SAW	WLM	KNO	
						Competency map									
Generation 4 Jet — Recurrent assessment and training matrix															
Section 4 — Training topics with frequency (A) in alphabetical order. Evaluation phase or scenario-based training phase (EVAL or SBT)															
EVAL or SBT	Adverse weather	A	GND	Thunderstorm, heavy rain, turbulence, ice build-up to include de-icing issues, as well as high-temperature conditions. The proper use of anti-ice and de-icing systems should be included generally in appropriate scenarios.	Anticipate adverse weather. Prepare for suspected adverse weather. Recognise adverse weather. Take appropriate action. Apply the appropriate procedure correctly. Assure aircraft control.	Predictive wind shear warning before take-off, as applicable	x	x				x			
			ALL			Adverse-weather scenario, e.g. thunderstorm activity, precipitation, icing			x	x		x			
			TO			Wind shear encounter during take-off, not predictive	x			x			x		X
			TO			Predictive wind shear warning during take-off	x	x					x	x	
			TO			Crosswinds with or without strong gusts on take-off	x			x					
			CRZ			Turbulence that increases to severe turbulence		x		x			x	x	
			CRZ			Wind shear encounter scenario during cruise	x		x				x	x	x

Assessment and training topic		Frequency	Flight phase activation	Description (includes type of topic, being threat, error or focus)	Desired outcome (includes performance criteria OR training outcome)	Guidance material (GM) Example scenario elements	PRO	COM	FPA	FPM	LTW	PSD	SAW	WLM	KNO				
			APP			Reactive wind shear warning during approach or go-around	x		x	x			x						
			APP			Predictive wind shear warning during approach or go-around	x	x				x	x						
			APP			Thunderstorm encounter during approach or on missed approach	x						x	x					
			APP			Increasing tailwind on final approach (not reported)	x	x					x	x					
			APP			Approach and landing in demanding weather conditions, e.g. turbulence, up and downdrafts, gusts and crosswinds including shifting wind directions							x		x	x			
			APP			Non-precision approach in cold-temperature conditions, requiring altitude compensation for temperature, as applicable to the type	x	x								x			
			APP LDG			Crosswinds with or without strong gusts on approach, final approach and landing (within and beyond limits)	x						x		x				
			APP			In approach, unexpected braking action 'good to medium' reported by the preceding aircraft						x				x	x	x	
			APP			Moderate to severe icing conditions during approach effecting aircraft performance	x	x								x	x		
			APP			Reduced visibility even after acquiring the necessary visual reference during approach, due to rain or fog	x	x								x			
EVAL or SBT	Automation management	A	CLB CRZ DES APP	The purpose of this topic is to encourage and develop effective flight path management through	Know how and when to use the flight management system(s), guidance and automation.	ACAS warning (resolution advisory), recovery and subsequent engagement of automation	x		x										

Assessment and training topic	Frequency	Flight phase activation	Description (includes type of topic, being threat, error or focus)	Desired outcome (includes performance criteria OR training outcome)	Guidance material (GM) Example scenario elements	PRO	COM	FPA	FPM	LTW	PSD	SAW	WLM	KNO			
		ALL	<p>proficient and appropriate use of the flight management system(s), guidance and automation, including transitions between modes, monitoring, mode awareness, vigilance and flexibility needed to change from one mode to another. The means of mitigating errors are included in this topic. The errors are described as mishandled auto flight systems, inappropriate mode selection, mishandled flight management system(s) and inappropriate autopilot usage.</p>	<p>Demonstrate correct methods for engagement and disengagement of the auto flight system(s). Demonstrate appropriate use of flight guidance, auto thrust and other automation systems. Maintain mode awareness of the auto flight system(s), including engagement and automatic transitions. Revert to different modes when appropriate. Detect deviations from the desired aircraft state (flight path, speed, attitude, thrust, etc.) and take appropriate action. Anticipate mishandled auto flight system. Recognise mishandled auto flight system. Take appropriate action if necessary. Restore correct auto flight state.</p>	FMS tactical programming issues, e.g. step climb, runway changes, late clearances, destination re-programming, executing diversion	x		x							X		
		CLB CRZ DES APP			Recoveries from terrain avoidance warning systems (TAWS), management of energy state to restore automated flight	x			x	x							
		CLB CRZ DES APP			Amendments to ATC cleared levels during altitude capture modes to force mode awareness and intervention	x			x					x			
		TO			ACAS warning (resolution advisory to level off) during climb or descent; for example, close to the cleared level when the capture mode has already been activated.	x			x					x			
		TO APP			Late ATC clearance to an altitude below acceleration altitude	x			x					x			
		CRZ			Engine-out special terrain procedures	x			x					x			
		CRZ			Forcing autopilot disconnect followed by re-engagement, recovery from low- or high-speed events in cruise	x			x	x				x			
		CLB			Engine failure during or after initial climb using automation	x			x								
		CRZ			Engine failure in cruise to onset of descent using automation	x			x								
		CRZ			Emergency descent	x			x								X
		DES APP			Managing high-energy descent capturing descent path from above (correlation with unstable approach training)	x			x					x			X

Assessment and training topic		Frequency	Flight phase activation	Description (includes type of topic, being threat, error or focus)	Desired outcome (includes performance criteria OR training outcome)	Guidance material (GM) Example scenario elements	PRO	COM	FPA	FPM	LTW	PSD	SAW	WLM	KNO				
			APP		Identify and manage consequences.	No ATC clearance received prior to commencement of approach or final descent	x		x				x						
			APP			Reactive wind shear and recovery from the consequent high-energy state	x		x				x						
			APP			Automation fail to capture the approach altitude in descent (e.g. last altitude before the FAP). Ideally, the failure occurs when the workload is high (e.g. configuration of the aircraft for final approach).							x	x	x	x			
			APP			Non-precision or infrequently flown approaches using the maximum available level of automation	x		x								X		
			APP			Gear malfunction during an approach planned with autoland (including autobrake). Competency FPA may or may not be included depending on the impact of such malfunction on the automation.			x	x				x		x			
			APP			ATC clearances to waypoints beyond the programmed descent point for a coded final descent point during an approach utilising a final descent that is commanded by the flight management system	x		x								x		X
			APP																
EVAL or SBT	Competencies —non-technical (CRM)	A	APP	This encapsulates the general CRM principles and objectives. It includes communication; leadership and teamwork; problem-solving and decision-making; situation awareness and	Exposure to an event or sequence of events to allow the pilot to build awareness of human factors in aviation and the human limitations.	GPS failure prior to commencement of approach associated with position drift and a terrain alert					x	x	x		X				
			DES			Cabin crew report of water noise below the forward galley indicating a possible toilet pipe leak, with consequent avionics failures					x	x	x						
			CRZ			Smoke removal but combined with a diversion until landing is completed.		x			x	x	x	x	X				

Assessment and training topic	Frequency	Flight phase activation	Description (includes type of topic, being threat, error or focus)	Desired outcome (includes performance criteria OR training outcome)	Guidance material (GM) Example scenario elements	PRO	COM	FPA	FPM	LTW	PSD	SAW	WLM	KNO			
		GND	management of information; and workload management. Emphasis should be placed on the development of leadership, shown by EBT data sources to be a highly effective competency in mitigating risk and improving safety through pilot performance.	This includes the development of the following competencies: Communication: Demonstrate: — effective use of language; — responsiveness to feedback; and — capability to state the plans and resolve ambiguities. Leadership and teamwork: Use appropriate authority to ensure focus on the task. Support others in completing tasks. Problem-solving and decision-making: Detect deviations from the desired state, evaluate problems, identify the risk, consider alternatives and select the best course of action. Continuously review	Apron fuel spilling					x	x		x				
		CRZ			Important water leak in an aircraft galley		x			x	x			x			
		ALL			A relevant number of cabin crew are wounded or incapacitated. Additionally, the cabin crew wounded or incapacitated are the most competent (e.g. senior cabin crew member).						x	x			x		
		ALL			Unruly passenger(s)					x					x		
		GND			Passenger oxygen: passenger service unit open and mask falling down							x	x			x	
		ALL			Passenger with medical problems — medical emergency							x				x	
		CRZ			Credible threat reported to the crew. Stowaway or fugitive on board.			x				x			x	x	
		GND			No METAR or TAFOR is available for destination due to industrial action at the destination airport.	x	x					x	x				
		CRZ			Credible bomb threat reported to crew			x				x			x	x	
		CLB DES			Credible bomb threat or pressurisation problem, but no quick landing possible (due to weather, terrain or other reasons)			x				x	x				x
		APP			Diversion with low remaining fuel or increased fuel flow due to system malfunction	x						x			x	x	
		APP			ACAS warning (resolution advisory) immediately following a go-around, with a descent manoeuvre required. (The RA should be a command for descent when the aircraft is above 1 100 ft AGL.)						x		x	x	x	x	

Assessment and training topic		Frequency	Flight phase activation	Description (includes type of topic, being threat, error or focus)	Desired outcome (includes performance criteria OR training outcome)	Guidance material (GM) Example scenario elements	PRO	COM	FPA	FPM	LTW	PSD	SAW	WLM	KNO
					<p>progress and adjust plans.</p> <p>Situation awareness and management of information:</p> <p>Have an awareness of the aircraft state in its environment; project and anticipate changes.</p> <p>Workload management:</p> <p>Prioritise, delegate and receive assistance to maximise focus on the task. Continuously monitor the flight progress.</p>										
<p>EVAL or SBT</p>	<p>Compliance</p>	<p>A</p>	<p>ALL</p>	<p>Compliance failure. Consequences of not complying with operating instructions (e.g. SOPs). This is not intended to list example scenario elements, but instructors should ensure that observed non-compliances are taken as learning opportunities throughout the programme. In all modules of the programme, the FSTD</p>	<p>Recognise that a compliance failure has occurred.</p> <p>Make a verbal announcement.</p> <p>Take appropriate action if necessary.</p> <p>Restore safe flight path if necessary.</p> <p>Manage consequences.</p>	<p>The following are examples of potential compliance failures and are not intended to be developed as scenarios as part of an EBT module:</p> <ol style="list-style-type: none"> Requesting flap beyond limit speed Flaps or slats in the wrong position for phase of flight or approach Omitting an action as part of a procedure 	<p>Intentionally blank</p>								

Assessment and training topic		Frequency	Flight phase activation	Description (includes type of topic, being threat, error or focus)	Desired outcome (includes performance criteria OR training outcome)	Guidance material (GM) Example scenario elements	PRO	COM	FPA	FPM	LTW	PSD	SAW	WLM	KNO				
				should as far as possible be treated like an aircraft, and non-compliances should not be accepted simply for expediency.		4. Failing to initiate or complete a checklist 5. Using the wrong checklist for the situation													
EVAL or SBT	Go-around management	A	APP	Any threat or error that can result in circumstances that require a decision to perform a go-around, in addition to the execution of the go-around. Go-around scenarios should be fully developed to encourage effective leadership and teamwork, in addition to problem-solving and decision-making, plus execution using manual aircraft control or the flight management system(s) and automation as applicable. Design should include the element of surprise, and scenario-based go-arounds should not be predictable and anticipated. This topic is completely distinct from		Adverse-weather scenario leading to a reactive wind shear warning during approach	x	x					x	x					
			APP			Adverse-weather scenario leading to a predictive wind shear warning during approach or go-around	x	x					x	x					
			APP			Adverse-weather scenario, e.g. thunderstorm activity, heavy precipitation or icing forcing decision at or close to DA/MDA	x						x	x	x				
			APP			DA with visual reference in heavy precipitation with doubt about the runway surface braking capability	x								x	x	x		
			APP			Adverse-wind scenario resulting in increasing tailwind below DA (not reported)			x						x				
			APP			Adverse-wind scenario including strong gusts and/or crosswind out of limits below DA (not reported)			x						x				
			APP			Adverse-wind scenario including strong gusts and/or crosswind out of limits below 15 m (50 ft) (not reported)			x						x				
			APP			Lost or difficult communications resulting in no approach clearance prior to commencement of approach or final descent	x			x							x		
			APP			Birds: large flocks of birds below DA once visual reference has been established				x						x	x		

Assessment and training topic		Frequency	Flight phase activation	Description (includes type of topic, being threat, error or focus)	Desired outcome (includes performance criteria OR training outcome)	Guidance material (GM) Example scenario elements	PRO	COM	FPA	FPM	LTW	PSD	SAW	WLM	KNO
			APP	the go-around manoeuvre listed in the MT section that is intended only to practise psychomotor skills and a simple application of the procedures.		System malfunction, landing gear malfunction during the approach									
EVAL or SBT	Manual aircraft control	A	CLB CRZ DES APP	Controls the flight path through manual control	<p>Demonstrate manual aircraft control skills with smoothness and accuracy as appropriate to the situation.</p> <p>Detect deviations through instrument scanning.</p> <p>Maintain spare mental capacity during manual aircraft control.</p> <p>Maintain the aircraft within the normal flight envelope.</p> <p>Apply knowledge of the relationship between aircraft attitude, speed and thrust.</p>	Flight with unreliable airspeed, which may or may not be recoverable	x			x			x		X
			CLB CRZ DES APP			Alternate flight control modes according to malfunction characteristics	x			x				x	X
			CLB CRZ DES APP			ACAS warning (resolution advisory) requires the pilot to descend or ATC calls for immediate descent (preferably during climb which requires a significant change in aircraft attitude).	x	x		x					
			CLB CRZ DES APP			ACAS warning (resolution advisory) requires the pilot to climb or ATC calls for immediate climb (preferably during descent which requires a significant change in aircraft attitude).	x	x		x					
			DES			TAWS warning when deviating from planned descent routing, requiring immediate response	x			x	x				
			TO			Scenario immediately after take-off which requires an immediate and overweight landing			x	x	x	x			
			TO			Adverse wind, crosswinds with or without strong gusts on take-off	x			x					

Assessment and training topic		Frequency	Flight phase activation	Description (includes type of topic, being threat, error or focus)	Desired outcome (includes performance criteria OR training outcome)	Guidance material (GM) Example scenario elements	PRO	COM	FPA	FPM	LTW	PSD	SAW	WLM	KNO
EVAL or SBT			TO			Adverse weather, wind shear, wind shear encounter during take-off, with or without reactive warnings	x			x			x		
			TO			Engine failure during initial climb, typically 30-60 m (100-200 ft) (autopilot off)	x	x		x				x	
			CRZ			Wind shear encounter scenario during cruise, significant and rapid change in wind speed or down/updrafts, without wind shear warning	x		x			x	x	x	
			APP			Adverse weather, wind shear, wind shear encounter with or without warning during approach	x		x	x			x		
			APP			Adverse weather, deterioration in visibility or cloud base, or adverse wind, requiring a go-around from visual circling approach, during the visual segment	x	x	x	x		x	x	x	
			APP			Interception of the glide slope from above (correlation with unstable approach training)			x				x	x	
			APP LDG			Adverse wind, crosswinds with or without strong gusts on approach, final approach and landing (within and beyond limits)	x			x		x			
			APP LDG			Adverse weather, adverse wind, approach and landing in demanding weather conditions, e.g. turbulence, up and downdrafts, gusts and crosswinds including shifting wind directions				x		x	x		
			APP LDG			Circling approach manually flown at night in minimum in-flight visibility to ensure ground reference, minimum environmental lighting and no glide slope guidance lights	x			x				x	x

Assessment and training topic		Frequency	Flight phase activation	Description (includes type of topic, being threat, error or focus)	Desired outcome (includes performance criteria OR training outcome)	Guidance material (GM) Example scenario elements	PRO	COM	FPA	FPM	LTW	PSD	SAW	WLM	KNO			
			APP LDG			Runway incursion during approach, which can be triggered by ATC at various altitudes or by visual contact during the landing phase	x			x			x					
			LDG			Adverse wind, visibility, type-specific, special consideration for long-bodied aircraft, landing in minimum visibility for visual reference, with crosswind	x	x		x			x					
			LDG			System malfunction, auto flight failure at DA during a low-visibility approach requiring a go-around flown manually	x		x	x			x					
			APP LDG			Approach planned with autoland, followed by a failure below 1 000 ft requiring a manual go-around and an immediate landing due to fuel shortage	x		x		x				x			
			TO			In-seat instruction: Insufficient engine failure recovery, forcing the pilot monitoring to take over the flight controls		x		x				x	x			
			APP LDG			In-seat instruction: Unstable approach on short final or long landing, forcing the pilot monitoring to take over the flight controls		x		x					x	x		
EVAL or SBT	Monitoring, cross-checking, error management, mismanagement	A	ALL	The scenarios should be realistic and relevant, and should be used for the purpose of demonstration and reinforcement of effective monitoring.	Recognise mismanaged aircraft state. Observe the pilot's behaviour: how the pilot is mitigating errors, performing cross-checking, monitoring performance and	Deviations from the flight path, in pitch attitude, speed, altitude, bank angle		x					x					
			ALL			In-seat instruction: Simple automation errors (e.g. incorrect mode selection, attempted engagement without the necessary conditions, entering wrong altitude or speed, failure to execute the desired mode) culminating in a need for direct intervention		x						x				

Assessment and training topic		Frequency	Flight phase activation	Description (includes type of topic, being threat, error or focus)	Desired outcome (includes performance criteria OR training outcome)	Guidance material (GM) Example scenario elements	PRO	COM	FPA	FPM	LTW	PSD	SAW	WLM	KNO
Managed aircraft state		APP	LDG	<p>Modules in the FSTD should be treated like those in an aircraft so that trainees have the opportunity to develop the competency with the practice of the right techniques and attitudes related to these topics through pilot performance, and that instructors have the opportunity to assess and train these topics in a realistic environment. As shown by the EBT data report, these topics are of key importance to improve safety in operations.</p> <p>In addition, the operator may also use these topics to develop scripted role-playing scenarios in the form of ISI. These scenarios cater for the need to monitor flight path excursions from the instructor pilot (PF), detect errors and make</p>	<p>dealing with a mismanaged aircraft state, in order to ensure that observed deviations, errors and mistakes are taken as learning opportunities throughout the programme. Monitor flight path excursions. Detect errors and threats through proper cross-checking performance. Make appropriate interventions either verbally or by taking control if applicable. Take appropriate action if necessary. Restore the desired aircraft state. Identify and manage consequences.</p>	from the pilot monitoring, and where necessary taking control.									
						In-seat instruction: Unstable approach or speed/path/vertical rate not congruent with the required state for the given flight condition	x	x					x	x	
						In-seat instruction: Demonstration exercise — recovery from bounced landing, adverse wind, strong gusts during landing phase, resulting in a bounce and necessitating recovery action from the pilot monitoring	x							x	

Assessment and training topic		Frequency	Flight phase activation	Description (includes type of topic, being threat, error or focus)	Desired outcome (includes performance criteria OR training outcome)	Guidance material (GM) Example scenario elements	PRO	COM	FPA	FPM	LTW	PSD	SAW	WLM	KNO
Unstable approach	A			appropriate interventions, either verbally or by taking control as applicable. Demonstration scenarios may also be used. Demonstrated role-play should contain realistic and not gross errors, leading at times to a mismanaged aircraft state, which can also be combined with upset management training.											
		DES APP	Reinforce stabilised approach philosophy and adherence to defined parameters. Encourage go-arounds when crews are outside these parameters. Develop and sustain competencies related to the management of high-energy situations.	ATC or terrain-related environment creating a high-energy descent with the need to capture the optimum profile to complete the approach in a stabilised configuration	x		x						x		
		DES APP		ATC or terrain-related environment creating a high-energy descent leading to unstable conditions and requiring a go-around	x		x						x		
		APP		Approach and landing in demanding weather conditions, e.g. turbulence, up and downdrafts, gusts and crosswinds including shifting wind directions					x				x	x	
		APP		Increasing tailwind on final approach (not reported)	x	x							x	x	
		APP LDG		Crosswinds with or without strong gusts on approach, final approach and landing (within and beyond limits)	x				x				x		

Section 5 — UPRT training topic with frequency (B). Evaluation phase, manoeuvres training phase or scenario-based training phase (EVAL, MT or SBT)																
EVAL, MT or SBT	Upset prevention training	B	N/A	Compliance with AMC1 or AMC2 to ORO.FC.220&230	Early recognition and prevention of upset conditions. When the differences between LHS and RHS are not significant in the handling of the aircraft, UPRT may be conducted in either seat.	See Table 1 of AMC1 ORO.FC.220&230: Elements and respective components of upset prevention training.	Intentionally blank									
			CRZ	Include upset prevention elements in Table 1 for the recurrent training programme in at least every cycle, such that all the elements are covered over a period not exceeding 3 years. The elements are numbered with letters from A to I in Table 1 of AMC1 ORO.FC.220&230. Each element is made up of several numbered components.		Demonstration of the defined normal flight envelope and any associated changes in flight instruments, flight director systems, and protection systems. This should take the form of an instructor-led exercise to show the crew the points beyond which an upset condition could exist.			X				x	x		
			TO APP	According to the principles of EBT, covering one component should satisfy the requirement to cover the whole element of recognising and preventing the development of upset conditions.		Severe wind shear or wake turbulence during take-off or approach			x	x		x	x			
			CRZ			As applicable and relevant to the aircraft type, demonstration at a suitable intermediate level, with turbulence as appropriate; practise steep turns and note the relationship between bank angle, pitch and stalling speed.							X		x	x
			CRZ			At the maximum cruise flight level for the current aircraft weight, turbulence to trigger overspeed conditions (if FSTD capability exists, consider use of the vertical wind component to add realism).	X		x	x					x	
			CRZ			At the maximum cruise flight level for the current aircraft weight, turbulence and significant temperature rise to trigger low-speed conditions (if FSTD capability exists, consider use of the vertical wind component to add realism).								X	x	X
			CRZ			High-altitude ACAS RA (where the RA is required to be flown in manual flight)	x								x	x

Assessment and training topic	Frequency	Flight phase activation	Description (includes type of topic, being threat, error or focus)	Desired outcome (includes performance criteria OR training outcome)	Guidance material (GM) Example scenario elements	PRO	COM	FPA	FPM	LTW	PSD	SAW	WLM	KNO			
Section 6 — Training topics with frequency (B) in alphabetical order. Evaluation phase or scenario-based training phase (EVAL or SBT)																	
EVAL or SBT	Adverse wind	B	Adverse wind/crosswind. This includes tailwind but not ATC mis-reporting of the actual wind.	Recognise adverse-wind conditions. Observe limitations. Apply the appropriate procedures. Maintain directional control and safe flight path.	Take-off with different crosswind/tailwind/gust conditions						x		x				
					Take-off with unreported tailwind		x			x							
					Crosswinds with or without strong gusts on take-off	x			x								
					Wind exceeding limits on final approach (not reported)	x	x						x	x			
					Wind exceeding limits on final approach (reported) in manual aircraft control	x	x		x				x				
					Increasing tailwind on final approach (not reported)	x	x						x	x			
					Approach and landing in demanding weather conditions, e.g. turbulence, up and downdrafts, gusts and crosswind including shifting wind directions							x		x	x		
					Adverse-wind scenario resulting in increasing tailwind below DA (not reported)		x		x					x			
					Adverse-wind scenario including strong gusts and/or crosswind out of limits below DA (not reported)		x		x					x			
					Adverse-wind scenario including strong gusts and/or crosswind out of limits below 15 m (50 ft) (not reported)		x		x					x			
					Crosswind with or without strong gusts on approach, final approach and landing (within and beyond limits)	x			x					x			
EVAL or	Aircraft system malfunc	B	ALL	Any internal failure(s) apparent or not apparent to the crew	Recognise system malfunction.	(i) System malfunctions that require immediate and urgent crew intervention or decision, e.g. fire, smoke, loss of pressurisation at high altitude,		Intentionally blank									

tions, includin g operati ons under MEL	Any item cleared by the MEL but having an impact upon flight operations — for instance, thrust reverser locked.	Malfunctions to be considered should have one or more of the following characteristics: Immediacy Complexity Degradation of aircraft control Loss of primary instrumentation Management of consequences The operator should vary malfunctions for each characteristic over the EBT cycle.	Take appropriate action including correct stop/go decision. Apply the appropriate procedure correctly. Maintain aircraft control. Manage consequences.	failures during take-off, brake failure during landing. (ii) System malfunctions that require complex procedures, e.g. multiple hydraulic system failures, smoke and fumes procedures, major electrical system failure. (iii) System malfunctions that result in significant degradation of flight controls in combination with abnormal handling characteristics, e.g. jammed flight controls, certain degradation of FBW control, jammed horizontal stabiliser; flaps and/or slats locked; other malfunctions that result in degraded flight controls. (iv) System failures that require monitoring and management of the flight path using degraded or alternative displays, unreliable primary flight path information, unreliable airspeed, e.g. flight with unreliable airspeed (v) System failures that require extensive management of their consequences (independent of operation or environment), e.g. fuel leak.												
					TO	Unless specified otherwise in the operational suitability data, at least one malfunction with each characteristic should be included in every cycle. Combining characteristics should not reduce the number of malfunctions below seven in each cycle. For each crew member, the characteristics of degraded control and loss	MEL items with crew operating procedures applicable during take-off						x			X
					TO		Response to an additional factor that is affected by an MEL item (e.g. system failure, runway state)		x		x		x			X
					GN D		Malfunction during preflight preparation and prior to departure	x					x	x		
					CLB		Malfunction after departure	x					x	x		X
					ALL		Malfunctions that require immediate attention (e.g. bleed fault during engine start, hydraulic failure during taxi)	x				x			x	
					CLB CRZ		Fuel leak (management of consequences)	x				x		x		X
					TO		Malfunction on take-off high speed below V1	x				x	x			
					TO		Malfunction on take-off high speed above V1	x					x			

			GN	of instrumentation should be in the role of pilot flying and the others may be in the role of pilot flying or pilot monitoring. For full details, see the malfunction equivalency methodology.		During taxi to the runway, a spurious brake temperature announcement. The crew had the correct brake temperature moments before the failure.									
			D												
			TO			Tyre failure during take-off									
			TO			Malfunction on initial climb									
			APP			Malfunction on approach									
			APP			Malfunction on go-around									
LDG	Malfunction during landing														

Assessment and training topic		Frequency	Flight phase activation	Description (includes type of topic, being threat, error or focus)	Desired outcome (includes performance criteria OR training outcome)	Guidance material (GM) Example scenario elements	PRO	COM	FPA	FPM	LTW	PSD	SAW	WLM	KNO	
EVAL or SBT	Aircraft system management	B		Normal system operation according to defined instructions	This is not considered as a stand-alone topic. It is linked with the topic 'compliance'. Where a system is not managed according to normal or defined procedures, this is determined as a non-compliance.	See 'compliance' topic above. There are no defined scenarios, but the instructor should focus on learning opportunities when system management non-compliances manifest themselves during other scenarios. Underpinning knowledge of systems and their interactions should be developed and challenged, and not merely the application of normal procedures.	Intentionally blank								X	
			Minimum fuel, caused by extended delays, weather, etc. where the crew would need to manage a minimum fuel situation.							X	x	x	x			
	Approach, visibility close to minimum	B	APP	Any situation where visibility becomes a threat	Recognise actual conditions. Observe aircraft and/or procedural limitations. Apply the appropriate procedures if applicable. Maintain directional control and safe flight path.	Approach in poor visibility	x		x	x					x	
			APP			Approach in poor visibility with deteriorations necessitating a decision to perform a go-around	x		x	x						
			LDG			Landing in poor visibility						x		x	x	

Assessment and training topic		Frequency	Flight phase activation	Description (includes type of topic, being threat, error or focus)	Desired outcome (includes performance criteria OR training outcome)	Guidance material (GM) Example scenario elements	PRO	COM	FPA	FPM	LTW	PSD	SAW	WLM	KNO
Landing	B	LDG		Pilots should have opportunities to practise landings in demanding situations at the defined frequency. Data indicates that landing problems have their roots in a variety of factors, including inappropriate decision-making, in addition to manual aircraft control skills if difficult environmental conditions exist. The purpose of this item is to ensure that pilots are exposed to this during the programme.	Landing in demanding environmental conditions, with malfunctions as appropriate	This topic should be combined with the adverse-weather topic, aircraft system malfunctions topic or any topic that can provide exposure to a landing in demanding conditions.	Intentionally blank								
Runway or taxiway condition	B	GND TO LDG	Contamination or surface quality of the runway, taxiway, or tarmac including foreign objects	Recognise hazardous runway condition. Observe limitations. Take appropriate action. Apply the appropriate procedures correctly. Assure aircraft control.	Planned anticipated hazardous conditions with dispatch information provided to facilitate planning and execution of appropriate procedures										X
		GND TO LDG					X			X	X				
		TO				X			X	X		X			
		TO							X	X			X		
					Stop/go decision in hazardous conditions					X	X		X		

Assessment and training topic		Frequency	Flight phase activation	Description (includes type of topic, being threat, error or focus)	Desired outcome (includes performance criteria OR training outcome)	Guidance material (GM) Example scenario elements	PRO	COM	FPA	FPM	LTW	PSD	SAW	WLM	KNO
EVAL or SBT	Surprise	B	TO	<p>The data analysed during the development of the EBT concept indicated substantial difficulties encountered by crews when faced with a threat or error, which was a surprise or an unexpected event. The element of surprise should be distinguished from what is sometimes referred to as the ‘startle factor’ — the latter being a physiological reaction. Wherever possible, consideration should be given towards variations in the types of scenario, times of occurrences and types of occurrence, so that pilots do not become overly familiar with repetitions of the same scenarios. Variations should be the focus of EBT programme design, and not left to the discretion of individual instructors, in order to preserve programme integrity and fairness.</p>	<p>Exposure to an unexpected event or sequence of events at the defined frequency in order to build resilience.</p>	<p>Rejected take- off</p>	X			X		X			
EVAL or SBT			ALL				Intentionally blank	Intentionally blank							

EVAL or SBT	Terrain	B	ALL	Alert, warning, or conflict	Anticipate terrain threats. Prepare for terrain threats. Recognise unsafe terrain clearance. Take appropriate action. Apply the appropriate procedures correctly. Maintain aircraft control. Restore safe flight path. Manage consequences.	ATC clearance giving insufficient terrain clearance	x	x			x				X
			ALL			Demonstration of terrain avoidance warning systems (TAWS) (this scenario element may be done in an ISI.)					x	x	x		
			TO CLB			Engine failure where performance is marginal leading to TAWS warning		x		x			x		
			DES APP			ATC provides a wrong QNH		x				x			
			DES			'Virtual mountain' refers to the surprise element of an unexpected warning. Care should be exercised in creating a level of realism, so this can best be achieved by an unusual and unexpected change of route during the descent.						X	x	x	
	Workload, distraction, pressure, stress	B	ALL	This is not considered a topic for specific attention on its own, but more as a reminder to programme developers to ensure that pilots are exposed to immersive training scenarios which expose them to manageable high workload and distractions during the course of the EBT programme, at the defined frequency.	Manage available resources efficiently to prioritise and perform tasks in a timely manner under all circumstances	Intentionally blank	Intentionally blank								

Assessment and training topic		Frequency	Flight phase activation	Description (includes type of topic, being threat, error or focus)	Desired outcome (includes performance criteria OR training outcome)	Guidance material (GM) Example scenario elements	PRO	COM	FPA	FPM	LTW	PSD	SAW	WLM	KNO			
Section 7 — UPRT Upset recovery training topic with frequency (C). Manoeuvres training phase or scenario-based training phase (MT or SBT)																		
MT or SBT	Upset recovery	C	N/A	Compliance with AMC1 or AMC2 to ORO.FC.220&230 Include the recovery exercises in Table 2 of AMC1 ORO.FC.220&230 for the recurrent training programme, such that all the exercises are covered over a period not exceeding 3 years.	Recognise upset condition. Make timely and appropriate intervention. Take appropriate action. Assure timely and appropriate intervention. (AMC1 ORO.FC.220&230 Table 2 component 1) Assure aircraft control. Maintain or restore a safe flight path.	The example scenario elements may be done in ISI, as non-ISI or a combination of both. If done in ISI: The instructor should position the aircraft within but close to the edge of the validated training envelope before handing control to the trainee to demonstrate the restoration of normal flight. Careful consideration should be given to flying within the validated training envelope.	Intentionally blank											
			CLB DES	According to the principles of EBT, covering one component should satisfy the requirement to cover the whole element of recovery from developed upsets. The same principles apply to the exercises of components 2, 3 and 4 where one exercise may satisfy the requirement to cover the whole component.	Assess consequential issues. Manage outcomes. Consolidate the summary of aeroplane recovery techniques. (AMC1 ORO.FC.220&230 Table 2 component 5)	Table 2 of AMC1 ORO.FC.220&230: Exercises for upset recovery training	A.	Recovery from developed upsets										
			CRZ	An aeroplane upset is defined as an undesired aeroplane state in flight characterised by	Note: The operator should assess if the exercises should be practised for the either seat qualification.				2.	Recovery from stall events in the following configurations: take-off configuration, clean configuration low altitude, clean configuration near maximum operating altitude, and landing configuration during the approach phase.	x					x	x	
			CRZ								3.	Recovery from nose high at various bank angles	x				x	x
			CRZ								4.	Recovery from nose low at various bank angles	x				x	x
			APP															
			CLB DES															

Assessment and training topic		Frequency	Flight phase activation	Description (includes type of topic, being threat, error or focus)	Desired outcome (includes performance criteria OR training outcome)	Guidance material (GM) Example scenario elements	PRO	COM	FPA	FPM	LTW	PSD	SAW	WLM	KNO
				unintentional divergences from parameters normally experienced during line operations or training. An aeroplane upset may involve pitch and/or bank angle divergences as well as inappropriate airspeeds for the conditions.		disable aircraft systems as necessary to enable trainee to perform stall recovery according to OEM instructions.									
						Recovery from a wake turbulence position with high-bank angle	x		x	x				x	

Assessment and training topic		Frequency	Flight phase activation	Description (includes type of topic, being threat, error or focus)	Desired outcome (includes performance criteria OR training outcome)	Guidance material (GM) Example scenario elements	PRO	COM	FPA	FPM	LTW	PSD	SAW	WLM	KNO	
Section 8 — Training topics with frequency (C) in alphabetical order. Evaluation phase or scenario-based training phase (EVAL or SBT)																
EVAL or SBT	ATC	C	ALL	ATC error. Omission, miscommunication, garbled, poor quality transmission. All these act as distractions to be managed by the crew. The scenarios should be combined, where possible, with others of the same or higher weighting, the principal reason being to create distractions.	Respond to communications appropriately. Recognise, clarify and resolve any ambiguities. Refuse or question unsafe instructions. Use standard phraseology whenever possible.	ATC role-play: the instructor provides scripted instructions, as a distraction to the crew	x	x			x					
			ALL			Controller error, provided by the instructor according to a defined scripted scenario	x	x				x	x			
			ALL			Frequency congestion, with multiple aircraft using the same frequency		x								
			APP			Destination temporarily closed					x	x	x	x		
			CRZ			Rescue and firefighting services (RFFS) level reduction at destination		x		x		x				
			APP			Runway change before the interception of the localiser or similar navigation aid in azimuth			x		x		x	x		
			GND TO			Stray dogs at the opposite threshold runway		x		x		x		x		
			ALL			Poor quality transmissions		x								

Assessment and training topic		Frequency	Flight phase activation	Description (includes type of topic, being threat, error or focus)	Desired outcome (includes performance criteria OR training outcome)	Guidance material (GM) Example scenario elements	PRO	COM	FPA	FPM	LTV	PSD	SAW	WLM	KNO				
EVAL or SBT	Engine failure	C	TO	Any engine failure or malfunction, which causes loss or degradation of thrust that affects performance. This is distinct from the engine-out manoeuvres described in the MT section above, which are intended only to practise psychomotor skills and reinforce procedures to manage engine failures.	Recognise engine failure. Take appropriate action. Apply the appropriate procedure correctly. Maintain aircraft control. Manage consequences.	Engine failure or engine malfunction on take-off low speed	x			x		x		x					
			TO			Engine failure or engine malfunction on take-off high speed below V1	x			x		x		x					
			TO			Engine failure or engine malfunction on take-off above V1	x					x	x	x					
			TO			Engine failure or engine malfunction on initial climb	x					x	x						
			APP			Engine malfunction	x					x		x					
			CRZ			Engine failure in cruise (with autopilot)	x		x				x						
			CRZ			Multiple engine failure in CRZ (volcanic ash, recoverable). Competency FPM may or may not be included depending on the impact on the automation.								x	x	x	x		
			LDG			Engine failure or engine malfunction on landing							x						
EVAL or SBT	Fire and smoke management	C	GND	This includes engine, electric, pneumatic, cargo fire, smoke or fumes.	Recognise fire, smoke or fumes. Take appropriate action. Apply the appropriate procedure correctly. Maintain aircraft control. Manage consequences.	Fire in cargo or cabin/cockpit at gate	x	x				x		x					
			GND			Fire during taxi	x	x				x		x	x				
			GND			Fire with no cockpit indication	x	x						x		x	x		
			TO			Take-off low speed	x			x	x	x				x			
			TO			Fire or smoke on take-off high speed below V1	x			x	x	x							
			TO			Fire or smoke on take-off high speed above V1	x					x	x						
			TO			Fire or smoke on initial climb	x					x	x						
			CRZ			Cargo compartment fire or avionics compartment fire									x	x	x		
			APP			Engine fire in approach (extinguishable)					x				x				
			APP			Engine fire in approach (non-extinguishable)						x			x				
			CLB			Lithium battery fire in the cockpit or cabin compartment					x	x			x	x		x	
			CRZ																
			DES																
APP	Flight deck or cabin fire						x			x	x			x					

Assessment and training topic		Frequency	Flight phase activation	Description (includes type of topic, being threat, error or focus)	Desired outcome (includes performance criteria OR training outcome)	Guidance material (GM) Example scenario elements	PRO	COM	FPA	FPM	LTW	PSD	SAW	WLM	KNO
			GND			Any of the example scenario elements above ending in an evacuation		x			x	x		x	
Loss of communications	C	GND	Lost or difficult communications due to either pilot mis-selection or a failure external to the aircraft. This could be for a few seconds or a total loss.	Recognise loss of communications. Take appropriate action. Execute the appropriate procedure as applicable. Use alternative ways to communicate. Manage consequences.	Loss of communications during ground manoeuvring	x	x								
		TO				Loss of communications after take-off	x				x				X
		APP				Loss of communications during approach phase, including go-around	x	x			x	x		X	

Assessment and training topic		Frequency	Flight phase activation	Description (includes type of topic, being threat, error or focus)	Desired outcome (includes performance criteria OR training outcome)	Guidance material (GM) Example scenario elements	PRO	COM	FPA	FPM	LTW	PSD	SAW	WLM	KNO
EVAL or SBT Managing loading, fuel, performance errors	C	ALL	A calculation error by one or more pilots, or someone involved with the process, or the process itself, e.g. incorrect information on the load sheet	Anticipate the potential for errors in load/fuel/performance data. Recognise inconsistencies. Manage/avoid distractions. Make changes to paperwork/aircraft system(s) to eliminate error. Identify and manage consequences.	This can be a demonstrated error, in that the crew may be instructed to deliberately insert incorrect data — for example, to take off from an intersection with full-length performance information. The crew will be asked to intervene when acceleration is sensed to be lower than normal, and this may be part of the operator procedures, especially when operating mixed fleets with considerable variations in MTOM. Wind report with take-off clearance not consistent with prior performance calculation. ATC, cabin crew or other people are pushing crew to take off quickly.	x	x							x	
		TO					x			x		x	x		

Assessment and training topic		Frequency	Flight phase activation	Description (includes type of topic, being threat, error or focus)	Desired outcome (includes performance criteria OR training outcome)	Guidance material (GM) Example scenario elements	PRO	COM	FPA	FPM	LTW	PSD	SAW	WLM	KNO	
			GND			Environmental change during taxi (e.g. heavy rain) not consistent with prior take-off performance calculation							x	x		
			GND			Fuel ground staff on industrial action. Only limited amount of fuel available, which is below the calculated fuel for the flight.					x	x	x	x		
			GND			Advise crew that there is a change of the load sheet figures during taxi to the runway. The crew may have limited time due to a calculated take-off time (CTOT) — ATC Slot.	x								x	
			GND			Braking action reported 'medium'. The information is transmitted just before take-off. The flight is subject to a CTOT — ATC slot.							x		x	x
EVAL or SBT	Navigation	C	GND	External NAV failure. Loss of GPS satellite, ANP exceeding RNP, loss of external NAV source(s)	Recognise a NAV degradation. Take appropriate action. Execute the appropriate procedure as applicable. Use alternative NAV guidance. Manage consequences.	External failure or a combination of external failures degrading aircraft navigation performance on ground	x		x			x	x			
			TO CLB APP LDG			External failure or a combination of external failures degrading aircraft navigation performance in flight		x		x	x	x				
			GND			Standard initial departure change during taxi. The flight may be subject to a CTOT — ATC slot.					x		x	x		
			APP			Loss of runway lighting below decision height		x				x	x			
			CRZ			No fly zone: when the crew changes control frequency, the new ATCO informs the crew that they are flying over an unannounced 'no fly zone' that is not included in the NOTAMS. (To trigger such an event, the context may be as follows: an unexpected military conflict in the territory the aircraft is flying over or the crew is forced to re-route in flight and the new route flies over a city								x	x	x

Assessment and training topic		Frequency	Flight phase activation	Description (includes type of topic, being threat, error or focus)	Desired outcome (includes performance criteria OR training outcome)	Guidance material (GM) Example scenario elements	PRO	COM	FPA	FPM	LTW	PSD	SAW	WLM	KNO	
						that has an important event such the Olympic games, a G20/G7 submit, or the route is flying near a space rocket launch close to the time of the launch, like the Guiana Space Centre, Cape Cañaveral, etc.).										
	Operations - or type-specific	C	ALL	Intentionally blank	Intentionally blank	Intentionally blank	Intentionally blank									
	Operations of special airport approval	C	APP LDG	See equivalency of approaches relevant to operations.	The operator should comply with the national qualification requirements published in the aeronautical information publication (AIP).	Intentionally blank	Intentionally blank									
	Pilot incapacitation	C	TO	Consequences for the non-incapacitated pilot	Recognise incapacitation. Take appropriate action including correct stop/go decision. Apply the appropriate procedure correctly. Maintain aircraft control. Manage consequences.	During take-off	x	x			x	x			X	
During approach			x					x						x	X	
	Traffic	C	CLB CRZ DES	Traffic conflict. ACAS RA or TA, or visual observation of conflict, which requires evasive manoeuvring	Anticipate potential loss of separation. Recognise loss of separation. Take appropriate action. Apply the appropriate procedure correctly. Maintain aircraft control.	ACAS warning that requires crew intervention		x				x	x	x		
Dilemma: Visual acquisition of conflicting traffic followed by an ACAS warning (resolution advisory) triggered by the same or other traffic. Even if the traffic is in sight, the pilot should follow the RA.						x		x	x							
While in descent, ACAS warning (traffic advisory) of an aircraft below. The crew should						x				x	x					

Assessment and training topic		Frequency	Flight phase activation	Description (includes type of topic, being threat, error or focus)	Desired outcome (includes performance criteria OR training outcome)	Guidance material (GM) Example scenario elements	PRO	COM	FPA	FPM	LTW	PSD	SAW	WLM	KNO			
Wind shear recovery	C	APP	TO TO TO TO APP APP	With or without warnings including predictive. A wind shear scenario is ideally combined with an adverse-weather scenario containing other elements.	<p>Manage consequences.</p> <p>Anticipate potential for wind shear. Avoid known wind shear or prepare for suspected wind shear. Recognise wind shear encounter. Take appropriate action. Apply the appropriate procedure correctly. Assure aircraft control. Recognise out of wind shear condition. Maintain or restore a safe flight path. Assess consequential issues and manage outcomes.</p>	not initiate an avoidance manoeuvre based on TA (except decreasing the rate of descent unless otherwise instructed by ATC, etc.). This example scenario can be done during climb with conflicting traffic above.												
						Predictive wind shear warning during take-off					x	x						
						Wind shear encounter during take-off	x				x	x						
						Wind shear encounter after rotation						x				x		
						Predictive wind shear after rotation						x	x					
						Predictive wind shear during approach	x				x	x						
						Wind shear encounter during go-around	x				x	x				x		
						Wind shear encounter during approach	x								x	x		

END GEN4 JET

AMC3 ORO.FC.232 EBT programme assessment and training topics

ED Decision 2022/014/R

GENERATION 3 (JET) — TABLE OF ASSESSMENT AND TRAINING TOPICS

Assessment and training topic		Frequency	Description (includes type of topic, being threat, error or focus)	Desired outcome (includes performance criteria OR training outcome)	Flight phase activation	Guidance material (GM) Example scenario elements	PRO	COM	FPA	FPM	LTW	PSD	SAW	WLM	KNO		
Generation 3 Jet — Recurrent assessment and training matrix							Competency map										
Section 1 — Skill retention. Manoeuvres training phase (MT)																	
MT	Rejected take-off	B	Rejected take-off after the application of take-off thrust and before reaching V1 (CAT I or above)	Demonstrate manual aircraft control skills with smoothness and accuracy as appropriate to the situation. Detect deviations through instrument scanning. Maintain spare mental capacity during manual aircraft control. Maintain the aircraft within the flight envelope. Apply knowledge of the relationship between aircraft attitude, speed and thrust.	TO	From initiation of take-off to complete stop (or as applicable to the procedure)	x			x							
	Failure of the critical engine between V1 and V2	A	Failure of the critical engine from V1 and before reaching V2 in the lowest CAT I visibility or in LVO meteorological (MET) conditions.		TO	The manoeuvre is complete at a point when the aircraft is stabilised at normal engine-out climb speed with the correct pitch and lateral control, in trim condition and, as applicable, autopilot engagement. Only one failure of the critical engine between V1 and V2 a year may be done in LVO conditions.	x			x							
	Failure of one engine on take-off	B	Failure of one engine from V1 and before reaching V2 in the lowest CAT I visibility or in LVO MET conditions.		TO	The manoeuvre is complete at a point when the aircraft is stabilised in a clean configuration with engine-out procedures completed. Only one failure of the critical engine between V1 and V2 a year may be done in LVO conditions.	x			x							
			Failure of one engine above V2 (any segment of the TO) in the lowest CAT I visibility or in LVO MET conditions.		TO	The manoeuvre is complete at a point when the aircraft is stabilised in a clean configuration with engine-out procedures completed.	x		x	x							

Assessment and training topic		Frequency	Description (includes type of topic, being threat, error or focus)	Desired outcome (includes performance criteria OR training outcome)	Flight phase activation	Guidance material (GM) Example scenario elements	PRO	COM	FPA	FPM	LTW	PSD	SAW	WLM	KNO	
	Emergency descent	C	Initiation of emergency descent from normal cruise altitude		CRZ	The manoeuvre is complete once the aircraft is stabilised in emergency descent configuration (and profile). However, if the EBT programme does not include the example scenario element 'emergency descent' in the training topic 'automation management', the emergency descent procedures should be completed and should not stop once the aircraft is stabilised in emergency descent configuration.	x		x	x						
	Engine-out approach & landing	B	With the critical engine (if applicable) failed, normal landing		LDG	Initiation in a stabilised engine-out configuration from not less than 3 NM final approach, until completion of roll-out	x			x						
	Engine-out approach & go-around	B	With the critical engine (if applicable) failed, manually flown normal precision approach to DA, followed by a manual go-around — the whole manoeuvre to be flown without visual reference		APP	This manoeuvre should be flown from intercept to centreline until acceleration after go-around. The manoeuvre is complete at a point when the aircraft is stabilised at normal engine-out climb speed with the correct pitch and lateral control, in trim condition and, as applicable, autopilot engagement (describe generally the critical part of the manoeuvre).	x			x						
	Go-around	A	Go-around, all engines operative		APP	High energy, initiation during the approach at 150 to 300 m (500 to 1 000 ft) below the missed approach level-off altitude	x		x	x						
						Initiation of a go-around from DA followed by visual circuit and landing	x		x	x						
						During flare/rejected landing	x		x	x						
Pilot qualification to	B	As per ORO.FC.235		APP	Complete the manoeuvres mandated in ORO.FC.235.	Intentionally left in blank.										

Assessment and training topic	Frequency	Description (includes type of topic, being threat, error or focus)	Desired outcome (includes performance criteria OR training outcome)	Flight phase activation	Guidance material (GM) Example scenario elements	PRO	COM	FPA	FPM	LTW	PSD	SAW	WLM	KNO
operate in either pilot's seat														

Assessment and training topic	Frequency	Description (includes type of topic, being threat, error or focus)	Desired outcome (includes performance criteria OR training outcome)	Flight phase activation	Guidance material (GM) Example scenario elements	PRO	COM	FPA	FPM	LTW	PSD	SAW	WLM	KNO
Generation 3 Jet — Recurrent assessment and training matrix						Competency map								
Section 2 — Equivalency of approaches relevant to operations. Evaluation phase, manoeuvres training phase or scenario-based training phase (EVAL, MT or SBT)														
MT	Approach type A or B	B	Approach type A or B flight method 3D	See equivalency of approaches relevant to operations that place an additional demand on a proficient crew	APP	See equivalency of approaches relevant to operations	X		X	X			X	X
	Approach type A	B	Approach type A flight method 2D	See equivalency of approaches relevant to operations that place an additional demand on a proficient crew	APP	See equivalency of approaches relevant to operations	X		X	X			X	X
EVAL or SBT	Approach type A	B	Approach type A flight method 3D or 2D	See equivalency of approaches relevant to operations that place an additional demand on a proficient crew	APP	See equivalency of approaches relevant to operations	X		X	X			X	X
	Approach type B	B	Approach type B flight method 3D	See equivalency of approaches relevant to operations that place an additional demand on a proficient crew	APP	See equivalency of approaches relevant to operations	X		X	X			X	X

Assessment and training topic		Frequency	Description (includes type of topic, being threat, error or focus)	Desired outcome (includes performance criteria OR training outcome)	Flight phase activation	Guidance material (GM) Example scenario elements	PRO	COM	FPA	FPM	LTW	PSD	SAW	WLM	KNO
Section 3 – Equivalency of approaches under specific approvals and take-off under specific approvals. Evaluation phase, manoeuvres training phase or scenario-based training phase (EVAL, MT or SBT)															
MT	SPA approach(es)	B	Approach requiring specific approval	See equivalency of approaches relevant to operations — specific approval	APP	Approaches flown from FAF to landing or go-around	x		x	x					
EVAL or SBT	SPA approach(es)	B	Approach requiring specific approval	See equivalency of approaches relevant to operations — specific approval	APP	Approaches flown from FAF to landing or go-around	x		x	x					
EVAL, MT or SBT	SPA Rejected take-off (RTO)	B	<p>Engine failure after the application of take-off thrust and before reaching V1 (in low-visibility MET conditions, preferably in the lowest approved visibility) Low-visibility RTO is not required under Part SPA but instead in Appendix 9 Section 6.</p> <p>Note: AMC1 SPA.LVO.120 point (f) does not require a low-visibility RTO. RTO is required only in the initial LVO course (point (g)(1)(iii) of AMC1 SPA.LVO.120).</p>	<p>Demonstrate manual aircraft control skills with smoothness and accuracy as appropriate to the situation.</p> <p>Detect deviations through instrument scanning.</p> <p>Maintain spare mental capacity during manual aircraft control.</p> <p>Maintain the aircraft within the flight envelope.</p> <p>Apply knowledge of the relationship between aircraft attitude, speed and thrust.</p>	TO	RTO — can be combined with the assessment and training topic ‘surprise’ in EVAL or SBT	x			x					

Assessment and training topic		Frequency	Description (includes type of topic, being threat, error or focus)	Desired outcome (includes performance criteria OR training outcome)	Flight phase activation	Guidance material (GM) Example scenario elements	PRO	COM	FPA	FPM	LTW	PSD	SAW	WLM	KNO
EVAL, MT or SBT	LVTO	B	Notwithstanding AMC1 SPA.LVO120 point (f)(1) AMC1 SPA.LVO.120 requires SPA manoeuvres in the frequency of the OPC, as OPC is substituted in the EBT programme. Thus, the frequency in EBT is determined in every cycle (B). Low visibility take-off, preferably in the lowest approved visibility		TO	The manoeuvre is complete at a point when the aircraft is stabilised at normal climb speed with the correct pitch and lateral control, in trim condition and, as applicable, autopilot engagement.	x			x					

Assessment and training topic		Frequency	Flight phase activation	Description (includes type of topic, being threat, error or focus)	Desired outcome (includes performance criteria OR training outcome)	Guidance material (GM) Example scenario elements	PRO	COM	FPA	FPM	LTW	PSD	SAW	WLM	KNO
Generation 3 Jet — Recurrent assessment and training matrix							Competency map								
Section 4 — Training topics with frequency (A) in alphabetical order. Evaluation phase or scenario-based training phase (EVAL or SBT).															
EVAL or SBT	Adverse weather	A	GND	Thunderstorm, heavy rain, turbulence, ice build-up to include de-icing issues, as well as high-temperature conditions.	Anticipate adverse weather. Prepare for suspected adverse weather. Recognise adverse weather.	Predictive wind shear warning before take-off, as applicable	x	x				x			
			ALL			Adverse-weather scenario, e.g. thunderstorm activity, precipitation, icing		x		x		x			
			TO			Wind shear encounter during take-off, not predictive	x			x		x		X	
			TO			Predictive wind shear warning during take-off	x	x			x	x			
			TO			Crosswinds with or without strong gusts on take-off	x			x					

Assessment and training topic	Frequency	Flight phase activation	Description (includes type of topic, being threat, error or focus)	Desired outcome (includes performance criteria OR training outcome)	Guidance material (GM) Example scenario elements	PRO	COM	FPA	FPM	LTW	PSD	SAW	WLM	KNO		
		CRZ	The proper use of anti-ice and de-icing systems should be included generally in appropriate scenarios.	Take appropriate action. Apply the appropriate procedure correctly. Assure aircraft control.	Turbulence that increases to severe turbulence		x			x		x	x			
		CRZ			Wind shear encounter scenario during cruise	x		x			x	x	x			
		APP			Reactive wind shear warning during approach or go-around	x		x	x				x			
		APP			Predictive wind shear warning during approach or go-around	x	x					x	x			
		APP			Thunderstorm encounter during approach or on missed approach	x							x	x		
		APP			Increasing tailwind on final approach (not reported)	x	x						x	x		
		APP			Approach and landing in demanding weather conditions, e.g. turbulence, up and downdrafts, gusts and crosswinds including shifting wind directions						x		x	x		
		APP			Non-precision approach in cold-temperature conditions, requiring altitude compensation for temperature, as applicable to the type	x	x								x	
		APP LDG			Crosswinds with or without strong gusts on approach, final approach and landing (within and beyond limits)	x					x		x			
		APP			In approach, unexpected braking action 'good to medium' reported by the preceding aircraft					x				x	x	x
		APP			Moderate to severe icing conditions during approach effecting aircraft performance	x	x							x	x	
		APP			Reduced visibility even after acquiring the necessary visual reference during approach, due to rain or fog	x	x							x		
EVAL or SBT	Automation management	A	The purpose of this topic is to encourage and develop effective flight path management through proficient and appropriate use of the	Know how and when to use the flight management system(s), guidance and automation. Demonstrate correct methods for	ACAS warning (resolution advisory), recovery and subsequent engagement of automation	x		x								
		ALL			FMS tactical programming issues, e.g. step climb, runway changes, late clearances, destination re-programming, executing diversion	x		x							x	

Assessment and training topic	Frequency	Flight phase activation	Description (includes type of topic, being threat, error or focus)	Desired outcome (includes performance criteria OR training outcome)	Guidance material (GM) Example scenario elements	PRO	COM	FPA	FPM	LTW	PSD	SAW	WLM	KNO		
		CLB CRZ DES APP	flight management system(s), guidance and automation, including transitions between modes, monitoring, mode awareness, vigilance and flexibility needed to change from one mode to another. The means of mitigating errors are included in this topic. The errors are described as mishandled auto flight systems, inappropriate mode selection, mishandled flight management system(s) and inappropriate autopilot usage.	engagement and disengagement of the auto flight system(s). Demonstrate appropriate use of flight guidance, auto thrust and other automation systems. Maintain mode awareness of the auto flight system(s), including engagement and automatic transitions. Revert to different modes when appropriate. Detect deviations from the desired aircraft state (flight path, speed, attitude, thrust, etc.) and take appropriate action.	Recoveries from TAWS, management of energy state to restore automated flight	x		x	x							
		CLB CRZ DES APP				Amendments to ATC cleared levels during altitude capture modes to force mode awareness and intervention	x		x					x		
		TO				ACAS warning (resolution advisory to level off) during climb or descent; for example, close to the cleared level when the capture mode has already been activated.	x		x					x		
		TO APP				Late ATC clearance to an altitude below acceleration altitude	x		x					x		
		CRZ				Engine-out special terrain procedures	x		x					x		
		CLB				Forcing autopilot disconnect followed by re-engagement, recovery from low- or high-speed events in cruise	x		x	x				x		
		CRZ				Engine failure during or after initial climb using automation	x		x							
		CRZ				Engine failure in cruise to onset of descent using automation	x		x							
		DES APP				Emergency descent	x		x							X
		APP				Managing high-energy descent capturing descent path from above (correlation with unstable approach training)	x		x					x		X
		APP				No ATC clearance received prior to commencement of approach or final descent	x		x					x		
		APP				Reactive wind shear and recovery from the consequent high-energy state	x		x					x		

Assessment and training topic	Frequency	Flight phase activation	Description (includes type of topic, being threat, error or focus)	Desired outcome (includes performance criteria OR training outcome)	Guidance material (GM) Example scenario elements	PRO	COM	FPA	FPM	LTW	PSD	SAW	WLM	KNO		
		APP		Take appropriate action if necessary. Restore correct auto flight state. Identify and manage consequences.	Automation fail to capture the approach altitude in descent (e.g. last altitude before the FAP). Ideally, the failure occurs when the workload is high (e.g. configuration of the aircraft for final approach).					x	x	x	x			
		APP			Non-precision or infrequently flown approaches using the maximum available level of automation	x		x							X	
		APP			Gear malfunction during an approach planned with autoland (including autobrake). Competency FPA may or may not be included depending on the impact of such malfunction on the automation.		x	x			x			x		
		APP			ATC clearances to waypoints beyond the programmed descent point for a coded final descent point during an approach utilising a final descent that is commanded by the flight management system.	x		x						x		X
EVAL or SBT		APP	This encapsulates the general CRM principles and objectives. It includes communication; leadership and teamwork; problem-solving and decision-making; situation awareness and management of information; and workload management.	Exposure to an event or sequence of events to allow the pilot to build awareness of human factors in aviation and the human limitations. This includes the development of the following competencies: Communication: Demonstrate: — effective use of language;	GPS failure prior to commencement of approach associated with position drift and a terrain alert					x	x	x		X		
		DES			Cabin crew report of water noise below the forward galley indicating a possible toilet pipe leak, with consequent avionics failures					x	x	x				
		CRZ			Smoke removal but combined with a diversion until landing is completed.		x			x	x	x	x	x	X	
		GND			Apron fuel spilling					x	x			x		
		CRZ			Important water leak in an aircraft galley		x			x	x			x		
		ALL			A relevant number of cabin crew are wounded or incapacitated. Additionally, the cabin crew wounded or incapacitated are the most competent (e.g. senior cabin crew member).						x	x			x	
		ALL			Unruly passenger(s)						x				x	
		GND			Passenger oxygen: passenger service unit open and mask falling down							x	x		x	

Assessment and training topic	Frequency	Flight phase activation	Description (includes type of topic, being threat, error or focus)	Desired outcome (includes performance criteria OR training outcome)	Guidance material (GM) Example scenario elements	PRO	COM	FPA	FPM	LTW	PSD	SAW	WLM	KNO			
EVAL or SBT		ALL	Emphasis should be placed on the development of leadership, shown by EBT data sources to be a highly effective competency in mitigating risk and improving safety through pilot performance.	<ul style="list-style-type: none"> responsiveness to feedback; and capability to state the plans and resolve ambiguities. Leadership and teamwork: Use appropriate authority to ensure focus on the task. Support others in completing tasks. Problem-solving and decision-making: Detect deviations from the desired state, evaluate problems, identify the risk, consider alternatives and select the best course of action. Continuously review progress and adjust plans. Situation awareness and management of information: Have an awareness of the aircraft state in its environment; project	Passenger with medical problems — medical emergency					x			x				
		CRZ			Credible threat reported to the crew. Stowaway or fugitive on board.		x				x			x	x		
		GND			No METAR or TAFOR is available for destination due to industrial action at the destination airport.	x	x					x	x				
		CRZ			Credible bomb threat reported to crew		x					x			x	x	
		CLB DES			Credible bomb threat or pressurisation problem, but no quick landing possible (due to weather, terrain or other reasons)		x					x	x				x
		APP			Diversion with low remaining fuel or increased fuel flow due to system malfunction	x							x			x	x
		APP			ACAS warning (resolution advisory) immediately following a go-around, with a descent manoeuvre required. (The RA should be a command for descent when the aircraft is above 1 100 ft AGL.)									x		x	x

Assessment and training topic		Frequency	Flight phase activation	Description (includes type of topic, being threat, error or focus)	Desired outcome (includes performance criteria OR training outcome)	Guidance material (GM) Example scenario elements	PRO	COM	FPA	FPM	LTW	PSD	SAW	WLM	KNO
					and anticipate changes. Workload management: Prioritise, delegate and receive assistance to maximise focus on the task. Continuously monitor the flight progress.										
EVAL or SBT	Compliance	A	ALL	Compliance failure. Consequences of not complying with operating instructions (e.g. SOPs). This is not intended to list example scenario elements, but instructors should ensure that observed non-compliances are taken as learning opportunities throughout the programme. In all modules of the programme, the FSTD should as far as possible be treated like	Recognise that a compliance failure has occurred. Make a verbal announcement. Take appropriate action if necessary. Restore safe flight path if necessary. Manage consequences.	The following are examples of potential compliance failures and are not intended to be developed as scenarios as part of an EBT mod: 1. Requesting flap beyond limit speed 2. Flaps or slats in the wrong position for phase of flight or approach 3. Omitting an action as part of a procedure 4. Failing to initiate or complete a checklist 5. Using the wrong checklist for the situation	Intentionally blank								

Assessment and training topic	Frequency	Flight phase activation	Description (includes type of topic, being threat, error or focus)	Desired outcome (includes performance criteria OR training outcome)	Guidance material (GM) Example scenario elements	PRO	COM	FPA	FPM	LTW	PSD	SAW	WLM	KNO	
			an aircraft, and non-compliances should not be accepted simply for expediency.												
EVAL or SBT	Go-around management	A	Any threat or error that can result in circumstances that require a decision to perform a go-around, in addition to the execution of the go-around. Go-around scenarios should be fully developed to encourage effective leadership and teamwork, in addition to problem-solving and decision-making, plus execution using manual aircraft control or the flight management system(s) and automation as applicable. Design should include the element of surprise, and scenario-based go-		Adverse-weather scenario leading to a reactive wind shear warning during approach	x	x					x	x		
					Adverse-weather scenario leading to a predictive wind shear warning during approach or go-around	x	x					x	x		
					Adverse-weather scenario, e.g. thunderstorm activity, heavy precipitation or icing forcing decision at or close to DA/MDA	x					x	x	x		
					DA with visual reference in heavy precipitation with doubt about the runway surface braking capability	x					x	x	x		
					Adverse-wind scenario resulting in increasing tailwind below DA (not reported)		x		x		x				
					Adverse-wind scenario including strong gusts and/or crosswind out of limits below DA (not reported)		x		x		x				
					Adverse-wind scenario including strong gusts and/or crosswind out of limits below 15 m (50 ft) (not reported)		x		x		x				
					Lost or difficult communications resulting in no approach clearance prior to commencement of approach or final descent	x		x						x	
					Birds: large flocks of birds below DA once visual reference has been established				x		x	x			
					System malfunction, landing gear malfunction during the approach										

Assessment and training topic		Frequency	Flight phase activation	Description (includes type of topic, being threat, error or focus)	Desired outcome (includes performance criteria OR training outcome)	Guidance material (GM) Example scenario elements	PRO	COM	FPA	FPM	LTW	PSD	SAW	WLM	KNO
				rounds should not be predictable and anticipated. This topic is completely distinct from the go-around manoeuvre listed in the MT section that is intended only to practise psychomotor skills and a simple application of the procedures.											
EVAL or SBT	Manual aircraft control	A	CLB CRZ DES APP	Controls the flight path through manual control	Demonstrate manual aircraft control skills with smoothness and accuracy as appropriate to the situation. Detect deviations through instrument scanning. Maintain spare mental capacity during manual aircraft control. Maintain the aircraft within the normal flight envelope. Apply knowledge of the relationship between aircraft	Flight with unreliable airspeed, which may or may not be recoverable	x			x			x		X
			CLB CRZ DES APP			Alternate flight control modes according to malfunction characteristics	x			x			x	X	
			CLB CRZ DES APP			ACAS warning (resolution advisory) requires the pilot to descend or ATC calls for immediate descent (preferably during climb which requires a significant change in aircraft attitude)	x	x		x					
			CLB CRZ DES APP			ACAS warning (resolution advisory) requires the pilot to climb or ATC calls for immediate climb (preferably during descent which requires a significant change in aircraft attitude).	x	x		x					
			DES			TAWS warning when deviating from planned descent routing, requiring immediate response	x			x	x				

Assessment and training topic	Frequency	Flight phase activation	Description (includes type of topic, being threat, error or focus)	Desired outcome (includes performance criteria OR training outcome)	Guidance material (GM) Example scenario elements	PRO	COM	FPA	FPM	LTW	PSD	SAW	WLM	KNO	
EVAL or SBT		TO		attitude, speed and thrust.	Scenario immediately after take-off which requires an immediate and overweight landing			x	x	x	x				
		TO			Adverse wind, crosswinds with or without strong gusts on take-off	x			x						
		TO			Adverse weather, wind shear, wind shear encounter during take-off, with or without reactive warnings	x			x			x			
		TO			Engine failure during initial climb, typically 30-60 m (100-200 ft) (autopilot off)	x	x		x					x	
		CRZ			Wind shear encounter scenario during cruise, significant and rapid change in wind speed or down/updrafts, without wind shear warning	x		x				x	x	x	
		APP			Adverse weather, wind shear, wind shear encounter with or without warning during approach	x		x	x				x		
		APP			Adverse weather, deterioration in visibility or cloud base, or adverse wind, requiring a go-around from visual circling approach, during the visual segment	x	x	x	x			x	x	x	
		APP			Interception of the glide slope from above (correlation with unstable approach training)			x						x	x
		APP LDG			Adverse wind, crosswinds with or without strong gusts on approach, final approach and landing (within and beyond limits)	x			x			x			
		APP LDG			Adverse weather, adverse wind, approach and landing in demanding weather conditions, e.g. turbulence, up and downdrafts, gusts and crosswinds including shifting wind directions							x		x	
APP LDG	Circling approach manually flown at night in minimum in-flight visibility to ensure ground reference, minimum environmental lighting and no glide slope guidance lights	x						x			x	x			

Assessment and training topic		Frequency	Flight phase activation	Description (includes type of topic, being threat, error or focus)	Desired outcome (includes performance criteria OR training outcome)	Guidance material (GM) Example scenario elements	PRO	COM	FPA	FPM	LTW	PSD	SAW	WLM	KNO	
			APP LDG			Runway incursion during approach, which can be triggered by ATC at various altitudes or by visual contact during the landing phase	x			x			x			
			LDG			Adverse wind, visibility, type-specific, special consideration for long-bodied aircraft, landing in minimum visibility for visual reference, with crosswind	x	x		x				x		
			LDG			System malfunction, auto flight failure at DA during a low-visibility approach requiring a go-around flown manually	x		x	x				x		
			APP LDG			Approach planned autoland, followed by a failure below 1 000 ft requiring a manual go-around and an immediate landing due to fuel shortage	x		x		x			x		
			TO			In-seat instruction: Insufficient engine failure recovery, forcing the pilot monitoring to take over the flight controls		x		x				x	x	
			APP LDG			In-seat instruction: Unstable approach on short final or long landing, forcing the pilot monitoring to take over the flight controls		x		x					x	x
EVAL or SBT	Monitoring, cross-checking, error management, mismanaged	A	ALL	The scenarios should be realistic and relevant, and should be used for the purpose of demonstration and reinforcement of effective monitoring.	Recognise mismanaged aircraft state. Observe the pilot's behaviour: how the pilot is mitigating errors, performing cross-checking, monitoring performance and	Deviations from the flight path, in pitch attitude, speed, altitude, bank angle		x					x			
			ALL			In-seat instruction: Simple automation errors (e.g. incorrect mode selection, attempted engagement without the necessary conditions, entering wrong altitude or speed, failure to execute the desired mode) culminating in a need for direct intervention from the pilot monitoring, and where necessary taking control.			x					x		
			APP			In-seat instruction:	x	x					x	x		

Assessment and training topic	Frequency	Flight phase activation	Description (includes type of topic, being threat, error or focus)	Desired outcome (includes performance criteria OR training outcome)	Guidance material (GM) Example scenario elements	PRO	COM	FPA	FPM	LTW	PSD	SAW	WLM	KNO
aircraft state			<p>Modules in the FSTD should be treated like those in an aircraft so that trainees have the opportunity to develop the competency with the practice of the right techniques and attitudes related to these topics through pilot performance, and that instructors have the opportunity to assess and train these topics in a realistic environment. As shown by the EBT data report, these topics are of key importance to improve safety in operations.</p> <p>In addition, the operator may also use these topics to develop scripted role-playing scenarios in the form of ISI. These scenarios cater for the need to monitor flight path</p>	<p>dealing with a mismanaged aircraft state, in order to ensure that observed deviations, errors and mistakes are taken as learning opportunities throughout the programme.</p> <p>Monitor flight path excursions.</p> <p>Detect errors and threats through proper cross-checking performance.</p> <p>Make appropriate interventions either verbally or by taking control if applicable.</p> <p>Take appropriate action if necessary.</p> <p>Restore the desired aircraft state.</p> <p>Identify and manage consequences.</p>	<p>Unstable approach or speed/path/vertical rate not congruent with the required state for the given flight condition</p> <p>In-seat instruction: Demonstration exercise — recovery from bounced landing, adverse wind, strong gusts during landing phase, resulting in a bounce and necessitating recovery action from the pilot monitoring</p>									
		LDG				x			x					x

Assessment and training topic	Frequency	Flight phase activation	Description (includes type of topic, being threat, error or focus)	Desired outcome (includes performance criteria OR training outcome)	Guidance material (GM) Example scenario elements	PRO	COM	FPA	FPM	LTW	PSD	SAW	WLM	KNO
			excursions from the instructor pilot (PF), detect errors and make appropriate interventions, either verbally or by taking control as applicable. Demonstration scenarios may also be used. Demonstrated role-play should contain realistic and not gross errors, leading at times to a mismanaged aircraft state, which can also be combined with upset management training.											
Unstable approach	A	DES APP	Reinforce stabilised approach philosophy and adherence to defined parameters.		ATC or terrain-related environment creating a high-energy descent with the need to capture the optimum profile to complete the approach in a stabilised configuration	x		x				x		
		DES APP	Encourage go-arounds when crews are outside these parameters. Develop and sustain competencies related		ATC or terrain-related environment creating a high-energy descent leading to unstable conditions and requiring a go-around	x		x				x		
		APP			Approach and landing in demanding weather conditions, e.g. turbulence, up and downdrafts, gusts and crosswinds including shifting wind directions				x		x	x		
		APP			Increasing tailwind on final approach (not reported)	x	x				x	x		

Assessment and training topic	Frequency	Flight phase activation	Description (includes type of topic, being threat, error or focus)	Desired outcome (includes performance criteria OR training outcome)	Guidance material (GM) Example scenario elements	PRO	COM	FPA	FPM	LTW	PSD	SAW	WLM	KNO
		APP LDG	to the management of high-energy situations.		Crosswinds with or without strong gusts on approach, final approach and landing (within and beyond limits)	x			x		x			

Assessment and training topic	Frequency	Flight phase activation	Description (includes type of topic, being threat, error or focus)	Desired outcome (includes performance criteria OR training outcome)	Guidance material (GM) Example scenario elements	PRO	COM	FPA	FPM	LTW	PSD	SAW	WLM	KNO
-------------------------------	-----------	-------------------------	--	---	---	-----	-----	-----	-----	-----	-----	-----	-----	-----

Section 5 — UPRT training topic with frequency (B). Evaluation phase, manoeuvres training phase or scenario-based training phase (EVAL, MT or SBT)

EVAL, MT or SBT	Upset prevention training	B	N/A	Compliance with AMC1 or AMC2 to ORO.FC.220&230	Early recognition and prevention of upset conditions. When the differences between LHS and RHS are not significant in the handling of the aircraft, UPRT may be conducted in either seat.	See Table 1 of AMC1 ORO.FC.220&230: Elements and respective components of upset prevention training.									Intentionally blank			
			CRZ	Include upset prevention elements in Table 1 for the recurrent training programme in at least every cycle, such that all the elements are covered over a period not exceeding 3 years.														
			TO APP	The elements are numbered with letters from A to I in Table 1 of AMC1 ORO.FC.220&230. Each element is				x	x			x	x					
			CRZ															
			CRZ															
			CRZ															

Assessment and training topic	Frequency	Flight phase activation	Description (includes type of topic, being threat, error or focus)	Desired outcome (includes performance criteria OR training outcome)	Guidance material (GM) Example scenario elements	PRO	COM	FPA	FPM	LTW	PSD	SAW	WLM	KNO
			made up of several numbered components.		rise to trigger low-speed conditions (if FSTD capability exists, consider use of the vertical wind component to add realism)									
		CRZ	According to the principles of EBT, covering one component should satisfy the requirement to cover the whole element of recognising and preventing the development of upset conditions.		High-altitude loss of reliable airspeed	x	x		x			x	x	
		CRZ			High-altitude ACAS RA (where the RA is required to be flown in manual flight)	x			x			x	x	
Section 6 — Training topics with frequency (B) in alphabetical order. Evaluation phase or scenario-based training phase (EVAL or SBT)														
EVAL or SBT	Adverse wind	B	Adverse wind/crosswind. This includes tailwind but not ATC mis-reporting of the actual wind.	Recognise adverse-wind conditions. Observe limitations. Apply the appropriate procedures. Maintain directional control and safe flight path.	Take-off with different crosswind/tailwind/gust conditions						x		x	
					Take-off with unreported tailwind		x		x					
					Crosswinds with or without strong gusts on take-off	x			x					
					Wind exceeding limits on final approach (not reported)	x	x			x	x			
					Wind exceeding limits on final approach (reported) in manual aircraft control	x	x		x					
					Increasing tailwind on final approach (not reported)	x	x			x	x			
					Approach and landing in demanding weather conditions, e.g. turbulence, up and downdrafts, gusts and crosswind including shifting wind directions				x		x	x		
					Adverse-wind scenario resulting in increasing tailwind below DA (not reported)		x		x		x			

Assessment and training topic		Frequency	Flight phase activation	Description (includes type of topic, being threat, error or focus)	Desired outcome (includes performance criteria OR training outcome)	Guidance material (GM) Example scenario elements	PRO	COM	FPA	FPM	LTW	PSD	SAW	WLM	KNO
			APP			Adverse-wind scenario including strong gusts and/or crosswind out of limits below DA (not reported)		x		x		x			
			APP			Adverse-wind scenario including strong gusts and/or crosswind out of limits below 15 m (50 ft) (not reported)		x		x		x			
			APP LDG			Crosswind with or without strong gusts on approach, final approach and landing (within and beyond limits)	x			x		x			
EVAL or SBT	Aircraft system malfunctions, including operations under MEL	B	ALL	<p>Any internal failure(s) apparent or not apparent to the crew</p> <p>Any item cleared by the MEL but having an impact upon flight operations — for instance, thrust reverser locked.</p> <p>Malfunctions to be considered should have one or more of the following characteristics: Immediacy Complexity Degradation of aircraft control</p>	<p>Recognise system malfunction. Take appropriate action including correct stop/go decision. Apply the appropriate procedure correctly. Maintain aircraft control. Manage consequences.</p> <p>Apply crew operating procedures where necessary. Respond appropriately to additional system abnormalities associated with MEL dispatch.</p>	<p>(i) System malfunctions that require immediate and urgent crew intervention or decision, e.g. fire, smoke, loss of pressurisation at high altitude, failures during take-off, brake failure during landing.</p> <p>(ii) System malfunctions that require complex procedures, e.g. multiple hydraulic system failures, smoke and fumes procedures, major electrical system failure.</p> <p>(iii) System malfunctions that result in significant degradation of flight controls in combination with abnormal handling characteristics, e.g. jammed flight controls, certain degradation of FBW control, jammed horizontal stabiliser; flaps and/or slats locked; other malfunctions that result in degraded flight controls.</p> <p>(iv) System failures that require monitoring and management of the flight path using degraded or alternative displays, unreliable primary flight path information, unreliable airspeed, e.g. flight with unreliable airspeed</p> <p>(v) System failures that require extensive management of their consequences (independent of operation or environment), e.g. fuel leak.</p>	Intentionally blank								

Assessment and training topic	Frequency	Flight phase activation	Description (includes type of topic, being threat, error or focus)	Desired outcome (includes performance criteria OR training outcome)	Guidance material (GM) Example scenario elements	PRO	COM	FPA	FPM	LTW	PSD	SAW	WLM	KNO			
		TO	Loss of primary instrumentation Management of consequences The operator should vary malfunctions for each characteristic over the EBT cycle. Unless specified otherwise in the operational suitability data, at least one malfunction with each characteristic should be included in every cycle. Combining characteristics should not reduce the number of malfunctions below seven for each cycle. For each crew member, the characteristics of degraded control and loss of		MEL items with crew operating procedures applicable during take-off						x			X			
		TO			Response to an additional factor that is affected by an MEL item (e.g. system failure, runway state)		x		x		x			X			
		GND			Malfunction during preflight preparation and prior to departure	x					x	x					
		CLB			Malfunction after departure	x					x	x		X			
		ALL			Malfunctions that require immediate attention (e.g. bleed fault during engine start, hydraulic failure during taxi)	x				x				x			
		CLB CRZ			Fuel leak (management of consequences)	x				x		x			X		
		TO			Malfunction on take-off high speed below V1	x				x	x						
		TO			Malfunction on take-off high speed above V1	x					x						
		GND			During taxi to the runway, a spurious brake temperature announcement. The crew had the correct brake temperature moments before the failure.						X	X	X				
		TO			Tyre failure during take-off						x	x			x		
		TO			Malfunction on initial climb	x							x				
		APP			Malfunction on approach	x							x		x		
		APP			Malfunction on go-around	x							x		x		
		LDG			Malfunction during landing	x	x				x		x	x			

Assessment and training topic		Frequency	Flight phase activation	Description (includes type of topic, being threat, error or focus)	Desired outcome (includes performance criteria OR training outcome)	Guidance material (GM) Example scenario elements	PRO	COM	FPA	FPM	LTW	PSD	SAW	WLM	KNO	
				instrumentation should be in the role of pilot flying and the others may be in the role of pilot flying or pilot monitoring. For full details, see the malfunction equivalency methodology.												
EVAL or SBT	Aircraft system management	B	N/A	Normal system operation according to defined instructions	This is not considered as a stand-alone topic. It is linked with the topic 'compliance'. Where a system is not managed according to normal or defined procedures, this is determined as a non-compliance.	See 'compliance' topic above. There are no defined scenarios, but the instructor should focus on learning opportunities when system management non-compliances manifest themselves during other scenarios. Underpinning knowledge of systems and their interactions should be developed and challenged, and not merely the application of normal procedures.	Intentionally blank								X	
			CRZ APP LDG			Minimum fuel, caused by extended delays, weather, etc. where the crew would need to manage a minimum fuel situation.					x	x	x	x		
	Approach, visibility close to minimum	B	APP	Any situation where visibility becomes a threat	Recognise actual conditions. Observe aircraft and/or procedural limitations. Apply the appropriate procedures if applicable.	Approach in poor visibility	x		x	x					x	
			APP			Approach in poor visibility with deteriorations necessitating a decision to perform a go-around	x		x	x						
			LDG			Landing in poor visibility				x		x	x			

Assessment and training topic	Frequency	Flight phase activation	Description (includes type of topic, being threat, error or focus)	Desired outcome (includes performance criteria OR training outcome)	Guidance material (GM) Example scenario elements	PRO	COM	FPA	FPM	LTW	PSD	SAW	WLM	KNO
				Maintain directional control and safe flight path.										
Landing	B	LDG	Pilots should have opportunities to practise landings in demanding situations at the defined frequency. Data indicates that landing problems have their roots in a variety of factors, including inappropriate decision-making, in addition to manual aircraft control skills if difficult environmental conditions exist. The purpose of this item is to ensure that pilots are exposed to this during the programme.	Landing in demanding environmental conditions, with malfunctions as appropriate	This topic should be combined with the adverse-weather topic, aircraft system malfunctions topic or any topic that can provide exposure to a landing in demanding conditions.	Intentionally blank								

Assessment and training topic		Frequency	Flight phase activation	Description (includes type of topic, being threat, error or focus)	Desired outcome (includes performance criteria OR training outcome)	Guidance material (GM) Example scenario elements	PRO	COM	FPA	FPM	LTW	PSD	SAW	WLM	KNO
EVAL or SBT	Surprise	B	ALL	The data analysed during the development of the EBT concept indicated substantial difficulties encountered by crews when faced with a threat or error, which was a surprise or an unexpected event. The element of surprise should be distinguished from what is sometimes referred to as the 'startle factor' — the latter being a physiological reaction. Wherever possible, consideration should be given towards variations in the types of scenario, times of occurrences and types of occurrence, so that pilots do not become overly familiar with repetitions of the same scenarios. Variations should be the focus of EBT	Exposure to an unexpected event or sequence of events at the defined frequency in order to build resilience.	Rejected take-off	X			X		X			
						Intentionally blank									

Assessment and training topic		Frequency	Flight phase activation	Description (includes type of topic, being threat, error or focus)	Desired outcome (includes performance criteria OR training outcome)	Guidance material (GM) Example scenario elements	PRO	COM	FPA	FPM	LTW	PSD	SAW	WLM	KNO			
				programme design, and not left to the discretion of individual instructors, in order to preserve programme integrity and fairness.														
EVAL or SBT	Wind shear recovery	B	TO	With or without warnings including predictive. A wind shear scenario is ideally combined with an adverse-weather scenario containing other elements.	Anticipate potential for wind shear. Avoid known wind shear or prepare for suspected wind shear. Recognise wind shear encounter. Take appropriate action. Apply the appropriate procedure correctly. Assure aircraft control. Recognise out of wind shear condition. Maintain or restore a safe flight path. Assess consequential issues and manage outcomes.	Predictive wind shear warning during take-off					x	x						
			TO			Wind shear encounter during take-off	x				x	x						
			TO			Wind shear encounter after rotation								x		x		
			TO			Predictive wind shear after rotation								x	x			
			APP			Predictive wind shear during approach	x							x	x			
			APP			Wind shear encounter during go-around	x							x	x		x	
			APP			Wind shear encounter during approach	x								x	x		
EVAL or SBT	Workload, distraction, pressure	B	ALL	This is not considered a topic for specific attention on its own, but more as a reminder to programme	Manage available resources efficiently to prioritise and perform tasks in a timely manner under all circumstances	Intentionally blank	Intentionally blank											

Assessment and training topic		Frequency	Flight phase activation	Description (includes type of topic, being threat, error or focus)	Desired outcome (includes performance criteria OR training outcome)	Guidance material (GM) Example scenario elements	PRO	COM	FPA	FPM	LTW	PSD	SAW	WLM	KNO
	e, stress			developers to ensure that pilots are exposed to immersive training scenarios which expose them to manageable high workload and distractions during the course of the EBT programme, at the defined frequency.											

Assessment and training topic		Frequency	Flight phase activation	Description (includes type of topic, being threat, error or focus)	Desired outcome (includes performance criteria OR training outcome)	Guidance material (GM) Example scenario elements	PRO	COM	FPA	FPM	LTW	PSD	SAW	WLM	KNO	
Section 7 — UPRT Upset recovery training topic with frequency (C). Manoeuvres training phase or scenario-based training phase (MT or SBT)																
MT or SBT	Upset recovery	C	N/A	Compliance with AMC1 or AMC2 to ORO.FC.220&230	Recognise upset condition.	The example scenario elements may be done in ISI, as non-ISI or a combination of both. If done in ISI: The instructor should position the aircraft within but close to the edge of the validated training envelope before handing control to the trainee to demonstrate the restoration of normal flight. Careful consideration should be given to flying within the validated training envelope.									Intentionally blank	
				Include the recovery exercises in Table 2 of AMC1 ORO.FC.220&230 for the recurrent training programme, such	Make timely and appropriate intervention. Take appropriate action.											Table 2 of AMC1 ORO.FC.220&230: Exercises for upset recovery training
				Assure timely and appropriate intervention. (AMC1	A. Recovery from developed upsets											

Assessment and training topic	Frequency	Flight phase activation	Description (includes type of topic, being threat, error or focus)	Desired outcome (includes performance criteria OR training outcome)	Guidance material (GM) Example scenario elements	PRO	COM	FPA	FPM	LTW	PSD	SAW	WLM	KNO		
		CLB DES	that all the exercises are covered over a period not exceeding 3 years. According to the principles of EBT, covering one component should satisfy the requirement to cover the whole element of recovery from developed upsets. The same principles apply to the exercises of components 2, 3 and 4 where one exercise may satisfy the requirement to cover the whole component. An aeroplane upset is defined as an undesired aeroplane state in flight characterised	ORO.FC.220&230 Table 2 component 1) Assure aircraft control. Maintain or restore a safe flight path.	2. Recovery from stall events in the following configurations: take-off configuration, clean configuration low altitude, clean configuration near maximum operating altitude, and landing configuration during the approach phase.	x			x			x	x			
		CRZ		Assess consequential issues.	3. Recovery from nose high at various bank angles	x			x			x	x			
		CRZ		Manage outcomes.	4. Recovery from nose low at various bank angles	x			x			x	x			
		CRZ		Consolidate the summary of aeroplane recovery techniques. (AMC1 ORO.FC.220&230 Table 2 component 5)	Demonstration at a normal cruising altitude. Set conditions and disable aircraft systems as necessary to enable trainee to perform stall recovery according to OEM instructions.	x			x			x				
		APP		Note: The operator should assess if the exercises should be practised for the either seat qualification.	Demonstration at an intermediate altitude during early stages of the approach. Set conditions and disable aircraft systems as necessary to enable trainee to perform stall recovery according to OEM instructions.	x			x			x				
		CLB DES			Recovery from a wake turbulence position with high-bank angle	x			x	x			x			

Assessment and training topic		Frequency	Flight phase activation	Description (includes type of topic, being threat, error or focus)	Desired outcome (includes performance criteria OR training outcome)	Guidance material (GM) Example scenario elements	PRO	COM	FPA	FPM	LTW	PSD	SAW	WLM	KNO
				by unintentional divergences from parameters normally experienced during line operations or training. An aeroplane upset may involve pitch and/or bank angle divergences as well as inappropriate airspeeds for the conditions.											

Assessment and training topic		Frequency	Flight phase activation	Description (includes type of topic, being threat, error or focus)	Desired outcome (includes performance criteria OR training outcome)	Guidance material (GM) Example scenario elements	PRO	COM	FPA	FPM	LTW	PSD	SAW	WLM	KNO
-------------------------------	--	-----------	-------------------------	--	---	---	-----	-----	-----	-----	-----	-----	-----	-----	-----

Section 8 — Training topics with frequency (C) in alphabetical order. Evaluation phase or scenario-based training phase (EVAL or SBT)																
EVAL or SBT	ATC	C	ALL	ATC error. Omission, miscommunication, garbled, poor quality transmission. All these act as distractions to be managed by the crew. The scenarios should be combined,	Respond to communications appropriately. Recognise, clarify and resolve any ambiguities. Refuse or question unsafe instructions.	ATC role-play: the instructor provides scripted instructions, as a distraction to the crew	x	x			x					
			ALL			Controller error, provided by the instructor according to a defined scripted scenario	x	x				x	x			
			ALL			Frequency congestion, with multiple aircraft using the same frequency		x								
			APP			Destination temporarily closed					x	x	x	x		
			CRZ			Rescue and firefighting services (RFFS) level reduction at destination		x			x		x			

Assessment and training topic	Frequency	Flight phase activation	Description (includes type of topic, being threat, error or focus)	Desired outcome (includes performance criteria OR training outcome)	Guidance material (GM) Example scenario elements	PRO	COM	FPA	FPM	LTW	PSD	SAW	WLM	KNO		
		APP	where possible, with others of the same or higher weighting, the principal reason being to create distractions.	Use standard phraseology whenever possible.	Runway change before the interception of the localiser or similar navigation aid in azimuth			x		x		x	x			
		GND/TO			Stray dogs at the opposite threshold runway		x		x		x					
		ALL			Poor quality transmissions		x									
EVAL or SBT	Engine failure	C	Any engine failure or malfunction, which causes loss or degradation of thrust that affects performance. This is distinct from the engine-out manoeuvres described in the MT section above, which are intended only to practise psychomotor skills and reinforce procedures to manage engine failures.	Recognise engine failure. Take appropriate action. Apply the appropriate procedure correctly. Maintain aircraft control. Manage consequences.	Engine failure or engine malfunction on take-off low speed	x			x		x		x			
					TO	Engine failure or engine malfunction on take-off high speed below V1	x			x		x		x		
					TO	Engine failure or engine malfunction on take-off above V1	x					x	x	x		
					TO	Engine failure or engine malfunction on initial climb	x					x	x			
					APP	Engine malfunction	x					x		x		
					CRZ	Engine failure in cruise (with autopilot)	x		x					x		
					CRZ	Multiple engine failure in CRZ (volcanic ash, recoverable). Competency FPM may or may not be included depending on the impact on the automation.							x	x	x	x
LDG	Engine failure or engine malfunction on landing							x								
EVAL or SBT	Fire and smoke management	C	This includes engine, electric, pneumatic, cargo fire, smoke or fumes.	Recognise fire, smoke or fumes. Take appropriate action. Apply the appropriate procedure correctly.	Fire in cargo or cabin/cockpit at gate	x	x				x		x			
					GND	Fire during taxi	x	x				x		x	X	
					GND	Fire with no cockpit indication	x	x				x		x	X	
					TO	Take-off low speed	x			x	x	x			X	
					TO	Fire or smoke on take-off high speed below V1	x			x	x	x				
					TO	Fire or smoke on take-off high speed above V1	x				x	x				

Assessment and training topic		Frequency	Flight phase activation	Description (includes type of topic, being threat, error or focus)	Desired outcome (includes performance criteria OR training outcome)	Guidance material (GM) Example scenario elements	PRO	COM	FPA	FPM	LTW	PSD	SAW	WLM	KNO	
			TO		Maintain aircraft control. Manage consequences.	Fire or smoke on Initial climb	x				x	x				
			CRZ			Cargo compartment fire or avionics compartment fire.					x	x	x			
			APP			Engine fire in approach (extinguishable)		x			x					
			APP			Engine fire in approach (non-extinguishable)		x			x	x				
			CLB			Lithium battery fire in the cockpit or cabin compartment	x	x			x	x			x	
			CRZ				Flight deck or cabin fire		x			x	x			X
			DES			Any of the example scenario elements above ending in an evacuation			x			x	x			x
			APP													
GND																
EVAL of SBT	Loss of communications	C	GND	Lost or difficult communications due to either pilot mis-selection or a failure external to the aircraft. This could be for a few seconds or a total loss.	Recognise loss of communications. Take appropriate action. Execute the appropriate procedure as applicable. Use alternative ways to communicate. Manage consequences.	Loss of communications during ground manoeuvring	x	x								
			TO			Loss of communications after take-off	x				x				X	
			APP			Loss of communications during approach phase, including go-around	x	x			x	x			X	

Assessment and training topic	Frequency	Flight phase activation	Description (includes type of topic, being threat, error or focus)	Desired outcome (includes performance criteria OR training outcome)	Guidance material (GM) Example scenario elements	PRO	COM	FPA	FPM	LTW	PSD	SAW	WLM	KNO		
EVAL or SBT Managing loading, fuel, performance errors	C	ALL	A calculation error by one or more pilots, or someone involved with the process, or the process itself, e.g. incorrect information on the load sheet	Anticipate the potential for errors in load/fuel/performance data. Recognise inconsistencies. Manage/avoid distractions. Make changes to paperwork/aircraft system(s) to eliminate error. Identify and manage consequences.	This can be a demonstrated error, in that the crew may be instructed to deliberately insert incorrect data — for example, to take off from an intersection with full-length performance information. The crew will be asked to intervene when acceleration is sensed to be lower than normal, and this may be part of the operator procedures, especially when operating mixed fleets with considerable variations in MTOM.	x	x						x			
		TO			Wind report with take-off clearance not consistent with prior performance calculation. ATC, cabin crew or other people are pushing crew to take off quickly.	x				x		x	x			
		GND			Environmental change during taxi (e.g. heavy rain) not consistent with prior take-off performance calculation								x	x		
		GND			Fuel ground staff on industrial action. Only limited amount of fuel available, which is below the calculated fuel for the flight						x	x	x	x		
		GND			Advise crew that there is a change of the load sheet figures during taxi to the runway. The crew may have limited time due to a calculated take-off time (CTOT) — ATC slot.	x									x	
		GND			Braking action reported 'medium'. The information is transmitted just before take-off. The flight is subject to a CTOT — ATC slot.							x		x	x	
		GND														
EVAL or SBT Navigation	C	GND	External NAV failure. Loss of GPS satellite, ANP exceeding RNP, loss of external NAV source(s)	Recognise a NAV degradation. Take appropriate action.	External failure or a combination of external failures degrading aircraft navigation performance on ground	x		x			x	x				
		TO CLB APP LDG			External failure or a combination of external failures degrading aircraft navigation performance in flight		x		x	x	x					

Assessment and training topic	Frequency	Flight phase activation	Description (includes type of topic, being threat, error or focus)	Desired outcome (includes performance criteria OR training outcome)	Guidance material (GM) Example scenario elements	PRO	COM	FPA	FPM	LTW	PSD	SAW	WLM	KNO	
		GND		Execute the appropriate procedure as applicable. Use alternative NAV guidance. Manage consequences.	Standard initial departure change during taxi. The flight may be subject to a CTOT — ATC slot.					x		x	x		
		APP			Loss of runway lighting below decision height		x			x	x				
		CRZ			No fly zone: when the crew changes control frequency, the new ATCO informs the crew that they are flying over an unannounced 'no fly zone' that is not included in the NOTAMs. (To trigger such an event, the context may be as follows: an unexpected military conflict in the territory the aircraft is flying over or the crew is forced to re-route in flight and the new route flies over a city that has an important event such the Olympic games, a G20/G7 submit, or the route is flying near a space rocket launch close to the time of the launch, like the Guiana Space Centre, Cape Cañaverl, etc.).					x	x	x			
Operations- or type-specific	C	ALL	Intentionally blank	Intentionally blank	Intentionally blank	Intentionally blank									
Operations of special airport approval	C	APP LDG	See equivalency of approaches relevant to operations.	The operator should comply with the national qualification requirements published in the AIP.	Intentionally blank	Intentionally blank									
EVAL or SBT	Pilot incapacitation	C	TO	Consequences for the non-incapacitated pilot	Recognise incapacitation. Take appropriate action including correct stop/go decision.	During take-off	x	x			x	x			X
			APP			During approach	x			x				x	X

Assessment and training topic	Frequency	Flight phase activation	Description (includes type of topic, being threat, error or focus)	Desired outcome (includes performance criteria OR training outcome)	Guidance material (GM) Example scenario elements	PRO	COM	FPA	FPM	LTW	PSD	SAW	WLM	KNO			
				Apply the appropriate procedure correctly. Maintain aircraft control. Manage consequences.													
Runway or taxiway condition	C	GND TO LDG	Contamination or surface quality of the runway, taxiway, or tarmac including foreign objects	Recognise hazardous runway condition. Observe limitations. Take appropriate action. Apply the appropriate procedures correctly. Assure aircraft control.	Planned anticipated hazardous conditions with dispatch information provided to facilitate planning and execution of appropriate procedures						x			X			
		GND TO LDG			Unanticipated hazardous conditions, e.g. unexpected heavy rain resulting in flooded runway surface		x			x	x						
		TO			Take-off on runway with reduced cleared width due to snow	x				x	x		x				
		TO			Stop/go decision in hazardous conditions						x	x			x		
EVAL or SBT	Terrain	C	Alert, warning, or conflict	Anticipate terrain threats. Prepare for terrain threats. Recognise unsafe terrain clearance. Take appropriate action. Apply the appropriate procedures correctly. Maintain aircraft control. Restore safe flight path.	ATC clearance giving insufficient terrain clearance	x	x				x				X		
					Demonstration of terrain avoidance warning systems (TAWS) (this scenario element may be done in an ISI.)							x	x	x			
					Engine failure where performance is marginal leading to TAWS warning		x									x	
					ATC provides a wrong QNH		x								x		
					'Virtual mountain' refers to the surprise element of an unexpected warning. Care should be exercised in creating a level of realism, so this can best be achieved by an unusual and unexpected change of route during the descent.											x	x

Assessment and training topic	Frequency	Flight phase activation	Description (includes type of topic, being threat, error or focus)	Desired outcome (includes performance criteria OR training outcome)	Guidance material (GM) Example scenario elements	PRO	COM	FPA	FPM	LTW	PSD	SAW	WLM	KNO
Traffic	C	CLB CRZ DES	Traffic conflict. ACAS RA or TA, or visual observation of conflict, which requires evasive manoeuvring	<p>Manage consequences.</p> <p>Anticipate potential loss of separation. Recognise loss of separation. Take appropriate action. Apply the appropriate procedure correctly. Maintain aircraft control. Manage consequences.</p>	ACAS warning that requires crew intervention		x				x	x	x	
					Dilemma: Visual acquisition of conflicting traffic followed by an ACAS warning (resolution advisory) triggered by the same or other traffic. Even if the traffic is in sight, the pilot should follow the RA.	x		x	x					

Assessment and training topic	Frequency	Flight phase activation	Description (includes type of topic, being threat, error or focus)	Desired outcome (includes performance criteria OR training outcome)	Guidance material (GM) Example scenario elements	PRO	COM	FPA	FPM	LTW	PSD	SAW	WLM	KNO
					<p>While in descent, ACAS warning (traffic advisory) of an aircraft below. The crew should not initiate an avoidance manoeuvre based on TA (except decreasing the rate of descent unless otherwise instructed by ATC, etc.). This example scenario can be done during climb with conflicting traffic above.</p>	x				x	x			

END GEN3 JET

AMC4 ORO.FC.232 EBT programme assessment and training topics

ED Decision 2022/014/R

GENERATION 3 (TURBOPROP) — TABLE OF ASSESSMENT AND TRAINING TOPICS

Assessment and training topic		Frequency	Description (includes type of topic, being threat, error or focus)	Desired outcome (includes performance criteria OR training outcome)	Flight phase activation	Guidance material (GM) Example scenario elements	PRO	COM	FPA	FPM	LTW	PSD	SAW	WLM	KNO
Generation 3 Turboprop — Recurrent assessment and training matrix							Competency map								
Section 1 — Skill retention. Manoeuvres training phase (MT)															
MT	Rejected take-off	A	Rejected take-off after the application of take-off thrust and before reaching V1 (may be in LVOs or CAT I or above)	Demonstrate manual aircraft control skills with smoothness and accuracy as appropriate to the situation.	TO	From initiation of take-off to complete stop (or as applicable to the procedure)	x			x					
	Failure of the critical engine between V1 and V2	A	Failure of the critical engine from V1 and before reaching V2 in the lowest CAT I visibility or in LVO meteorological (MET) conditions.	Detect deviations through instrument scanning. Maintain spare mental capacity during manual aircraft control. Maintain the aircraft within the flight envelope.	TO	The manoeuvre is complete at a point when the aircraft is stabilised at normal engine-out climb speed with the correct pitch and lateral control, in trim condition and, as applicable, autopilot engagement. Only one failure of the critical engine between V1 and V2 a year may be done in LVO conditions.	x			x					
	Failure of one engine on take-off	B	Failure of one engine from V1 and before reaching V2 in the lowest CAT I visibility or in LVO MET conditions.	Apply knowledge of the relationship between aircraft attitude, speed and thrust.	TO	The manoeuvre is complete at a point when the aircraft is stabilised in a clean configuration with engine-out procedures completed. Only one failure of the critical engine between V1 and V2 a year may be done in LVO conditions.	x			x					

Assessment and training topic	Frequency	Description (includes type of topic, being threat, error or focus)	Desired outcome (includes performance criteria OR training outcome)	Flight phase activation	Guidance material (GM) Example scenario elements	PRO	COM	FPA	FPM	LTW	PSD	SAW	WLM	KNO
						Competency map								
Generation 3 Turboprop — Recurrent assessment and training matrix														
Emergency descent Engine-out approach & landing	C	Failure of one engine above V2 (any segment of the TO) in the lowest CAT I visibility or in LVO MET conditions.			The manoeuvre is complete at a point when the aircraft is stabilised in a clean configuration with engine-out procedures completed.	x		x	x					
		Initiation of emergency descent from normal cruise altitude			CRZ	The manoeuvre is complete once the aircraft is stabilised in emergency descent configuration (and profile). However, if the EBT programme does not include the example scenario element 'emergency descent' in the training topic 'automation management', the emergency descent procedures should be completed and should not stop once the aircraft is stabilised in emergency descent configuration.	x		x	x				
	A	With the critical engine (if applicable) failed, normal landing			LDG	Initiation in a stabilised engine-out configuration from not less than 3 NM final approach, until completion of roll-out	x			x				

Assessment and training topic	Frequency	Description (includes type of topic, being threat, error or focus)	Desired outcome (includes performance criteria OR training outcome)	Flight phase activation	Guidance material (GM) Example scenario elements	PRO	COM	FPA	FPM	LTW	PSD	SAW	WLM	KNO				
						Competency map												
Generation 3 Turboprop — Recurrent assessment and training matrix																		
Engine-out approach & go-around	A	With the critical engine (if applicable) failed, manually flown normal precision approach to DA, followed by a manual go-around — the whole manoeuvre to be flown without visual reference		APP	This manoeuvre should be flown from intercept to centreline until acceleration after go-around. The manoeuvre is complete at a point when the aircraft is stabilised at normal engine-out climb speed with the correct pitch and lateral control, in trim condition and, as applicable, autopilot engagement (describe generally the critical part of the manoeuvre).	x			x									
						Go-around	A	Go-around, all engines operative	APP	High energy, initiation during the approach at 150 to 300 m (500 to 1 000 ft) below the missed approach level-off altitude	x		x	x				
										Initiation of a go-around from DA followed by visual circuit and landing	x		x	x				
										During flare/rejected landing	x		x	x				
Pilot qualification to operate in either pilot's seat	B	As per ORO.FC.235		APP	Complete the manoeuvres mandated in ORO.FC.235.	Intentionally left in blank.												

Section 2 — Equivalency of approaches relevant to operations. Evaluation phase, manoeuvres training phase or scenario-based training phase (EVAL, MT or SBT)														
MT	Approach type A or B	B	Approach type A or B flight method 3D	See equivalency of approaches relevant to operations that place an additional demand on a proficient crew	APP	See equivalency of approaches relevant to operations	x		x	x			x	x
	Approach type A	B	Approach type A flight method 2D	See equivalency of approaches relevant to operations that place an additional demand on a proficient crew	APP	See equivalency of approaches relevant to operations	x		x	x			x	x
EVAL or SBT	Approach type A	B	Approach type A flight method 3D or 2D	See equivalency of approaches relevant to operations that place an additional demand on a proficient crew	APP	See equivalency of approaches relevant to operations	x		x	x			x	x
	Approach type B	B	Approach type B flight method 3D	See equivalency of approaches relevant to operations that place an additional demand on a proficient crew	APP	See equivalency of approaches relevant to operations	x		x	x			x	x
Section 3 — Equivalency of approaches under specific approvals and Take-off under specific approvals. Evaluation phase, manoeuvres training phase or scenario-based training phase (EVAL, MT or SBT)														
MT	SPA approach(es)	B	Approach requiring specific approval	See equivalency of approaches relevant to operations — specific approval	APP	Approaches flown from FAF to landing or go-around	x		x	x				
EVAL or SBT	SPA approach(es)	B	Approach requiring specific approval	See equivalency of approaches relevant to operations — specific approval	APP	Approaches flown from FAF to landing or go-around	x		x	x				

EVAL, MT or SBT	SPA rejected take-off (RTO)	<p>B</p> <p>Engine failure after the application of take-off thrust and before reaching V1 (in low-visibility MET conditions, preferably in the lowest approved visibility)</p> <p>Low-visibility RTO is not required under Part SPA but instead in Appendix 9 Section 6.</p> <p>Note: AMC1 SPA.LVO.120 point (f) does not require a low-visibility RTO. RTO is required only in the initial LVO course (point (g)(1)(iii) of AMC1 SPA.LVO.120).</p>	<p>Demonstrate manual aircraft control skills with smoothness and accuracy as appropriate to the situation.</p> <p>Detect deviations through instrument scanning.</p> <p>Maintain spare mental capacity during manual aircraft control.</p>	TO	<p>RTO — can be combined with the assessment and training topic ‘surprise’ in EVAL or SBT</p>	x			x					
VAL, MT or SBT	LVTO	<p>B</p> <p>Notwithstanding AMC1 SPA.LVO120 point (f)(1)</p> <p>AMC1 SPA.LVO.120 requires SPA manoeuvres in the frequency of the OPC, as OPC is substituted in the EBT programme. Thus, the frequency in EBT is determined in every cycle (B).</p> <p>Low-visibility take-off, preferably in the lowest approved visibility</p>	<p>Maintain the aircraft within the flight envelope.</p> <p>Apply knowledge of the relationship between aircraft attitude, speed and thrust.</p>	TO	<p>The manoeuvre is complete at a point when the aircraft is stabilised at normal climb speed with the correct pitch and lateral control, in trim condition and, as applicable, autopilot engagement.</p>	x			x					

Assessment and training topic	Frequency	Flight phase activation	Description (includes type of topic, being threat, error or focus)	Desired outcome (includes performance criteria OR training outcome)	Guidance material (GM) Example scenario elements	PRO	COM	FPA	FPM	LTW	PSD	SAW	WLM	KNO					
Generation 3 Turboprop — Recurrent assessment and training matrix						Competency map													
Section 4 — Training topics with frequency (A) in alphabetical order. Evaluation phase or scenario-based training phase (EVAL or SBT)																			
EVAL or SBT	Adverse weather	A	Thunderstorm, heavy rain, turbulence, ice build-up to include de-icing issues, as well as high-temperature conditions. The proper use of anti-ice and de-icing systems should be included generally in appropriate scenarios.	Anticipate adverse weather. Prepare for suspected adverse weather. Recognise adverse weather. Take appropriate action. Apply the appropriate procedure correctly. Assure aircraft control.	Predictive wind shear warning before take-off, as applicable	x	x				x								
					Adverse-weather scenario, e.g. thunderstorm activity, precipitation, icing		x			x	x		x						
					Wind shear encounter during take-off, not predictive	x			x			x			x				
					Predictive wind shear warning during take-off	x	x							x	x				
					Crosswinds with or without strong gusts on take-off	x			x										
					Turbulence that increases to severe turbulence		x						x			x	x		
					Wind shear encounter scenario during cruise	x			x						x	x	x		
					Reactive wind shear warning during approach or go-around	x			x	x						x			
					Predictive wind shear warning during approach or go-around	x	x									x	x		
					Thunderstorm encounter during approach or on missed approach	x										x	x		
					Increasing tailwind on final approach (not reported)	x	x									x	x		
					Approach and landing in demanding weather conditions, e.g. turbulence, up and downdrafts, gusts and crosswinds including shifting wind directions									x		x	x		

Assessment and training topic		Frequency	Flight phase activation	Description (includes type of topic, being threat, error or focus)	Desired outcome (includes performance criteria OR training outcome)	Guidance material (GM) Example scenario elements	PRO	COM	FPA	FPM	LTW	PSD	SAW	WLM	KNO
Generation 3 Turboprop — Recurrent assessment and training matrix							Competency map								
			APP			Non-precision approach in cold-temperature conditions, requiring altitude compensation for temperature, as applicable to the type	x	x					x		
			APP LDG			Crosswinds with or without strong gusts on approach, final approach and landing (within and beyond limits)	x			x		x			
			APP			In approach, unexpected braking action 'good to medium' reported by the preceding aircraft		x				x	x	x	
			APP			Moderate to severe icing conditions during approach effecting aircraft performance	x	x				x	x		
			APP			Reduced visibility even after acquiring the necessary visual reference during approach, due to rain or fog	x	x				x			
EVAL or SBT	Automation management	A	CLB CRZ DES APP	The purpose of this topic is to encourage and develop effective flight path management through proficient and appropriate use of the flight management system(s), guidance and	Know how and when to use the flight management system(s), guidance and automation. Demonstrate correct methods for engagement and disengagement of the auto flight system(s). Demonstrate appropriate use of flight	ACAS warning (resolution advisory), recovery and subsequent engagement of automation	x		x						
			ALL			FMS tactical programming issues, e.g. step climb, runway changes, late clearances, destination re-programming, executing diversion	x		x						x
			CLB CRZ DES APP			Recoveries from TAWS, management of energy state to restore automated flight	x		x	x					

Assessment and training topic	Frequency	Flight phase activation	Description (includes type of topic, being threat, error or focus)	Desired outcome (includes performance criteria OR training outcome)	Guidance material (GM) Example scenario elements	PRO	COM	FPA	FPM	LTW	PSD	SAW	WLM	KNO	
Generation 3 Turboprop — Recurrent assessment and training matrix						Competency map									
		CLB	automation, including transitions between modes, monitoring, mode awareness, vigilance and flexibility needed to change from one mode to another. The means of mitigating errors are included in this topic. The errors are described as mishandled auto flight systems, inappropriate mode selection, mishandled flight management system(s) and inappropriate autopilot usage.	guidance, auto thrust and other automation systems. Maintain mode awareness of the auto flight system(s), including engagement and automatic transitions. Revert to different modes when appropriate. Detect deviations from the desired aircraft state (flight path, speed, attitude, thrust, etc.) and take appropriate action. Anticipate mishandled auto flight system. Recognise mishandled auto flight system. Take appropriate action if necessary. Restore correct auto flight state. Identify and manage consequences.	Amendments to ATC cleared levels during altitude capture modes to force mode awareness and intervention	x		x				x			
		CRZ			ACAS warning (resolution advisory to level off) during climb or descent; for example, close to the cleared level when the capture mode has already been activated.	x		x					x		
		DES			Late ATC clearance to an altitude below acceleration altitude	x		x					x		
		APP			Engine-out special terrain procedures	x		x					x		
		TO			Forcing autopilot disconnect followed by re-engagement, recovery from low- or high-speed events in cruise	x		x	x				x		
		TO APP			Engine failure during or after initial climb using automation	x		x							
		CRZ			Engine failure in cruise to onset of descent using automation	x		x							
		CLB			Emergency descent	x		x							x
		CRZ			Managing high-energy descent capturing descent path from above (correlation with unstable approach training)	x		x					x		x
		CRZ			No ATC clearance received prior to commencement of approach or final descent	x		x					x		
		DES APP	Reactive wind shear and recovery from the consequent high-energy state	x		x					x				
		APP													
		APP													

Assessment and training topic		Frequency	Flight phase activation	Description (includes type of topic, being threat, error or focus)	Desired outcome (includes performance criteria OR training outcome)	Guidance material (GM) Example scenario elements	PRO	COM	FPA	FPM	LTW	PSD	SAW	WLM	KNO	
Generation 3 Turboprop — Recurrent assessment and training matrix							Competency map									
			APP			Automation fail to capture the approach altitude in descent (e.g. last altitude before the FAP). Ideally, the failure occurs when the workload is high (e.g. configuration of the aircraft for final approach).					x	x	x	x		
			APP			Non-precision or infrequently flown approaches using the maximum available level of automation	x		x							x
			APP			Gear malfunction during an approach planned with autoland (including autobrake). Competency FPA may or may not be included depending on the impact of such malfunction on the automation.		x			x					x
			APP			ATC clearances to waypoints beyond the programmed descent point for a coded final descent point during an approach utilising a final descent that is commanded by the flight management system	x		x						x	
EVAL or SBT	Competencies — non-technical (CRM)	A	APP	This encapsulates the general CRM principles and objectives. It includes communication; leadership and	Exposure to an event or sequence of events to allow the pilot to build awareness of human factors in aviation and the human limitations.	GPS failure prior to commencement of approach associated with position drift and a terrain alert					x	x	x		x	
			DES			Cabin crew report of water noise below the forward galley indicating a possible toilet pipe leak, with consequent avionics failures					x	x	x			

Assessment and training topic	Frequency	Flight phase activation	Description (includes type of topic, being threat, error or focus)	Desired outcome (includes performance criteria OR training outcome)	Guidance material (GM) Example scenario elements	PRO	COM	FPA	FPM	LTW	PSD	SAW	WLM	KNO		
						Competency map										
Generation 3 Turboprop — Recurrent assessment and training matrix																
		CRZ	teamwork; problem-solving and decision-making; situation awareness and management of information; and workload management. Emphasis should be placed on the development of leadership, shown by EBT data sources to be a highly effective competency in mitigating risk and improving safety through pilot performance.	This includes the development of the following competencies: <u>Communication:</u> Demonstrate: — effective use of language; — responsiveness to feedback; and — capability to state the plans and resolve ambiguities. <u>Leadership and teamwork:</u> Use appropriate authority to ensure focus on the task. Support others in completing tasks. <u>Problem-solving and decision-making:</u> Detect deviations from the desired state, evaluate problems, identify the risk, consider alternatives and select the best course of action. Continuously	Smoke removal but combined with a diversion until landing is completed.		x			x	x	x	x	x		
		GND			Apron fuel spillage					x	x			x		
		CRZ			Important water leak in an aircraft galley			x			x	x			x	
		ALL			A relevant number of cabin crew are wounded or incapacitated. Additionally, the cabin crew wounded or incapacitated are the most competent (e.g. senior cabin crew member).						x	x			x	
		ALL			Unruly passenger(s)						x				x	
		GND			Passenger oxygen: passenger service unit open and mask falling down						x	x			x	
		ALL			Passenger with medical problems — medical emergency						x				x	
		CRZ			Credible threat reported to the crew. Stowaway or fugitive on board.			x			x			x	x	
		GND			No METAR or TAFOR is available for destination due to industrial action at the destination airport		x	x			x	x				
		CRZ			Credible bomb threat reported to crew			x			x			x	x	
		CLB DES	Credible bomb threat or pressurisation problem, but no quick landing possible (due to weather, terrain or other reasons)			x			x	x			x			
		APP	Diversion with low remaining fuel or increased fuel flow due to system malfunction		x				x			x	x			

Assessment and training topic		Frequency	Flight phase activation	Description (includes type of topic, being threat, error or focus)	Desired outcome (includes performance criteria OR training outcome)	Guidance material (GM) Example scenario elements	PRO	COM	FPA	FPM	LTW	PSD	SAW	WLM	KNO
Generation 3 Turboprop — Recurrent assessment and training matrix							Competency map								
<p>EBT or SBT</p>			APP	<p>review progress and adjust plans. <u>Situation awareness and management of information:</u> Have an awareness of the aircraft state in its environment; project and anticipate changes. <u>Workload management:</u> Prioritise, delegate and receive assistance to maximise focus on the task. Continuously monitor the flight progress.</p>	<p>review progress and adjust plans. <u>Situation awareness and management of information:</u> Have an awareness of the aircraft state in its environment; project and anticipate changes. <u>Workload management:</u> Prioritise, delegate and receive assistance to maximise focus on the task. Continuously monitor the flight progress.</p>	<p>ACAS warning (resolution advisory) immediately following a go-around, with a descent manoeuvre required. (The RA should be a command for descent when the aircraft is above 1 100 ft AGL.)</p>		x			x	x	x	x	
<p>EBT or SBT</p>	Compliance	A	ALL	<p>Compliance failure. Consequences of not complying with operating instructions (e.g. SOPs). This is not intended to list example scenario elements, but instructors should ensure that</p>	<p>Recognise that a compliance failure has occurred. Make a verbal announcement. Take appropriate action if necessary. Restore safe flight path if necessary. Manage consequences.</p>	<p>The following are examples of potential compliance failures and are not intended to be developed as scenarios as part of an EBT module:</p> <ol style="list-style-type: none"> Requesting flap beyond limit speed Flaps or slats in the wrong position for phase of flight or approach 	Intentionally blank								

Assessment and training topic		Frequency	Flight phase activation	Description (includes type of topic, being threat, error or focus)	Desired outcome (includes performance criteria OR training outcome)	Guidance material (GM) Example scenario elements	PRO	COM	FPA	FPM	LTW	PSD	SAW	WLM	KNO
Generation 3 Turboprop — Recurrent assessment and training matrix							Competency map								
				observed non-compliances are taken as learning opportunities throughout the programme. In all modules of the programme, the FSTD should as far as possible be treated like an aircraft, and non-compliances should not be accepted simply for expediency.		3. Omitting an action as part of a procedure 4. Failing to initiate or complete a checklist 5. Using the wrong checklist for the situation									
EVAL or SBT	Go-around management	A	APP	Any threat or error that can result in circumstances that require a decision to perform a go-around, in addition to the execution of the go-around. Go-around scenarios should be fully		Adverse-weather scenario leading to a reactive wind shear warning during approach	x	x					x	x	
			APP			Adverse-weather scenario leading to a predictive wind shear warning during approach or go-around	x	x					x	x	
			APP			Adverse-weather scenario, e.g. thunderstorm activity, heavy precipitation or icing forcing decision at or close to DA/MDA	x						x	x	x

Assessment and training topic	Frequency	Flight phase activation	Description (includes type of topic, being threat, error or focus)	Desired outcome (includes performance criteria OR training outcome)	Guidance material (GM) Example scenario elements	PRO	COM	FPA	FPM	LTW	PSD	SAW	WLM	KNO	
Generation 3 Turboprop — Recurrent assessment and training matrix						Competency map									
		APP	developed to encourage effective leadership and teamwork, in addition to problem-solving and decision-making, plus execution using manual aircraft control or the flight management system(s) and automation as applicable. Design should include the element of surprise, and scenario-based go-arounds should not be predictable and anticipated. This topic is completely distinct from the go-around manoeuvre listed in the MT section that is		DA with visual reference in heavy precipitation with doubt about the runway surface braking capability	x					x	x	x		
		APP			Adverse-wind scenario resulting in increasing tailwind below DA (not reported)		x		x		x				
		APP			Adverse-wind scenario including strong gusts and/or crosswind out of limits below DA (not reported)		x		x		x				
		APP			Adverse-wind scenario including strong gusts and/or crosswind out of limits below 15 m (50 ft) (not reported)		x		x		x				
		APP			Lost or difficult communications resulting in no approach clearance prior to commencement of approach or final descent	x		x					x		
		APP			Birds: large flocks of birds below DA once visual reference has been established				x		x	x			
		APP			System malfunction, landing gear malfunction during the approach										

Assessment and training topic		Frequency	Flight phase activation	Description (includes type of topic, being threat, error or focus)	Desired outcome (includes performance criteria OR training outcome)	Guidance material (GM) Example scenario elements	PRO	COM	FPA	FPM	LTW	PSD	SAW	WLM	KNO
Generation 3 Turboprop — Recurrent assessment and training matrix							Competency map								
				intended only to practise psychomotor skills and a simple application of the procedures.											
EVAL or SBT	Manual aircraft control	A	CLB CRZ DES APP	Controls the flight path through manual control	Demonstrate manual aircraft control skills with smoothness and accuracy as appropriate to the situation. Detect deviations through instrument scanning. Maintain spare mental capacity during manual aircraft control. Maintain the aircraft within the normal flight envelope. Apply knowledge of the relationship between aircraft attitude, speed and thrust.	Flight with unreliable airspeed, which may or may not be recoverable	x			x			x		x
			CLB CRZ DES APP			Alternate flight control modes according to malfunction characteristics	x			x			x		
			CLB CRZ DES APP			ACAS warning (resolution advisory) requires the pilot to descend or ATC calls for immediate descent (preferably during climb which requires a significant change in aircraft attitude)	x	x		x					
			CLB CRZ DES APP			ACAS warning (resolution advisory) requires the pilot to climb or ATC calls for immediate climb (preferably during descent which requires a significant change in aircraft attitude).	x	x		x					
			DES			TAWS warning when deviating from planned descent routing, requiring immediate response	x			x	x				

Assessment and training topic	Frequency	Flight phase activation	Description (includes type of topic, being threat, error or focus)	Desired outcome (includes performance criteria OR training outcome)	Guidance material (GM) Example scenario elements	PRO	COM	FPA	FPM	LTW	PSD	SAW	WLM	KNO
Generation 3 Turboprop — Recurrent assessment and training matrix						Competency map								
		TO			Scenario immediately after take-off which requires an immediate and overweight landing			x	x	x	x			
		TO			Adverse wind, crosswinds with or without strong gusts on take-off	x			x					
		TO			Adverse weather, wind shear, wind shear encounter during take-off, with or without reactive warnings	x			x			x		
		TO			Engine failure during initial climb, typically 30-60 m (100-200 ft) (autopilot off)	x	x		x					x
		CRZ			Wind shear encounter scenario during cruise, significant and rapid change in wind speed or down/updrafts, without wind shear warning	x		x			x	x	x	
		APP			Adverse weather, wind shear, wind shear encounter with or without warning during approach	x		x	x			x		
		APP			Adverse weather, deterioration in visibility or cloud base, or adverse wind, requiring a go-around from visual circling approach, during the visual segment	x	x	x	x		x	x	x	
		APP			Interception of the glide slope from above (correlation with unstable approach training)			x				x	x	
		APP LDG			Adverse wind, crosswinds with or without strong gusts on approach, final	x			x		x			

Assessment and training topic	Frequency	Flight phase activation	Description (includes type of topic, being threat, error or focus)	Desired outcome (includes performance criteria OR training outcome)	Guidance material (GM) Example scenario elements	PRO	COM	FPA	FPM	LTW	PSD	SAW	WLM	KNO
Generation 3 Turboprop — Recurrent assessment and training matrix						Competency map								
					approach and landing (within and beyond limits)									
		APP LDG			Adverse weather, adverse wind, approach and landing in demanding weather conditions, e.g. turbulence, up and downdrafts, gusts and crosswinds including shifting wind directions				x		x	x		
		APP LDG			Circling approach manually flown at night in minimum in-flight visibility to ensure ground reference, minimum environmental lighting and no glide slope guidance lights	x			x			x	x	
		APP LDG			Runway incursion during approach, which can be triggered by ATC at various altitudes or by visual contact during the landing phase	x			x			x		
		LDG			Adverse wind, visibility, type-specific, special consideration for long-bodied aircraft, landing in minimum visibility for visual reference, with crosswind	x	x		x			x		
		LDG			System malfunction, auto flight failure at DA during a low-visibility approach requiring a go-around flown manually	x		x	x			x		
		APP LDG			Approach planned with autoland, followed by a failure below 1 000 ft requiring a manual go-around and an immediate landing due to fuel shortage	x		x		x		x		
		TO			In-seat instruction:		x		x			x	x	

Assessment and training topic		Frequency	Flight phase activation	Description (includes type of topic, being threat, error or focus)	Desired outcome (includes performance criteria OR training outcome)	Guidance material (GM) Example scenario elements	PRO	COM	FPA	FPM	LTW	PSD	SAW	WLM	KNO
Generation 3 Turboprop — Recurrent assessment and training matrix							Competency map								
						Insufficient engine failure recovery, forcing the pilot monitoring to take over the flight controls									
			APP LDG			In-seat instruction: Unstable approach on short final or long landing, forcing the pilot monitoring to take over the flight controls		x		x			x	x	
EVAL or SBT	Monitoring, cross-checking, error management, mismanaged aircraft state	A	ALL	The scenarios should be realistic and relevant, and should be used for the purpose of demonstration and reinforcement of effective monitoring.	Recognise mismanaged aircraft state. Observe the pilot's behaviour: how the pilot is mitigating errors, performing cross-checking, monitoring performance and dealing with a mismanaged aircraft state, in order to ensure that observed deviations, errors and mistakes are taken as learning opportunities throughout the programme. Monitor flight path excursions. Detect errors and threats through proper cross-checking performance.	Deviations from the flight path, in pitch attitude, speed, altitude, bank angle		x					x		
			ALL	Modules in the FSTD should be treated like those in an aircraft so that trainees have the opportunity to develop the competency with the practice of the right techniques and attitudes		In-seat instruction: Simple automation errors (e.g. incorrect mode selection, attempted engagement without the necessary conditions, entering wrong altitude or speed, failure to execute the desired mode) culminating in a need for direct intervention from the pilot monitoring, and where necessary taking control.						x			
			APP			In-seat instruction: Unstable approach or speed/path/vertical rate not congruent with the required state for the given flight condition	x	x					x	x	
			LDG			In-seat instruction: Demonstration exercise — recovery from bounced landing, adverse wind, strong gusts during landing phase, resulting in a bounce and necessitating	x			x			x		

Assessment and training topic	Frequency	Flight phase activation	Description (includes type of topic, being threat, error or focus)	Desired outcome (includes performance criteria OR training outcome)	Guidance material (GM) Example scenario elements	PRO	COM	FPA	FPM	LTW	PSD	SAW	WLM	KNO
Generation 3 Turboprop — Recurrent assessment and training matrix						Competency map								
			<p>related to these topics through pilot performance, and that instructors have the opportunity to assess and train these topics in a realistic environment. As shown by the EBT data report, these topics are of key importance to improve safety in operations.</p> <p>In addition, the operator may also use these topics to develop scripted role-playing scenarios in the form of ISI. These scenarios cater for the need to monitor flight path excursions from the instructor pilot</p>	<p>Make appropriate interventions either verbally or by taking control if applicable. Take appropriate action if necessary. Restore the desired aircraft state. Identify and manage consequences.</p>	<p>recovery action from the pilot monitoring</p>									

Assessment and training topic	Frequency	Flight phase activation	Description (includes type of topic, being threat, error or focus)	Desired outcome (includes performance criteria OR training outcome)	Guidance material (GM) Example scenario elements	PRO	COM	FPA	FPM	LTW	PSD	SAW	WLM	KNO
Generation 3 Turboprop — Recurrent assessment and training matrix						Competency map								
			(PF), detect errors and make appropriate interventions, either verbally or by taking control as applicable. Demonstration scenarios may also be used. Demonstrated role-play should contain realistic and not gross errors, leading at times to a mismanaged aircraft state, which can also be combined with upset management training.											
Unstable approach	A	DES APP	Reinforce stabilised approach philosophy and adherence to		ATC or terrain-related environment creating a high-energy descent with the need to capture the optimum profile to complete the approach in a stabilised configuration	x		x				x		

Assessment and training topic		Frequency	Flight phase activation	Description (includes type of topic, being threat, error or focus)	Desired outcome (includes performance criteria OR training outcome)	Guidance material (GM) Example scenario elements	PRO	COM	FPA	FPM	LTW	PSD	SAW	WLM	KNO	
Generation 3 Turboprop — Recurrent assessment and training matrix							Competency map									
			DES APP	defined parameters. Encourage go-arounds when crews are outside these parameters. Develop and sustain competencies related to the management of high-energy situations.		ATC or terrain-related environment creating a high-energy descent leading to unstable conditions and requiring a go-around	x		x				x			
			APP			Approach and landing in demanding weather conditions, e.g. turbulence, up and downdrafts, gusts and crosswinds including shifting wind directions					x	x				
			APP			Increasing tailwind on final approach (not reported)	x	x				x	x			
			APP LDG			Crosswinds with or without strong gusts on approach, final approach and landing (within and beyond limits)	x			x		x				
Section 5 — UPRT training topic with frequency (B). Evaluation phase, manoeuvres training phase or scenario-based training phase (EVAL, MT or SBT)																
EVAL, MT or SBT	Upset prevention training	B	N/A	Compliance with AMC1 or AMC2 to ORO.FC.220&230 Include upset prevention elements in Table 1 for the recurrent training programme in at least every cycle, such that all the elements are covered over a period not exceeding 3 years.	Early recognition and prevention of upset conditions. When the differences between LHS and RHS are not significant in the handling of the aircraft, UPRT may be conducted in either seat.	See Table 1 of AMC1 ORO.FC.220&230: Elements and respective components of upset prevention training.	Intentionally blank									
			CRZ			Demonstration of the defined normal flight envelope and any associated changes in flight instruments, flight director systems, and protection systems. This should take the form of an instructor-led exercise to show the crew the points beyond which an upset condition could exist.									x	x
			TO APP			Severe wind shear or wake turbulence during take-off or approach				x	x		x	x		
			CRZ			As applicable and relevant to the aircraft type, demonstration at a suitable				x			x			x

Assessment and training topic	Frequency	Flight phase activation	Description (includes type of topic, being threat, error or focus)	Desired outcome (includes performance criteria OR training outcome)	Guidance material (GM) Example scenario elements	PRO	COM	FPA	FPM	LTW	PSD	SAW	WLM	KNO
Generation 3 Turboprop — Recurrent assessment and training matrix						Competency map								
			<p>The elements are numbered with letters from A to I in Table 1 of AMC1 ORO.FC.220&230. Each element is made up of several numbered components. According to the principles of EBT, covering one component should satisfy the requirement to cover the whole element of recognising and preventing the development of upset conditions.</p>		intermediate level, with turbulence as appropriate; practise steep turns and note the relationship between bank angle, pitch and stalling speed									
		CRZ			At the maximum cruise flight level for the current aircraft weight, turbulence to trigger overspeed conditions (if FSTD capability exists, consider use of the vertical wind component to add realism)	x		x	x			x		
		CRZ			At the maximum cruise flight level for the current aircraft weight, turbulence and significant temperature rise to trigger low-speed conditions (if FSTD capability exists, consider use of the vertical wind component to add realism)			x	x			x		x
		CRZ			High-altitude loss of reliable airspeed	x	x		x			x	x	
		CRZ			High-altitude ACAS RA (where the RA is required to be flown in manual flight)	x			x			x	x	

Section 6 — Training topics with frequency (B) in alphabetical order. Evaluation phase or scenario-based training phase (EVAL or SBT)											
EVAL or SBT	Aircraft system malfunctions, including operations under MEL	B	ALL	<p>Any internal failure(s) apparent or not apparent to the crew</p> <p>Any item cleared by the MEL but having an impact upon flight operations — for instance, thrust reverser locked.</p> <p>Malfunctions to be considered should have one or more of the following characteristics: Immediacy Complexity Degradation of aircraft control Loss of primary instrumentation Management of consequences The operator should vary malfunctions for each characteristic over the EBT cycle.</p>	<p>Recognise system malfunction. Take appropriate action including correct stop/go decision. Apply the appropriate procedure correctly. Maintain aircraft control. Manage consequences.</p> <p>Apply crew operating procedures where necessary. Respond appropriately to additional system abnormalities associated with MEL dispatch.</p>	<p>(i) System malfunctions that require immediate and urgent crew intervention or decision, e.g. fire, smoke, loss of pressurisation at high altitude, failures during take-off, brake failure during landing.</p> <p>(ii) System malfunctions that require complex procedures, e.g. multiple hydraulic system failures, smoke and fumes procedures, major electrical system failure.</p> <p>(iii) System malfunctions that result in significant degradation of flight controls in combination with abnormal handling characteristics, e.g. jammed flight controls, certain degradation of FBW control, jammed horizontal stabiliser; flaps and/or slats locked; other malfunctions that result in degraded flight controls.</p> <p>(iv) System failures that require monitoring and management of the flight path using degraded or alternative displays, unreliable primary flight path information, unreliable airspeed, e.g. flight with unreliable airspeed</p> <p>(v) System failures that require extensive management of their consequences (independent of operation or environment), e.g. fuel leak.</p>	Intentionally blank				
			TO					MEL items with crew operating procedures applicable during take-off			

			TO	<p>Unless specified otherwise in the operational suitability data, at least one malfunction with each characteristic should be included in every cycle. Combining characteristics should not reduce the number of malfunctions below seven for each cycle. For each crew member, the characteristics of degraded control and loss of instrumentation should be in the role of pilot flying and the others may be in the role of pilot flying or pilot monitoring. For full details, see the malfunction equivalency methodology.</p>		Response to an additional factor that is affected by an MEL item (e.g. system failure, runway state)		x		x		x			x			
			GND			Malfunction during preflight preparation and prior to departure	x						x	x				
			CLB			Malfunction after departure	x							x	x		x	
			ALL			Malfunctions that require immediate attention (e.g. bleed fault during engine start, hydraulic failure during taxi)	x						x				x	
			CLB CRZ			Fuel leak (management of consequences)	x						x			x	x	
			TO			Malfunction on take-off high speed below V1	x						x	x				
			TO			Malfunction on take-off high speed above V1	x							x				
			GND			During taxi to the runway, a spurious brake temperature announcement. The crew had the correct brake temperature moments before the failure.								x	x	x		
			TO			Tyre failure during take-off								x	x			x
			TO			Malfunction on initial climb	x								x			
			APP			Malfunction on approach	x								x			x
			APP			Malfunction on go-around	x								x			x
								LDG			Malfunction during landing	x	x			x		x
EVAL	Aircraft system management	B	Normal system operation	This is not considered as a stand-alone topic. It is	See 'compliance' topic above. There are no defined scenarios, but the instructor	Intentionally blank									x			

			according to defined instructions	linked with the topic 'compliance'. Where a system is not managed according to normal or defined procedures, this is determined as a non-compliance.	should focus on learning opportunities when system management non-compliances manifest themselves during other scenarios. Underpinning knowledge of systems and their interactions should be developed and challenged, and not merely the application of normal procedures.												
			CRZ APP LDG			Minimum fuel, caused by extended delays, weather, etc. where the crew would need to manage a minimum fuel situation						x	x	x	x		
Approach, visibility close to minimum	B	APP	Any situation where visibility becomes a threat	Recognise actual conditions. Observe aircraft and/or procedural limitations. Apply the appropriate procedures if applicable. Maintain directional control and safe flight path.	Approach in poor visibility	x		x	x								x
		APP			Approach in poor visibility with deteriorations necessitating a decision to perform a go-around	x		x	x								
		LDG			Landing in poor visibility					x		x	x				
Landing	B	LDG	Pilots should have opportunities to practise landings in demanding situations at the defined frequency. Data indicates that landing problems have their roots in a variety of factors, including inappropriate decision-making, in addition to	Landing in demanding environmental conditions, with malfunctions as appropriate	This topic should be combined with the adverse-weather topic, aircraft system malfunctions topic or any topic that can provide exposure to a landing in demanding conditions.	Intentionally blank											

				manual aircraft control skills if difficult environmental conditions exist. The purpose of this item is to ensure that pilots are exposed to this during the programme.													
EVAL OF SBT	Surprise	B	ALL	The data analysed during the development of the EBT concept indicated substantial difficulties encountered by crews when faced with a threat or error, which was a surprise or an unexpected event. The element of surprise should be distinguished from what is sometimes referred to as the 'startle factor' — the latter being a physiological reaction. Wherever possible,	Exposure to an unexpected event or sequence of events at the defined frequency in order to build resilience.	Rejected take-off	x				x			x			
						Intentionally blank											

				consideration should be given towards variations in the types of scenario, times of occurrences and types of occurrence, so that pilots do not become overly familiar with repetitions of the same scenarios. Variations should be the focus of EBT programme design, and not left to the discretion of individual instructors, in order to preserve programme integrity and fairness.														
EVAL or SBT	Terrain	B	ALL	Alert, warning, or conflict	Anticipate terrain threats. Prepare for terrain threats. Recognise unsafe terrain clearance. Take appropriate action. Apply the appropriate procedures correctly.		ATC clearance giving insufficient terrain clearance	x	x			x						
			ALL										x	x	x			
			TO CLB						x		x				x			
			DES APP						x					x				

			DES		Maintain aircraft control. Restore safe flight path. Manage consequences.	‘Virtual mountain’ refers to the surprise element of an unexpected warning. Care should be exercised in creating a level of realism, so this can best be achieved by an unusual and unexpected change of route during the descent.										X	X	X	
EVAL or SBT	Wind shear recovery	B	TO	With or without warnings including predictive. A wind shear scenario is ideally combined with an adverse-weather scenario containing other elements.	Anticipate potential for wind shear. Avoid known wind shear or prepare for suspected wind shear. Recognise wind shear encounter. Take appropriate action. Apply the appropriate procedure correctly. Assure aircraft control. Recognise out of wind shear condition. Maintain or restore a safe flight path. Assess consequential issues and manage outcomes.	Predictive wind shear warning during take-off					X	X							
			TO			Wind shear encounter during take-off	X				X	X							
			TO			Wind shear encounter after rotation						X			X				
			TO			Predictive wind shear after rotation						X	X						
			APP			Predictive wind shear during approach	X					X	X						
			APP			Wind shear encounter during go-around	X					X	X			X			
			APP			Wind shear encounter during approach	X						X	X					

	Workload, distraction, pressure, stress	B	ALL	This is not considered a topic for specific attention on its own, but more as a reminder to programme developers to ensure that pilots are exposed to immersive training scenarios which expose them to manageable high workload and distractions during the course of the EBT programme, at the defined frequency.	Manage available resources efficiently to prioritise and perform tasks in a timely manner under all circumstances.	Intentionally blank	Intentionally blank
Section 7 — UPRT Upset recovery training topic with frequency (C). Manoeuvres training phase or scenario-based training phase (MT or SBT)							
MT or SBT	Upset recovery	C	N/A	Compliance with AMC1 or AMC2 to ORO.FC.220&230	Recognise upset condition.	The example scenario elements may be done in ISI, as non-ISI or a combination of both. If done in ISI: The instructor should position the aircraft within but close to the edge of the validated training envelope before handing control to the trainee to demonstrate the restoration of normal flight. Careful consideration should be given to flying within the validated training envelope.	Intentionally blank
				Include the recovery exercises in Table 2 of AMC1 ORO.FC.220&230 for the recurrent training programme, such that all the exercises are covered over a	Make timely and appropriate intervention. Take appropriate action. Assure timely and appropriate intervention. (AMC1 ORO.FC.220&230 Table 2 component 1)		
				Assure aircraft control.	A.	Recovery from developed upsets	

				<p>period not exceeding 3 years. According to the principles of EBT, covering one component should satisfy the requirement to cover the whole element of recovery from developed upsets. The same principles apply to the exercises of components 2, 3 and 4 where one exercise may satisfy the requirement to cover the whole component.</p>	<p>Maintain or restore a safe flight path.</p> <p>Assess consequential issues.</p> <p>Manage outcomes.</p> <p>Consolidate the summary of aeroplane recovery techniques. (AMC1 ORO.FC.220&230 Table 2 component 5)</p> <p>Note: The operator should assess if the exercises should be practised for the either seat qualification.</p>														
			CLB DES			2.	Recovery from stall events in the following configurations: take-off configuration, clean configuration low altitude, clean configuration near maximum operating altitude, and landing configuration during the approach phase.	x				x				x	x		
			CRZ			3.	Recovery from nose high at various bank angles	x				x				x	x		
			CRZ			4.	Recovery from nose low at various bank angles	x				x				x	x		
			APP				Demonstration at a normal cruising altitude. Set conditions and disable aircraft systems as necessary to enable trainee to perform stall recovery according to OEM instructions.	x				x				x			
			CLB DES				Demonstration at an intermediate altitude during early stages of the approach. Set conditions and disable aircraft systems as necessary to enable trainee to perform stall recovery according to OEM instructions.	x				x				x			

				An aeroplane upset is defined as an undesired aeroplane state in flight characterised by unintentional divergences from parameters normally experienced during line operations or training. An aeroplane upset may involve pitch and/or bank angle divergences as well as inappropriate airspeeds for the conditions.		Recovery from a wake turbulence position with high-bank angle	x		x	x					x		
Section 8 — Training topics with frequency (C) in alphabetical order. Evaluation phase or scenario-based training phase (EVAL or SBT)																	
EVAL or SBT	Adverse wind	C	TO	Adverse wind/crosswind. This includes tailwind but not ATC mis-reporting of the actual wind.	Recognise adverse-wind conditions. Observe limitations. Apply the appropriate procedures. Maintain directional control and safe flight path.	Take-off with different crosswind/tailwind/gust conditions									x		x
			TO			Take-off with unreported tailwind		x			x						
			TO			Crosswinds with or without strong gusts on take-off	x			x							
			APP			Wind exceeding limits on final approach (not reported)	x	x			x	x					
			APP			Wind exceeding limits on final approach (reported) in manual aircraft control	x	x		x		x					
			APP			Increasing tailwind on final approach (not reported)	x	x				x	x				

			APP			Approach and landing in demanding weather conditions, e.g. turbulence, up and downdrafts, gusts and crosswind including shifting wind directions				X		X	X		
			APP			Adverse-wind scenario resulting in increasing tailwind below DA (not reported)		X		X		X			
			APP			Adverse-wind scenario including strong gusts and/or crosswind out of limits below DA (not reported)		X		X		X			
			APP			Adverse-wind scenario including strong gusts and/or crosswind out of limits below 15 m (50 ft) (not reported)		X		X		X			
			APP LDG			Crosswind with or without strong gusts on approach, final approach and landing (within and beyond limits)	X			X		X			
EVAL or SBT	ATC	C	ALL	ATC error. Omission, miscommunication, garbled, poor quality transmission. All these act as distractions to be managed by the crew. The scenarios should be combined, where possible, with others of the same or higher weighting, the principal reason being to create distractions.	Respond to communications appropriately. Recognise, clarify and resolve any ambiguities. Refuse or question unsafe instructions. Use standard phraseology whenever possible.	ATC role-play: the instructor provides scripted instructions, as a distraction to the crew	X	X			X				
			ALL			Controller error, provided by the instructor according to a defined scripted scenario	X	X				X	X		
			ALL			Frequency congestion, with multiple aircraft using the same frequency		X							
			CRZ			Destination temporarily closed					X	X	X	X	
			APP			Rescue and firefighting services (RFFS) level reduction at destination		X		X		X	X		
			GND TO			Runway change before the interception of the localiser or similar navigation aid in azimuth			X		X		X	X	
			ALL			Stray dogs at the opposite threshold runway		X		X		X			
			ALL			Poor quality transmissions		X							

EVAL or SBT	Engine failure	C	TO	Any engine failure or malfunction, which causes loss or degradation of thrust that affects performance. This is distinct from the engine-out manoeuvres described in the MT section above, which are intended only to practise psychomotor skills and reinforce procedures to manage engine failures.	Recognise engine failure. Take appropriate action. Apply the appropriate procedure correctly. Maintain aircraft control. Manage consequences.	Engine failure or engine malfunction on take-off low speed	x			x		x		x		
			TO			Engine failure or engine malfunction on take-off high speed below V1	x			x		x		x		
			TO			Engine failure or engine malfunction on take-off above V1	x					x	x	x		
			TO			Engine failure or engine malfunction on initial climb	x					x	x			
			APP			Engine malfunction	x					x		x		
			CRZ			Engine failure in cruise (with autopilot)	x		x					x		
			LDG			Engine failure or engine malfunction on landing								x		
EVAL or SBT	Fire and smoke management	C	GND	This includes engine, electric, pneumatic, cargo fire, smoke or fumes.	Recognise fire, smoke or fumes. Take appropriate action. Apply the appropriate procedure correctly. Maintain aircraft control. Manage consequences.	Fire in cargo or cabin/cockpit at gate	x	x					x		x	
			GND			Fire during taxi	x	x				x		x	x	
			GND			Fire with no cockpit indication	x	x				x		x	x	
			TO			Take-off low speed	x			x	x	x			x	
			TO			Fire or smoke on take-off high speed below V1	x			x	x	x				
			TO			Fire or smoke on take-off high speed above V1	x				x	x				
			TO			Fire or smoke on initial climb	x				x	x				
			CRZ			Cargo fire							x	x	x	
			APP			Engine fire in approach (extinguishable)		x					x			

			APP			Engine fire in approach (non-extinguishable)		X			X	X			
			CLB CRZ DES			Lithium battery fire in the cockpit or cabin compartment	X	X			X	X		X	
			APP			Flight deck or cabin fire		X			X	X			X
			GND			Any of the example scenario elements above ending in an evacuation		X			X	X		X	
EVAL or SBT	Loss of communications	C	GND	Lost or difficult communications due to either pilot mis-selection or a failure external to the aircraft. This could be for a few seconds or a total loss.	Recognise loss of communications. Take appropriate action. Execute the appropriate procedure as applicable. Use alternative ways to communicate. Manage consequences.	Loss of communications during ground manoeuvring	X	X							
			TO			Loss of communications after take-off	X				X			X	
			APP			Loss of communications during approach phase, including go-around	X	X			X	X		X	
EVAL or SBT	Managing loading, fuel, performance errors	C	ALL	A calculation error by one or more pilots, or someone involved with the process, or the process itself, e.g. incorrect information on the load sheet	Anticipate the potential for errors in load/fuel/performance data. Recognise inconsistencies. Manage/avoid distractions. Make changes to paperwork/aircraft system(s) to eliminate error. Identify and manage consequences.	This can be a demonstrated error, in that the crew may be instructed to deliberately insert incorrect data — for example, to take off from an intersection with full-length performance information. The crew will be asked to intervene when acceleration is sensed to be lower than normal, and this may be part of the operator procedures, especially when operating mixed fleets with considerable variations in MTOM.	X	X							X
			GND			Fuel ground staff on industrial action. Only limited amount of fuel available, which is below the calculated fuel for the flight.					X	X	X	X	

			GND			Advise crew that there is a change of the load sheet figures during taxi to the runway. The crew may have limited time due to a calculated take-off time (CTOT) – ATC slot.	x									x	
			GND			Braking action reported ‘medium’. The information is transmitted just before take-off. The flight is subject to a (CTOT) – ATC slot.						x				x	x
			GND			External failure or a combination of external failures degrading aircraft navigation performance on ground	x		x							x	x
			TO CLB APP LDG			External failure or a combination of external failures degrading aircraft navigation performance in flight		x				x				x	
			GND			Standard initial departure change during taxi. The flight may be subject to a CTOT – ATC slot.						x				x	x
			APP			Loss of runway lighting below decision height		x								x	x
			CRZ			No fly zone: when the crew changes control frequency, the new ATCO informs the crew that they are flying over an unannounced ‘no fly zone’ that is not included in the NOTAMs. (To trigger such an event, the context may be as follows: an unexpected military conflict in the territory the aircraft is flying over or the crew is forced to re-route in flight and the new route flies over a city that has an important event such the Olympic games, a G20/G7 summit, or the route is flying near a space rocket launch close to the time of										x	x
				External NAV failure. Loss of GPS satellite, ANP exceeding RNP, loss of external NAV source(s)	Recognise a NAV degradation. Take appropriate action. Execute the appropriate procedure as applicable. Use alternative NAV guidance. Manage consequences.												
EVAL or SBT	Navigation	C															

EVAL or SBT	Operations- or type-specific	C	ALL	Intentionally blank	Intentionally blank	Intentionally blank	Intentionally blank											
	Operations of special airport approval	C	APP LDG	See equivalency of approaches relevant to operations.	The operator should comply with the national qualification requirements published in the Aeronautical Information Publication.	Intentionally blank	Intentionally blank											
	Pilot incapacitation	C	TO	Consequences for the non-incapacitated pilot	Recognise incapacitation. Take appropriate action including correct stop/go decision. Apply the appropriate procedure correctly. Maintain aircraft control. Manage consequences.	During take-off	x	x			x	x						x
			APP			During approach	x			x					x	x		
Runway or taxiway condition	C	GND TO LDG	Contamination or surface quality of the runway, taxiway, or tarmac including foreign objects	Recognise hazardous runway condition. Observe limitations. Take appropriate action. Apply the appropriate procedures correctly. Assure aircraft control.	Planned anticipated hazardous conditions with dispatch information provided to facilitate planning and execution of appropriate procedures									x				x
		GND TO LDG			Unanticipated hazardous conditions, e.g. unexpected heavy rain resulting in flooded runway surface		x			x	x							
		TO			Take-off on runway with reduced cleared width due to snow	x			x	x			x					
		TO			Stop/go decision in hazardous conditions					x	x					x		

EVAL or SBT	Traffic	C	CLB CRZ DES	Traffic conflict. ACAS RA or TA, or visual observation of conflict, which requires evasive manoeuvring	Anticipate potential loss of separation. Recognise loss of separation. Take appropriate action. Apply the appropriate procedure correctly. Maintain aircraft control. Manage consequences.	ACAS warning that requires crew intervention		x					x	x	x	
						Dilemma: Visual acquisition of conflicting traffic followed by an ACAS warning (resolution advisory) triggered by the same or other traffic. Even if the traffic is in sight, the pilot should follow the RA.	x		x	x						
						While in descent, ACAS warning (traffic advisory) of an aircraft below. The crew should not initiate an avoidance manoeuvre based on TA (except decreasing the rate of descent unless otherwise instructed by ATC, etc.). This example scenario can be done during climb with conflicting traffic above.	x				x					

END GEN3 TURBOPROP

AMC5 ORO.FC.232 EBT programme assessment and training topics*ED Decision 2021/002/R***GENERATION 2 (JET) — EBT PROGRAMME — TABLE OF ASSESSMENT AND TRAINING TOPICS**

Given the very small number of turbo-jet aeroplanes of the second generation in current use in commercial air transport operations, the operator should apply for an alternative means of compliance to develop a table of assessment and training topics to apply EBT.

AMC6 ORO.FC.232 EBT programme assessment and training topics

ED Decision 2022/014/R

GENERATION 2 (TURBOPROP) — TABLE OF ASSESSMENT AND TRAINING TOPICS

Assessment and training topic		Frequency	Description (includes type of topic, being threat, error or focus)	Desired outcome (includes performance criteria OR training outcome)	Flight phase activation	Guidance material (GM) Example scenario elements	PRO	COM	FPA	FPM	LTW	PSD	SAW	WLM	KNO
Generation 2 Turboprop — Recurrent assessment and training matrix						Competency map									
Section 1 — Skill retention. Manoeuvres training phase (MT)															
MT	Rejected take-off	A	Engine failure after the application of take-off thrust and before reaching V1 (may be in LVO or CAT I or above)	Demonstrate manual aircraft control skills with smoothness and accuracy as appropriate to the situation.	TO	From initiation of take-off to complete stop (or as applicable to the procedure)	x			x					
	Failure of the critical engine between V1 and V2	A	Failure of the critical engine from V1 and before reaching V2 in the lowest CAT I visibility or in LVO meteorological (MET) conditions.	Detect deviations through instrument scanning. Maintain spare mental capacity during manual aircraft control. Maintain the aircraft within the flight envelope.	TO	The manoeuvre is complete at a point when the aircraft is stabilised at normal engine-out climb speed with the correct pitch and lateral control, in trim condition and, as applicable, autopilot engagement. Only one failure of the critical engine between V1 and V2 a year may be done in LVO conditions.	x			x					
	Failure of one engine on take-off	B	Failure of one engine from V1 and before reaching V2 in the lowest CAT I visibility or in LVO MET conditions.	Apply knowledge of the relationship between aircraft attitude, speed and thrust.	TO	The manoeuvre is complete at a point when the aircraft is stabilised in a clean configuration with engine-out procedures completed. Only one failure of the critical engine between V1 and V2 a year may be done in LVO conditions.	x			x					

Assessment and training topic	Frequency	Description (includes type of topic, being threat, error or focus)	Desired outcome (includes performance criteria OR training outcome)	Flight phase activation	Guidance material (GM) Example scenario elements	PRO	COM	FPA	FPM	LTW	PSD	SAW	WLM	KNO
Generation 2 Turboprop — Recurrent assessment and training matrix						Competency map								
		Failure of one engine above V2 (any segment of the TO) in the lowest CAT I visibility or in LVO MET conditions.			The manoeuvre is complete at a point when the aircraft is stabilised in a clean configuration with engine-out procedures completed	x		x	x					
Emergency descent	C	Initiation of emergency descent from normal cruise altitude		CRZ	The manoeuvre is complete once the aircraft is stabilised in emergency descent configuration (and profile). However, if the EBT programme does not include the example scenario element 'emergency descent' in the training topic 'automation management', the emergency descent procedures should be completed and should not stop once the aircraft is stabilised in emergency descent configuration.	x		x	x					
Engine-out approach & landing	A	With the critical engine (if applicable) failed, normal landing		LDG	Initiation in a stabilised engine-out configuration from not less than 3 NM final approach, until completion of roll-out	x			x					

Assessment and training topic	Frequency	Description (includes type of topic, being threat, error or focus)	Desired outcome (includes performance criteria OR training outcome)	Flight phase activation	Guidance material (GM) Example scenario elements	PRO	COM	FPA	FPM	LTW	PSD	SAW	WLM	KNO	
Generation 2 Turboprop — Recurrent assessment and training matrix						Competency map									
Engine-out approach & go-around	A	With the critical engine (if applicable) failed, manually flown normal precision approach to DA, followed by a manual go-around — the whole manoeuvre to be flown without visual reference		APP	This manoeuvre should be flown from intercept to centreline until acceleration after go-around. The manoeuvre is complete at a point when the aircraft is stabilised at normal engine-out climb speed with the correct pitch and lateral control, in trim condition and, as applicable, autopilot engagement (describe generally the critical part of the manoeuvre).	x			x						
Go-around	A	Go-around, all engines operative		APP	High energy, initiation during the approach at 150 to 300 m (500 to 1 000 ft) below the missed approach level-off altitude	x		x	x						
					Initiation of a go-around from DA followed by visual circuit and landing	x		x	x						
					During flare/rejected landing	x		x	x						
Pilot qualification to operate in either pilot's seat	B	As per ORO.FC.235		APP	Complete the manoeuvres mandated in ORO.FC.235.	Intentionally left in blank.									

Section 2 — Equivalency of approaches relevant to operations. Evaluation phase, manoeuvres training phase or scenario-based training phase (EVAL, MT or SBT)														
MT	Approach type A or B	B	Approach type A or B flight method 3D	See equivalency of approaches relevant to operations that place an additional demand on a proficient crew	APP	See equivalency of approaches relevant to operations	x		x	x			x	x
	Approach type A	B	Approach type A flight method 2D	See equivalency of approaches relevant to operations that place an additional demand on a proficient crew	APP	See equivalency of approaches relevant to operations	x		x	x			x	x
EVAL or SBT	Approach type A	B	Approach type A flight method 3D or 2D	See equivalency of approaches relevant to operations that place an additional demand on a proficient crew	APP	See equivalency of approaches relevant to operations	x		x	x			x	x
	Approach type B	B	Approach type B flight method 3D	See equivalency of approaches relevant to operations that place an additional demand on a proficient crew	APP	See equivalency of approaches relevant to operations	x		x	x			x	x
Section 3 – Equivalency of approaches under specific approvals and take-off under specific approvals. Evaluation phase, manoeuvres training phase or scenario-based training phase (EVAL, MT or SBT)														
MT	SPA approach(es)	B	Approach requiring specific approval	See equivalency of approaches relevant to operations — specific approval	APP	Approaches flown from FAF to landing or go-around	x		x	x				
EVAL or SBT	SPA approach(es)	B	Approach requiring specific approval	See equivalency of approaches relevant to operations — specific approval	APP	Approaches flown from FAF to landing or go-around	x		x	x				

EVAL, MT or SBT	SPA rejected Take-off (RTO)	<p>B</p> <p>Engine failure after the application of take-off thrust and before reaching V1 (in low-visibility MET conditions, preferably in the lowest approved visibility)</p> <p>Low-visibility RTO is not required under Part SPA but instead in Appendix 9 Section 6.</p> <p>Note: AMC1 SPA.LVO.120 point (f) does not require a low-visibility RTO. RTO is required only in the initial LVO course (point (g)(1)(iii) of AMC1 SPA.LVO.120).</p>	<p>Demonstrate manual aircraft control skills with smoothness and accuracy as appropriate to the situation.</p> <p>Detect deviations through instrument scanning.</p> <p>Maintain spare mental capacity during manual aircraft control.</p>	TO	<p>RTO — can be combined with the assessment and training topic ‘surprise’ in EVAL or SBT</p>	x			x					
VAL, MT or SBT	LVTO	<p>B</p> <p>Notwithstanding AMC1 SPA.LVO120 point (f)(1)</p> <p>AMC1 SPA.LVO.120 requires SPA manoeuvres in the frequency of the OPC, as OPC is substituted in the EBT programme. Thus, the frequency in EBT is determined in every cycle (B).</p> <p>Low-visibility take-off, preferably in the lowest approved visibility</p>	<p>Maintain the aircraft within the flight envelope.</p> <p>Apply knowledge of the relationship between aircraft attitude, speed and thrust.</p>	TO	<p>The manoeuvre may be complete at a point when the aircraft is stabilised at normal climb speed with the correct pitch and lateral control, in trim condition and, as applicable, autopilot engagement.</p>	x			x					

Assessment and training topic		Frequency	Flight phase activation	Description (includes type of topic, being threat, error or focus)	Desired outcome (includes performance criteria OR training outcome)	Guidance material (GM) Example scenario elements	PRO	COM	FPA	FPM	LTW	PSD	SAW	WLM	KNO			
Generation 3 Turboprop — Recurrent assessment and training matrix							Competency map											
Section 4 — Training topics with frequency (A) in alphabetical order. Evaluation phase or scenario-based training phase (EVAL or SBT)																		
EVAL or SBT	Adverse weather	A	GND	Thunderstorm, heavy rain, turbulence, ice build-up to include de-icing issues, as well as high-temperature conditions. The proper use of anti-ice and de-icing systems should be included generally in appropriate scenarios.	Anticipate adverse weather. Prepare for suspected adverse weather. Recognise adverse weather. Take appropriate action. Apply the appropriate procedure correctly. Assure aircraft control.	Predictive wind shear warning before take-off, as applicable	x	x				x						
			ALL			Adverse-weather scenario, e.g. thunderstorm activity, precipitation, icing		x			x	x		x				
			TO			Wind shear encounter during take-off, not predictive	x			x			x		x			
			TO			Predictive wind shear warning during take-off	x	x					x	x				
			TO			Crosswinds with or without strong gusts on take-off	x			x								
			CRZ			Turbulence that increases to severe turbulence		x			x	x						
			CRZ			Wind shear encounter scenario during cruise	x		x			x	x	x				
			APP			Reactive wind shear warning during approach or go-around	x		x	x				x				
			APP			Predictive wind shear warning during approach or go-around	x	x						x	x			
			APP			Thunderstorm encounter during approach or on missed approach	x							x	x			
			APP			Increasing tailwind on final approach (not reported)	x	x						x	x			
			APP			Approach and landing in demanding weather conditions, e.g. turbulence, up and downdrafts, gusts and crosswinds including shifting wind directions								x		x		

Assessment and training topic		Frequency	Flight phase activation	Description (includes type of topic, being threat, error or focus)	Desired outcome (includes performance criteria OR training outcome)	Guidance material (GM) Example scenario elements	PRO	COM	FPA	FPM	LTW	PSD	SAW	WLM	KNO
Generation 3 Turboprop — Recurrent assessment and training matrix							Competency map								
			APP			Non-precision approach in cold-temperature conditions, requiring altitude compensation for temperature, as applicable to the type	x	x					x		
			APP LDG			Crosswinds with or without strong gusts on approach, final approach and landing (within and beyond limits)	x			x		x			
			APP			In approach, unexpected braking action 'good to medium' reported by the preceding aircraft		x			x	x	x		
			APP			Moderate to severe icing conditions during approach effecting aircraft performance	x	x			x	x			
			APP			Reduced visibility even after acquiring the necessary visual reference during approach, due to rain or fog	x	x			x				
EVAL or SBT	Aircraft system management	A	N/A	Normal system operation according to defined instructions	This is not considered as a stand-alone topic. It is linked with the topic 'compliance'. Where a system is not managed according to normal or defined procedures, this is determined as a non-compliance.	See 'compliance' topic above. There are no defined scenarios, but the instructor should focus on learning opportunities when system management non-compliances manifest themselves during other scenarios. Underpinning knowledge of systems and their interactions should be developed and challenged, and not merely the application of normal procedures.	Intentionally blank								x
			CRZ APP LDG			Minimum fuel, caused by extended delays, weather, etc. where the crew					x	x	x	x	

Assessment and training topic		Frequency	Flight phase activation	Description (includes type of topic, being threat, error or focus)	Desired outcome (includes performance criteria OR training outcome)	Guidance material (GM) Example scenario elements	PRO	COM	FPA	FPM	LTW	PSD	SAW	WLM	KNO
Generation 3 Turboprop — Recurrent assessment and training matrix							Competency map								
						would need to manage a minimum fuel situation.									
EVAL or SBT	Automation management	A	CLB CRZ DES APP	The purpose of this topic is to encourage and develop effective flight path management through proficient and appropriate use of the flight management system(s), guidance and automation, including transitions between modes, monitoring, mode awareness, vigilance and flexibility needed to change from one mode to another. The means of	Know how and when to use the flight management system(s), guidance and automation. Demonstrate correct methods for engagement and disengagement of the auto flight system(s). Demonstrate appropriate use of flight guidance, auto thrust and other automation systems. Maintain mode awareness of the auto flight system(s), including engagement and automatic transitions. Revert to different modes when appropriate. Detect deviations from the desired aircraft state (flight path, speed,	ACAS warning (resolution advisory), recovery and subsequent engagement of automation	x		x						
			ALL			FMS tactical programming issues, e.g. step climb, runway changes, late clearances, destination re-programming, executing diversion	x		x						x
			CLB CRZ DES APP			Recoveries from TAWS, management of energy state to restore automated flight	x		x	x					
			CLB CRZ DES APP			Amendments to ATC cleared levels during altitude capture modes to force mode awareness and intervention	x		x					x	
			TO			ACAS warning (resolution advisory to level off) during climb or descent; for example, close to the cleared level when the capture mode has already been activated.	x		x					x	
			TO			Late ATC clearance to an altitude below acceleration altitude	x		x					x	
			APP			Engine-out special terrain procedures	x		x					x	

Assessment and training topic	Frequency	Flight phase activation	Description (includes type of topic, being threat, error or focus)	Desired outcome (includes performance criteria OR training outcome)	Guidance material (GM) Example scenario elements	PRO	COM	FPA	FPM	LTW	PSD	SAW	WLM	KNO	
						Competency map									
Generation 3 Turboprop — Recurrent assessment and training matrix															
		CRZ	mitigating errors are included in this topic. The errors are described as mishandled auto flight systems, inappropriate mode selection, mishandled flight management system(s) and inappropriate autopilot usage.	attitude, thrust, etc.) and take appropriate action. Anticipate mishandled auto flight system. Recognise mishandled auto flight system. Take appropriate action if necessary. Restore correct auto flight state. Identify and manage consequences.	Forcing autopilot disconnect followed by re-engagement, recovery from low- or high-speed events in cruise	x		x	x			x			
		CLB			Engine failure during or after initial climb using automation	x		x							
		CRZ			Engine failure in cruise to onset of descent using automation	x		x							
		CRZ			Emergency descent	x		x							x
		DES APP			Managing high-energy descent capturing descent path from above (correlation with unstable approach training)	x		x					x		x
		APP			No ATC clearance received prior to commencement of approach or final descent	x		x					x		
		APP			Reactive wind shear and recovery from the consequent high-energy state	x		x					x		
		APP			Automation fail to capture the approach altitude in descent (e.g. last altitude before the FAP). Ideally, the failure occurs when the workload is high (e.g. configuration of the aircraft for final approach).						x	x	x	x	
		APP			Non-precision or infrequently flown approaches using the maximum available level of automation	x		x							x
		APP			Gear malfunction during an approach planned with autoland (including autobrake).			x					x		x

Assessment and training topic		Frequency	Flight phase activation	Description (includes type of topic, being threat, error or focus)	Desired outcome (includes performance criteria OR training outcome)	Guidance material (GM) Example scenario elements	PRO	COM	FPA	FPM	LTW	PSD	SAW	WLM	KNO		
Generation 3 Turboprop — Recurrent assessment and training matrix							Competency map										
						Competency FPA may or may not be included depending on the impact of such malfunction on the automation.											
			APP			ATC clearances to waypoints beyond the programmed descent point for a coded final descent point during an approach utilising a final descent that is commanded by the flight management system	x		x				x		x		
EVAL or SBT	Competencies — non-technical (CRM)	A	APP	This encapsulates the general CRM principles and objectives. It includes communication; leadership and teamwork; problem-solving and decision-making; situation awareness and management of information; and workload management.	Exposure to an event or sequence of events to allow the pilot to build awareness of human factors in aviation and the human limitations. This includes the development of the following competencies: <u>Communication:</u> Demonstrate: — effective use of language; — responsiveness to feedback; and	GPS failure prior to commencement of approach associated with position drift and a terrain alert					x	x	x		x		
			DES			Cabin crew report of water noise below the forward galley indicating a possible toilet pipe leak, with consequent avionics failures					x	x	x				
			CRZ			Smoke removal but combined with a diversion until landing is completed.		x		x	x	x	x	x			
			GND			Apron fuel spilling				x	x		x				
			CRZ			Important water leak in an aircraft galley		x		x	x						
			ALL			A relevant number of cabin crew are wounded or incapacitated. Additionally, the cabin crew wounded or incapacitated are the most competent (e.g. senior cabin crew member).							x	x			x
			ALL			Unruly passenger(s)									x		

Assessment and training topic	Frequency	Flight phase activation	Description (includes type of topic, being threat, error or focus)	Desired outcome (includes performance criteria OR training outcome)	Guidance material (GM) Example scenario elements	PRO	COM	FPA	FPM	LTW	PSD	SAW	WLM	KNO		
						Competency map										
Generation 3 Turboprop — Recurrent assessment and training matrix																
		GND	Emphasis should be placed on the development of leadership, shown by EBT data sources to be a highly effective competency in mitigating risk and improving safety through pilot performance.	— capability to state the plans and resolve ambiguities. <u>Leadership and teamwork:</u> Use appropriate authority to ensure focus on the task. Support others in completing tasks. <u>Problem-solving and decision-making:</u> Detect deviations from the desired state, evaluate problems, identify the risk, consider alternatives and select the best course of action. Continuously review progress and adjust plans. <u>Situation awareness and management of information:</u> Have an awareness of the aircraft state in its environment; project and anticipate changes. <u>Workload management:</u>	Passenger oxygen: passenger service unit open and mask falling down					x	x		x			
		ALL			Passenger with medical problems — medical emergency						x				x	
		CRZ			Credible threat reported to the crew. Stowaway or fugitive on board.		x				x			x	x	
		GND			No METAR or TAFOR is available for destination due to industrial action at the destination airport	x	x				x	x				
		CRZ			Credible bomb threat reported to crew		x				x			x	x	
		CLB DES			Credible bomb threat or pressurisation problem, but no quick landing possible (due to weather, terrain or other reasons)		x				x	x			x	
		APP			Diversion with low remaining fuel or increased fuel flow due to system malfunction	x					x			x	x	
		APP			ACAS warning (resolution advisory) immediately following a go-around, with a descent manoeuvre required. (The RA should be a command for descent when the aircraft is above 1 100 ft AGL.)		x				x	x		x	x	

Assessment and training topic		Frequency	Flight phase activation	Description (includes type of topic, being threat, error or focus)	Desired outcome (includes performance criteria OR training outcome)	Guidance material (GM) Example scenario elements	PRO	COM	FPA	FPM	LTW	PSD	SAW	WLM	KNO
Generation 3 Turboprop — Recurrent assessment and training matrix							Competency map								
					Prioritise, delegate and receive assistance to maximise focus on the task. Continuously monitor the flight progress.										
EVAL or SBT	Compliance	A	ALL	Compliance failure. Consequences of not complying with operating instructions (e.g. SOPs). This is not intended to list example scenario elements, but instructors should ensure that observed non-compliances are taken as learning opportunities throughout the programme. In all modules of the programme, the FSTD should as far as possible be	Recognise that a compliance failure has occurred. Make a verbal announcement. Take appropriate action if necessary. Restore safe flight path if necessary. Manage consequences.	The following are examples of potential compliance failures and are not intended to be developed as scenarios as part of an EBT module: <ol style="list-style-type: none"> 1. Requesting flap beyond limit speed 2. Flaps or slats in the wrong position for phase of flight or approach 3. Omitting an action as part of a procedure 4. Failing to initiate or complete a checklist 5. Using the wrong checklist for the situation 	Intentionally blank								

Assessment and training topic		Frequency	Flight phase activation	Description (includes type of topic, being threat, error or focus)	Desired outcome (includes performance criteria OR training outcome)	Guidance material (GM) Example scenario elements	PRO	COM	FPA	FPM	LTW	PSD	SAW	WLM	KNO	
Generation 3 Turboprop — Recurrent assessment and training matrix							Competency map									
				treated like an aircraft, and non-compliances should not be accepted simply for expediency.												
EVAL or SBT	Go-around management	A	APP	Any threat or error that can result in circumstances that require a decision to perform a go-around, in addition to the execution of the go-around. Go-around scenarios should be fully developed to encourage effective leadership and teamwork, in addition to problem-solving and decision-making, plus		Adverse-weather scenario leading to a reactive wind shear warning during approach	x	x					x	x		
			APP			Adverse-weather scenario leading to a predictive wind shear warning during approach or go-around	x	x					x	x		
			APP			Adverse-weather scenario, e.g. thunderstorm activity, heavy precipitation or icing forcing decision at or close to DA/MDA	x						x	x	x	
			APP			DA with visual reference in heavy precipitation with doubt about the runway surface braking capability	x							x	x	x
			APP			Adverse-wind scenario resulting in increasing tailwind below DA (not reported)						x			x	
			APP			Adverse-wind scenario including strong gusts and/or crosswind out of limits below DA (not reported)						x			x	
			APP			Adverse-wind scenario including strong gusts and/or crosswind out of limits below 15 m (50 ft) (not reported)						x			x	

Assessment and training topic		Frequency	Flight phase activation	Description (includes type of topic, being threat, error or focus)	Desired outcome (includes performance criteria OR training outcome)	Guidance material (GM) Example scenario elements	PRO	COM	FPA	FPM	LTW	PSD	SAW	WLM	KNO
Generation 3 Turboprop — Recurrent assessment and training matrix							Competency map								
			APP	execution using manual aircraft control or the flight management system(s) and automation as applicable. Design should include the element of surprise, and scenario-based go-arounds should not be predictable and anticipated. This topic is completely distinct from the go-around manoeuvre listed in the MT section that is intended only to practise psychomotor skills and a simple application of the procedures.		Lost or difficult communications resulting in no approach clearance prior to commencement of approach or final descent	x		x				x		
			APP			Birds: large flocks of birds below DA once visual reference has been established				x		x	x		
			APP			System malfunction, landing gear malfunction during the approach									

Assessment and training topic		Frequency	Flight phase activation	Description (includes type of topic, being threat, error or focus)	Desired outcome (includes performance criteria OR training outcome)	Guidance material (GM) Example scenario elements	PRO	COM	FPA	FPM	LTW	PSD	SAW	WLM	KNO
Generation 3 Turboprop — Recurrent assessment and training matrix							Competency map								
EVAL or SBT	Manual aircraft control	A	CLB CRZ DES APP	Controls the flight path through manual control	<p>Demonstrate manual aircraft control skills with smoothness and accuracy as appropriate to the situation.</p> <p>Detect deviations through instrument scanning.</p> <p>Maintain spare mental capacity during manual aircraft control.</p> <p>Maintain the aircraft within the normal flight envelope.</p> <p>Apply knowledge of the relationship between aircraft attitude, speed and thrust.</p>	Flight with unreliable airspeed, which may or may not be recoverable	x			x			x		x
			CLB CRZ DES APP			Alternate flight control modes according to malfunction characteristics	x			x				x	x
			CLB CRZ DES APP			ACAS warning (resolution advisory) requires the pilot to descend or ATC calls for immediate descent (preferably during climb which requires a significant change in aircraft attitude)	x	x		x					
			CLB CRZ DES APP			ACAS warning (resolution advisory) requires the pilot to climb or ATC calls for immediate climb (preferably during descent which requires a significant change in aircraft attitude).	x	x		x					
			DES			TAWS warning when deviating from planned descent routing, requiring immediate response	x			x	x				
			TO			Scenario immediately after take-off which requires an immediate and overweight landing			x	x	x	x			
			TO			Adverse wind, crosswinds with or without strong gusts on take-off	x			x					
			TO			Adverse weather, wind shear, wind shear encounter during take-off, with or without reactive warnings	x			x				x	

Assessment and training topic	Frequency	Flight phase activation	Description (includes type of topic, being threat, error or focus)	Desired outcome (includes performance criteria OR training outcome)	Guidance material (GM) Example scenario elements	PRO	COM	FPA	FPM	LTW	PSD	SAW	WLM	KNO
						Competency map								
Generation 3 Turboprop — Recurrent assessment and training matrix														
		TO			Engine failure during initial climb, typically 30-60 m (100-200 ft) (autopilot off)	x	x		x				x	
		CRZ			Wind shear encounter scenario during cruise, significant and rapid change in wind speed or down/updrafts, without wind shear warning	x		x			x	x	x	
		APP			Adverse weather, wind shear, wind shear encounter with or without warning during approach	x		x	x			x		
		APP			Adverse weather, deterioration in visibility or cloud base, or adverse wind, requiring a go-around from visual circling approach, during the visual segment	x	x	x	x		x	x	x	
		APP			Interception of the glide slope from above (correlation with unstable approach training)			x				x	x	
		APP LDG			Adverse wind, crosswinds with or without strong gusts on approach, final approach and landing (within and beyond limits)	x			x		x			
		APP LDG			Adverse weather, adverse wind, approach and landing in demanding weather conditions, e.g. turbulence, up and downdrafts, gusts and crosswinds including shifting wind directions				x		x	x		
		APP LDG			Circling approach manually flown at night in minimum in-flight visibility to	x			x			x	x	

Assessment and training topic	Frequency	Flight phase activation	Description (includes type of topic, being threat, error or focus)	Desired outcome (includes performance criteria OR training outcome)	Guidance material (GM) Example scenario elements	PRO	COM	FPA	FPM	LTW	PSD	SAW	WLM	KNO
Generation 3 Turboprop — Recurrent assessment and training matrix						Competency map								
					ensure ground reference, minimum environmental lighting and no glide slope guidance lights									
		APP LDG			Runway incursion during approach, which can be triggered by ATC at various altitudes or by visual contact during the landing phase	x			x			x		
		LDG			Adverse wind, visibility, type-specific, special consideration for long-bodied aircraft, landing in minimum visibility for visual reference, with crosswind	x	x		x			x		
		LDG			System malfunction, auto flight failure at DA during a low-visibility approach requiring a go-around flown manually	x		x	x			x		
		APP LDG			Approach planned with autoland, followed by a failure below 1 000 ft requiring a manual go-around and an immediate landing due to fuel shortage	x		x		x		x		
		TO			In-seat instruction: Insufficient engine failure recovery, forcing the pilot monitoring to take over the flight controls		x		x			x	x	
		APP LDG			In-seat instruction: Unstable approach on short final or long landing, forcing the pilot monitoring to take over the flight controls		x		x			x	x	

Assessment and training topic		Frequency	Flight phase activation	Description (includes type of topic, being threat, error or focus)	Desired outcome (includes performance criteria OR training outcome)	Guidance material (GM) Example scenario elements	PRO	COM	FPA	FPM	LTW	PSD	SAW	WLM	KNO
Generation 3 Turboprop — Recurrent assessment and training matrix							Competency map								
EVAL or SBT	Monitoring, cross-checking, error management, mismanaged aircraft state	A	ALL	The scenarios should be realistic and relevant, and should be used for the purpose of demonstration and reinforcement of effective monitoring.	Recognise mismanaged aircraft state. Observe the pilot's behaviour: how the pilot is mitigating errors, performing cross-checking, monitoring performance and dealing with a mismanaged aircraft state, in order to ensure that observed deviations, errors and mistakes are taken as learning opportunities throughout the programme. Monitor flight path excursions.	Deviations from the flight path, in pitch attitude, speed, altitude, bank angle		x					x		
			ALL			In-seat instruction: Simple automation errors (e.g. incorrect mode selection, attempted engagement without the necessary conditions, entering wrong altitude or speed, failure to execute the desired mode) culminating in a need for direct intervention from the pilot monitoring, and where necessary taking control.		x				x			
			APP	Modules in the FSTD should be treated like those in an aircraft so that trainees have the opportunity to develop the competency with the practice of the right techniques and attitudes related to these topics through pilot performance, and that instructors have the opportunity to	Monitor flight path excursions. Detect errors and threats through proper cross-checking performance. Make appropriate interventions either verbally or by taking control if applicable. Take appropriate action if necessary. Restore the desired aircraft state.	In-seat instruction: Unstable approach or speed/path/vertical rate not congruent with the required state for the given flight condition	x	x					x	x	
			LDG			In-seat instruction: Demonstration exercise — recovery from bounced landing, adverse wind, strong gusts during landing phase, resulting in a bounce and necessitating recovery action from the pilot monitoring	x			x				x	

Assessment and training topic	Frequency	Flight phase activation	Description (includes type of topic, being threat, error or focus)	Desired outcome (includes performance criteria OR training outcome)	Guidance material (GM) Example scenario elements	PRO	COM	FPA	FPM	LTW	PSD	SAW	WLM	KNO
Generation 3 Turboprop — Recurrent assessment and training matrix						Competency map								
			<p>assess and train these topics in a realistic environment. As shown by the EBT data report, these topics are of key importance to improve safety in operations.</p> <p>In addition, the operator may also use these topics to develop scripted role-playing scenarios in the form of ISI. These scenarios cater for the need to monitor flight path excursions from the instructor pilot (PF), detect errors and make appropriate interventions, either verbally or</p>	Identify and manage consequences.										

Assessment and training topic	Frequency	Flight phase activation	Description (includes type of topic, being threat, error or focus)	Desired outcome (includes performance criteria OR training outcome)	Guidance material (GM) Example scenario elements	PRO	COM	FPA	FPM	LTW	PSD	SAW	WLM	KNO
Generation 3 Turboprop — Recurrent assessment and training matrix						Competency map								
			by taking control as applicable. Demonstration scenarios may also be used. Demonstrated role-play should contain realistic and not gross errors, leading at times to a mismanaged aircraft state, which can also be combined with upset management training.											
Unstable approach	A	DES APP	Reinforce stabilised approach philosophy and adherence to defined parameters.		ATC or terrain-related environment creating a high-energy descent with the need to capture the optimum profile to complete the approach in a stabilised configuration	x		x				x		
		DES APP	Encourage go-arounds when crews are outside these parameters.		ATC or terrain-related environment creating a high-energy descent leading to unstable conditions and requiring a go-around	x		x		x				
		APP			Approach and landing in demanding weather conditions, e.g. turbulence, up			x		x	x			

Assessment and training topic		Frequency	Flight phase activation	Description (includes type of topic, being threat, error or focus)	Desired outcome (includes performance criteria OR training outcome)	Guidance material (GM) Example scenario elements	PRO	COM	FPA	FPM	LTW	PSD	SAW	WLM	KNO			
Generation 3 Turboprop — Recurrent assessment and training matrix							Competency map											
			APP	Develop and sustain competencies related to the management of high-energy situations.		and downdrafts, gusts and crosswinds including shifting wind directions												
			APP LDG			Increasing tailwind on final approach (not reported)	x	x					x	x				
			APP LDG			Crosswinds with or without strong gusts on approach, final approach and landing (within and beyond limits)	x			x			x					
Section 5 — UPRT training topic with frequency (B). Evaluation phase, manoeuvres training phase or scenario-based training phase (EVAL, MT or SBT)																		
EVAL, MT or SBT	Upset prevention training	B	N/A	Compliance with AMC1 or AMC2 to ORO.FC.220&230	Early recognition and prevention of upset conditions. When the differences between LHS and RHS are not significant in the handling of the aircraft, UPRT may be conducted in either seat.	See Table 1 of AMC1 ORO.FC.220&230: Elements and respective components of upset prevention training.	Intentionally blank											
			CRZ	Include upset prevention elements in Table 1 for the recurrent training programme in at least every cycle, such that all the elements are covered over a period not exceeding 3 years. The elements are numbered with letters from A to I in Table 1 of AMC1 ORO.FC.220&230.		Demonstration of the defined normal flight envelope and any associated changes in flight instruments, flight director systems, and protection systems. This should take the form of an instructor-led exercise to show the crew the points beyond which an upset condition could exist.				x					x	x		
			TO APP			Severe wind shear or wake turbulence during take-off or approach				x	x			x	x			
			CRZ			As applicable and relevant to the aircraft type, demonstration at a suitable intermediate level, with turbulence as appropriate; practise steep turns and note the relationship between bank angle, pitch and stalling speed										x		x
			CRZ			At the maximum cruise flight level for the current aircraft weight, turbulence	x			x	x					x		

Assessment and training topic		Frequency	Flight phase activation	Description (includes type of topic, being threat, error or focus)	Desired outcome (includes performance criteria OR training outcome)	Guidance material (GM) Example scenario elements	PRO	COM	FPA	FPM	LTW	PSD	SAW	WLM	KNO	
Generation 3 Turboprop — Recurrent assessment and training matrix							Competency map									
			CRZ	Each element is made up of several numbered components. According to the principles of EBT, covering one component should satisfy the requirement to cover the whole element of recognising and preventing the development of upset conditions.		to trigger overspeed conditions (if FSTD capability exists, consider use of the vertical wind component to add realism)										
			CRZ			At the maximum cruise flight level for the current aircraft weight, turbulence and significant temperature rise to trigger low-speed conditions (if FSTD capability exists, consider use of the vertical wind component to add realism)			x	x				x		x
			CRZ			High-altitude loss of reliable airspeed	x	x		x				x	x	
			CRZ			High-altitude ACAS RA (where the RA is required to be flown in manual flight)	x			x				x	x	
Section 6 — Training topics with frequency (B) in alphabetical order. Evaluation phase or scenario-based training phase (EVAL or SBT)																
EVAL, MT or SBT	Aircraft system malfunctions, including operations under MEL	B	ALL	For full details, see the malfunction equivalency methodology. Any internal failure(s) apparent or not apparent to the crew	Recognise system malfunction. Take appropriate action including correct stop/go decision. Apply the appropriate procedure correctly. Maintain aircraft control. Manage consequences.	(i) System malfunctions that require immediate and urgent crew intervention or decision, e.g. fire, smoke, loss of pressurisation at high altitude, failures during take-off, brake failure during landing. (ii) System malfunctions that require complex procedures, e.g. multiple hydraulic system failures, smoke and fumes procedures, major electrical system failure.	Intentionally blank									

Assessment and training topic	Frequency	Flight phase activation	Description (includes type of topic, being threat, error or focus)	Desired outcome (includes performance criteria OR training outcome)	Guidance material (GM) Example scenario elements	PRO	COM	FPA	FPM	LTW	PSD	SAW	WLM	KNO
						Competency map								
Generation 3 Turboprop — Recurrent assessment and training matrix														
			<p>Any item cleared by the MEL but having an impact upon flight operations — for instance, thrust reverser locked.</p> <p>Malfunctions to be considered should have one or more of the following characteristics: Immediacy Complexity Degradation of aircraft control Loss of primary instrumentation Management of consequences</p>	<p>Apply crew operating procedures where necessary. Respond appropriately to additional system abnormalities associated with MEL dispatch.</p>	<p>(iii) System malfunctions that result in significant degradation of flight controls in combination with abnormal handling characteristics, e.g. jammed flight controls, certain degradation of FBW control, jammed horizontal stabiliser; flaps and/or slats locked; other malfunctions that result in degraded flight controls.</p> <p>(iv) System failures that require monitoring and management of the flight path using degraded or alternative displays, unreliable primary flight path information, unreliable airspeed, e.g. flight with unreliable airspeed</p> <p>(v) System failures that require extensive management of their consequences (independent of operation or environment), e.g. fuel leak.</p>									
		TO	Management of consequences		MEL items with crew operating procedures applicable during take-off						x			x
		TO	The operator should vary malfunctions for each characteristic		Response to an additional factor that is affected by an MEL item (e.g. system failure, runway state)		x		x		x			x
		GND			Malfunction during preflight preparation and prior to departure	x					x	x		
		CLB			Malfunction after departure	x					x	x		x

Assessment and training topic	Frequency	Flight phase activation	Description (includes type of topic, being threat, error or focus)	Desired outcome (includes performance criteria OR training outcome)	Guidance material (GM) Example scenario elements	PRO	COM	FPA	FPM	LTW	PSD	SAW	WLM	KNO	
						Competency map									
Generation 3 Turboprop — Recurrent assessment and training matrix															
		ALL	over the EBT cycle.		Malfunctions that require immediate attention (e.g. bleed fault during engine start, hydraulic failure during taxi)	x				x			x		
		CLB CRZ	Unless specified otherwise in the operational suitability data, at least one malfunction with each characteristic should be included in every cycle. Combining characteristics should not reduce the number of malfunctions below seven for each cycle. For each crew member, the characteristics of degraded control and loss of instrumentation should be in the role of pilot flying and the others		Fuel leak (management of consequences)	x				x		x		x	
		TO			Malfunction on take-off high speed below V1	x				x	x				
		TO			Malfunction on take-off high speed above V1	x						x			
		GND			During taxi to the runway, a spurious brake temperature announcement. The crew had the correct brake temperature moments before the failure.					x	x	x			
		TO			Tyre failure during take-off					x	x			x	
		TO			Malfunction on initial climb	x						x			
		APP			Malfunction on approach	x						x		x	
		APP			Malfunction on go-around	x						x		x	
		LDG			Malfunction during landing	x	x		x			x	x		

Assessment and training topic		Frequency	Flight phase activation	Description (includes type of topic, being threat, error or focus)	Desired outcome (includes performance criteria OR training outcome)	Guidance material (GM) Example scenario elements	PRO	COM	FPA	FPM	LTW	PSD	SAW	WLM	KNO
Generation 3 Turboprop — Recurrent assessment and training matrix							Competency map								
				may be in the role of pilot flying or pilot monitoring. For full details, see the malfunction equivalency methodology.											
EVAL or SBT	Engine failure	B	TO	Any engine failure or malfunction, which causes loss or degradation of thrust that affects performance. This is distinct from the engine-out manoeuvres described in the MT section above, which are intended only to practise psychomotor skills and reinforce procedures to manage engine failures.	Recognise engine failure. Take appropriate action. Apply the appropriate procedure correctly. Maintain aircraft control. Manage consequences.	Engine failure or engine malfunction on take-off low speed	x			x		x		x	
			TO			Engine failure or engine malfunction on take-off high speed below V1	x			x		x			
			TO			Engine failure or engine malfunction on take-off above V1	x				x	x	x		
			TO			Engine failure or engine malfunction on initial climb	x				x	x			
			APP			Engine malfunction	x				x		x		
			CRZ			Engine failure in cruise (with autopilot)	x		x				x		
			LDG			Engine failure or engine malfunction on landing							x		

Assessment and training topic		Frequency	Flight phase activation	Description (includes type of topic, being threat, error or focus)	Desired outcome (includes performance criteria OR training outcome)	Guidance material (GM) Example scenario elements	PRO	COM	FPA	FPM	LTW	PSD	SAW	WLM	KNO
Generation 3 Turboprop — Recurrent assessment and training matrix							Competency map								
	Landing	B	LDG	Pilots should have opportunities to practise landings in demanding situations at the defined frequency. Data indicates that landing problems have their roots in a variety of factors, including inappropriate decision-making, in addition to manual aircraft control skills if difficult environmental conditions exist. The purpose of this item is to ensure that pilots are exposed to this during the programme.	Landing in demanding environmental conditions, with malfunctions as appropriate	This topic should be combined with the adverse-weather topic, aircraft system malfunctions topic or any topic that can provide exposure to a landing in demanding conditions.	Intentionally blank								
EVAL	Surprise	B	ALL	The data analysed during the	Exposure to an unexpected event or	Rejected take-off	x			x		x			

Assessment and training topic	Frequency	Flight phase activation	Description (includes type of topic, being threat, error or focus)	Desired outcome (includes performance criteria OR training outcome)	Guidance material (GM) Example scenario elements	PRO	COM	FPA	FPM	LTW	PSD	SAW	WLM	KNO
						Competency map								
Generation 3 Turboprop — Recurrent assessment and training matrix														
			development of the EBT concept indicated substantial difficulties encountered by crews when faced with a threat or error, which was a surprise or an unexpected event. The element of surprise should be distinguished from what is sometimes referred to as the 'startle factor' — the latter being a physiological reaction. Wherever possible, consideration should be given towards variations in the types of scenario,	sequence of events at the defined frequency in order to build resilience.	Intentionally blank	Intentionally blank								

Assessment and training topic		Frequency	Flight phase activation	Description (includes type of topic, being threat, error or focus)	Desired outcome (includes performance criteria OR training outcome)	Guidance material (GM) Example scenario elements	PRO	COM	FPA	FPM	LTW	PSD	SAW	WLM	KNO
Generation 3 Turboprop — Recurrent assessment and training matrix							Competency map								
				times of occurrences and types of occurrence, so that pilots do not become overly familiar with repetitions of the same scenarios. Variations should be the focus of EBT programme design, and not left to the discretion of individual instructors, in order to preserve programme integrity and fairness.											
EVAL or SBT	Terrain	B	ALL	Alert, warning, or conflict	Anticipate terrain threats. Prepare for terrain threats. Recognise unsafe terrain clearance. Take appropriate action.	ATC clearance giving insufficient terrain clearance	x	x			x				
			ALL			Demonstration of terrain avoidance warning systems (TAWS) (this scenario element may be done in an ISI.)					x	x	x		
			TO CLB			Engine failure where performance is marginal leading to TAWS warning		x		x				x	

Assessment and training topic	Frequency	Flight phase activation	Description (includes type of topic, being threat, error or focus)	Desired outcome (includes performance criteria OR training outcome)	Guidance material (GM) Example scenario elements	PRO	COM	FPA	FPM	LTW	PSD	SAW	WLM	KNO
						Competency map								
Generation 3 Turboprop — Recurrent assessment and training matrix														
		DES APP		Apply the appropriate procedures correctly. Maintain aircraft control. Restore safe flight path. Manage consequences.	ATC provides a wrong QNH		x					x		
		DES			'Virtual mountain' refers to the surprise element of an unexpected warning. Care should be exercised in creating a level of realism, so this can best be achieved by an unusual and unexpected change of route during the descent.							x	x	x

Assessment and training topic		Frequency	Flight phase activation	Description (includes type of topic, being threat, error or focus)	Desired outcome (includes performance criteria OR training outcome)	Guidance material (GM) Example scenario elements	PRO	COM	FPA	FPM	LTW	PSD	SAW	WLM	KNO
Generation 3 Turboprop — Recurrent assessment and training matrix							Competency map								
EVAL or SBT	Workload, distraction, pressure, stress	B	ALL	This is not considered a topic for specific attention on its own, but more as a reminder to programme developers to ensure that pilots are exposed to immersive training scenarios which expose them to manageable high workload and distractions during the course of the EBT programme, at the defined frequency.	Manage available resources efficiently to prioritise and perform tasks in a timely manner under all circumstances	Intentionally blank	Intentionally blank								

Section 7 — UPRT Upset recovery training topic with frequency (C). Evaluation phase, manoeuvres training phase or scenario-based training phase (EVAL, MT or SBT)													
MT or SBT	Upset recovery	C	N/A	<p>Compliance with AMC1 or AMC2 to ORO.FC.220&230</p> <p>Include the recovery exercises in Table 2 of AMC1 ORO.FC.220&230 for the recurrent training programme, such that all the exercises are covered over a period not exceeding 3 years. According to the principles of EBT, covering one component should satisfy the requirement to cover the whole element of recovery from developed upsets. The same principles apply to the exercises of components 2, 3 and 4 where one exercise may satisfy the</p>	<p>Recognise upset condition.</p> <p>Make timely and appropriate intervention. Take appropriate action. Assure timely and appropriate intervention. (AMC1 ORO.FC.220&230 Table 2 component 1)</p> <p>Assure aircraft control. Maintain or restore a safe flight path.</p> <p>Assess consequential issues. Manage outcomes.</p> <p>Consolidate the summary of aeroplane recovery techniques. (AMC1 ORO.FC.220&230 Table 2 component 5)</p> <p>Note: The operator should assess if the exercises should be practised for the either seat qualification.</p>	<p>The example scenario elements may be done in ISI, as non-ISI or a combination of both.</p> <p>If done in ISI: The instructor should position the aircraft within but close to the edge of the validated training envelope before handing control to the trainee to demonstrate the restoration of normal flight. Careful consideration should be given to flying within the validated training envelope.</p>	Intentionally blank						
			Table 2 of AMC1 ORO.FC.220&230: Exercises for upset recovery training										
			A. Recovery from developed upsets										
			CLB DES	2.	Recovery from stall events in the following configurations: take-off configuration, clean configuration low altitude, clean configuration near maximum operating altitude, and landing configuration during the approach phase.	x			x			x	x
			CRZ	3.	Recovery from nose high at various bank angles	x			x			x	x
			CRZ	4.	Recovery from nose low at various bank angles	x			x			x	x
			APP	Demonstration at a normal cruising altitude. Set conditions and disable aircraft systems as necessary to enable trainee to perform stall recovery according to OEM instructions.		x			x			x	
			CLB DES	Demonstration at an intermediate altitude during early stages of the approach. Set conditions and disable		x			x			x	

				<p>requirement to cover the whole component.</p> <p>An aeroplane upset is defined as an undesired aeroplane state in flight characterised by unintentional divergences from parameters normally experienced during line operations or training. An aeroplane upset may involve pitch and/or bank angle divergences as well as inappropriate airspeeds for the conditions.</p>		<p>aircraft systems as necessary to enable trainee to perform stall recovery according to OEM instructions.</p>											
						<p>Recovery from a wake turbulence position with high-bank angle</p>	x		x	x					x		
Section 8 – Training topics with frequency (C) in alphabetical order. Evaluation phase or scenario-based training phase (EVAL or SBT)																	
EVAL or SBT	Adverse wind	C	TO	<p>Adverse wind/crosswind. This includes tailwind but not ATC mis-reporting of the actual wind.</p>	<p>Recognise adverse-wind conditions. Observe limitations. Apply the appropriate procedures. Maintain directional control and safe flight path.</p>	Take-off with different crosswind/tailwind/gust conditions									x		x
			TO			Take-off with unreported tailwind		x			x						
			TO			Crosswinds with or without strong gusts on take-off	x				x						
			APP			Wind exceeding limits on final approach (not reported)	x	x					x	x			
			APP			Wind exceeding limits on final approach (reported) in manual aircraft control	x	x			x			x			

			APP			Increasing tailwind on final approach (not reported)	x	x				x	x			
			APP			Approach and landing in demanding weather conditions, e.g. turbulence, up and downdrafts, gusts and crosswind including shifting wind directions				x		x	x			
			APP			Adverse-wind scenario resulting in increasing tailwind below DA (not reported)		x		x		x				
			APP			Adverse-wind scenario including strong gusts and/or crosswind out of limits below DA (not reported)		x		x		x				
			APP			Adverse-wind scenario including strong gusts and/or crosswind out of limits below 15 m (50 ft) (not reported)		x		x		x				
			APP LDG			Crosswind with or without strong gusts on approach, final approach and landing (within and beyond limits)	x			x		x				
	Approach, visibility close to minimum	C	Any situation where visibility becomes a threat	APP	Recognise actual conditions. Observe aircraft and/or procedural limitations. Apply the appropriate procedures if applicable. Maintain directional control and safe flight path.	Approach in poor visibility	x		x	x					x	
				APP		Approach in poor visibility with deteriorations necessitating a decision to perform a go-around	x		x	x						
				LDG		Landing in poor visibility				x		x	x			
	EVAL or SBT	ATC	C	ALL	ATC error. Omission, miscommunication, garbled, poor quality transmission. All	Respond to communications appropriately. Recognise, clarify and resolve any ambiguities.	ATC role-play: the instructor provides scripted instructions, as a distraction to the crew	x	x			x				
				ALL			Controller error, provided by the instructor according to a defined scripted scenario	x	x				x	x		

		ALL	these act as distractions to be managed by the crew. The scenarios should be combined, where possible, with others of the same or higher weighting, the principal reason being to create distractions.	Refuse or question unsafe instructions. Use standard phraseology whenever possible.	Frequency congestion, with multiple aircraft using the same frequency		x											
		APP			Destination temporarily closed						x	x	x	x				
		CRZ			Rescue and firefighting services (RFFS) level reduction at destination		x				x		x					
		APP			Runway change before the interception of the localiser or similar navigation aid in azimuth				x		x		x	x				
		GND /TO			Stray dogs at the opposite threshold runway		x				x		x					
		ALL			Poor quality transmissions		x											
EVAL or SBT	Fire and smoke management	C	This includes engine, electric, pneumatic, cargo fire, smoke or fumes.	Recognise fire, smoke or fumes Take appropriate action. Apply the appropriate procedure correctly. Maintain aircraft control. Manage consequences.	Fire in cargo or cabin/cockpit at gate	x	x					x			x			
					Fire during taxi	x	x					x			x	x		
					Fire with no cockpit indication	x	x					x			x	x	x	
					Take-off low speed	x				x	x	x					x	
					Fire or smoke on take-off high speed below V1	x				x	x	x						
					Fire or smoke on take-off high speed above V1	x						x	x					
					Fire or smoke on Initial climb	x						x	x					
					Cargo fire								x	x	x			
					Engine fire in approach (extinguishable)		x						x					
					Engine fire in approach (non-extinguishable)		x						x	x				
					Lithium battery fire in the cockpit or cabin compartment	x	x						x	x			x	
					Flight deck or cabin fire		x						x	x			x	
					Any of the example scenario elements above ending in an evacuation		x						x	x			x	

EVAL or SBT	Loss of communications	C	GND	Lost or difficult communications due to either pilot mis-selection or a failure external to the aircraft. This could be for a few seconds or a total loss.	Recognise loss of communications. Take appropriate action. Execute the appropriate procedure as applicable. Use alternative ways to communicate. Manage consequences.	Loss of communications during ground manoeuvring		x	x										
			TO			Loss of communications after take-off		x					x				x		
			APP			Loss of communications during approach phase, including go-around		x	x					x	x			x	
EVAL or SBT	Managing loading, fuel, performance errors	C	ALL	A calculation error by one or more pilots, or someone involved with the process, or the process itself, e.g. incorrect information on the load sheet	Anticipate the potential for errors in load/fuel/performance data. Recognise inconsistencies. Manage/avoid distractions. Make changes to paperwork/aircraft system(s) to eliminate error. Identify and manage consequences.	This can be a demonstrated error, in that the crew may be instructed to deliberately insert incorrect data — for example, to take off from an intersection with full-length performance information. The crew will be asked to intervene when acceleration is sensed to be lower than normal, and this may be part of the operator procedures, especially when operating mixed fleets with considerable variations in MTOM.		x	x								x		
			GND			Fuel ground staff on industrial action. Only limited amount of fuel available, which is below the calculated fuel for the flight.								x	x	x	x		
			GND			Advise crew that there is a change of the load sheet figures during taxi to the runway. The crew may have limited time due to a calculated take-off time (CTOT) — ATC slot.		x											x
			GND			Braking action reported 'medium'. The information is transmitted just before take-off. The flight is subject to a									x		x	x	

						calculated take-off time (CTOT) — ATC slot.											
EVAL or SBT	Navigation	C	GND	External NAV failure. Loss of GPS satellite, ANP exceeding RNP, loss of external NAV source(s)	Recognise a NAV degradation. Take appropriate action. Execute the appropriate procedure as applicable. Use alternative NAV guidance. Manage consequences.	External failure or a combination of external failures degrading aircraft navigation performance on ground	x		x				x	x			
			TO CLB APP LDG			External failure or a combination of external failures degrading aircraft navigation performance in flight		x			x	x	x				
			GND			Standard initial departure change during taxi. The flight may be subject to a CTOT — ATC slot.					x			x	x		
			APP			Loss of runway lighting below decision height		x				x	x				
			CRZ			No fly zone: when the crew changes control frequency, the new ATCO informs the crew that they are flying over an unannounced 'no fly zone' that is not included in the NOTAMs. (To trigger such an event, the context may be as follows: an unexpected military conflict in the territory the aircraft is flying over or the crew is forced to re-route in flight and the new route flies over a city that has an important event such the Olympic games, a G20/G7 summit, or the route is flying near a space rocket launch close to the time of the launch, like the Guiana Space Centre, Cape Cañaverl, etc.).								x	x	x	
Operations- or type-specific	C	ALL	Intentionally blank	Intentionally blank	Intentionally blank	Intentionally blank											

	Operations of special airport approval	C	APP LDG	See equivalency of approaches relevant to operations.	The operator should comply with the national qualification requirements published in the aeronautical information publication (AIP).	Intentionally blank	Intentionally blank									
EVAL or SBT	Pilot incapacitation	C	TO	Consequences for the non-incapacitated pilot	Recognise incapacitation. Take appropriate action including correct stop/go decision. Apply the appropriate procedure correctly. Maintain aircraft control. Manage consequences.	During take-off	x	x			x	x			x	
			APP			During approach	x			x				x	x	
EVAL or SBT	Runway or taxiway condition	C	GND TO LDG	Contamination or surface quality of the runway, taxiway, or tarmac including foreign objects	Recognise hazardous runway condition. Observe limitations. Take appropriate action. Apply the appropriate procedures correctly. Assure aircraft control.	Planned anticipated hazardous conditions with dispatch information provided to facilitate planning and execution of appropriate procedures							x			x
			GND TO LDG			Unanticipated hazardous conditions, e.g. unexpected heavy rain resulting in flooded runway surface		x			x	x				
			TO			Take-off on runway with reduced cleared width due to snow	x			x	x		x			
			TO			Stop/go decision in hazardous conditions				x	x			x		
EVAL or SBT	Traffic	C	CLB CRZ DES	Traffic conflict. ACAS RA or TA, or visual observation of conflict, which	Anticipate potential loss of separation. Recognise loss of separation.	ACAS warning that requires crew intervention		x					x	x	x	

			requires evasive manoeuvring	Take appropriate action. Apply the appropriate procedure correctly. Maintain aircraft control. Manage consequences.	Dilemma: Visual acquisition of conflicting traffic followed by an ACAS warning (resolution advisory) triggered by the same or other traffic. Even if the traffic is in sight, the pilot should follow the RA.	x		x	x						
					While in descent, ACAS warning (traffic advisory) of an aircraft below. The crew should not initiate an avoidance manoeuvre based on TA (except decreasing the rate of descent unless otherwise instructed by ATC, etc.). This example scenario can be done during climb with conflicting traffic above.	x				x	x				
Wind shear recovery	C	TO	With or without warnings including predictive. A wind shear scenario is ideally combined with an adverse-weather scenario containing other elements.	Anticipate potential for wind shear. Avoid known wind shear or prepare for suspected wind shear. Recognise wind shear encounter. Take appropriate action. Apply the appropriate procedure correctly. Assure aircraft control. Recognise out of wind shear condition. Maintain or restore a safe flight path. Assess consequential issues and manage outcomes.	Predictive wind shear warning during take-off					x	x				
		TO			Wind shear encounter during take-off	x				x	x				
		TO			Wind shear encounter after rotation						x			x	
		TO			Predictive wind shear after rotation						x	x			
		APP			Predictive wind shear during approach	x					x	x			
		APP			Wind shear encounter during go-around	x					x	x			x
		APP			Wind shear encounter during approach	x						x	x		

END GEN2 TURBOPROP

AMC7 ORO.FC232 EBT programme assessment and training topics

ED Decision 2021/002/R

GENERATION 1 (JET) — EBT PROGRAMME — TABLE OF ASSESSMENT AND TRAINING TOPICS

Given the very small number of turbo-jet aeroplanes of the first generation in current use in commercial air transport operations and the lack of appropriate FSTDs for recurrent training, it has not been deemed possible to provide a table of assessment and training topics for those aeroplanes and therefore it is not possible to apply EBT.

AMC8 ORO.FC.232 EBT programme assessment and training topics

ED Decision 2021/002/R

SCENARIO ELEMENTS AND COMPETENCY MAPPING

- (a) The operator may develop scenario elements and a competency map that are more relevant to its operation.
- (b) When developing scenario elements, the operator should ensure that there can be no negative training when asking pilots to induce their own errors.
- (c) Competencies mapped are those considered critical in managing the scenario. They are determined according to the following principles:
 - (1) those competencies considered most critical to the successful management of the defined threat or error; or
 - (2) those competencies most likely to be linked to the root cause of poor performance in the case of unsuccessful management of a defined threat or error.
- (d) The competency map may indicate scenarios or combinations of scenarios for development of particular competencies.
- (e) The competency map indicates the most critical competencies suggested by design, but the instructor should always assess all observed competencies.

GM1 ORO.FC.232 EBT programme assessment and training topics

ED Decision 2021/002/R

TABLE OF ASSESSMENT AND TRAINING TOPICS

- (a) The assessment and training topics usually have several example scenario elements. At least one example scenario element is selected (e.g. Gen 4 topic ‘Go-around’ in MT has three example scenario elements — the operator may choose one at each module (frequency A)).
- (b) Flight phase for activation:

Abbreviation	Flight phase	Description
GND (1)	Flight planning, preflight, engine start & taxi-out	Ground phases up to when the crew increases thrust for taking-off
	Taxi-in, engine shutdown, post-flight & flight closing	From the speed that permits the aircraft to be manoeuvred by means of taxiing for arriving at a parking area until the crew completes post-flight and flight closing duties.
TO (2)	Take-off	This phase begins when the crew increases the thrust for taking-off. It ends after the speed and configuration are established at a defined manoeuvring altitude or to continue the climb for cruise.
CLB (3)	Climb	This phase begins when the crew establishes the aircraft at a defined speed and configuration enabling the aircraft to increase altitude for the purpose of cruise. It ends with the aircraft established at a predetermined constant initial cruise altitude at a defined speed.
CRZ (4)	Cruise	The cruise phase begins when the crew establishes the aircraft at a defined speed and predetermined constant initial cruise altitude and

		proceeds in the direction of a destination. It ends with the beginning of descent for an approach.
DES (5)	Descent	This phase begins when the crew departs the cruise altitude for an approach at a particular destination. It ends when the crew initiates changes in aircraft configuration and/or speed to facilitate a landing on a particular runway.
APP (6)	Approach	This phase begins when the crew initiates changes in aircraft configuration and/or speeds enabling the aircraft to manoeuvre for landing on a particular runway. It ends when the aircraft is in the landing configuration and the crew is dedicated to land on a specific runway. It also includes go-around where the crew aborts the descent to the planned landing runway during the approach phase. Go-around ends after speed and configuration are established at a defined manoeuvring altitude or to continue the climb for cruise.
LDG (7)	Landing	This phase begins when the aircraft is in the landing configuration and the crew is dedicated to touchdown on a specific runway. It ends when the speed permits the aircraft to be manoeuvred by means of taxiing for arrival at a parking area.
ALL (8)	All	Any or all phases of flight

GM2 ORO.FC.232 EBT programme assessment and training topics

ED Decision 2021/002/R

COMPETENCY MAP PROCESS

Note 1. The competency map process may be done in teams of instructors. Then the results are compared and reconciled by a small group of subject matter experts (SMEs).

Note 2. It is always easy to map SAW or KNO as the underlying competency, but there are almost invariably other competencies, especially when there is ineffective management, so the intent should be to balance the mapping of SAW or KNO and map the other predominant competencies within the scenario.

AMC1 ORO.FC.232(b)(1) EBT programme assessment and training topics

ED Decision 2021/002/R

EBT DATA REPORT

- (a) The data report is a large-scale comprehensive study of operational data. It identifies the areas of pilot training for improvement, providing the prioritisation of germane and relevant training topics to guide in the construction of suitable EBT programmes. The data report uses other studies, a variety of data sources and/or varied methodology to mitigate the inherent bias associated with individual types of data sources.
- (b) The data report should:
 - (1) be endorsed or developed by the competent authority, EASA or ICAO;
 - (2) be reviewed by a team of experts in pilot training, representing airline operators, pilot associations, regulators, and original equipment manufacturers (OEM);

- (3) use data or information (training data, operational data and safety data) from the following sources:
 - (i) accident investigation bodies;
 - (ii) competent authorities;
 - (iii) OEM — aircraft;
 - (iv) EASA safety information;
 - (v) operators; and
 - (vi) studies or reports (aviation or scientific);
- (4) analyse the data with the following objectives:
 - (i) to substantiate the need for change in the assessment and training programmes for commercial transport pilots;
 - (ii) to provide evidence from data analyses to support the derivation of training topics, prioritised according to aircraft generation;
 - (iii) to challenge and/or corroborate the other sources of data (e.g. Training Criticality Survey and Training Guidance) with operational data;
 - (iv) to provide feedback regarding the effectiveness of changes implemented through the adoption of competency-based training methodologies; and
 - (v) to validate or ascertain practices, findings or conclusions made previously by the industry;
- (5) include the studies and define the use of such studies in the data report following the criteria below:
 - (i) The study is relevant from a training perspective (e.g. if incorporating a training change mitigates the risk found in the study).
 - (ii) There is evidence that it will assist with the identification of competencies to be developed in training in order to mitigate risks encountered in the evolving operational environment.
 - (iii) The findings of the study will be corroborative or challenging across the spectrum of the analysis made in the data report.
 - (iv) The study allows the analysis and comparison of the data or findings in the data report and it is coming from industry-respected research or studies;
- (6) include an evidence table for the purpose of:
 - (i) integrating the evidence of the analyses in points (4) and (5);
 - (ii) identifying meaningful patterns;
 - (iii) enabling the grouping of evidence to support the key findings; and
 - (iv) facilitating the prioritisation of results; and
- (7) include a prioritisation of the training topics for the purpose of translating data into useful events and scenarios to assess and develop pilot performance (assessment and training topics). The prioritisation shall:

- (i) systematically rank threats, errors and competencies along with the factors leading to accidents and serious incidents from multiple data sources to formulate a table of assessment and training topics;
- (ii) be performed for each of the generations of aircraft. This allows highlighting the differences and commonalities between generations; and
- (iii) ensure sufficient flexibility in the process to allow enhancement of the training programmes according to the type of operation, culture and type of aircraft.

AMC1 ORO.FC.232(b)(3) EBT programme assessment and training topics

ED Decision 2021/002/R

AIRCRAFT TYPES BY GENERATIONS

The operator should only develop an EBT programme for aircraft types for which there is a table of assessment and training topics.

Generation 4 — Jet)	<p>From 1988.</p> <p>EFIS cockpit — FMS equipped</p> <p>FADEC</p> <p>Fly-by-wire control systems</p> <p>Advanced flight envelope protection</p> <p>Integrated auto flight control system — navigation performance, and terrain avoidance systems</p> <p>Generation fatal accident average rate: 0,1/million flights</p>	<p>A318/A319/A320/A321 (including neo), A330, A340-200/300, A340-500/600, B777, A380, B787, A350, Bombardier C Series (A220), Embraer E170/E175/E190/E195</p>
Generation 3 — Jet	<p>From 1969</p> <p>EFIS cockpit — FMS equipped</p> <p>FADEC</p> <p>Integrated auto flight control system — navigation performance, and terrain avoidance systems</p> <p>Basic flight envelope protection — stick shaker/pusher</p> <p>Generation fatal accident average rate: 0,2/million flights</p>	<p>A310/A300-600, B737-300/400/500, B737-600/700/800 (NG), B737 MAX, B757, B767, B747-400, B747-8, B717, BAE 146, MD11, MD80, MD90, F70, F100, Bombardier CRJ Series, Embraer ERJ 135/145</p>
Generation 3 — Turboprop	<p>From 1992</p> <p>EFIS cockpit — FMS equipped</p> <p>EEC/ECU or higher engine control</p> <p>Integrated auto flight control system — navigation performance and terrain avoidance systems</p> <p>Basic flight envelope protection — stick shaker/pusher</p>	<p>ATR 42-600, ATR 72-600, Bombardier Dash 8-400, BAE ATP, Saab 2000</p>
Generation 2 — Jet	<p>From 1964.</p> <p>Integrated auto-flight system.</p> <p>EEC/ECU or higher engine control</p>	<p>A300 (except A300-600), BAC111, B727, B737-100/200,</p>

	Analogue/CRT instrument display Basic flight envelope protection — stick shaker/pusher Generation fatal accident average rate: 0,7/million flights	B747-100/200/300, DC9, DC10, F28, L1011
Generation 2 — Turboprop	From 1964 Analogue/CRT instrument display EEC/ECU Basic flight envelope protection — stick shaker/pusher Integrated auto flight control system	ATR 42, ATR 72 (all series except -600), BAE J-41, Fokker F27/50, Bombardier Dash 7 and Dash 8-100/200/300 Series, Convair 580-600 Series, Shorts 330 and 360, Saab 340, Embraer 120
Generation 1 — Jet	From 1952 First commercial jets. Manual engine control Analogue instrument display Not integrated auto flight control system Basic flight envelope protection — stick shaker/pusher, attitude warning Generation fatal accident average rate: 3.0/million flights	DC8, B707

ORO.FC.235 Pilot qualification to operate in either pilot's seat — aeroplanes

Regulation (EU) 2021/2237

- (a) Commanders of aeroplanes whose duties require them to operate in either pilot's seat and carry out the duties of a co-pilot, or commanders required to conduct training or checking duties shall complete additional training and checking to ensure that they are proficient in conducting the relevant normal, abnormal and emergency procedures from either seat. Such training and checking shall be specified in the operations manual. The checking may be conducted together with the operator proficiency check prescribed in [ORO.FC.230\(b\)](#) or in the EBT programme prescribed in [ORO.FC.231](#).
- (b) The additional training and checking shall include at least the following:
- (1) an engine failure during take-off;
 - (2) a one-engine-inoperative approach and go-around; and
 - (3) a one-engine-inoperative landing.
- (c) The validity period shall be 12 calendar months. For operators with an approved EBT programme, the validity is determined by the assessment and training topics in accordance with [ORO.FC.232](#).
- (d) When operating in the co-pilot's seat, the checks required by [ORO.FC.230](#) or the assessment and training required by [ORO.FC.231](#) for operating in the commander's seat shall, in addition, be valid and current.
- (e) The pilot relieving the commander shall have demonstrated, concurrent with the operator proficiency checks prescribed in [ORO.FC.230\(b\)](#) or the assessment and training required by

[ORO.FC.231](#), practice of drills and procedures that would not normally be his or her responsibility. Where the differences between left- and right-hand seats are not significant, practice may be conducted in either seat.

- (f) The pilot, other than the commander, occupying the commander's seat shall demonstrate practice of drills and procedures, concurrent with the operator proficiency checks prescribed in [ORO.FC.230\(b\)](#) or the assessment and training required by [ORO.FC.231](#), which are the commander's responsibility acting as pilot monitoring. Where the differences between left- and right-hand seats are not significant, practice may be conducted in either seat.

GM1 ORO.FC.235(e);(f) Pilot qualification to operate in either pilot's seat

ED Decision 2022/014/R

DIFFERENCES BETWEEN LEFT AND RIGHT-HAND SEATS

The differences between left- and right-hand seats may not be significant in cases where, for example, the autopilot is used.

ORO.FC.236 Pilot qualification to operate in either pilot's seat — helicopters

Regulation (EU) 2021/2237

- (a) Helicopter pilots whose duties require them to operate in either pilot's seat shall complete additional training and checking to ensure that they are proficient in conducting the relevant normal, abnormal and emergency procedures from either seat. The validity period of this qualification shall be 12 calendar months.
- (b) Current FIs or TRIs on the relevant type are considered to fulfil the requirement of point (a) if they have had a FI or TRI activity in the last 6 months on that type and on the helicopter.

AMC1 ORO.FC.236 Pilot qualification to operate in either pilot's seat — helicopters

ED Decision 2022/014/R

GENERAL

- (a) The operator should either conduct a check every year or alternate training and checking every year. The training and checking may take place during or together with an operator proficiency check or an aircraft/FSTD training session.
- (b) When engine-out manoeuvres are carried out in an aircraft, the engine failure should be simulated.
- (c) Helicopter pilots should meet one of the following criteria:
- (1) complete their operator proficiency checks from left- and right-hand seats, on alternate proficiency checks; or
 - (2) for multi-engined helicopters, if two consecutive operator proficiency checks are conducted from the same seat, the pilot should complete at least the following from the other pilot's seat:
 - (i) an engine failure during take-off;

- (ii) a one-engine-inoperative approach and go-around; and
 - (iii) a one-engine-inoperative landing;
- (3) for single-engined helicopters, if two consecutive operator proficiency checks are conducted from the same seat, the pilot should complete at least one autorotation training or checking from the other pilot's seat.

GM1 ORO.FC.236 Pilot qualification to operate in either pilot's seat — helicopters

ED Decision 2022/014/R

QUALIFICATION TO FLY IN EITHER PILOT'S SEAT — NOMINATED COMMANDER CONDUCTING LINE CHECKS

In the case of a line check revalidation of a fully qualified commander in single-pilot operations, the line checker does not require a qualification to operate in either pilot's seat, regardless of the seat he or she occupies, provided that the line checker has no pilot duties other than checking.

ORO.FC.240 Operation on more than one type or variant

Regulation (EU) 2021/2237

- (a) The procedures or operational restrictions for operation on more than one type or variant established in the operations manual and approved by the competent authority shall cover:
- (1) the flight crew members' minimum experience level;
 - (2) the minimum experience level on one type or variant before beginning training for and operation of another type or variant;
 - (3) the process whereby flight crew qualified on one type or variant will be trained and qualified on another type or variant; and
 - (4) all applicable recent experience requirements for each type or variant.
- (b) INTENTIONALLY LEFT BLANK
- (c) Point (a) shall not apply to operations of performance class B aeroplanes if they are limited to single-pilot classes of reciprocating engine aeroplanes under VFR by day.

AMC1 ORO.FC.240 Operation on more than one type or variant

ED Decision 2022/014/R

GENERAL

- (a) Aeroplanes
- (1) When a flight crew member operates more than one aeroplane class, type or variant, as determined by the operational suitability data established in accordance with [Commission Regulation \(EU\) No 748/2012](#) for class-single pilot or type-single pilot, but not within a single licence endorsement, the operator should ensure that the flight crew member does not operate more than:
 - (i) three reciprocating engine aeroplane types or variants;
 - (ii) three turbo-propeller aeroplane types or variants;
 - (iii) one turbo-propeller aeroplane type or variant and one reciprocating engine aeroplane type or variant; or

- (iv) one turbo-propeller aeroplane type or variant and any aeroplane within a particular class.
- (2) When a flight crew member operates more than one aeroplane type or variant within one or more licence endorsement, as determined by the operational suitability data established in accordance with [Commission Regulation \(EU\) No 748/2012](#), the operator should ensure that:
- (i) the minimum flight crew complement specified in the operations manual is the same for each type or variant to be operated;
 - (ii) the flight crew member does not operate more than two aeroplane types or variants for which a separate licence endorsement is required, unless credits related to the training, checking, and recent experience requirements are defined in the operational suitability data established in accordance with [Commission Regulation \(EU\) No 748/2012](#) for the relevant types or variants; and
 - (iii) only aeroplanes within one licence endorsement are flown in any one flight duty period, unless the operator has established procedures to ensure adequate time for preparation.
- (3) When a flight crew member operates more than one aeroplane type or variant as determined by the operational suitability data established in accordance with [Commission Regulation \(EU\) No 748/2012](#) for type-single pilot and type-multi pilot, but not within a single licence endorsement, the operator should comply with points (a)(2) and (4).
- (4) When a flight crew member operates more than one aeroplane type or variant as determined by the operational suitability data established in accordance with [Commission Regulation \(EU\) No 748/2012](#) for type multi-pilot, but not within a single licence endorsement, or combinations of aeroplane types or variants as determined by the operational suitability data established in accordance with [Commission Regulation \(EU\) No 748/2012](#) for class single-pilot and type multi-pilot, the operator should comply with the following:
- (i) point (a)(2);
 - (ii) before exercising the privileges of more than one licence endorsement:
 - (A) flight crew members should have completed two consecutive OPCs and should have:
 - 500 hours in the relevant crew position in CAT operations with the same operator; or
 - for IFR and VFR night operations with performance class B aeroplanes, 100 hours or flight sectors in the relevant crew position in CAT operations with the same operator, if at least one licence endorsement is related to a class. A check flight should be completed before the pilot is released for duties as commander;
 - (B) in the case of a pilot having experience with an operator and exercising the privileges of more than one licence endorsement, and then being promoted to command with the same operator on one of those types, the required minimum experience as commander is 6 months and 300 hours, and the pilot should have completed two consecutive OPCs before again being eligible to exercise more than one licence endorsement;

- (iii) before commencing training for and operation of another type or variant, flight crew members should have completed 3 months and 150 hours flying on the base aeroplane, which should include at least one proficiency check, unless credits related to the training, checking and recent experience requirements are defined in the operational suitability data established in accordance with [Commission Regulation \(EU\) No 748/2012](#) for the relevant types or variants;
- (iv) after completion of the initial line check on the new type, 50 hours flying or 20 sectors should be achieved solely on aeroplanes of the new type rating, unless credits related to the training, checking and recent experience requirements are defined in the operational suitability data established in accordance with [Commission Regulation \(EU\) No 748/2012](#) for the relevant types or variants;
- (v) recent experience requirements established in [Commission Regulation \(EU\) No 1178/2011](#) for each type operated;
- (vi) the period within which line flying experience is required on each type should be specified in the operations manual;
- (vii) when credits are defined in the operational suitability data established in accordance with [Commission Regulation \(EU\) No 748/2012](#) for the relevant type or variant, this should be reflected in the training required in [ORO.FC.230](#) and:
 - (A) [ORO.FC.230 \(b\)](#) requires two OPCs every year. When credits are defined in the operational suitability data established in accordance with [Commission Regulation \(EU\) No 748/2012](#) for OPCs to alternate between the types, each OPC should revalidate the OPC for the other type(s). The OPC may be combined with the proficiency checks for revalidation or renewal of the aeroplane type rating or the instrument rating in accordance with [Commission Regulation \(EU\) No 1178/2011](#). For EBT programmes, [ORO.FC.231\(a\)\(3\)](#) requires the pilot to complete a minimum of two modules of the EBT programme, separated by a period of more than 3 months, within a 12-month period. In addition, the pilot is required to be trained according to assessment and training topics distributed across a 3-year period at the defined frequency relevant to the type or variant of aircraft. When credits are defined in the operational suitability data established in accordance with [Commission Regulation \(EU\) No 748/2012](#), EBT modules should alternate between types. The EBT modules may be combined for revalidation or renewal of the aeroplane type rating or the instrument rating in accordance with [Commission Regulation \(EU\) No 1178/2011](#). When operating more than one type of different generations, the operator has to fulfil both generation table of assessment and training topics as per [ORO.FC.232](#).
 - (B) [ORO.FC.230 \(c\)](#) requires one line check every year. When credits are defined in the operational suitability data established in accordance with [Commission Regulation \(EU\) No 748/2012](#) for line checks to alternate between types or variants, each line check should revalidate the line check for the other type or variant. For EBT programmes, [ORO.FC.231\(h\)](#) requires one line evaluation of competence every year. When credits are defined in the operational suitability data established in accordance with [Commission Regulation \(EU\) No 748/2012](#) for line evaluation of competence to alternate between types or variants, each line evaluation of competence should

revalidate the line evaluation of competence for the other type or variant. In such case, the operator should meet the requirements to extend the validity of the line evaluation of competence to 2 years. Extension to 3 years should not be allowed.

- (C) Annual emergency and safety equipment training and checking should cover all requirements for each type.

(b) Helicopters

- (1) If a flight crew member operates more than one type or variant, the following provisions should be met:
 - (i) The recency requirements and the requirements for recurrent training and checking should be met and confirmed prior to CAT operations on any type, and the minimum number of flights on each type within a 3 months' period specified in the operations manual.
 - (ii) [ORO.FC.230](#) requirements with regard to recurrent training.
 - (iii) When credits related to the training, checking and recent experience requirements are defined in operational suitability data established in accordance with [Commission Regulation \(EU\) No 748/2012](#) for the relevant types or variants, the requirements of [ORO.FC.230](#) with regard to proficiency checks may be met by a 6 monthly check on any one type or variant operated. However, a proficiency check on each type or variant operated should be completed every 12 months.
 - (iv) If a helicopter has a maximum certified take-off mass (MCTOM) of more than 5 700 kg or a maximum operational passenger seating configuration (MOPSC) of more than 19:
 - (A) the flight crew member should not fly more than two helicopter types, unless credits related to the training, checking and recent experience requirements are defined in operational suitability data established in accordance with [Commission Regulation \(EU\) No 748/2012](#) for the relevant types or variants;
 - (B) a minimum of 3 months and 150 hours experience on the type should be achieved before the flight crew member should commence the conversion course onto the new type or variant, unless credits related to the training, checking and recent experience requirements are defined in the operational suitability data established in accordance with [Commission Regulation \(EU\) No 748/2012](#) for the relevant types or variants;
 - (C) 28 flying days or 50 hours experience should then be achieved exclusively on the new type or variant, unless credits related to the training, checking and recent experience requirements are defined in the operational suitability data established in accordance with [Commission Regulation \(EU\) No 748/2012](#) for the relevant types or variants; and
 - (D) a flight crew member should not be rostered to fly more than one type during a single duty period unless the following conditions are met:
 - There should be sufficient time off between the two types for a comprehensive training or self-training on the differences between the types. The time off should not include flight preparation duties.

- The training referred in the previous paragraph should include time in flight or in the cockpit or in a device representative of the cockpit of the next type to be flown.
 - The training syllabus should be based on a risk assessment of the operator and be described in the operations manual. The training should take place every time the pilot changes types, whether within the same duty period or not.
- (v) In the case of all other helicopters, the flight crew member should not operate more than three helicopter types or groups of types in CAT, NCC and SPO, unless credits related to the training, checking and recent experience requirements are defined in the operational suitability data established in accordance with [Commission Regulation \(EU\) No 748/2012](#) for the relevant types or variants.
- (vi) The operator should only define a group of types for the purpose of this AMC if the following conditions are met:
- (A) A group of helicopter types should either include only single-engined turbine helicopters operated only under VFR or it should include only single-engined piston helicopters operated only under VFR.
 - (B) The operator should define conditions for flying more than one type or variant on the same day, including sufficient time for a briefing or self-briefing on changing types or variants.
 - (C) The operator should define the maximum number of types and variants that can be flown on the same day.
- (vii) Points (v) and (vi) above apply whenever a flight crew member operates more than one type or variant in CAT.
- (c) Combination of helicopter and aeroplane
- (1) The flight crew member should only operate a combination of helicopters and aeroplanes if one of the following conditions is met:
- (i) operations under CAT, NCC and SPO should be limited to one type or class of aeroplane and one helicopter type; or
 - (ii) operations under CAT, NCC and SPO should be limited to one type or class of aeroplane and one group of helicopter types defined in (b)(vi) above; or
 - (iii) operations under CAT, NCC and SPO should be limited to only performance class B aeroplanes from the single-pilot classes of reciprocating engine aeroplanes and one helicopter type or group of helicopter types defined in (b)(vi) above.
- (2) If a helicopter type is covered by point (b)(1)(iv), then (b)(1)(iv)(B), (C) and (D) should also apply in this case.

ORO.FC.A.245 Alternative training and qualification programme

Regulation (EU) 2021/2237

- (a) The aeroplane operator having appropriate experience may substitute one or more of the following training and checking requirements for flight crew by an alternative training and qualification programme (ATQP), approved by the competent authority:
- (1) set out in point [SPA.LVO.120](#) on flight crew training and qualifications;

- (2) set out in point [ORO.FC.220](#) on conversion training and checking;
 - (3) set out in point [ORO.FC.125](#) on differences training, familiarisation, equipment and procedure training;
 - (4) set out in point [ORO.FC.205](#) on command course;
 - (5) set out in point [ORO.FC.230](#) on recurrent training and checking; and
 - (6) set out in point [ORO.FC.240](#) on operation on more than one type or variant.
- (b) The ATQP shall contain training and checking that establishes and maintains at least an equivalent level of proficiency achieved by complying with the provisions of [ORO.FC.220](#) and [ORO.FC.230](#). The level of flight crew training and qualification proficiency shall be demonstrated prior to being granted the ATQP approval by the competent authority.
- (c) The operator applying for an ATQP approval shall provide the competent authority with an implementation plan, including a description of the level of flight crew training and qualification proficiency to be achieved.
- (d) In addition to the checks required by points [ORO.FC.230](#) and FCL.060 of Annex I (Part-FCL) to [Regulation \(EU\) No 1178/2011](#), each flight crew member shall complete a line oriented evaluation (LOE) conducted in an FSTD. The validity period of an LOE shall be 12 calendar months. The LOE is completed when both of the following conditions are met:
- (1) the syllabus of the LOE is completed; and
 - (2) the flight crew member has demonstrated an acceptable level of performance.
- (e) After 2 years of operating with an approved ATQP, the operator may, with the approval of the competent authority, extend the validity periods of the checks referred to in point [ORO.FC.230](#) as follows:
- (1) Operator proficiency check to 12 calendar months.
 - (2) Line check to 24 calendar months.
 - (3) Emergency and safety equipment checking to 24 calendar months.
- (f) Each flight crew member shall undergo specific modular CRM training. All major topics of CRM training shall be covered by distributing modular training sessions as evenly as possible over each 3-year period.
- (g) The ATQP programme shall include 48 hours on an FSTD for each flight crew member, distributed evenly over a 3-year programme. The operator may reduce the number of FSTD hours, but no lower than 36 hours, provided that it demonstrates that the level of safety that is achieved is equivalent to that of the programme the ATQP may substitute in accordance with point (a).

AMC1 ORO.FC.A.245 Alternative training and qualification programme

ED Decision 2015/005/R

COMPONENTS AND IMPLEMENTATION

- (a) Alternative training and qualification programme (ATQP) components
- The ATQP should comprise the following:

- (1) Documentation that details the scope and requirements of the programme, including the following:
 - (i) The programme should demonstrate that the operator is able to improve the training and qualification standards of flight crew to a level that exceeds the standards prescribed in ORO.FC and Subpart E of Annex V (SPA.LVO).
 - (ii) The operator's training needs and established operational and training objectives.
 - (iii) A description of the process for designing and gaining approval for the operator's flight crew qualification programmes. This should include quantified operational and training objectives identified by the operator's internal monitoring programmes. External sources may also be used.
 - (iv) A description of how the programme will:
 - (A) enhance safety;
 - (B) improve training and qualification standards of flight crew;
 - (C) establish attainable training objectives;
 - (D) integrate CRM in all aspects of training;
[point (D) applicable until 25 March 2023 — ED Decision 2022/014/R]
(D) integrate CRM in all aspects of training and ensure that each flight crew member undergoes specific modular CRM training. All major topics of CRM training should be covered by distributing modular training sessions as evenly as possible over each 3-year period;
[point (D) applicable from 26 March 2023 — ED Decision 2022/014/R]
 - (E) develop a support and feedback process to form a self-correcting training system;
 - (F) institute a system of progressive evaluations of all training to enable consistent and uniform monitoring of the training undertaken by flight crew;
 - (G) enable the operator to be able to respond to new aeroplane technologies and changes in the operational environment;
 - (H) foster the use of innovative training methods and technology for flight crew instruction and the evaluation of training systems; and
 - (I) make efficient use of training resources, specifically to match the use of training media to the training needs.
- (2) A task analysis to determine:
 - (i) knowledge;
 - (ii) required skills;
 - (iii) associated skill-based training; and
 - (iv) validated behavioural markers, where appropriate.

For each aeroplane type/class to be included within the ATQP the operator should establish a systematic review that determines and defines the various tasks to be undertaken by the flight crew when operating that type/class. Data from other types/classes may also be used. The analysis should determine and describe the

knowledge and skills required to complete the various tasks specific to the aeroplane type/class and/or type of operation. In addition, the analysis should identify the appropriate behavioural markers that should be exhibited. The task analysis should be suitably validated in accordance with (b)(3). The task analysis, in conjunction with the data gathering programme(s), permits the operator to establish a programme of targeted training together with the associated training objectives.

- (3) Curricula. The curriculum structure and content should be determined by task analysis, and should include proficiency objectives, including when and how these objectives should be met.
 - (i) The training programme should have the following structure:
 - (A) Curriculum, specifying the following elements:
 - (a) Entry requirements: a list of topics and content, describing what training level will be required before start or continuation of training.
 - (b) Topics: a description of what will be trained during the lesson.
 - (c) Targets/Objectives
 - (1) Specific target or set of targets that have to be reached and fulfilled before the training course can be continued.
 - (2) Each specified target should have an associated objective that is identifiable both by the flight crew and the trainers.
 - (3) Each qualification event that is required by the programme should specify the training that is required to be undertaken and the required standard to be achieved.
 - (B) Daily lesson plan
 - (a) Each lesson/course/training or qualification event should have the same basic structure. The topics related to the lesson should be listed and the lesson targets should be unambiguous.
 - (b) Each lesson/course or training event whether classroom, CBT or simulator should specify the required topics with the relevant targets to be achieved.
 - (4) A specific training programme for:
 - (i) each aeroplane type/class within the ATQP;
 - (ii) instructors (class rating instructor rating/synthetic flight instructor authorisation/type rating instructor rating — CRI/SFI/TRI), and other personnel undertaking flight crew instruction; and
 - (iii) examiners (class rating examiner/synthetic flight examiner/type rating examiner — CRE/SFE/TRE).

This should include a method for the standardisation of instructors and examiners.

Personnel who perform training and checking of flight crew in an operator's ATQP should receive the following additional training on:

- (A) ATQP principles and goals;
- (B) knowledge/skills/behaviour as learnt from task analysis;

- (C) line-oriented evaluation (LOE)/ LOFT scenarios to include triggers/markers/event sets/observable behaviour;
- (D) qualification standards;
- (E) harmonisation of assessment standards;
- (F) behavioural markers and the systemic assessment of CRM;
- (G) event sets and the corresponding desired knowledge/skills and behaviour of the flight crew;
- (H) the processes that the operator has implemented to validate the training and qualification standards and the instructors part in the ATQP quality control; and
- (I) line-oriented quality evaluation (LOQE).

[points (A)-(I) applicable until 25 March 2023 — ED Decision 2022/014/R]

- (A) ATQP principles and goals;
- (B) knowledge/skills/behavioural markers as learnt from task analysis;
- (C) line-oriented evaluation (LOE)/LOFT scenarios to include triggers/behavioural markers/event sets/observable behaviour;
- (D) qualification standards;
- (E) harmonisation of assessment standards;
- (F) behavioural markers and the systemic assessment of CRM;
- (G) event sets and the corresponding desired knowledge/skills and behavioural markers of the flight crew;
- (H) the processes that the operator has implemented to validate the training and qualification standards and the instructors part in the ATQP quality control; and
- (I) line-oriented quality evaluation (LOQE).

[points (A)-(I) applicable from 26 March 2023 — ED Decision 2022/014/R]

- (5) A feedback loop for the purpose of curriculum validation and refinement, and to ascertain that the programme meets its proficiency objectives.
 - (i) The feedback should be used as a tool to validate that the curricula are implemented as specified by the ATQP; this enables substantiation of the curriculum, and that proficiency and training objectives have been met. The feedback loop should include data from operations flight data monitoring, the advanced flight data monitoring (FDM) programme and LOE/LOQE programmes. In addition, the evaluation process should describe whether the overall targets/objectives of training are being achieved and should prescribe any corrective action that needs to be undertaken.
 - (ii) The programme's established quality control mechanisms should at least review the following:
 - (A) procedures for approval of recurrent training;
 - (B) ATQP instructor training approvals;

- (C) approval of event set(s) for LOE/LOFT;
 - (D) procedures for conducting LOE and LOQE.
- (6) A method for the assessment of flight crew during conversion and recurrent training and checking. The assessment process should include event-based assessment as part of the LOE. The assessment method should comply with [ORO.FC.230](#).
- (i) The qualification and checking programmes should include at least the following elements:
 - (A) a specified structure;
 - (B) elements to be tested/examined;
 - (C) targets and/or standards to be attained;
 - (D) the specified technical and procedural knowledge and skills, and behavioural markers to be exhibited.
 - (ii) An LOE event should comprise tasks and sub-tasks performed by the crew under a specified set of conditions. Each event has one or more specific training targets/objectives, which require the performance of a specific manoeuvre, the application of procedures, or the opportunity to practise cognitive, communication or other complex skills. For each event the proficiency that is required to be achieved should be established. Each event should include a range of circumstances under which the crews' performance is to be measured and evaluated. The conditions pertaining to each event should also be established and they may include the prevailing meteorological conditions (ceiling, visibility, wind, turbulence, etc.), the operational environment (navigation aid inoperable, etc.), and the operational contingencies (non-normal operation, etc.).
 - (iii) The markers specified under the operator's ATQP should form one of the core elements in determining the required qualification standard. A typical set of markers is shown in the table below:

EVENT	MARKER
Awareness of aeroplane systems:	1. Monitors and reports changes in automation status
	2. Applies closed loop principle in all relevant situations
	3. Uses all channels for updates
	4. Is aware of remaining technical resources

- (iv) The topics/targets integrated into the curriculum should be measurable and progression on any training/course is only allowed if the targets are fulfilled.
- (v) The assessment and the subsequent grading of the performance of flight crew members should include the following steps:
 - (A) Observe performance (behaviours) during the simulator session.
 - (B) Record details of effective and ineffective performance (behaviours) observed during the simulator session ('record' in this context refers to instructors taking notes).
 - (C) Classify observations against the set of behavioural markers and allocate the behavioural markers to each type of knowledge or skill or task, using amongst others the facilitation technique. If the operator has developed a

set of competencies, it may allocate the behavioural markers to each competency.

- (D) Assess and evaluate (grade): assess the performance by determining the root cause(s). Low performance would normally indicate the area of performance to be remediated in subsequent phases or modules or training sessions. Evaluate (grade) the performance by determining a grade using the methodology defined by the operator.

[point (v) applicable from 26 March 2023 — ED Decision 2022/014/R]

- (7) A data monitoring/analysis programme consisting of the following:
- (i) A flight data monitoring (FDM) programme, as described in [AMC1 ORO.AOC.130](#). Data collection should reach a minimum of 60 % of all relevant flights conducted by the operator before ATQP approval is granted. This proportion may be increased as determined by the competent authority.
 - (ii) An advanced FDM when an extension to the ATQP is requested: an advanced FDM programme is determined by the level of integration with other safety initiatives implemented by the operator, such as the operator's safety management system. The programme should include both systematic evaluations of data from an FDM programme and flight crew training events for the relevant crews. Data collection should reach a minimum of 80 % of all relevant flights and training conducted by the operator. This proportion may be varied as determined by the competent authority.

The purpose of an FDM or advanced FDM programme for ATQP is to enable the operator to:

 - (A) provide data to support the programme's implementation and justify any changes to the ATQP;
 - (B) establish operational and training objectives based upon an analysis of the operational environment; and
 - (C) monitor the effectiveness of flight crew training and qualification.
 - (iii) Data gathering: the data analysis should be made available to the person responsible for ATQP within the organisation. The data gathered should:
 - (A) include all fleets that are planned to be operated under the ATQP;
 - (B) include all crews trained and qualified under the ATQP;
 - (C) be established during the implementation phase of ATQP; and
 - (D) continue throughout the life of the ATQP.
 - (iv) Data handling: the operator should establish a procedure to ensure the confidentiality of individual flight crew members, as described by [AMC1 ORO.AOC.130](#).
 - (v) The operator that has a flight data monitoring programme prior to the proposed introduction of ATQP may use relevant data from other fleets not part of the proposed ATQP.

(b) Implementation. The operator should develop an evaluation and implementation process, including the following stages:

(1) A safety case that demonstrates equivalency of:

- (i) the revised training and qualification standards compared to the standards of ORO.FC and/or Subpart E of Annex V (SPA.LVO) prior to the introduction of ATQP; and
- (ii) any new training methods implemented as part of ATQP.

The safety case should encompass each phase of implementation of the programme and be applicable over the lifetime of the programme that is to be overseen. The safety case should:

- demonstrate the required level of safety;
- ensure the required safety is maintained throughout the lifetime of the programme; and
- minimise risk during all phases of the programme's implementation and operation.

The elements of a safety case include:

- planning: integrated and planned with the operation (ATQP) that is to be justified;
- criteria;
- safety-related documentation, including a safety checklist;
- programme of implementation to include controls and validity checks; and
- oversight, including review and audits.

Criteria for the establishment of a safety case. The safety case should:

- be able to demonstrate that the required or equivalent level of safety is maintained throughout all phases of the programme;
- be valid to the application and the proposed operation;
- be adequately safe and ensure the required regulatory safety standards or approved equivalent safety standards are achieved;
- be applicable over the entire lifetime of the programme;
- demonstrate completeness and credibility of the programme;
- be fully documented;
- ensure integrity of the operation and the maintenance of the operations and training infrastructure;
- ensure robustness to system change;
- address the impact of technological advance, obsolescence and change; and
- address the impact of regulatory change.

(2) A task analysis, as required by (a)(2), to establish the operator's programme of targeted training and the associated training objectives.

- (3) A period of operation whilst data is collected and analysed to validate the safety case and task analysis. During this period the operator should continue to operate in accordance with ORO.FC and/or Subpart E of Annex V (SPA.LVO), as applicable. The length of this period should be determined by the competent authority.

GM1 ORO.FC.A.245 Alternative training and qualification programme

ED Decision 2014/017/R

TERMINOLOGY

- (a) 'Line-oriented evaluation (LOE)' is an evaluation methodology used in the ATQP to evaluate trainee performance, and to validate trainee proficiency. LOEs consist of flight simulator scenarios that are developed by the operator in accordance with a methodology approved as part of the ATQP. The LOE should be realistic and include appropriate weather scenarios and, in addition, should fall within an acceptable range of difficulty. The LOE should include the use of validated event sets to provide the basis for event-based assessment.
- (b) 'Line-oriented quality evaluation (LOQE)' is one of the tools used to help evaluate the overall performance of an operation. LOQEs consist of line flights that are observed by appropriately qualified operator personnel to provide feedback to validate the ATQP. The LOQE should be designed to look at those elements of the operation that are unable to be monitored by FDM or Advanced FDM programmes.
- (c) 'Skill-based training' requires the identification of specific knowledge and skills. The required knowledge and skills are identified within an ATQP as part of a task analysis and are used to provide targeted training.
- (d) 'Event-based assessment' is the assessment of flight crew to provide assurance that the required knowledge and skills have been acquired. This is achieved within an LOE. Feedback to the flight crew is an integral part of event-based assessment.
- (e) Safety case means a documented body of evidence that provides a demonstrable and valid justification that the ATQP is adequately safe for the given type of operation.

GM2 ORO.FC.A.245 Alternative training and qualification programme

ED Decision 2015/027/R

EVIDENCE-BASED RECURRENT TRAINING AND CHECKING OF FLIGHT CREW CONDUCTED IN FLIGHT SIMULATION TRAINING DEVICES (FSTDs)

It is possible to implement EBT in accordance with ICAO Doc 9995 in the framework of an approved alternative training and qualification programme (ATQP). [GM1 ORO.FC.230\(a\);\(b\);\(f\)](#) may be used to guide the operator towards EBT according to [ORO.FC.A.245](#) of Commission Regulation (EU) No 965/2012.

An operator holding approval for ATQP and wishing to implement EBT may use the guidance material in [GM1 ORO.FC.230\(a\);\(b\);\(f\)](#) for the conduct of the Licence Proficiency Check, or where the Licence Proficiency Check and Operator Proficiency Check are combined. For this purpose, the evaluation phase is equivalent to the line-oriented evaluation (LOE) described in [ORO.FC.A.245\(d\)](#).

GM3 ORO.FC.A.245 Alternative training and qualification programme

ED Decision 2022/014/R

BEHAVIOURAL MARKERS AND OBSERVABLE BEHAVIOURS — ATQP & EBT

- (b) Behavioural markers in ATQP are observable behaviours that contribute to superior or substandard performance within a flight (including pre-flight and post-flight duties).
- (c) A good behavioural marker:
 - (1) describes a specific, observable behaviour, not an attitude or personality trait, with clear definition (enactment of skills or knowledge is shown in behaviour);
 - (2) has demonstrated a causal relationship to performance outcome, without necessarily being present in all situations, and with its appropriateness possibly depending on context;
 - (3) uses simple phraseology; and
 - (4) describes a clear concept.
- (d) The characteristics of good behavioural marker systems are:
 - (1) validity: in relation to performance outcome;
 - (2) reliability: instructor or examiner concordance (inter-rater reliability), internal consistency;
 - (3) sensitivity: in relation to levels of performance;
 - (4) transparency: the pilots receiving the training or checking understand the performance criteria against which they are being rated; availability of reliability and validity data;
 - (5) usability: easy to train, simple framework, easy to understand, domain-appropriate language, sensitive to rater (i.e. examiner, instructor) workload, easy to observe;
 - (6) ability to provide a focus for training goals and needs; and
 - (7) minimal overlap between components.
- (e) For EBT mixed implementation, the operator may refer to the Annex I definitions of 'behaviour' and 'observable behaviour' which include the concept of behavioural marker in ATQP. In other words, the EBT OBs may be used as behavioural markers under ATQP.

AMC1 ORO.FC.A.245(a) Alternative training and qualification programme

ED Decision 2014/017/R

OPERATOR EXPERIENCE

The appropriate experience should be at least 2 years' continuous operation.

AMC1 ORO.FC.A.245(d)(e)(2) Alternative training and qualification programme

ED Decision 2014/017/R

COMBINATION OF CHECKS

- (a) The line-orientated evaluation (LOE) may be undertaken with other ATQP training.
- (b) The line check may be combined with a line-oriented quality evaluation (LOQE).

[applicable until 25 March 2023 — ED Decision 2022/014/R]

AMC1 ORO.FC.A.245(d);(e)(2) Alternative training and qualification programme

ED Decision 2022/014/R

COMBINATION OF CHECKS

- (a) The LOE may be undertaken with other ATQP training. The operator should ensure that training and checking are clearly distinguished and described in the operations manual.
- (b) The line check may be combined with a line-oriented quality evaluation (LOQE).
- (c) Complementary CRM assessment

The CRM assessment should take place in a line-oriented flight scenario (LOFT, LOE or line-oriented section of the OPC) of an FSTD session. This assessment complements the CRM assessment taking place during the line check /LOQE, but it is not part of the line check / LOQE.

[applicable from 26 March 2023]

GM1 ORO.FC.A.245(e)(2) Alternative training and qualification programme

ED Decision 2022/014/R

LINE CHECK IN MIXED FLEET OPERATION UNDER ATQP

The extension of validity for the line check is intended for single fleet operation. For mixed fleet operation, the operator needs to observe the provisions in the operational suitability data established in accordance with [Commission Regulation \(EU\) No 748/2012](#). Usually the operational suitability data refers to one line check per year in alternate aircraft types.

AMC1 ORO.FC.A.245(g) Alternative training and qualification programme

ED Decision 2022/014/R

ATQP PROGRAMME — FSTD

The FSTD qualification level should be adequate to complete proficiency checks; therefore, the ATQP programme should be conducted in a full-flight simulator (FFS) level C or D.

ORO.FC.A.250 Commanders holding a CPL(A)

Regulation (EU) 2017/363

- (a) The holder of a CPL(A) (aeroplane) shall only act as commander in commercial air transport on a single-pilot aeroplane if either of the following conditions is met:
- (1) when carrying passengers under VFR outside a radius of 50 NM (90 km) from an aerodrome of departure, he/she has a minimum of 500 hours of flight time on aeroplanes or holds a valid instrument rating; or
 - (2) when operating on a multi-engine type under IFR, he/she has a minimum of 700 hours of flight time on aeroplanes, including 400 hours as pilot-in-command. These hours shall include 100 hours under IFR and 40 hours in multi-engine operations. The 400 hours as pilot-in-command may be substituted by hours operating as co-pilot within an established multi-pilot crew system prescribed in the operations manual, on the basis of two hours of flight time as co-pilot for one hour of flight time as pilot-in command;
 - (3) when operating on a single-engined aeroplane under IFR, he/she has a minimum of 700 hours of flight time on aeroplanes, including 400 hours as pilot-in-command. Those hours shall include 100 hours under IFR. The 400 hours as pilot-in-command may be substituted by hours operating as co-pilot within an established multi-pilot crew system prescribed in the operations manual, on the basis of two hours of flight time as co-pilot for one hour of flight time as pilot-in command.
- (b) For operations under VFR by day of performance class B aeroplanes (a)(1) shall not apply.

ORO.FC.H.250 Commanders holding a CPL(H)

Regulation (EU) 2021/2237

- (a) Holders of a CPL(H) (helicopter) shall only act as commanders in CAT operations on a single-pilot helicopter if:
- (1) when operating under IFR, they have a minimum of 700 hours total flight time on helicopters, including 300 hours as pilot-in-command. The total flight time on helicopters shall include 100 hours under IFR. Up to 50 hours instrument time performed on an FFS(H) level B or FTD level 3 qualification or higher qualified for instrument training, may be credited towards the 100 hours. The 300 hours as pilot-in-command may be substituted by hours operating as co-pilot within an established multi-pilot crew system prescribed in the operations manual on the basis of 2 hours of flight time as co-pilot for 1 hour flight time as pilot-in command;
 - (2) when operating under visual meteorological conditions (VMC) at night, he/she has:
 - (i) a valid instrument rating; or
 - (ii) 300 hours of flight time on helicopters, including 100 hours as pilot-in-command and 10 hours as pilot flying at night.

SECTION 3 – ADDITIONAL REQUIREMENTS FOR COMMERCIAL SPECIALISED OPERATIONS AND CAT OPERATIONS REFERRED TO IN ORO.FC.005(B)(1) AND (2)

ORO.FC.320 Operator conversion training and checking

Regulation (EU) 2021/2237

The operator conversion course shall include an operator proficiency check.

AMC1 ORO.FC.320 Operator conversion training and checking

ED Decision 2022/014/R

OPERATOR PROFICIENCY CHECK

The operator proficiency check should take place at the end of the operator conversion training programme defined in [AMC3 ORO.FC.120](#).

[applicable from 26 March 2023]

ORO.FC.325 Equipment and procedure training and checking

Regulation (EU) 2021/2237

If a flight crew member undergoes equipment and procedure training that requires training on a suitable FSTD or the aircraft, with regard to standard operating procedures related to a specialised operation, the flight crew member shall undergo an operator proficiency check.

AMC1 ORO.FC.325 Equipment and procedure training and checking

ED Decision 2022/014/R

SPECIALISED OPERATIONS

- (a) If the equipment and procedure training includes training for SOPs related to a specialised operation, points (b) to (f) of [AMC3 ORO.FC.120](#) should apply.
- (b) The operator proficiency check should take place at the end of the aircraft/FSTD training programme defined in [AMC3 ORO.FC.120](#).

[applicable from 26 March 2023]

ORO.FC.330 Recurrent training and checking — operator proficiency check

Regulation (EU) 2021/2237

- (a) Each flight crew member shall complete recurrent training and operator proficiency checks. In the case of specialised operations, the recurrent training and checking shall cover the relevant aspects associated with the specialised tasks described in the operations manual.
- (b) Appropriate consideration shall be given when operations are undertaken under IFR or at night.
- (c) The validity period of the operator proficiency check shall be 12 calendar months.

AMC1 ORO.FC.330 Recurrent training and checking — operator proficiency check

ED Decision 2022/014/R

SPO — RECURRENT TRAINING

- (a) The training should include:
- (1) ground training, including all the following:
 - (i) aircraft systems;
 - (ii) normal procedures, which include flight planning and ground-handling and flight operations, including performance, mass and balance, fuel schemes selection of alternates, and ground de-icing/anti-icing;
 - (iii) abnormal and emergency procedures, which include pilot incapacitation as applicable;
 - (iv) a review of relevant samples of accident/incident and occurrences to increase awareness of the occurrences that may be relevant for the intended operation;
 - (2) emergency and safety equipment training if one or more task specialists are on board. The training should ensure that all emergency equipment can be used timely and efficiently, that an emergency evacuation and first aid can be conducted, taking into account the training and operating procedures of the task specialist(s); and
 - (3) aircraft/FSTD training relevant to the type or variant of aircraft on which the flight crew operates.
- (b) Additional training relevant to the specialised tasks should be either ground training or aircraft/FSTD training or both, in accordance with the results of the operator's risk assessment.

SPO — OPERATOR PROFICIENCY CHECK

- (c) The SPO operator proficiency check should take place at least annually. If the SPO operator combines the operator proficiency check with a licence proficiency check, the check should cover both the normal, abnormal and emergency procedures relevant to the type or variant and the relevant aspects associated with the specialised tasks described in the operations manual.
- (d) If the SPO operator does not combine the operator proficiency check with a licence proficiency check, the operator proficiency check may not include the normal, abnormal and emergency procedures relevant to the type or variant that are already covered within the licence proficiency check. The operator proficiency check then covers the relevant aspects associated with the specialised task described in the operations manual.
- (e) The flight crew should be assessed on their CRM skills in accordance with the methodology described in [AMC1](#) and [AMC2 ORO.FC.115](#) and as specified in the operations manual. CRM assessment should not be used as a reason for a failure of the operator proficiency check unless the observed behaviour could lead to an unacceptable reduction in safety margin.
- (f) Each flight crew member should complete the operator proficiency checks as part of the normal crew complement.

SPO — RELEVANT PROCEDURES TO BE TRAINED AND CHECKED

- (g) The operator should determine, based on a risk assessment, which procedures associated with the specialised tasks are relevant to be trained and checked. The following should be taken into account:

- (1) specific risks associated with the specialised operation;
 - (2) for abnormal and emergency procedures, the criticality of the situation or failure and the impact of training and checking on ensuring a positive outcome; and
 - (3) for normal procedures, the amount of experience and recent experience accumulated since the previous training or checking.
- (h) The operator should establish a training and checking programme to ensure that normal, abnormal and emergency procedures covering the relevant aspects associated with the specialised tasks are:
- (1) trained and checked over a 2-year cycle for SPO operators engaged in only one specialised operation;
 - (2) trained and checked over a 2-year cycle for pilots engaged in only one specialised operation;
 - (3) trained and checked over a 3-year cycle, if neither (1) nor (2) applies;
 - (4) trained and checked before a pilot with no recent experience of the specialised operation in the last 6 months resumes the specialised operation.
 - (i) Whenever an item requires both training and checking, the recurrent aircraft/FSTD training of a single task or manoeuvre should be separate from, and should not take place at the same time as, an operator proficiency check of the item.
 - (j) Specialised operations may be exposed to specific risks such as routinely flying within the height velocity envelope of a helicopter. The operator should avoid taking unnecessary risks during aircraft training and checking and should take advantage of simulation devices, if possible, to train for such situations.

COMBINED CAT AND SPO TRAINING AND CHECKING

- (k) If the operator is involved in both CAT and SPO, the CAT training and checking programme may include elements that are relevant to the specialised tasks. If this is the case, these training and checking elements may be credited towards compliance with [ORO.FC.330](#) as approved by the authority under [ORO.FC.145\(c\)](#).

[applicable from 26 March 2023]

GM1 ORO.FC.330 Recurrent training and checking — operator proficiency check

ED Decision 2022/014/R

SPO — RELEVANT PROCEDURES TO BE TRAINED AND CHECKED

The procedures to be trained in the aircraft/FSTD may be different from the procedures to be checked if both complement each other, as defined by the operator in [AMC1 ORO.FC.330](#), considering the following:

- (a) It may happen that several training elements are covered by a single check; and
- (b) Certain complex procedures are best explored under recurrent training, where the trainee will derive more benefit and training to proficiency is also employed.

[applicable from 26 March 2023]

SUBPART CC: CABIN CREW

ORO.CC.005 Scope

Regulation (EU) No 800/2013

This Subpart establishes the requirements to be met by the operator when operating an aircraft with cabin crew and comprises:

- (a) Section 1 specifying common requirements applicable to all operations; and
- (b) Section 2 specifying additional requirements only applicable to commercial air transport operations.

SECTION 1 – COMMON REQUIREMENTS

ORO.CC.100 Number and composition of cabin crew

Regulation (EU) 2019/1384

- (a) For the operation of aircraft with an MOPSC of more than 19, at least one cabin crew member shall be assigned when carrying one or more passenger(s).
- (b) For the purpose of complying with point (a), the minimum number of cabin crew members shall be the greatest number amongst the following:
 - (1) the number of cabin crew members established during the aircraft certification process in accordance with the applicable certification specifications, for the aircraft cabin configuration used by the operator;
 - (2) if the number under point (1) has not been established, the number of cabin crew members established during the aircraft certification process for the maximum certified passenger seating configuration reduced by 1 for every whole multiple of 50 passenger seats of the aircraft cabin configuration used by the operator falling below the maximum certified seating capacity;
 - (3) one cabin crew member for every 50, or fraction of 50, passenger seats installed on the same deck of the aircraft to be operated.
- (c) For operations with more than one cabin crew member, the operator shall nominate one cabin crew member accountable to the pilot-in-command or the commander.
- (d) By way of derogation from point (a), non-commercial operations with aircraft with an MOPSC of more than 19 may be performed without an operating cabin crew member, subject to the prior approval by the competent authority. To obtain the approval, the operator shall ensure that all of the following conditions are fulfilled:
 - (1) there are maximum 19 passengers on board;
 - (2) the operator has developed procedures for that operation.

AMC1 ORO.CC.100 Number and composition of cabin crew

ED Decision 2014/017/R

DETERMINATION OF THE NUMBER AND COMPOSITION OF CABIN CREW

- (a) When determining the minimum number of cabin crew required to operate aircraft engaged in CAT operations, factors to be taken into account should include:
- (1) the number of doors/exits;
 - (2) the type(s) of doors/exits and the associated assisting evacuation means;
 - (3) the location of doors/exits in relation to cabin crew stations and the cabin layout;
 - (4) the location of cabin crew stations taking into account direct view requirements and cabin crew duties in an emergency evacuation including:
 - (i) opening floor level doors/exits and initiating stair or slide deployment;
 - (ii) assisting passengers to pass through doors/exits; and
 - (iii) directing passengers away from inoperative doors/exits, crowd control and passenger flow management;
 - (5) actions required to be performed by cabin crew in ditching, including the deployment of slide-rafts and the launching of life-rafts;
 - (6) additional actions required to be performed by cabin crew members when responsible for a pair of doors/exits; and
 - (7) the type and duration of the flight to be operated.
- (b) When scheduling cabin crew for a flight, the operator should establish procedures that take account of the experience of each cabin crew member. The procedures should specify that the required cabin crew includes some cabin crew members who have at least 3 months experience as an operating cabin crew member.

GM1 ORO.CC.100 Number and composition of cabin crew

ED Decision 2019/019/R

MINIMUM NUMBER OF CABIN CREW

- (a) When determining the minimum required cabin crew for its specific aircraft cabin configuration, the operator should:
- (1) request information regarding the minimum number of cabin crew established by the aircraft type certificate (TC) holder or other design organisation responsible for showing compliance with the evacuation requirements of the applicable Certification Specifications; and
 - (2) take into account the factors specified in [AMC1 ORO.CC.100](#), as applicable.
- (b) The number of cabin crew referred to in [ORO.CC.100\(b\)\(1\)](#) means either:
- (1) the number of cabin crew who actively participated in the aircraft cabin during the relevant emergency evacuation demonstration, or who were assumed to have taken part in the relevant analysis, carried out by the aircraft TC holder when demonstrating the maximum passenger seating capacity (MPSC) of the aircraft type at the time of initial type certification; or

- (2) a lower number of cabin crew who actively participated in a subsequent emergency evacuation demonstration, or who were assumed to have taken part in the relevant analysis, and for which approval has been obtained for a cabin configuration other than the MPSC, either by the TC holder or by another design organisation. The operator should obtain a clear indication of that number which is specified in the related documentation.

AMC1 ORO.CC.100(d)(2) Number and composition of cabin crew

ED Decision 2019/019/R

PROCEDURES FOR NON-COMMERCIAL OPERATIONS WITH NO OPERATING CABIN CREW ON BOARD AN AIRCRAFT WITH AN MOPSC OF MORE THAN 19 AND MAXIMUM 19 PASSENGERS

The operator should assess the risk of operating a flight with no cabin crew member and ensure that the following procedures mitigate the risks and provide appropriate level of protection of the aircraft occupants:

- (a) Flight crew members assigned to these flights should receive training on operations where no cabin crew is required in accordance with [ORO.FC.220](#) and [ORO.FC.230](#).
- (b) The operator should consider the categories of passengers to be carried on such flights, who may be knowledgeable or not about the aircraft type and procedures in normal, abnormal and emergency situations.
- (c) The procedures should cover at least the following elements, if applicable:
 - (1) communication and coordination between flight crew members and passengers;
 - (2) flight crew member incapacitation;
 - (3) cabin surveillance;
 - (4) rapid egress from the aircraft in case of rapid disembarkation or evacuation;
 - (5) operation and use of emergency exits and assisting evacuation means;
 - (6) location and use of oxygen;
 - (7) location and use of life jackets;
 - (8) passenger seating in order to maintain:
 - (i) an easy access to emergency exits;
 - (ii) timely communication with flight crew member(s); and
 - (iii) the required mass and balance of the aircraft;
 - (9) passenger briefing in accordance with Annex IV (Part-CAT), including information on the location and use of equipment not displayed in the operator's safety briefing material, such as a fire extinguisher, first-aid equipment (e.g. first-aid kit, defibrillator), smoke hood, etc.; and
 - (10) any additional safety instructions that are deemed necessary to ensure passenger protection.

GM1 ORO.CC.100(d)(2) Number and composition of cabin crew

ED Decision 2019/019/R

CATEGORIES OF PASSENGERS

- (a) The operator should adapt the procedures for non-commercial operations with an aircraft with an MOPSC of more than 19 and maximum 19 passengers and no operating cabin crew on board to the categories of passengers to be carried on such flight. This includes but is not limited to the following groups:
- (1) Passengers who are already familiar with the aircraft environment, the procedures in normal operations, abnormal and emergency situations or trained on the aircraft type, e.g. non-operating aircrew members, maintenance personnel, etc.
 - (2) Passengers who are not familiar with the aircraft environment or procedures in normal operations, abnormal and emergency situations, e.g. operator's guests, employees, etc.
 - (3) Passengers who travel frequently on such flights. The operator may consider providing these passengers with training covering all safety and emergency procedures for the given aircraft type as described in [AMC1.1 CAT.OP.MPA.170](#). The operator should be able to show evidence of their training. These passengers may also be provided with an extended briefing to facilitate communication with flight crew and coordination of all passengers in case of an abnormal or emergency situation.
 - (4) Special categories of passengers (see [CAT.OP.MPA.155](#)).
- (b) The operator may include in its procedures a ratio of the categories of passengers described in (a) above that can travel on the same flight.

ORO.CC.110 Conditions for assignment to duties

Regulation (EU) No 965/2012

- (a) Cabin crew members shall only be assigned to duties on an aircraft if they:
- (1) are at least 18 years of age;
 - (2) have been assessed, in accordance with the applicable requirements of Annex IV (Part-MED) to Regulation (EU) No 1178/2011, as physically and mentally fit to perform their duties and discharge their responsibilities safely; and
 - (3) have successfully completed all applicable training and checking required by this Subpart and are competent to perform the assigned duties in accordance with the procedures specified in the operations manual.
- (b) Before assigning to duties cabin crew members who are working on a freelance or part-time basis, the operator shall verify that all applicable requirements of this Subpart are complied with, taking into account all services rendered by the cabin crew member to any other operator(s), to determine in particular:
- (1) the total number of aircraft types and variants operated; and
 - (2) the applicable flight and duty time limitations and rest requirements.
- (c) Operating cabin crew members, as well as their role with regard to the safety of passengers and flight, shall be clearly identified to the passengers.

ORO.CC.115 Conduct of training courses and associated checking

Regulation (EU) No 965/2012

- (a) A detailed programme and syllabus shall be established by the operator for each training course in accordance with the applicable requirements of this Subpart, and of Annex V (Part-CC) to Regulation (EU) No 1178/2011 where applicable, to cover the duties and responsibilities to be discharged by the cabin crew members.
- (b) Each training course shall include theoretical and practical instruction together with individual or collective practice, as relevant to each training subject, in order that the cabin crew member achieves and maintains the adequate level of proficiency in accordance with this Subpart.
- (c) Each training course shall be:
 - (1) conducted in a structured and realistic manner; and
 - (2) performed by personnel appropriately qualified for the subject to be covered.
- (d) During or following completion of all training required by this Subpart, each cabin crew member shall undergo a check covering all training elements of the relevant training programme, except for crew resource management (CRM) training. Checks shall be performed by personnel appropriately qualified to verify that the cabin crew member has achieved and/or maintains the required level of proficiency.
- (e) CRM training courses and CRM modules where applicable shall be conducted by a cabin crew CRM instructor. When CRM elements are integrated in other training, a cabin crew CRM instructor shall manage the definition and implementation of the syllabus.

GM1 ORO.CC.115 Conduct of training courses and associated checking

ED Decision 2014/017/R

EQUIPMENT AND PROCEDURES

The following definitions apply for the purpose of training programmes, syllabi and the conduct of training and checking on equipment and procedures:

- (a) 'Safety equipment' means equipment installed/carried to be used during day-to-day normal operations for the safe conduct of the flight and protection of occupants (e.g. seat belts, child restraint devices, safety card, safety demonstration kit).
- (b) 'Emergency equipment' means equipment installed/carried to be used in case of abnormal and emergency situations that demand immediate action for the safe conduct of the flight and protection of occupants, including life preservation (e.g. drop-out oxygen, crash axe, fire extinguisher, protective breathing equipment, manual release tool, slide-raft).
- (c) 'Normal procedures' means all procedures established by the operator in the operations manual for day-to-day normal operations (e.g. pre-flight briefing of cabin crew, pre-flight checks, passenger briefing, securing of galleys and cabin, cabin surveillance during flight).
- (d) 'Emergency procedures' means all procedures established by the operator in the operations manual for abnormal and emergency situations. For this purpose, 'abnormal' refers to a situation that is not typical or usual, deviates from normal operation and may result in an emergency.

AMC1 ORO.CC.115(c) Conduct of training courses and associated checking

ED Decision 2014/017/R

TRAINING METHODS AND TRAINING DEVICES

- (a) The operator should establish training methods that take into account the following:
- (1) training should include the use of cabin training devices, audio-visual presentations, computer-based training and other types of training, as most appropriate to the training element; and
 - (2) a reasonable balance between the different training methods should be ensured so that the cabin crew member achieves the level of proficiency necessary for a safe performance of all related cabin crew duties and responsibilities.
- (b) When assessing the representative training devices to be used, the operator should:
- (1) take into account that a representative training device may be used to train cabin crew as an alternative to the use of the actual aircraft or required equipment;
 - (2) ensure that those items relevant to the training and checking intended to be given accurately represent the aircraft or equipment in the following particulars:
 - (i) layout of the cabin in relation to doors/exits, galley areas and safety and emergency equipment stowage as relevant;
 - (ii) type and location of passenger seats and cabin crew stations;
 - (iii) doors/exits in all modes of operation, particularly in relation to the method of operation, mass and balance and operating forces, including failure of power-assist systems where fitted; and
 - (iv) safety and emergency equipment of the type provided in the aircraft (such equipment may be 'training use only' items and, for oxygen and protective breathing equipment, units charged with or without oxygen may be used); and
 - (3) assess the following factors when determining whether a door/exit can be considered to be a variant of another type:
 - (i) door/exit arming/disarming;
 - (ii) direction of movement of the operating handle;
 - (iii) direction of door/exit opening;
 - (iv) power-assist mechanisms; and
 - (v) assisting evacuation means such as slides and ropes.

AMC1 ORO.CC.115(d) Conduct of training courses and associated checking

ED Decision 2014/017/R

CHECKING

- (a) Checking required for each training course should be accomplished by the method appropriate to the training element to be checked. These methods include:
- (1) practical demonstration;

- (2) computer-based assessment;
 - (3) in-flight checks;
 - (4) oral or written tests.
- (b) Training elements that require individual practical participation may be combined with practical checks.

AMC1 ORO.CC.115(e) Conduct of training courses and associated checking

ED Decision 2015/022/R

RESOURCE MANAGEMENT (CRM) TRAINING – MULTI CABIN CREW OPERATIONS

- (a) General
- (1) Training environment

CRM training should be conducted in the non-operational environment (classroom and computer-based) and in the operational environment (cabin training device and aircraft). Tools such as group discussions, team task analysis, team task simulation and feedback should be used.
 - (2) Classroom training

Whenever possible, classroom training should be conducted in a group session away from the pressures of the usual working environment, so that the opportunity is provided for cabin crew members to interact and communicate in an environment conducive to learning.
 - (3) Computer-based training

Computer-based training should not be conducted as a stand-alone training method, but may be conducted as a complementary training method.
 - (4) Cabin training devices and aircraft

Whenever practicable, relevant parts of CRM training should be conducted in representative cabin training devices that reproduce a realistic operational environment, or in the aircraft. During practical training, interaction should be encouraged.
 - (5) Integration into cabin crew training

CRM principles should be integrated into relevant parts of cabin crew training and operations, including checklists, briefings and emergency procedures.
 - (6) Combined CRM training for flight crew and cabin crew
 - (i) Operators should provide combined training for flight crew and cabin crew during recurrent CRM training.
 - (ii) The combined training should address at least:
 - (A) effective communication, coordination of tasks and functions of flight crew and cabin crew; and
 - (B) mixed multinational and cross-cultural flight crew and cabin crew, and their interaction, if applicable.

- (iii) Combined CRM training should be conducted by flight crew CRM trainer or cabin crew CRM trainer.
 - (iv) There should be an effective liaison between flight crew and cabin crew training departments. Provision should be made for transfer of relevant knowledge and skills between flight crew and cabin crew CRM trainers.
- (7) Management system

CRM training should address hazards and risks identified by the operator's management system described in [ORO.GEN.200](#).
- (8) Competency-based CRM training

Whenever practicable, the compliance-based approach concerning CRM training may be substituted by a competency-based approach. In this context, CRM training should be characterised by a performance orientation, with emphasis on standards of performance and their measurement, and the development of training to the specified performance standards.
- (9) Contracted CRM training

If the operator chooses not to establish its own CRM training, another operator, a third party or a training organisation may be contracted to provide the training in accordance with [ORO.GEN.205](#). In case of contracted CRM training, the operator should ensure that the content of the course covers the specific culture, the type of operations and the associated procedures of the operator. When crew members from different operators attend the same course, the CRM training should be specific to the relevant flight operations and to the trainees concerned.
- (b) Operator's CRM training

The operator's CRM training should cover all elements listed in Table 1 of (g). Several training elements are specified as 'not required' for the operator's CRM training, since they are covered under the introductory CRM course for cabin crew as required in Annex V (Part-CC) to Commission Regulation (EU) No 1178/2011.
- (c) Operator aircraft type conversion CRM training

If the cabin crew member undertakes the operator's conversion training on an aircraft type, the applicable CRM training elements should be covered as specified in Table 1 of (g).
- (d) Annual recurrent CRM training
 - (1) Annual recurrent CRM training should be provided in such a way that all CRM training elements specified for the annual recurrent training in Table 1 of (g) are covered over a period not exceeding 3 years.
 - (2) Operators should update their recurrent CRM training programme over a period not exceeding 3 years. The revision of the programme should take into account information from the operator's management system.
- (e) Senior cabin crew member course
 - (1) CRM training for senior cabin crew members should be the application of knowledge gained in previous CRM training and operational experience relevant to the specific duties and responsibilities of a senior cabin crew member. The operator should ensure that for the senior cabin crew member course the CRM training elements are integrated into the training, as specified in Table 1 of (g).

-
- (2) During the training the senior cabin crew member should demonstrate the ability:
- (i) to manage the operation; and
 - (ii) to take appropriate leadership and management decisions.
- (f) Training elements
- The CRM training elements to be covered are specified in Table 1 of (g). The operator should ensure that the following aspects are addressed:
- (1) Resilience development
- CRM training should address the main aspects of resilience development. The training should cover:
- (i) Mental flexibility
Cabin crew should be trained to:
 - (A) understand that mental flexibility is necessary to recognise critical changes;
 - (B) reflect on their judgement and adjust it to the unique situation;
 - (C) avoid fixed prejudices and over-reliance on standard solutions; and
 - (D) remain open to changing assumptions and perceptions.
 - (ii) Performance adaptation
Cabin crew should be trained to:
 - (A) mitigate frozen behaviours, overreactions and inappropriate hesitation; and
 - (B) adjust actions to current conditions.
- (2) Surprise and startle effect
- CRM training should address unexpected, unusual and stressful situations including interruptions and distractions. Therefore, CRM training should be designed to prepare cabin crew to master sudden events and associated uncontrolled reactions.
- (3) Cultural differences
- CRM training should cover cultural differences of multinational and cross-cultural crews. This includes recognising that:
- (i) different cultures may have different communication specifics, ways of understanding and approaches to the same situation or problem;
 - (ii) difficulties may arise when crew members with different mother tongue communicate in a common language which is not their mother tongue; and
 - (iii) cultural differences may lead to different methods for identifying a situation and solving a problem.
- (4) Operator's safety culture and company culture
- CRM training should cover the operator's safety culture, its company culture, the type of operations and the associated procedures of the operator. This should include areas of operations that may lead to particular difficulties or involve unusual hazards.

(5) Case studies

(i) CRM training should cover aircraft type-specific case studies, based on the information available within the operator’s management system, including:

- (A) accident and serious incident reviews to analyse and identify any associated non-technical causal and contributory factors, and instances or examples of lack of CRM; and
- (B) analysis of occurrences that were well managed.

(ii) If relevant aircraft type-specific or operator-specific case studies are not available, the operator should consider other case studies relevant to the scale and scope of its operations.

(g) CRM training syllabus

Table 1 below specifies which CRM training elements should be covered in each type of training. The levels of training in Table 1 can be described as follows:

- (1) ‘Required’ means training that should be instructional or interactive in style to meet the objectives specified in the CRM training programme or to refresh and strengthen knowledge gained in a previous training.
- (2) ‘In-depth’ means training that should be instructive or interactive in style taking full advantage of group discussions, team task analysis, team task simulation, etc., for the acquisition or consolidation of knowledge, skills and attitudes. The CRM training elements should be tailored to the specific needs of the training phase being undertaken.

Table 1 — Cabin crew CRM training

CRM training elements	Operator’s CRM training	Operator aircraft type conversion training	Annual recurrent training	Senior cabin crew member (SCC) course
General principles				
Human factors in aviation; General instructions on CRM principles and objectives; Human performance and limitations; Threat and error management.	Not required (covered under initial training required by Part-CC)	Required	Required	Required
Relevant to the individual cabin crew member				
Personality awareness, human error and reliability, attitudes and behaviours, self-assessment and self-critique; Stress and stress management; Fatigue and vigilance; Assertiveness, situation awareness, information acquisition and processing.	Not required (covered under initial training required by Part-CC)	Required	Required (3-year cycle)	Required
Relevant to the entire aircraft crew				
Shared situation awareness, shared information acquisition and processing; Workload management; Effective communication and coordination between all crew members including the flight crew as well as inexperienced cabin crew members;	In-depth	Required when relevant to the type(s)	Required (3-year cycle)	In-depth

Leadership, cooperation, synergy, delegation, decision-making, actions; Resilience development; Surprise and startle effect; Cultural differences; Identification and management of the passenger human factors: crowd control, passenger stress, conflict management, medical factors.				
Specifics related to aircraft types (narrow-/wide-bodied, single-/multi-deck), flight crew and cabin crew composition and number of passengers	Required	In-depth	Required (3-year cycle)	In-depth
Relevant to the operator and the organisation				
Operator’s safety culture and company culture, standard operating procedures (SOPs), organisational factors, factors linked to the type of operations; Effective communication and coordination with other operational personnel and ground services; Participation in cabin safety incident and accident reporting.	In-depth	Required when relevant to the type(s)	Required (3-year cycle)	In-depth
Case- studies	In-depth	Required when relevant to the type(s)	In-depth	In-depth

[Table 1 applicable until 25 March 2023 — ED Decision 2022/014/R]

CRM training elements	Operator’s CRM training	Operator aircraft type conversion training	Annual recurrent training	Senior cabin crew member (SCC) course
General principles				
Human factors in aviation; General instructions on CRM principles and objectives; Human performance and limitations; Threat and error management.	Required	Not required	Required	Required
Relevant to the individual cabin crew member				
Personality awareness, human error and reliability, attitudes and behaviours, self-assessment and self-critique; Stress and stress management; Fatigue and vigilance; Assertiveness, situation awareness, information acquisition and processing.	Required	Required	Required (3-year cycle)	Required
Relevant to the entire aircraft crew				
Shared situation awareness, shared information acquisition and processing; Workload management; Effective communication and coordination between all crew members	In-depth	Required when relevant to the type(s)	Required (3-year cycle)	In-depth

including the flight crew as well as inexperienced cabin crew members; Leadership, cooperation, synergy, delegation, decision-making, actions; Resilience development; Surprise and startle effect; Cultural differences; Identification and management of the passenger human factors: crowd control, passenger stress, conflict management, medical factors.				
Specifics related to aircraft types (narrow-/wide-bodied, single-/multi-deck), flight crew and cabin crew composition and number of passengers	Required	In-depth	Required (3-year cycle)	In-depth
Relevant to the operator and the organisation				
Operator's safety culture and company culture, standard operating procedures (SOPs), organisational factors, factors linked to the type of operations; Effective communication and coordination with other operational personnel and ground services; Participation in cabin safety incident and accident reporting.	In-depth	Required when relevant to the type(s)	Required (3-year cycle)	In-depth
Case- studies	In-depth	Required when relevant to the type(s)	In-depth	In-depth

[Table 1 applicable from 26 March 2023 — ED Decision 2022/014/R]

AMC2 ORO.CC.115(e) Conduct of training courses and associated checking

ED Decision 2022/014/R

CREW RESOURCE MANAGEMENT (CRM) TRAINING — SINGLE CABIN CREW OPERATIONS

For single cabin crew operations, [AMC1 ORO.CC.115\(e\)](#) should be applied with the following differences:

(a) Relevant training elements

CRM training should focus on the elements specified in Table 1 of (g) of [AMC1 ORO.CC.115\(e\)](#) which are relevant to single cabin crew operations. Therefore, single cabin crew CRM training should include, among others:

- (1) situation awareness;
- (2) workload management;
- (3) decision-making;
- (4) resilience development;
- (5) surprise and startle effect; and

- (6) effective communication and coordination with
 - (i) the flight crew; and
 - (ii) other operational personnel and ground services.
- (b) Virtual classroom training

Notwithstanding (a)(2) of [AMC1 ORO.CC.115\(e\)](#), classroom training may take place remotely, using a videoconferencing tool for a cabin crew member operating on aircraft with a maximum operational passenger seating configuration of 19 or less. The tool should permit real-time interaction between the trainees and the trainer, including speech and elements of body language. It should also be capable of transmitting any document to the trainee that the trainer wishes to present. The CRM trainer should establish the list of trainees in advance. Their number should be limited to 6 to ensure a sufficient level of interaction during the training session.

AMC3 ORO.CC.115(e) Conduct of training courses and associated checking

ED Decision 2015/022/R

CABIN CREW CRM TRAINER

- (a) Applicability

The provisions described herein:

- (1) should be fulfilled by cabin crew CRM trainers responsible for classroom CRM training; and
 - (2) are not applicable to trainers or instructors conducting training other than CRM training, but integrating CRM elements into this training. Nevertheless, trainers or instructors who are integrating CRM elements into the aircraft type training, recurrent training or senior cabin crew member training should have acquired relevant knowledge of human performance and limitations, and have completed appropriate CRM training.
- (b) Qualification of cabin crew CRM trainer
 - (1) A training and standardisation programme for cabin crew CRM trainers should be established.
 - (2) The cabin crew CRM trainer, in order to be suitably qualified, should:
 - (i) have adequate knowledge of the relevant flight operations;
 - (ii) have received instructions on human performance and limitations (HPL);
 - (iii) have completed an introductory CRM course, as required in Annex V (Part-CC) to Commission Regulation (EU) No 1178/2011, and an operator's CRM training, as specified in [AMC1 ORO.CC.115\(e\)](#);
 - (iv) have received training in group facilitation skills;
 - (v) have received additional training in the fields of group management, group dynamics and personal awareness; and
 - (vi) have demonstrated the knowledge, skills and credibility required to train the CRM training elements in the non-operational environment, as specified in Table 1 of [AMC1 ORO.CC.115\(e\)](#).

- (3) An experienced CRM trainer may become a cabin crew CRM trainer if he/she demonstrates a satisfactory knowledge of the relevant flight operations and the cabin crew working environment, and fulfils the provisions specified in (2)(ii) to (2)(vi).
- (c) Training of cabin crew CRM trainer
- (1) Training of cabin crew CRM trainers should be both theoretical and practical. Practical elements should include the development of specific trainer skills, particularly the integration of CRM into day-to-day operations.
 - (2) The basic training of cabin crew CRM trainers should include the training elements for cabin crew, as specified in Table 1 of [AMC1 ORO.CC.115\(e\)](#). In addition, the basic training should include the following:
 - (i) introduction to CRM training;
 - (ii) operator's management system; and
 - (iii) characteristics, as applicable:
 - (A) of the different types of CRM trainings (initial, recurrent, etc.);
 - (B) of combined training; and
 - (C) related to the type of aircraft or operation.
 - (3) The refresher training of cabin crew CRM trainers should include new methodologies, procedures and lessons learned.
 - (4) The training of cabin crew CRM trainers should be conducted by cabin crew CRM trainers with a minimum of 3 years' experience. Assistance may be provided by experts in order to address specific areas.
- (d) Assessment of cabin crew CRM trainer
- (1) A cabin crew CRM trainer should be assessed by the operator when conducting the first CRM training course. This first assessment should be valid for a period of 3 years.
 - (2) Assessment is the process of observing, recording, interpreting and debriefing the cabin crew CRM trainer. The operator should describe the assessment process in the operations manual. All personnel involved in the assessment must be credible and competent in their role.
- (e) Recency and renewal of qualification as cabin crew CRM trainer
- (1) For recency of the 3-year validity period, the cabin crew CRM trainer should:
 - (i) conduct at least 2 CRM training events in any 12-month period;
 - (ii) be assessed within the last 12 months of the 3-year validity period by the operator; and
 - (iii) complete CRM trainer refresher training within the 3-year validity period.
 - (2) The next 3-year validity period should start at the end of the previous period.
 - (3) For renewal, i.e. when a cabin crew CRM trainer does not fulfil the provisions of (1), he/she should, before resuming as cabin crew CRM trainer:
 - (i) comply with the qualification provisions of (b) and (d); and
 - (ii) complete CRM trainer refresher training.

GM1 ORO.CC.115(e) Conduct of training courses and associated checking

ED Decision 2015/022/R

CRM – GENERAL

- (a) CRM is the effective utilisation of all available resources (e.g. crew members, aircraft systems, and supporting facilities) to achieve safe and efficient operation.
- (b) The objective of CRM is to enhance the communication and management skills of the crew member, as well as the importance of effective coordination and two-way communication between all crew members.

GM2 ORO.CC.115(e) Conduct of training courses and associated checking

ED Decision 2022/014/R

MINIMUM TRAINING TIMES

- (a) The following minimum training times are appropriate:
 - (1) multi cabin crew operations:
 - (i) combined CRM training: 6 training hours over a period of 3 years or, for EBT operators which have implemented a competency framework for cabin crew (e.g. ICAO PANS-TRG), a minimum of 3 training hours within 3 years; and
 - (ii) operator's CRM training: 6 training hours;
 - (2) operator's CRM training for single cabin crew operations: 4 training hours for a cabin crew member operating on aircraft with a maximum operational passenger seating configuration of 19 or less;
 - (3) cabin crew CRM trainer:
 - (i) basic training:
 - (A) 18 training hours when the operator can justify that the trainee already has received sufficient and suitable instruction on training skills in order to conduct CRM training courses; or
 - (B) 30 training hours for trainees not fulfilling (A); and
 - (ii) refresher training: 6 training hours.
- (b) 'Training hours' means actual training time excluding breaks.

GM3 ORO.CC.115(e) Conduct of training courses and associated checking

ED Decision 2022/014/R

DESIGN, IMPLEMENTATION AND EVALUATION OF CRM TRAINING

The checklist in Table 1 provides guidance on the design, implementation and evaluation of CRM training, and on their incorporation into the operator's safety culture. Elements of the operator's management systems and the competency-based approach are incorporated in the checklist.

Table 1 — Checklist for design, implementation, evaluation and incorporation of CRM training

Step No	Description	Element
1	Needs analysis	Determine the necessary CRM competencies
		Develop CRM training goals
		Ensure the organisation is ready for CRM training
2	Design	Develop CRM training objectives
		Determine what to measure and how to measure it
3	Development	Describe the CRM learning environment
		Develop full-scale prototype of training
		Validate and modify CRM training
4	Implementation	Prepare trainees and environment
		Set a climate for learning (e.g. practice and feedback)
		Implement the CRM training programme
5	Evaluation	Determine training effectiveness
		Evaluate CRM training at multiple levels
		Revise the CRM training programme to improve effectiveness
6	Incorporation	Establish an environment where CRM training is positively recognised
		Reinforce CRM behaviours in daily work
		Provide recurrent CRM training

GM4 ORO.CC.115(e) Conduct of training courses and associated checking

ED Decision 2022/014/R

RESILIENCE DEVELOPMENT

- (a) The main aspects of resilience development can be described as the ability to:
- (1) learn ('knowing what has happened');
 - (2) monitor ('knowing what to look for');
 - (3) anticipate ('finding out and knowing what to expect'); and
 - (4) respond ('knowing what to do and being capable of doing it').
- (b) Operational safety is a continuous process of evaluation of and adjustment to existing and future conditions. In this context, and following the description in (a), resilience development involves an ongoing and adaptable process including situation assessment, self-review, decision and action. Training on resilience development enables crew members to draw the right conclusions from both positive and negative experiences. Based on those experiences, crew members are better prepared to maintain or create safety margins by adapting to dynamic complex situations.
- (c) The training topics in (f)(1) of [AMC1 ORO.CC.115\(e\)](#) are to be understood as follows:
- (1) Mental flexibility
 - (i) The phrase 'understand that mental flexibility is necessary to recognise critical changes' means that crew members are prepared to respond to situations for which there is no set procedure.

- (ii) The phrase ‘reflect on their judgement and adjust it to the unique situation’ means that crew members learn to review their judgement based on the unique characteristics of the given circumstances.
 - (iii) The phrase ‘avoid fixed prejudices and over-reliance on standard solutions’ means that crew members learn to update solutions and standard response sets, which have been formed on prior knowledge.
 - (iv) The phrase ‘remain open to changing assumptions and perceptions’ means that crew members constantly monitor the situation, and are prepared to adjust their understanding of the evolving conditions.
- (2) Performance adaptation
- (i) The phrase ‘mitigate frozen behaviours, overreactions and inappropriate hesitation’ means that crew members correct improper actions with a balanced response.
 - (ii) The phrase ‘adjust actions to current conditions’ means that crew members’ responses are in accordance with the actual situation.

GM5 ORO.CC.115(e) Conduct of training courses and associated checking

ED Decision 2015/022/R

CABIN CREW CRM TRAINER ASSESSMENT

- (a) For assessing cabin crew CRM trainers, the operator may nominate experienced cabin crew CRM trainers who have demonstrated continued compliance with the provisions for a cabin crew CRM trainer and capability in that role for at least 3 years.
- (b) An operator that does not have the resources to conduct the assessment may employ a contractor. The standard as regards the assessment is confirmed on a 3-year basis by the operator.
- (c) The checklist in Table 1 provides guidance on the assessment of a cabin crew CRM trainer. If a cabin crew CRM trainer is competent in his/her role, the response to the questions in Table 1 should be ‘yes’. When answering the questions in Table 1, justifications and examples related to the responses given should be provided.

Table 1 — Cabin crew CRM trainer assessment checklist

Questions to assess a cabin crew CRM trainer	Response yes/no
Did the CRM trainer demonstrate the knowledge required for the role?	
Did the CRM trainer support CRM concepts?	
Did the CRM trainer encourage trainees to participate, share their experiences and self-analyse?	
Did the CRM trainer identify and respond to the trainees’ needs relative to expertise/experience?	
Did the CRM trainer show how CRM is integrated in technical training?	
Did the CRM trainer incorporate company CRM standards when appropriate?	
Did the CRM trainer identify and discuss the non-technical reasons involved in accidents, incidents and events included in case studies?	
Did the CRM trainer regularly check for understanding and resolve ambiguities?	
Did the CRM trainer demonstrate effective instruction and facilitation skills?	

GM6 ORO.CC.115(e) Conduct of training courses and associated checking

ED Decision 2022/014/R

CRM TRAINING — VIRTUAL CLASSROOM TRAINING — SINGLE-CABIN CREW OPERATIONS OF AIRCRAFT WITH AN MOPSC OF 19 OR LESS

- (a) A successful virtual classroom training relies on the ability of the trainer to make best use of the associated technologies in the context of CRM training. The cabin crew CRM trainer may need to receive appropriate training covering the following:
 - (1) learning style;
 - (2) teaching method associated with virtual classroom instruction, such as videoconferencing, and a familiarisation with the virtual classroom instruction system in use, including management of time, training media and equipment and tools.
- (b) The requirement of [ORO.GEN.140](#) for the operator to grant access to the competent authority also applies to the virtual classroom training.
- (c) More information on virtual classroom training is provided in the EASA Guidance for allowing virtual classroom instruction and distance learning.

ORO.CC.120 Initial training course

Regulation (EU) No 965/2012

- (a) Each new entrant who does not already hold a valid cabin crew attestation issued in accordance with Annex V (Part-CC) to Regulation (EU) No 1178/2011:
 - (1) shall be provided with an initial training course as specified in CC.TRA.220 of that Annex; and
 - (2) shall successfully undergo the associated examination before undertaking other training required by this Subpart.
- (b) Elements of the initial training programme may be combined with the first aircraft type specific training and operator conversion training, provided that the requirements of CC.TRA.220 are met and any such element(s) are recorded as elements of the initial training course in the training records of the cabin crew members concerned.

AMC1 ORO.CC.120(a)(1) Initial training course

ED Decision 2014/017/R

NEW ENTRANTS IN OPERATIONS OTHER THAN CAT OPERATIONS

- (a) When a new entrant to an operator conducting operations other than CAT is a cabin crew member, not holding a valid cabin crew attestation, who has already acquired experience as cabin crew in operations other than CAT, credit may be granted to the elements of the initial training programme he/she has previously completed if such training elements are documented in his/her training records.
- (b) In such a case, the operator should ensure that:
 - (1) the full training programme, as specified in Appendix 1 to Part-CC, has been covered, and
 - (2) the new entrant successfully undergoes the examination required by [ORO.CC.120\(a\)\(2\)](#).

ORO.CC.125 Aircraft type specific training and operator conversion training

Regulation (EU) No 71/2014

- (a) Each cabin crew member shall have completed appropriate aircraft type specific training and operator conversion training, as well as the associated checks, before being:
 - (1) first assigned by the operator to operate as a cabin crew member; or
 - (2) assigned by that operator to operate on another aircraft type.
- (b) When establishing the aircraft type specific and the operator conversion training programmes and syllabi, the operator shall include, where available, the relevant elements defined in the mandatory part of the operational suitability data established in accordance with Regulation (EU) No 748/2012.
- (c) The aircraft type specific training programme shall:
 - (1) involve training and practice on a representative training device or on the actual aircraft; and
 - (2) cover at least the following aircraft type specific training elements:
 - (i) aircraft description as relevant to cabin crew duties;
 - (ii) all safety equipment and systems installed relevant to cabin crew duties;
 - (iii) operation and actual opening, by each cabin crew member, of each type or variant of normal and emergency doors and exits in the normal and emergency modes;
 - (iv) demonstration of the operation of the other exits including flight crew compartment windows;
 - (v) fire and smoke protection equipment where installed;
 - (vi) evacuation slide training, where fitted;
 - (vii) operation of the seat, restraint system and oxygen system equipment relevant to pilot incapacitation.
- (d) The operator conversion training programme for each aircraft type to be operated shall:
 - (1) involve training and practice on a representative training device or on the actual aircraft;
 - (2) include training in the operator's standard operating procedures for cabin crew members to be first assigned to duties by the operator;
 - (3) cover at least the following operator specific training elements as relevant to the aircraft type to be operated:
 - (i) description of the cabin configuration;
 - (ii) location, removal and use of all portable safety and emergency equipment carried on-board;
 - (iii) all normal and emergency procedures;
 - (iv) passenger handling and crowd control;
 - (v) fire and smoke training including the use of all related fire-fighting and protective equipment representative of that carried on-board;
 - (vi) evacuation procedures;

- (vii) pilot incapacitation procedures;
- (viii) applicable security requirements and procedures;
- (ix) crew resource management.

AMC1 ORO.CC.125(c) Aircraft type specific training and operator conversion training

ED Decision 2014/017/R

TRAINING PROGRAMME — AIRCRAFT TYPE SPECIFIC TRAINING

The following aircraft type specific training elements should be covered as relevant to the aircraft type:

- (a) Aircraft description
 - (1) type of aircraft, principal dimensions, narrow or wide bodied, single or double deck;
 - (2) speed, altitude, range;
 - (3) passenger seating capacity;
 - (4) flight crew number and minimum number of required cabin crew;
 - (5) cabin doors/exits location and sill height;
 - (6) cargo and unpressurised areas as relevant;
 - (7) aircraft systems relevant to cabin crew duties;
 - (8) flight crew compartment — general presentation, pilot seats and their mechanism, emergency exits, storage;
 - (9) required cabin crew stations;
 - (10) flight crew compartment security — general: door components and use;
 - (11) access to avionics bay where relevant;
 - (12) lavatories — general: doors, systems, calls and signs; and
 - (13) least risk bomb location.
- (b) Safety and emergency equipment and aircraft systems installed

Each cabin crew member should receive realistic training on, and demonstration of, the location and use of all aircraft type specific safety and emergency equipment and aircraft systems installed, with emphasis on the following:

 - (1) slides, and where non-self-supporting slides are carried, the use of any associated assisting evacuation means;
 - (2) life-rafts and slide-rafts, including the equipment attached to, and/or carried in, the raft;
 - (3) drop-out oxygen system; and
 - (4) communication equipment.
- (c) Operation of doors and exits

This training should be conducted in a representative training device or in the actual aircraft and should include failure of power assist systems where fitted and the action and forces

required to operate and deploy evacuation slides. Training should also include operation and actual opening of the flight crew compartment security door when installed.

(d) Fire and smoke protection equipment

Each cabin crew member should be trained in using fire and/or smoke protection equipment where fitted.

(e) Evacuation slide training

(1) Each cabin crew member should descend an evacuation slide from a height representative of the aircraft main deck sill height.

(2) The slide should be fitted to a representative training device or to the actual aircraft.

(3) A further descent should be made when the cabin crew member qualifies on an aircraft type in which the main deck exit sill height differs significantly from any aircraft type previously operated.

(f) Operation of equipment related to pilot incapacitation

The training should cover any type specific elements or conditions relevant to cabin crew actions to be taken in case of pilot incapacitation. Each cabin crew member should be trained to operate all equipment that must be used in case of pilot incapacitation.

AMC1 ORO.CC.125(d) Aircraft type-specific training and operator conversion training

ED Decision 2019/019/R

TRAINING PROGRAMME — OPERATOR CONVERSION TRAINING

The following training elements should be covered as relevant to the aircraft type and the related operator's specifics:

(a) Description of the cabin configuration

The description should cover all elements specific to the operator's cabin configuration and any differences with those previously covered in accordance with [AMC1 ORO.CC.125\(c\)](#), including:

- (1) required and additional cabin crew stations — location (including direct view), restraint systems, control panels;
- (2) passenger seats — general presentation and associated operator's specific features and equipment;
- (3) designated stowage areas;
- (4) lavatories — operator's specific features, equipment and systems additional to the aircraft type specific elements;
- (5) galley — location, appliances, water and waste system, including shut-off, sinks, drains, stowage, control panels, calls and signs;
and where applicable
- (6) crew rest areas — location, systems, controls, safety and emergency equipment;
- (7) cabin dividers, curtains, partitions;
- (8) lift location, use, controls;

- (9) stowage for the containment of waste;
- (10) passenger hand rail system or alternative means; and
- (11) in-flight entertainment (IFE) system, if installed (e.g. central system or hand-held device(s) such as PEDs for the use by passenger(s) as applicable) and its safety aspects.

(b) Safety and emergency equipment

Each cabin crew member should receive realistic training on and demonstration of the location and use of all safety and emergency equipment carried, including:

- (1) life jackets, infant life jackets and flotation devices;
- (2) first-aid and drop-out oxygen, including supplementary systems;
- (3) fire extinguishers and protective breathing equipment (PBE);
- (4) crash axe or crowbar;
- (5) emergency lights including torches;
- (6) communication equipment, including megaphones;
- (7) slide rafts and life rafts' survival packs and their contents;
- (8) pyrotechnics (actual or representative devices);
- (9) first-aid kits, emergency medical kits and their contents; and
- (10) other portable safety and emergency equipment, where applicable.

(c) Normal and emergency procedures

Each cabin crew member should be trained on the operator's normal and emergency procedures as applicable, with emphasis on the following:

- (1) passenger briefing, safety demonstration and cabin surveillance;
- (2) severe air turbulence;
- (3) non-pressurisation, slow and sudden decompression, including the donning of portable oxygen equipment by each cabin crew member;
- (4) other in-flight emergencies; and
- (5) carriage of special categories of passengers (SCPs).

(d) Passenger handling and crowd control

Training should be provided on the practical aspects of passenger preparation and handling, as well as crowd control, in various emergency situations as applicable to the operator's specific aircraft cabin configuration, and should cover the following:

- (1) communications between flight crew and cabin crew and use of all communications equipment, including the difficulties of coordination in a smoke-filled environment;
- (2) verbal commands;
- (3) the physical contact that may be needed to encourage people out of a door/exit and onto a slide;
- (4) redirection of passengers away from unusable doors/exits;
- (5) marshalling of passengers away from the aircraft;

- (6) evacuation of special categories of passengers with emphasis on passengers with disabilities or reduced mobility; and
 - (7) authority and leadership.
- (e) Fire and smoke training
- (1) Each cabin crew member should receive realistic and practical training in the use of all fire-fighting equipment, including protective clothing representative of that carried in the aircraft.
 - (2) Each cabin crew member should:
 - (i) extinguish an actual fire characteristic of an aircraft interior fire except that, in the case of halon extinguishers, an alternative extinguishing agent may be used; and
 - (ii) exercise the donning and use of PBE in an enclosed simulated smoke-filled environment with particular emphasis on identifying the actual source of fire and smoke.
- (f) Evacuation procedures
- Training should include all the operator's procedures that are applicable to planned or unplanned evacuations on land and water. It should also include, where relevant, the additional actions required from cabin crew members responsible for a pair of doors/exits and the recognition of when doors/exits are unusable or when evacuation equipment is unserviceable.
- (g) Pilot incapacitation procedures
- Unless the minimum flight crew is more than two, each cabin crew member should be trained in the procedure for pilot incapacitation. Training in the use of flight crew checklists, where required by the operator's standard operating procedures (SOPs), should be conducted by a practical demonstration.
- (h) CRM
- (1) The operator should ensure that all applicable CRM training elements, as specified in Table 1 of [AMC1 ORO.CC.115\(e\)](#), are covered to the level required in the column 'Operator aircraft type conversion training'.
 - (2) The operator's CRM training and the CRM training covered during the operator aircraft type conversion training should be conducted by at least one cabin crew CRM instructor.

AMC1 ORO.CC.125 & ORO.CC.130 Aircraft type specific training and operator conversion training & differences training

ED Decision 2014/017/R

TRAINING PROGRAMMES

The programmes and syllabi of aircraft type specific training, operator conversion training and differences training should take into account the cabin crew member's previous training as documented in his/her training records.

AMC1 ORO.CC.125(b) & ORO.CC.130(c) Aircraft type specific training and operator conversion training & differences training

ED Decision 2014/017/R

NON-MANDATORY (RECOMMENDATIONS) ELEMENTS OF OPERATIONAL SUITABILITY DATA

When developing the training programmes and syllabi for aircraft-type specific training and for differences training, the operator should consider the non-mandatory (recommendations) elements for the relevant type that are provided in the operational suitability data established in accordance with Commission Regulation (EU) No 748/2012¹.

ORO.CC.130 Differences training

Regulation (EU) No 71/2014

- (a) In addition to the training required in [ORO.CC.125](#), the cabin crew member shall complete appropriate training and checking covering any differences before being assigned on:
 - (1) a variant of an aircraft type currently operated; or
 - (2) a currently operated aircraft type or variant with different:
 - (i) safety equipment;
 - (ii) safety and emergency equipment location; or
 - (iii) normal and emergency procedures.
- (b) The differences training programme shall:
 - (1) be determined as necessary on the basis of a comparison with the training programme completed by the cabin crew member, in accordance with [ORO.CC.125\(c\)](#) and (d), for the relevant aircraft type; and
 - (2) involve training and practice in a representative training device or the actual aircraft as relevant to the difference training element to be covered.
- (c) When establishing a differences training programme and syllabus for a variant of an aircraft type currently operated, the operator shall include, where available, the relevant elements defined in the mandatory part of the operational suitability data established in accordance with Regulation (EU) No 748/2012.

AMC1 ORO.CC.125 & ORO.CC.130 Aircraft type specific training and operator conversion training & differences training

ED Decision 2014/017/R

TRAINING PROGRAMMES

The programmes and syllabi of aircraft type specific training, operator conversion training and differences training should take into account the cabin crew member's previous training as documented in his/her training records.

¹ OJ L 243, 27.9.2003, p. 6.

AMC1 ORO.CC.125(b) & ORO.CC.130(c) Aircraft type specific training and operator conversion training & differences training

ED Decision 2014/017/R

NON-MANDATORY (RECOMMENDATIONS) ELEMENTS OF OPERATIONAL SUITABILITY DATA

When developing the training programmes and syllabi for aircraft-type specific training and for differences training, the operator should consider the non-mandatory (recommendations) elements for the relevant type that are provided in the operational suitability data established in accordance with Commission Regulation (EU) No 748/2012¹.

ORO.CC.135 Familiarisation

Regulation (EU) No 965/2012

After completion of aircraft type specific training and operator conversion training on an aircraft type, each cabin crew member shall complete appropriate supervised familiarisation on the type before being assigned to operate as a member of the minimum number of cabin crew required in accordance with [ORO.CC.100](#).

AMC1 ORO.CC.135 Familiarisation

ED Decision 2019/019/R

FAMILIARISATION FLIGHTS AND AIRCRAFT FAMILIARISATION VISITS

- (a) For CAT operations, familiarisation of cabin crew to a new aircraft type or variant should be completed in accordance with the following, as relevant:
- (1) New entrant cabin crew
Each new entrant cabin crew member having no previous comparable operating experience should participate in:
 - (i) a familiarisation visit, as described in (c), to the aircraft to be operated; and
 - (ii) familiarisation flights, as described in (b).
 - (2) Cabin crew operating on a subsequent aircraft type
A cabin crew member assigned to operate on a subsequent aircraft type with the same operator should participate either in:
 - (i) a familiarisation flight, as described in (b); or
 - (ii) a familiarisation visit, as described in (c), to the aircraft type to be operated.
- (b) Familiarisation flights
- (1) During familiarisation flights, the cabin crew member should be assigned in addition to the minimum number of cabin crew required in accordance with [ORO.CC.100](#) and if applicable [ORO.CC.200](#).
 - (2) Familiarisation flights should be:
 - (i) conducted under the supervision of the senior cabin crew member;

¹ OJ L 243, 27.9.2003, p. 6.

- (ii) structured and conducted with the cabin crew member participating in pre-flight, in-flight and post-flight safety duties;
 - (iii) operated with the cabin crew member wearing the operator's cabin crew uniform; and
 - (iv) recorded in the training record of the cabin crew member.
- (c) Aircraft familiarisation visits
- (1) Aircraft visits should enable the cabin crew member to become familiar with the aircraft environment and its equipment. Accordingly, aircraft visits should be conducted by appropriately qualified persons. The aircraft visit should provide an overview of the aircraft's exterior, interior and aircraft systems with emphasis on the following:
 - (i) interphone and public address systems;
 - (ii) evacuation alarm systems;
 - (iii) emergency lighting;
 - (iv) smoke detection systems;
 - (v) safety and emergency equipment;
 - (vi) flight crew compartment;
 - (vii) cabin crew stations;
 - (viii) lavatories;
 - (ix) galleys, galley security and water shut-off;
 - (x) cargo areas if accessible from the passenger compartment during flight;
 - (xi) circuit breaker panels located in the passenger compartment;
 - (xii) crew rest areas;
 - (xiii) doors/exits location and environment; and
 - (xiv) IFE system used for conveying safety-related information.
 - (2) An aircraft familiarisation visit may be combined with the aircraft type specific training or operator conversion training required by [ORO.CC.125](#).
- (d) For cabin crew members assigned to operations other than CAT, familiarisation should be completed by means of an aircraft familiarisation visit, or a familiarisation flight, as appropriate taking into account the aircraft type to be operated by the cabin crew member.

ORO.CC.140 Recurrent training

Regulation (EU) No 965/2012

- (a) Each cabin crew member shall complete annually recurrent training and checking.
- (b) Recurrent training shall cover the actions assigned to each member of the cabin crew in normal and emergency procedures and drills relevant to each aircraft type and/or variant to be operated.

- (c) Aircraft type specific training elements:
- (1) Recurrent training shall include annually touch-drills by each cabin crew member for simulating the operation of each type or variant of normal and emergency doors and exits for passenger evacuation.
 - (2) Recurrent training shall also include at intervals not exceeding three years:
 - (i) operation and actual opening by each cabin crew member, in a representative training device or in the actual aircraft, of each type or variant of normal and emergency exits in the normal and emergency modes;
 - (ii) actual operation by each cabin crew member, in a representative training device or in the actual aircraft, of the flight crew compartment security door, in both normal and emergency modes, and of the seat and restraint system, and a practical demonstration of the oxygen system equipment relevant to pilot incapacitation;
 - (iii) demonstration of the operation of all other exits including the flight crew compartment windows; and
 - (iv) demonstration of the use of the life-raft, or slide raft, where fitted.
- (d) Operator specific training elements:
- (1) Recurrent training shall include annually:
 - (i) by each cabin crew member:
 - (A) location and handling of all safety and emergency equipment installed or carried on board; and
 - (B) the donning of life-jackets, portable oxygen and protective breathing equipment (PBE);
 - (ii) stowage of articles in the passenger compartment;
 - (iii) procedures related to aircraft surface contamination;
 - (iv) emergency procedures;
 - (v) evacuation procedures;
 - (vi) incident and accident review;
 - (vii) crew resource management;
 - (viii) aero-medical aspects and first aid including related equipment;
 - (ix) security procedures.
 - (2) Recurrent training shall also include at intervals not exceeding three years:
 - (i) use of pyrotechnics (actual or representative devices);
 - (ii) practical demonstration of the use of flight crew checklists;
 - (iii) realistic and practical training in the use of all fire-fighting equipment, including protective clothing, representative of that carried in the aircraft;
 - (iv) by each cabin crew member:
 - (A) extinguishing a fire characteristic of an aircraft interior fire;
 - (B) donning and use of PBE in an enclosed simulated smoke-filled environment.

- (e) Validity periods:
- (1) The annual recurrent training validity period shall be 12 calendar months counted from the end of the month when the check was taken.
 - (2) If the recurrent training and checking required in (a) are undertaken within the last three calendar months of the validity period, the new validity period shall be counted from the original expiry date.
 - (3) For the additional triennial training elements specified in (c)(2) and (d)(2), the validity period shall be 36 calendar months counted from the end of the month when the checks were taken.

AMC1 ORO.CC.140 Recurrent training

ED Decision 2016/004/R

TRAINING PROGRAMMES

- (a) Elements of the annual recurrent training programme
- (1) Training on the location and handling of safety and emergency equipment should include all relevant oxygen systems, and any equipment such as defibrillators if carried on board.
 - (2) Training on emergency procedures should cover pilot incapacitation procedures and crowd control techniques.
 - (3) CRM training should satisfy the following:
 - (i) the applicable training elements specified in Table 1 of [AMC1 ORO.CC.115\(e\)](#) should be covered within a 3-yearcycle to the level required by column 'Annual Recurrent Training';
 - (ii) the definition and implementation of the CRM training programme should be managed by a cabin crew CRM trainer; and
 - (iii) when CRM training is provided by stand-alone modules, it should be conducted by at least one cabin crew CRM trainer.
- (b) Additional triennial elements of recurrent training programme
- (1) Training on the operation of normal and emergency doors/exits should cover failure of power assist systems where fitted. This should include the actions and forces required to operate and deploy evacuation slides, and additional training when relevant for cabin crew members responsible for a pair of doors/exits.
 - (2) Training in the use of all firefighting equipment, including protective clothing, representative of that carried in the aircraft should include individual practice by each cabin crew member to extinguish a fire characteristic of an aircraft interior fire except that, in the case of halon extinguishers, an alternative extinguishing agent may be used. Training should place particular emphasis on identifying the actual source of fire or smoke.
 - (3) Training on normal and emergency procedures for special categories of passengers (SCPs) should cover the specific procedures established by the operator for the carriage of SCPs. The operator may determine that such training is to be completed at shorter intervals, taking into account the route structure, passenger profiles, aircraft types operated, seasonal demands and operations.

ORO.CC.145 Refresher training

Regulation (EU) No 965/2012

- (a) When a cabin crew member, during the preceding six months within the validity period of the last relevant recurrent training and checking:
- (1) has not performed any flying duties, he/she shall, before being reassigned to such duties, complete refresher training and checking for each aircraft type to be operated; or
 - (2) has not performed flying duties on one particular aircraft type, he/she shall, before being reassigned to duties, complete on that aircraft type:
 - (i) refresher training and checking; or
 - (ii) two familiarisation flights in accordance with [ORO.CC.135](#).
- (b) The refresher training programme for each aircraft type shall at least cover:
- (1) emergency procedures;
 - (2) evacuation procedures;
 - (3) operation and actual opening, by each cabin crew member, of each type or variant of normal and emergency exits and of the flight crew compartment security door in the normal and emergency modes;
 - (4) demonstration of the operation of all other exits including the flight crew compartment windows;
 - (5) location and handling of all relevant safety and emergency equipment installed or carried on-board.
- (c) The operator may elect to replace refresher training by recurrent training if the reinstatement of the cabin crew member's flying duties commences within the validity period of the last recurrent training and checking. If that validity period has expired, refresher training may only be replaced by aircraft type specific and operator conversion training as specified in [ORO.CC.125](#).

AMC1 ORO.CC.145 Refresher training

ED Decision 2014/017/R

TRAINING PROGRAMME

- (a) Training on emergency procedures should include pilot incapacitation procedures and crowd control techniques as applicable to the aircraft type; and
- (b) Operation of doors and exits by each cabin crew member should include failure of power assist systems where fitted as well as the action and forces required to operate and deploy evacuation slides.

GM1 ORO.CC.145 Refresher training

ED Decision 2014/017/R

FREQUENCY OF REFRESHER TRAINING

For aircraft with complex equipment or procedures, the operator should consider the need for refresher training to be completed by cabin crew members who have been absent from flying duties for less than 6 months.

SECTION 2 – ADDITIONAL REQUIREMENTS FOR COMMERCIAL AIR TRANSPORT OPERATIONS

ORO.CC.200 Senior cabin crew member

Regulation (EU) No 965/2012

- (a) When more than one cabin crew member is required, the composition of the cabin crew shall include a senior cabin crew member nominated by the operator.
- (b) The operator shall nominate cabin crew members to the position of senior cabin crew member only if they:
 - (1) have at least one year of experience as operating cabin crew member; and
 - (2) have successfully completed a senior cabin crew training course and the associated check.
- (c) The senior cabin crew training course shall cover all duties and responsibilities of senior cabin crew members and shall include at least the following elements:
 - (1) pre-flight briefing;
 - (2) cooperation with the crew;
 - (3) review of operator requirements and legal requirements;
 - (4) accident and incident reporting;
 - (5) human factors and crew resource management (CRM); and
 - (6) flight and duty time limitations and rest requirements.
- (d) The senior cabin crew member shall be responsible to the commander for the conduct and coordination of normal and emergency procedures specified in the operations manual, including for discontinuing non-safety-related duties for safety or security purposes.
- (e) The operator shall establish procedures to select the most appropriately qualified cabin crew member to act as senior cabin crew member if the nominated senior cabin crew member becomes unable to operate. Changes to these procedures shall be notified to the competent authority.

AMC1 ORO.CC.200(c) Senior cabin crew member

ED Decision 2014/017/R

TRAINING PROGRAMME

The senior cabin crew member training course should at least cover the following elements:

- (a) Pre-flight briefing:
 - (1) operating as a crew;
 - (2) allocation of cabin crew stations and responsibilities; and
 - (3) consideration of the particular flight, aircraft type, equipment, area and type of operation, including extended range operations with two-engine aeroplanes (ETOPS) and special categories of passengers with emphasis on passengers with disabilities or reduced mobility, infants and stretcher cases.

- (b) Cooperation within the crew:
 - (1) discipline, responsibilities and chain of command;
 - (2) importance of coordination and communication; and
 - (3) pilot incapacitation.
- (c) Review of operator requirements and legal requirements:
 - (1) passenger briefing, safety briefing cards;
 - (2) securing of galleys;
 - (3) stowage of cabin baggage;
 - (4) electronic equipment;
 - (5) procedures when fuelling with passengers on board;
 - (6) turbulence; and
 - (7) documentation.
- (d) Accident and incident reporting.
- (e) Human factors and CRM:

The operator should ensure that all applicable elements specified in Table 1 of [AMC1 ORO.CC.115\(e\)](#) are integrated into the training and covered to the level required by Column 'Senior Cabin Crew Course'.
- (f) Flight and duty time limitations and rest requirements (FTL).

AMC1 ORO.CC.200(d) Senior cabin crew member

ED Decision 2014/017/R

RESPONSIBILITY TO THE COMMANDER

When the level of turbulence so requires, and in the absence of any instructions from the flight crew, the senior cabin crew member should be entitled to discontinue non-safety-related duties and advise the flight crew of the level of turbulence being experienced and the need for the fasten seat belt signs to be switched on. This should be followed by the cabin crew securing the passenger cabin and other relevant areas.

AMC1 ORO.CC.200(e) Senior cabin crew member

ED Decision 2015/005/R

UNABLE TO OPERATE

- (a) Replacement of senior cabin crew member at a base of the operator

A senior cabin crew member who did not report for or cannot commence the assigned flight or series of flights originating from a base of the operator should be replaced without undue delay. The flight should not depart unless another senior cabin crew member has been assigned.
- (b) Replacement of incapacitated or unavailable senior cabin crew member
 - (1) A senior cabin crew member, who becomes incapacitated during a flight or series of flights, or unavailable at a stopover (layover) point, should be replaced without undue delay by another senior cabin crew member qualified on the concerned aircraft type/variant. If there is no other senior cabin crew member, the most appropriately

qualified cabin crew member should be assigned to act as senior cabin crew member in order to reach a base of the operator.

- (2) If during the series of flights the aircraft transits via a base of the operator, the assigned cabin crew member acting as senior cabin crew member should be replaced by another senior cabin crew member.

AMC2 ORO.CC.200(e) Senior cabin crew member

ED Decision 2015/005/R

MOST APPROPRIATELY QUALIFIED CABIN CREW MEMBER

Selection of the most appropriately qualified cabin crew member should take into account if the individual's experience as operating cabin crew member is adequate for the conduct of duties required of a senior cabin crew member. The selected cabin crew member should have operational experience on the concerned aircraft type/variant.

GM1 ORO.CC.200(e) Senior cabin crew member

ED Decision 2015/005/R

REPLACEMENT OF INCAPACITATED OR UNAVAILABLE SENIOR CABIN CREW MEMBER BY ANOTHER SENIOR CABIN CREW MEMBER

To ensure that another senior cabin crew member is assigned without undue delay, the operator should take appropriate measures. These include, but are not limited to, the following:

- (a) to ensure that a flight or series of flights do not depart from an aerodrome where a senior cabin crew member is available or can be made available, the operator may:
 - (1) appoint a senior cabin crew member originally assigned to another flight and who is available at the concerned base or stopover (layover) point if the reporting time for that flight provides sufficient time to find a replacement; or
 - (2) assign a senior cabin crew member who is on standby to operate the flight or to position to the destination where the nominated senior cabin crew member has become incapacitated or unavailable to operate;
- (b) the operator should utilise another senior cabin crew member if she/he is among the operating crew on the same flight;
- (c) in case of unavailable senior cabin crew member, the operator should use the available time and resources to replace him/her at the stopover (layover) point with another senior cabin crew member;
- (d) the operator should consider including the identification of the most appropriately qualified cabin crew member in pre-flight briefings.

GM2 ORO.CC.200(e) Senior cabin crew member

ED Decision 2015/005/R

FLIGHT OR SERIES OF FLIGHTS

Flight or series of flights refers to a period that commences when a cabin crew member is required to report for duty, which includes a sector or a series of sectors, and finishes when the aircraft finally comes to rest and the engines are shut down, at the end of the last sector on which the cabin crew member acts as an operating crew member.

ORO.CC.205 Reduction of the number of cabin crew members during ground operations and in unforeseen circumstances

Regulation (EU) 2019/1384

- (a) Whenever passengers are on board an aircraft, the minimum number of cabin crew members required in accordance with point [ORO.CC.100](#) shall be present in the aircraft and ready to act.
- (b) By way of derogation from point (a), the minimum number of cabin crew members may be reduced in either of the following cases:
 - (1) during normal ground operations not involving refuelling or defuelling when the aircraft is at its parking station;
 - (2) in unforeseen circumstances if the number of passengers carried on the flight is reduced. In this case, a report shall be submitted to the competent authority after completion of the flight;
 - (3) for the purpose of providing in-flight rest during the cruise phase, either in accordance with point [ORO.FTL.205\(e\)](#) or as a fatigue mitigation implemented by the operator.
- (c) For the purposes of points (b)(1) and (b)(2), the operator's procedures of the operations manual shall ensure that:
 - (1) an equivalent level of safety is achieved with the reduced number of cabin crew members, in particular for evacuation of passengers;
 - (2) despite the reduced number of cabin crew members a senior cabin crew member is present in accordance with point [ORO.CC.200](#);
 - (3) at least one cabin crew member is required for every 50, or fraction of 50, passengers present on the same deck of the aircraft;
 - (4) in the case of normal ground operations with aircraft requiring more than one cabin crew member, the number determined in accordance with point (3) shall be increased by one cabin crew member per each pair of floor level emergency exits.
- (d) For the purposes of point (b)(3), the operator shall:
 - (1) conduct a risk assessment to determine the number of cabin crew members who are to be present and ready to act at all times during cruise;
 - (2) identify measures to mitigate the effects of having a lower number of cabin crew members being present and ready to act during cruise;
 - (3) establish in the operations manual specific procedures, including for the in-flight rest of the senior cabin crew member, that ensure at all times appropriate passenger handling and efficient management of any abnormal or emergency situations;
 - (4) specify, in the flight time specification scheme in accordance with point [ORO.FTL.125](#), the conditions under which in-flight rest may be provided to the cabin crew members.

GM1 ORO.CC.205(a) Reduction of the number of cabin crew members during ground operations and in unforeseen circumstances

ED Decision 2019/019/R

CABIN CREW PRESENT AND READY TO ACT

'Present and ready to act' means that cabin crew members should be awake and in a state of alertness that enables them to fulfil their responsibilities and perform their duties as required by any situation in accordance with all applicable normal and emergency procedures established in the operations manual.

GM1 ORO.CC.205(b)(2) Reduction of the number of cabin crew during ground operations and in unforeseen circumstances

ED Decision 2015/005/R

UNFORESEEN CIRCUMSTANCES

Unforeseen circumstances in this context refer to incapacitation and unavailability of a senior cabin crew member or a cabin crew member as follows:

- (a) 'Incapacitation' means a sudden degradation of medical fitness that occurs during flight duty period either in-flight or during a flight transit of the same flight duty period away from operator's base and that precludes the senior cabin crew member or cabin crew member from performing his/her duties. Incapacitation prior to dispatch of the aircraft from a base of the operator does not substantiate a reduction of the cabin crew complement below the minimum required.
- (b) 'Unavailability' means circumstances at a stopover (layover) destination that preclude the senior cabin crew member or cabin crew member from reporting for the flight duty period, such as traffic jams that prevent the senior cabin crew member or cabin crew member from presenting himself/herself at the crew pick-up point in time, difficulties with local authorities, health problems, death, etc. Unavailability does not refer to insufficient number or absence of cabin crew members on standby, or absence from work due to pregnancy, maternity/paternity leave, parental leave, medical leave, sick leave, or any other absence from work.

AMC1 ORO.CC.205(c)(1) Reduction of the number of cabin crew members during ground operations and in unforeseen circumstances

ED Decision 2019/019/R

PROCEDURES WITH REDUCED NUMBER OF CABIN CREW

- (a) During ground operations, if reducing the applicable minimum required number of cabin crew, the operator should ensure that the procedures required by [ORO.CC.205\(c\)\(1\)](#) specify that:
 - (1) electrical power is available on the aircraft;
 - (2) a means of initiating an evacuation is available to the senior cabin crew member or at least one member of the flight crew is in the flight crew compartment;
 - (3) cabin crew stations and associated duties are specified in the operations manual; and

- (4) cabin crew remain aware of the position of servicing and loading vehicles at and near the exits.
Additionally, in the case of passengers' embarkation:
 - (5) the senior cabin crew member should have performed the pre-boarding safety briefing to the cabin crew; and
 - (6) the pre-boarding cabin checks should have been completed.
- (b) If, in unforeseen circumstances, the number of cabin crew members is reduced below the applicable minimum required number, for example in the event of incapacitation or unavailability of cabin crew, the procedures established for this purpose in the operations manual should take into consideration at least the following:
- (1) reduction of passenger numbers;
 - (2) reseating of passengers with due regard to doors/exits and other applicable limitations; and
 - (3) relocation of cabin crew taking into account the factors specified in [AMC1 ORO.CC.100](#) and any change of procedures.

AMC1 ORO.CC.205(d) Reduction of the number of cabin crew members during ground operations and in unforeseen circumstances

ED Decision 2019/019/R

RISK ASSESSMENT FOR CRUISE PHASE OPERATION WITH A LOWER NUMBER OF CABIN CREW MEMBERS

When conducting the risk assessment required under [ORO.CC.205\(d\)](#), the operator should:

- (a) assess the risks as relevant to the type and duration of the flight to be operated, aeroplane type, cabin configuration, passenger seating capacity, the number and qualification of the operating cabin crew members, and the particular flight duty period (FDP);
- (b) determine how many cabin crew members should be present and ready to act at any time to realistically manage the normal and emergency procedures to be applied during cruise; and
- (c) evaluate the time and conditions necessary for the cabin crew members taking in-flight rest to reach their assigned cabin crew stations in case of an emergency.

AMC2 ORO.CC.205(d) Reduction of the number of cabin crew members during ground operations and in unforeseen circumstances

ED Decision 2019/019/R

SPECIFIC PROCEDURES FOR CRUISE PHASE OPERATION WITH A LOWER NUMBER OF CABIN CREW MEMBERS IN THE PASSENGER COMPARTMENT

- (a) When establishing the specific procedures for cruise phase operation with a lower number of cabin crew members in the passenger compartment, the operator should at least consider the following:
 - (1) Normal procedures including at least:

- (i) surveillance of the passenger compartment, including the lavatories and the galleys;
 - (ii) management of, and assistance to, passengers;
 - (iii) crew communication and coordination, including the necessary contact with and support to the flight crew as specified by the operator.
- (2) Emergency procedures including at least those to be applied in case of:
- (i) medical emergency;
 - (ii) unruly behaviour;
 - (iii) unlawful interference or bomb threat;
 - (iv) slow depressurisation;
 - (v) decompression;
 - (vi) fire or smoke event;
 - (vii) emergency descent, taking into account that the procedure to be applied may vary depending on the causing event (e.g. depressurisation or fire).
- (c) Specific procedures for cruise phase operation with a lower number of cabin crew should describe:
- (1) how to re-assign duties and responsibilities of cabin crew members or senior crew members who take in-flight rest to another cabin crew member considering the experience and qualification of the cabin crew member or senior cabin crew member; and
 - (2) how cabin crew members taking in-flight rest can be again ready to act and reach their assigned cabin crew stations in case of an emergency.

ORO.CC.210 Additional conditions for assignment to duties

Regulation (EU) No 965/2012

Cabin crew members shall only be assigned to duties, and operate, on a particular aircraft type or variant if they:

- (a) hold a valid attestation issued in accordance with Annex V (Part-CC) to Regulation (EU) No 1178/2011;
- (b) are qualified on the type or variant in accordance with this Subpart;
- (c) comply with the other applicable requirements of this Subpart and Annex IV (Part-CAT);
- (d) wear the operator's cabin crew uniform.

GM1 ORO.CC.210(d) Additional conditions for assignment to duties

ED Decision 2014/017/R

OPERATOR'S CABIN CREW UNIFORM

The uniform to be worn by operating cabin crew should be such as not to impede the performance of their duties, as required for the safety of passengers and flight during operations, and should allow passengers to identify the operating cabin crew including in an emergency situation.

ORO.CC.215 Training and checking programs and related documentation

Regulation (EU) No 965/2012

- (a) Training and checking programmes including syllabi required by this Subpart shall be approved by the competent authority and specified in the operations manual.
- (b) After a cabin crew member has successfully completed a training course and the associated check, the operator shall:
 - (1) update the cabin crew member’s training records in accordance with [ORO.MLR.115](#); and
 - (2) provide him/her with a list showing updated validity periods as relevant to the aircraft type(s) and variant(s) on which the cabin crew member is qualified to operate.

GM1 ORO.CC.215(b)(2) Training and checking programmes and related documentation

ED Decision 2014/017/R

LIST OF AIRCRAFT TYPE/VARIANT QUALIFICATION(S)

When providing the updated validity list of aircraft type/variant qualifications to cabin crew members having successfully completed a training course and the associated checking, the operator may use the following format. If using another format, at least the elements in (a) to (d) and in columns (1) and (2) should be indicated to show validity of qualification(s).

CABIN CREW AIRCRAFT TYPE/VARIANT QUALIFICATION(S)							
(a)	Reference number of the cabin crew attestation:						
(b)	Cabin crew attestation holder’s full name: The above-mentioned person may act as an operating cabin crew member during flight operations only if his/her aircraft type and/or variant qualification(s) listed below, and dated DD/MM/YYYY, comply with the applicable validity period(s) specified in Part-ORO.						
(c)	Issuing organisation: (name, postal address, AOC and/or approval reference number and stamp or logo)						
(d)	Date of issue: (DD/MM/YYYY)						
(1)	(2)	(3)	(4)	(5)	(6)	(7)	(8)
	Qualification valid until	Aircraft type specific training	Operator conversion training	Differences training If relevant	Familiari- sation	Last recurrent training	Refresher training If relevant
A/C type 1							
Variant ...							
A/C type 2							
Variant ...							
A/C type 3							
Variant ...							
If approved A/C type 4							

ORO.CC.250 Operation on more than one aircraft type or variant

Regulation (EU) No 71/2014

- (a) A cabin crew member shall not be assigned to operate on more than three aircraft types, except that, with the approval of the competent authority, the cabin crew member may be assigned to operate on four aircraft types if for at least two of the types:
- (1) safety and emergency equipment and type-specific normal and emergency procedures are similar; and
 - (2) non-type-specific normal and emergency procedures are identical.
- (b) For the purpose of (a) and for cabin crew training and qualifications, the operator shall determine:
- (1) each aircraft as a type or a variant taking into account, where available, the relevant elements defined in the mandatory part of the operational suitability data established in accordance with Regulation (EU) No 748/2012 for the relevant aircraft type or variant; and
 - (2) variants of an aircraft type to be different types if they are not similar in the following aspects:
 - (i) emergency exit operation;
 - (ii) location and type of portable safety and emergency equipment;
 - (iii) type-specific emergency procedures.

AMC1 ORO.CC.250(b) Operation on more than one aircraft type or variant

ED Decision 2014/017/R

DETERMINATION OF AIRCRAFT TYPES AND VARIANTS

- (a) When determining similarity of location and type of portable safety and emergency equipment, the following factors should be assessed:
- (1) all portable safety and emergency equipment is stowed in the same, or in exceptional circumstances, in substantially the same location;
 - (2) all portable safety and emergency equipment requires the same method of operation;
 - (3) portable safety and emergency equipment includes:
 - (i) fire-fighting equipment;
 - (ii) protective breathing equipment (PBE);
 - (iii) oxygen equipment;
 - (iv) crew life-jackets;
 - (v) torches;
 - (vi) megaphones;
 - (vii) first-aid equipment;
 - (viii) survival and signalling equipment; and
 - (ix) other safety and emergency equipment, where applicable.

- (b) The type-specific emergency procedures to be considered should include at least the following:
- (1) land and water evacuation;
 - (2) in-flight fire;
 - (3) non-pressurisation, slow and sudden decompression; and
 - (4) pilot incapacitation.
- (c) When determining similarity of doors/exits in the absence of operational suitability data established in accordance with Commission Regulation (EU) No 748/2012 for the relevant aircraft type(s) or variant(s), the following factors should be assessed, except for self-help exits, such as type III and type IV exits, that need not be included in the assessment:
- (1) door/exit arming and disarming;
 - (2) direction of movement of the operating handle;
 - (3) direction of door/exit opening;
 - (4) power assist mechanisms; and
 - (5) assisting evacuation means.

GM1 ORO.CC.250 Operation on more than one aircraft type or variant

ED Decision 2014/017/R

SAFETY BRIEFING FOR CABIN CREW

When changing aircraft type or variant during a series of flight sectors, the cabin crew safety briefing should include a representative sample of type-specific normal and emergency procedures and safety and emergency equipment applicable to the actual aircraft to be operated for the immediately subsequent flight sector.

ORO.CC.255 Single cabin crew member operations

Regulation (EU) No 965/2012

- (a) The operator shall select, recruit, train and check the proficiency of cabin crew members to be assigned to single cabin crew member operations according to criteria appropriate to this type of operation.
- (b) Cabin crew members who have no previous operating experience as single cabin crew member shall only be assigned to such type of operation after they have:
- (1) completed training as required in (c) in addition to other applicable training and checking required by this Subpart;
 - (2) successfully passed the checks verifying their proficiency in discharging their duties and responsibilities in accordance with the procedures specified in the operations manual; and
 - (3) undertaken familiarisation flying of at least 20 hours and 15 sectors on the relevant aircraft type under the supervision of an appropriately experienced cabin crew member.

- (c) The following additional training elements shall be covered with particular emphasis to reflect single cabin crew operations:
- (1) responsibility to the commander for the conduct of normal and emergency procedures;
 - (2) importance of coordination and communication with the flight crew, in particular when managing unruly or disruptive passengers;
 - (3) review of operator requirements and legal requirements;
 - (4) documentation;
 - (5) accident and incident reporting; and
 - (6) flight and duty time limitations and rest requirements.

SUBPART TC: TECHNICAL CREW IN HEMS, HHO OR NVIS OPERATIONS

ORO.TC.100 Scope

Regulation (EU) No 965/2012

This Subpart establishes the requirements to be met by the operator when operating an aircraft with technical crew members in commercial air transport helicopter emergency medical service (HEMS), night vision imaging system (NVIS) operations or helicopter hoist operations (HHO).

ORO.TC.105 Conditions for assignment to duties

Regulation (EU) No 965/2012

- (a) Technical crew members in commercial air transport HEMS, HHO or NVIS operations shall only be assigned duties if they:
 - (1) are at least 18 years of age;
 - (2) are physically and mentally fit to safely discharge assigned duties and responsibilities;
 - (3) have completed all applicable training required by this Subpart to perform the assigned duties;
 - (4) have been checked as proficient to perform all assigned duties in accordance with the procedures specified in the operations manual.
- (b) Before assigning to duties technical crew members who are self-employed and/or working on a freelance or part-time basis, the operator shall verify that all applicable requirements of this Subpart are complied with, taking into account all services rendered by the technical crew member to other operator(s) to determine in particular:
 - (1) the total number of aircraft types and variants operated;
 - (2) the applicable flight and duty time limitations and rest requirements.

GM1 ORO.TC.105 Conditions for assignment to duties

ED Decision 2014/017/R

GENERAL

- (a) The technical crew member in HEMS, HHO or NVIS operations should undergo an initial medical examination or assessment and, if applicable, a re-assessment before undertaking duties.
- (b) Any medical assessment or re-assessment should be carried out according to best aero-medical practice by a medical practitioner who has sufficiently detailed knowledge of the applicant's medical history.
- (c) The operator should maintain a record of medical fitness for each technical crew member.
- (d) Technical crew members should:
 - (1) be in good health;
 - (2) be free from any physical or mental illness that might lead to incapacitation or inability to perform crew duties;
 - (3) have normal cardio-respiratory function;

- (4) have normal central nervous system;
- (5) have adequate visual acuity 6/9 with or without glasses;
- (6) have adequate hearing; and
- (7) have normal function of ear, nose and throat.

ORO.TC.110 Training and checking

Regulation (EU) No 965/2012

- (a) The operator shall establish a training programme in accordance with the applicable requirements of this Subpart to cover the duties and responsibilities to be performed by technical crew members.
- (b) Following the completion of initial, operator conversion, differences and recurrent training, each technical crew member shall undergo a check to demonstrate their proficiency in carrying out normal and emergency procedures.
- (c) Training and checking shall be conducted for each training course by personnel suitably qualified and experienced in the subject to be covered. The operator shall inform the competent authority about the personnel conducting the checks.

AMC1 ORO.TC.110 Training and checking

ED Decision 2014/017/R

GENERAL

- (a) Elements of training that require individual practice may be combined with practical checks.
- (b) The checks should be accomplished by the method appropriate to the type of training including:
 - (1) practical demonstration;
 - (2) computer-based assessment;
 - (3) in-flight checks; and/or
 - (4) oral or written tests.

AMC1 ORO.TC.110(a) Training and checking

ED Decision 2015/022/R

CRM TRAINING

The technical crew training programme for initial, operator conversion and recurrent training should include relevant CRM training elements as specified in [AMC1 ORO.FC.115](#).

ORO.TC.115 Initial training

Regulation (EU) No 965/2012

Before undertaking the operator conversion training, each technical crew member shall complete initial training, including:

- (a) general theoretical knowledge on aviation and aviation regulations covering all elements relevant to the duties and responsibilities required of technical crew;
- (b) fire and smoke training;

- (c) survival training on ground and in water, appropriate to the type and area of operation;
- (d) aero-medical aspects and first-aid;
- (e) communication and relevant CRM elements of [ORO.FC.115](#) and [ORO.FC.215](#).

AMC1 ORO.TC.115 Initial training

ED Decision 2015/022/R

ELEMENTS

- (a) The elements of initial training mentioned in [ORO.TC.115](#) should include in particular:
 - (1) General theoretical knowledge on aviation and aviation regulations relevant to duties and responsibilities:
 - (i) the importance of crew members performing their duties in accordance with the operations manual;
 - (ii) continuing competence and fitness to operate as a crew member with special regard to flight and duty time limitations and rest requirements;
 - (iii) an awareness of the aviation regulations relating to crew members and the role of the competent and inspecting authority;
 - (iv) general knowledge of relevant aviation terminology, theory of flight, passenger distribution, meteorology and areas of operation;
 - (v) pre-flight briefing of the crew members and the provision of necessary safety information with regard to their specific duties;
 - (vi) the importance of ensuring that relevant documents and manuals are kept up-to-date with amendments provided by the operator;
 - (vii) the importance of identifying when crew members have the authority and responsibility to initiate an evacuation and other emergency procedures; and
 - (viii) the importance of safety duties and responsibilities and the need to respond promptly and effectively to emergency situations.
 - (2) Fire and smoke training:
 - (i) reactions to emergencies involving fire and smoke and identification of the fire sources;
 - (ii) the classification of fires and the appropriate type and techniques of application of extinguishing agents, the consequences of misapplication, and of use in a confined space; and
 - (iii) the general procedures of ground-based emergency services at aerodromes.
 - (3) When conducting extended overwater operations, water survival training, including the use of personal flotation equipment.
 - (4) Before first operating on an aircraft fitted with life-rafts or other similar equipment, training on the use of this equipment, including practice in water.
 - (5) Survival training appropriate to the areas of operation (e.g. polar, desert, jungle, sea or mountain).

- (6) Aero-medical aspects and first aid, including:
 - (i) instruction on first aid and the use of first-aid kits; and
 - (ii) the physiological effects of flying.
- (7) Effective communication between technical crew members and flight crew members, including common language and terminology.

ORO.TC.120 Operator conversion training

Regulation (EU) No 965/2012

Each technical crew member shall complete:

- (a) operator conversion training, including relevant CRM elements,
 - (1) before being first assigned by the operator as a technical crew member; or
 - (2) when changing to a different aircraft type or class, if any of the equipment or procedures mentioned in (b) are different.
- (b) Operator conversion training shall include:
 - (1) the location and use of all safety and survival equipment carried on the aircraft;
 - (2) all normal and emergency procedures;
 - (3) on-board equipment used to carry out duties in the aircraft or on the ground for the purpose of assisting the pilot during HEMS, HHO or NVIS operations.

AMC1 ORO.TC.120&.125 Operator conversion training and differences training

ED Decision 2014/017/R

ELEMENTS

- (a) Operator conversion training mentioned in [ORO.TC.120\(b\)](#) and differences training mentioned in [ORO.TC.125\(a\)](#) should include the following:
 - (1) Fire and smoke training, including practical training in the use of all fire fighting equipment as well as protective clothing representative of that carried in the aircraft. Each technical crew member should:
 - (i) extinguish a fire characteristic of an aircraft interior fire except that, in the case of Halon extinguishers, an alternative extinguishing agent may be used; and
 - (ii) practise the donning and use of protective breathing equipment (when fitted) in an enclosed, simulated smoke-filled environment.
 - (2) Practical training on operating and opening all normal and emergency exits for passenger evacuation in an aircraft or representative training device and demonstration of the operation of all other exits.
 - (3) Evacuation procedures and other emergency situations, including:
 - (i) recognition of planned or unplanned evacuations on land or water — this training should include recognition of unusable exits or unserviceable evacuation equipment;
 - (ii) in-flight fire and identification of fire source; and

- (iii) other in-flight emergencies.
- (4) When the flight crew is more than one, training on assisting if a pilot becomes incapacitated, including a demonstration of:
 - (i) the pilot's seat mechanism;
 - (ii) fastening and unfastening the pilot's seat restraint system;
 - (iii) use of the pilot's oxygen equipment, when applicable; and
 - (iv) use of pilots' checklists.
- (5) Training on, and demonstration of, the location and use of safety equipment, including the following:
 - (i) life rafts, including the equipment attached to, and/or carried in, the raft, where applicable;
 - (ii) life jackets, infant life jackets and flotation devices, where applicable;
 - (iii) fire extinguishers;
 - (iv) crash axe or crow bar;
 - (v) emergency lights, including portable lights;
 - (vi) communication equipment, including megaphones;
 - (vii) survival packs, including their contents;
 - (viii) pyrotechnics (actual or representative devices);
 - (ix) first-aid kits, their contents and emergency medical equipment; and
 - (x) other safety equipment or systems, where applicable.
- (6) Training on passenger briefing/safety demonstrations and preparation of passengers for normal and emergency situations.
- (7) Training on the use of dangerous goods, if applicable.
- (8) Task-specific training.

AMC2 ORO.TC.120&.125 Operator conversion training and differences training

ED Decision 2014/017/R

GENERAL

- (a) The operator should determine the content of the conversion or differences training taking account of the technical crew member's previous training as documented in the technical crew member's training records.
- (b) Aircraft conversion or differences training should be conducted according to a syllabus and include the use of relevant equipment and emergency procedures and practice on a representative training device or on the actual aircraft.
- (c) The operator should specify in the operations manual the maximum number of types or variants that can be operated by a technical crew member.

ORO.TC.125 Differences training

Regulation (EU) No 965/2012

- (a) Each technical crew member shall complete differences training when changing equipment or procedures on types or variants currently operated.
- (b) The operator shall specify in the operations manual when such differences training is required.

ORO.TC.130 Familiarisation flights

Regulation (EU) No 965/2012

Following completion of the operator conversion training, each technical crew member shall undertake familiarisation flights prior to operating as a required technical crew member in HEMS, HHO or NVIS operations.

ORO.TC.135 Recurrent training

Regulation (EU) No 965/2012

- (a) Within every 12-month period, each technical crew member shall undergo recurrent training relevant to the type or class of aircraft and equipment that the technical crew member operates. Elements of CRM shall be integrated into all appropriate phases of the recurrent training.
- (b) Recurrent training shall include theoretical and practical instruction and practice.

AMC1 ORO.TC.135 Recurrent training

ED Decision 2014/017/R

ELEMENTS

- (a) The 12-month period mentioned in [ORO.TC.135\(a\)](#) should be counted from the last day of the month when the first checking was made. Further training and checking should be undertaken within the last 3 calendar months of that period. The new 12-month period should be counted from the original expiry date.
- (b) The recurrent practical training should include every year:
 - (1) emergency procedures, including pilot incapacitation;
 - (2) evacuation procedures;
 - (3) touch-drills by each technical crew member for opening normal and emergency exits for (passenger) evacuation;
 - (4) the location and handling of emergency equipment and the donning by each technical crew member of life jackets and protective breathing equipment (PBE), when applicable;
 - (5) first aid and the contents of the first-aid kit(s);
 - (6) stowage of articles in the cabin;
 - (7) use of dangerous goods, if applicable;
 - (8) incident and accident review; and
 - (9) crew resource management: all major topics of the initial CRM training should be covered over a period not exceeding 3 years.

- (c) Recurrent training should include every 3 years:
- (1) practical training on operating and opening all normal and emergency exits for passenger evacuation in an aircraft or representative training device and demonstration of the operation of all other exits;
 - (2) practical training in the use of all firefighting equipment as well as protective clothing representative of that carried in the aircraft. Each technical crew member should:
 - (i) extinguish a fire characteristic of an aircraft interior fire except that, in the case of Halon extinguishers, an alternative extinguishing agent may be used; and
 - (ii) practise the donning and use of protective breathing equipment (when fitted) in an enclosed, simulated smoke-filled environment;
 - (3) use of pyrotechnics (actual or representative devices); and
 - (4) demonstration of the use of the life raft, where fitted.

ORO.TC.140 Refresher training

Regulation (EU) No 965/2012

- (a) Each technical crew member who has not undertaken duties in the previous six months shall complete the refresher training specified in the operations manual.
- (b) The technical crew member who has not performed flying duties on one particular aircraft type or class during the preceding six months shall, before being assigned on that type or class, complete either:
 - (1) refresher training on the type or class; or
 - (2) two familiarisation sectors on the aircraft type or class.

AMC1 ORO.TC.140 Refresher training

ED Decision 2014/017/R

ELEMENTS

- (a) Refresher training may include familiarisation flights.
- (b) Refresher training should include at least the following:
 - (1) emergency procedures, including pilot incapacitation;
 - (2) evacuation procedures;
 - (3) practical training on operating and opening all normal and emergency exits for passenger evacuation in an aircraft or representative training device and demonstration of the operation of all other exits; and
 - (4) the location and handling of emergency equipment, and the donning of life jackets and protective breathing equipment, when applicable.

SUBPART FTL: FLIGHT AND DUTY TIME LIMITATIONS AND REST REQUIREMENTS

SECTION 1 – GENERAL

ORO.FTL.100 Scope

Regulation (EU) No 83/2014

This Subpart establishes the requirements to be met by an operator and its crew members with regard to flight and duty time limitations and rest requirements for crew members.

ORO.FTL.105 Definitions

Regulation (EU) 2018/1975

For the purpose of this Subpart, the following definitions shall apply:

- (1) ‘acclimatised’ means a state in which a crew member’s circadian biological clock is synchronised to the time zone where the crew member is. A crew member is considered to be acclimatised to a 2-hour wide time zone surrounding the local time at the point of departure. When the local time at the place where a duty commences differs by more than 2 hours from the local time at the place where the next duty starts, the crew member, for the calculation of the maximum daily flight duty period, is considered to be acclimatised in accordance with the values in the Table 1.

Table 1

Time difference (h) between reference time and local time where the crew member starts the next duty	Time elapsed since reporting at reference time				
	<48	48–71:59	72–95:59	96–119:59	≥120
< 4	B	D	D	D	D
≤6	B	X	D	D	D
≤9	B	X	X	D	D
≤12	B	X	X	X	D

‘B’ means acclimatised to the local time of the departure time zone,

‘D’ means acclimatised to the local time where the crew member starts his/her next duty, and

‘X’ means that a crew member is in an unknown state of acclimatisation.

- (2) ‘reference time’ means the local time at the reporting point situated in a 2-hour wide time zone band around the local time where a crew member is acclimatised;
- (3) ‘accommodation’ means, for the purpose of standby and split duty, a quiet and comfortable place not open to the public with the ability to control light and temperature, equipped with adequate furniture that provides a crew member with the possibility to sleep, with enough capacity to accommodate all crew members present at the same time and with access to food and drink;
- (4) ‘suitable accommodation’ means, for the purpose of standby, split duty and rest, a separate room for each crew member located in a quiet environment and equipped with a bed, which is

- sufficiently ventilated, has a device for regulating temperature and light intensity, and access to food and drink;
- (5) 'augmented flight crew' means a flight crew which comprises more than the minimum number required to operate the aircraft, allowing each flight crew member to leave the assigned post, for the purpose of in-flight rest, and to be replaced by another appropriately qualified flight crew member;
 - (6) 'break' means a period of time within an flight duty period, shorter than a rest period, counting as duty and during which a crew member is free of all tasks;
 - (7) 'delayed reporting' means the postponement of a scheduled FDP by the operator before a crew member has left the place of rest;
 - (8) 'disruptive schedule' means a crew member's roster which disrupts the sleep opportunity during the optimal sleep time window by comprising an FDP or a combination of FDPs which encroach, start or finish during any portion of the day or of the night where a crew member is acclimatised. A schedule may be disruptive due to early starts, late finishes or night duties.
 - (a) 'early type' of disruptive schedule means:
 - (i) for 'early start' a duty period starting in the period between 05:00 and 05:59 in the time zone to which a crew member is acclimatised, and
 - (ii) for 'late finish' a duty period finishing in the period between 23:00 and 01:59 in the time zone to which a crew member is acclimatised;
 - (b) 'late type' of disruptive schedule means:
 - (i) for 'early start' a duty period starting in the period between 05:00 and 06:59 in the time zone to which a crew member is acclimatised; and
 - (ii) for 'late finish' a duty period finishing in the period between 00:00 and 01:59 in the time zone to which a crew member is acclimatised;
 - (9) 'night duty' means a duty period encroaching any portion of the period between 02:00 and 04:59 in the time zone to which the crew is acclimatised;
 - (10) 'duty' means any task that a crew member performs for the operator, including flight duty, administrative work, giving or receiving training and checking, positioning, and some elements of standby;
 - (11) 'duty period' means a period which starts when a crew member is required by an operator to report for or to commence a duty and ends when that person is free of all duties, including post-flight duty;
 - (12) 'flight duty period ('FDP')' means a period that commences when a crew member is required to report for duty, which includes a sector or a series of sectors, and finishes when the aircraft finally comes to rest and the engines are shut down, at the end of the last sector on which the crew member acts as an operating crew member;
 - (13) 'flight time' means, for aeroplanes, the time between an aircraft first moving from its parking place for the purpose of taking off until it comes to rest on the designated parking position and all engines or propellers are shut down.
 - (14) 'home base' means the location, assigned by the operator to the crew member, from where the crew member normally starts and ends a duty period or a series of duty periods and where, under normal circumstances, the operator is not responsible for the accommodation of the crew member concerned;

- (15) 'local day' means a 24-hour period commencing at 00:00 local time;
- (16) 'local night' means a period of 8 hours falling between 22:00 and 08:00 local time;
- (17) 'operating crew member' means a crew member carrying out duties in an aircraft during a sector;
- (18) 'positioning' means the transferring of a non-operating crew member from one place to another, at the behest of the operator, excluding:
- the time of travel from a private place of rest to the designated reporting place at home base and vice versa, and
 - the time for local transfer from a place of rest to the commencement of duty and vice versa;
- (19) 'rest facility' means a bunk or seat with leg and foot support suitable for crew members' sleeping on board an aircraft.
- (20) 'reserve' means a period of time during which a crew member is required by the operator to be available to receive an assignment for an FDP, positioning or other duty notified at least 10 hours in advance.
- (21) 'rest period' means a continuous, uninterrupted and defined period of time, following duty or prior to duty, during which a crew member is free of all duties, standby and reserve.
- (22) 'rotation' is a duty or a series of duties, including at least one flight duty, and rest periods out of home base, starting at home base and ending when returning to home base for a rest period where the operator is no longer responsible for the accommodation of the crew member.
- (23) 'single day free of duty' means, for the purpose of complying with the provisions of Council Directive 2000/79/EC, a time free of all duties and standby consisting of one day and two local nights, which is notified in advance. A rest period may be included as part of the single day free of duty.
- (24) 'sector' means the segment of an FDP between an aircraft first moving for the purpose of taking off until it comes to rest after landing on the designated parking position.
- (25) 'standby' means a pre-notified and defined period of time during which a crew member is required by the operator to be available to receive an assignment for a flight, positioning or other duty without an intervening rest period.
- (26) 'airport standby' means a standby performed at the airport;
- (27) 'other standby' means a standby either at home or in a suitable accommodation;
- (28) 'window of circadian low ('WOCL') means the period between 02:00 and 05:59 hours in the time zone to which a crew member is acclimatised.

GM1 ORO.FTL.105(1) Definitions

ED Decision 2019/019/R

ACCLIMATISED

- (a) A crew member remains acclimatised to the local time of his or her reference time during 47 hours 59 minutes after reporting no matter how many time zones he/she has crossed.
- (b) The maximum daily FDP for acclimatised crew members is determined by using table 1 of [ORO.FTL.205\(b\)\(1\)](#) with the reference time of the point of departure. As soon as 48 hours have

elapsed, the state of acclimatisation is derived from the time elapsed since reporting at reference time and the number of time zones crossed.

- (c) A crew member is considered to be in an unknown state of acclimatisation after the first 48 hours of the rotation have elapsed unless he or she remains in the first arrival destination time zone (either for rest or any duties) in accordance with the table in [ORO.FTL.105\(1\)](#).
- (d) Should a crew member's rotation include additional duties that end in a different time zone than his or her first arrival destination's time zone while he or she is considered to be in an unknown state of acclimatisation, then the crew member remains in an unknown state of acclimatisation until he or she:
 - (1) has taken the rest period required by [CS FTL.1.235\(b\)\(3\)](#) at home base;
 - (2) has taken the rest period required by [CS FTL.1.235\(b\)\(3\)](#) at the new location; or
 - (3) has been undertaking duties starting at and returning to the time zone of the new location until he or she becomes acclimatised in accordance with the values in the table in [ORO.FTL.105\(1\)](#).

To determine the state of acclimatisation, the two following criteria should be applied:

- (i) the greater of the time differences between the time zone where he or she was last acclimatised or the local time of his or her last departure point and the new location; and
- (ii) the time elapsed since reporting at home base for the first time during the rotation.

GM2 ORO.FTL.105(1) Definitions

ED Decision 2014/017/R

ACCLIMATISED 'POINT OF DEPARTURE'

The point of departure refers to the reporting point for a flight duty period or positioning duty after a rest period.

GM3 ORO.FTL.105(1) Definitions

ED Decision 2014/017/R

ACCLIMATISED 'TIME ELAPSED SINCE REPORTING AT REFERENCE TIME'

The time elapsed since reporting at reference time for operations applying CS FTL.1.235(b)(3)(ii) at home base refers to the time elapsed since reporting for the first time at home base for a rotation.

GM1 ORO.FTL.105(2) Definitions

ED Decision 2014/017/R

REFERENCE TIME

- (a) Reference time refers to reporting points in a 2-hour wide time zone band around the local time where a crew member is acclimatised.
- (b) Example: A crew member is acclimatised to the local time in Helsinki and reports for duty in London. The reference time is the local time in London.

GM1 ORO.FTL.105(3) Definitions

ED Decision 2014/017/R

ADEQUATE FURNITURE FOR 'ACCOMMODATION'

Adequate furniture for crew member accommodation should include a seat that reclines at least 45° back angle to the vertical, has a seat width of at least 20 inches (50cm) and provides leg and foot support.

GM1 ORO.FTL.105(8) Definitions

ED Decision 2014/017/R

DETERMINATION OF DISRUPTIVE SCHEDULES

If a crew member is acclimatised to the local time at his/her home base, the local time at the home base should be used to consider an FDP as 'disruptive schedule'. This applies to operations within the 2-hour wide time zone surrounding the local time at the home base, if a crew member is acclimatised to the local time at his/her home base.

GM1 ORO.FTL.105(10) Definitions

ED Decision 2014/017/R

ELEMENTS OF STANDBY FOR DUTY

[ORO.FTL.225\(c\)](#) and (d) and [CS FTL.1.225\(b\)\(2\)](#) determine which elements of standby count as duty.

GM1 ORO.FTL.105(17) Definitions

ED Decision 2014/017/R

OPERATING CREW MEMBER

A person on board an aircraft is either a crew member or a passenger. If a crew member is not a passenger on board an aircraft he/she should be considered as 'carrying out duties'. The crew member remains an operating crew member during in-flight rest. In-flight rest counts in full as FDP, and for the purpose of [ORO.FTL.210](#).

ORO.FTL.110 Operator responsibilities

Regulation (EU) No 83/2014

An operator shall:

- (a) publish duty rosters sufficiently in advance to provide the opportunity for crew members to plan adequate rest;
- (b) ensure that flight duty periods are planned in a way that enables crew members to remain sufficiently free from fatigue so that they can operate to a satisfactory level of safety under all circumstances;
- (c) specify reporting times that allow sufficient time for ground duties;
- (d) take into account the relationship between the frequency and pattern of flight duty periods and rest periods and give consideration to the cumulative effects of undertaking long duty hours combined with minimum rest periods;
- (e) allocate duty patterns which avoid practices that cause a serious disruption of an established sleep/work pattern, such as alternating day/night duties;

- (f) comply with the provisions concerning disruptive schedules in accordance with [ARO.OPS.230](#);
- (g) provide rest periods of sufficient time to enable crew members to overcome the effects of the previous duties and to be rested by the start of the following flight duty period;
- (h) plan recurrent extended recovery rest periods and notify crew members sufficiently in advance;
- (i) plan flight duties in order to be completed within the allowable flight duty period taking into account the time necessary for pre-flight duties, the sector and turnaround times;
- (j) change a schedule and/or crew arrangements if the actual operation exceeds the maximum flight duty period on more than 33% of the flight duties in that schedule during a scheduled seasonal period.

AMC1 ORO.FTL.110 Operator responsibilities

ED Decision 2014/017/R

SCHEDULING

- (a) Scheduling has an important impact on a crew member's ability to sleep and to maintain a proper level of alertness. When developing a workable roster, the operator should strike a fair balance between the commercial needs and the capacity of individual crew members to work effectively. Rosters should be developed in such a way that they distribute the amount of work evenly among those that are involved.
- (b) Schedules should allow for flights to be completed within the maximum permitted flight duty period and flight rosters should take into account the time needed for pre-flight duties, taxiing, the flight- and turnaround times. Other factors to be considered when planning duty periods should include:
 - (1) the allocation of work patterns which avoid undesirable practices such as alternating day/night duties, alternating eastward-westward or westward-eastward time zone transitions, positioning of crew members so that a serious disruption of established sleep/work patterns occurs;
 - (2) scheduling sufficient rest periods especially after long flights crossing many time zones; and
 - (3) preparation of duty rosters sufficiently in advance with planning of recurrent extended recovery rest periods and notification of the crew members well in advance to plan adequate pre-duty rest.

AMC1 ORO.FTL.110(a) Operator responsibilities

ED Decision 2014/017/R

PUBLICATION OF ROSTERS

Rosters should be published 14 days in advance.

AMC1 ORO.FTL.110(j) Operator responsibilities

ED Decision 2014/017/R

OPERATIONAL ROBUSTNESS OF ROSTERS

The operator should establish and monitor performance indicators for operational robustness of rosters.

GM1 ORO.FTL.110(j) Operator responsibilities

ED Decision 2014/017/R

OPERATIONAL ROBUSTNESS OF ROSTERS

Performance indicators for operational robustness of rosters should support the operator in the assessment of the stability of its rostering system. Performance indicators for operational robustness of rosters should at least measure how often a rostered crew pairing for a duty period is achieved within the planned duration of that duty period. Crew pairing means rostered positioning and flights for crew members in one duty period.

ORO.FTL.115 Crew member responsibilities

Regulation (EU) No 83/2014

Crew members shall:

- (a) comply with point [CAT.GEN.MPA.100\(b\)](#) of Annex IV (Part-CAT); and
- (b) make optimum use of the opportunities and facilities for rest provided and plan and use their rest periods properly.

ORO.FTL.120 Fatigue risk management (FRM)

Regulation (EU) No 83/2014

- (a) When FRM is required by this Subpart or an applicable certification specification, the operator shall establish, implement and maintain a FRM as an integral part of its management system. The FRM shall ensure compliance with the essential requirements in points 7.f., 7.g. and 8.f. of Annex IV to Regulation (EC) No 216/2008. The FRM shall be described in the operations manual.
- (b) The FRM established, implemented and maintained shall provide for continuous improvement to the overall performance of the FRM and shall include:
 - (1) a description of the philosophy and principles of the operator with regard to FRM, referred to as the FRM policy;
 - (2) documentation of the FRM processes, including a process for making personnel aware of their responsibilities and the procedure for amending this documentation;
 - (3) scientific principles and knowledge;
 - (4) a hazard identification and risk assessment process that allows managing the operational risk(s) of the operator arising from crew member fatigue on a continuous basis;
 - (5) a risk mitigation process that provides for remedial actions to be implemented promptly, which are necessary to effectively mitigate the operator's risk(s) arising from crew member fatigue and for continuous monitoring and regular assessment of the mitigation of fatigue risks achieved by such actions;
 - (6) FRM safety assurance processes;
 - (7) FRM promotion processes.
- (c) The FRM shall correspond to the flight time specification scheme, the size of the operator and the nature and complexity of its activities, taking into account the hazards and associated risks inherent in those activities and the applicable flight time specification scheme.
- (d) The operator shall take mitigating actions when the FRM safety assurance process shows that the required safety performance is not maintained.

GM1 ORO.FTL.120 Fatigue risk management (FRM)

ED Decision 2017/007/R

ICAO DOC 9966 — MANUAL FOR THE OVERSIGHT OF FATIGUE MANAGEMENT APPROACHES

Further guidance on FRM processes, appropriate fatigue management, the underlying scientific principles and operational knowledge may be found in ICAO Doc 9966 (Manual for the Oversight of Fatigue Management Approaches).

AMC1 ORO.FTL.120(b)(1) Fatigue risk management (FRM)

ED Decision 2015/005/R

CAT OPERATORS FRM POLICY

- (a) The operator's FRM policy should identify all the elements of FRM.
- (b) The FRM policy should define to which operations FRM applies.
- (c) The FRM policy should:
 - (1) reflect the shared responsibility of management, flight and cabin crew, and other involved personnel;
 - (2) state the safety objectives of FRM;
 - (3) be signed by the accountable manager;
 - (4) be communicated, with visible endorsement, to all the relevant areas and levels of the organisation;
 - (5) declare management commitment to effective safety reporting;
 - (6) declare management commitment to the provision of adequate resources for FRM;
 - (7) declare management commitment to continuous improvement of FRM;
 - (8) require that clear lines of accountability for management, flight and cabin crew, and all other involved personnel are identified; and
 - (9) require periodic reviews to ensure it remains relevant and appropriate.

AMC1 ORO.FTL.120(b)(2) Fatigue risk management (FRM)

Reserved

AMC2 ORO.FTL.120(b)(2) Fatigue risk management (FRM)

ED Decision 2014/017/R

CAT OPERATORS FRM DOCUMENTATION

The operator should develop and keep current FRM documentation that describes and records:

- (1) FRM policy and objectives;
- (2) FRM processes and procedures;
- (3) accountabilities, responsibilities and authorities for these processes and procedures;
- (4) mechanisms for on-going involvement of management, flight and cabin crew members, and all other involved personnel;

- (5) FRM training programmes, training requirements and attendance records;
- (6) scheduled and actual flight times, duty periods and rest periods with deviations and reasons for deviations; and
- (7) FRM outputs including findings from collected data, recommendations, and actions taken.

GM1 ORO.FTL.120(b)(3) Fatigue risk management (FRM)

ED Decision 2017/007/R

SCIENTIFIC METHOD

‘Scientific method’ is defined as ‘a method or procedure that has characterized natural science since the 17th century, consisting in systematic observation, measurement, and experiment, and the formulation, testing, and modification of hypotheses’.

A scientific study may be required as an element of proactive fatigue hazard identification. Such a study should be based on scientific principles, i.e. use the scientific method. That means that the study should consist of the following elements as applicable to each individual case:

- (a) an introduction with a summary and the description of the study design, methods and results;
- (b) a statement of the hypothesis being tested, how it is being tested and a conclusion as to whether the hypothesis was found to be true or not;
- (c) a description of the data collection method and tools, e.g. the sensitivity of the activity monitors, further information on any model and its limitations and how it is being used as part of the study;
- (d) a description of how the study subjects were selected and how representative of the crew member population the study group is;
- (e) a description of the rosters the study participants have worked containing data such as e.g. flight and duty hours, number of sectors, duty start/finish times;
- (f) reports on mean sleep duration and efficiency and data for other standard measures (e.g. sleep timing, self-rated sleepiness/fatigue, sources of sleep disruption, performance, safety);
- (g) a description of how sleep and the other measures varied across the roster (i.e. day-to-day) and where and why minimum sleep occurred;
- (h) statistical data analysis to test the hypothesis; and
- (i) the explanation of how the study results have been used to influence the design of the roster or other fatigue mitigations.

AMC1 ORO.FTL.120(b)(4) Fatigue risk management (FRM)

ED Decision 2015/005/R

CAT OPERATORS IDENTIFICATION OF HAZARDS

The operator should develop and maintain three documented processes for fatigue hazard identification:

- (a) Predictive

The predictive process should identify fatigue hazards by examining crew scheduling and taking into account factors known to affect sleep and fatigue and their effects on performance. Methods of examination may include, but are not limited to:

- (1) operator or industry operational experience and data collected on similar types of operations;
 - (2) evidence-based scheduling practices; and
 - (3) bio-mathematical models.
- (b) Proactive
- The proactive process should identify fatigue hazards within current flight operations. Methods of examination may include, but are not limited to:
- (1) self-reporting of fatigue risks;
 - (2) crew fatigue surveys;
 - (3) relevant flight and cabin crew performance data;
 - (4) available safety databases and scientific studies; and
 - (5) analysis of planned versus actual time worked.
- (c) Reactive
- The reactive process should identify the contribution of fatigue hazards to reports and events associated with potential negative safety consequences in order to determine how the impact of fatigue could have been minimised. At a minimum, the process may be triggered by any of the following:
- (1) fatigue reports;
 - (2) confidential reports;
 - (3) audit reports;
 - (4) incidents; or
 - (5) flight data monitoring (FDM) events.

AMC2 ORO.FTL.120(b)(4) Fatigue risk management (FRM)

ED Decision 2014/017/R

CAT OPERATORS RISK ASSESSMENT

An operator should develop and implement risk assessment procedures that determine the probability and potential severity of fatigue-related events and identify when the associated risks require mitigation. The risk assessment procedures should review identified hazards and link them to:

- (a) operational processes;
- (b) their probability;
- (c) possible consequences; and
- (d) the effectiveness of existing safety barriers and controls.

AMC1 ORO.FTL.120(b)(5) Fatigue risk management (FRM)

ED Decision 2014/017/R

CAT OPERATORS RISK MITIGATION

An operator should develop and implement risk mitigation procedures that:

- (a) select the appropriate mitigation strategies;
- (b) implement the mitigation strategies; and
- (c) monitor the strategies' implementation and effectiveness.

AMC1 ORO.FTL.120(b)(6) Fatigue risk management (FRM)

ED Decision 2015/005/R

CAT OPERATORS FRM SAFETY ASSURANCE PROCESSES

The operator should develop and maintain FRM safety assurance processes to:

- (a) provide for continuous FRM performance monitoring, analysis of trends, and measurement to validate the effectiveness of the fatigue safety risk controls. The sources of data may include, but are not limited to:
 - (1) hazard reporting and investigations;
 - (2) audits and surveys; and
 - (3) reviews and fatigue studies;
- (b) provide a formal process for the management of change which should include, but is not limited to:
 - (1) identification of changes in the operational environment that may affect FRM;
 - (2) identification of changes within the organisation that may affect FRM; and
 - (3) consideration of available tools which could be used to maintain or improve FRM performance prior to implementing changes; and
- (c) provide for the continuous improvement of FRM. This should include, but is not limited to:
 - (1) the elimination and/or modification of risk controls have had unintended consequences or that are no longer needed due to changes in the operational or organisational environment;
 - (2) routine evaluations of facilities, equipment, documentation and procedures; and
 - (3) the determination of the need to introduce new processes and procedures to mitigate emerging fatigue-related risks.

AMC1 ORO.FTL.120(b)(7) Fatigue risk management (FRM)

ED Decision 2015/005/R

CAT OPERATORS FRM PROMOTION PROCESS

FRM promotion processes should support the on-going development of FRM, the continuous improvement of its overall performance, and attainment of optimum safety levels.

The following should be established and implemented by the operator as part of its FRM:

- (a) training programmes to ensure competency commensurate with the roles and responsibilities of management, flight and cabin crew, and all other involved personnel under the planned FRM; and
- (b) an effective FRM communication plan that:
 - (1) explains FRM policies, procedures and responsibilities to all relevant stakeholders; and
 - (2) describes communication channels used to gather and disseminate FRM-related information.

ORO.FTL.125 Flight time specification schemes

Regulation (EU) No 83/2014

- (a) Operators shall establish, implement and maintain flight time specification schemes that are appropriate for the type(s) of operation performed and that comply with Regulation (EC) No 216/2008, this Subpart and other applicable legislation, including Directive 2000/79/EC.
- (b) Before being implemented, flight time specification schemes, including any related FRM where required, shall be approved by the competent authority.
- (c) To demonstrate compliance with Regulation (EC) No 216/2008 and this Subpart, the operator shall apply the applicable certification specifications adopted by the Agency. Alternatively, if the operator wants to deviate from those certification specifications in accordance with Article 22(2) of Regulation (EC) No 216/2008, it shall provide the competent authority with a full description of the intended deviation prior to implementing it. The description shall include any revisions to manuals or procedures that may be relevant, as well as an assessment demonstrating that the requirements of Regulation (EC) No 216/2008 and of this Subpart are met.
- (d) For the purpose of point [ARO.OPS.235\(d\)](#), within 2 years of the implementation of a deviation or derogation, the operator shall collect data concerning the granted deviation or derogation and analyse that data using scientific principles with a view to assessing the effects of the deviation or derogation on aircrew fatigue. Such analysis shall be provided in the form of a report to the competent authority.

SECTION 2 – COMMERCIAL AIR TRANSPORT OPERATORS

ORO.FTL.200 Home base

Regulation (EU) No 83/2014

An operator shall assign a home base to each crew member.

ORO.FTL.205 Flight duty period (FDP)

Regulation (EU) No 83/2014

- (a) The operator shall:
 - (1) define reporting times appropriate to each individual operation taking into account [ORO.FTL.110\(c\)](#);

- (2) establish procedures specifying how the commander shall, in case of special circumstances which could lead to severe fatigue, and after consultation with the crew members concerned, reduce the actual FDP and/or increase the rest period in order to eliminate any detrimental effect on flight safety.
- (b) Basic maximum daily FDP.
- (1) The maximum daily FDP without the use of extensions for acclimatised crew members shall be in accordance with the following table:

Table 2
Maximum daily FDP — Acclimatised crew members

Start of FDP at reference time	1–2 Sectors	3 Sectors	4 Sectors	5 Sectors	6 Sectors	7 Sectors	8 Sectors	9 Sectors	10 Sectors
0600–1329	13:00	12:30	12:00	11:30	11:00	10:30	10:00	09:30	09:00
1330–1359	12:45	12:15	11:45	11:15	10:45	10:15	09:45	09:15	09:00
1400–1429	12:30	12:00	11:30	11:00	10:30	10:00	09:30	09:00	09:00
1430–1459	12:15	11:45	11:15	10:45	10:15	09:45	09:15	09:00	09:00
1500–1529	12:00	11:30	11:00	10:30	10:00	09:30	09:00	09:00	09:00
1530–1559	11:45	11:15	10:45	10:15	09:45	09:15	09:00	09:00	09:00
1600–1629	11:30	11:00	10:30	10:00	09:30	09:00	09:00	09:00	09:00
1630–1659	11:15	10:45	10:15	09:45	09:15	09:00	09:00	09:00	09:00
1700–0459	11:00	10:30	10:00	09:30	09:00	09:00	09:00	09:00	09:00
0500–0514	12:00	11:30	11:00	10:30	10:00	09:30	09:00	09:00	09:00
0515–0529	12:15	11:45	11:15	10:45	10:15	09:45	09:15	09:00	09:00
0530–0544	12:30	12:00	11:30	11:00	10:30	10:00	09:30	09:00	09:00
0545–0559	12:45	12:15	11:45	11:15	10:45	10:15	09:45	09:15	09:00

- (2) The maximum daily FDP when crew members are in an unknown state of acclimatisation shall be in accordance with the following table:

Table 3
Crew members in an unknown state of acclimatisation

Maximum daily FDP according to sectors						
1–2	3	4	5	6	7	8
11:00	10:30	10:00	09:30	09:00	09:00	09:00

- (3) The maximum daily FDP when crew members are in an unknown state of acclimatisation and the operator has implemented a FRM, shall be in accordance with the following table:

Table 4
Crew members in an unknown state of acclimatisation under FRM

The values in the following table may apply provided the operator’s FRM continuously monitors that the required safety performance is maintained.

Maximum daily FDP according to sectors						
1-2	3	4	5	6	7	8
12:00	11:30	11:00	10:30	10:00	09:30	09:00

- (c) FDP with different reporting time for flight crew and cabin crew.

Whenever cabin crew requires more time than the flight crew for their pre-flight briefing for the same sector or series of sectors, the FDP of the cabin crew may be extended by the difference in reporting time between the cabin crew and the flight crew. The difference shall not exceed 1 hour. The maximum daily FDP for cabin crew shall be based on the time at which the flight crew report for their FDP, but the FDP shall start at the reporting time of the cabin crew.

- (d) Maximum daily FDP for acclimatised crew members with the use of extensions without in-flight rest.

- (1) The maximum daily FDP may be extended by up to 1 hour not more than twice in any 7 consecutive days. In that case:

- (i) the minimum pre-flight and post-flight rest periods shall be increased by 2 hours; or
- (ii) the post-flight rest period shall be increased by 4 hours.

- (2) When extensions are used for consecutive FDPs, the additional pre- and post-flight rest between the two extended FDPs required under subparagraph 1 shall be provided consecutively.

- (3) The use of the extension shall be planned in advance, and shall be limited to a maximum of:

- (i) 5 sectors when the WOCL is not encroached; or
- (ii) 4 sectors, when the WOCL is encroached by 2 hours or less; or
- (iii) 2 sectors, when the WOCL is encroached by more than 2 hours.

- (4) Extension of the maximum basic daily FDP without in-flight rest shall not be combined with extensions due to in-flight rest or split duty in the same duty period.

- (5) Flight time specification schemes shall specify the limits for extensions of the maximum basic daily FDP in accordance with the certification specifications applicable to the type of operation, taking into account:

- (i) the number of sectors flown; and
- (ii) WOCL encroachment.

- (e) Maximum daily FDP with the use of extensions due to in-flight rest

Flight time specification schemes shall specify the conditions for extensions of the maximum basic daily FDP with in-flight rest in accordance with the certification specifications applicable to the type of operation, taking into account:

- (i) the number of sectors flown;
- (ii) the minimum in-flight rest allocated to each crew member;
- (iii) the type of in-flight rest facilities; and
- (iv) the augmentation of the basic flight crew.

- (f) Unforeseen circumstances in flight operations — commander's discretion
- (1) The conditions to modify the limits on flight duty, duty and rest periods by the commander in the case of unforeseen circumstances in flight operations, which start at or after the reporting time, shall comply with the following:
 - (i) the maximum daily FDP which results after applying points (b) and (e) of point ORO.FTL.205 or point ORO.FTL.220 may not be increased by more than 2 hours unless the flight crew has been augmented, in which case the maximum flight duty period may be increased by not more than 3 hours;
 - (ii) if on the final sector within an FDP the allowed increase is exceeded because of unforeseen circumstances after take-off, the flight may continue to the planned destination or alternate aerodrome; and
 - (iii) the rest period following the FDP may be reduced but can never be less than 10 hours.
 - (2) In case of unforeseen circumstances which could lead to severe fatigue, the commander shall reduce the actual flight duty period and/or increase the rest period in order to eliminate any detrimental effect on flight safety.
 - (3) The commander shall consult all crew members on their alertness levels before deciding the modifications under subparagraphs 1 and 2.
 - (4) The commander shall submit a report to the operator when an FDP is increased or a rest period is reduced at his or her discretion.
 - (5) Where the increase of an FDP or reduction of a rest period exceeds 1 hour, a copy of the report, to which the operator shall add its comments, shall be sent by the operator to the competent authority not later than 28 days after the event.
 - (6) The operator shall implement a non-punitive process for the use of the discretion described under this provision and shall describe it in the operations manual.
- (g) Unforeseen circumstances in flight operations — delayed reporting
- The operator shall establish procedures, in the operations manual, for delayed reporting in the event of unforeseen circumstances, in accordance with the certification specifications applicable to the type of operation.

GM1 ORO.FTL.205(a)(1) Flight Duty Period (FDP)

ED Decision 2014/017/R

REPORTING TIMES

The operator should specify reporting times taking into account the type of operation, the size and type of aircraft and the reporting airport conditions.

GM1 ORO.FTL.205(b)(1) Flight duty period (FDP)

ED Decision 2014/017/R

REFERENCE TIME

The start time of the FDP in the table refers to the 'reference time'. That means, to the local time of the point of departure, if this point of departure is within a 2-hour wide time zone band around the local time where a crew member is acclimatised.

AMC1 ORO.FTL.205(f) Flight Duty Period (FDP)

ED Decision 2014/017/R

UNFORESEEN CIRCUMSTANCES IN ACTUAL FLIGHT OPERATIONS — COMMANDER'S DISCRETION

- (a) As general guidance when developing a commander's discretion policy, the operator should take into consideration the shared responsibility of management, flight and cabin crew in the case of unforeseen circumstances. The exercise of commander's discretion should be considered exceptional and should be avoided at home base and/or company hubs where standby or reserve crew members should be available. Operators should assess on a regular basis the series of pairings where commander's discretion has been exercised in order to be aware of possible inconsistencies in their rostering.
- (b) The operator's policy on commander's discretion should state the safety objectives, especially in the case of an extended FDP or reduced rest and should take due consideration of additional factors that might decrease a crew member's alertness levels, such as:
- (1) WOCL encroachment;
 - (2) weather conditions;
 - (3) complexity of the operation and/or airport environment;
 - (4) aeroplane malfunctions or specifications;
 - (5) flight with training or supervisory duties;
 - (6) increased number of sectors;
 - (7) circadian disruption; and
 - (8) individual conditions of affected crew members (time since awake, sleep-related factor, workload, etc.).

GM1 ORO.FTL.205(f)(1)(i) Flight Duty Period (FDP)

ED Decision 2014/017/R

COMMANDER'S DISCRETION

The maximum basic daily FDP that results after applying [ORO.FTL.205\(b\)](#) should be used to calculate the limits of commander's discretion, if commander's discretion is applied to an FDP which has been extended under the provisions of ORO.FTL.205(d).

ORO.FTL.210 Flight times and duty periods

Regulation (EU) No 83/2014

- (a) The total duty periods to which a crew member may be assigned shall not exceed:
- (1) 60 duty hours in any 7 consecutive days;
 - (2) 110 duty hours in any 14 consecutive days; and
 - (3) 190 duty hours in any 28 consecutive days, spread as evenly as practicable throughout that period.
- (b) The total flight time of the sectors on which an individual crew member is assigned as an operating crew member shall not exceed:
- (1) 100 hours of flight time in any 28 consecutive days;

- (2) 900 hours of flight time in any calendar year; and
 - (3) 1 000 hours of flight time in any 12 consecutive calendar months.
- (c) Post-flight duty shall count as duty period. The operator shall specify in its operations manual the minimum time period for post-flight duties.

AMC1 ORO.FTL.210(c) Flight times and duty periods

ED Decision 2014/017/R

POST-FLIGHT DUTIES

The operator should specify post-flight duty times taking into account the type of operation, the size and type of aircraft and the airport conditions.

ORO.FTL.215 Positioning

Regulation (EU) No 83/2014

If an operator positions a crew member, the following shall apply:

- (a) positioning after reporting but prior to operating shall be counted as FDP but shall not count as a sector;
- (b) all time spent on positioning shall count as duty period.

ORO.FTL.220 Split duty

Regulation (EU) No 83/2014

The conditions for extending the basic maximum daily FDP due to a break on the ground shall be in accordance with the following:

- (a) flight time specification schemes shall specify the following elements for split duty in accordance with the certification specifications applicable to the type of operation:
 - (1) the minimum duration of a break on the ground; and
 - (2) the possibility to extend the FDP prescribed under point [ORO.FTL.205\(b\)](#) taking into account the duration of the break on the ground, the facilities provided to the crew member to rest and other relevant factors;
- (b) the break on the ground shall count in full as FDP;
- (c) split duty shall not follow a reduced rest.

ORO.FTL.225 Standby and duties at the airport

Regulation (EU) No 83/2014

If an operator assigns crew members to standby or to any duty at the airport, the following shall apply in accordance with the certification specifications applicable to the type of operation:

- (a) standby and any duty at the airport shall be in the roster and the start and end time of standby shall be defined and notified in advance to the crew members concerned to provide them with the opportunity to plan adequate rest;
- (b) a crew member is considered on airport standby from reporting at the reporting point until the end of the notified airport standby period;

- (c) airport standby shall count in full as duty period for the purpose of points [ORO.FTL.210](#) and [ORO.FTL.235](#);
- (d) any duty at the airport shall count in full as duty period and the FDP shall count in full from the airport duty reporting time;
- (e) the operator shall provide accommodation to the crew member on airport standby;
- (f) flight time specification schemes shall specify the following elements:
 - (1) the maximum duration of any standby;
 - (2) the impact of the time spent on standby on the maximum FDP that may be assigned, taking into account facilities provided to the crew member to rest, and other relevant factors such as:
 - the need for immediate readiness of the crew member,
 - the interference of standby with sleep, and
 - sufficient notification to protect a sleep opportunity between the call for duty and the assigned FDP;
 - (3) the minimum rest period following standby which does not lead to assignment of an FDP;
 - (4) how time spent on standby other than airport standby shall be counted for the purpose of cumulative duty periods.

ORO.FTL.230 Reserve

Regulation (EU) No 83/2014

If an operator assigns crew members to reserve, the following requirements shall apply in accordance with the certification specifications applicable to the type of operation:

- (a) reserve shall be in the roster;
- (b) flight time specification schemes shall specify the following elements:
 - (1) the maximum duration of any single reserve period;
 - (2) the number of consecutive reserve days that may be assigned to a crew member.

GM1 ORO.FTL.230(a) Reserve

ED Decision 2014/017/R

ROSTERING OF RESERVE

Including reserve in a roster, also referred to as 'rostering', implies that a reserve period that does not result in a duty period may not retrospectively be considered as part of a recurrent extended recovery rest period.

ORO.FTL.235 Rest periods

Regulation (EU) No 83/2014

- (a) Minimum rest period at home base.
 - (1) The minimum rest period provided before undertaking an FDP starting at home base shall be at least as long as the preceding duty period, or 12 hours, whichever is greater.

- (2) By way of derogation from point (1), the minimum rest provided under point (b) applies if the operator provides suitable accommodation to the crew member at home base.
- (b) Minimum rest period away from home base.
- The minimum rest period provided before undertaking an FDP starting away from home base shall be at least as long as the preceding duty period, or 10 hours, whichever is greater. This period shall include an 8-hour sleep opportunity in addition to the time for travelling and physiological needs.
- (c) Reduced rest
- By derogation from points (a) and (b), flight time specification schemes may reduce the minimum rest periods in accordance with the certification specifications applicable to the type of operation and taking into account the following elements:
- (1) the minimum reduced rest period;
 - (2) the increase of the subsequent rest period; and
 - (3) the reduction of the FDP following the reduced rest.
- (d) Recurrent extended recovery rest periods
- Flight time specification schemes shall specify recurrent extended recovery rest periods to compensate for cumulative fatigue. The minimum recurrent extended recovery rest period shall be 36 hours, including 2 local nights, and in any case the time between the end of one recurrent extended recovery rest period and the start of the next extended recovery rest period shall not be more than 168 hours. The recurrent extended recovery rest period shall be increased to 2 local days twice every month.
- (e) Flight time specification schemes shall specify additional rest periods in accordance with the applicable certification specifications to compensate for:
- (1) the effects of time zone differences and extensions of the FDP;
 - (2) additional cumulative fatigue due to disruptive schedules; and
 - (3) a change of home base.

GM1 ORO.FTL.235(a)(2) Rest periods

ED Decision 2014/017/R

MINIMUM REST PERIOD AT HOME BASE IF SUITABLE ACCOMMODATION IS PROVIDED

An operator may apply the minimum rest period away from home base during a rotation which includes a rest period at a crew member's home base. This applies only if the crew member does not rest at his/her residence, or temporary accommodation, because the operator provides suitable accommodation. This type of roster is known as "back-to-back operation".

AMC1 ORO.FTL.235(b) Rest periods

ED Decision 2014/017/R

MINIMUM REST PERIOD AWAY FROM HOME BASE

The time allowed for physiological needs should be 1 hour. Consequently, if the travelling time to the suitable accommodation is more than 30 minutes, the operator should increase the rest period by twice the amount of difference of travelling time above 30 minutes.

ORO.FTL.240 Nutrition

Regulation (EU) No 83/2014

- (a) During the FDP there shall be the opportunity for a meal and drink in order to avoid any detriment to a crew member's performance, especially when the FDP exceeds 6 hours.
- (b) An operator shall specify in its operations manual how the crew member's nutrition during FDP is ensured.

AMC1 ORO.FTL.240 Nutrition

ED Decision 2014/017/R

MEAL OPPORTUNITY

- (a) The operations manual should specify the minimum duration of the meal opportunity, when a meal opportunity is provided, in particular when the FDP encompasses the regular meal windows (e.g. if the FDP starts at 11:00 hours and ends at 22:00 hours meal opportunities for two meals should be given).
- (b) It should define the time frames in which a regular meal should be consumed in order not to alter the human needs for nutrition without affecting the crew member's body rhythms.

ORO.FTL.245 Records of home base, flight times, duty and rest periods

Regulation (EU) No 83/2014

- (a) An operator shall maintain, for a period of 24 months:
 - (1) individual records for each crew member including:
 - (i) flight times;
 - (ii) start, duration and end of each duty period and FDP;
 - (iii) rest periods and days free of all duties; and
 - (iv) assigned home base;
 - (2) reports on extended flight duty periods and reduced rest periods.
- (b) Upon request, the operator shall provide copies of individual records of flight times, duty periods and rest periods to:
 - (1) the crew member concerned; and
 - (2) to another operator, in relation to a crew member who is or becomes a crew member of the operator concerned.
- (c) Records referred to in point [CAT.GEN.MPA.100\(b\)\(5\)](#) in relation to crew members who undertake duties for more than one operator shall be kept for a period of 24 months.

ORO.FTL.250 Fatigue management training

Regulation (EU) No 83/2014

- (a) The operator shall provide initial and recurrent fatigue management training to crew members, personnel responsible for preparation and maintenance of crew rosters and management personnel concerned.

- (b) This training shall follow a training programme established by the operator and described in the operations manual. The training syllabus shall cover the possible causes and effects of fatigue and fatigue countermeasure.

AMC1 ORO.FTL.250 Fatigue management training

ED Decision 2014/017/R

TRAINING SYLLABUS FATIGUE MANAGEMENT TRAINING

The training syllabus should contain the following:

- (a) applicable regulatory requirements for flight, duty and rest;
- (b) the basics of fatigue including sleep fundamentals and the effects of disturbing the circadian rhythms;
- (c) the causes of fatigue, including medical conditions that may lead to fatigue;
- (d) the effect of fatigue on performance;
- (e) fatigue countermeasures;
- (f) the influence of lifestyle, including nutrition, exercise, and family life, on fatigue;
- (g) familiarity with sleep disorders and their possible treatments;
- (h) where applicable, the effects of long range operations and heavy short range schedules on individuals;
- (i) the effect of operating through and within multiple time zones; and
- (j) the crew member responsibility for ensuring adequate rest and fitness for flight duty.

CERTIFICATION SPECIFICATIONS AND GUIDANCE MATERIAL FOR COMMERCIAL AIR TRANSPORT BY AEROPLANE — SCHEDULED AND CHARTER OPERATIONS

CS FTL.1.100 Applicability

ED Decision 2014/002/R

These Certification Specifications are applicable to commercial air transport by aeroplanes for scheduled and charter operations, excluding emergency medical service (EMS), air taxi and single pilot operations.

CS FTL.1.200 Home base

ED Decision 2014/002/R

- (a) The home base is a single airport location assigned with a high degree of permanence.
- (b) In the case of a change of home base, the first recurrent extended recovery rest period prior to starting duty at the new home base is increased to 72 hours, including 3 local nights. Travelling time between the former home base and the new home base is positioning.

GM1 CS FTL.1.200 Home base

ED Decision 2014/002/R

TRAVELLING TIME

Crew members should consider making arrangements for temporary accommodation closer to their home base if the travelling time from their residence to their home base usually exceeds 90 minutes.

CS FTL.1.205 Flight duty period (FDP)

ED Decision 2014/002/R

- (a) Night duties under the provisions of [ORO.FTL.205\(b\)](#) and (d) comply with the following:
- (1) When establishing the maximum FDP for consecutive night duties, the number of sectors is limited to 4 sectors per duty. (2) The operator applies appropriate fatigue risk management to actively manage the fatiguing effect of night duties of more than 10 hours in relation to the surrounding duties and rest periods.
- (b) Extension of FDP without in-flight rest

The extension of FDP without in-flight rest under the provisions of [ORO.FTL.205\(d\)\(5\)](#) is limited to the values specified in the table below.

Maximum daily FDP with extension

Starting time of FDP	1–2 sectors (in hours)	3 sectors (in hours)	4 sectors (in hours)	5 sectors (in hours)
0600–0614	Not allowed	Not allowed	Not allowed	Not allowed
0615–0629	13:15	12:45	12:15	11:45
0630–0644	13:30	13:00	12:30	12:00
0645–0659	13:45	13:15	12:45	12:15
0700–1329	14:00	13:30	13:00	12:30
1330–1359	13:45	13:15	12:45	Not allowed
1400–1429	13:30	13:00	12:30	Not allowed
1430–1459	13:15	12:45	12:15	Not allowed
1500–1529	13:00	12:30	12:00	Not allowed
1530–1559	12:45	Not allowed	Not allowed	Not allowed
1600–1629	12:30	Not allowed	Not allowed	Not allowed
1630–1659	12:15	Not allowed	Not allowed	Not allowed
1700–1729	12:00	Not allowed	Not allowed	Not allowed
1730–1759	11:45	Not allowed	Not allowed	Not allowed
1800–1829	11:30	Not allowed	Not allowed	Not allowed
1830–1859	11:15	Not allowed	Not allowed	Not allowed
1900–0359	Not allowed	Not allowed	Not allowed	Not allowed
0400–0414	Not allowed	Not allowed	Not allowed	Not allowed
0415–0429	Not allowed	Not allowed	Not allowed	Not allowed
0430–0444	Not allowed	Not allowed	Not allowed	Not allowed
0445–0459	Not allowed	Not allowed	Not allowed	Not allowed
0500–0514	Not allowed	Not allowed	Not allowed	Not allowed
0515–0529	Not allowed	Not allowed	Not allowed	Not allowed

0530–0544	Not allowed	Not allowed	Not allowed	Not allowed
0545–0559	Not allowed	Not allowed	Not allowed	Not allowed

(c) Extension of FDP due to in-flight rest

In-flight rest facilities in accordance with [ORO.FTL.205\(e\)\(iii\)](#) fulfil the following minimum standards:

- ‘Class 1 rest facility’ means a bunk or other surface that allows for a flat or near flat sleeping position. It reclines to at least 80° back angle to the vertical and is located separately from both the flight crew compartment and the passenger cabin in an area that allows the crew member to control light, and provides isolation from noise and disturbance;
 - ‘Class 2 rest facility’ means a seat in an aircraft cabin that reclines at least 45° back angle to the vertical, has at least a pitch of 55 inches (137,5 cm), a seat width of at least 20 inches (50 cm) and provides leg and foot support. It is separated from passengers by at least a curtain to provide darkness and some sound mitigation, and is reasonably free from disturbance by passengers or crew members;
 - ‘Class 3 rest facility’ means a seat in an aircraft cabin or flight crew compartment that reclines at least 40° from the vertical, provides leg and foot support and is separated from passengers by at least a curtain to provide darkness and some sound mitigation, and is not adjacent to any seat occupied by passengers.
- (1) The extension of FDP with in-flight rest under the provisions of [ORO.FTL.205\(e\)](#) complies with the following:
- (i) the FDP is limited to 3 sectors; and
 - (ii) the minimum in-flight rest period is a consecutive 90-minute period for each crew member and 2 consecutive hours for the flight crew members at control during landing.
- (2) The maximum daily FDP under the provisions of [ORO.FTL.205\(e\)](#) may be extended due to in-flight rest for flight crew:
- (i) with one additional flight crew member:
 - (A) up to 14 hours with class 3 rest facilities;
 - (B) up to 15 hours with class 2 rest facilities; or
 - (C) up to 16 hours with class 1 rest facilities;
 - (ii) with two additional flight crew members:
 - (A) up to 15 hours with class 3 rest facilities;
 - (B) up to 16 hours with class 2 rest facilities; or
 - (C) up to 17 hours with class 1 rest facilities.

- (3) The minimum in-flight rest for each cabin crew member is:

Maximum extended FDP	Minimum in-flight rest (in hours)		
	Class 1	Class 2	Class 3
up to 14:30 hrs	1:30	1:30	1:30
14:31 – 15:00 hrs	1:45	2:00	2:20
15:01 – 15:30 hrs	2:00	2:20	2:40
15:31 – 16:00 hrs	2:15	2:40	3:00
16:01 – 16:30 hrs	2:35	3:00	Not allowed
16:31 – 17:00 hrs	3:00	3:25	Not allowed
17:01 – 17:30 hrs	3:25	Not allowed	Not allowed
17:31 – 18:00 hrs	3:50	Not allowed	Not allowed

- (4) The limits specified in (2) may be increased by 1 hour for FDPs that include 1 sector of more than 9 hours of continuous flight time and a maximum of 2 sectors.
- (5) All time spent in the rest facility is counted as FDP.
- (6) The minimum rest at destination is at least as long as the preceding duty period, or 14 hours, whichever is greater.
- (7) A crew member does not start a positioning sector to become part of this operating crew on the same flight.
- (d) Unforeseen circumstances in flight operations — delayed reporting
- (1) The operator may delay the reporting time in the event of unforeseen circumstances, if procedures for delayed reporting are established in the operations manual. The operator keeps records of delayed reporting. Delayed reporting procedures establish a notification time allowing a crew member to remain in his/her suitable accommodation when the delayed reporting procedure is activated. In such a case, if the crew member is informed of the delayed reporting time, the FDP is calculated as follows:
- (i) one notification of a delay leads to the calculation of the maximum FDP according to (iii) or (iv);
 - (ii) if the reporting time is further amended, the FDP starts counting 1 hour after the second notification or at the original delayed reporting time if this is earlier;
 - (iii) when the delay is less than 4 hours, the maximum FDP is calculated based on the original reporting time and the FDP starts counting at the delayed reporting time;
 - (iv) when the delay is 4 hours or more, the maximum FDP is calculated based on the more limiting of the original or the delayed reporting time and the FDP starts counting at the delayed reporting time;
 - (v) as an exception to (i) and (ii), when the operator informs the crew member of a delay of 10 hours or more in reporting time and the crew member is not further disturbed by the operator, such delay of 10 hours or more counts as a rest period.

GM1 CS FTL.1.205(a)(2) Flight duty period (FDP)

ED Decision 2014/002/R

NIGHT DUTIES – APPROPRIATE FATIGUE RISK MANAGEMENT

- (a) When rostering night duties of more than 10 hours (referred to below as ‘long night duties’), it is critical for the crew member to obtain sufficient sleep before such duties when he/she is adapted to being awake during day time hours at the local time where he/she is acclimatised. To optimise alertness on long night duties, the likelihood of obtaining sleep as close as possible to the start of the FDP should be considered, when rostering rest periods before long night duties, by providing sufficient time to the crew member to adapt to being awake during the night. Rostering practices leading to extended wakefulness before reporting for such duties should be avoided. Fatigue risk management principles that could be applied to the rostering of long night duties may include:
- (1) avoiding long night duties after extended recovery rest periods
 - (2) progressively delaying the rostered ending time of the FDPs preceding long night duties;
 - (3) starting a block of night duties with a shorter FDP; and
 - (4) avoiding the sequence of early starts and long night duties.
- (b) Fatigue risk management principles may be applied to the rostering of long night duties by means of:
- (1) considering operator or industry operational experience and data collected on similar operations;
 - (2) evidence-based scheduling practices; and
 - (3) bio-mathematical models.

GM1 CS FTL.1.205(c)(1)(ii) Flight Duty Period (FDP)

ED Decision 2014/002/R

IN-FLIGHT REST

In-flight rest should be taken during the cruise phase of the flight.

GM2 CS FTL.1.205(c)(1)(ii) Flight Duty Period (FDP)

ED Decision 2014/002/R

IN-FLIGHT REST

In-flight rest periods should be allocated in order to optimise the alertness of those flight crew members at control during landing.

GM1 CS FTL.1.205(d) Flight Duty Period (FDP)

ED Decision 2014/002/R

DELAYED REPORTING

Operator procedures for delayed reporting should:

- (a) specify a contacting mode;
- (b) establish minimum and maximum notification times; and

- (c) avoid interference with sleeping patterns when possible.

CS FTL.1.220 Split duty

ED Decision 2014/002/R

The increase of limits on flight duty, under the provisions of [ORO.FTL.220](#), complies with the following:

- (a) The break on the ground within the FDP has a minimum duration of 3 consecutive hours.
- (b) The break excludes the time allowed for post and pre-flight duties and travelling. The minimum total time for post and pre-flight duties and travelling is 30 minutes. The operator specifies the actual times in its operations manual.
- (c) The maximum FDP specified in [ORO.FTL.205\(b\)](#) may be increased by up to 50 % of the break.
- (d) Suitable accommodation is provided either for a break of 6 hours or more or for a break that encroaches the window of circadian low (WOCL).
- (e) In all other cases:
 - (1) accommodation is provided; and
 - (2) any time of the actual break exceeding 6 hours or any time of the break that encroaches the WOCL does not count for the extension of the FDP.
- (f) Split duty cannot be combined with in-flight rest.

GM1 CS FTL.1.220(b) Split duty

ED Decision 2014/002/R

POST, PRE-FLIGHT DUTY AND TRAVELLING TIMES

The operator should specify post and pre-flight duty and travelling times taking into account aircraft type, type of operation and airport conditions.

CS FTL.1.225 Standby

ED Decision 2014/002/R

The modification of limits on flight duty, duty and rest periods under the provisions of [ORO.FTL.225](#) complies with the following:

- (a) Airport standby
 - (1) If not leading to the assignment of an FDP, airport standby is followed by a rest period as specified in [ORO.FTL.235](#).
 - (2) If an assigned FDP starts during airport standby, the following applies:
 - (i) the FDP counts from the start of the FDP. The maximum FDP is reduced by any time spent on standby in excess of 4 hours;
 - (ii) the maximum combined duration of airport standby and assigned FDP as specified in [ORO.FTL.205\(b\)](#) and (d) is 16 hours.
- (b) Standby other than airport standby:
 - (1) the maximum duration of standby other than airport standby is 16 hours;
 - (2) The operator's standby procedures are designed to ensure that the combination of standby and FDP do not lead to more than 18 hours awake time;

- (3) 25 % of time spent on standby other than airport standby counts as duty time for the purpose of [ORO.FTL.210](#);
- (4) standby is followed by a rest period in accordance with [ORO.FTL.235](#);
- (5) standby ceases when the crew member reports at the designated reporting point;
- (6) if standby ceases within the first 6 hours, the maximum FDP counts from reporting;
- (7) if standby ceases after the first 6 hours, the maximum FDP is reduced by the amount of standby time exceeding 6 hours;
- (8) if the FDP is extended due to in-flight rest according to [CS FTL.1.205\(c\)](#), or to split duty according to [CS FTL.1.220](#), the 6 hours of paragraph (6) and (7) are extended to 8 hours;
- (9) if standby starts between 23:00 and 07:00, the time between 23:00 and 07:00 does not count towards the reduction of the FDP under (6), (7) and (8) until the crew member is contacted by the operator; and
- (10) the response time between call and reporting time established by the operator allows the crew member to arrive from his/her place of rest to the designated reporting point within a reasonable time.

GM1 CS FTL.1.225 Standby

ED Decision 2014/002/R

MINIMUM REST AND STANDBY

- (a) If airport or other standby initially assigned is reduced by the operator during standby that does not lead to an assignment to a flight duty period, the minimum rest requirements specified in [ORO.FTL.235](#) should apply.
- (b) If a minimum rest period as specified in [ORO.FTL.235](#) is provided before reporting for the duty assigned during the standby, this time period should not count as standby duty.
- (c) Standby other than airport standby counts (partly) as duty for the purpose of [ORO.FTL.210](#) only. If a crew member receives an assignment during standby other than airport standby, the actual reporting time at the designated reporting point should be used for the purpose of [ORO.FTL.235](#).

GM1 CS FTL.1.225(b) Standby

ED Decision 2014/002/R

STANDBY OTHER THAN AIRPORT STANDBY NOTIFICATION

Operator procedures for the notification of assigned duties during standby other than airport standby should avoid interference with sleeping patterns if possible.

GM1 CS FTL.1.225(b)(2) Standby

ED Decision 2014/002/R

AWAKE TIME

Scientific research shows that continuous awake in excess of 18 hours can reduce the alertness and should be avoided.

CS FTL.1.230 Reserve

ED Decision 2014/002/R

The operator assigns duties to a crew member on reserve under the provisions of [ORO.FTL.230](#) complying with the following:

- (a) An assigned FDP counts from the reporting time.
- (b) Reserve times do not count as duty period for the purpose of [ORO.FTL.210](#) and [ORO.FTL.235](#).
- (c) The operator defines the maximum number of consecutive reserve days within the limits of [ORO.FTL.235\(d\)](#).
- (d) To protect an 8-hour sleep opportunity, the operator rosters a period of 8 hours, taking into account fatigue management principles, for each reserve day during which a crew member on reserve is not contacted by the operator.

GM1 CS FTL.1.230 Reserve

ED Decision 2014/002/R

RESERVE NOTIFICATION

Operator procedures for the notification of assigned duties during reserve should avoid interference with sleeping patterns if possible.

GM2 CS FTL.1.230 Reserve

ED Decision 2014/002/R

NOTIFICATION IN ADVANCE

The minimum 'at least 10 hours' between the notification of an assignment for any duty and reporting for that duty during reserve may include the period of 8 hours during which a crew member on reserve is not contacted by the operator.

GM1 CS FTL.1.230(c) Reserve

ED Decision 2014/002/R

RECURRENT EXTENDED RECOVERY REST

[ORO.FTL.235\(d\)](#) applies to a crew member on reserve.

CS FTL.1.235 Rest periods

ED Decision 2014/002/R

- (a) Disruptive schedules
 - (1) If a transition from a late finish/night duty to an early start is planned at home base, the rest period between the 2 FDPs includes 1 local night.
 - (2) If a crew member performs 4 or more night duties, early starts or late finishes between 2 extended recovery rest periods as defined in [ORO.FTL.235\(d\)](#), the second extended recovery rest period is extended to 60 hours.
- (b) Time zone differences
 - (1) For the purpose of [ORO.FTL.235\(e\)\(1\)](#), 'rotation' is a series of duties, including at least one flight duty, and rest period out of home base, starting at home base and ending when

returning to home base for a rest period where the operator is no longer responsible for the accommodation of the crew member.

- (2) The operator monitors rotations and combinations of rotations in terms of their effect on crew member fatigue, and adapts the rosters as necessary.
- (3) Time zone differences are compensated by additional rest, as follows:
 - (i) At home base, if a rotation involves a 4 hour time difference or more, the minimum rest is as specified in the following table.

Minimum local nights of rest at home base to compensate for time zone differences

Maximum time difference (h) between reference time and local time where a crew member rests during a rotation	Time elapsed (h) since reporting for the first FDP in a rotation involving at least 4 hour time difference to the reference time			
	< 48	48 – 71:59	72 – 95:59	≥96
≤6	2	2	3	3
≤9	2	3	3	4
≤12	2	3	4	5

- (ii) Away from home base, if an FDP involves a 4-hour time difference or more, the minimum rest following that FDP is at least as long as the preceding duty period, or 14 hours, whichever is greater. By way of derogation from point (b)(3)(i) and only once between 2 recurrent extended recovery rest periods as specified in [ORO.FTL.235\(d\)](#), the minimum rest provided under this point (b)(3)(ii) may also apply to home base if the operator provides suitable accommodation to the crew member.
 - (4) In case of an Eastward-Westward or Westward-Eastward transition, at least 3 local nights of rest at home base are provided between alternating rotations.
 - (5) The monitoring of combinations of rotations is conducted under the operator’s management system provisions.
- (c) Reduced rest
- (1) The minimum reduced rest periods under reduced rest arrangements are 12 hours at home base and 10 hours out of base.
 - (2) Reduced rest is used under fatigue risk management.
 - (3) The rest period following the reduced rest is extended by the difference between the minimum rest period specified in [ORO.FTL.235\(a\)](#) or (b) and the reduced rest.
 - (4) The FDP following the reduced rest is reduced by the difference between the minimum rest period specified in [ORO.FTL.235\(a\)](#) or (b) as applicable and the reduced rest.
 - (5) There is a maximum of 2 reduced rest periods between 2 recurrent extended recovery rest periods specified in accordance with [ORO.FTL.235\(d\)](#).

GM1 CS FTL.1.235(b)(3) Rest periods

ED Decision 2014/002/R

TIME ELAPSED SINCE REPORTING

The time elapsed since reporting for a rotation involving at least a 4-hour time difference to the reference time stops counting when the crew member returns to his/her home base for a rest period during which the operator is no longer responsible for the accommodation of the crew member.

GM2 CS FTL.1.235(b)(3) Additional rest to compensate for time zone differences

ED Decision 2017/007/R

REST AFTER ROTATIONS WITH THREE OR MORE FLIGHT DUTY PERIODS

For a rotation with three or more FDPs, the greatest time zone difference from the original reference time should be used to determine the minimum number of local nights of rest to compensate for time zone differences. If such a rotation includes time zones crossings in both directions, the calculation is based on the highest number of time zones crossed in any one FDP during the rotation.

Appendix I to Annex III (Part-ORO)

Regulation (EU) 2021/2237

DECLARATION					
in accordance with Commission Regulation (EU) No 965/2012 on air operations					
Operator Name: Place in which the operator has its principal place of business or, if the operator has no principal place of business, place in which the operator is established or residing and place from which the operations are directed: Name and contact details of the accountable manager:					
Aircraft operation					
Starting date of operation and applicability date of the change:					
Information on aircraft, operation and continuing airworthiness management organisation ⁽¹⁾ :					
Type(s) of aircraft, registration(s) and main base:					
Aircraft MSN ⁽²⁾	Aircraft type	Aircraft registration ⁽³⁾	Main base	Type(s) of operation ⁽⁴⁾	Organisation responsible for the continuing airworthiness management ⁽⁵⁾
The operator shall obtain a prior approval ⁽⁶⁾ or specific approval ⁽⁷⁾ for certain operations before conducting such operations.					
Where applicable, details of approvals held. Attach the list of specific approvals. Include: <ul style="list-style-type: none"> — specific approvals granted by a third country, if applicable; — name of operations conducted with operational credits (e.g. EFVS 200, SA CAT I, etc.). 					
Where applicable, details of specialised operations authorisation held (attach authorisation(s), if applicable).					
Where applicable, list of alternative means of compliance (AltMoC) with references to the associated AMC they replace (attach AltMoC).					
Statements					
<input type="checkbox"/> The operator complies, and continues to comply, with the essential requirements set out in Annex V to Regulation (EU) 2018/1139 of the European Parliament and of the Council and with the requirements of Regulation (EU) No 965/2012 .					
<input type="checkbox"/> The management system documentation, including the operations manual, shall comply with the requirements of Annex III (Part-ORO), Annex V (Part-SPA), Annex VI (Part-NCC) or Annex VIII (Part-SPO) to Commission Regulation (EU) No 965/2012 and all flights shall be made in accordance with the provisions of the operations manual as required by point ORO.GEN.110(b) of Part-ORO.					
<input type="checkbox"/> All operated aircraft shall hold: <ul style="list-style-type: none"> — a valid certificate of airworthiness in accordance with Commission Regulation (EU) No 748/2012 or, for aircraft registered in a third country, in accordance with ICAO Annex 8; and 					

—	when used for SPO activities, a valid lease agreement as per ORO.SPO.100 .
<input type="checkbox"/>	All flight crew members shall hold a licence in accordance with Annex I to Commission Regulation (EU) No 1178/2011 as required by point ORO.FC.100(c) of Part-ORO, and cabin crew members shall, where applicable, be trained in accordance with Subpart CC of Part-ORO.
<input type="checkbox"/>	(If applicable) The operator shall implement and demonstrate conformity to a recognised industry standard. Reference of the standard: Certification body: Date of the last conformity audit:
<input type="checkbox"/>	The operator shall notify to the competent authority any changes in circumstances affecting its compliance with the essential requirements set out in Annex V to Regulation (EU) 2018/1139 and with the requirements of Commission Regulation (EU) No 965/2012 as declared to the competent authority through this declaration, and any changes to the information and lists of AltMoC included in and annexed to this declaration, as required by point ORO.GEN.120(a) of Part-ORO.
<input type="checkbox"/>	The operator shall confirm that the information disclosed in this declaration is correct.
Date, name, and signature of the accountable manager	
(1)	If there is not enough space to list the required information in the declaration, the information shall be listed in a separate annex. The annex shall be dated and signed.
(2)	Manufacturer serial number.
(3)	If the aircraft is also registered with an AOC holder, specify the AOC number of the AOC holder.
(4)	'Type(s) of operation' refers to the type of operations conducted with this aircraft, e.g. non-commercial operations or specialised operations, e.g. aerial photography flights, aerial advertising flights, news media flights, television and movie flights, parachute operations, skydiving, maintenance check flights.
(5)	Information about the organisation responsible for the continuing airworthiness management shall include the name of the organisation, its address, and the approval reference.
(6)	(a) operations with any defective instrument or piece of equipment or item or function, under a minimum equipment list (MEL) (points ORO.MLR.105 (b), (f), and (j) , NCC.IDE.A.105 , NCC.IDE.H.105 , SPO.IDE.A.105 , and SPO.IDE.H.105).
	(b) Operations requiring prior authorisation or approval, including all of the following: <ul style="list-style-type: none"> — for specialised operations, wet lease-in and dry lease-in of aircraft registered in a third country (point ORO.SPO.100 (c)); — high-risk commercial specialised operations (point ORO.SPO.110); — non-commercial operations with aircraft with an MOPSC of more than 19, which are performed without — an operating cabin crew member (point ORO.CC.100 (d)); — use of IFR operating minima that are lower than those published by the State (points NCC.OP.110 and SPO.OP.110); — refuelling with engine(s) and/or rotors turning (point NCC.OP.157); — specialised operations (SPO) without oxygen above 10 000 ft (point SPO.OP.195).
(7)	Operations in accordance with Annex V (Part-SPA) to Regulation (EU) No 965/2012 , including Subparts B 'Performance based navigation (PBN) operations', C 'Operations with specified minimum navigation performance (MNPS)', D 'Operations in airspace with reduced vertical separation minima (RVSM)', E 'Low-visibility operations (LVOs) and operations with operational credits', G 'Transport of dangerous goods', K 'Helicopter offshore operations' and N 'Helicopter point-in-space approaches and departures with reduced VFR minima'.

ANNEX IV (PART-CAT)

SUBPART A: GENERAL REQUIREMENTS

CAT.GEN.100 Competent authority

Regulation (EU) No 965/2012

The competent authority shall be the authority designated by the Member State in which the operator has its principal place of business.

SECTION 1 – MOTOR-POWERED AIRCRAFT

CAT.GEN.MPA.100 Crew responsibilities

Regulation (EU) 2021/2037

- (a) The crew member shall be responsible for the proper execution of his or her duties that are:
- (1) related to the safety of the aircraft and its occupants; and
 - (2) specified in the instructions and procedures in the operations manual.
- (b) The crew member shall:
- (1) report to the commander any fault, failure, malfunction or defect which the crew member believes may affect the airworthiness or safe operation of the aircraft including emergency systems, if not already reported by another crew member;
 - (2) report to the commander any incident that endangered, or could have endangered, the safety of the operation, if not already reported by another crew member;
 - (3) comply with the relevant requirements of the operator's occurrence reporting schemes;
 - (4) comply with all flight and duty time limitations (FTL) and rest requirements applicable to their activities;
 - (5) when undertaking duties for more than one operator:
 - (i) maintain his or her individual records regarding flight and duty times and rest periods as referred to in the applicable FTL requirements;
 - (ii) provide each operator with the data needed to schedule activities in accordance with the applicable FTL requirements; and
 - (iii) provide each operator with the data needed regarding operations on more than one type or variant.
- (c) The crew member shall not perform duties on an aircraft:
- (1) when under the influence of psychoactive substances or when unfit due to injury, fatigue, medication, sickness or other similar causes;
 - (2) until a reasonable time period has elapsed after deep water diving or following blood donation;
 - (3) if applicable medical requirements are not fulfilled;
 - (4) if he or she is in any doubt of being able to accomplish his or her assigned duties; or

- (5) if he or she knows or suspects that he or she is suffering from fatigue as referred to in Annex V, point 7.5, to [Regulation \(EU\) 2018/1139](#) or feels otherwise unfit, to the extent that the flight may be endangered.

AMC1 CAT.GEN.MPA.100(b) Crew responsibilities

ED Decision 2014/015/R

COPIES OF REPORTS

Where a written report is required, a copy of the report should be communicated to the commander concerned unless the terms of the operator's reporting schemes prevent this.

AMC1 CAT.GEN.MPA.100(c)(1) Crew responsibilities

ED Decision 2014/015/R

ALCOHOL CONSUMPTION

The operator should issue instructions concerning the consumption of alcohol by crew members. The instructions should be not less restrictive than the following:

- (a) no alcohol should be consumed less than 8 hours prior to the specified reporting time for a flight duty period or the commencement of standby;
- (b) the blood alcohol level should not exceed the lower of the national requirements or 0.2 per thousand at the start of a flight duty period;
- (c) no alcohol should be consumed during the flight duty period or whilst on standby.

GM1 CAT.GEN.MPA.100(c)(2) Crew responsibilities

ED Decision 2014/015/R

ELAPSED TIME BEFORE RETURNING TO FLYING DUTY

24 hours is a suitable minimum length of time to allow after normal blood donation or normal recreational (sport) diving before returning to flying duties. This should be considered by operators when determining a reasonable time period for the guidance of crew members.

PART-MED

Information on the effects of medication, drugs, other treatments and alcohol can be found in Annex IV (Part-MED) to Commission Regulation (EU) No 1178/2011¹.

CAT.GEN.MPA.105 Responsibilities of the commander

Regulation (EU) 2019/1384

- (a) The commander, in addition to complying with [CAT.GEN.MPA.100](#), shall:
 - (1) be responsible for the safety of all crew members, passengers and cargo on board, as soon as the commander arrives on board the aircraft, until the commander leaves the aircraft at the end of the flight;

¹ Commission Regulation (EU) No 1178/2011 of 3 November 2011 laying down technical requirements and administrative procedures related to civil aviation aircrew pursuant to Regulation (EC) No 216/2008 of the European Parliament and of the Council (OJ L 311, 25.11.2011, p. 1).

- (2) be responsible for the operation and safety of the aircraft:
 - (i) for aeroplanes, from the moment the aeroplane is first ready to move for the purpose of taxiing prior to take-off, until the moment it finally comes to rest at the end of the flight and the engine(s) used as primary propulsion unit(s) is(are) shut down;
 - (ii) for helicopters, when the rotors are turning;
- (3) have authority to give all commands and take any appropriate actions for the purpose of securing the safety of the aircraft and of persons and/or property carried therein in accordance with 7.c of Annex IV to Regulation (EC) No 216/2008;
- (4) have authority to disembark any person, or any part of the cargo, that may represent a potential hazard to the safety of the aircraft or its occupants;
- (5) not allow a person to be carried in the aircraft who appears to be under the influence of alcohol or drugs to the extent that the safety of the aircraft or its occupants is likely to be endangered;
- (6) have the right to refuse transportation of inadmissible passengers, deportees or persons in custody if their carriage increases the risk to the safety of the aircraft or its occupants;
- (7) ensure that all passengers are briefed on the location of emergency exits and the location and use of relevant safety and emergency equipment;
- (8) ensure that all operational procedures and checklists are complied with in accordance with the operations manual;
- (9) not permit any crew member to perform any activity during critical phases of flight, except duties required for the safe operation of the aircraft;
- (10) ensure that:
 - (i) flight recorders are not disabled or switched off during flight;
 - (ii) in the event of an occurrence other than an accident or a serious incident that shall be reported according to [ORO.GEN.160\(a\)](#), flight recorders' recordings are not intentionally erased; and
 - (iii) in the event of an accident or a serious incident, or if preservation of recordings of flight recorders is directed by the investigating authority:
 - (A) flight recorders' recordings are not intentionally erased;
 - (B) flight recorders are deactivated immediately after the flight is completed; and
 - (C) precautionary measures to preserve the recordings of flight recorders are taken before leaving the flight crew compartment;
- (11) decide on acceptance of the aircraft with unserviceabilities in accordance with the configuration deviation list (CDL) or the minimum equipment list (MEL);
- (12) ensure that the pre-flight inspection has been carried out in accordance with the requirements of Annex I (Part-M) to Regulation (EU) No 1321/2014;
- (13) be satisfied that relevant emergency equipment remains easily accessible for immediate use;

- (14) record, at the termination of the flight, utilisation data and all known or suspected defects of the aircraft in the aircraft technical log or journey log of the aircraft to ensure continued flight safety.
- (b) The commander, or the pilot to whom conduct of the flight has been delegated, shall, in an emergency situation that requires immediate decision and action, take any action he/she considers necessary under the circumstances in accordance with 7.d of Annex IV to Regulation (EC) No 216/2008. In such cases he/she may deviate from rules, operational procedures and methods in the interest of safety.
- (c) Whenever an aircraft in flight has manoeuvred in response to an airborne collision avoidance system (ACAS) resolution advisory (RA), the commander shall submit an ACAS report to the competent authority.
- (d) Bird hazards and strikes:
- (1) Whenever a potential bird hazard is observed, the commander shall inform the air traffic service (ATS) unit as soon as flight crew workload allows.
 - (2) Whenever an aircraft for which the commander is responsible suffers a bird strike that results in significant damage to the aircraft or the loss or malfunction of any essential service, the commander shall submit a written bird strike report after landing to the competent authority.
- (e) The commander shall, as soon as possible, report to the appropriate air traffic services (ATS) unit any hazardous weather or flight conditions encountered that are likely to affect the safety of other aircraft.

GM1 CAT.GEN.MPA.105(a)(10) Responsibilities of the commander

ED Decision 2015/030/R

IDENTIFICATION OF THE SEVERITY OF AN OCCURRENCE BY THE COMMANDER

The definitions of an accident and a serious incident as well as examples thereof can be found in Regulation (EU) No 996/2010 of the European Parliament and of the Council.

CAT.GEN.MPA.110 Authority of the commander

Regulation (EU) No 965/2012

The operator shall take all reasonable measures to ensure that all persons carried in the aircraft obey all lawful commands given by the commander for the purpose of securing the safety of the aircraft and of persons or property carried therein.

CAT.GEN.MPA.115 Personnel or crew members other than cabin crew in the passenger compartment

Regulation (EU) No 965/2012

The operator shall ensure that personnel or crew members, other than operating cabin crew members, carrying out their duties in the passenger compartment of an aircraft:

- (a) are not confused by the passengers with operating cabin crew members;
- (b) do not occupy required cabin crew assigned stations;
- (c) do not impede operating cabin crew members in their duties.

AMC1 CAT.GEN.MPA.115(a) Personnel or crew members other than cabin crew in the passenger compartment

ED Decision 2014/015/R

MEASURES TO PREVENT CONFUSION BY PASSENGERS

If personnel or crew members other than operating cabin crew members carry out duties in a passenger compartment, the operator should ensure that they do not perform tasks or wear a uniform in such a way that might identify them as members of the operating cabin crew.

GM1 CAT.GEN.MPA.115 Personnel or crew members other than cabin crew in the passenger compartment

ED Decision 2014/015/R

POSITIONING CABIN CREW MEMBERS

To prevent confusion by passengers and undue expectations in case of emergency, positioning cabin crew members should not wear, or should at least make invisible to passengers, parts of the operator's cabin crew uniform, such as main jacket or crew signs or badges, that might identify them as members of the operating cabin crew.

CAT.GEN.MPA.120 Common language

Regulation (EU) No 965/2012

The operator shall ensure that all crew members can communicate with each other in a common language.

CAT.GEN.MPA.124 Taxiing of aircraft

Regulation (EU) 2015/140

The operator shall establish procedures for taxiing of aircraft in order to ensure safe operation and in order to enhance runway safety.

AMC1 CAT.GEN.MPA.124 Taxiing of aircraft

ED Decision 2015/007/R

PROCEDURES FOR TAXIING

Procedures for taxiing should include at least the following:

- (a) application of the sterile flight crew compartment procedures;
- (b) use of standard radio-telephony (RTF) phraseology;
- (c) use of lights;
- (d) measures to enhance the situational awareness of the minimum required flight crew members. The following list of typical items should be adapted by the operator to take into account its operational environment:
 - (1) each flight crew member should have the necessary aerodrome layout charts available;
 - (2) the pilot taxiing the aircraft should announce in advance his/her intentions to the pilot monitoring;

- (3) all taxi clearances should be heard and should be understood by each flight crew member;
 - (4) all taxi clearances should be cross-checked against the aerodrome chart and aerodrome surface markings, signs, and lights;
 - (5) an aircraft taxiing on the manoeuvring area should stop and hold at all lighted stop bars, and may proceed further when an explicit clearance to enter or cross the runway has been issued by the aerodrome control tower, and when the stop bar lights are switched off;
 - (6) if the pilot taxiing the aircraft is unsure of his/her position, he/she should stop the aircraft and contact air traffic control;
 - (7) the pilot monitoring should monitor the taxi progress and adherence to the clearances, and should assist the pilot taxiing;
 - (8) any action which may disturb the flight crew from the taxi activity should be avoided or done with the parking brake set (e.g. announcements by public address);
- (e) subparagraphs (d)(2) and (d)(7) are not applicable to single-pilot operations.

CAT.GEN.MPA.125 Taxiing of aeroplanes

Regulation (EU) No 965/2012

The operator shall ensure that an aeroplane is only taxied on the movement area of an aerodrome if the person at the controls:

- (a) is an appropriately qualified pilot; or
- (b) has been designated by the operator and:
 - (1) is trained to taxi the aircraft;
 - (2) is trained to use the radio telephone;
 - (3) has received instruction in respect of aerodrome layout, routes, signs, marking, lights, air traffic control (ATC) signals and instructions, phraseology and procedures;
 - (4) is able to conform to the operational standards required for safe aeroplane movement at the aerodrome.

GM1 CAT.GEN.MPA.125 Taxiing of aeroplanes

ED Decision 2014/015/R

SKILLS AND KNOWLEDGE

The following skills and knowledge may be assessed to check if a person can be authorised by the operator to taxi an aeroplane:

- (a) positioning of the aeroplane to ensure safety when starting engine;
- (b) getting ATIS reports and taxi clearance, where applicable;
- (c) interpretation of airfield markings/lights/signals/indicators;
- (d) interpretation of marshalling signals, where applicable;
- (e) identification of suitable parking area;

- (f) maintaining lookout and right-of-way rules and complying with air traffic control (ATC) or marshalling instructions, when applicable;
- (g) avoidance of adverse effect of propeller slipstream or jet wash on other aeroplanes, aerodrome facilities and personnel;
- (h) inspection of taxi path when surface conditions are obscured;
- (i) communication with others when controlling an aeroplane on the ground;
- (j) interpretation of operational instructions;
- (k) reporting of any problem that may occur while taxiing an aeroplane; and
- (l) adapting the taxi speed in accordance with prevailing aerodrome, traffic, surface and weather conditions.

GM2 CAT.GEN.MPA.125 Taxiing of aeroplanes

ED Decision 2015/007/R

SAFETY-CRITICAL ACTIVITY

- (a) Taxiing should be treated as a safety-critical activity due to the risks related to the movement of the aeroplane and the potential for a catastrophic event on the ground.
- (b) Taxiing is a high-workload phase of flight that requires the full attention of the flight crew.

CAT.GEN.MPA.130 Rotor engagement — helicopters

Regulation (EU) No 965/2012

A helicopter rotor shall only be turned under power for the purpose of flight with a qualified pilot at the controls.

GM1 CAT.GEN.MPA.130 Rotor engagement — helicopters

ED Decision 2014/015/R

INTENT OF THE RULE

- (a) The following two situations where it is allowed to turn the rotor under power should be distinguished:
 - (1) for the purpose of flight, this is described in the Implementing Rule;
 - (2) for maintenance purposes.
- (b) Rotor engagement for the purpose of flight: the pilot should not leave the control when the rotors are turning. For example, the pilot is not allowed to get out of the aircraft in order to welcome passengers and adjust their seat belts with the rotors turning.
- (c) Rotor engagement for the purpose of maintenance: the Implementing Rule, however, does not prevent ground runs being conducted by qualified personnel other than pilots for maintenance purposes.

The following conditions should be applied:

- (1) the operator should ensure that the qualification of personnel, other than pilots, who are authorised to conduct maintenance runs is described in the appropriate manual;
- (2) ground runs should not include taxiing the helicopter;

- (3) there should be no passengers on board; and
- (4) maintenance runs should not include collective increase or autopilot engagement (due to the risk of ground resonance).

CAT.GEN.MPA.135 Admission to the flight crew compartment

Regulation (EU) No 965/2012

- (a) The operator shall ensure that no person, other than a flight crew member assigned to a flight, is admitted to, or carried in, the flight crew compartment unless that person is:
 - (1) an operating crew member;
 - (2) a representative of the competent or inspecting authority, if required to be there for the performance of his/her official duties; or
 - (3) permitted by and carried in accordance with instructions contained in the operations manual.
- (b) The commander shall ensure that:
 - (1) admission to the flight crew compartment does not cause distraction or interference with the operation of the flight; and
 - (2) all persons carried in the flight crew compartment are made familiar with the relevant safety procedures.
- (c) The commander shall make the final decision regarding the admission to the flight crew compartment.

AMC1 CAT.GEN.MPA.135(a)(3) Admission to the flight crew compartment

ED Decision 2014/015/R

INSTRUCTIONS FOR SINGLE-PILOT OPERATIONS UNDER VFR BY DAY

Where an aircraft is used in a single-pilot operation under visual flight rules (VFR) by day, but has more than one pilot station, the instructions of the operator may permit passengers to be carried in the unoccupied pilot seat(s), provided that the commander is satisfied that:

- (a) it will not cause distraction or interference with the operation of the flight; and
- (b) the passenger occupying a pilot seat is familiar with the relevant restrictions and safety procedures.

CAT.GEN.MPA.140 Portable electronic devices

Regulation (EU) No 965/2012

The operator shall not permit any person to use a portable electronic device (PED) on board an aircraft that could adversely affect the performance of the aircraft's systems and equipment, and shall take all reasonable measures to prevent such use.

AMC1 CAT.GEN.MPA.140 Portable electronic devices

ED Decision 2019/008/R

TECHNICAL PREREQUISITES FOR THE USE OF PEDS

(a) Scope

This AMC describes the technical prerequisites under which any kind of portable electronic device (PED) may be used on board the aircraft without adversely affecting the performance of the aircraft's systems and equipment.

(b) Prerequisites concerning the aircraft configuration

- (1) Before an operator may permit the use of any kind of PED on-board, it should ensure that PEDs have no impact on the safe operation of the aircraft. The operator should demonstrate that PEDs do not interfere with on-board electronic systems and equipment, especially with the aircraft's navigation and communication systems.
- (2) The assessment of PED tolerance may be tailored to the different aircraft zones for which the use of PEDs is considered, i.e. may address separately:
 - (i) the passenger compartment;
 - (ii) the flight crew compartment; and
 - (iii) areas not accessible during the flight.

(c) Scenarios for permitting the use of PEDs

- (1) Possible scenarios, under which the operator may permit the use of PEDs, should be as documented in Table 1. The scenarios in Table 1 are listed in a descending order with the least permitting scenario at the bottom.
- (2) Restrictions arising from the corresponding aircraft certification, as documented in the aircraft flight manual (AFM) or equivalent document(s), should stay in force. They may be linked to different aircraft zones, or to particular transmitting technologies covered.
- (3) For Scenarios Nos. 3 to 8 in Table 1 the use of C-PEDs and cargo tracking devices may be further expanded, when the EMI assessment has demonstrated that there is no impact on safety as follows:
 - (i) for C-PEDs by using the method described in (d)(2); and
 - (ii) for cargo tracking devices by using the method described in (d)(3).

Table 1 – Scenarios for permitting the use of PEDs by the operator

No.	Technical condition	Non-intentional transmitters	T-PEDs
1	The aircraft is certified as T-PED tolerant, i.e. it has been demonstrated during the aircraft certification process that front door and back door coupling have no impact on the safe operation of the aircraft	All phases of flight	All phases of flight
2	A complete electromagnetic interference (EMI) assessment for all technologies, using the method described in (d)(1), has been performed and has demonstrated the T-PED tolerance	All phases of flight	All phases of flight

No.	Technical condition	Non-intentional transmitters	T-PEDs
3	The aircraft is certified for the use of T-PEDs using particular technologies (e.g. WLAN or mobile phone)	All phases of flight	All phases of flight, restricted to those particular technologies
4	The EMI assessment, using the method described in (d)(1), has demonstrated that: (a) the front door coupling has no impact on safety; and (b) the back door coupling has no impact on safety when using particular technologies (e.g. WLAN or mobile phone)	All phases of flight	All phases of flight, restricted to those particular technologies
5	The EMI assessment, using the method described in (d)(1)(i), has demonstrated that the front door coupling has no impact on safety caused by non-intentional transmitters	All phases of flight	Not permitted
6	The EMI assessment, using the method described in (d)(1)(ii), has demonstrated that the back door coupling has no impact on safety when using particular technologies (e.g. WLAN or mobile phone)	All phases of flight - except low visibility approach operation	All phases of flight - except low visibility approach operation, restricted to those particular technologies
7	An EMI assessment has not been performed	All phases of flight - except low visibility approach operation	Not permitted
8	Notwithstanding Scenarios Nos. 3 to 7	(a) before taxi-out; (b) during taxi-in after the end of landing roll; and (c) the commander may permit the use during prolonged departure delays, provided that sufficient time is available to check the passenger compartment before the flight proceeds	

(d) Demonstration of electromagnetic compatibility

(1) EMI assessment at aircraft level

The means to demonstrate that the radio frequency (RF) emissions (intentional or non-intentional) are tolerated by aircraft systems should be as follows:

(i) to address front door coupling susceptibility for any kind of PEDs:

- (A) EUROCAE, ‘Guidance for the use of Portable Electronic Devices (PEDs) on Board Aircraft’, ED-130A / RTCA DO-363 ‘Guidance for the Development of Portable Electronic Devices (PED) Tolerance for Civil Aircraft’, Section 5; or
- (B) EUROCAE, ‘Aircraft Design and Certification for Portable Electronic Device (PED) Tolerance’, ED-239 / RTCA DO-307A, Section 4;

The use of RTCA, ‘Guidance on Allowing Transmitting Portable Electronic Devices (T PEDs) on Aircraft’, DO-294C (or later revisions), Appendix 5C; or RTCA DO-307 ‘Aircraft Design and Certification for Portable Electronic Device (PED) Tolerance’, (including Change 1 or later revisions), Section 4 may be acceptable.

- (ii) to address back door coupling susceptibility for T-PEDs:
 - (A) EUROCAE, 'Guidance for the use of portable electronic devices (PEDs) on board aircraft', ED-130A/RTCA DO-363, Section 6; or
 - (B) EUROCAE, 'Aircraft Design and Certification for Portable Electronic Device (PED) Tolerance', ED-239 / RTCA DO-307A, Section 3; or
 - (C) The use of EUROCAE, 'Guidance for the use of Portable Electronic Devices (PEDs) on Board Aircraft', ED-130, Annex 6; or RTCA DO-294C (or later revisions), Appendix 6D; or RTCA DO-307 (including Change 1 or later revisions), Section 3 may be acceptable.
- (2) Alternative EMI assessment of controlled PEDs (C-PEDs)
 - (i) To address front door coupling:
 - (A) C-PEDs should comply with the levels as defined by:
 - (a) EUROCAE/RTCA, 'Environmental conditions and test procedures for airborne equipment', ED-14D/DO-160D (or later revisions), Section 21, Category M, for operation in the passenger compartment and the flight crew compartment; and
 - (b) EUROCAE ED-14D/RTCA DO-160D (or later revisions), Section 21, Category H, for operation in areas not accessible during the flight.
 - (B) If the C-PEDs are electronic flight bags used in the flight crew compartment and if the DO-160 testing described in (A) identifies inadequate margins for interference or has not been performed, it is necessary to test the C-PED in each aircraft model in which it will be operated. The C-PED should be tested in operation on the aircraft to show that no interference with aircraft equipment occurs. Credit may be given to other aircraft that are similarly equipped (meaning in particular that they contain the same avionics equipment) of the same make and model as the one tested.
 - (ii) To address back door coupling susceptibility for C-PEDs with transmitting capabilities, the EMI assessment described in (1)(ii) should be performed.

(3) Alternative EMI assessment of cargo tracking devices

In cases where a transmitting function is automatically deactivated in a cargo tracking device that is a T-PED, the unit should be qualified for safe operation on board the aircraft. One of the following methods should be considered to be acceptable as evidence of its safe operation:

- (i) A type-specific safety assessment, including failure mode and effects analysis, has been performed at the aircraft level. The main purpose of the assessment should be to determine the hazards and to demonstrate that the design assurance levels of the relevant hardware and software components of the cargo tracking device are adequate.
- (ii) The high intensity radiated field (HIRF) certification of the aircraft has been performed, i.e. the aircraft type has been certified after 1987 and meets the appropriate special condition. In such a case, the operator should ensure that the following conditions are met:
 - (A) The tracking device:

- (a) features an automated and prolonged radio suspension in flight using multiple modes of redundancy; and
 - (b) has been verified in the aircraft environment to ensure deactivation of the transmitting function in flight.
 - (B) The emissions from the tracking device comply with the levels as defined by EUROCAE ED-14E/RTCA DO-160E (or later revisions), Section 21, Category H.
 - (C) The operator should ensure that the following documents are provided by the tracking device manufacturer:
 - (a) a declaration from the manufacturer identifying the device and confirming that the device and its deactivation function comply with the requirement (A) and (B) above;
 - (b) a declaration showing that robust design and production controls are in place during the manufacturing of the tracking device;
 - (c) a declaration of conformity and technical documentation showing compliance with the European Norms (EN), regulating the transmitter characteristics of the tracking device or its transmission module; and
 - (d) the EMI assessment report documenting compliance with point (B) above.
 - (iii) The tracking device interference levels during transmission are below those considered acceptable for the specific aircraft environment.
- (e) Operational conditions of C-PEDs and cargo tracking devices

The operator should ensure that C-PEDs and cargo tracking devices are maintained in good and safe condition, having in mind that:

 - (1) damage may modify their emissions characteristics; and
 - (2) damage to the battery may create a fire hazard.
- (f) Batteries in C-PEDs and cargo tracking devices

Lithium-type batteries in C-PEDs and cargo tracking devices should meet:

 - (1) United Nations (UN) Transportation Regulations, 'Recommendations on the transport of dangerous goods - manual of tests and criteria', UN ST/SG/AC.10/11; and
 - (2) one of the following standards:
 - (i) Underwriters Laboratory, 'Lithium batteries', UL 1642;
 - (ii) Underwriters Laboratory, 'Household and commercial batteries', UL 2054;
 - (iii) Underwriters Laboratory, 'Information technology equipment – safety', UL 60950-1;
 - (iv) International Electrotechnical Commission (IEC), 'Secondary cells and batteries containing alkaline or other non-acid electrolytes - safety requirements for portable sealed secondary cells, and for batteries made from them, for use in portable applications', IEC 62133;
 - (v) RTCA, 'Minimum operational performance standards for rechargeable lithium battery systems', DO-311. RTCA DO-311 may be used to address concerns regarding overcharging, over-discharging, and the flammability of cell

components. The standard is intended to test permanently installed equipment; however, these tests are applicable and sufficient to test electronic flight bags rechargeable lithium-type batteries; or

- (vi) European Technical Standard Order (ETSO), 'Non-rechargeable lithium cells and batteries', ETSO C142a.

AMC2 CAT.GEN.MPA.140 Portable electronic devices

ED Decision 2014/029/R

PROCEDURES FOR THE USE OF PEDS

(a) Scope

This AMC describes the procedures under which any kind of portable electronic device (PED) may be used on board the aircraft without adversely affecting the performance of the aircraft's systems and equipment. This AMC addresses the operation of PEDs in the different aircraft zones — passenger compartment, flight compartment, and areas inaccessible during the flight.

(b) Prerequisites

Before permitting the use of any kind of PEDs the operator should ensure compliance with (c) of [AMC1 CAT.GEN.MPA.140](#).

(c) Hazard identification and risk assessment

The operator should identify the safety hazards and manage the associated risks following the management system implemented in accordance with [ORO.GEN.200](#). The risk assessment should include hazards associated with:

- (1) PEDs in different aircraft zones;
- (2) PED use during various phases of flight;
- (3) PED use during turbulence;
- (4) improperly stowed PEDs;
- (5) impeded or slowed evacuations;
- (6) passenger non-compliance, e.g. not deactivating transmitting functions, not switching off PEDs or not stowing PEDs properly;
- (7) disruptive passengers; and
- (8) battery fire.

(d) Use of PEDs in the passenger compartment

(1) Procedures and training

If an operator permits passengers to use PEDs on board its aircraft, procedures should be in place to control their use. These procedures should include provisions for passenger briefing, passenger handling and for the stowage of PEDs. The operator should ensure that all crew members and ground personnel are trained to enforce possible restrictions concerning the use of PEDs, in line with these procedures.

-
- (2) Provisions for use
- (i) The use of PEDs in the passenger compartment may be granted under the responsibility of the operator, i.e. the operator decides which PED may be used during which phases of the flight.
 - (ii) Notwithstanding (b), medical equipment necessary to support physiological functions may be used at all times and does not need to be switched-off.
- (3) Stowage, passenger information and passenger briefing of PEDs
- (i) In accordance with [CAT.OP.MPA.160](#) the operator should establish procedures concerning the stowage of PEDs. The operator should:
 - (A) identify the phases of flight in which PEDs are to be stowed; and
 - (B) determine suitable stowage locations, taking into account the PEDs' size and weight.
 - (ii) The operator should provide general information on the use of PEDs to the passengers before the flight. This information should specify at least:
 - (A) which PEDs can be used during which phases of the flight;
 - (B) when and where PEDs are to be stowed; and
 - (C) that the instructions of the crew are to be followed at all times.
 - (iii) In accordance with [CAT.OP.MPA.170](#), the use of PEDs should be part of the passenger briefings. The operator should remind passengers to pay attention and to avoid distraction during such briefings.
- (4) In-seat electrical power supplies
- Where in-seat electrical power supplies are available for passenger use, the following should apply:
- (i) information giving safety instructions should be provided to the passengers;
 - (ii) PEDs should be disconnected from any in-seat electrical power supply during taxiing, take-off, approach, landing, and during abnormal or emergency conditions; and
 - (iii) flight crew, cabin crew and technical crew should be aware of the proper means to switch-off in-seat power supplies used for PEDs.
- (5) Operator's safety measures during boarding and any phase of flight
- (i) Appropriate coordination between flight crew, cabin crew and technical crew should be established to deal with interference or other safety problems associated with PEDs.
 - (ii) Suspect equipment should be switched off.
 - (iii) Particular attention should be given to passenger misuse of equipment.
 - (iv) Thermal runaways of batteries, in particular lithium batteries, and potential resulting fire, should be handled properly.
 - (v) The commander may, for any reason and during any phase of flight, require deactivation and stowage of PEDs.

- (vi) When the operator restricts the use of PEDs, consideration should be given to handle special requests to operate a T-PED during any phase of the flight for specific reasons (e.g. for security measures).

(6) Reporting

Occurrences of suspected or confirmed interference should be reported to the competent authority. Where possible, to assist follow-up and technical investigation, reports should describe the suspected device, identify the brand name and model number, its location in the aircraft at the time of the occurrence, interference symptoms, the device user's contact details and the results of actions taken by the crew.

(e) Use of PEDs in the flight crew compartment

In the flight crew compartment the operator may permit the use of PEDs, e.g. to assist the flight crew in their duties, when procedures are in place to ensure the following:

- (1) The conditions for the use of PEDs in-flight are specified in the operations manual.
- (2) The PEDs do not pose a loose item risk or other hazard.
- (3) These provisions should not preclude use of a T-PED (specifically a mobile phone) by the flight crew to deal with an emergency. However, reliance should not be predicated on a T-PED for this purpose.

(f) PEDs not accessible during the flight

PEDs should be switched off, when not accessible for deactivation during flight. This should apply especially to PEDs contained in baggage or transported as part of the cargo. The operator may permit deviation for PEDs for which safe operation has been demonstrated in accordance with [AMC1 CAT.GEN.MPA.140](#). Other precautions, such as transporting in shielded metal boxes, may also be used to mitigate associated risks.

GM1 CAT.GEN.MPA.140 Portable electronic devices

ED Decision 2019/008/R

DEFINITIONS

(a) Categories of PEDs

PEDs include the following two categories:

- (1) Non-intentional transmitters can non-intentionally radiate RF transmissions, sometimes referred to as spurious emissions. This category includes, but is not limited to, calculators, cameras, radio receivers, audio and video players, electronic games and toys; when these devices are not equipped with a transmitting function.
- (2) Intentional transmitters radiate RF transmissions on specific frequencies as part of their intended function. In addition, they may radiate non-intentional transmissions like any PED. The term 'transmitting PED' (T-PED) is used to identify the transmitting capability of the PED. Intentional transmitters are transmitting devices such as RF-based remote control equipment, which may include some toys, two-way radios (sometimes referred to as 'private mobile radio'), mobile phones of any type, satellite phones, computers with mobile phone data connection, wireless local area network (WLAN) or Bluetooth capability. After deactivation of the transmitting capability, e.g. by activating the so-called 'flight mode' or 'flight safety mode', the T-PED remains a PED having non-intentional emissions.

(b) Cargo tracking device

A cargo tracking device is a PED attached to or included in airfreight (e.g. in or on containers, pallets, parcels or baggage). Cargo tracking devices can be assigned to the category of non-intentional transmitters or T-PEDs. If the device is a T-PED, it complies with the European Norms (EN) for transmissions.

(c) Definition of the switched-off status

Many PEDs are not completely disconnected from the internal power source when switched off. The switching function may leave some remaining functionality e.g. data storage, timer, clock, etc. These devices can be considered switched off when in the deactivated status. The same applies to devices having no transmitting capability and are operated by coin cells without further deactivation capability, e.g. wrist watches.

(d) Electromagnetic interference (EMI)

The two classes of EMI to be addressed can be described as follows:

- (1) Front door coupling is the possible disturbance to an aircraft system as received by the antenna of the system and mainly in the frequency band used by the system. Any PED internal oscillation has the potential to radiate low level signals in the aviation frequency bands. Through this disturbance especially the instrument landing system (ILS) and the VHF omni range (VOR) navigation system may indicate erroneous information.
- (2) Back door coupling is the possible disturbance of aircraft systems by electromagnetic fields generated by transmitters at a level which could exceed on short distance (i.e. within the aircraft) the electromagnetic field level used for the aircraft system certification. This disturbance may then lead to system malfunction.

GM2 CAT.GEN.MPA.140 Portable electronic devices

ED Decision 2014/029/R

CREW REST COMPARTMENT, NAVIGATION, TEST ENTITIES AND FIRE CAUSED BY PEDS

- (a) When the aircraft is equipped with a crew rest compartment, it is considered being part of the passenger compartment.
- (b) Front door coupling may influence the VOR navigation system. Therefore, the flight crew monitors other navigation sensors to detect potential disturbances by PEDs, especially during low visibility departure operation based on VOR guidance.
- (c) Specific equipment, knowledge and experience are required, when the industry standards for evaluating technical prerequisites for the use of PEDs are applied. In order to ensure conformity with the industry standards, the operator is encouraged to cooperate with an appropriately qualified and experienced entity, as necessary. For this entity an aviation background is not required, but is considered to be beneficial.
- (d) Guidance to follow in case of fire caused by PEDs is provided by the International Civil Aviation Organisation, 'Emergency response guidance for aircraft incidents involving dangerous goods', ICAO Doc 9481-AN/928.

GM3 CAT.GEN.MPA.140 Portable electronic devices

ED Decision 2019/008/R

EVALUATION OF CARGO TRACKING DEVICES

(a) Safety assessment

Further guidance on performing a safety assessment can be found in:

- (1) EASA, 'Certification specifications and acceptable means of compliance for large aeroplanes', CS-25, Book 2, AMC-Subpart F, AMC 25.1309;
- (2) EUROCAE/SAE, 'Guidelines for development of civil aircraft and systems', ED-79/ARP 4754 (or later revisions); and
- (3) SAE, 'Guidelines and methods for conducting the safety assessment process on civil airborne systems and equipment', ARP 4761 (or later revisions).

(b) HIRF certification

The type certificate data sheet (TCDS), available on the EASA website for each aircraft model having EASA certification, lists whether the HIRF certification has been performed through a special condition. The operator may contact the type certification holder to gain the necessary information.

(c) Multiple modes of redundancy

Multiple modes of redundancy means that the device is designed with a minimum of two independent means to turn it off completely, turn off the cellular or mobile functions, or a combination of both when airborne. These independent methods should use different sources to identify that the aircraft is in flight, for example, a cargo-tracking device may be designed to sense rapid altitude changes and acceleration to determine when to turn off cellular transmissions. Redundant sources of the same information, such as two vertical accelerometers, should not be considered independent.

CAT.GEN.MPA.141 Use of electronic flight bags (EFBs)

Regulation (EU) 2018/1975

- (a) Where an EFB is used on board an aircraft, the operator shall ensure that it does not adversely affect the performance of the aircraft systems or equipment, or the ability of the flight crew member to operate the aircraft.
- (b) The operator shall not use a type B EFB application unless it is approved in accordance with Subpart M of Annex V (Part-SPA).

GM1 CAT.GEN.MPA.141 Use of electronic flight bags (EFBs)

ED Decision 2019/008/R

DEFINITIONS

For the purpose of EFB use, the following definitions apply:

(a) Aircraft administrative communications (AAC):

AAC are defined by ICAO as non-safety communications that are used by aeronautical operating agencies and are related to the business aspects of operating their flights and transport services. These communications are used for a variety of purposes, such as flight and ground transportation, bookings, deployment of crew, and aircraft or any other logistical purposes that

maintain or enhance the efficiency of overall flight operations. AAC data links receive/transmit information that includes, but is not limited to, the support of EFB applications.

(b) Aeronautical operational control (AOC):

AOC communications are defined by ICAO as communications required for the exercise of authority over the initiation, continuation, diversion or termination of flight for safety, regularity, and efficiency reasons.

GM2 CAT.GEN.MPA.141 Use of electronic flight bags (EFBs)

ED Decision 2019/008/R

BACKGROUND INFORMATION

Further related information on EFB hardware and EFB applications can be found in the following documents:

- (a) EASA AMC 20-25, Airworthiness considerations for EFBs;
- (b) EASA CS-25, Book 2, AMC Subpart F, AMC 25.1309, System Design and Analysis;
- (c) EUROCAE ED-14D/DO-160D (or later revisions) Environmental Conditions and Test Procedures for Airborne Equipment;
- (d) EASA ETSO-C165A, Electronic Map Systems for Graphical Depiction of Aircraft Position;
- (e) FAA AC 120-76(C), Authorization for an Electronic Flight Bag Program;
- (f) FAA AC 120-78, Electronic Signatures, Electronic Recordkeeping, and Electronic Manuals;
- (g) ICAO Doc 10020, Manual of Electronic Flight Bags (EFBs).

AMC1 CAT.GEN.MPA.141(a) Use of electronic flight bags (EFBs)

ED Decision 2019/008/R

HARDWARE

Before using a portable EFB, the following considerations should be assessed by the operator:

(a) General

A portable EFB is a portable electronic device (PED) and may host type A and/or type B EFB applications. In addition, it may host miscellaneous software applications. Portable EFBs are controlled PEDs (C-PEDs).

A portable EFB should be capable of operation autonomously inside and outside the aircraft.

The mass, dimensions, shape, and position of the portable EFB should not compromise flight safety.

The power supply of a portable EFB may be provided by aircraft sources through an adequate power source.

If mounted or stowed, a portable EFB should be easily removable from its mounting device/viewable stowage device or attached to it, without the use of tools by the flight crew. Any locking devices used to prevent theft should be unlocked during flight.

A portable EFB may be part of a system that contains EFB-installed resources which are part of the certified aircraft configuration. The intended functions of the EFB-installed components may be to mount the EFB onto the aircraft and/or connect it to other systems.

Portable EFBs may be used in all phases of the flight if secured to a certified mount or securely attached to a viewable stowage device in a manner that allows its use.

Portable EFBs that do not meet the above characteristics should be stowed during critical phases of the flight.

However, this does not preclude a flight crew from using a portable EFB during restricted portions of the critical phases of flight to complete a task related to the safety of the flight on the condition that the device is continuously handheld and used only during a short period of time. When the task is completed, the device should be stowed again.

Any EFB component that is either not accessible in the flight crew compartment by the flight crew members or not removable by the flight crew members should be installed as 'certified equipment' covered by a type certificate (TC), a change to a TC or a supplemental (S)TC.

(b) Characteristics and placement of the EFB display

For a portable EFB, the considerations on the location of the display proposed below should apply to the proposed location of the display when the EFB is in use.

The EFB display and any other elements of the EFB system should be placed in such a way that they do not unduly impair the flight crew's external view during any of the phases of the flight. Equally, they should not impair the view of or access to any flight-crew-compartment control or instrument.

The location of the display unit and the other EFB system elements should be assessed for their possible impact on egress requirements.

When the EFB is in use (intended to be viewed or controlled), its display should be within 90 degrees on either side of each flight crew member's line of sight.

Glare and reflection on the EFB display should not interfere with the normal duties of the flight crew.

(c) Power source

If the aircraft is equipped with electrical power outlet(s) in the flight crew compartment, the operator should ensure that their certified characteristics are compatible with the intended use of the EFB system. The powering or charging of the EFB system should be compatible with the electrical characteristics of the power supplied by the outlets in terms of power consumption, voltage, frequency, etc., not to impair the EFB system or other aircraft systems.

(d) EFB data connectivity

Portable EFBs may have data connectivity to aircraft systems, either wired or wireless, provided that the connections (hardware and software for data connection provisions) and adequate interface protection devices are incorporated into the aircraft type design.

A portable EFB may receive any data from aircraft systems, but data transmission from EFBs should be limited to aircraft systems that have been certified for this intended purpose (refer to AMC 20-25 for more details).

(e) External connecting cables (to avionics and/or power sources)

When external cables are used to connect a portable EFB to the aircraft systems and/or to a power source, the following should apply:

- (1) cables should not hang loosely in a way that compromises task performance and safety; flight crew members should be able to easily secure the cables out of the way during operations (e.g. by using cable tether straps); and

- (2) cables should be of sufficient length so that they do not obstruct the use of any movable device (e.g. flight controls, switches, seats, windows) in the flight crew compartment.
- (f) Electromagnetic interference (EMI) demonstrations
See paragraph (b), (c) and (d) of [AMC1 CAT.GEN.MPA.140](#).
The EMI demonstration should cover any cable connected to the EFB as well as non-certified power chargers.
- (g) Batteries
See paragraph (f) of [AMC1 CAT.GEN.MPA.140](#).
- (h) Viewable stowage
The evaluation of the viewable stowage should be performed for a given location in the flight deck. This location should be documented and this information should be part of the EFB policy.
The viewable stowage should not be positioned in such a way that it creates significant obstruction to the flight crew members' view or hinders physical access to aircraft controls and/or displays and/or aircraft safety equipment, flight crew ingress or egress. The viewable stowage as positioned should allow the flight crew to retain a sufficiently extensive, clear, and undistorted view, to enable them to safely perform any manoeuvres within the operating limitations of the aircraft, including taxiing, take-off, approach, and landing. The design of the viewable stowage should allow the user easy access to any item of the EFB system, even if stowed, and notably to the EFB controls and a clear view of the EFB display while in use. The following design practices should be considered:
- (1) The viewable stowage and associated mechanisms should not impede the flight crew members in the performance of any task (whether normal, abnormal, or emergency) associated with operating any aircraft system;
 - (2) When the viewable stowage is used to secure an EFB display, it should be able to be easily locked in position. If necessary, the selection of positions should be adjustable enough to accommodate a range of flight crew member preferences. In addition, the range of available movement should accommodate the expected range of users' physical abilities (i.e. anthropometric constraints). Locking mechanisms should be of a low-wear type that will minimise slippage even after extended periods of normal use;
 - (3) The viewable stowage should be designed and installed so that it will sustain all foreseeable conditions relative to the flight environment (e.g. severe turbulence, hard landings) while retaining its structural integrity and without becoming detached. The use of restraints of the device should be considered where appropriate;
 - (4) A provision should be available to secure or lock the device in a position out of the way of flight crew operations when not in use. When stowed, the device and its securing mechanism should not intrude into the flight crew compartment space to the extent that they cause either visual or physical obstruction of flight controls/displays and/or ingress/egress routes;
 - (5) Possible mechanical interference issues of the viewable stowage, either on the side panel (side stick controller), or on the control yoke, in terms of full and free movement under all operating conditions and non-interference with buckles, etc., should be prevented;
 - (6) Adequate means should be provided (e.g. hardware or software) to shut down the portable EFB when its controls are not accessible by the flight crew members when strapped in the normal seated position; and

- (7) The viewable stowage device should be easily removable from the aircraft without the use of tools.

Some types of means for securing viewable stowage may have characteristics that degrade noticeably with ageing or due to various environmental factors. In that case, the documentation should include procedures (e.g. crew procedures, checks, or maintenance actions) to ensure that the stowage characteristics remain within acceptable limits for the proposed operations. Securing means based on vacuums (e.g. suction cups) have holding capacities that decrease with pressure. It should be demonstrated that they will still perform their intended function at operating cabin altitudes or in the event of a rapid decompression.

In addition, it should be demonstrated that if the EFB moves or is separated from its stowage, or if the viewable stowage is unsecured from the aircraft (as a result of turbulence, manoeuvring, or other action), it will not jam flight controls, damage flight deck equipment, or injure flight crew members.

The risks associated with an EFB fire should be minimised by the design and location of the viewable stowage.

GM1 CAT.GEN.MPA.141(a) Use of electronic flight bags (EFBs)

ED Decision 2019/008/R

VIEWABLE STOWAGE

- (a) Viewable stowage devices have been involved in several reported incidents worldwide. The following issues should be considered by the operator when assessing the compliance of a viewable stowage device:
- (1) The EFB or EFB stowage interfering with controls (e.g. side sticks, tillers, PTT switches, etc.);
 - (2) Stowage or EFB cables interfering with the opening of windows;
 - (3) Stowage or EFB cables interfering with the access to oxygen masks;
 - (4) The EFB falling during take-off, cruise, or landing, interfering with flight controls, disengaging the autopilot, or hurting the flight crew; and
 - (5) Suction cups detaching following a loss of pressurisation, adding to the crew's workload.
- (b) Guidance on the safety, reliability and usability of different viewable stowage solutions and on the related operating conditions can be found in a study published by the FAA¹.

With regard to the specific example of suction cups, the following means of mitigation are recommended:

- (1) The suction cups and the surface to which they will be attached should be properly cleaned with isopropyl alcohol or aircraft window cleaner prior to attachment of the suction cups;
- (2) Attachment surfaces should be substantially smooth and flat;
- (3) Periodic cleaning and reattachment should be performed, as appropriate, for the conditions of the environment in which they are used (dusty, etc.);

¹ <http://fsims.faa.gov/wdocs/other/efb%20securing%20solutions%20environmental%20test%20report.pdf>

- (4) Suction cups should not be left attached to the aircraft windscreen for long periods of time;
- (5) Suction cups should be replaced every 6 months at a minimum, and, more often in extreme environments.

AMC1 CAT.GEN.MPA.141(b) Use of electronic flight bags (EFBs)

ED Decision 2019/008/R

APPLICATION CLASSIFICATION

An EFB software application is an application that is not part of the configuration of the certified aircraft and is installed on an EFB system to support flight operations. The classification of the applications, based on their respective safety effects, is intended to provide clear divisions between such applications and, therefore, between the assessment processes applied to each.

For the purpose of the following process, 'malfunction or misuse' means any failure, malfunction of the application, or design-related human errors that can reasonably be expected in service.

- (a) Determination of an application type:

[AMC2 CAT.GEN.MPA.141\(b\)](#) and [AMC3 CAT.GEN.MPA.141\(b\)](#) should be used to justify a classification, provided that the application does not feature design or functional novelties that introduce new forms of crew interaction or unusual procedures.

An application may also be recognised as a type A or type B EFB application through an appropriate approval (e.g. ETSO authorisation) granted by EASA.

If an application is not listed in [AMC2](#) or [AMC3 CAT.GEN.MPA.141\(b\)](#), presents a high degree of novelty, or is not covered by an EASA approval (e.g. ETSO authorisation), the classification should be established using the definitions and criteria provided hereafter.

As a first step, it should be verified that the application does not belong to the following list of applications that are not eligible for classification as either type A or type B EFB applications.

Applications that:

- (1) display information which is tactically used by the flight crew members to check, control or deduce the aircraft position or trajectory, either to follow the intended navigation route or to avoid adverse weather, obstacles or traffic during the flight;
- (2) display information which may be directly used by the flight crew members to assess the real-time status of aircraft critical and essential systems, as a replacement for existing installed avionics, and/or to manage aircraft critical and essential systems following a failure;
- (3) send data to air traffic services;

are not eligible to be classified as either type A or type B EFB applications.

Then, the next steps in this process should be to:

- (1) identify any failure conditions resulting from potential losses of function or malfunction (with either detected or undetected erroneous outputs), taking into consideration any relevant factors (e.g. aircraft/system failures, operational or environmental conditions) and any established mitigation (e.g. flight crew procedures, flight crew training) that would intensify or alleviate the effects; and

- (2) classify the application as follows, based on the assessment of the safety effect of each failure condition:
 - (i) if there is no failure condition that may have a safety effect, the application should be classified as a type A EFB application;
 - (ii) if one or several failure conditions with a safety effect that is limited to minor are identified, the application should be classified as type B;
 - (iii) if more severe failure conditions are identified, the application should not be eligible for classification as an EFB application.

Software applications with failure conditions that are classified as more severe than minor are ineligible as type A or type B EFB applications.

Notes:

- The severity of the failure conditions linked to displaying a function that already exists in the certified type design, or that is already authorised through an ETSO, and used with same concept of operation (considering the intended function but also operational means of mitigation), should be considered in the assessment of the severity of the failure condition of an application and cannot be less than the severity already assessed for this function.
- The data resulting from this process may be reused by the operators in the context of the EFB risk assessment process.

(b) Miscellaneous software applications

Miscellaneous software applications are applications that support function(s) that are not directly related to operations conducted by the flight crew on the aircraft. Miscellaneous software applications are not considered to be EFB applications for the purposes of this AMC.

Examples of miscellaneous software applications are web browsers (not used for operational purposes), email clients, picture management applications, or even applications used by ground crews (e.g. for maintenance purposes).

AMC2 CAT.GEN.MPA.141(b) Use of electronic flight bags (EFBs)

ED Decision 2019/008/R

TYPICAL TYPE A EFB APPLICATIONS

The following EFB application should be considered type A EFB applications:

- (a) browsers that display:
 - (1) the certificates and other documents which are required to be carried by the applicable operational regulations, including digitally created documents such as:
 - (i) the certificate of registration;
 - (ii) the certificate of airworthiness (CofA);
 - (iii) the noise certificate, and its English translation if applicable;
 - (iv) the air operator certificate (AOC);
 - (v) the operations specifications relevant to the aircraft type, issued with the AOC;
 - (vi) the third-party liability insurance certificate(s); and

- (vii) the aircraft continuing airworthiness records, including the technical log (flight crew view thereof);
- (2) some manuals and additional information and forms which are required to be carried by the applicable operational regulations such as:
 - (i) notifications of special categories of passenger (SCPs) and special loads; and
 - (ii) passenger and cargo manifests, if applicable; and
- (3) other information within the operator's aircraft library such as:
 - (i) airport diversion policy guidance, including a list of special designated airports and/or approved airports with emergency medical service (EMS) support facilities;
 - (ii) maintenance manuals;
 - (iii) emergency response guidance for aircraft incidents involving dangerous goods (see ICAO Doc 9481-AN/928);
 - (iv) aircraft parts manuals;
 - (v) service bulletins/published airworthiness directives, etc.;
 - (vi) current fuel prices at various airports;
 - (vii) trip scheduling and bid lists;
 - (viii) passenger information requests;
 - (ix) examiner and flight instructor records; and
 - (x) flight crew currency requirements;
- (b) interactive applications for crew rest calculations in the framework of flight time limitations;
- (c) interactive forms to comply with the reporting requirements of the competent authority and the operator;
- (d) applications that make use of aircraft administrative communications (AAC) to collect, process and then disseminate data that has no effect on the safe operation of an aircraft.

AMC3 CAT.GEN.MPA.141(b) Use of electronic flight bags (EFBs)

ED Decision 2019/008/R

TYPICAL TYPE B EFB APPLICATIONS

The following EFB applications should be considered type B EFB applications, provided that they do not feature design or functional novelties that introduce new forms of crew interaction or unusual procedures:

- (a) Document browsers that display the manuals and additional information and forms required to be carried by regulations and that are necessary for the safe operation of the aircraft, such as:
 - (1) the operations manual (including the minimum equipment list (MEL) and configuration deviation list (CDL));
 - (2) the aircraft flight manual, or equivalent document;
 - (3) the operational flight plan;
 - (4) meteorological information with graphical interpretation;
 - (5) air traffic services (ATS) flight plan;

- (6) notices to airmen (NOTAMs) and aeronautical information service (AIS) briefing documentation.
- (b) Electronic aeronautical chart applications including en-route, area, approach, and airport surface maps.
- (c) Airport moving map display (AMMD) applications.
- (d) Applications that make use of the aeronautical operational control (AOC) communications to collect, process and then disseminate operational data.
- (e) Aircraft performance calculation applications that use algorithmic data or that perform calculations using software algorithms to provide aircraft performance data such as:
 - (1) take-off, en-route, approach and landing, missed approach and other phases of flight, performance calculations providing limiting masses, distances, times and/or speeds, etc.;
 - (2) power settings, including reduced take-off thrust settings, etc.
- (f) Mass and balance calculation applications used to establish the mass and centre of gravity of the aircraft and to determine that the load and its distribution are such that the mass and balance limits of the aircraft are not exceeded.
- (g) Applications providing in-flight weather information.

GM1 CAT.GEN.MPA.141(b) Use of electronic flight bags (EFBs)

ED Decision 2019/008/R

TACTICAL USE

The tactical use of an EFB application is considered to be related to short-term decision-making, while strategic use is related to long-term decision-making support.

GM2 CAT.GEN.MPA.141(b) Use of electronic flight bags (EFBs)

ED Decision 2019/008/R

HUMAN-MACHINE INTERFACE (HMI) FOR TYPE A EFB APPLICATIONS

An HMI assessment is not required for a type A EFB application. However, type A EFB applications should be designed in accordance with the human factor principles in order to minimise their impacts on crew workload.

CAT.GEN.MPA.145 Information on emergency and survival equipment carried

Regulation (EU) No 965/2012

The operator shall at all times have available for immediate communication to rescue coordination centres (RCCs) lists containing information on the emergency and survival equipment carried on board any of their aircraft.

AMC1 CAT.GEN.MPA.145 Information on emergency and survival equipment carried

ED Decision 2014/015/R

ITEMS FOR COMMUNICATION TO THE RESCUE COORDINATION CENTRE

The information, compiled in a list, should include, as applicable, the number, colour and type of life rafts and pyrotechnics, details of emergency medical supplies, e.g. first-aid kits, emergency medical kits, water supplies and the type and frequencies of emergency portable radio equipment.

CAT.GEN.MPA.150 Ditching — aeroplanes

Regulation (EU) 2019/1384

The operator shall only operate an aeroplane with a passenger seating configuration of more than 30 on overwater flights at a distance from land suitable for making an emergency landing, greater than 120 minutes at cruising speed, or 400 NM, whichever is less, if the aeroplane complies with the ditching provisions prescribed in the applicable certification specification or specifications.

CAT.GEN.MPA.155 Carriage of weapons of war and munitions of war

Regulation (EU) No 965/2012

- (a) The operator shall only transport weapons of war or munitions of war by air if an approval to do so has been granted by all States whose airspace is intended to be used for the flight.
- (b) Where an approval has been granted, the operator shall ensure that weapons of war and munitions of war are:
 - (1) stowed in the aircraft in a place that is inaccessible to passengers during flight; and
 - (2) in the case of firearms, unloaded.
- (c) The operator shall ensure that, before a flight begins, the commander is notified of the details and location on board the aircraft of any weapons of war and munitions of war intended to be carried.

GM1 CAT.GEN.MPA.155 Carriage of weapons of war and munitions of war

ED Decision 2015/007/R

WEAPONS OF WAR AND MUNITIONS OF WAR

- (a) In accordance with Regulation (EC) No 300/2008, weapons of war may be carried on board an aircraft, in a place that is not inaccessible, if the required security conditions in accordance with national laws have been fulfilled and authorisation has been given by the States involved.
- (b) There is no internationally agreed definition of weapons of war and munitions of war. Some States may have defined them for their particular purposes or for national need.
- (c) It is the responsibility of the operator to check, with the State(s) concerned, whether or not a particular weapon or munition is regarded as a weapon of war or munitions of war. In this context, States that may be concerned with granting approvals for the carriage of weapons of war or munitions of war are those of origin, transit, overflight and destination of the consignment and the State of the operator.

- (d) Where weapons of war or munitions of war are also dangerous goods by definition (e.g. torpedoes, bombs, etc.), [CAT.GEN.MPA.200](#) Transport of dangerous goods also applies.

CAT.GEN.MPA.160 Carriage of sporting weapons and ammunition

Regulation (EU) No 965/2012

- (a) The operator shall take all reasonable measures to ensure that any sporting weapons intended to be carried by air are reported to the operator.
- (b) The operator accepting the carriage of sporting weapons shall ensure that they are:
- (1) stowed in the aircraft in a place that is inaccessible to passengers during flight; and
 - (2) in the case of firearms or other weapons that can contain ammunition, unloaded.
- (c) Ammunition for sporting weapons may be carried in passengers' checked baggage, subject to certain limitations, in accordance with the technical instructions.

GM1 CAT.GEN.MPA.160 Carriage of sporting weapons and ammunition

ED Decision 2015/007/R

SPORTING WEAPONS

- (a) In accordance with Regulation (EC) No 300/2008 sporting weapons may be carried on board an aircraft, in a place that is not inaccessible, if the required security conditions in accordance with national laws have been fulfilled and authorisation has been given by the States involved.
- (b) There is no internationally agreed definition of sporting weapons. In general, it may be any weapon that is not a weapon of war or munitions of war. Sporting weapons include hunting knives, bows and other similar articles. An antique weapon, which at one time may have been a weapon of war or munitions of war, such as a musket, may now be regarded as a sporting weapon.
- (c) A firearm is any gun, rifle or pistol that fires a projectile.
- (d) The following firearms are generally regarded as being sporting weapons:
- (1) those designed for shooting game, birds and other animals;
 - (2) those used for target shooting, clay-pigeon shooting and competition shooting, providing the weapons are not those on standard issue to military forces; and
 - (3) airguns, dart guns, starting pistols, etc.
- (e) A firearm, which is not a weapon of war or munitions of war, should be treated as a sporting weapon for the purposes of its carriage on an aircraft.

CAT.GEN.MPA.161 Carriage of sporting weapons and ammunition — alleviations

Regulation (EU) No 965/2012

Notwithstanding [CAT.GEN.MPA.160\(b\)](#), for helicopters with a maximum certified take-off mass (MCTOM) of 3 175 kg or less operated by day and over routes navigated by reference to visual landmarks, a sporting weapon may be carried in a place that is accessible during flight, provided that

the operator has established appropriate procedures and it is impracticable to stow it in an inaccessible stowage during flight.

AMC1 CAT.GEN.MPA.161 Carriage of sporting weapons and ammunition — alleviations

ED Decision 2014/015/R

SPORTING WEAPONS — HELICOPTERS

Procedures for the carriage of sporting weapons may need to be considered if the helicopter does not have a separate compartment in which the weapons can be stowed. These procedures should take into account the nature of the flight, its origin and destination, and the possibility of unlawful interference. As far as possible, the weapons should be stowed so they are not immediately accessible to the passengers, e.g. in locked boxes, in checked baggage that is stowed under other baggage or under fixed netting.

CAT.GEN.MPA.165 Method of carriage of persons

Regulation (EU) No 965/2012

The operator shall take all measures to ensure that no person is in any part of an aircraft in flight that is not designed for the accommodation of persons unless temporary access has been granted by the commander:

- (a) for the purpose of taking action necessary for the safety of the aircraft or of any person, animal or goods therein; or
- (b) to a part of the aircraft in which cargo or supplies are carried, being a part that is designed to enable a person to have access thereto while the aircraft is in flight.

CAT.GEN.MPA.170 Psychoactive substances

Regulation (EU) 2020/745

- (a) The operator shall take all reasonable measures to ensure that no person enters or is in an aircraft when under the influence of psychoactive substances to the extent that the safety of the aircraft or its occupants is likely to be endangered.
- (b) The operator shall develop and implement a policy on the prevention and detection of misuse of psychoactive substances by flight and cabin crew members and by other safety-sensitive personnel under its direct control, in order to ensure that the safety of the aircraft or its occupants is not endangered.
- (c) Without prejudice to the applicable national legislation on data protection concerning testing of individuals, the operator shall develop and implement an objective, transparent and non-discriminatory procedure for the prevention and detection of cases of misuse of psychoactive substances by its flight and cabin crew and other safety-sensitive personnel.
- (d) In case of a confirmed positive test result, the operator shall inform its competent authority and the authority responsible for the personnel concerned, such as a medical assessor of the licensing authority.

AMC1 CAT.GEN.MPA.170(b) Psychoactive substances

ED Decision 2018/012/R

POLICY ON PREVENTION OF MISUSE OF PSYCHOACTIVE SUBSTANCES

- (a) The operator's policy on prevention of misuse of psychoactive substances should ensure that flight and cabin crew, as well as other safety-sensitive personnel, are dealt with in a consistent, just and fair manner as regards the prevention and detection of misuse of psychoactive substances.
- (b) The operator's training policy on misuse of psychoactive substances should include training and/or educational material on:
 - (1) the effects of psychoactive substances on individuals and on flight safety;
 - (2) established procedures within the organisation to prevent misuse of psychoactive substances;
 - (3) individual responsibilities with regard to applicable legislation and policies on psychoactive substances; and
 - (4) assistance provided by the support programme in accordance with [CAT.GEN.MPA.215](#).

AMC2 CAT.GEN.MPA.170(b) Psychoactive substances

ED Decision 2018/012/R

POLICY TO PREVENT MISUSE OF PSYCHOACTIVE SUBSTANCES

The operator's policy should ensure testing for psychoactive substances at least in the following cases:

- (a) upon employment by the operator; and
- (b) with due cause in the following cases:
 - (1) following a reasonable suspicion, and following an assessment by appropriately trained personnel; and
 - (2) after a serious incident or accident within the meaning of Regulation (EU) No 996/2010, provided that testing is possible due to the location of the serious incident or accident.

GM1 CAT.GEN.MPA.170(b) Psychoactive substances

ED Decision 2018/012/R

POLICY ON PREVENTION OF MISUSE OF PSYCHOACTIVE SUBSTANCES

Guidance for the development and implementation of the policy on prevention of misuse of psychoactive substances is contained in ICAO Doc 9654 'Manual on Prevention of Problematic Use of Substances in the Aviation Workplace'.

TRAINING AND EDUCATION PROGRAMMES

Guidance for the development and implementation of training and education programmes is contained in ICAO Doc 9654 'Manual on Prevention of Problematic Use of Substances in the Aviation Workplace'.

GM2 CAT.GEN.MPA.170(b) Psychoactive substances

ED Decision 2018/012/R

OPERATOR RANDOM TESTING PROGRAMME

Nothing should prevent an operator from implementing a random testing programme in accordance with national requirements on testing of individuals, in order to mitigate the risk that misuse of psychoactive substances remains undetected and endangers the safety of the aircraft or its occupants.

GM3 CAT.GEN.MPA.170(b) Psychoactive substances

ED Decision 2018/012/R

MEANING OF 'PERSONNEL UNDER THE DIRECT CONTROL OF THE OPERATOR'

- (a) Personnel under the direct control of the operator means personnel that is directly employed by the operator. This excludes personnel of contractors or subcontractors of the operator unless they act as flight or cabin crew.
- (b) The operator may require the contracted service provider to carry out testing of personnel as part of the contract between the operator and the contracted service provider.

GM4 CAT.GEN.MPA.170(b) Psychoactive substances

ED Decision 2018/012/R

POLICY TO PREVENT MISUSE OF PSYCHOACTIVE SUBSTANCES

After referral and assessment by the medical assessor of the licencing authority, the operator may consider unannounced testing as part of a periodic medical follow-up after rehabilitation and return to work.

AMC1 CAT.GEN.MPA.170(c) Psychoactive substances

ED Decision 2018/012/R

OBJECTIVE, TRANSPARENT AND NON-DISCRIMINATORY TESTING PROCEDURE

The operator's objective, transparent and non-discriminatory testing procedure should specify:

- (a) means to ensure confidentiality and protection of data;
- (b) the responsibilities of the person carrying out a test, which should be in accordance with national legislation;
- (c) the timing and suitable locations for testing;
- (d) that the body responsible for testing should be an independent, accredited body using standard guidelines on psychoactive substance testing in line with national legislation;
- (e) the testing process, and in particular:
 - (1) the psychoactive substances to be tested for;
 - (2) the applicable national legislation and use of recognised quality standards applied to the testing methodology;
 - (3) initial screening and confirmation methods used; and
 - (4) handling of test results, which should be conducted by impartial and trained personnel, in order to ensure adherence to the procedure, to determine the true positives and to prevent false positives;

- (f) applicable limits applying to psychoactive substance tests;
- (g) the process to be followed in case of a confirmed positive test result; and
- (h) the internal appeal process.

CAT.GEN.MPA.175 Endangering safety

Regulation (EU) 2018/1042

- (a) The operator shall take all reasonable measures to ensure that no person recklessly, intentionally or negligently acts or omits to act so as to:
 - (1) endanger an aircraft or person therein; or
 - (2) cause or permit an aircraft to endanger any person or property.
- (b) The operator shall ensure that flight crew has undergone a psychological assessment before commencing line flying in order to:
 - (1) identify psychological attributes and suitability of the flight crew in respect of the work environment; and
 - (2) reduce the likelihood of negative interference with the safe operation of the aircraft.
- (c) Considering the size, nature and complexity of the activity of an operator, an operator may replace the psychological assessment referred to in point (b) with an internal assessment of the psychological attributes and suitability of flight crew.

AMC1 CAT.GEN.MPA.175(b) Endangering safety

ED Decision 2018/012/R

PSYCHOLOGICAL ASSESSMENT

- (a) The psychological assessment should be:
 - (1) appropriate to the particularity, the complexity and the challenges of the operational environment that the flight crew is likely to be exposed to, as defined by a job analysis identifying the safety-critical dimensions related to the flight crew's function and role within the operator and should include at least the following assessment criteria:
 - (i) cognitive abilities;
 - (ii) personality traits;
 - (iii) operational and professional competencies; and
 - (iv) social competences in accordance with crew resource management principles;
 - (2) validated and either directly performed or overseen by a psychologist with acquired knowledge in aviation relevant to the flight crew's operating environment and with expertise in psychological assessment, and where possible, the psychological selection of aviation personnel; and
 - (3) undertaken at least within the past 24 months before commencing line flying, unless the operator can demonstrate that the psychological assessment undertaken more than 24 months ago is still adequate for the risk mitigation as required by [ORO.GEN.200\(a\)\(3\)](#). Such a demonstration should be based on the tests previously performed, an updated risk assessment based on data gathered from previous operational experience and continuous human performance monitoring since the last psychological assessment.

- (b) As regards the psychological assessment, the following should be documented:
- (1) the procedures followed;
 - (2) the personnel involved;
 - (3) the assessment criteria and instruments used in the assessment; and
 - (4) the validity period.

GM1 CAT.GEN.MPA.175(b) Endangering safety

ED Decision 2018/012/R

GUIDANCE ON CONDUCTING A PSYCHOLOGICAL ASSESSMENT

- (a) A psychological assessment performed by one operator may subsequently be accepted by a different operator, provided that the latter is satisfied that the assessment has been performed in accordance with [AMC1 CAT.GEN.MPA.175\(b\)](#).
- (b) A psychological assessment conducted by or on behalf of an operator should not be considered or conducted as a clinical psychological evaluation.
- (c) When establishing the policy on psychological assessment of flight crews, the operator may refer to recognised industry standards and best practices in the field of pilot selection, aptitude testing and psychological assessment such as:
- (1) IATA 'Guidance Material and Best Practices for Pilot Aptitude Testing'; and
 - (2) national or European standards of ethical codes of conduct when conducting a psychological assessment, such as by national or European associations for (aviation) psychology.

AMC1 CAT.GEN.MPA.175(c) Endangering safety

Regulation (EU) 2018/1139

INTERNAL ASSESSMENT FOR NON-COMPLEX OPERATORS

- (a) An operator may replace the psychological assessment with an internal assessment of the psychological attributes and suitability of the flight crew, if the operator is considered to be a non-complex operator, i.e. when it has a workforce of 20 full-time equivalents (FTEs) or less, that are involved in an activity subject to Regulation (EU) 2018/1139 and its implementing rules.
- (b) The internal assessment for non-complex operators should as far as possible apply the same principles as the psychological assessment before commencing line flying for complex operators.

CAT.GEN.MPA.180 Documents, manuals and information to be carried

Regulation (EU) 2019/1384

- (a) The following documents, manuals and information shall be carried on each flight, as originals or copies unless otherwise specified:
- (1) the aircraft flight manual (AFM), or equivalent document(s);
 - (2) the original certificate of registration;
 - (3) the original certificate of airworthiness (CofA);

- (4) the noise certificate, including an English translation, where one has been provided by the authority responsible for issuing the noise certificate;
 - (5) a certified true copy of the air operator certificate (AOC), including an English translation when the AOC has been issued in another language;
 - (6) the operations specifications relevant to the aircraft type, issued with the AOC, including an English translation when the operations specifications have been issued in another language;
 - (7) the original aircraft radio licence, if applicable;
 - (8) the third party liability insurance certificate(s);
 - (9) the journey log, or equivalent, for the aircraft;
 - (10) the aircraft technical log, in accordance with Annex I (Part-M) to Regulation (EU) No 1321/2014;
 - (11) details of the filed ATS flight plan, if applicable;
 - (12) current and suitable aeronautical charts for the route of the proposed flight and all routes along which it is reasonable to expect that the flight may be diverted;
 - (13) procedures and visual signals information for use by intercepting and intercepted aircraft;
 - (14) information concerning search and rescue services for the area of the intended flight, which shall be easily accessible in the flight crew compartment;
 - (15) the current parts of the operations manual that are relevant to the duties of the crew members, which shall be easily accessible to the crew members;
 - (16) the MEL;
 - (17) appropriate notices to airmen (NOTAMs) and aeronautical information service (AIS) briefing documentation;
 - (18) appropriate meteorological information;
 - (19) cargo and/or passenger manifests, if applicable;
 - (20) mass and balance documentation;
 - (21) the operational flight plan, if applicable;
 - (22) notification of special categories of passenger (SCPs) and special loads, if applicable; and
 - (23) any other documentation that may be pertinent to the flight or is required by the States concerned with the flight.
- (b) Notwithstanding (a), for operations under visual flight rules (VFR) by day with other-than complex motor-powered aircraft taking off and landing at the same aerodrome or operating site within 24 hours, or remaining within a local area specified in the operations manual, the following documents and information may be retained at the aerodrome or operating site instead:
- (1) noise certificate;
 - (2) aircraft radio licence;
 - (3) journey log, or equivalent;
 - (4) aircraft technical log;

- (5) NOTAMs and AIS briefing documentation;
 - (6) meteorological information;
 - (7) notification of SCPs and special loads, if applicable; and
 - (8) mass and balance documentation.
- (c) Notwithstanding (a), in case of loss or theft of documents specified in (a)(2) to (a)(8), the operation may continue until the flight reaches its destination or a place where replacement documents can be provided.

AMC1 CAT.GEN.MPA.180 Documents, manuals and information to be carried

ED Decision 2014/015/R

GENERAL

The documents, manuals and information may be available in a form other than on printed paper. Accessibility, usability and reliability should be assured.

GM1 CAT.GEN.MPA.180(a)(1) Documents, manuals and information to be carried

ED Decision 2014/015/R

AIRCRAFT FLIGHT MANUAL OR EQUIVALENT DOCUMENT(S)

‘Aircraft flight manual, or equivalent document(s)’ means in the context of this rule the flight manual for the aircraft, or other documents containing information required for the operation of the aircraft within the terms of its certificate of airworthiness unless these data are available in the parts of the operations manual carried on board.

GM1 CAT.GEN.MPA.180(a)(5)(6) Documents, manuals and information to be carried

ED Decision 2014/015/R

CERTIFIED TRUE COPIES

- (a) Certified true copies may be provided:
- (1) directly by the competent authority; or
 - (2) by persons holding privileges for certification of official documents in accordance with the applicable Member State’s legislation, e.g. public notaries, authorised officials in public services.
- (b) Translations of the air operator certificate (AOC) including operations specifications do not need to be certified.

GM1 CAT.GEN.MPA.180(a)(9) Documents, manuals and information to be carried

ED Decision 2014/015/R

JOURNEY LOG OR EQUIVALENT

'Journey log, or equivalent' means that the required information may be recorded in documentation other than a log book, such as the operational flight plan or the aircraft technical log.

AMC1 CAT.GEN.MPA.180(a)(13) Documents, manuals and information to be carried

ED Decision 2014/015/R

PROCEDURES AND VISUAL SIGNALS FOR USE BY INTERCEPTING AND INTERCEPTED AIRCRAFT

The procedures and the visual signals information for use by intercepting and intercepted aircraft should reflect those contained in International Civil Aviation Organization (ICAO) Annex 2. This may be part of the operations manual.

GM1 CAT.GEN.MPA.180(a)(14) Documents, manuals and information to be carried

ED Decision 2014/015/R

SEARCH AND RESCUE INFORMATION

This information is usually found in the State's aeronautical information publication.

AMC1 CAT.GEN.MPA.180(a)(18) Documents, manuals and information to be carried

ED Decision 2022/005/R

APPROPRIATE METEOROLOGICAL INFORMATION

The appropriate meteorological information should be relevant to the planned operation, as specified in point (a) of point MET.TR.215 of Annex V (Part MET) to [Regulation \(EU\) 2017/373](#), and comprise the following:

- (a) the meteorological information that is specified in point (e) of point MET.TR.215 of Part-MET; and
- (b) supplemental meteorological information:
 - (1) information other than that specified in point (a), which should be based on data from certified meteorological service providers; or
 - (2) information from other reliable sources of meteorological information that should be evaluated by the operator.

GM1 CAT.GEN.MPA.180(a)(18) Documents, manuals and information to be carried

ED Decision 2022/005/R

DATA FROM CERTIFIED METEOROLOGICAL SERVICE PROVIDERS

In the context of point (b)(1) of [AMC1 CAT.GEN.MPA.180\(a\)\(18\)](#), the operator may consider that any meteorological information that is provided by the organisation within the scope of the meteorological information included in the flight documentation defined in point (e) of point MET.TR.215 of Part-MET should originate only from authoritative sources or certified providers, and should not be transformed or tampered, except for the purpose of presenting the data in the correct format. The organisation's process should provide assurance that the integrity of such service is preserved in the data to be used by both flight crews and operators, regardless of their form.

GM2 CAT.GEN.MPA.180(a)(18) Documents, manuals and information to be carried

ED Decision 2022/005/R

INFORMATION FROM OTHER RELIABLE SOURCES OF METEOROLOGICAL INFORMATION

In the context of point (b)(2) of [AMC1 CAT.GEN.MPA.180\(a\)\(18\)](#), reliable sources of meteorological information are organisations that are able to provide an appropriate level of data assurance in terms of accuracy and integrity. The operator may consider in the evaluation that the organisation has a quality assurance system in place that covers source selection, acquisition/import, processing, validity period check, and distribution phase of data.

GM3 CAT.GEN.MPA.180(a)(18) Documents, manuals and information to be carried

ED Decision 2022/005/R

SUPPLEMENTAL METEOROLOGICAL INFORMATION AND SUPPLEMENTARY INFORMATION

Supplemental meteorological information: when operating under specific provisions and without the meteorological information from a certified service provider, the operator should use 'supplemental meteorological information', such as digital imagery. Related information can be found in point (e)(4) of [AMC1 CAT.OP.MPA.192](#).

Supplementary information: it is included in point (a) of [AMC1 CAT.GEN.MPA.180\(a\)\(18\)](#) and refers to meteorological information to be reported in specific cases such as freezing precipitation, blowing snow, thunderstorm, etc.

GM1 CAT.GEN.MPA.180(a)(23) Documents, manuals and information to be carried

ED Decision 2014/015/R

DOCUMENTS THAT MAY BE PERTINENT TO THE FLIGHT

Any other documents that may be pertinent to the flight or required by the States concerned with the flight, may include, for example, forms to comply with reporting requirements.

STATES CONCERNED WITH THE FLIGHT

The States concerned are those of origin, transit, overflight and destination of the flight.

CAT.GEN.MPA.185 Information to be retained on the ground*Regulation (EU) No 965/2012*

- (a) The operator shall ensure that at least for the duration of each flight or series of flights:
 - (1) information relevant to the flight and appropriate for the type of operation is preserved on the ground;
 - (2) the information is retained until it has been duplicated at the place at which it will be stored; or, if this is impracticable
 - (3) the same information is carried in a fireproof container in the aircraft.
- (b) The information referred to in (a) includes:
 - (1) a copy of the operational flight plan, where appropriate;
 - (2) copies of the relevant part(s) of the aircraft technical log;
 - (3) route-specific NOTAM documentation if specifically edited by the operator;
 - (4) mass and balance documentation if required; and
 - (5) special loads notification.

CAT.GEN.MPA.190 Provision of documentation and records*Regulation (EU) No 965/2012*

The commander shall, within a reasonable time of being requested to do so by a person authorised by an authority, provide to that person the documentation required to be carried on board.

CAT.GEN.MPA.195 Handling of flight recorder recordings: preservation, production, protection and use*Regulation (EU) 2019/1387*

- (a) Following an accident, a serious incident or an occurrence identified by the investigating authority, the operator of an aircraft shall preserve the original recorded data of the flight recorders for a period of 60 days or until otherwise directed by the investigating authority.
- (b) The operator shall conduct operational checks and evaluations of the recordings to ensure the continued serviceability of the flight recorders which are required to be carried under this Regulation.
- (c) The operator shall ensure that the recordings of flight parameters and data link communication messages required to be recorded on flight recorders are preserved. However, for the purpose of testing and maintaining those flight recorders, up to 1 hour of the oldest recorded data at the time of testing may be erased.
- (d) The operator shall keep and maintain up to date documentation that presents the necessary information to convert raw flight data into flight parameters expressed in engineering units.
- (e) The operator shall make available any flight recorder recordings that have been preserved, if so determined by the competent authority.

- (f) Without prejudice to Regulation (EU) No 996/2010 and Regulation (EU) 2016/679 of the European Parliament and of the Council¹
- (1) Except for ensuring flight recorder serviceability, audio recordings from a flight recorder shall not be disclosed or used unless all of the following conditions are fulfilled:
 - (i) a procedure related to the handling of such audio recordings and of their transcript is in place;
 - (ii) all crew members and maintenance personnel concerned have given their prior consent;
 - (iii) such audio recordings are used only for maintaining or improving safety.
 - (1a) When inspecting flight recorder audio recordings to ensure flight recorder serviceability, the operator shall protect the privacy of those audio recordings and make sure that they are not disclosed or used for purposes other than for ensuring flight recorder serviceability.
 - (2) Flight parameters or data link messages recorded by a flight recorder shall not be used for purposes other than for the investigation of an accident or an incident which is subject to mandatory reporting, unless such recordings meet any of the following conditions:
 - (i) are used by the operator for airworthiness or maintenance purposes only;
 - (ii) are de-identified;
 - (iii) are disclosed under secure procedures.
 - (3) Except for ensuring flight recorder serviceability, images of the flight crew compartment that are recorded by a flight recorder shall not be disclosed or used unless all of the following conditions are fulfilled:
 - (i) a procedure related to the handling of such image recordings is in place;
 - (ii) all crew members and maintenance personnel concerned have given their prior consent;
 - (iii) such image recordings are used only for maintaining or improving safety.
 - (3a) When images of the flight crew compartment that are recorded by a flight recorder are inspected for ensuring the serviceability of the flight recorder, then:
 - (i) those images shall not be disclosed or used for purposes other than for ensuring flight recorder serviceability;
 - (ii) if body parts of crew members are likely to be visible on the images, the operator shall ensure the privacy of those images.

¹ Regulation (EU) 2016/679 of the European Parliament and of the Council of 27 April 2016 on the protection of natural persons with regard to the processing of personal data and on the free movement of such data, and repealing Directive 95/46/EC (General Data Protection Regulation) (OJ L 119, 4.5.2016, p. 1).

AMC1 CAT.GEN.MPA.195(a) Handling of flight recorder recordings: preservation, production, protection and use

ED Decision 2015/030/R

PRESERVATION OF RECORDED DATA FOR INVESTIGATION

- (a) The operator should establish procedures to ensure that flight recorder recordings are preserved for the investigating authority.
- (b) These procedures should include:
 - (1) instructions for flight crew members to deactivate the flight recorders immediately after completion of the flight and inform relevant personnel that the recording of the flight recorders should be preserved. These instructions should be readily available on board; and
 - (2) instructions to prevent inadvertent reactivation, test, repair or reinstallation of the flight recorders by operator personnel or during maintenance or ground handling activities performed by third parties.

GM1 CAT.GEN.MPA.195(a) Handling of flight recorder recordings: preservation, production, protection and use

ED Decision 2015/030/R

REMOVAL OF RECORDERS IN CASE OF AN INVESTIGATION

The need for removal of the recorders from the aircraft is determined by the investigating authority with due regard to the seriousness of an occurrence and the circumstances, including the impact on the operation.

AMC1 CAT.GEN.MPA.195(b) Handling of flight recorder recordings: preservation, production, protection and use

ED Decision 2021/005/R

INSPECTIONS AND CHECKS OF RECORDINGS

- (a) The operator should perform an inspection of the FDR recording and the CVR recording every year unless one or more of the following applies:
 - (1) If the flight recorder records on magnetic wire or uses frequency modulation technology, the time interval between two inspections of the recording should not exceed 3 months.
 - (2) If the flight recorder is solid-state and the flight recorder system is fitted with continuous monitoring for proper operation, the time interval between two inspections of the recording may be up to 2 years.
 - (3) In the case of an aircraft equipped with two solid-state flight data and cockpit voice combination recorders, where
 - (i) the flight recorder systems are fitted with continuous monitoring for proper operation, and
 - (ii) the flight recorders share the same flight data acquisition, a comprehensive inspection of the recording needs only to be performed for one flight recorder position. The inspection of the recordings should be performed alternately so that each flight recorder position is inspected at time intervals not exceeding 4 years.

- (4) Where all the following conditions are met, the inspection of the FDR recording is not needed:
- (i) the aircraft flight data is collected in the frame of a flight data monitoring (FDM) programme;
 - (ii) the data acquisition of mandatory flight parameters is the same for the FDR and for the recorder used for the FDM programme;
 - (iii) an inspection similar to the inspection of the FDR recording and covering all mandatory flight parameters is conducted on the FDM data at time intervals not exceeding 2 years; and
 - (iv) the FDR is solid-state and the FDR system is fitted with continuous monitoring for proper operation.
- (b) the operator should perform every 5 years an inspection of the data link recording;
- (c) The operator should perform, at time intervals not exceeding 2 years, an inspection of the recording of flight recorders other than an FDR, which are installed on an aircraft, in order to ensure compliance with [CAT.IDE.A.191](#) or [CAT.IDE.H.191](#).
- (d) When installed, the aural or visual means for preflight checking of the flight recorders for proper operation should be used on each day when the aircraft is operated. When no such means is available for a flight recorder, the operator should perform an operational check of this flight recorder at intervals not exceeding 150 flight hours or 7 calendar days of operation, whichever is considered more suitable by the operator.
- (e) The operator should check every 5 years, or in accordance with the recommendations of the sensor manufacturer, that the parameters dedicated to the FDR and not monitored by other means are being recorded within the calibration tolerances and that there is no discrepancy in the engineering conversion routines for these parameters.

GM1 CAT.GEN.MPA.195(b) Handling of flight recorder recordings: preservation, production, protection and use

ED Decision 2021/005/R

INSPECTION OF THE FLIGHT RECORDERS' RECORDINGS FOR ENSURING SERVICEABILITY

- (a) The inspection of recorded flight parameters usually consists of the following:
- (1) Making a copy of the complete recording file.
 - (2) Converting the recording to parameters expressed in engineering units in accordance with the documentation required to be held.
 - (3) Examining a whole flight in engineering units to evaluate the validity of all mandatory parameters — this could reveal defects or noise in the measuring and processing chains and indicate necessary maintenance actions. The following should be considered:
 - (i) when applicable, each parameter should be expressed in engineering units and checked for different values of its operational range — for this purpose, some parameters may need to be inspected at different flight phases; and
 - (ii) (only applicable to an FDR) if the parameter is delivered by a digital data bus and the same data are utilised for the operation of the aircraft, then a reasonableness check may be sufficient; otherwise a correlation check may need to be performed:

- (A) a reasonableness check is understood in this context as a subjective, qualitative evaluation, requiring technical judgement, of the recordings from a complete flight; and
 - (B) a correlation check is understood in this context as the process of comparing data recorded by the flight data recorder against the corresponding data derived from flight instruments, indicators or the expected values obtained during specified portion(s) of a flight profile or during ground checks that are conducted for that purpose.
- (4) Retaining the most recent copy of the complete recording file and the corresponding recording inspection report that includes references to the documentation required to be held.
- (b) When performing the inspection of an audio recording from a flight recorder, precautions need to be taken to comply with CAT.GEN.MPA.195(f)(1a). The inspection of the audio recording usually consists of:
- (1) checking that the flight recorder operates correctly for the nominal duration of the recording;
 - (2) examining samples of in-flight audio recording from the flight recorder for evidence that the signal is acceptable on each channel and in all phases of flight; and
 - (3) preparing and retaining an inspection report.
- (c) The inspection of the DLR recording usually consists of:
- (1) Checking the consistency of the data link recording with other recordings for example, during a designated flight, the flight crew speaks out a few data link messages sent and received. After the flight, the data link recording and the CVR recording are compared for consistency.
 - (2) Retaining the most recent copy of the complete recording and the corresponding inspection report.
- (d) When inspecting images recorded by a flight recorder, precautions need to be taken to comply with CAT.GEN.MPA.195(f)(3a). The inspection of such images usually consists of the following:
- (1) checking that the flight recorder operates correctly for the nominal duration of the recording;
 - (2) examining samples of images recorded in different flight phases for evidence that the images of each camera are of acceptable quality; and
 - (3) preparing and retaining an inspection report.

GM2 CAT.GEN.MPA.195(b) Handling of flight recorder recordings: preservation, production, protection and use

ED Decision 2016/012/R

MONITORING AND CHECKING THE PROPER OPERATION OF FLIGHT RECORDERS — EXPLANATION OF TERMS

For the understanding of the terms used in [AMC1 CAT.GEN.MPA.195\(b\)](#):

- (a) 'operational check of the flight recorder' means a check of the flight recorder for proper operation. It is not a check of the quality of the recording and, therefore, it is not equivalent to

an inspection of the recording. This check can be carried out by the flight crew or through a maintenance task.

- (b) 'aural or visual means for preflight checking the flight recorders for proper operation' means an aural or visual means for the flight crew to check before the flight the results of an automatically or manually initiated test of the flight recorders for proper operation. Such a means provides for an operational check that can be performed by the flight crew.
- (c) 'flight recorder system' means the flight recorder, its dedicated sensors and transducers, as well as its dedicated acquisition and processing equipment.
- (d) 'continuous monitoring for proper operation' means for a flight recorder system, a combination of system monitors and/or built-in test functions which operates continuously in order to detect the following:
 - (1) loss of electrical power supply to the flight recorder system;
 - (2) failure of the equipment performing acquisition and processing;
 - (3) failure of the recording medium and/or drive mechanism; and
 - (4) failure of the recorder to store the data in the recording medium as shown by checks of the recorded data including, as reasonably practicable for the storage medium concerned, correct correspondence with the input data.

However, detections by the continuous monitoring for proper operation do not need to be automatically reported to the flight crew compartment.

GM3 CAT.GEN.MPA.195(b) Handling of flight recorder recordings: preservation, production, protection and use

ED Decision 2021/005/R

CVR AUDIO QUALITY

Additional guidance material for performing the CVR recording inspection may be found in the document of the French Bureau d'Enquêtes et d'Analyses, titled 'Guidance on CVR recording inspection' and dated October 2018 or later.

AMC1 CAT.GEN.MPA.195(f)(1) Handling of flight recorder recordings: preservation, production, protection and use

ED Decision 2021/005/R

USE OF AUDIO RECORDINGS FOR MAINTAINING OR IMPROVING SAFETY

- (a) The procedure related to the handling of audio recordings from flight recorders and of their transcripts should be documented and signed by all parties (aircraft operator, crew member representatives nominated either by the union or the crew themselves, maintenance personnel representatives if applicable). This procedure should take into account [Regulation \(EU\) 2016/679](#)¹ and as a minimum, define:
 - (1) the method to obtain the consent of all crew members and maintenance personnel concerned;

¹ Regulation (EU) 2016/679 of the European Parliament and of the Council of 27 April 2016 on the protection of natural persons with regard to the processing of personal data and on the free movement of such data, and repealing Directive 95/46/EC (General Data Protection Regulation) (OJ L 119, 4.5.2016, p. 1).

- (2) an access and security policy that restricts access to audio recordings from flight recorders and their transcripts to specifically authorised persons identified by their position;
 - (3) a retention policy and accountability, including the measures to be taken to ensure the security of audio recordings from flight recorders and their transcripts and their protection from misuse. The retention policy should specify the period of time after which such audio recordings and identified transcripts are destroyed;
 - (4) a description of the uses made of audio recordings from flight recorders and their transcripts ;
 - (5) the participation of flight crew member representatives in the assessment of audio recordings from flight recorders and their transcripts;
 - (6) the conditions under which advisory briefing or remedial training should take place; this should always be carried out in a constructive and non-punitive manner; and
 - (7) the conditions under which actions other than advisory briefing or remedial training may be taken for reasons of gross negligence or significant continuing safety concern.
- (b) Each time an audio recording file from a flight recorder is read out under the conditions defined by [CAT.GEN.MPA.195\(f\)\(1\)](#):
- (1) parts of the audio recording file that contain information with a privacy content should be deleted to the extent possible, and it should not be permitted that the detail of information with a privacy content is transcribed; and
 - (2) the operator should retain, and when requested, provide to the competent authority:
 - (i) information on the use made (or the intended use) of the audio recording file; and
 - (ii) evidence that the persons concerned consented to the use made (or the intended use) of the audio recording file.
- (c) The safety manager or the person identified by the operator to fulfil this role should be responsible for the protection and use of audio recordings from flight recorders and their transcripts, as well as for the assessment of issues and their transmission to the manager(s) responsible for the process concerned.
- (d) In case a third party is involved in the use of audio recordings from flight recorders, contractual agreements with this third party should cover the aspects enumerated in (a) and (b).

AMC1 CAT.GEN.MPA.195(f)(1a) Handling of flight recorder recordings: preservation, production, protection and use

ED Decision 2021/005/R

INSPECTION OF AUDIO RECORDINGS FOR ENSURING SERVICEABILITY

- (a) When an inspection of the audio recordings from a flight recorder is performed for ensuring audio quality and intelligibility of recorded communications:
- (1) the privacy of the audio recordings should be ensured (e.g. by locating the replay equipment in a separated area and/or using headsets);
 - (2) access to the replay equipment should be restricted to specifically authorised persons identified by their position;

- (3) provision should be made for the secure storage of the recording medium, the audio recording files and copies thereof;
 - (4) the audio recording files and copies thereof should be destroyed not earlier than 2 months and not later than 1 year after completion of the inspection of the audio recordings, except that audio samples with no privacy content may be retained for enhancing this inspection (e.g. for comparing audio quality);
 - (5) only the accountable manager of the operator and, when identified to comply with ORO.GEN.200, the safety manager should be entitled to request a copy of the audio recording files.
- (b) The conditions enumerated in (a) should also be complied with if the inspection of the audio recordings is subcontracted to a third party. The contractual agreements with the third party should explicitly cover these aspects.

GM1 CAT.GEN.MPA.195(f)(2) Handling of flight recorder recordings: preservation, production, protection and use

ED Decision 2016/012/R

USE OF FDR DATA FOR AN FDM PROGRAMME

The use of FDR data in the framework of an FDM programme may be acceptable if it fulfils the conditions set by sub-paragraph (f)(2) of [CAT.GEN.MPA.195](#).

AMC1 CAT.GEN.MPA.195(f)(3) Handling of flight recorder recordings: preservation, production, protection and use

ED Decision 2021/005/R

USE OF IMAGES FROM THE FLIGHT CREW COMPARTMENT FOR MAINTAINING OR IMPROVING SAFETY

- (a) The procedure related to the handling of images of the flight crew compartment that are recorded by a flight recorder should be documented and signed by all parties involved (aircraft operator, crew member representatives nominated either by the union or the crew themselves, maintenance personnel representatives if applicable). This procedure should take into account Regulation (EU) 2016/679 and, as a minimum, define the following aspects:
- (1) the method to obtain the consent of all crew members and maintenance personnel concerned;
 - (2) an access and security policy that restricts access to the image recordings to specifically authorised persons identified by their position;
 - (3) a retention policy and accountability, including the measures to ensure the security of the image recordings and their protection from misuse. The retention policy should specify the period of time after which such image recordings are destroyed;
 - (4) a description of the uses made of the image recordings;
 - (5) the participation of flight crew member representatives in the assessment of the image recordings;
 - (6) the conditions under which advisory briefing or remedial training should take place; this should always be carried out in a constructive and non-punitive manner; and

- (7) the conditions under which actions other than advisory briefing or remedial training may be taken for reasons of gross negligence or significant continuing safety concern.
- (b) Each time an image recording file from a flight recorder that contains images of the flight crew compartment is read out for purposes other than ensuring the serviceability of that flight recorder:
 - (1) images that contain information with a privacy content should be deleted to the extent possible, and it should not be permitted that the detail of information with a privacy content is transcribed; and
 - (2) the operator should retain, and when requested, provide the competent authority with:
 - (i) information on the use made (or the intended use) of this image recording file; and
 - (ii) evidence that the crew members concerned consented to the use made (or the intended use) of the flight crew compartment images.
- (c) The safety manager or the person identified by the operator to fulfil this role should be responsible for the protection and use of images of the flight crew compartment that are recorded by a flight recorder, as well as for the assessment of issues and their transmission to the manager(s) responsible for the process concerned.
- (d) In case a third party is involved in the use of images of the flight crew compartment that are recorded by a flight recorder, contractual agreements with this third party should cover the aspects enumerated in (a) and (b).

AMC1 CAT.GEN.MPA.195(f)(3a) Handling of flight recorder recordings: preservation, production, protection and use

ED Decision 2021/005/R

INSPECTION OF IMAGES OF THE FLIGHT CREW COMPARTMENT FOR ENSURING SERVICEABILITY

- (a) When images of the flight crew compartment recorded by a flight recorder are inspected for ensuring the serviceability of the flight recorder, and any body part of a crew member is likely to be visible on these images, then:
 - (1) the privacy of the image recordings should be ensured (e.g. by locating the replay equipment in a separated area);
 - (2) access to the replay equipment should be restricted to specifically authorised persons identified by their position;
 - (3) provision should be made for the secure storage of the recording medium, the image recording files and copies thereof;
 - (4) the image recording files and copies thereof should be destroyed not earlier than 2 months and not later than 1 year after completion of the inspection of the image recordings. Images that do not contain any body part of a person may be retained for enhancing this inspection (e.g. for comparing image quality); and
 - (5) only the accountable manager of the operator and, when identified to comply with [ORO.GEN.200](#), the safety manager should be entitled to request a copy of the image recording files.
- (b) The conditions enumerated in (a) should also be complied with if the inspection of the image recording is subcontracted to a third party. The contractual agreements with the third party should explicitly cover these aspects.

GM1 CAT.GEN.MPA.195(f) Handling of flight recorder recordings: preservation, production, protection and use

ED Decision 2021/005/R

FLIGHT CREW COMPARTMENT

If there are no compartments to physically segregate the flight crew from the passengers during the flight, the 'flight crew compartment' in point (f) of CAT.GEN.MPA.195 should be understood as the area including:

- (a) the flight crew seats;
- (b) aircraft and engine controls;
- (c) aircraft instruments;
- (d) windshield and windows used by the flight crew to get an external view while seated at their duty station; and
- (e) circuit breakers accessible by the flight crew while seated at their duty station.

CAT.GEN.MPA.200 Transport of dangerous goods

Regulation (EU) No 965/2012

- (a) Unless otherwise permitted by this Annex, the transport of dangerous goods by air shall be conducted in accordance with Annex 18 to the Chicago Convention as last amended and amplified by the 'Technical instructions for the safe transport of dangerous goods by air' (ICAO Doc 9284-AN/905), including its supplements and any other addenda or corrigenda.
- (b) Dangerous goods shall only be transported by an operator approved in accordance with Annex V (Part-SPA), Subpart G, except when:
 - (1) they are not subject to the technical instructions in accordance with Part 1 of those instructions; or
 - (2) they are carried by passengers or crew members, or are in baggage, in accordance with Part 8 of the technical instructions.
- (c) An operator shall establish procedures to ensure that all reasonable measures are taken to prevent dangerous goods from being carried on board inadvertently.
- (d) The operator shall provide personnel with the necessary information enabling them to carry out their responsibilities, as required by the technical instructions.
- (e) The operator shall, in accordance with the technical instructions, report without delay to the competent authority and the appropriate authority of the State of occurrence in the event of:
 - (1) any dangerous goods accidents or incidents;
 - (2) the discovery of undeclared or misdeclared dangerous goods in cargo or mail; or
 - (3) the finding of dangerous goods carried by passengers or crew members, or in their baggage, when not in accordance with Part 8 of the technical instructions.
- (f) The operator shall ensure that passengers are provided with information about dangerous goods in accordance with the technical instructions.
- (g) The operator shall ensure that notices giving information about the transport of dangerous goods are provided at acceptance points for cargo as required by the technical instructions.

AMC1 CAT.GEN.MPA.200(e) Transport of dangerous goods

ED Decision 2014/015/R

DANGEROUS GOODS ACCIDENT AND INCIDENT REPORTING

- (a) Any type of dangerous goods accident or incident, or the finding of undeclared or misdeclared dangerous goods should be reported, irrespective of whether the dangerous goods are contained in cargo, mail, passengers' baggage or crew baggage. For the purposes of the reporting of undeclared and misdeclared dangerous goods found in cargo, the Technical Instructions considers this to include items of operators' stores that are classified as dangerous goods.
- (b) The first report should be dispatched within 72 hours of the event. It may be sent by any means, including e-mail, telephone or fax. This report should include the details that are known at that time, under the headings identified in (c). If necessary, a subsequent report should be made as soon as possible giving all the details that were not known at the time the first report was sent. If a report has been made verbally, written confirmation should be sent as soon as possible.
- (c) The first and any subsequent report should be as precise as possible and should contain the following data, where relevant:
 - (1) date of the incident or accident or the finding of undeclared or misdeclared dangerous goods;
 - (2) location, the flight number and flight date;
 - (3) description of the goods and the reference number of the air waybill, pouch, baggage tag, ticket, etc.;
 - (4) proper shipping name (including the technical name, if appropriate) and UN/ID number, when known;
 - (5) class or division and any subsidiary risk;
 - (6) type of packaging, and the packaging specification marking on it;
 - (7) quantity;
 - (8) name and address of the shipper, passenger, etc.;
 - (9) any other relevant details;
 - (10) suspected cause of the incident or accident;
 - (11) action taken;
 - (12) any other reporting action taken; and
 - (13) name, title, address and telephone number of the person making the report.
- (d) Copies of relevant documents and any photographs taken should be attached to the report.
- (e) A dangerous goods accident or incident may also constitute an aircraft accident, serious incident or incident. Reports should be made for both types of occurrences when the criteria for each are met.
- (f) The following dangerous goods reporting form should be used, but other forms, including electronic transfer of data, may be used provided that at least the minimum information of this AMC is supplied:

DANGEROUS GOODS OCCURRENCE REPORT
DGOR No:

1. Operator:		2. Date of Occurrence:		3. Local time of occurrence:	
4. Flight date:			5. Flight No:		
6. Departure aerodrome:			7. Destination aerodrome:		
8. Aircraft type:			9. Aircraft registration:		
10. Location of occurrence:			11. Origin of the goods:		
12. Description of the occurrence, including details of injury, damage, etc. (if necessary, continue on the reverse of this form):					
13. Proper shipping name (including the technical name):				14. UN/ID No (when known):	
15. Class/Division (when known):	16. Subsidiary risk(s):	17. Packing group:	18. Category (Class 7 only):		
19. Type of packaging:	20. Packaging specification marking:	21. No of packages:	22. Quantity (or transport index, if applicable):		
23. Reference No of Airway Bill:					
24. Reference No of courier pouch, baggage tag, or passenger ticket:					
25. Name and address of shipper, agent, passenger, etc.:					
26. Other relevant information (including suspected cause, any action taken):					
27. Name and title of person making report:			28. Telephone No:		
29. Company:			30. Reporters ref:		
31. Address:			32. Signature:		
			33. Date:		
Description of the occurrence (continuation)					

Notes for completion of the form:

1. A dangerous goods accident is as defined in [Annex I](#). For this purpose, serious injury is as defined in Regulation (EU) No 996/2010¹.
2. This form should also be used to report any occasion when undeclared or misdeclared dangerous goods are discovered in cargo, mail or unaccompanied baggage or when accompanied baggage contains dangerous goods which passengers or crew are not permitted to take on aircraft.
3. The initial report should be dispatched unless exceptional circumstances prevent this. This occurrence report form, duly completed, should be sent as soon as possible, even if all the information is not available.
4. Copies of all relevant documents and any photographs taken should be attached to this report.
5. Any further information, or any information not included in the initial report, should be sent as soon as possible to the authorities identified in [CAT.GEN.MPA.200\(e\)](#).
6. Providing it is safe to do so, all dangerous goods, packaging, documents, etc., relating to the occurrence should be retained until after the initial report has been sent to the authorities identified in [CAT.GEN.MPA.200\(e\)](#) and they have indicated whether or not these should continue to be retained.

GM1 CAT.GEN.MPA.200 Transport of dangerous goods

ED Decision 2014/015/R

GENERAL

- (a) The requirement to transport dangerous goods by air in accordance with the Technical Instructions is irrespective of whether:
 - (1) the flight is wholly or partly within or wholly outside the territory of a State; or
 - (2) an approval to carry dangerous goods in accordance with Annex V (Part-SPA), Subpart G is held.
- (b) The Technical Instructions provide that in certain circumstances dangerous goods, which are normally forbidden on an aircraft, may be carried. These circumstances include cases of extreme urgency or when other forms of transport are inappropriate or when full compliance with the prescribed requirements is contrary to the public interest. In these circumstances, all the States concerned may grant exemptions from the provisions of the Technical Instructions provided that an overall level of safety which is at least equivalent to that provided by the Technical Instructions is achieved. Although exemptions are most likely to be granted for the carriage of dangerous goods that are not permitted in normal circumstances, they may also be granted in other circumstances, such as when the packaging to be used is not provided for by the appropriate packing method or the quantity in the packaging is greater than that permitted. The Technical Instructions also make provision for some dangerous goods to be carried when an approval has been granted only by the State of origin and the State of the operator.
- (c) When an exemption is required, the States concerned are those of origin, transit, overflight and destination of the consignment and that of the operator. For the State of overflight, if none of

¹ Regulation (EU) No 996/2010 of the European Parliament and of the Council of 20 October 2010 on the investigation and prevention of accidents and incidents in civil aviation and repealing Directive 94/56/EC (OJ L 295, 12.11.2010, p. 35).

the criteria for granting an exemption are relevant, an exemption may be granted based solely on whether it is believed that an equivalent level of safety in air transport has been achieved.

- (d) The Technical Instructions provide that exemptions and approvals are granted by the 'appropriate national authority', which is intended to be the authority responsible for the particular aspect against which the exemption or approval is being sought. The Instructions do not specify who should seek exemptions and, depending on the legislation of the particular State, this may mean the operator, the shipper or an agent. If an exemption or approval has been granted to other than the operator, the operator should ensure a copy has been obtained before the relevant flight. The operator should ensure all relevant conditions on an exemption or approval are met.
- (e) The exemption or approval referred to in (b) to (d) is in addition to the approval required by Annex V (Part SPA), Subpart G.

CAT.GEN.MPA.205 Aircraft tracking system — Aeroplanes

Regulation (EU) 2015/2338

- (a) By 16 December 2018 at the latest, the operator shall establish and maintain, as part of the system for exercising operational control over the flights, an aircraft tracking system, which includes the flights eligible to (b) when performed with the following aeroplanes:
 - (1) aeroplanes with an MCTOM of more than 27 000 kg, with an MOPSC of more than 19, and first issued with an individual CofA before 16 December 2018, which are equipped with a capability to provide a position additional to the secondary surveillance radar transponder;
 - (2) all aeroplanes with an MCTOM of more than 27 000 kg, with an MOPSC of more than 19, and first issued with an individual CofA on or after 16 December 2018; and
 - (3) all aeroplanes with an MCTOM of more than 45 500 kg and first issued with an individual CofA on or after 16 December 2018.
- (b) Flights shall be tracked by the operator from take-off to landing, except when the planned route and the planned diversion routes are fully included in airspace blocks where:
 - (1) ATS surveillance service is normally provided which is supported by ATC surveillance systems locating the aircraft at time intervals with adequate duration; and
 - (2) the operator has provided to competent air navigation service providers necessary contact information.

AMC1 CAT.GEN.MPA.205 Aircraft tracking system — Aeroplanes

ED Decision 2021/008/R

EQUIPMENT, PERFORMANCE AND PROCEDURES WHEN AIRCRAFT TRACKING IS REQUIRED

- (a) Automatic tracking of aeroplane position

The aircraft tracking system should rely on equipment capable of automatically detecting and transmitting a position report to the aircraft operator, except if (d)(2) applies.
- (b) Position reporting period

The tracking of an individual flight should provide a position report at time intervals which do not exceed 15 minutes.

(c) Content of position reports

Each position report should contain at least the latitude, the longitude and the time of position determination and whenever available, an indication of the aeroplane altitude, except that for each flight:

- (1) One of the position reports may contain only time-stamped data indicating that the aeroplane has left the gate;
- (2) One of the position reports may contain only time-stamped data indicating that the aeroplane has become airborne;
- (3) One of the position reports may contain only time-stamped data indicating that the aeroplane has landed; and
- (4) One of the position reports may contain only time-stamped data indicating that the aeroplane has reached the gate.

(d) Source of position data

The data contained in a position report may come from:

- (1) ATC surveillance systems, if the ATC surveillance data source is capable of providing this data with a delay equal to or less than 10 minutes;
- (2) the flight crew, if the planned flight duration is less than two position reporting periods;
- (3) aeroplane systems. In that case:
 - (i) the source of time, latitude and longitude data should be the navigation system of the aeroplane or an approved GNSS receiver;
 - (ii) the source of altitude data should be:
 - (A) the same source as for time, latitude and longitude data, or
 - (B) an approved source of pressure altitude; and
 - (iii) the delivery time of position reports from the aeroplane to the operational control over the flight should, to the extent possible, not exceed 10 minutes; or
- (4) any data source when the position report is of a type designated by (c)(1), (c)(2), (c)(3) or (c)(4). In that case, the delivery time of position reports from the data source to the operational control over the flight should, to the extent possible, not exceed 10 minutes.

(e) Temporary lack of aircraft tracking data

Aircraft tracking data may be incomplete due to a temporary or unexpected issue prior to or during the flight. However, the operator should:

- (1) identify any loss of aircraft tracking data which is not due to a temporary issue, and
- (2) address any systematic lack of aircraft tracking data affecting a given aeroplane or a given route in a timely manner.

(f) Operational control over the flights

When abnormal flight behaviour is suspected, this should be checked and acted upon without delay.

(g) Recording of aircraft tracking data during normal operation

When the tracking of a flight is required, all related aircraft tracking data should be recorded on the ground, including position data from ATC surveillance systems when they are used. The aircraft tracking data of a given flight should be retained until confirmation that the flight is completed and no accident or serious incident occurred.

(h) Preserving aircraft tracking data after an accident or a serious incident

Following an accident or a serious incident, the operator should retain the aircraft tracking data of the involved flight for at least 30 days. In addition, the operator should be capable of providing a copy of this data without delay and in an electronic format that is human-readable using a common text file editor.

(i) Procedures

The operator should establish procedures describing its aircraft tracking system, including the identification of abnormal flight behaviour and the notification of the competent ATS unit (ATS unit responsible for providing the alerting service in the airspace where the aircraft is believed to be), when appropriate. These procedures should be integrated with the emergency response plan of the operator.

AMC2 CAT.GEN.MPA.205 Aircraft tracking system — Aeroplanes

ED Decision 2017/023/R

ROUTES INCLUDED IN AIRSPACE COVERED BY ATS SURVEILLANCE

- (a) Trajectory points located at a distance of less than 50 NM from the departure airfield and trajectory points located at a distance of less than 50 NM from the destination airfield may be considered as not part of the 'planned route'.
- (b) Trajectory points located at a distance of less than 50 NM from any diversion airfield may be considered as not part of the 'planned diversion routes'.
- (c) An ATS surveillance service may be considered 'supported by ATC surveillance systems locating the aircraft at time intervals with adequate duration' if those ATC surveillance systems are capable of locating aircraft at time intervals not exceeding 15 minutes when operated normally.
- (d) When applicable, the operator should check that the conditions required for using the exception defined by [CAT.GEN.MPA.205\(b\)](#) are fulfilled before operating into new airspace blocks.
- (e) When applicable, the operator should check at time intervals not exceeding 180 calendar days that the conditions required for using the exception defined by [CAT.GEN.MPA.205\(b\)](#) are maintained.

GM1 CAT.GEN.MPA.205 Aircraft tracking system — Aeroplanes

ED Decision 2017/023/R

EXPLANATION OF TERMS

For the understanding of the terms used in [CAT.GEN.MPA.205](#):

- (a) 'capability to provide a position additional to the secondary surveillance radar transponder' means airborne equipment other than the SSR transponder, which is operative and which can be used to automatically transmit time-stamped position data without change to the approved airborne systems; and

(b) ‘abnormal flight behaviour’: see [GM1 to Annex I](#) (Definitions).

GM2 CAT.GEN.MPA.205 Aircraft tracking system — Aeroplanes

ED Decision 2017/023/R

DETERMINING WHETHER A FLIGHT NEEDS TO BE TRACKED

Table 1 provides a summary of the cases applicable to an aeroplane which is within the scope of [CAT.GEN.MPA.205\(a\)](#).

Table 1: Cases applicable to the flight of an aeroplane subject to the aircraft tracking requirement

Condition 1: The planned route and the planned diversion routes are included in airspace blocks where ATS surveillance service is normally provided.	Condition 2: The ATS surveillance service provided in all airspace blocks determined by Condition 1 is supported by ATC surveillance systems locating the aircraft at time intervals with adequate duration.	Condition 3: The operator has provided all air navigation service providers competent for the airspace blocks determined by Condition 1 with the necessary contact information.	Case considered: Aeroplane that is within the scope of CAT.GEN.MPA.205(a) .
Conditions 1, 2 and 3 are met altogether.			The flight does not need to be tracked (refer to CAT.GEN.MPA.205(b)). Note: The operator should check at regular time intervals that Conditions 1, 2 and 3 are still met (refer to AMC2 CAT.GEN.MPA.205).
Either Condition 1, Condition 2 or Condition 3 is not met.			The flight shall be tracked (refer to CAT.GEN.MPA.205(b)). Note: Lack of aircraft tracking data due to a temporary or unexpected issue may be acceptable (refer to AMC1 CAT.GEN.MPA.205). Examples of issues (list is indicative and not exhaustive): airborne equipment found inoperative, transmission link disturbed by environmental factors; issue with the ground-based infrastructure or the space-based infrastructure.

GM3 CAT.GEN.MPA.205 Aircraft tracking system — Aeroplanes

ED Decision 2017/023/R

METHOD FOR ASSESSING WHETHER A FLIGHT NEEDS TO BE TRACKED

The following gives an example of a method to assess whether flights performed along a given route need to be tracked.

- (a) Determine the planned route and the planned diversion routes and consider only points of these routes located at a distance of greater than or equal to 50 NM from the departure airfield, the destination airfield and the diversion airfields. If there is no such point, then the flight does not need to be tracked, otherwise go to (b).
- (b) Identify all airspace blocks crossed by the result of (a) and go to (c).
- (c) If every airspace block meets all of the following conditions, then the flight does not need to be tracked:
 - (1) ATS surveillance service is provided in the airspace block;
 - (2) This ATS surveillance service relies on ATC surveillance systems which are normally capable of detecting aircraft in the airspace block at time intervals not exceeding 15 minutes; and
 - (3) The air navigation service provider competent for the airspace block has information sufficient to contact the on-duty staff at the operator;

GM4 CAT.GEN.MPA.205 Aircraft tracking system — Aeroplanes

ED Decision 2017/023/R

POSSIBLE SOURCES AND MINIMUM CONTENT OF A POSITION REPORT

Table 1 presents a summary of the possible sources and the minimum content of a position report according to [AMC1 CAT.GEN.MPA.205](#).

Table 1: Possible sources and minimum content of a position report

Planned flight duration	Possible sources of a position report	Minimum content of a position report
Flight duration < 2×reporting period	<ul style="list-style-type: none"> — Airborne equipment (automatic transmission); — Flight crew; or — ATC surveillance systems. 	Latitude, longitude and time (and whenever available altitude), except for the position reports designated by point (c)(1), (c)(2), (c)(3) and (c)(4) of AMC1 CAT.GEN.MPA.205 .
Flight duration ≥ 2×reporting period	<ul style="list-style-type: none"> — Airborne equipment (automatic transmission); — ATC surveillance systems; — Flight crew if the flight is not required to be tracked; or — Any source for position reports designated by point (c)(1), (c)(2), (c)(3) and (c)(4) of AMC1 CAT.GEN.MPA.205. 	

GM5 CAT.GEN.MPA.205 Aircraft tracking system — Aeroplanes

ED Decision 2017/023/R

AIRCRAFT TRACKING — CHOICE OF THE POSITION REPORTING PERIOD

- (a) Unless the aircraft tracking system includes functionalities enhancing the detection of deviations from normal operation (e.g. airborne systems capable of automatically transmitting more information under some conditions, possibility for the operational control to adjust the position reporting period of an ongoing flight, etc.), the choice of the position reporting period has a significant influence on the effectiveness of the aircraft tracking system.

- (1) Indeed, assuming that an operator has set itself the objective of detecting, within a given time T, deviations from normal operation, and that the operator relies for this purpose only on position reports, then the position reporting period needs to be less than T.
 - (2) Furthermore, when no other information than position reports is available to locate a missing aircraft, then the search zone is a circle with a radius corresponding to the distance likely to have been covered since the last detection. The corresponding search area grows as the square of the time, until the position of the aircraft is detected again or the fuel on board is exhausted. Taking the example of an aeroplane cruising at Mach 0.8 (i.e. covering a distance of about 8 NM per minute), after 15 minutes the search area is 155 000 square kilometres.
 - (3) In the publication of the Australian Transportation Safety Bureau titled 'The Operational Search for MH370' (dated October 2017), it is recommended that 'Aircraft operators, aircraft manufacturers, and aircraft equipment manufacturers investigate ways to provide high-rate and/or automatically triggered global position tracking in existing and future fleets'.
- (b) It is advised to take the above into account when setting up the aircraft tracking system.

GM6 CAT.GEN.MPA.205 Aircraft tracking system — Aeroplanes

ED Decision 2021/008/R

PROVIDING CONTACT INFORMATION TO COMPETENT AIR NAVIGATION SERVICE PROVIDERS

A solution for the operator to make the necessary contact information available to all competent air navigation service providers (ANSPs) could be to register to the global OPS Control Directory of ICAO. Another possible way is to provide in the ATS flight plan (item 18 'Other information') information sufficient to contact the on-duty staff of the aircraft operator.

GM7 CAT.GEN.MPA.205 Aircraft tracking system — Aeroplanes

ED Decision 2017/023/R

GUIDANCE

Additional guidance for the establishment of an aircraft tracking system is found in ICAO Circular 347 – Aircraft Tracking Implementation Guidelines, dated 2017.

CAT.GEN.MPA.210 Location of an aircraft in distress — Aeroplanes

Regulation (EU) 2019/1384

The following aeroplanes shall be equipped with robust and automatic means to accurately determine, following an accident during which the aeroplane is severely damaged, the location of the point of end of flight:

- (1) all aeroplanes with an MCTOM of more than 27 000 kg, with an MOPSC of more than 19 and first issued with an individual CofA on or after 1 January 2023; and
- (2) all aeroplanes with an MCTOM of more than 45 500 kg and first issued with an individual CofA on or after 1 January 2023.

[points (1)-(2) applicable until 3 December 2022 — Regulation (EU) 2022/2203]

- (1) all aeroplanes with an MCTOM of more than 27 000 kg, with an MOPSC of more than 19, and first issued with an individual CofA on or after 1 January 2024; and

- (2) all aeroplanes with an MCTOM of more than 45 500 kg and first issued with an individual CofA on or after 1 January 2024.

[points (1)-(2) applicable from 4 December 2022 — Regulation (EU) 2022/2203]

AMC1 CAT.GEN.MPA.210 Location of an aircraft in distress — Aeroplanes

ED Decision 2021/008/R

PERFORMANCE OF THE AIRBORNE SYSTEM, TRANSMISSION SERVICE, AND OPERATIONAL PROCEDURES

- (a) Performance of the airborne system

The airborne system used to comply with point [CAT.GEN.MPA.210](#) ('airborne system') should:

- (1) be approved in accordance with the applicable airworthiness requirements; and
- (2) comply with the Certification Specifications for Airborne Communications, Navigation and Surveillance (CS-ACNS) issued by EASA, or equivalent.

- (b) Transmission service

If the airborne system relies on other equipment than ELTs for transmitting the information needed to comply with point [CAT.GEN.MPA.210](#), the provider of the transmission service should be a surveillance service provider that is certified in accordance with Regulation (EU) 2017/373 (the 'ATM/ANS Regulation').

- (c) Flight crew procedures

The operator should establish flight crew procedures for using the airborne system, including manual activation and manual deactivation of that system. These procedures should ensure that the flight crew manually activate the airborne system only if a search and rescue (SAR) response is needed or anticipated, and that they inform the relevant ATS unit in a timely manner when they manually deactivate or disable the airborne system to stop data transmission.

- (d) Operator's procedures

The operator should establish procedures:

- (1) for assessing whether an aircraft is likely to be in a state of emergency and
- (2) for informing the competent ATS unit (ATS unit responsible for providing the alerting service in the airspace where the aircraft is believed to be):
 - (i) when a state of emergency is identified, and
 - (ii) when a state of emergency no longer exists.

- (e) Limiting the effects of false alerts

To reduce the frequency and effects of false alerts that are caused by the airborne system, the operator should:

- (1) establish procedures for disabling any of the required functions of the airborne system;
- (2) consider the airborne system inoperative if, during a flight, there were several occurrences of undesirable automatic activation of the airborne system; and
- (3) analyse occurrences of undesirable (manual and automatic) activation of the airborne system to determine their probable cause; the records of such analyses should be retained for at least 12 months and provided to the competent authority on request.

GM1 CAT.GEN.MPA.210 Location of an aircraft in distress — Aeroplanes

ED Decision 2021/008/R

OBJECTIVES AND IMPLEMENTATION

(a) The purpose of point CAT.GEN.MPA.210 is to have a high probability of timely and accurately locating the accident site after an accident during which the aircraft is severely damaged, irrespective of the accident location and survivability (hence, the terms ‘automatic’, ‘robust’, and ‘accurately’ are used in [CAT.GEN.MPA.210](#)). The scope of point [CAT.GEN.MPA.210](#) includes non-survivable accidents. Means compliant with point [CAT.GEN.MPA.210](#) are expected to:

- (1) quickly inform the SAR authority concerned that an accident occurred or is about to occur and provide them with information that can easily be used for locating the accident site; and
- (2) help the safety investigation authority concerned to locate the accident site and the aircraft wreckage so that they can collect evidence in a reasonable time frame.

Therefore, if an aircraft in the scope of [CAT.IDE.A.280](#) complies with CAT.GEN.MPA.210, this aircraft is not required to be equipped with an automatic emergency locator transmitter (ELT). Similarly, if an aircraft in the scope of [CAT.IDE.A.285](#) complies with CAT.GEN.MPA.210, this aircraft is not required to be equipped with a 8.8-kHz underwater locating device (ULD).

- (b) The airborne system used to comply with point [CAT.GEN.MPA.210](#) could rely, for example, on an emergency locator transmitter of a distress tracking type (ELT(DT)), on an automatic deployable flight recorder (ADFR), or on the transmission of position reports at short time intervals (high-rate tracking (HRT)).
- (c) Subpart A of the Certification Specifications for Airborne Communications, Navigation and Surveillance (CS-ACNS) contains general conditions applicable to the airborne system. Subpart E of CS-ACNS contains specific conditions for meeting the purpose of point [CAT.GEN.MPA.210](#).
- (d) If other transmitting equipment than an ELT is used by the airborne system for complying with [CAT.GEN.MPA.210](#), AMC1 CNS.OR.100 to Part-CNS of the ATM/ANS Regulation contains conditions applicable to the provider of the transmission service that is used by that equipment.
- (e) While AMC1 CNS.OR.100 only addresses the transmission of information to the SAR authorities, the capability to also transmit that information to the operator is advisable.

GM2 CAT.GEN.MPA.210 Location of an aircraft in distress — Aeroplanes

ED Decision 2021/008/R

EXPLANATION OF TERMS

The terms used in point [CAT.GEN.MPA.210](#) and [AMC1 CAT.GEN.MPA.210](#) are explained below for better understanding:

- ‘accident during which the aeroplane is severely damaged’ refers to an accident during which the aeroplane sustains damage or structural failure that adversely affects its structural strength, performance, or flight characteristics, and would normally require a major repair or replacement of the affected component, except for:
 - an engine failure or damage to the engine, when the damage is limited to a single engine (including its cowlings or accessories);

- damage limited to propellers, wing tips, antennas, probes, vanes, tyres, brakes, wheels, fairings, panels, landing gear doors, windscreens, the aeroplane skin (such as small dents or puncture holes);
- minor damage to the landing gear; and
- damage resulting from hail or bird strike (including holes in the radome);
- accurately determine the location of the point of end of flight’ means locating the point of end of flight with a position accuracy that is sufficient for safety investigation purposes, and when the accident conditions are survivable, also for SAR purposes;
- ‘activation of the airborne system’ means the transition of the airborne system from another state to the activated state;
- ‘airborne system’ means the organised set of airborne applications and airborne equipment that comply with [CAT.GEN.MPA.210](#);
- ‘ATM/ANS Regulation’ refers to [Commission Implementing Regulation \(EU\) 2017/373](#) of 1 March 2017 or any later EU regulation laying down common requirements for providers of air traffic management/air navigation services.
- ‘automatic means’ refers to means that do not require any human action to perform their intended function;
- ‘automatic activation of the airborne system’ means activation of the airborne system that is automatically triggered by airborne equipment;
- ‘deactivation of the airborne system’ means the transition of that system from the activated state to another state;
- ‘point of end of flight’ means, depending on the nature of the accident, the point where the aircraft crashed into land or water, or landed on land or water, or was destroyed;
- ‘required functions of the airborne system’ refers to the ‘functions of the system’, which are defined in the CS-ACNS that are applicable to locating an aircraft in distress;
- ‘robust means’ refers to means designed to work properly under the circumstances of survivable accidents, and under the circumstances of most non-survivable accidents;
- ‘the airborne system is activated’ means that the airborne system transmits signals to enable the determination of the location of the point of end of flight without sending mobile SAR facilities to the area of the transmitter; and
- ‘transmission service’ refers to the service that makes the information sent by the airborne system available to the relevant stakeholders.

CAT.GEN.MPA.215 Support programme

Regulation (EU) 2018/1042

- (a) The operator shall enable, facilitate and ensure access to a proactive and non-punitive support programme that will assist and support flight crew in recognising, coping with, and overcoming any problem which might negatively affect their ability to safely exercise the privileges of their licence. Such access shall be made available to all flight crew.
- (b) Without prejudice to applicable national legislation on the protection of individuals with regard to the processing of personal data and on the free movement of such data, the protection of the confidentiality of data shall be a precondition for an effective support programme as it encourages the use of such a programme and ensures its integrity.

AMC1 CAT.GEN.MPA.215 Support programme

ED Decision 2018/012/R

PRINCIPLES GOVERNING A SUPPORT PROGRAMME

The access to a support programme should:

- (a) enable self-declaration or referral in case of a decrease in a flight crew's medical fitness with an emphasis on prevention and early support; and
- (b) if appropriate, allow the flight crew to receive temporary relief from flight duties and be referred to professional advice.

AMC2 CAT.GEN.MPA.215 Support programme

ED Decision 2018/012/R

CONFIDENTIALITY AND PROTECTION OF DATA *ED Decision 2018/012/R*

- (a) The personal data of flight crew who have been referred to a support programme should be handled in a confidential, non-stigmatising, and safe environment.
- (b) A culture of mutual trust and cooperation should be maintained so that the flight crew is less likely to hide a condition and more likely to report and seek help.
- (c) Disclosure of data to the operator may only be granted in an anonymised manner such as in the form of aggregated statistical data and only for purposes of safety management so as not to compromise the voluntary participation in a support programme, thereby compromising flight safety.
- (d) Notwithstanding the above, an agreement with related procedures should be in place between the operator and the support programme on how to proceed in case of a serious safety concern.

AMC3 CAT.GEN.MPA.215 Support programme

ED Decision 2018/012/R

ELEMENTS OF A SUPPORT PROGRAMME

- (a) A support programme should contain as a minimum the following elements:
 - (1) procedures including education of flight crew regarding self-awareness and facilitation of self-referral;
 - (2) assistance provided by professionals, including mental and psychological health professionals with relevant knowledge of the aviation environment;
 - (3) involvement of trained peers, where trained peers are available;
 - (4) monitoring of the efficiency and effectiveness of the programme;
 - (5) monitoring and support of the process of returning to work;
 - (6) management of risks resulting from fear of loss of licence; and
 - (7) a referral system to an aero-medical examiner in defined cases raising serious safety concerns.
- (b) A support programme should be linked to the management system of the operator, provided that data is used for purposes of safety management and is anonymised and aggregated to ensure confidentiality.

AMC4 CAT.GEN.MPA.215 Support programme

ED Decision 2018/012/R

TRAINING AND AWARENESS

- (a) The operator should promote access to the support programme for all flight crew.
- (b) Professionals, including mental and psychological health professionals, as well as trained peers, where trained peers are available, that are involved in the support programme, should receive initial and recurrent training related to their role and function within the support programme.

GM1 CAT.GEN.MPA.215 Support programme

ED Decision 2018/012/R

SUPPORT PROGRAMME

- (a) A support programme is a proactive programme applying the principles of 'just culture' as defined in Regulation (EU) No 376/2014, whereby the senior management of the operator, mental health professionals, trained peers, and in many cases representative organisations of crew members work together to enable self-declaration, referral, advice, counselling and/or treatment, where necessary, in case of a decrease in medical fitness.
- (b) The support programme should be easily accessible for flight crew, and should provide adequate means of support at the earliest stages.

GM2 CAT.GEN.MPA.215 Support programme

ED Decision 2018/012/R

FACILITATION OF TRUST IN THE SUPPORT PROGRAMME

Essential trust between management and crew is the foundation for a successful support programme. This trust can be facilitated by:

- (a) establishing a platform for multi-stakeholder participation and partnership in the governance process of the support programme by involving flight crew representatives from one or more operators and representatives of the relevant operator. In some cases, a multi-stakeholder platform may also include representatives of the competent authority;
- (b) participation of the representatives of those personnel covered by the support programme in the design, implementation and operation of the support programme;
- (c) a formal agreement between management and crew, identifying the procedures for the use of data, its protection and confidentiality;
- (d) clear and unambiguous provisions on data protection;
- (e) senior management's demonstrated commitment to promote a proactive safety culture;
- (f) a non-punitive operator policy that also covers the support programme;
- (g) support programme management by staff either established within the operator or by a separate independent organisation;
- (h) involvement of persons with appropriate expertise when advising crews (for example, pilot peers with similar cultural backgrounds and professional staff with appropriate training in e.g. psychology, etc.);
- (i) a structured system to protect the confidentiality of personal data; and

- (j) an efficient communication system that promotes the benefits of the support programme, such as its positive impacts, temporary relief from duties without fear of dismissal, management of risks resulting from fear of loss of licence.

GM3 CAT.GEN.MPA.215 Support programme

ED Decision 2018/012/R

TRAINING AND AWARENESS

- (a) When promoting the benefits of the support programme, the operator should stress at least the following elements of the programme:
- (1) positive impacts of a support programme;
 - (2) awareness of job stressors and life stressors — mental fitness and mental health;
 - (3) coping strategies;
 - (4) potential effects of psychoactive substances and their use or misuse;
 - (5) medication use (prescribed and over-the-counter medication) to ensure the safe exercise of the privileges of the licence whilst taking medication;
 - (6) early recognition of mental unfitness;
 - (7) principles and availability of a support programme; and
 - (8) data protection and confidentiality principles.
- (b) Mental health professionals involved in the support programme should be trained on:
- (1) psychological first aid;
 - (2) applicable legal requirements regarding data protection; and
 - (3) cases where information should be disclosed due to an immediate and evident safety threat and in the interest of public safety.
- (c) Peers involved in the support programme should receive practically orientated basic training in psychological first aid and regular refresher trainings.

GM4 CAT.GEN.MPA.215 Support programme

ED Decision 2018/012/R

ELEMENTS CONTRIBUTING TO A SUPPORT PROGRAMME

When implementing a support programme, the operator should pay attention to the following:

- (a) establishment and verification of operational and data protection procedures;
- (b) selection and training of dedicated and experienced staff and peers;
- (c) offer of motivating alternative positions to flight crew in case a return to in-flight duties is not possible; and
- (d) limitation of the financial consequences of a loss of licence, for example through extending loss of licence coverage.

GM5 CAT.GEN.MPA.215 Support programme

ED Decision 2018/012/R

POSSIBILITY TO CONTRACT THE ESTABLISHMENT OF A SUPPORT PROGRAMME TO A THIRD PARTY

The operator may contract the establishment of a support programme to a third party. For a smaller-sized operator, the synergies created by a third-party support programme can be beneficial and in some cases may provide the only feasible option to ensure access to a support programme or to ensure availability of trained peers.

GM6 CAT.GEN.MPA.215 Support programme

ED Decision 2018/012/R

OBLIGATION TO SEEK AERO-MEDICAL ADVICE IN CASE OF A DECREASE IN MEDICAL FITNESS

Joining a support programme does not remove the flight crew's obligation to seek aero-medical advice in case of a decrease in medical fitness in accordance with MED.A.020 of Commission Regulation (EU) No 1178/2011.

GM7 CAT.GEN.MPA.215 Support programme

ED Decision 2018/012/R

SCOPE OF THE SUPPORT PROGRAMME

Nothing should prevent an operator from extending the scope of the support programme to include, apart from flight crew, other safety-sensitive categories personnel, e.g. cabin crew or maintenance, as well.

GM8 CAT.GEN.MPA.215 Support programme

ED Decision 2018/012/R

MEANING OF THE TERM 'PEER'

- (a) In the context of a support programme, a 'peer' is a trained person who shares common professional qualifications and experience, and has encountered similar situations, problems or conditions with the person seeking assistance from a support programme. This may or may not be a person working in the same organisation as the person seeking assistance from the support programme.
- (b) A peer's involvement in a support programme can be beneficial due to similar professional backgrounds between the peer and the person seeking support. However, a mental health professional should support the peer when required, e.g. in cases where intervention is required to prevent endangering safety.

SUBPART B: OPERATING PROCEDURES

SECTION 1 – MOTOR-POWERED AIRCRAFT

CAT.OP.MPA.100 Use of air traffic services

Regulation (EU) 2021/1296

- (a) The operator shall ensure that:
- (1) air traffic services (ATS) appropriate to the airspace and the applicable rules of the air are used for all flights whenever available;
 - (2) in-flight operational instructions involving a change to the ATS flight plan, when practicable, are coordinated with the appropriate ATS unit before transmission to an aircraft.
- (b) Notwithstanding (a), the use of ATS is not required unless mandated by air space requirements for:
- (1) operations under VFR by day of other-than complex motor-powered aeroplanes;
 - (2) helicopters with an MCTOM of 3 175 kg or less operated by day and over routes navigated by reference to visual landmarks; or
 - (3) local helicopter operations (LHOs),
provided that search and rescue service arrangements can be maintained.

GM1 CAT.OP.MPA.100(a)(2) Use of air traffic services

ED Decision 2014/015/R

IN-FLIGHT OPERATIONAL INSTRUCTIONS

When coordination with an appropriate air traffic service (ATS) unit has not been possible, in-flight operational instructions do not relieve a commander of the responsibility for obtaining an appropriate clearance from an ATS unit, if applicable, before making a change in flight plan.

CAT.OP.MPA.101 Altimeter check and settings

Regulation (EU) 2021/2237

- (a) The operator shall establish procedures for altimeter checking before each departure.
- (b) The operator shall establish procedures for altimeter settings for all phases of flight, which shall take into account the procedures established by the State of the aerodrome or the State of the airspace, if applicable.

GM1 CAT.OP.MPA.101(b) Altimeter check and settings

ED Decision 2022/014/R

ALTIMETER SETTING PROCEDURES

The following paragraphs of ICAO Doc 8168 (PANS-OPS), Volume III provide recommended guidance on how to develop the altimeter setting procedure:

- (a) 3.2 'Pre-flight operational test';

- (b) 3.3 'Take-off and climb';
- (c) 3.5 'Approach and landing'.

CAT.OP.MPA.105 Use of aerodromes and operating sites

Regulation (EU) 2015/140

- (a) The operator shall only use aerodromes and operating sites that are adequate for the type(s) of aircraft and operation(s) concerned.
- (b) The use of operating sites shall only apply to:
 - (1) other-than complex motor-powered aeroplanes; and
 - (2) helicopters.

AMC1 CAT.OP.MPA.105 Use of aerodromes and operating sites

ED Decision 2014/015/R

DEFINING OPERATING SITES — HELICOPTERS

When defining operating sites (including infrequent or temporary sites) for the type(s) of helicopter(s) and operation(s) concerned, the operator should take account of the following:

- (a) An adequate site is a site that the operator considers to be satisfactory, taking account of the applicable performance requirements and site characteristics (guidance on standards and criteria are contained in ICAO Annex 14 Volume 2 and in the ICAO *Helicopter Manual* (Doc 9261-AN/903)).
- (b) The operator should have in place a procedure for the survey of sites by a competent person. Such a procedure should take account of possible changes to the site characteristics which may have taken place since last surveyed.
- (c) Sites that are pre-surveyed should be specifically specified in the operations manual. The operations manual should contain diagrams or/and ground and aerial photographs, and depiction (pictorial) and description of:
 - (1) the overall dimensions of the site;
 - (2) location and height of relevant obstacles to approach and take-off profiles, and in the manoeuvring area;
 - (3) approach and take-off flight paths;
 - (4) surface condition (blowing dust/snow/sand);
 - (5) helicopter types authorised with reference to performance requirements;
 - (6) provision of control of third parties on the ground (if applicable);
 - (7) procedure for activating site with land owner or controlling authority;
 - (8) other useful information, for example, appropriate ATS agency and frequency; and
 - (9) lighting (if applicable).
- (d) For sites that are not pre-surveyed, the operator should have in place a procedure that enables the pilot to make, from the air, a judgment on the suitability of a site. (c)(1) to (c)(6) should be considered.

- (e) Operations to non-pre-surveyed sites by night (except in accordance with [SPA.HEMS.125\(b\)\(4\)](#)) should not be permitted.

CAT.OP.MPA.107 Adequate aerodrome

Regulation (EU) 2021/2237

The operator shall consider an aerodrome as adequate if, at the expected time of use, the aerodrome is available and equipped with necessary ancillary services such as air traffic services (ATS), sufficient lighting, communications, meteorological reports, navigation aids and emergency services.

AMC1 CAT.OP.MPA.107 Adequate aerodrome

ED Decision 2019/019/R

RESCUE AND FIREFIGHTING SERVICES (RFFS)

When considering the adequacy of an aerodrome's rescue and firefighting services (RFFS), the operator should:

- (a) as part of its management system, assess the level of RFFS protection available at the aerodrome intended to be specified in the operational flight plan in order to ensure that an acceptable level of protection is available for the intended operation; and
- (b) include relevant information related to the RFFS protection that is deemed acceptable by the operator in the operations manual.

GM1 CAT.OP.MPA.107 Adequate aerodrome

ED Decision 2022/005/R

VERIFICATION OF WEATHER CONDITIONS

This GM clarifies the difference between 'adequate aerodrome' and 'weather-permissible aerodrome'. The two concepts are complementary:

- 'adequate aerodrome': see definition in [Annex I](#) (Definitions for terms used in Annexes II to VIII) and point [CAT.OP.MPA.107](#) of Annex IV (Part-CAT) to Regulation (EU) No 965/2012; and
- 'weather-permissible aerodrome' means an adequate aerodrome with additional requirements: see definition in [Annex I](#) (Definitions for terms used in Annexes II to VIII).

Weather conditions are not required to be considered at an adequate aerodrome.

CAT.OP.MPA.110 Aerodrome operating minima

Regulation (EU) 2021/2237

- (a) The operator shall establish aerodrome operating minima for each departure, destination or alternate aerodrome that is planned to be used in order to ensure separation of the aircraft from terrain and obstacles and to mitigate the risk of loss of visual references during the visual flight segment of instrument approach operations.
- (b) The method used to establish aerodrome operating minima shall take all the following elements into account:
 - (1) the type, performance, and handling characteristics of the aircraft;

- (2) the equipment available on the aircraft for the purpose of navigation, acquisition of visual references, and/or control of the flight path during take-off, approach, landing, and the missed approach;
 - (3) any conditions or limitations stated in the aircraft flight manual (AFM);
 - (4) the relevant operational experience of the operator;
 - (5) the dimensions and characteristics of the runways/final approach and take-off areas (FATOs) that may be selected for use;
 - (6) the adequacy and performance of the available visual and non-visual aids and infrastructure;
 - (7) the obstacle clearance altitude/height (OCA/H) for the instrument approach procedures (IAPs);
 - (8) the obstacles in the climb-out areas and necessary clearance margins;
 - (9) the composition of the flight crew, their competence and experience;
 - (10) the IAP;
 - (11) the aerodrome characteristics and the available air navigation services (ANS);
 - (12) any minima that may be promulgated by the State of the aerodrome;
 - (13) the conditions prescribed in the operations specifications including any specific approvals for low-visibility operations (LVOs) or operations with operational credits.
 - (14) any non-standard characteristics of the aerodrome, the IAP or the environment
- (c) The operator shall specify a method of determining aerodrome operating minima in the operations manual.
- (d) The method used by the operator to establish aerodrome operating minima and any change to that method shall be approved by the competent authority.

AMC1 CAT.OP.MPA.110 Aerodrome operating minima

ED Decision 2022/012/R

TAKE-OFF OPERATIONS — AEROPLANES

(a) Take-off minima

Take-off minima should be expressed as visibility (VIS) or runway visual range (RVR) limits, taking into account all relevant factors for each runway planned to be used and aircraft characteristics and equipment. Where there is a specific need to see and avoid obstacles on departure and/or for a forced landing, additional conditions, e.g. ceiling, should be specified.

(b) Visual reference

- (1) The take-off minima should be selected to ensure sufficient guidance to control the aircraft in the event of both a rejected take-off in adverse circumstances and a continued take-off after failure of the critical engine.
- (2) For night operations, the prescribed runway lights should be in operation.

(c) Required RVR or VIS

- (1) For multi-engined aeroplanes, with performance such that, in the event of a critical engine failure at any point during take-off, the aeroplane can either stop or continue the

take-off to a height of 1 500 ft above the aerodrome while clearing obstacles by the required margins, the take-off minima specified by the operator should be expressed as RVR or VIS values not lower than those specified in Table 1.

- (2) For multi-engined aeroplanes without the performance to comply with the conditions in (c)(1), in the event of a critical engine failure, there may be a need to re-land immediately and to see and avoid obstacles in the take-off area. Such aeroplanes may be operated to the following take-off minima provided that they are able to comply with the applicable obstacle clearance criteria, assuming engine failure at the height specified. The take-off minima specified by the operator should be based upon the height from which the one-engine-inoperative (OEI) net take-off flight path can be constructed. The RVR minima used should not be lower than either of the values specified in Table 1 or Table 2.
- (3) For single-engined turbine aeroplane operations approved in accordance with Subpart L (SET-IMC) of Annex V (Part-SPA), the take-off minima specified by the operator should be expressed as RVR values not lower than those specified in Table 1.

Unless the operator is making use of a risk period, whenever the surface in front of the runway does not allow for a safe forced landing, the RVR values should not be lower than 800 m. In this case, the proportion of the flight to be considered starts at the lift-off position and ends when the aeroplane is able to turn back and land on the runway in the opposite direction or glide to the next landing site in case of power loss.

Table 1

Take-off — aeroplanes (without LVTO approval)

RVR or VIS

Minimum RVR* or VIS*	Facilities
500 m (day)	Nil**
400 m (day)	Centre line markings or Runway edge lights or Runway centre line lights
400 m (night)	Runway end lights*** and Runway edge lights or runway centreline lights

* The reported RVR or VIS value representative of the initial part of the take-off run can be replaced by pilot assessment.

** The pilot is able to continuously identify the take-off surface and maintain directional control.

*** Runway end lights may be substituted by colour-coded runway edge lights or colour-coded runway centre line lights.

Table 2

Take-off — aeroplanes (without LVTO approval)

Assumed engine failure height above the runway versus RVR or VIS

Assumed engine failure height above the take-off runway (ft)	RVR or VIS (m)**
<50	400
51–100	400
101–150	400
151–200	500
201–300	1 000
>300* or if no positive take-off flight path can be constructed	1 500

** The reported RVR or VIS value representative of the initial part of the take-off run can be replaced by pilot assessment.

AMC2 CAT.OP.MPA.110 Aerodrome operating minima

ED Decision 2022/012/R

TAKE-OFF OPERATIONS — HELICOPTERS

(a) General

- (1) Take-off minima should be expressed as VIS or RVR limits, taking into account all relevant factors for each aerodrome or operating site planned to be used and aircraft characteristics and equipment. Where there is a specific need to see and avoid obstacles on departure, or for a forced landing, additional conditions, e.g. ceiling, should be specified.
- (2) The commander should not commence take-off unless the meteorological conditions at the aerodrome or operating site of departure are equal to or better than the applicable minima for landing at that aerodrome or operating site unless a weather-permissible take-off alternate aerodrome is available.
- (3) When the reported VIS is below that required for take-off and the RVR is not reported, a take-off should only be commenced if the commander can determine that the visibility or RVR along the take-off runway/area is equal to or better than the required minimum.
- (4) When no reported VIS or RVR is available, a take-off should only be commenced if the commander can determine that the visibility along the take-off runway/area is equal to or better than the required minimum.

(b) Visual reference

- (1) The take-off minima should be selected to ensure sufficient guidance to control the aircraft in the event of both a rejected take-off in adverse circumstances and a continued take-off after failure of the critical engine.
- (2) For night operations, ground lights should be available to illuminate the take-off runway/final approach and take-off area (FATO) and any obstacles.
- (3) For point-in-space (PinS) departures to an initial departure fix (IDF), the take-off minima should be selected to ensure sufficient guidance to see and avoid obstacles and return to

the heliport if the flight cannot be continued visually to the IDF. This should require a VIS of 800 m. The ceiling should be 250 ft.

- (c) Required RVR or VIS
- (1) For performance class 1 operations, the operator should specify an RVR or a VIS as take-off minima in accordance with Table 3.
 - (2) For performance class 2 operations onshore, the commander should operate to take-off minima of 800 m RVR or VIS and remain clear of cloud during the take-off manoeuvre until reaching performance class 1 capabilities.
 - (3) For performance class 2 operations offshore, the commander should operate to minima not less than those for performance class 1 and remain clear of cloud during the take-off manoeuvre until reaching performance class 1 capabilities.

Table 3

Take-off — helicopters (without LVTO approval)

RVR or VIS

Onshore aerodromes with instrument flight rules (IFR) departure procedures	RVR or VIS (m)**
No light and no markings (day only)	400 or the rejected take-off distance, whichever is the greater
No markings (night)	800
Runway edge/FATO light and centre line marking	400
Runway edge/FATO light, centre line marking and relevant RVR information	400
Offshore helideck*	
Two-pilot operations	400
Single-pilot operations	500

* The take-off flight path to be free of obstacles.

** On PinS departures to IDF, VIS should not be less than 800 m and the ceiling should not be less than 250 ft.

AMC3 CAT.OP.MPA.110 Aerodrome operating minima

ED Decision 2022/012/R

DETERMINATION OF DH/MDH FOR INSTRUMENT APPROACH OPERATIONS — AEROPLANES

- (a) The decision height (DH) to be used for a 3D approach operation or a 2D approach operation flown using the continuous descent final approach (CDFA) technique should not be lower than the highest of:
- (1) the obstacle clearance height (OCH) for the category of aircraft;
 - (2) the published approach procedure DH or minimum descent height (MDH) where applicable;
 - (3) the system minima specified in Table 4;

- (4) the minimum DH permitted for the runway specified in Table 5; or
 - (5) the minimum DH specified in the aircraft flight manual (AFM) or equivalent document, if stated.
- (b) The MDH for a 2D approach operation flown not using the CDFA technique should not be lower than the highest of:
- (1) the OCH for the category of aircraft;
 - (2) the published approach procedure MDH where applicable;
 - (3) the system minima specified in Table 4;
 - (4) the lowest MDH permitted for the runway specified in Table 5; or
 - (5) the lowest MDH specified in the AFM, if stated.

Table 4
System minima — aeroplanes

Facility	Lowest DH/MDH (ft)
ILS/MLS/GLS	200
GNSS/SBAS (LPV)	200*
Precision approach radar (PAR)	200
GNSS/SBAS (LP)	250
GNSS (LNAV)	250
GNSS/Baro VNAV (LNAV/VNAV)	250
LOC with or without DME	250
SRA (terminating at ½ NM)	250
SRA (terminating at 1 NM)	300
SRA (terminating at 2 NM or more)	350
VOR	300
VOR/DME	250
NDB	350
NDB/DME	300
VDF	350

* For localiser performance with vertical guidance (LPV), a DH of 200 ft may be used only if the published FAS datablock sets a vertical alert limit not exceeding 35 m. Otherwise, the DH should not be lower than 250 ft.

Table 5
Runway type minima — aeroplanes

Runway type	Lowest DH/MDH (ft)	
Instrument runway	Precision approach (PA) runway, category I	200
	NPA runway	250
Non-Instrument runway	Non-instrument runway	Circling minima as shown in Table 15

- (c) Where a barometric DA/H or MDA/H is used, this should be adjusted where the ambient temperature is significantly below international standard atmosphere (ISA).

[GM8 CAT.OP.MPA.110](#) ‘Low temperature correction’ provides a cold temperature correction table for adjustment of minimum promulgated heights/altitudes.

AMC4 CAT.OP.MPA.110 Aerodrome operating minima

ED Decision 2022/012/R

DETERMINATION OF DH/MDH FOR INSTRUMENT APPROACH OPERATIONS — HELICOPTERS

- (a) The DH or MDH to be used for a 3D or a 2D approach operation should not be lower than the highest of:
- (1) the OCH for the category of aircraft;
 - (2) the published approach procedure DH or MDH where applicable;
 - (3) the system minima specified in Table 6;
 - (4) the minimum DH permitted for the runway/FATO specified in Table 7, if applicable; or
 - (5) the minimum DH specified in the AFM or equivalent document, if stated.

Table 6

System minima — helicopters

Facility	Lowest DH/MDH (ft)
ILS/MLS/GLS	200
GNSS/SBAS (LPV)*	200
Precision approach radar (PAR)	200
GNSS/SBAS (LP)	250
GNSS (LNAV)	250
GNSS/Baro VNAV (LNAV/VNAV)	250
Helicopter PinS approach	250**
LOC with or without DME	250
SRA (terminating at ½ NM)	250
SRA (terminating at 1 NM)	300
SRA (terminating at 2 NM or more)	350
VOR	300
VOR/DME	250
NDB	350
NDB/DME	300
VDF	350

* For LPV, a DH of 200 ft may be used only if the published FAS datablock sets a vertical alert limit not exceeding 35 m. Otherwise, the DH should not be lower than 250 ft.

** For PinS approaches with instructions to ‘proceed VFR’ to an undefined or virtual destination, the DH or MDH should be with reference to the ground below the missed approach point (MAPt).

Table 7

Type of runway/FATO versus lowest DH/MDH — helicopters

Type of runway/FATO	Lowest DH/MDH (ft)
Precision approach (PA) runway, category I	200
Non-precision approach (NPA) runway	
Non-instrument runway	

Instrument FATO	200
FATO	250

Table 7 does not apply to helicopter PinS approaches with instructions to ‘proceed VFR’.

AMC5 CAT.OP.MPA.110 Aerodrome operating minima

ED Decision 2022/014/R

DETERMINATION OF RVR OR VIS FOR INSTRUMENT APPROACH OPERATIONS — AEROPLANES

- (a) The RVR or VIS for straight-in instrument approach operations should be not less than the greatest of:
- (1) the minimum RVR or VIS for the type of runway used according to Table 8;
 - (2) the minimum RVR determined according to the MDH or DH and class of lighting facility according to Table 9; or
 - (3) the minimum RVR according to the visual and non-visual aids and on-board equipment used according to Table 10.

If the value determined in (1) is a VIS, then the result is a minimum VIS. In all other cases, the result is a minimum RVR.

- (b) For Category A and B aeroplanes, if the RVR or VIS determined in accordance with (a) is greater than 1 500 m, then 1 500 m should be used.
- (c) If the approach is flown with a level flight segment at or above the MDA/H, then 200 m should be added to the RVR calculated in accordance with (a) and (b) for Category A and B aeroplanes and 400 m for Category C and D aeroplanes.
- (d) The visual aids should comprise standard runway day markings, runway edge lights, threshold lights, runway end lights and approach lights as defined in Table 11.

Table 8

Type of runway versus minimum RVR or VIS — aeroplanes

Type of runway	Minimum RVR or VIS (m)
PA runway Category I	RVR 550
NPA runway	RVR 750
Non-instrument runway	VIS according to Table 15 (circling minima)

Table 9

RVR versus DH/MDH — aeroplanes

DH or MDH (ft)			Class of lighting facility			
			FALS	IALS	BALS	NALS
			RVR (m)			
200	-	210	550	750	1 000	1 200
211	-	240	550	800	1 000	1 200
241	-	250	550	800	1 000	1 300
251	-	260	600	800	1 100	1 300
261	-	280	600	900	1 100	1 300
281	-	300	650	900	1 200	1 400
301	-	320	700	1 000	1 200	1 400

321	-	340	800	1 100	1 300	1 500
341	-	360	900	1 200	1 400	1 600
361	-	380	1 000	1 300	1 500	1 700
381	-	400	1 100	1 400	1 600	1 800
401	-	420	1 200	1 500	1 700	1 900
421	-	440	1 300	1 600	1 800	2 000
441	-	460	1 400	1 700	1 900	2 100
461	-	480	1 500	1 800	2 000	2 200
481		500	1 500	1 800	2 100	2 300
501	-	520	1 600	1 900	2 100	2 400
521	-	540	1 700	2 000	2 200	2 400
541	-	560	1 800	2 100	2 300	2 400
561	-	580	1 900	2 200	2 400	2 400
581	-	600	2 000	2 300	2 400	2 400
601	-	620	2 100	2 400	2 400	2 400
621	-	640	2 200	2 400	2 400	2 400
641		660	2 300	2 400	2 400	2 400
661	and above		2 400	2 400	2 400	2 400

Table 10
Visual and non-visual aids and/or on-board equipment versus minimum RVR — aeroplanes

Type of approach	Facilities	Lowest RVR	
		Multi-pilot operations	Single-pilot operations
3D operations	runway touchdown zone lights (RTZL) and runway centre line lights (RCLL)	No limitation	
Final approach track offset $\leq 15^\circ$ for category A and B aeroplanes or $\leq 5^\circ$ for Category C and D aeroplanes	without RTZL and RCLL but using HUDLS or equivalent system; autopilot or flight director to the DH	No limitation	600 m
	No RTZL and RCLL, not using HUDLS or equivalent system or autopilot to the DH	750 m	800 m
3D operations	runway touchdown zone lights (RTZL) and runway centre line lights (RCLL) and Final approach track offset $> 15^\circ$ for Category A and B aeroplanes or Final approach track offset $> 5^\circ$ for Category C and D aeroplanes	800 m	1 000 m
	without RTZL and RCLL but using HUDLS or equivalent system; autopilot or flight director to the DH and	800 m	1 000 m

	Final approach track offset > 15° for Category A and B aeroplanes or Final approach track offset > 5° for Category C and D aeroplanes		
2D operations	Final approach track offset ≤15° for category A and B aeroplanes or ≤5° for Category C and D aeroplanes	750 m	800 m
	Final approach track offset > 15° for Category A and B aeroplanes	1 000 m	1 000 m
	Final approach track offset > 5° for Category C and D aeroplanes	1 200 m	1 200 m

Table 11

Approach lighting systems — aeroplanes

Class of lighting facility	Length, configuration and intensity of approach lights
FALS	CAT I lighting system (HIALS ≥720 m) distance coded centre line, barrette centre line
IALS	Simple approach lighting system (HIALS 420–719 m) single source, barrette
BALS	Any other approach lighting system (HIALS, MALS or ALS 210–419 m)
NALS	Any other approach lighting system (HIALS, MALS or ALS <210 m) or no approach lights

- (e) For night operations or for any operation where credit for visual aids is required, the lights should be on and serviceable except as provided for in Table 17.
- (f) Where any visual or non-visual aid specified for the approach and assumed to be available in the determination of operating minima is unavailable, revised operating minima will need to be determined.

AMC6 CAT.OP.MPA.110 Aerodrome operating minima

ED Decision 2022/012/R

DETERMINATION OF RVR OR VIS FOR INSTRUMENT APPROACH OPERATIONS — HELICOPTERS

The RVR/VIS minima for Type A instrument approach and Type B CAT I instrument approach operations should be determined as follows:

- (a) For IFR operations, the RVR or VIS should not be less than the greatest of:
 - (1) the minimum RVR or VIS for the type of runway/FATO used according to Table 12;
 - (2) the minimum RVR determined according to the MDH or DH and class of lighting facility according to Table 13; or
 - (3) for PinS operations with instructions to ‘proceed visually’, the distance between the MAPt of the PinS and the FATO or its approach light system.

If the value determined in (1) is a VIS, then the result is a minimum VIS. In all other cases, the result is a minimum RVR.

- (b) For PinS operations with instructions to ‘proceed VFR’, the VIS should be compatible with visual flight rules.

- (c) For Type A instrument approaches where the MAPt is within ½ NM of the landing threshold, the approach minima specified for FALS may be used regardless of the length of the approach lights available. However, FATO/runway edge lights, threshold lights, end lights and FATO/runway markings are still required.
- (d) An RVR of less than 800 m should not be used except when using a suitable autopilot coupled to an ILS, an MLS, a GLS or LPV, in which case normal minima apply.
- (e) For night operations, ground lights should be available to illuminate the FATO/runway and any obstacles.
- (f) The visual aids should comprise standard runway day markings, runway edge lights, threshold lights and runway end lights and approach lights as specified in Table 14.
- (g) For night operations or for any operation where credit for runway and approach lights as defined in Table 14 is required, the lights should be on and serviceable except as defined in Table 17.

Table 12

Type of runway/FATO versus minimum RVR — helicopters

Type of runway/FATO	Minimum RVR or VIS
PA runway, category I NPA runway Non-instrument runway	RVR 550 m
Instrument FATO FATO	RVR 550 m RVR/VIS 800 m

Table 13

Onshore helicopter instrument approach minima

DH/MDH (ft)	Facilities versus RVR (m)			
	FALS	IALS	BALS	NALS
200	550	600	700	1 000
201–249	550	650	750	1 000
250–299	600*	700*	800	1 000
300 and above	750*	800	900	1 000

* Minima on 2D approach operations should be no lower than 800 m.

Table 14

Approach lighting systems — helicopters

Class of lighting facility	Length, configuration and intensity of approach lights
FALS	CAT I lighting system (HIALS ≥ 720 m) distance coded centre line, barrette centre line
IALS	Simple approach lighting system (HIALS 420–719 m) single source, barrette
BALS	Any other approach lighting system (HIALS, MALS or ALS 210–419 m)
NALS	Any other approach lighting system (HIALS, MALS or ALS < 210 m) or no approach lights

AMC7 CAT.OP.MPA.110 Aerodrome operating minima

ED Decision 2022/012/R

CIRCLING OPERATIONS — AEROPLANES

(a) Circling minima

The following standards should apply for establishing circling minima for operations with aeroplanes:

- (1) the MDH for circling operation should not be lower than the highest of:
 - (i) the published circling OCH for the aeroplane category;
 - (ii) the minimum circling height derived from Table 15; or
 - (iii) the DH/MDH of the preceding instrument approach procedure (IAP);
- (2) the MDA for circling should be calculated by adding the published aerodrome elevation to the MDH, as determined by (a)(1); and
- (3) the minimum VIS for circling should be the higher of:
 - (i) the circling VIS for the aeroplane category, if published; or
 - (ii) the minimum VIS derived from Table 15.

Table 15

Circling — aeroplanes

MDH and minimum VIS versus aeroplane category

	Aeroplane category			
	A	B	C	D
MDH (ft)	400	500	600	700
Minimum VIS (m)	1 500	1 600	2 400	3 600

(b) Conduct of flight — general

- (1) the MDH and OCH included in the procedure are referenced to aerodrome elevation;
- (2) the MDA is referenced to mean sea level;
- (3) for these procedures, the applicable visibility is the VIS; and
- (4) operators should provide tabular guidance of the relationship between height above threshold and the in-flight visibility required to obtain and sustain visual contact during the circling manoeuvre.

(c) Instrument approach followed by visual manoeuvring (circling) without prescribed tracks

- (1) When the aeroplane is on the initial instrument approach, before visual reference is established, but not below MDA/H, the aeroplane should follow the corresponding IAP until the appropriate instrument MAPt is reached.
- (2) At the beginning of the level flight phase at or above the MDA/H, the instrument approach track should be maintained until the pilot:
 - (i) estimates that, in all probability, visual contact with the runway of intended landing or the runway environment will be maintained during the entire circling procedure;

- (ii) estimates that the aeroplane is within the circling area before commencing circling; and
 - (iii) is able to determine the aeroplane's position in relation to the runway of intended landing with the aid of the appropriate visual references.
 - (3) If the pilot cannot comply with the conditions in (c)(2) at the MAPt, then a missed approach should be executed in accordance with the IAP.
 - (4) After the aeroplane has left the track of the initial instrument approach, the flight phase outbound from the runway should be limited to an appropriate distance, which is required to align the aeroplane onto the final approach. Such manoeuvres should be conducted to enable the aeroplane to:
 - (i) attain a controlled and stable descent path to the intended landing runway; and
 - (ii) remain within the circling area and in such way that visual contact with the runway of intended landing or runway environment is maintained at all times.
 - (5) Flight manoeuvres should be carried out at an altitude/height that is not less than the circling MDA/H.
 - (6) Descent below MDA/H should not be initiated until the threshold of the runway to be used has been appropriately identified. The aeroplane should be in a position to continue with a normal rate of descent and land within the touchdown zone (TDZ).
- (d) Instrument approach followed by a visual manoeuvring (circling) with prescribed track
 - (1) The aeroplane should remain on the initial IAP until one of the following is reached:
 - (i) the prescribed divergence point to commence circling on the prescribed track; or
 - (ii) the MAPt.
 - (2) The aeroplane should be established on the instrument approach track in level flight at or above the MDA/H at or by the circling manoeuvre divergence point.
 - (3) If the divergence point is reached before the required visual reference is acquired, a missed approach should be initiated not later than the MAPt and completed in accordance with the instrument approach procedure.
 - (4) When commencing the prescribed circling manoeuvre at the published divergence point, the subsequent manoeuvres should be conducted to comply with the published routing and published heights/altitudes.
 - (5) Unless otherwise specified, once the aeroplane is established on the prescribed track(s), the published visual reference does not need to be maintained unless:
 - (i) required by the State of the aerodrome; or
 - (ii) the circling MAPt (if published) is reached.
 - (6) If the prescribed circling manoeuvre has a published MAPt and the required visual reference has not been obtained by that point, a missed approach should be executed in accordance with (e)(2) and (e)(3).
 - (7) Subsequent further descent below MDA/H should only commence when the required visual reference has been obtained.
 - (8) Unless otherwise specified in the procedure, final descent should not be commenced from MDA/H until the threshold of the intended landing runway has been identified and

the aeroplane is in a position to continue with a normal rate of descent to land within the TDZ.

- (e) Missed approach
- (1) Missed approach during the instrument procedure prior to circling
 - (i) If the missed approach procedure is required to be flown when the aeroplane is positioned on the instrument approach track defined by radio-navigation aids RNAV, RNP, or ILS, MLS, and before commencing the circling manoeuvre, the published missed approach for the instrument approach should be followed; or
 - (ii) If the IAP is carried out with the aid of an ILS, an MLS or a stabilised approach (SAp), the MAPt associated with an ILS or an MLS procedure without glide path (GP-out procedure) or the SAp, where applicable, should be used.
 - (2) If a prescribed missed approach is published for the circling manoeuvre, this overrides the manoeuvres prescribed below.
 - (3) If visual reference is lost while circling to land after the aeroplane has departed from the initial instrument approach track, the missed approach specified for that particular instrument approach should be followed. It is expected that the pilot will make an initial climbing turn toward the intended landing runway to a position overhead the aerodrome where the pilot will establish the aeroplane in a climb on the instrument missed approach segment.
 - (4) The aeroplane should not leave the visual manoeuvring (circling) area, which is obstacle-protected, unless:
 - (i) established on the appropriate missed approach procedure; or
 - (ii) at minimum sector altitude (MSA).
 - (5) All turns should be made in the same direction and the aeroplane should remain within the circling protected area while climbing either:
 - (i) to the altitude assigned to any published circling missed approach manoeuvre if applicable;
 - (ii) to the altitude assigned to the missed approach of the initial instrument approach;
 - (iii) to the MSA; or
 - (iv) to the minimum holding altitude (MHA) applicable to transition to a holding facility or fix, or continue to climb to an MSA;

or as directed by ATS.

When the missed approach procedure is commenced on the 'downwind' leg of the circling manoeuvre, an 'S' turn may be undertaken to align the aeroplane on the initial instrument approach missed approach path, provided the aeroplane remains within the protected circling area.

The commander should be responsible for ensuring adequate terrain clearance during the above-stipulated manoeuvres, particularly during the execution of a missed approach initiated by ATS.

- (6) Because the circling manoeuvre may be accomplished in more than one direction, different patterns will be required to establish the aeroplane on the prescribed missed approach course depending on its position at the time visual reference is lost. In

particular, all turns are to be in the prescribed direction if this is restricted, e.g. to the west/east (left or right hand) to remain within the protected circling area.

- (7) If a missed approach procedure is published for a particular runway onto which the aeroplane is conducting a circling approach and the aeroplane has commenced a manoeuvre to align with the runway, the missed approach for this direction may be accomplished. The ATS unit should be informed of the intention to fly the published missed approach procedure for that particular runway.
- (8) The commander should advise ATS when any missed approach procedure has been commenced, the height/altitude the aeroplane is climbing to and the position the aeroplane is proceeding towards and/or heading the aeroplane is established on.

AMC8 CAT.OP.MPA.110 Aerodrome operating minima

ED Decision 2022/012/R

ONSHORE CIRCLING OPERATIONS — HELICOPTERS

For circling, the specified MDH should not be less than 250 ft, and the VIS not less than 800 m.

AMC9 CAT.OP.MPA.110 Aerodrome operating minima

ED Decision 2014/015/R

VISUAL APPROACH OPERATIONS

The operator should not use an RVR of less than 800 m for a visual approach operation.

AMC10 CAT.OP.MPA.110 Aerodrome operating minima

ED Decision 2022/012/R

CONVERSION OF VISIBILITY TO CMV — AEROPLANES

The following conditions apply to the use of converted meteorological visibility (CMV) instead of RVR:

- (a) If the reported RVR is not available, a CMV may be substituted for the RVR, except:
 - (1) to satisfy the take-off minima; or
 - (2) for the purpose of continuation of an approach in LVOs.
- (b) If the minimum RVR for an approach is more than the maximum value assessed by the aerodrome operator, then CMV should be used.
- (c) In order to determine CMV from visibility:
 - (1) for flight planning purposes, a factor of 1.0 should be used;
 - (2) for purposes other than flight planning, the conversion factors specified in Table 16 should be used.

Table 16

Conversion of reported VIS to RVR/CMV

Light elements in operation	RVR/CMV = reported VIS x	
	Day	Night
HI approach and runway lights	1.5	2.0
Any type of light installation other than above	1.0	1.5
No lights	1.0	not applicable

AMC11 CAT.OP.MPA.110 Aerodrome operating minima

ED Decision 2022/014/R

EFFECT ON LANDING MINIMA OF TEMPORARILY FAILED OR DOWNGRADED GROUND EQUIPMENT

(a) General

These instructions are intended for use both before and during flight. It is, however, not expected that the commander would consult such instructions after passing 1 000 ft above the aerodrome. If failures of ground aids are announced at such a late stage, the approach could be continued at the commander’s discretion. If failures are announced before such a late stage in the approach, their effect on the approach should be considered as described in Table 17, and the approach may have to be abandoned.

(b) Conditions applicable to Table 17:

- (1) multiple failures of runway/FATO lights other than those indicated in Table 17 should not be acceptable;
- (2) failures of approach and runway/FATO lights are acceptable at the same time, and the most demanding consequence should be applied; and
- (3) failures other than ILS, GLS, MLS affect the RVR only and not DH.

Table 17

Failed or downgraded equipment — effect on landing minima

Operations without LVO approval

Failed or downgraded equipment	Effect on landing minima	
	Type B	Type A
Navaid stand-by transmitter	No effect	
Outer marker (ILS only)	Not allowed except if the required height versus glide path can be checked using other means, e.g. DME fix	APV — not applicable NPA with final approach fix (FAF): no effect unless used as FAF If the FAF cannot be identified (e.g. no method available for timing of descent), NPA operations cannot be conducted
Middle marker (ILS only)	No effect	No effect unless used as MAPt
RVR assessment systems	No effect	
Approach lights	Minima as for NALS	
Approach lights except the last 210 m	Minima as for BALS	
Approach lights except the last 420 m	Minima as for IALS	
Standby power for approach lights	No effect	
Edge lights, threshold lights and runway end lights	Day: no effect; Night: not allowed	
Centre line lights	Aeroplanes: No effect if flight director (F/D), HUDLS or autoland; otherwise RVR 750 m Helicopters: No effect on CAT I and HELI SA	No effect

Failed or downgraded equipment	Effect on landing minima	
	Type B	Type A
	CAT I approach operations	
Centre line lights spacing increased to 30 m	No effect	
TDZ lights	Aeroplanes: No effect if F/D, HUDLS or autoland; otherwise RVR 750 m Helicopters: No effect	No effect
Taxiway lighting system	No effect	

AMC12 CAT.OP.MPA.110 Aerodrome operating minima

ED Decision 2014/015/R

VFR OPERATIONS WITH OTHER-THAN-COMPLEX MOTOR-POWERED AIRCRAFT

For the establishment of VFR operation minima, the operator may apply the VFR operating minima specified in Part-SERA. Where necessary, the operator may specify in the OM additional conditions for the applicability of such minima taking into account such factors as radio coverage, terrain, nature of sites for take-off and landing, flight conditions and ATS capacity.

GM1 CAT.OP.MPA.110 Aerodrome operating minima

ED Decision 2014/015/R

ONSHORE AERODROME DEPARTURE PROCEDURES — HELICOPTERS

The cloud base and visibility should be such as to allow the helicopter to be clear of cloud at take-off decision point (TDP), and for the pilot flying to remain in sight of the surface until reaching the minimum speed for flight in instrument meteorological conditions (IMC) given in the AFM.

GM2 CAT.OP.MPA.110 Aerodrome operating minima

ED Decision 2022/012/R

APPROACH LIGHTING SYSTEMS — ICAO, FAA

The following table provides a comparison of ICAO and FAA specifications.

Table 19

Approach lighting systems — ICAO and FAA specifications

Class of lighting facility	Length, configuration and intensity of approach lights
FALS	ICAO: CAT I lighting system (HIALS \geq 720 m) distance coded centre line, barrette centre line FAA: ALSF1, ALSF2, SSALR, MALSR, high or medium intensity and/or flashing lights, 720 m or more
IALS	ICAO: simple approach lighting system (HIALS 420–719 m) single source, barrette FAA: MALSF, MALS, SALS/SALSF, SSALF, SSALS, high or medium intensity and/or flashing lights, 420–719 m
BALS	Any other approach lighting system (HIALS, MALS or ALS 210–419 m) FAA: ODALS, high or medium intensity or flashing lights 210–419 m

NALS

Any other approach lighting system (HIALS, MALS or ALS <210 m) or no approach lights

GM3 CAT.OP.MPA.110 Aerodrome operating minima

ED Decision 2022/012/R

SBAS OPERATIONS

- (a) SBAS LPV operations with a DH of 200 ft depend on an SBAS system approved for operations down to a DH of 200 ft.
- (b) The following systems are in operational use or in a planning phase:
 - (1) European geostationary navigation overlay service (EGNOS) operational in Europe;
 - (2) wide area augmentation system (WAAS) operational in the USA;
 - (3) multi-functional satellite augmentation system (MSAS) operational in Japan;
 - (4) system of differential correction and monitoring (SDCM) planned by Russia;
 - (5) GPS aided geo augmented navigation (GAGAN) system, planned by India; and
 - (6) satellite navigation augmentation system (SNAS), planned by China.

GM4 CAT.OP.MPA.110 Aerodrome operating minima

ED Decision 2022/012/R

MEANS TO DETERMINE THE REQUIRED RVR BASED ON DH AND LIGHTING FACILITIES

The values in Table 9 are derived from the formula below:

Minimum RVR (m) = [(DH/MDH (ft) x 0.3048)/tan α] — length of approach lights (m)

where α is the calculation angle, being a default value of 3.00° increasing in steps of 0.10° for each line in Table 9 up to 3.77° and then remaining constant. An upper RVR limit of 2 400 m has been applied to the table.

GM5 CAT.OP.MPA.110 Aerodrome operating minima

ED Decision 2022/012/R

USE OF DH FOR NPAs FLOWN USING THE CDFA TECHNIQUE

[AMC3 CAT.OP.MPA.110](#) provides that, in certain circumstances, a published MDH may be used as a DH for a 2D operation flown using the CDFA technique.

The safety of the use of MDH as DH in CDFA operations has been verified by at least two independent analyses concluding that the CDFA using MDH as DH without any add-on is safer than the traditional step-down and level-flight NPA operation. A comparison has been made between the safety level of using MDH as DH without an add-on with the well-established safety level resulting from the ILS collision risk model. The NPA used was the most demanding, i.e. most tightly designed NPA, which offers the least additional margins. It should be noted that the design limits of the ILS approach design, e.g. the maximum GP angle of 3,5 degrees, must be observed for the CDFA in order to keep the validity of the comparison.

There is a wealth of operational experience in Europe confirming the above-mentioned analytical assessments. It cannot be expected that each operator is able to conduct similar safety assessments,

and this is not necessary. The safety assessments already performed take into account the most demanding circumstances at hand, like the most tightly designed NPA procedures and other 'worst-case scenarios'. The assessments naturally focus on cases where the controlling obstacle is located in the missed approach area.

However, it is necessary for operators to assess whether their cockpit procedures and training are adequate to ensure minimal height loss in case of a go-around manoeuvre. Suitable topics for the safety assessment required by each operator may include:

- understanding of the CDFA concept including the use of the MDA/H as DA/H;
- cockpit procedures that ensure flight on speed, on path and with proper configuration and energy management;
- cockpit procedures that ensure gradual decision-making; and
- identification of cases where an increase of the DA/H may be necessary because of non-standard circumstances, etc.

GM6 CAT.OP.MPA.110 Aerodrome operating minima

ED Decision 2022/012/R

INCREMENTS SPECIFIED BY THE COMPETENT AUTHORITY

Additional increments to the published minima may be specified by the competent authority to take into account certain operations, such as downwind approaches, single-pilot operations or approaches flown not using the CDFA technique.

GM7 CAT.OP.MPA.110 Aerodrome operating minima

ED Decision 2022/012/R

USE OF COMMERCIALY AVAILABLE INFORMATION

When an operator uses commercially available information to establish aerodrome operating minima, the operator remains responsible for ensuring that the material used is accurate and suitable for its operation, and that aerodrome operating minima are calculated in accordance with the method specified in Part C of its operations manual and approved by the competent authority.

The procedures in [ORO.GEN.205](#) 'Contracted activities' apply in this case.

GM8 CAT.OP.MPA.110 Aerodrome operating minima

ED Decision 2022/012/R

LOW TEMPERATURE CORRECTION

- (a) An operator may determine the aerodrome temperature below which a correction should be applied to the DA/H.
- (b) Table 20 may be used to determine the correction that should be applied.
- (c) The calculations in the table are for a sea-level aerodrome; they are therefore conservative when applied at higher-level aerodromes.
- (d) Guidance on accurate corrections for specific conditions (if required) is available in PANS-OPS, Volume I (ICAO Doc 8168) Section 1 Chapter 4.

Table 20

Temperature corrections to be applied to barometric DH/MDH

Aerodrome temperature (°C)	Height above the elevation of the altimeter setting source (ft)													
	200	300	400	500	600	700	800	900	1 000	1 500	2 000	3 000	4 000	5 000
0	20	20	30	30	40	40	50	50	60	90	120	170	230	280
-10	20	30	40	50	60	70	80	90	100	150	200	290	390	490
-20	30	50	60	70	90	100	120	130	140	210	280	420	570	710
-30	40	60	80	100	120	140	150	170	190	280	380	570	760	950
-40	50	80	100	120	150	170	190	220	240	360	480	720	970	1 210
-50	60	90	120	150	180	210	240	270	300	450	590	890	1 190	1 500

GM9 CAT.OP.MPA.110 Aerodrome operating minima

ED Decision 2022/012/R

AERODROME OPERATING MINIMA — HELICOPTERS

High vertical speeds should be avoided due to unstable aerodynamics and potential transient autorotation state of the main rotor.

Vertical speeds at or below 800 ft/min should be considered to be normal, and vertical speeds above 1 000 ft/min should be considered to be high.

The vertical speed on final approach increases with the descent angle and the ground speed (GS), including tailwinds. Whereas the helicopter should be manoeuvred into the wind during the visual segment of an instrument approach, tailwinds may be encountered during the instrument segments of the approach.

If the vertical speed is above 1 000 ft/min, a go-around should be considered. Greater vertical speeds may be used based on the available data in the rotorcraft flight manual.

Table 21 below gives an indication of the vertical speed based on the descent angles and ground speed.

Table 21

Examples of vertical speeds

Ground speed	Descent angle	Vertical speed
80 kt	5.7° (10 %)	800 ft/min
100 kt	5.7° (10 %)	1 000 ft/min
80 kt	7.5° (13.2 %)	1 050 ft/min
100 kt	7.5° (13.2 %)	1 300 ft/min

Note: A GS of 80 kt may be the result of an indicated airspeed (IAS) of 60 kt and a tailwind component of 20 kt.

GM1 CAT.OP.MPA.110(b)(6) Aerodrome operating minima

ED Decision 2022/012/R

VISUAL AND NON-VISUAL AIDS AND INFRASTRUCTURE

‘Visual and non-visual aids and infrastructure’ refers to all equipment and facilities required for the procedure to be used for the intended instrument approach operation. This includes but is not limited to lights, markings, ground- or space-based radio aids, etc.

CAT.OP.MPA.115 Approach flight technique — aeroplanes

Regulation (EU) 2021/2237

- (a) All approach operations shall be flown as stabilised approach operations unless otherwise approved by the competent authority for a particular approach to a particular runway.
- (b) The continuous descent final approach (CDFA) technique shall be used for approach operations using non-precision approach (NPA) procedures except for such particular runways for which the competent authority has approved another flight technique.

AMC1 CAT.OP.MPA.115 Approach flight technique — aeroplanes

ED Decision 2022/012/R

CONTINUOUS DESCENT FINAL APPROACH (CDFA)

The following criteria apply to CDFA:

- (a) For each NPA procedure to be used, the operator should provide information allowing the flight crew to determine the appropriate descent path. This information is either:
 - (1) a descent path depicted on the approach chart including check altitude/heights against range;
 - (2) a descent path coded into the aircraft flight management system; or
 - (3) a recommended descent rate based on estimated ground speed.
- (b) The information provided to the crew should observe human factors principles.
- (c) The descent path should be calculated to pass at or above the minimum altitude specified at any step-down fix.
- (d) The optimum angle for the descent path is 3° and should not exceed 4,5° except for steep approach operations approved in accordance with this Part.
- (e) For multi-pilot operations, the operator should establish procedures that require:
 - (1) the pilot monitoring to verbalise deviations from the required descent path;
 - (2) the pilot flying to make prompt corrections to deviation from the required descent path; and
 - (3) a call-out to be made when the aircraft is approaching the DA/H.
- (f) A missed approach should be executed promptly at the DA/H or the MAPt, whichever is first, if the required visual references have not been established.
- (g) For approaches other than circling approaches, the lateral part of the missed approach should be flown via the MAPt unless otherwise stated on the approach chart.

AMC2 CAT.OP.MPA.115 Approach flight technique — aeroplanes

ED Decision 2022/012/R

APPROACH OPERATIONS USING NPA PROCEDURES FLOWN WITH A FLIGHT TECHNIQUE OTHER THAN THE CDFA

- (a) In case the CDFA technique is not used, the approach should be flown to an altitude/height at or above the MDA/H where a level flight segment at or above MDA/H may be flown to the MAPt.
- (b) Even when the approach procedure is flown without the CDFA technique, the relevant procedures for ensuring a controlled and stable path to MDA/H should be followed.
- (c) In case the CDFA technique is not used when flying an approach, the operator should implement procedures to ensure that early descent to the MDA/H will not result in a subsequent flight below MDA/H without adequate visual reference. These procedures could include:
 - (1) awareness of radio altimeter information with reference to the approach profile;
 - (2) terrain awareness warning system (TAWS);
 - (3) limitation of rate of descent;
 - (4) limitation of the number of repeated approaches;
 - (5) safeguards against too early descents with prolonged flight at MDA/H; and
 - (6) specification of visual requirements for the descent from the MDA/H.
- (d) In case the CDFA technique is not used and when the MDA/H is high, it may be appropriate to make an early descent to MDA/H with appropriate safeguards such as the application of a significantly higher RVR or VIS.
- (e) The procedures that are flown with level flight at or above the MDA/H should be listed in the OM.
- (f) Operators should categorise aerodromes where there are approaches that require level flight at or above MDA/H as B or C. Such aerodrome categorisation will depend upon the operator's experience, operational exposure, training programme(s) and flight crew qualification(s).

AMC3 CAT.OP.MPA.115 Approach flight technique — aeroplanes

ED Decision 2022/012/R

OPERATIONAL PROCEDURES AND INSTRUCTIONS AND TRAINING

- (a) The operator should establish procedures and instructions for flying approaches using the CDFA technique and not using it. These procedures should be included in the operations manual and should include the duties of the flight crew during the conduct of such operations. The operator should ensure that the initial and recurrent flight crew training required by ORO.FC includes the use of the CDFA technique.
- (b) Operators holding an approval to use another technique for NPAs on certain runways should establish procedures for the application of such techniques.

AMC1 CAT.OP.MPA.115(a) Approach flight technique — aeroplanes

ED Decision 2022/014/R

STABILISED APPROACH OPERATIONS — AEROPLANES

The following criteria should be satisfied for all stabilised approach operations with aeroplanes:

- (a) The flight management systems and approach aids should be correctly set, and any required radio aids identified before reaching a predetermined point or altitude/height on the approach.
- (b) The aeroplane should be flown according to the following criteria from a predetermined point or altitude/height on the approach:
 - (1) the angle of bank should be less than 30 degrees; and
 - (2) the target rate of descent should be that required to maintain the correct vertical path at the planned approach speed.
- (c) Variations in the rate of descent should normally not exceed 50 % of the target rate of descent.
- (d) An aeroplane should be considered stabilised for landing when the following conditions are met:
 - (1) the aeroplane is tracking within an acceptable tolerance of the required lateral path;
 - (2) the aeroplane is tracking within an acceptable tolerance of the required vertical path;
 - (3) the vertical speed of the aeroplane is within an acceptable tolerance of the required rate of descent;
 - (4) the airspeed of the aeroplane is within an acceptable tolerance of the intended landing speed;
 - (5) the aeroplane is in the correct configuration for landing, unless operating procedures require a final configuration change for performance reasons after visual reference is acquired; and
 - (6) the thrust/power and trim settings are appropriate.
- (e) The aeroplane should be stabilised for landing before reaching 500 ft above the landing runway threshold elevation.
- (f) For approach operations where the pilot does not have visual reference with the ground, the aeroplane should additionally be stabilised for landing before reaching 1 000 ft above the landing runway threshold elevation except that a later stabilisation in airspeed may be acceptable if higher than normal approach speeds are required for operational reasons specified in the operations manual.
- (g) The operator should specify the following in the operations manual:
 - (1) the acceptable tolerances referred to in (d);
 - (2) the means to identify the predetermined points referred to in (a) and (b). This should normally be the FAF.
- (h) When the operator requests approval for an alternative to the stabilised approach criteria for a particular approach to a particular runway, the operator should demonstrate that the proposed alternative will ensure that an acceptable level of safety is achieved.

GM1 CAT.OP.MPA.115(a) Approach flight techniques — aeroplanes

ED Decision 2022/012/R

ACCEPTABLE TOLERANCES FOR STABILISED APPROACH OPERATIONS

- (a) The requirement for the aircraft to be tracking within an acceptable tolerance of the required lateral path does not imply that the aircraft has to be aligned with the runway centre line by any particular height.
- (b) The target rate of descent for the final approach segment (FAS) of a stabilised approach normally does not exceed 1 000 fpm. Where a rate of descent of more than 1 000 fpm will be required (e.g. due to high ground speed or a steeper-than-normal approach path), this should be briefed in advance.
- (c) Operational reasons for specifying a higher-than-normal approach speed below 1 000 ft may include compliance with air traffic control (ATC) speed restrictions.
- (d) For operations where a level flight segment is required during the approach (e.g. circling approaches or approaches flown as non-CDFA), the criteria in point (b) of [AMC1 CAT.OP.MPA.115\(a\)](#) should apply from the predetermined point until the start of the level flight segment and again from the point at which the aircraft begins descent from the level flight segment down to a point of 50 ft above the threshold or the point where the flare manoeuvre is initiated, if higher.

GM1 CAT.OP.MPA.115(b) Approach flight technique — aeroplanes

ED Decision 2022/012/R

CONTINUOUS DESCENT FINAL APPROACH (CDFA)

- (a) Introduction
 - (1) Controlled flight into terrain (CFIT) is a major hazard in aviation. Most CFIT accidents occur in the FAS of approach operations flown using the NPA procedures. The use of stabilised-approach criteria on a continuous descent with a constant, predetermined vertical path is seen as a major improvement in safety during the conduct of such approaches.
 - (2) The elimination of level flight segments at MDA close to the ground during approaches, and the avoidance of major changes in attitude and power/thrust close to the runway that can destabilise approaches, are seen as ways to reduce operational risks significantly.
 - (3) The term CDFA has been selected to cover a flight technique for instrument approach operations using NPA procedures.
 - (4) The advantages of CDFA are as follows:
 - (i) the technique enhances safe approach operations by the utilisation of standard operating practices;
 - (ii) the technique is similar to that used when flying an ILS approach, including when executing the missed approach and the associated missed approach procedure manoeuvre;
 - (iii) the aeroplane attitude may enable better acquisition of visual cues;
 - (iv) the technique may reduce pilot workload;
 - (v) the approach profile is fuel-efficient;

- (vi) the approach profile affords reduced noise levels;
 - (vii) the technique affords procedural integration with 3D approach operations; and
 - (viii) when used and the approach is flown in a stabilised manner, CDFA is the safest approach technique for all instrument approach operations using NPA procedures.
- (b) Stabilised approach (SAp)
- (1) The control of the descent path is not the only consideration when using the CDFA technique. Control of the aeroplane's configuration and energy is also vital to the safe conduct of an approach.
 - (2) The control of the flight path, described above as one of the specifications for conducting an SAp, should not be confused with the path specifications for using the CDFA technique. The predetermined path specification for conducting an SAp are established by the operator and published in the operations manual.
 - (3) The appropriate descent path for applying the CDFA technique is established by the following:
 - (A) the published 'nominal' slope information when the approach has a nominal vertical profile; and
 - (B) the designated final-approach segment minimum of 3 NM, and maximum, when using timing techniques, of 8 NM.
 - (4) Straight-in approach operations using CDFA do not have a level segment of flight at MDA/H. This enhances safety by mandating a prompt missed approach procedure manoeuvre at DA/H.
 - (5) An approach using the CDFA technique is always flown as an SAp, since this is a specification for applying CDFA. However, an SAp does not have to be flown using the CDFA technique, for example, a visual approach.
- (c) Circling approach operations using the CDFA technique
- Circling approach operations using the CDFA technique require a continuous descent from an altitude/height at or above the FAF altitude/height until MDA/H or visual flight manoeuvre altitude/height. This does not preclude level flight at or above the MDA/H. This level flight may be at MDA/H while following the IAP or after visual reference has been established as the aircraft is aligned with the final approach track. The conditions for descent from level flight are described in [AMC7 CAT.OP.MPA.110](#).

CAT.OP.MPA.125 Instrument departure and approach procedures

Regulation (EU) No 965/2012

- (a) The operator shall ensure that instrument departure and approach procedures established by the State of the aerodrome are used.
- (b) Notwithstanding (a), the commander may accept an ATC clearance to deviate from a published departure or arrival route, provided obstacle clearance criteria are observed and full account is taken of the operating conditions. In any case, the final approach shall be flown visually or in accordance with the established instrument approach procedures.
- (c) Notwithstanding (a), the operator may use procedures other than those referred to in (a) provided they have been approved by the State in which the aerodrome is located and are specified in the operations manual.

CAT.OP.MPA.126 Performance-based navigation

Regulation (EU) 2016/1199

The operator shall ensure that, when performance-based navigation (PBN) is required for the route or procedure to be flown:

- (a) the relevant PBN navigation specification is stated in the AFM or other document that has been approved by the certifying authority as part of an airworthiness assessment or is based on such approval; and
- (b) the aircraft is operated in conformance with the relevant navigation specification and limitations in the AFM or other document referred above.

AMC1 CAT.OP.MPA.126 Performance-based navigation

ED Decision 2016/015/R

PBN OPERATIONS

For operations where a navigation specification for performance-based navigation (PBN) has been prescribed and no specific approval is required in accordance with [SPA.PBN.100](#), the operator should:

- (a) establish operating procedures specifying:
 - (1) normal, abnormal and contingency procedures;
 - (2) electronic navigation database management; and
 - (3) relevant entries in the minimum equipment list (MEL);
- (b) specify the flight crew qualification and proficiency constraints and ensure that the training programme for relevant personnel is consistent with the intended operation; and
- (c) ensure continued airworthiness of the area navigation system.

AMC2 CAT.OP.MPA.126 Performance-based navigation

ED Decision 2022/012/R

MONITORING AND VERIFICATION

- (a) Preflight and general considerations
 - (1) At navigation system initialisation, the flight crew should confirm that the navigation database is current and verify that the aircraft position has been entered correctly, if required.
 - (2) The active flight plan, if applicable, should be checked by comparing the charts or other applicable documents with navigation equipment and displays. This includes confirmation of the departing runway and the waypoint sequence, reasonableness of track angles and distances, any altitude or speed constraints, and, where possible, which waypoints are fly-by and which are fly-over. Where relevant, the RF leg arc radii should be confirmed.
 - (3) The flight crew should check that the navigation aids critical to the operation of the intended PBN procedure are available.
 - (4) The flight crew should confirm the navigation aids that should be excluded from the operation, if any.

-
- (5) An arrival, approach or departure procedure should not be used if the validity of the procedure in the navigation database has expired.
 - (6) The flight crew should verify that the navigation systems required for the intended operation are operational.
- (b) Departure
- (1) Prior to commencing a take-off on a PBN procedure, the flight crew should check that the indicated aircraft position is consistent with the actual aircraft position at the start of the take-off roll (aeroplanes) or lift-off (helicopters).
 - (2) Where GNSS is used, the signal should be acquired before the take-off roll (aeroplanes) or lift-off (helicopters) commences.
 - (3) Unless automatic updating of the actual departure point is provided, the flight crew should ensure initialisation on the runway or FATO by means of a manual runway threshold or intersection update, as applicable. This is to preclude any inappropriate or inadvertent position shift after take-off.
- (c) Arrival and approach
- (1) The flight crew should verify that the navigation system is operating correctly and the correct arrival procedure and runway (including any applicable transition) are entered and properly depicted.
 - (2) Any published altitude and speed constraints should be observed.
 - (3) The flight crew should check approach procedures (including alternate aerodromes if needed) as extracted by the system (e.g. CDU flight plan page) or presented graphically on the moving map, in order to confirm the correct loading and the reasonableness of the procedure content.
 - (4) Prior to commencing the approach operation (before the IAF), the flight crew should verify the correctness of the loaded procedure by comparison with the appropriate approach charts. This check should include:
 - (i) the waypoint sequence;
 - (ii) reasonableness of the tracks and distances of the approach legs and the accuracy of the inbound course; and
 - (iii) the vertical path angle, if applicable.
- (d) Altimetry settings for RNP APCH operations using Baro VNAV
- (1) Barometric settings
 - (i) The flight crew should set and confirm the correct altimeter setting and check that the two altimeters provide altitude values that do not differ more than 100 ft at the most at or before the final approach fix (FAF).
 - (ii) The flight crew should fly the procedure with:
 - (A) a current local altimeter setting source available — a remote or regional altimeter setting source should not be used; and
 - (B) the QNH/QFE, as appropriate, set on the aircraft's altimeters.

- (2) Temperature compensation
 - (i) For RNP APCH operations to LNAV/VNAV minima using Baro VNAV:
 - (A) the flight crew should not commence the approach when the aerodrome temperature is outside the promulgated aerodrome temperature limits for the procedure unless the area navigation system is equipped with approved temperature compensation for the final approach;
 - (B) when the temperature is within promulgated limits, the flight crew should not make compensation to the altitude at the FAF;
 - (C) since only the final approach segment is protected by the promulgated aerodrome temperature limits, the flight crew should consider the effect of temperature on terrain and obstacle clearance in other phases of flight.
 - (ii) For RNP APCH operations to LNAV minima, the flight crew should consider the effect of temperature on terrain and obstacle clearance in all phases of flight, in particular on any step-down fix.
- (e) Sensor and lateral navigation accuracy selection
 - (1) For multi-sensor systems, the flight crew should verify, prior to approach, that the GNSS sensor is used for position computation.
 - (2) Flight crew of aircraft with RNP input selection capability should confirm that the indicated RNP value is appropriate for the PBN operation.

AMC3 CAT.OP.MPA.126 Performance-based navigation

ED Decision 2016/015/R

MANAGEMENT OF THE NAVIGATION DATABASE

- (a) For RNAV 1, RNAV 2, RNP 1, RNP 2, and RNP APCH, the flight crew should neither insert nor modify waypoints by manual entry into a procedure (departure, arrival or approach) that has been retrieved from the database. User-defined data may be entered and used for waypoint altitude/speed constraints on a procedure where said constraints are not included in the navigation database coding.
- (b) For RNP 4 operations, the flight crew should not modify waypoints that have been retrieved from the database. User-defined data (e.g. for flex-track routes) may be entered and used.
- (c) The lateral and vertical definition of the flight path between the FAF and the missed approach point (MAPt) retrieved from the database should not be revised by the flight crew.

AMC4 CAT.OP.MPA.126 Performance-based navigation

ED Decision 2016/015/R

DISPLAYS AND AUTOMATION

- (a) For RNAV 1, RNP 1, and RNP APCH operations, the flight crew should use a lateral deviation indicator, and where available, flight director and/or autopilot in lateral navigation mode.
- (b) The appropriate displays should be selected so that the following information can be monitored:
 - (1) the computed desired path;
 - (2) aircraft position relative to the lateral path (cross-track deviation) for FTE monitoring;

- (3) aircraft position relative to the vertical path (for a 3D operation).
- (c) The flight crew of an aircraft with a lateral deviation indicator (e.g. CDI) should ensure that lateral deviation indicator scaling (full-scale deflection) is suitable for the navigation accuracy associated with the various segments of the procedure.
- (d) The flight crew should maintain procedure centrelines unless authorised to deviate by air traffic control (ATC) or demanded by emergency conditions.
- (e) Cross-track error/deviation (the difference between the area-navigation-system-computed path and the aircraft-computed position) should normally be limited to $\pm \frac{1}{2}$ time the RNAV/RNP value associated with the procedure. Brief deviations from this standard (e.g. overshoots or undershoots during and immediately after turns) up to a maximum of 1 time the RNAV/RNP value should be allowable.
- (f) For a 3D approach operation, the flight crew should use a vertical deviation indicator and, where required by AFM limitations, a flight director or autopilot in vertical navigation mode.
- (g) Deviations below the vertical path should not exceed 75 ft at any time, or half-scale deflection where angular deviation is indicated, and not more than 75 ft above the vertical profile, or half-scale deflection where angular deviation is indicated, at or below 1 000 ft above aerodrome level. The flight crew should execute a missed approach if the vertical deviation exceeds this criterion, unless the flight crew has in sight the visual references required to continue the approach.

AMC5 CAT.OP.MPA.126 Performance-based navigation

ED Decision 2016/015/R

VECTORIZING AND POSITIONING

- (a) ATC tactical interventions in the terminal area may include radar headings, 'direct to' clearances which bypass the initial legs of an approach procedure, interceptions of an initial or intermediate segments of an approach procedure or the insertion of additional waypoints loaded from the database.
- (b) In complying with ATC instructions, the flight crew should be aware of the implications for the navigation system.
- (c) 'Direct to' clearances may be accepted to the IF provided that it is clear to the flight crew that the aircraft will be established on the final approach track at least 2 NM before the FAF.
- (d) 'Direct to' clearance to the FAF should not be acceptable. Modifying the procedure to intercept the final approach track prior to the FAF should be acceptable for radar-vectored arrivals or otherwise only with ATC approval.
- (e) The final approach trajectory should be intercepted no later than the FAF in order for the aircraft to be correctly established on the final approach track before starting the descent (to ensure terrain and obstacle clearance).
- (f) 'Direct to' clearances to a fix that immediately precede an RF leg should not be permitted.
- (g) For parallel offset operations en route in RNP 4 and A-RNP, transitions to and from the offset track should maintain an intercept angle of no more than 45° unless specified otherwise by ATC.

AMC6 CAT.OP.MPA.126 Performance-based navigation

ED Decision 2016/015/R

ALERTING AND ABORT

- (a) Unless the flight crew has sufficient visual reference to continue the approach operation to a safe landing, an RNP APCH operation should be discontinued if:
 - (1) navigation system failure is annunciated (e.g. warning flag);
 - (2) lateral or vertical deviations exceed the tolerances;
 - (3) loss of the on-board monitoring and alerting system.
- (b) Discontinuing the approach operation may not be necessary for a multi-sensor navigation system that includes demonstrated RNP capability without GNSS in accordance with the AFM.
- (c) Where vertical guidance is lost while the aircraft is still above 1 000 ft AGL, the flight crew may decide to continue the approach to LNAV minima, when supported by the navigation system.

AMC7 CAT.OP.MPA.126 Performance-based navigation

ED Decision 2016/015/R

CONTINGENCY PROCEDURES

- (a) The flight crew should make the necessary preparation to revert to a conventional arrival procedure where appropriate. The following conditions should be considered:
 - (1) failure of the navigation system components including navigation sensors, and a failure effecting flight technical error (e.g. failures of the flight director or autopilot);
 - (2) multiple system failures affecting aircraft performance;
 - (3) coasting on inertial sensors beyond a specified time limit; and
 - (4) RAIM (or equivalent) alert or loss of integrity function.
- (b) In the event of loss of PBN capability, the flight crew should invoke contingency procedures and navigate using an alternative means of navigation.
- (c) The flight crew should notify ATC of any problem with PBN capability.
- (d) In the event of communication failure, the flight crew should continue with the operation in accordance with published lost communication procedures.

GM1 CAT.OP.MPA.126 Performance-based navigation

ED Decision 2016/015/R

DESCRIPTION

- (a) For both, RNP X and RNAV X designations, the 'X' (where stated) refers to the lateral navigation accuracy (total system error) in NM, which is expected to be achieved at least 95 % of the flight time by the population of aircraft operating within the airspace, route or procedure. For RNP APCH and A-RNP, the lateral navigation accuracy depends on the segment.
- (b) PBN may be required on notified routes, for notified procedures and in notified airspace.

RNAV 10

- (c) For purposes of consistency with the PBN concept, this Regulation is using the designation 'RNAV 10' because this specification does not include on-board performance monitoring and alerting.
- (d) However, it should be noted that many routes still use the designation 'RNP 10' instead of 'RNAV 10'. 'RNP 10' was used as designation before the publication of the fourth edition of ICAO Doc 9613 in 2013. The terms 'RNP 10' and 'RNAV 10' should be considered equivalent.

CAT.OP.MPA.130 Noise abatement procedures — aeroplanes*Regulation (EU) 2015/140*

- (a) Except for VFR operations of other-than complex motor-powered aeroplanes, the operator shall establish appropriate operating departure and arrival/approach procedures for each aeroplane type taking into account the need to minimise the effect of aircraft noise.
- (b) The procedures shall:
 - (1) ensure that safety has priority over noise abatement; and
 - (2) be simple and safe to operate with no significant increase in crew workload during critical phases of flight.

AMC1 CAT.OP.MPA.130 Noise abatement procedures — aeroplanes*ED Decision 2014/015/R***NADP DESIGN**

- (a) For each aeroplane type, two departure procedures should be defined, in accordance with ICAO Doc 8168 (Procedures for Air Navigation Services, 'PANS-OPS'), Volume I:
 - (1) noise abatement departure procedure one (NADP 1), designed to meet the close-in noise abatement objective; and
 - (2) noise abatement departure procedure two (NADP 2), designed to meet the distant noise abatement objective.
- (b) For each type of NADP (1 and 2), a single climb profile should be specified for use at all aerodromes, which is associated with a single sequence of actions. The NADP 1 and NADP 2 profiles may be identical.

GM1 CAT.OP.MPA.130 Noise abatement procedures — aeroplanes*ED Decision 2014/015/R***TERMINOLOGY**

- (a) 'Climb profile' means in this context the vertical path of the NADP as it results from the pilot's actions (engine power reduction, acceleration, slats/flaps retraction).
- (b) 'Sequence of actions' means the order in which these pilot's actions are done and their timing.

GENERAL

- (c) The rule addresses only the vertical profile of the departure procedure. Lateral track has to comply with the standard instrument departure (SID).

EXAMPLE

- (d) For a given aeroplane type, when establishing the distant NADP, the operator should choose either to reduce power first and then accelerate, or to accelerate first and then wait until slats/flaps are retracted before reducing power. The two methods constitute two different sequences of actions.
- (e) For an aeroplane type, each of the two departure climb profiles may be defined by one sequence of actions (one for close-in, one for distant) and two above aerodrome level (AAL) altitudes/heights. These are:
 - (1) the altitude of the first pilot's action (generally power reduction with or without acceleration). This altitude should not be less than 800 ft AAL; or
 - (2) the altitude of the end of the noise abatement procedure. This altitude should usually not be more than 3 000 ft AAL.

These two altitudes may be runway specific when the aeroplane flight management system (FMS) has the relevant function which permits the crew to change thrust reduction and/or acceleration altitude/height. If the aeroplane is not FMS-equipped or the FMS is not fitted with the relevant function, two fixed heights should be defined and used for each of the two NADPs.

CAT.OP.MPA.131 Noise abatement procedures — helicopters*Regulation (EU) No 965/2012*

- (a) The operator shall ensure that take-off and landing procedures take into account the need to minimise the effect of helicopter noise.
- (b) The procedures shall:
 - (1) ensure that safety has priority over noise abatement; and
 - (2) be simple and safe to operate with no significant increase in crew workload during critical phases of flight.

CAT.OP.MPA.135 Routes and areas of operation — general*Regulation (EU) 2016/1119*

- (a) The operator shall ensure that operations are only conducted along routes, or within areas, for which:
 - (1) space-based facilities, ground facilities and services, including meteorological services, adequate for the planned operation are provided;
 - (2) the performance of the aircraft is adequate to comply with minimum flight altitude requirements;
 - (3) the equipment of the aircraft meets the minimum requirements for the planned operation; and
 - (4) appropriate maps and charts are available.
- (b) The operator shall ensure that operations are conducted in accordance with any restriction on the routes or the areas of operation specified by the competent authority.
- (c) point (a)(1) shall not apply to operations under VFR by day of other-than complex motor-powered aircraft on flights that depart from and arrive at the same aerodrome or operating site.

AMC1 CAT.OP.MPA.135 Routes and areas of operation — general

ED Decision 2016/015/R

RNAV 10

- (a) Operating procedures and routes should take account of the RNAV 10 time limit declared for the inertial system, if applicable, considering also the effect of weather conditions that could affect flight duration in RNAV 10 airspace.
- (b) The operator may extend RNAV 10 inertial navigation time by position updating. The operator should calculate, using statistically-based typical wind scenarios for each planned route, points at which updates can be made, and the points at which further updates will not be possible.

CAT.OP.MPA.136 Routes and areas of operation — single-engined aeroplanes

Regulation (EU) 2017/363

Unless approved by the competent authority in accordance with Annex V (Part-SPA), Subpart L — SINGLE-ENGINE TURBINE AEROPLANE OPERATIONS AT NIGHT OR IN IMC (SET-IMC), the operator shall ensure that operations of single-engined aeroplanes are only conducted along routes, or within areas, where surfaces are available that permit a safe forced landing to be executed.

CAT.OP.MPA.137 Routes and areas of operation — helicopters

Regulation (EU) No 965/2012

The operator shall ensure that:

- (a) for helicopters operated in performance class 3, surfaces are available that permit a safe forced landing to be executed, except when the helicopter has an approval to operate in accordance with [CAT.POL.H.420](#);
- (b) for helicopters operated in performance class 3 and conducting 'coastal transit' operations, the operations manual contains procedures to ensure that the width of the coastal corridor, and the equipment carried, is consistent with the conditions prevailing at the time.

GM1 CAT.OP.MPA.137(b) Routes and areas of operation — helicopters

ED Decision 2014/015/R

COASTAL TRANSIT

- (a) General
 - (1) Helicopters operating overwater in performance class 3 have to have certain equipment fitted. This equipment varies with the distance from land that the helicopter is expected to operate. The aim of this GM is to discuss that distance, bring into focus what fit is required and to clarify the operator's responsibility, when a decision is made to conduct coastal transit operations.
 - (2) In the case of operations north of 45N or south of 45S, the coastal corridor facility may or may not be available in a particular state, as it is related to the State definition of open sea area as described in the definition of hostile environment.

-
- (3) Where the term 'coastal transit' is used, it means the conduct of operations overwater within the coastal corridor in conditions where there is reasonable expectation that:
- (i) the flight can be conducted safely in the conditions prevailing;
 - (ii) following an engine failure, a safe forced landing and successful evacuation can be achieved; and
 - (iii) survival of the crew and passengers can be assured until rescue is effected.
- (4) Coastal corridor is a variable distance from the coastline to a maximum distance corresponding to three minutes' flying at normal cruising speed.
- (b) Establishing the width of the coastal corridor
- (1) The maximum distance from land of coastal transit, is defined as the boundary of a corridor that extends from the land, to a maximum distance of up to 3 minutes at normal cruising speed (approximately 5 - 6 NM). Land in this context includes sustainable ice (see (i) to (iii) below) and, where the coastal region includes islands, the surrounding waters may be included in the corridor and aggregated with the coast and each other. Coastal transit need not be applied to inland waterways, estuary crossing or river transit.
- (i) In some areas, the formation of ice is such that it can be possible to land, or force land, without hazard to the helicopter or occupants. Unless the competent authority considers that operating to, or over, such ice fields is unacceptable, the operator may regard that the definition of the 'land' extends to these areas.
 - (ii) The interpretation of the following rules may be conditional on (i) above:
 - [CAT.OP.MPA.137\(a\)\(2\)](#);
 - [CAT.IDE.H.290](#);
 - [CAT.IDE.H.295](#);
 - [CAT.IDE.H.300](#); and
 - [CAT.IDE.H.320](#).
 - (iii) In view of the fact that such featureless and flat white surfaces could present a hazard and could lead to white-out conditions, the definition of land does not extend to flights over ice fields in the following rules:
 - [CAT.IDE.H.125\(d\)](#); and
 - [CAT.IDE.H.145](#).
- (2) The width of the corridor is variable from not safe to conduct operations in the conditions prevailing, to the maximum of 3 minutes wide. A number of factors will, on the day, indicate if it can be used — and how wide it can be. These factors will include, but not be restricted to, the following:
- (i) meteorological conditions prevailing in the corridor;
 - (ii) instrument fit of the aircraft;
 - (iii) certification of the aircraft — particularly with regard to floats;
 - (iv) sea state;
 - (v) temperature of the water;
 - (vi) time to rescue; and

- (vii) survival equipment carried.
- (3) These can be broadly divided into three functional groups:
- (i) those that meet the provisions for safe flying;
 - (ii) those that meet the provisions for a safe forced landing and evacuation; and
 - (iii) those that meet the provisions for survival following a forced landing and successful evacuation.
- (c) Provision for safe flying
- (1) It is generally recognised that when flying out of sight of land in certain meteorological conditions, such as those occurring in high pressure weather patterns (goldfish bowl — no horizon, light winds and low visibility), the absence of a basic panel (and training) can lead to disorientation. In addition, lack of depth perception in these conditions demands the use of a radio altimeter with an audio voice warning as an added safety benefit — particularly when autorotation to the surface of the water may be required.
 - (2) In these conditions, the helicopter, without the required instruments and radio altimeter, should be confined to a corridor in which the pilot can maintain reference using the visual cues on the land.
- (d) Provision for a safe forced landing and evacuation
- (1) Weather and sea state both affect the outcome of an autorotation following an engine failure. It is recognised that the measurement of sea state is problematical and when assessing such conditions, good judgement has to be exercised by the operator and the commander.
 - (2) Where floats have been certificated only for emergency use (and not for ditching), operations should be limited to those sea states that meet the provisions for such use — where a safe evacuation is possible.
- Ditching certification requires compliance with a comprehensive number of requirements relating to rotorcraft water entry, flotation and trim, occupant egress and occupant survival. Emergency flotation systems, generally fitted to smaller CS-27 rotorcraft, are approved against a broad specification that the equipment should perform its intended function and not hazard the rotorcraft or its occupants. In practice, the most significant difference between ditching and emergency flotation systems is substantiation of the water entry phase. Ditching rules call for water entry procedures and techniques to be established and promulgated in the AFM. The fuselage/flotation equipment should thereafter be shown to be able to withstand loads under defined water entry conditions which relate to these procedures. For emergency flotation equipment, there is no specification to define the water entry technique and no specific conditions defined for the structural substantiation.
- (e) Provisions for survival
- (1) Survival of crew members and passengers, following a successful autorotation and evacuation, is dependent on the clothing worn, the equipment carried and worn, the temperature of the sea and the sea state. Search and rescue (SAR) response/capability consistent with the anticipated exposure should be available before the conditions in the corridor can be considered non-hostile.

- (2) Coastal transit can be conducted (including north of 45N and south of 45S — when the definition of open sea areas allows) providing the provisions of (c) and (d) are met, and the conditions for a non-hostile coastal corridor are satisfied.

CAT.OP.MPA.140 Maximum distance from an adequate aerodrome for two-engined aeroplanes without an ETOPS approval

Regulation (EU) 2019/1387

- (a) Unless approved by the competent authority in accordance with Subpart F of Annex V (Part-SPA), the operator shall not operate a two-engined aeroplane over a route that contains a point further from an adequate aerodrome, under standard conditions in still air, than the appropriate distance for the given type of aeroplane among the following:
 - (1) for performance class A aeroplanes with a maximum operational passenger seating configuration (MOPSC) of 20 or more, the distance flown in 60 minutes at the one-engine-inoperative (OEI) cruising speed determined in accordance with point (b);
 - (2) for performance class A aeroplanes with an MOPSC of 19 or less, the distance flown in 120 minutes or, subject to approval by the competent authority, up to 180 minutes for turbojet aeroplanes, at the OEI cruising speed determined in accordance with point (b);
 - (3) for performance class B or C aeroplanes, whichever is less:
 - (i) the distance flown in 120 minutes at the OEI cruising speed determined in accordance with point (b);
 - (ii) 300 NM.
- (b) The operator shall determine a speed for the calculation of the maximum distance to an adequate aerodrome for each two-engined aeroplane type or variant operated, not exceeding VMO (maximum operating speed) based upon the true airspeed that the aeroplane can maintain with one engine inoperative.
- (c) The operator shall include the following data, specific to each type or variant, in the operations manual:
 - (1) the determined OEI cruising speed; and
 - (2) the determined maximum distance from an adequate aerodrome.
- (d) To obtain the approval referred to in point (a)(2), the operator shall provide evidence that:
 - (1) procedures have been established for flight planning and dispatch;
 - (2) specific maintenance instructions and procedures to ensure the intended levels of continued airworthiness and reliability of the aeroplane including its engines have been established and included in the operator's aircraft maintenance programme in accordance with Annex I (Part-M) to Regulation (EU) No 1321/2014, including:
 - (i) an engine oil consumption programme;
 - (ii) an engine condition monitoring programme.

AMC1 CAT.OP.MPA.140(d) Maximum distance from an adequate aerodrome for two-engined aeroplanes without an ETOPS approval

ED Decision 2022/014/R

OPERATION OF NON-ETOPS-COMPLIANT TWIN TURBO-JET AEROPLANES WITH MOPSC OF 19 OR LESS BETWEEN 120 AND 180 MINUTES FROM AN ADEQUATE AERODROME

- (a) For operations between 120 and 180 minutes, the operator should include the relevant information in its operations manual (OM) and its maintenance procedures.
- (b) The aeroplane should be certified to CS-25 or equivalent (e.g. FAR-25)
- (c) Engine events and corrective action
 - (1) All engine events and operating hours should be reported by the operator to the airframe and engine type certificate (TC) holders, as well as to the competent authority.
 - (2) These events should be evaluated by the operator in consultation with the competent authority and with the engine and airframe TC holders. The competent authority may consult EASA to ensure that worldwide data is evaluated.
 - (3) Where statistical assessment alone is not applicable, e.g. where the fleet size or accumulated flight hours are small, individual engine events should be reviewed on a case-by-case basis.
 - (4) The evaluation or statistical assessment, when available, may result in corrective action or the application of operational restrictions.
 - (5) Engine events could include engine shutdowns, both on-ground and in-flight, excluding normal training events, including flameout, occurrences where the intended thrust level was not achieved or where crew action was taken to reduce thrust below the normal level for whatever reason, and unscheduled removals.
 - (6) The operator should ensure that all corrective actions required by the competent authority are implemented.
- (d) Maintenance
 - (1) The operator's oil-consumption-monitoring programme should be based on engine manufacturer's recommendations, if available, and track oil consumption trends. The monitoring should be continuous and take account of the oil added.
 - (2) The engine monitoring programme should also provide for engine condition monitoring describing the parameters to be monitored, the method of data collection and a corrective action process, and should be based on the engine manufacturer's instructions. This monitoring will be used to detect propulsion system deterioration at an early stage allowing corrective action to be taken before safe operation is affected.
- (e) Flight crew training

The operator should establish a flight crew training programme for this type of operation that includes, in addition to the requirements of Subpart FC (Flight Crew) of Annex III (Part-ORO), particular emphasis on the following:

- (1) Fuel management: verifying required fuel on board prior to departure and monitoring fuel on board en-route, including calculation of fuel remaining. Procedures should provide for an independent cross-check of fuel quantity indicators, e.g. fuel flow may be

used to calculate the fuel burned, which may be compared with the indicated fuel remaining. It should be confirmed that the fuel remaining is sufficient to satisfy the critical fuel reserves.

- (2) Procedures for single and multiple failures in flight that may give rise to go/no-go and diversion decisions — policy and guidelines to aid the flight crew in the diversion decision-making process and emphasising the need for constant awareness of the closest weather-permissible alternate aerodrome in terms of time.
- (3) OEI performance data: drift-down procedures and OEI service ceiling data.
- (4) Meteorological reports and flight requirements: meteorological aerodrome reports (METARs) and terminal aerodrome forecast (TAF) reports and obtaining in-flight weather updates on the en-route alternate (ERA), destination and destination alternate aerodromes. Consideration should also be given to forecast winds, including the accuracy of the forecast compared to actual wind experienced during flight and meteorological conditions along the expected flight path at the OEI cruising altitude and throughout the approach and landing.

(f) Pre-departure check

A pre-departure check, additional to the pre-flight inspection required by Part-M and designed to verify the status of the aeroplane's significant systems, should be conducted. Adequate status monitoring information on all significant systems should be available to the flight crew to conduct the pre-departure check. The content of the pre-departure check should be described in the OM. The operator should ensure that flight crew members are fully trained and competent to conduct a pre-departure check of the aeroplane. The operator's required training programme should cover all relevant tasks, with particular emphasis on checking required fluid levels.

(g) MEL

The operator should establish in its MEL the minimum equipment that has to be serviceable for non-ETOPS operations between 120 and 180 minutes. The operator should ensure that the MEL takes into account all items specified by the manufacturer relevant to this type of operations.

(h) Dispatch/flight planning rules

The operator should establish dispatch procedures that address the following:

- (1) Fuel and oil supply: for releasing an aeroplane on an extended range flight, the operator should ensure that it carries sufficient fuel and oil to meet the applicable operational requirements and any additional fuel that may be determined in accordance with the following:
 - (i) Critical fuel scenario: in establishing the critical fuel reserves, the applicant is to determine the fuel necessary to fly to the most critical point of the route and execute a diversion to an alternate aerodrome assuming a simultaneous failure of an engine and the cabin air pressurisation system. The operator should carry additional fuel for the worst-case fuel burn condition (one engine versus two engines operating) if this is greater than the additional fuel calculated in accordance with the fuel requirements in CAT.OP.MPA, in order to:

- (A) fly from the critical point to an alternate aerodrome:
 - (a) at 10 000 ft; or
 - (b) at 25 000 ft or the single-engine ceiling, whichever is lower, provided that all occupants can be supplied with and use oxygen for the time required to fly from the critical point to an alternate aerodrome;
 - (B) descend and hold at 1 500 ft for 15 minutes in standard conditions;
 - (C) descend to the applicable MDA/DH followed by a missed approach (taking into account the complete missed approach procedure); followed by
 - (D) a normal approach and landing.
- (ii) Ice protection: additional fuel used when operating in icing conditions (e.g. operation of ice protection systems (engine/airframe as applicable)) and, when manufacturer's data is available, take account of ice accumulation on unprotected surfaces if icing conditions are likely to be encountered during a diversion.
 - (iii) APU operation: if an APU has to be used to provide additional electrical power, consideration should be given to the additional fuel required.
- (2) Communication facilities: the operator should ensure the availability of communications facilities in order to allow reliable two-way voice communications between the aeroplane and the appropriate ATC unit at OEI cruise altitudes.
 - (3) Aircraft technical log review to ensure that proper MEL procedures, deferred items, and required maintenance checks have been completed.
 - (4) ERA aerodrome(s): the operator should ensure that ERA aerodromes are available for the intended route, within the distance flown in 180 minutes based upon the OEI cruising speed, which is a speed within the certified limits of the aeroplane, selected by the operator and approved by the competent authority, confirming that, based on the available meteorological information, the weather conditions at ERA aerodromes are at or above the applicable minima for the applicable period of time, in accordance with [CAT.OP.MPA.182](#).

GM1 CAT.OP.MPA.140(c) Maximum distance from an adequate aerodrome for two-engined aeroplanes without an ETOPS approval

ED Decision 2014/015/R

ONE-ENGINE-INOPERATIVE (OEI) CRUISING SPEED

The OEI cruising speed is intended to be used solely for establishing the maximum distance from an adequate aerodrome.

GM1 CAT.OP.MPA.140(d) Maximum distance from an adequate aerodrome for two-engined aeroplanes without an ETOPS approval

ED Decision 2021/005/R

SIGNIFICANT SYSTEMS

(a) Definition:

Significant systems to be checked are the aeroplane propulsion system and any other aeroplane systems whose failure could adversely affect the safety of a non-ETOPS diversion flight, or whose functioning is important to continued safe flight and landing during an aeroplane diversion.

(b) When defining the pre-departure check, the operator should give consideration, at least, to the following systems:

- (1) electrical;
- (2) hydraulic;
- (3) pneumatic;
- (4) flight instrumentation, including warning and caution systems;
- (5) fuel, including potential leakage, fuel drains, fuel boost and fuel transfer;
- (6) flight control;
- (7) ice protection;
- (8) engine start and ignition;
- (9) propulsion system instruments;
- (10) engine thrust reversers;
- (11) navigation and communications, including any route specific long-range navigation and communication equipment;
- (12) back-up power systems (i.e. emergency generator and auxiliary power unit);
- (13) air conditioning and pressurisation;
- (14) cargo fire detection and suppression;
- (15) propulsion system fire detection and suppression;
- (16) emergency equipment (e.g. ELT, hand fire extinguisher, etc.).

CAT.OP.MPA.145 Establishment of minimum flight altitudes

Regulation (EU) No 965/2012

(a) The operator shall establish for all route segments to be flown:

- (1) minimum flight altitudes that provide the required terrain clearance, taking into account the requirements of Subpart C; and
- (2) a method for the flight crew to determine those altitudes.

(b) The method for establishing minimum flight altitudes shall be approved by the competent authority.

- (c) Where the minimum flight altitudes established by the operator and a State overflown differ, the higher values shall apply.

AMC1 CAT.OP.MPA.145(a) Establishment of minimum flight altitudes

ED Decision 2014/015/R

CONSIDERATIONS FOR ESTABLISHING MINIMUM FLIGHT ALTITUDES

- (a) The operator should take into account the following factors when establishing minimum flight altitudes:
- (1) the accuracy with which the position of the aircraft can be determined;
 - (2) the probable inaccuracies in the indications of the altimeters used;
 - (3) the characteristics of the terrain, such as sudden changes in the elevation, along the routes or in the areas where operations are to be conducted;
 - (4) the probability of encountering unfavourable meteorological conditions, such as severe turbulence and descending air currents; and
 - (5) possible inaccuracies in aeronautical charts.
- (b) The operator should also consider:
- (1) corrections for temperature and pressure variations from standard values;
 - (2) ATC requirements; and
 - (3) any foreseeable contingencies along the planned route.

AMC1.1 CAT.OP.MPA.145(a) Establishment of minimum flight altitudes

ED Decision 2014/015/R

CONSIDERATIONS FOR ESTABLISHING MINIMUM FLIGHT ALTITUDES

This AMC provides another means of complying with the rule for VFR operations of other-than-complex motor-powered aircraft by day, compared to that presented in [AMC1 CAT.OP.MPA.145\(a\)](#). The safety objective should be satisfied if the operator ensures that operations are only conducted along such routes or within such areas for which a safe terrain clearance can be maintained and take account of such factors as temperature, terrain and unfavourable meteorological conditions.

GM1 CAT.OP.MPA.145(a) Establishment of minimum flight altitudes

ED Decision 2014/015/R

MINIMUM FLIGHT ALTITUDES

- (a) The following are examples of some of the methods available for calculating minimum flight altitudes.
- (b) KSS formula:
- (1) Minimum obstacle clearance altitude (MOCA)
 - (i) MOCA is the sum of:
 - (A) the maximum terrain or obstacle elevation, whichever is higher; plus

- (B) 1 000 ft for elevation up to and including 6 000 ft; or
- (C) 2 000 ft for elevation exceeding 6 000 ft rounded up to the next 100 ft.
- (ii) The lowest MOCA to be indicated is 2 000 ft.
- (iii) From a VOR station, the corridor width is defined as a borderline starting 5 NM either side of the VOR, diverging 4° from centreline until a width of 20 NM is reached at 70 NM out, thence paralleling the centreline until 140 NM out, thence again diverging 4° until a maximum width of 40 NM is reached at 280 NM out. Thereafter, the width remains constant (see Figure 1).

Figure 1

Corridor width from a VOR station

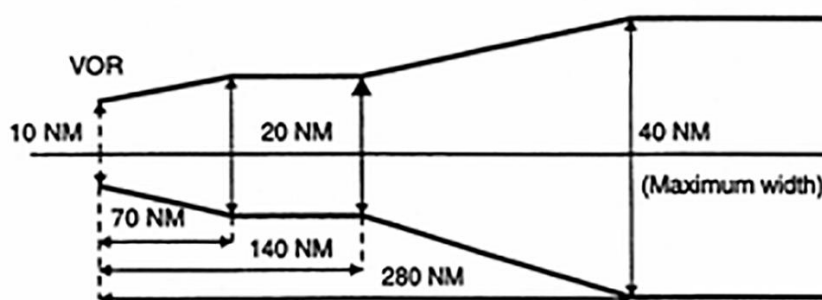

- (iv) From a non-directional beacon (NDB), similarly, the corridor width is defined as a borderline starting 5 NM either side of the NDB diverging 7° until a width of 20 NM is reached 40 NM out, thence paralleling the centreline until 80 NM out, thence again diverging 7° until a maximum width of 60 NM is reached 245 NM out. Thereafter, the width remains constant (see Figure 2).

Figure 2

Corridor width from an NDB

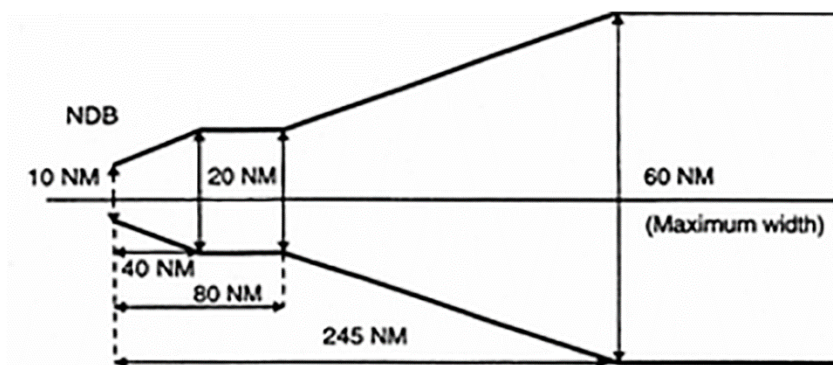

- (v) MOCA does not cover any overlapping of the corridor.
- (2) Minimum off-route altitude (MORA). MORA is calculated for an area bounded by each or every second LAT/LONG square on the route facility chart (RFC)/terminal approach chart (TAC) and is based on a terrain clearance as follows:

- (i) terrain with elevation up to 6 000 ft (2 000 m) – 1 000 ft above the highest terrain and obstructions;
 - (ii) terrain with elevation above 6 000 ft (2 000 m) – 2 000 ft above the highest terrain and obstructions.
- (c) Jeppesen formula (see Figure 3)
- (1) MORA is a minimum flight altitude computed by Jeppesen from current operational navigation charts (ONCs) or world aeronautical charts (WACs). Two types of MORAs are charted which are:
 - (i) route MORAs e.g. 9800a; and
 - (ii) grid MORAs e.g. 98.
 - (2) Route MORA values are computed on the basis of an area extending 10 NM to either side of route centreline and including a 10 NM radius beyond the radio fix/reporting point or mileage break defining the route segment.
 - (3) MORA values clear all terrain and man-made obstacles by 1 000 ft in areas where the highest terrain elevation or obstacles are up to 5 000 ft. A clearance of 2 000 ft is provided above all terrain or obstacles that are 5 001 ft and above.
 - (4) A grid MORA is an altitude computed by Jeppesen and the values are shown within each grid formed by charted lines of latitude and longitude. Figures are shown in thousands and hundreds of feet (omitting the last two digits so as to avoid chart congestion). Values followed by ± are believed not to exceed the altitudes shown. The same clearance criteria as explained in (c)(3) apply.

Figure 3

Jeppesen formula

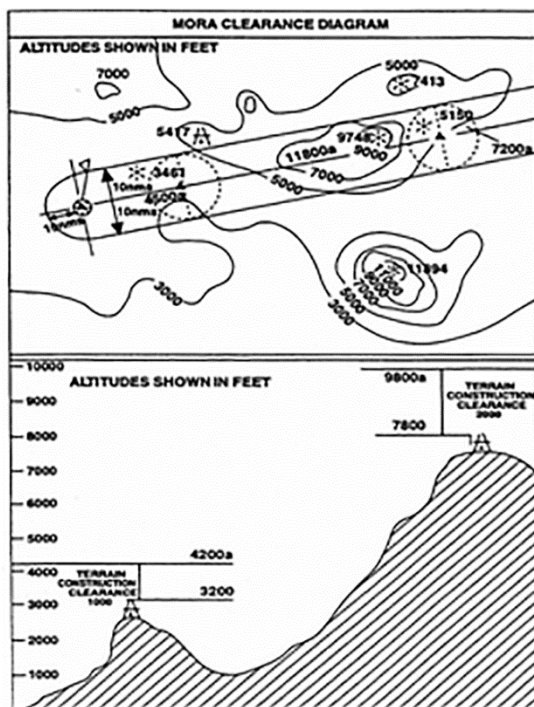

(d) ATLAS formula

- (1) Minimum en-route altitude (MEA). Calculation of the MEA is based on the elevation of the highest point along the route segment concerned (extending from navigational aid to navigational aid) within a distance on either side of track as specified in Table 1 below:

Table 1

Minimum safe en-route altitude

Segment length	Distance either side of track
Up to 100 NM	10 NM *
More than 100 NM	10 % of segment length up to a maximum of 60 NM **

*: This distance may be reduced to 5 NM within terminal control areas (TMAs) where, due to the number and type of available navigational aids, a high degree of navigational accuracy is warranted.

**: In exceptional cases, where this calculation results in an operationally impracticable value, an additional special MEA may be calculated based on a distance of not less than 10 NM either side of track. Such special MEA will be shown together with an indication of the actual width of protected airspace.

- (2) The MEA is calculated by adding an increment to the elevation specified above as appropriate, following Table 2 below. The resulting value is adjusted to the nearest 100 ft.

Table 2:

Increment added to the elevation *

Elevation of highest point	Increment
Not above 5 000 ft	1 500 ft
Above 5 000 ft but not above 10 000 ft	2 000 ft
Above 10 000 ft	10 % of elevation plus 1 000 ft

*: For the last route segment ending over the initial approach fix, a reduction to 1 000 ft is permissible within TMAs where, due to the number and type of available navigation aids, a high degree of navigational accuracy is warranted.

- (3) Minimum safe grid altitude (MGA). Calculation of the MGA is based on the elevation of the highest point within the respective grid area.

The MGA is calculated by adding an increment to the elevation specified above as appropriate, following Table 3 below. The resulting value is adjusted to the nearest 100 ft.

Table 3

Minimum safe grid altitude

Elevation of highest point	Increment
Not above 5 000 ft	1 500 ft
Above 5 000 ft but not above 10 000 ft	2 000 ft
Above 10 000 ft	10 % of elevation plus 1 000 ft

(e) Lido formula

(1) Minimum terrain clearance altitude (MTCA)

The MTCA represents an altitude providing terrain and obstacle clearance for all airways/ATS routes, all standard terminal arrival route (STAR) segments up to IAF or equivalent end point and for selected standard instrument departures (SIDs).

The MTCA is calculated by Lido and covers terrain and obstacle clearance relevant for air navigation with the following buffers:

(i) Horizontal:

- (A) for SID and STAR procedures 5 NM either side of centre line; and
- (B) for airways/ATS routes 10 NM either side of centre line.

(ii) Vertical:

- (A) 1 000 ft up to 6 000 ft; and
- (B) 2 000 ft above 6 000 ft.

MTCA is always shown in feet. The lowest indicated MTCA is 3 100 ft.

(2) Minimum grid altitude (MGA)

MGA represents the lowest safe altitude which can be flown off-track. The MGA is calculated by rounding up the elevation of the highest obstruction within the respective grid area to the next 100 ft and adding an increment of

- (i) 1 000 ft for terrain or obstructions up to 6 000 ft; and
- (ii) 2 000 ft for terrain or obstructions above 6 000 ft.

MGA is shown in hundreds of feet. The lowest indicated MGA is 2 000 ft. This value is also provided for terrain and obstacles that would result in an MGA below 2 000 ft. An exception is over water areas where the MGA can be omitted.

CAT.OP.MPA.150

Regulation (EU) 2021/1296

INTENTIONALLY LEFT BLANK

CAT.OP.MPA.155 Carriage of special categories of passengers (SCPs)

Regulation (EU) No 965/2012

(a) Persons requiring special conditions, assistance and/or devices when carried on a flight shall be considered as SCPs including at least:

- (1) persons with reduced mobility (PRMs) who, without prejudice to Regulation (EC) No 1107/2006, are understood to be any person whose mobility is reduced due to any physical disability, sensory or locomotory, permanent or temporary, intellectual disability or impairment, any other cause of disability, or age;
- (2) infants and unaccompanied children; and
- (3) deportees, inadmissible passengers or prisoners in custody.

(b) SCPs shall be carried under conditions that ensure the safety of the aircraft and its occupants according to procedures established by the operator.

- (c) SCPs shall not be allocated, nor occupy, seats that permit direct access to emergency exits or where their presence could:
 - (1) impede crew members in their duties;
 - (2) obstruct access to emergency equipment; or
 - (3) impede the emergency evacuation of the aircraft.
- (d) The commander shall be notified in advance when SCPs are to be carried on board.

AMC1 CAT.OP.MPA.155(b) Carriage of special categories of passengers (SCPs)

ED Decision 2016/004/R

PROCEDURES

When establishing the procedures for the carriage of SCPs, the operator should take into account the following factors:

- (a) the aircraft type and cabin configuration;
- (b) the total number of passengers carried on board;
- (c) the number and categories of SCPs, which should not exceed the number of passengers capable of assisting them in case of an emergency; and
- (d) any other factor(s) or circumstances possibly impacting on the application of emergency procedures by the operating crew members.

AMC2 CAT.OP.MPA.155(b) Carriage of Special Categories of Passengers (SCPs)

ED Decision 2016/004/R

PROCEDURES TO PROVIDE INFORMATION TO SCP

The operator procedures on information provided to the SCP should specify the timing and methods on how and when the information can be provided.

AMC3 CAT.OP.MPA.155(b) Carriage of Special Categories of Passengers (SCPs)

ED Decision 2016/004/R

CONDITIONS OF SAFE CARRIAGE FOR UNACCOMPANIED CHILDREN

- (a) When carrying an unaccompanied child that is not self-reliant, the operator should assess the safety risks to ensure that the child is assisted in case of an emergency situation.
- (b) A child under the age of 12 years, separated from the accompanying adult, who is travelling in another cabin class, should be considered as an unaccompanied child in order to ensure that the child is assisted in case of an emergency situation.

GM1 CAT.OP.MPA.155(b) Carriage of Special Categories of Passengers (SCPs)

ED Decision 2016/004/R

PROCEDURES TO PROVIDE INFORMATION TO SCP

Providing information only at the time of booking might not be sufficient to ensure that the SCP is aware of the information at the time of the flight.

GM2 CAT.OP.MPA.155(b) Carriage of special categories of passengers (SCPs)

ED Decision 2019/019/R

INFORMATION PROVIDED TO SCPS

When establishing procedures on the information to be provided to an SCP, the operator should consider informing the SCP that cabin crew can only assist the SCP once the cabin has been evacuated. The following table contains additional information by SCP category:

SCP category	Type of information
Unaccompanied child	Inform the unaccompanied child on the following: <ul style="list-style-type: none"> (a) which adult will assist with the operation of the seat belt and the fitting of the oxygen mask if the situation requires it; (b) the content of the passenger safety briefing card; and (c) in case of evacuation, to seek the assistance of adult passenger(s) in contacting a crew member. Inform the passenger sitting next to the unaccompanied child to assist with: <ul style="list-style-type: none"> (a) providing the child with an oxygen mask in case of decompression after fitting one's own mask; (b) securing/releasing the child's seat belt, if necessary; and (c) calling a cabin crew member in all other in-flight situations. When a child and the accompanying adult travel in a different class of cabin, information should be provided to the child and adult that, in the event of an emergency, they should follow the instructions of the cabin crew and not try to reunite inside the cabin as this would slow down the overall evacuation.
Adult travelling with an infant	Information on brace position for adult with lap-held infant. Information on the use of the loop belt, in case of a lap-held infant. Information to fit own oxygen mask before fitting the infant's oxygen mask. Information on how to evacuate when carrying an infant: <ul style="list-style-type: none"> (a) On land, see EASA SIB 2013-06 on evacuation of infants on aircraft equipped with inflatable slides or hatch-type overwing exits; and (b) In case of ditching, how to fit and when to inflate infant flotation aid (e.g. life jacket, flotation device).
Physically disabled passenger (aided walking)	Inform the SCP to leave mobility aid behind in an emergency evacuation.
Passenger with disability of upper limbs	Inform the accompanying passenger to: <ul style="list-style-type: none"> (a) fit the life jacket on the SCP, in case of a ditching evacuation; (b) first put on their own oxygen mask before fitting the SCP's oxygen mask, in case of decompression; and (c) secure/release the SCP's seat belt, if necessary.
Passenger with disability of lower limbs	Inform the SCP: <ul style="list-style-type: none"> (a) on the location of the nearest suitable exit; and (b) that mobility aids might not be accessible in an emergency evacuation.

Passenger with disability of both upper and lower limbs	<p>Inform accompanying passenger to secure/release the SCP's seat belt.</p> <p>Inform the SCP:</p> <ul style="list-style-type: none"> (a) in case of an evacuation, on the location of the nearest suitable exit; (b) in case of a ditching evacuation, that the accompanying passenger should fit the life jacket on the SCP; and (c) in case of a decompression, that the accompanying passenger should first put on his/her own oxygen mask before fitting the SCP's oxygen mask.
Visually impaired passenger	<p>Depending on the level of impairment, inform the visually impaired passenger on the following:</p> <ul style="list-style-type: none"> (a) seat and seat belt operation; (b) location of the nearest exit (e.g. number of seat rows to the nearest exit); (c) oxygen mask deployment; (d) location of life jacket; (e) brace position; and (f) location of cabin crew call button. <p>If available, take the aircraft demonstration equipment to the passenger for tactile assistance.</p>
Passenger travelling with a recognised assistance dog in the cabin	<p>Advise how to evacuate guide dog by holding the dog and sliding.</p>
Stretcher occupant	<p>Inform the stretcher occupant and the accompanying passenger that in case of an evacuation:</p> <ul style="list-style-type: none"> (a) the stretcher occupant should be evacuated when the cabin area surrounding the stretcher is clear; (b) to evacuate the stretcher occupant without the stretcher, if possible; (c) to be seated when sliding, holding the stretcher occupant in front; and (d) in the event of a ditching evacuation, to fit the life jacket on the stretcher occupant.

GM3 CAT.OP.MPA.155(b) Carriage of Special Categories of Passengers (SCPs)

ED Decision 2016/004/R

PROCEDURES

A passenger capable of assisting in case of an emergency means a passenger who is not an SCP and has no other role or private responsibility that would prevent him/her from assisting the SCP. For example, an adult travelling alone has no other role or private responsibility, unlike a family travelling together with younger children.

GM4 CAT.OP.MPA.155(b) Carriage of Special Categories of Passengers (SCPs)

ED Decision 2016/004/R

BRIEFING PROCEDURE IN A PLANNED EMERGENCY

In a planned emergency, if time permits, passengers identified by the cabin crew as capable of assisting an SCP should be briefed on the assistance they can provide.

AMC1 CAT.OP.MPA.155(c) Carriage of Special Categories of Passengers (SCPs)

ED Decision 2016/004/R

SEATING PROCEDURES

When establishing SCP seating procedures, the operator should take into account the following factors:

- (a) If the SCP travels with an accompanying passenger, the accompanying passenger should be seated next to the SCP.
- (b) If the SCP is unable to negotiate stairs within the cabin unaided, he/she should not be seated on the upper deck of a multi-deck aircraft if the exits are not certified for emergency evacuation on both land and water.

AMC2 CAT.OP.MPA.155(c) Carriage of Special Categories of Passengers (SCPs)

ED Decision 2016/004/R

SEATING ALLOCATION OF SCP WITH A DISABILITY AND/OR RESTRAINT AID

- (a) A disability and/or restraint aid that requires to be secured around the back of the seat should not be used if there is a person seated behind unless the seating configuration is approved for the use of such devices. This is to avoid the changed dynamic seat reactions with the disability and/or restraint aid, which may lead to head injury of the passenger seated behind.
- (b) If the seat design or installation would prevent head contact of the person seated behind, then no further consideration is necessary.

GM1 CAT.OP.MPA.155(c) Carriage of Special categories of Passengers (SCPs)

ED Decision 2016/004/R

GROUP SEATING

- (a) Taking into account access to exits, groups of non-ambulatory SCPs should be seated throughout the cabin to ensure that each SCP is surrounded by the maximum number of passengers capable of assisting in case of an emergency.
- (b) If non-ambulatory SCPs cannot be evenly distributed throughout the cabin, the operator should establish procedures to mitigate the increased safety risk such as seating of passengers capable of assisting in case of an emergency in the vicinity, additional information or training of cabin crew.
- (c) A group of passengers whose physical size would possibly prevent them from moving quickly or reaching and passing through an emergency exit, should not occupy the same seat row segment to avoid overloading the structure of the seat.

GM2 CAT.OP.MPA.155(c) Carriage of Special Categories of Passengers (SCPs)

ED Decision 2016/004/R

SEATING ALLOCATION

When establishing the procedure on seating of an SCP, seats should be allocated taking into account the following:

SCP category	Seating allocation procedure
Unaccompanied child	The seating allocation of an unaccompanied child should allow for visual or audible communication during all phases of the flight with cabin crew. Groups of unaccompanied children should be seated in mix of ages, with the tallest child seated to allow assistance with fitting drop-down oxygen mask to smaller children in case of a decompression. Where possible, one adult should occupy the seat across the aisle next to each row of unaccompanied children.
Passenger travelling with a child of less than 12 years of age	If a child travels with an accompanying adult in the same class of cabin, the child should be seated in the same seat row segment as the accompanying adult. Where this is not possible, the child should be seated no more than one seat row or aisle away.
Passenger whose physical size would possibly prevent him/her from passing through an emergency exit	A passenger whose physical size would possibly prevent him/her from passing through an emergency exit (e.g. Type III or Type IV exit), should be seated in the vicinity of a suitable exit, taking into account the size of the exit. Seating of more than one of such passengers in the same seat row segment should be avoided.
Passenger with physical disability of the upper limbs	A passenger with a physical disability of the upper limbs travelling without an accompanying passenger should be allocated seats during all phases of the flight so that visual and audible communication can be established with the cabin crew.
Passenger with disability of lower limbs	A passenger with a disability of the lower limbs should be seated in a location providing easy access to floor level exits.
Passenger with disability of both upper and lower limbs	A passenger with a disability of both upper and lower limbs should be seated in a location providing easy access to floor level exits.
Mentally impaired passenger	A mentally impaired passenger, who travels without an accompanying passenger, should be allocated seats during all phases of the flight so that visual and audible communication can be established with the cabin crew.
Passenger travelling with recognised assistance dog in the cabin	Suitable arrangements should be made between the passenger and the operator in advance of a flight where a recognised assistance dog is to be accommodated. A suitable restraint harness should be provided by the owner to secure and restrain the dog during taxi, take-off, landing and turbulence. In cruise, it is acceptable for the dog to be subject to less restraint.
Stretcher occupant	Where possible, the stretcher should be installed behind a cabin monument. Alternatively, the stretcher could be installed where it can demonstrate compliance with the appropriate certification basis (CS.25.561 and CS.25.562(b), (c)(7), (8)). Stretcher installation should be as close to the floor level non-overwing exits as practical; preferably close to a required cabin crew station with an adjacent seat for the designated accompanying passenger.

CAT.OP.MPA.160 Stowage of baggage and cargo

Regulation (EU) No 965/2012

The operator shall establish procedures to ensure that:

- (a) only hand baggage that can be adequately and securely stowed is taken into the passenger compartment; and
- (b) all baggage and cargo on board that might cause injury or damage, or obstruct aisles and exits if displaced, is stowed so as to prevent movement.

AMC1 CAT.OP.MPA.160 Stowage of baggage and cargo

ED Decision 2014/015/R

STOWAGE PROCEDURES

Procedures established by the operator to ensure that hand baggage and cargo are adequately and securely stowed should take account of the following:

- (a) each item carried in a cabin should be stowed only in a location that is capable of restraining it;
- (b) weight limitations placarded on or adjacent to stowages should not be exceeded;
- (c) under seat stowages should not be used unless the seat is equipped with a restraint bar and the baggage is of such size that it may adequately be restrained by this equipment;
- (d) items should not be stowed in lavatories or against bulkheads that are incapable of restraining articles against movement forwards, sideways or upwards and unless the bulkheads carry a placard specifying the greatest mass that may be placed there;
- (e) baggage and cargo placed in lockers should not be of such size that they prevent latched doors from being closed securely;
- (f) baggage and cargo should not be placed where it can impede access to emergency equipment; and
- (g) checks should be made before take-off, before landing and whenever the 'fasten seat belts' signs are illuminated or it is otherwise so ordered to ensure that baggage is stowed where it cannot impede evacuation from the aircraft or cause injury by falling (or other movement), as may be appropriate to the phase of flight.

AMC2 CAT.OP.MPA.160 Stowage of baggage and cargo

ED Decision 2014/015/R

CARRIAGE OF CARGO IN THE PASSENGER COMPARTMENT

The following should be observed before carrying cargo in the passenger compartment:

- (a) for aeroplanes:
 - (1) dangerous goods should not be allowed; and
 - (2) a mix of passengers and live animals should only be allowed for pets weighing not more than 8 kg and guide dogs;
- (b) for aeroplanes and helicopters:
 - (1) the mass of cargo should not exceed the structural loading limits of the floor or seats;

- (2) the number/type of restraint devices and their attachment points should be capable of restraining the cargo in accordance with applicable Certification Specifications; and
- (3) the location of the cargo should be such that, in the event of an emergency evacuation, it will not hinder egress nor impair the crew's view.

CAT.OP.MPA.165 Passenger seating

Regulation (EU) No 965/2012

The operator shall establish procedures to ensure that passengers are seated where, in the event that an emergency evacuation is required, they are able to assist and not hinder evacuation of the aircraft.

AMC1 CAT.OP.MPA.165 Passenger seating

ED Decision 2017/008/R

EMERGENCY EXIT SEATING

The operator should make provisions so that:

- (a) a passenger occupies a seat at least on each side in a seat row with direct access to an emergency exit (not staffed by a cabin crew member) during taxiing, take-off and landing unless this would be impracticable due to a low number of passengers or might negatively impact the mass and balance limitations.
- (b) those passengers who are allocated seats that permit direct access to emergency exits appear to be reasonably fit, strong, and be able and willing to assist the rapid evacuation of the aircraft in an emergency after an appropriate briefing by the crew;
- (c) in all cases, passengers who, because of their condition, might hinder other passengers during an evacuation or who might impede the crew in carrying out their duties, should not be allocated seats that permit direct access to emergency exits. If procedures cannot be reasonably implemented at the time of passenger 'check-in', the operator should establish an alternative procedure which ensures that the correct seat allocations will, in due course, be made.

AMC2 CAT.OP.MPA.165 Passenger seating

ED Decision 2014/015/R

ACCESS TO EMERGENCY EXITS

The following categories of passengers are among those who should not be allocated to, or directed to, seats that permit direct access to emergency exits:

- (a) passengers suffering from obvious physical or mental disability to the extent that they would have difficulty in moving quickly if asked to do so;
- (b) passengers who are either substantially blind or substantially deaf to the extent that they might not readily assimilate printed or verbal instructions given;
- (c) passengers who because of age or sickness are so frail that they have difficulty in moving quickly;
- (d) passengers who are so obese that they would have difficulty in moving quickly or reaching and passing through the adjacent emergency exit;
- (e) children (whether accompanied or not) and infants;
- (f) deportees, inadmissible passengers or persons in custody; and

- (g) passengers with animals.

GM1 CAT.OP.MPA.165 Passenger seating

ED Decision 2014/015/R

DIRECT ACCESS

‘Direct access’ means a seat from which a passenger can proceed directly to the exit without entering an aisle or passing around an obstruction.

GM2 CAT.OP.MPA.165 Passenger seating

ED Decision 2017/008/R

EMERGENCY EXIT SEATING

When allocating a seat in a seat row with direct access to an emergency exit, the operator should consider at least the following:

- (a) providing the passenger with the applicable emergency exit seating restrictions prior to boarding, or upon assigning a passenger to a seat, e.g. at the stage of booking, or check-in, or at the airport;
- (b) utilising, as far as practicable, cabin crew members that are additional to the minimum required cabin crew complement, or positioning crew members, if available on board.

CAT.OP.MPA.170 Passenger briefing

Regulation (EU) 2019/1384

The operator shall ensure that passengers are:

- (a) given briefings and demonstrations relating to safety in a form that facilitates the application of the procedures applicable in the event of an emergency; and
- (b) provided with a safety briefing card on which picture-type instructions indicate the operation of safety and emergency equipment and emergency exits likely to be used by passengers.

AMC1 CAT.OP.MPA.170 Passenger briefing

ED Decision 2019/019/R

PASSENGER BRIEFING

Passenger briefings should contain the following:

- (a) Before take-off
 - (1) Passengers should be briefed on the following items, if applicable:
 - (i) any cabin secured aspects, e.g. required position of seatbacks, tray tables, footrests, window blinds, etc. as applicable;
 - (ii) emergency lighting (floor proximity escape path markings, exit signs);
 - (iii) correct stowage of hand baggage and the importance of leaving hand baggage behind in case of evacuation;
 - (iv) the use and stowage of portable electronic devices, including in-flight entertainment (IFE) systems;

-
- (v) the location and presentation of the safety briefing card, the importance of its contents and the need for passengers to review it prior to take-off; and
 - (vi) compliance with ordinance signs, pictograms or placards, and crew member instructions; and
 - (2) Passengers should receive a demonstration of the following:
 - (i) the use of safety belts or restraint systems, including how to fasten and unfasten the safety belts or restraint systems;
 - (ii) the location of emergency exits;
 - (iii) the location and use of oxygen equipment, if required. Passengers should also be briefed to extinguish all smoking materials when oxygen is being used; and
 - (iv) the location and use of life-jackets if required.
 - (3) Passengers occupying seats with direct access to emergency exits not staffed by cabin crew members should receive an additional briefing on the operation and use of the exit.
- (b) After take-off
- (1) Passengers should be reminded of the following, if applicable:
 - (i) use of safety belts or restraint systems including the safety benefits of having safety belts fastened when seated irrespective of seat belt sign illumination; and
 - (ii) caution when opening overhead compartments.
- (c) Before landing
- (1) Passengers should be reminded of the following, if applicable:
 - (i) use of safety belts or restraint systems;
 - (ii) any cabin secured aspects, e.g. required position of seatbacks, tray tables, footrests, window blinds, etc. as applicable;
 - (iii) correct stowage of hand baggage and the importance of leaving hand baggage behind in case of evacuation;
 - (iv) the use and stowage of portable electronic devices; and
 - (v) the location of the safety briefing card, the importance of its contents and its review.
- (d) After landing
- (1) Passengers should be reminded of the following:
 - (i) use of safety belts or restraint systems;
 - (ii) the use and stowage of portable electronic devices; and
 - (iii) caution when opening overhead compartments.
- (e) Emergency during flight:
- (1) Passengers should be instructed as appropriate to the circumstances.
- (f) Smoking regulations
- (1) The operator should determine the frequency of briefings or reminding passengers about the smoking regulations.

AMC1.1 CAT.OP.MPA.170 Passenger briefing

ED Decision 2014/015/R

PASSENGER BRIEFING

- (a) The operator may replace the briefing/demonstration as set out in AMC1 CAT.OP.MPA.170 with a passenger training programme covering all safety and emergency procedures for a given type of aircraft.
- (b) Only passengers who have been trained according to this programme and have flown on the aircraft type within the last 90 days may be carried on board without receiving a briefing/demonstration.

AMC2 CAT.OP.MPA.170 Passenger briefing

ED Decision 2014/015/R

SINGLE-PILOT OPERATIONS WITHOUT CABIN CREW

For single-pilot operations without cabin crew, the commander should provide safety briefings to passengers except during critical phases of flight and taxiing.

AMC3 CAT.OP.MPA.170 Passenger briefing

ED Decision 2019/019/R

IN-FLIGHT ENTERTAINMENT (IFE) SYSTEMS

When IFE systems are available by means of equipment that can be handled by passengers, including portable electronic devices (PEDs), provided by the operator for the purpose of IFE, appropriate information containing at least the following should be made available to passengers:

- (a) instructions on how to safely operate the IFE system for personal use in normal conditions;
- (b) restrictions, including stowage of retractable or loose items of equipment (e.g. screens or remote controls) during taxiing, take-off and landing, and in abnormal or emergency conditions; and
- (c) the instruction to alert cabin crew members in case of IFE system malfunction in accordance with point (f)(9) of [GM2 CAT.OP.MPA.170](#).

GM1 CAT.OP.MPA.170(a) Passenger briefing

ED Decision 2017/008/R

BRIEFING OF PASSENGERS OCCUPYING SEATS WITH DIRECT ACCESS TO EMERGENCY EXITS NOT STAFFED BY CABIN CREW MEMBERS

- (a) The emergency exit briefing should contain instructions on the operation of the exit, assessment of surrounding conditions for the safe use of the exit, and recognition of emergency commands given by the crew.
- (b) Cabin crew should verify that the passenger(s) is (are) able and willing to assist the crew in case of an emergency and that the passenger(s) has (have) understood the instructions.

GM2 CAT.OP.MPA.170 Passenger briefing

ED Decision 2017/008/R

SAFETY BRIEFING MATERIAL

- (a) Safety briefing material may include but is not limited to an audio-visual presentation, such as a safety video or a safety briefing card. Information in the safety briefing material should be relevant to the aircraft type and the installed equipment and should be consistent with the operator's procedures. Information in the safety briefing material should be presented in a clear and unambiguous manner and in a form easily understandable to passengers.
- (b) For those passengers occupying seats with direct access to emergency exits, the operator should consider providing a separate briefing card, which contains a summary of the exit briefing information.
- (c) The safety briefing card should be designed, and the information should be provided, in a size easily visible to the passenger. The safety briefing card should be stowed in a location from where it is easily visible and reachable to the seated passenger and from where it cannot easily fall out. Information should be presented in a pictographic form and should be consistent with the placards used in the aircraft. Written information should be kept to the necessary minimum. The safety briefing card should only contain information relevant to safety.
- (d) The operator conducting an operation with no cabin crew should consider including expanded information, such as location and use of fire extinguisher, oxygen system if different from the drop-down system, etc.
- (e) The safety video should be structured in a pace that allows a continuous ability to follow the information presented. The operator may consider including sign language or subtitles to simultaneously complement the soundtrack.
- (f) The operator should consider including the following information in its safety briefing material:
 - (1) hand baggage:
 - (i) correct versus forbidden stowage locations (e.g. exits, aisles, etc.);
 - (2) safety belts and other restraint systems:
 - (i) when and how to use safety belts and other restraint systems;
 - (ii) restraint of infants and children;
 - (iii) additional installed systems, e.g. airbag;
 - (3) drop-down oxygen system:
 - (i) location;
 - (ii) activation;
 - (iii) indication of active oxygen supply;
 - (iv) correct and timely donning of oxygen mask;
 - (v) assisting others;
 - (4) flotation devices:
 - (i) stowage locations (including if different in various cabin sections);
 - (ii) use for adult, child and infant;
 - (iii) features, e.g. straps, toggles, tubes, signalling light, whistle;

- (iv) when and where to inflate a life jacket;
- (v) flotation devices for infants;
- (5) emergency exits:
 - (i) number and location;
 - (ii) method of operation, including alternative operation in case of ditching;
 - (iii) surrounding conditions prior to opening (e.g. fire, smoke, water level, etc.);
 - (iv) unusable exit;
 - (v) alternative egress routes in case of unusable exit(s);
 - (vi) leaving hand baggage behind;
 - (vii) method of egress through exit including with infants and children;
 - (viii) awareness of exit height;
 - (ix) awareness of propellers;
- (6) escape routes: depiction of routes:
 - (i) to the exits (inside the aircraft);
 - (ii) movement on a double-deck aircraft;
 - (iii) via the wing to the ground;
 - (iv) on the ground away from the aircraft;
- (7) assisting evacuation means:
 - (i) location of available equipment (e.g. life raft, installed slide/raft, etc.);
 - (ii) awareness of the evacuation equipment's features;
 - (iii) operation of the available equipment (activation, detachment, etc.);
 - (iv) method of boarding the device including with infants and children;
 - (v) use of shoes;
 - (vi) method of evacuation through exits with no assisting evacuation means;
- (8) brace position:
 - (i) appropriate method to the applicable facing direction;
 - (ii) alternative brace positions for e.g. expectant mothers, passengers with lap-held infants, tall or large individuals, children, etc.;
- (9) portable electronic devices, including spare batteries:
 - (i) allowed versus forbidden devices;
 - (ii) use in various flight phases including during safety briefing;
 - (iii) stowage;
 - (iv) danger of fire in case the device is damaged;
 - (v) the need to call for immediate assistance in case a device is damaged, hot, produces smoke, is lost, or falls into the seat structure (including advice to refrain from manipulating the seat);

- (vi) the need to monitor devices during charging;
- (10) cabin secured aspects:
 - (i) required position of seatbacks, headrests, tray tables, footrests, window blinds, in-seat video screens and their control gadgets, etc.;
 - (ii) caution when opening overhead compartments;
- (11) smoking regulations (e.g. phase of flight, electronic smoking devices, pipes, etc.) including smoking in the lavatory;
- (12) floor proximity escape path marking:
 - (i) location;
 - (ii) purpose in case of darkness or smoke;
- (13) actions in case of an emergency (e.g. remove sharp objects, fasten seat belt, open window blind, etc.);
- (14) any other safety aspects.

CAT.OP.MPA.175 Flight preparation

Regulation (EU) 2021/1296

- (a) An operational flight plan shall be completed for each intended flight based on considerations of aircraft performance, other operating limitations and relevant expected conditions on the route to be followed and at the aerodromes/operating sites concerned.
- (b) The flight shall not be commenced unless the commander is satisfied that:
 - (1) all items stipulated in 2.a.3 of Annex IV to Regulation (EC) No 216/2008 concerning the airworthiness and registration of the aircraft, instrument and equipment, mass and centre of gravity (CG) location, baggage and cargo and aircraft operating limitations can be complied with;
 - (2) the aircraft is not operated contrary to the provisions of the configuration deviation list (CDL);
 - (3) the parts of the operations manual that are required for the conduct of the flight are available;
 - (4) the documents, additional information and forms required to be available by [CAT.GEN.MPA.180](#) are on board;
 - (5) current maps, charts and associated documentation or equivalent data are available to cover the intended operation of the aircraft including any diversion that may reasonably be expected;
 - (6) space-based facilities, ground facilities and services that are required for the planned flight are available and adequate;
 - (7) the provisions specified in the operations manual in respect of fuel/energy, oil, oxygen, minimum safe altitudes, aerodrome operating minima and availability of alternate aerodromes, where required, can be complied with for the planned flight;
 - (7a) any navigational database required for performance-based navigation is suitable and current; and
 - (8) any additional operational limitation can be complied with.

- (c) Notwithstanding (a), an operational flight plan is not required for operations under VFR of:
- (1) other-than complex motor-powered aeroplane taking off and landing at the same aerodrome or operating site; or
 - (2) helicopters with an MCTOM of 3 175 kg or less, by day and over routes navigated by reference to visual landmarks in a local area as specified in the operations manual.

AMC1 CAT.OP.MPA.175 Flight preparation

ED Decision 2016/015/R

FLIGHT PREPARATION FOR PBN OPERATIONS

- (a) The flight crew should ensure that RNAV 1, RNAV 2, RNP 1 RNP 2, and RNP APCH routes or procedures to be used for the intended flight, including for any alternate aerodromes, are selectable from the navigation database and are not prohibited by NOTAM.
- (b) The flight crew should take account of any NOTAMs or operator briefing material that could adversely affect the aircraft system operation along its flight plan including any alternate aerodromes.
- (c) When PBN relies on GNSS systems for which RAIM is required for integrity, its availability should be verified during the preflight planning. In the event of a predicted continuous loss of fault detection of more than five minutes, the flight planning should be revised to reflect the lack of full PBN capability for that period.
- (d) For RNP 4 operations with only GNSS sensors, a fault detection and exclusion (FDE) check should be performed. The maximum allowable time for which FDE capability is projected to be unavailable on any one event is 25 minutes. If predictions indicate that the maximum allowable FDE outage will be exceeded, the operation should be rescheduled to a time when FDE is available.
- (e) For RNAV 10 operations, the flight crew should take account of the RNAV 10 time limit declared for the inertial system, if applicable, considering also the effect of weather conditions that could affect flight duration in RNAV 10 airspace. Where an extension to the time limit is permitted, the flight crew will need to ensure that en route radio facilities are serviceable before departure, and to apply radio updates in accordance with any AFM limitation.

AMC2 CAT.OP.MPA.175 Flight preparation

ED Decision 2016/015/R

DATABASE SUITABILITY

- (a) The flight crew should check that any navigational database required for PBN operations includes the routes and procedures required for the flight.

DATABASE CURRENCY

- (b) The database validity (current AIRAC cycle) should be checked before the flight.
- (c) Navigation databases should be current for the duration of the flight. If the AIRAC cycle is due to change during flight, the flight crew should follow procedures established by the operator to ensure the accuracy of navigation data, including the suitability of navigation facilities used to define the routes and procedures for the flight.

- (d) An expired database may only be used if the following conditions are satisfied:
- (1) the operator has confirmed that the parts of the database which are intended to be used during the flight and any contingencies that are reasonable to expect are not changed in the current version;
 - (2) any NOTAMs associated with the navigational data are taken into account;
 - (3) maps and charts corresponding to those parts of the flight are current and have not been amended since the last cycle;
 - (4) any MEL limitations are observed; and
 - (5) the database has expired by no more than 28 days.

AMC1 CAT.OP.MPA.175(a) Flight preparation

ED Decision 2022/005/R

OPERATIONAL FLIGHT PLAN — COMPLEX MOTOR-POWERED AIRCRAFT

- (a) The operational flight plan used and the entries made during flight should contain the following items:
- (1) aircraft registration;
 - (2) aircraft type and variant;
 - (3) date of flight;
 - (4) flight identification;
 - (5) names of flight crew members;
 - (6) duty assignment of flight crew members;
 - (7) place of departure;
 - (8) time of departure (actual off-block time, take-off time);
 - (9) place of arrival (planned and actual);
 - (10) time of arrival (actual landing and on-block time);
 - (11) type of operation (ETOPS, VFR, ferry flight, etc.);
 - (12) route and route segments with checkpoints/waypoints, distances, time and tracks;
 - (13) planned cruising speed and flying times between check-points/waypoints (estimated, revised, and actual times overhead);
 - (14) safe altitudes and minimum levels;
 - (15) planned altitudes and flight levels;
 - (16) fuel calculations (records of in-flight fuel checks);
 - (17) fuel on board when starting engines;
 - (18) alternate(s) for destination, including the information required in (a)(12) to (15), as well as destination 2 and destination 2 alternate aerodromes in case of a reduced contingency fuel (RCF) procedure;
 - (19) where applicable, a take-off alternate and fuel ERA aerodrome(s);
 - (20) initial ATS flight plan clearance and subsequent reclearance;

- (21) in-flight replanning calculations; and
- (22) meteorological information, as specified in point (a) of point MET.TR.215 of Part-MET.
- (b) Items that are readily available in other documentation or from another acceptable source or are irrelevant to the type of operation may be omitted from the operational flight plan.
- (c) The operational flight plan and its use should be described in the operations manual.
- (d) All entries on the operational flight plan should be made concurrently and be permanent in nature.

OPERATIONAL FLIGHT PLAN — OTHER-THAN-COMPLEX MOTOR-POWERED AIRCRAFT OPERATIONS AND LOCAL OPERATIONS

- (e) An operational flight plan may be established in a simplified form relevant to the type of operation for operations with other-than-complex motor-powered aircraft as well as local operations with any aircraft. Local operations should be defined in the OM.

OPERATIONAL FLIGHT PLAN — HELICOPTERS OPERATED WITH A SINGLE PILOT AND WITHOUT A STABILITY AUGMENTATION SYSTEM OR AN AUTOMATIC FLIGHT CONTROL SYSTEM (AFCS)

- (f) No entries should be made in the operational flight plan during the flight.

OPERATIONAL FLIGHT PLAN PRODUCED BY A COMPUTERISED FLIGHT-PLANNING SYSTEM

- (g) When the operator uses a computerised flight-planning system to produce an operational flight plan, the functionality of this system should be described in the OM.
- (h) If the computerised flight-planning system is used in conjunction with a basic fuel scheme with variations or an individual fuel scheme, the operator should ensure that the quality and the proper functionality of the software are tested after each upgrade. The test should verify that the changes to the software do not affect the final output.

GM1 CAT.OP.MPA.175(b)(5) Flight preparation*ED Decision 2014/015/R***CONVERSION TABLES**

The documentation should include any conversion tables necessary to support operations where metric heights, altitudes and flight levels are used.

CAT.OP.MPA.177 Submission of the ATS flight plan*Regulation (EU) 2021/1296*

- (a) If an air traffic services (ATS) flight plan is not submitted because it is not required by the rules of the air, adequate information shall be deposited in order to permit alerting services to be activated if required.
- (b) When operating from a site where it is impossible to submit an ATS flight plan, the ATS flight plan shall be transmitted as soon as possible after take-off by the commander or the operator.

AMC1 CAT.OP.MPA.177 Submission of the ATS flight plan

ED Decision 2022/005/R

FLIGHTS WITHOUT AN ATS FLIGHT PLAN

- (a) When unable to submit or close the ATS flight plan due to lack of ATS facilities or of any other means of communications to ATS, the operator should establish procedures, instructions, and a list of nominated persons to be responsible for alerting search and rescue (SAR) services.
- (b) To ensure that each flight is located at all times, these instructions should:
 - (1) provide the nominated person with at least the information required to be included in a VFR flight plan, and the location, date, and estimated time for re-establishing communications;
 - (2) if an aircraft is overdue or missing, ensure that the appropriate ATS or SAR service is notified; and
 - (3) ensure that the information will be retained at a designated place until the completion of the flight.

CAT.OP.MPA.180 Fuel/energy scheme – aeroplanes

Regulation (EU) 2021/1296

- (a) The operator shall establish, implement, and maintain a fuel/energy scheme that:
 - (1) is appropriate for the type(s) of operation performed;
 - (2) corresponds to the capability of the operator to support its implementation; and
 - (3) is either:
 - (i) a basic fuel/energy scheme, which shall form the basis for a basic fuel/energy scheme with variations and an individual fuel/energy scheme; the basic fuel/energy scheme derives from a large-scale analysis of safety and operational data from previous performance and experience of the industry, applying scientific principles; the basic fuel/energy scheme shall ensure, in this order, a safe, effective, and efficient operation of the aircraft; or
 - (ii) a basic fuel/energy scheme with variations, which is a basic fuel/energy scheme where the analysis referred to in point (i) is used to establish a variation to the basic fuel/energy scheme that ensures, in this order, a safe, effective, and efficient operation of the aircraft; or
 - (iii) an individual fuel/energy scheme, which derives from a comparative analysis of the operator's safety and operational data, applying scientific principles; the analysis is used to establish a fuel/energy scheme with a higher or equivalent level of safety to that of the basic fuel/energy scheme that ensures, in this order, a safe, effective, and efficient operation of the aircraft.
- (b) All fuel/energy schemes shall comprise:
 - (1) a fuel/energy planning and in-flight re-planning policy;
 - (2) an aerodrome selection policy; and
 - (3) an in-flight fuel/energy management policy.
- (c) The fuel/energy scheme and any change to it shall require prior approval by the competent authority.

- (d) When the operator intends to apply for an individual fuel/energy scheme, it shall:
- (1) establish a baseline safety performance of its current fuel/energy scheme;
 - (2) demonstrate its capability to support the implementation of the proposed individual fuel/energy scheme, including the capability to exercise adequate operational control and to ensure exchange of the relevant safety information between the operational control personnel and the flight crew; and
 - (3) make a safety risk assessment that demonstrates how an equivalent level of safety to that of the current fuel/energy scheme is achieved.

AMC1 CAT.OP.MPA.180 Fuel/energy scheme — aeroplanes

ED Decision 2022/005/R

INDIVIDUAL FUEL SCHEME

- (a) Prior to submitting an individual fuel scheme for approval, the operator should perform all the following actions to establish a baseline safety performance:
- (1) measure the baseline safety performance of its operation with the current fuel scheme by:
 - (i) selecting safety performance indicators (SPIs) and targets that are agreed with the competent authority; and
 - (ii) collecting statistically relevant data for a period of at least 2 years of continuous operation (note: the number of flights should be sufficient to provide data to support the intended deviation);
 - (2) identify the hazards associated with the individual fuel scheme and carry out a safety risk assessment of these hazards; and
 - (3) based on this safety risk assessment, establish a mechanism for risk monitoring and risk control to ensure an equivalent level of safety to that of the current fuel scheme.
- (b) In order to ensure the approval of the competent authority and its continuous oversight, the operator should establish an effective continuous reporting system to the competent authority on the safety performance and regulatory compliance of the individual fuel scheme.
- (c) When determining the extent of the deviation from the current fuel scheme, the operator should take into account at least the following elements for the relevant area of operation:
- (1) the available aerodrome technologies, capabilities, and infrastructure;
 - (2) the reliability of meteorological and aerodrome information;
 - (3) the reliability of the aeroplane systems, especially the time-limited ones; and
 - (4) the type of ATS provided and, where applicable, characteristics and procedures of the air traffic flow management and of the airspace management.
- (d) An operator wishing to apply for the approval of an individual fuel scheme should be able to demonstrate that it exercises sufficient organisational control over internal processes and the use of resources. The operator should adapt its management system to ensure that:
- (1) processes and procedures are established to support the individual fuel scheme;
 - (2) involved flight crew and personnel are trained and competent to perform their tasks; and

- (3) the implementation and effectiveness of such processes, procedures, and training are monitored.
- (e) The operator should have as a minimum the following operational capabilities that support the implementation of an individual fuel scheme:
 - (1) use a suitable computerised flight-planning system;
 - (2) ensure that the planning of flights is based upon current aircraft-specific data that is derived from a fuel consumption monitoring system and reliable meteorological data;
 - (3) have airborne fuel prediction systems;
 - (4) be able to operate in required navigation performance (RNP) 4 oceanic and remote continental airspace and in area navigation (RNAV) 1 continental en-route airspace, as applicable;
 - (5) be able to perform APCHs that require an LVO approval and RNP APCHs down to VNAV minima; and
 - (6) update the available landing options by establishing an operational control system with the following capabilities:
 - (i) flight monitoring or flight watch;
 - (ii) collection and continuous monitoring of reliable meteorological, aerodrome, and traffic information;
 - (iii) two independent airborne communications systems to achieve rapid and reliable exchange of relevant safety information between flight operations personnel and flight crew during the entire flight; and
 - (iv) monitoring of the status of aircraft systems that affect fuel consumption and of ground and aircraft systems that affect landing capabilities.
- (f) After receiving the approval, the operator should:
 - (1) continually measure and monitor the outcome of each SPI; and
 - (2) in case of degradation of any SPI:
 - (i) assess the root cause of the degradation;
 - (ii) identify remedial actions to restore the baseline safety performance; and
 - (iii) when the associated safety performance target is not met, inform the authority as soon as practicable.

GM1 CAT.OP.MPA.180 Fuel/energy scheme — aeroplanes

ED Decision 2022/005/R

FUEL SCHEMES

An operator can choose between three different fuel schemes. For the development of each fuel scheme, the following AMC are applicable:

- (a) Basic fuel scheme: all the AMC that apply to the basic fuel scheme.
- (b) Basic fuel scheme with variations: when an operator decides to deviate fully or partly from the basic fuel schemes, the AMC for basic fuel schemes with variations apply to the specific deviation.

- (c) Individual fuel scheme: when an operator wishes to apply an individual fuel scheme, the AMC for the individual fuel scheme apply; for the part of the scheme where the operator still follows the basic fuel scheme, the operator should apply the AMC referred to in (a) and (b).

GM2 CAT.OP.MPA.180 Fuel/energy scheme — aeroplanes

ED Decision 2022/005/R

INDIVIDUAL FUEL SCHEMES — BASELINE SAFETY PERFORMANCE INDICATORS (SPIs) AND EQUIVALENT LEVEL OF SAFETY

- (a) Establishing the baseline safety performance of a current fuel scheme involves collecting historical statistical data for the selected SPIs over a defined period of time, e.g. a minimum of 2 years. The safety performance of the operator's processes is then measured against this baseline safety performance before and after implementation of the individual fuel scheme.
- (b) Agreed SPIs should be commensurate with the complexity of the operational context, the extent of the deviations of the individual fuel scheme from the current fuel scheme, and the availability of resources to address those SPIs.
- (c) The following is a non-exhaustive list of SPIs that are used to measure the baseline safety performance:
- (1) flights with 100 % consumption of the contingency fuel;
 - (2) flights with a percentage consumption of the contingency fuel (e.g. 85 %), as agreed by the operator and the competent authority;
 - (3) difference between planned and actual trip fuel;
 - (4) landings with less than the final reserve fuel (FRF) remaining;
 - (5) flights landing with less than minutes of fuel remaining (e.g. 45 minutes), as agreed by the operator and the competent authority;
 - (6) 'MINIMUM FUEL' declarations;
 - (7) 'MAYDAY MAYDAY MAYDAY FUEL' declarations;
 - (8) in-flight re-planning to the planned destination due to fuel shortage, including committing to land at the destination by cancelling the planned destination alternate;
 - (9) diversion to an en route alternate (ERA) aerodrome to protect the FRF;
 - (10) diversion to the destination alternate aerodrome; and
 - (11) any other indicator with the potential of demonstrating the suitability or unsuitability of the alternate aerodrome and fuel planning policy.

Note: Although the above-list includes quantitative SPIs, for certain non-data-based monitoring SPIs, alert and target levels may be qualitative in nature.

- (d) Equivalent level of safety: SPIs and associated targets that are achieved after the introduction of an individual fuel scheme 'should be equivalent to' or 'exceed' the SPIs and associated targets that were used in the previously approved fuel scheme. To determine if such equivalence is achieved, the operator should carefully compare with one another the safety performance of operational activities before and after the application of the individual fuel scheme. For example, the operator should ensure that the average number of landings with less than the FRF does not increase after the introduction of the individual fuel scheme.

- (e) The applicability of the individual fuel scheme may be limited to a specific aircraft fleet or type/variant of aircraft or area of operations. Different policies may be established as long as the procedures clearly specify the boundaries of each policy so that the flight crew is aware of the policy being applied: for example, the operator may wish to deviate from the basic 5 % contingency fuel policy only in certain areas of operations or only for a specific aircraft fleet or type/variant of aircraft. The safety performance of the fuel scheme may be measured according to the relevant area of operation or aircraft fleet or type/variant of aircraft so that any degradation of the safety performance can be isolated and mitigated separately. In that case, the approval for a deviation may be suspended for the affected area of operations and/or type/variant of aircraft until the required safety performance is achieved.

Note: ICAO Doc 9976 Flight Planning and Fuel Management (FPFM) Manual (1st Edition, 2015) and the EASA Fuel Manual provide further guidance.

GM3 CAT.OP.MPA.180 Fuel/energy scheme — aeroplanes

ED Decision 2022/005/R

INDIVIDUAL FUEL SCHEMES — OPERATOR CAPABILITIES — COMMUNICATIONS SYSTEMS

- (a) In the context of point (e)(6) of [AMC1 CAT.OP.MPA.180](#), the availability of two independent communications systems at dispatch is particularly relevant for flights over oceanic and remote areas (e.g. when flying over the ocean without VHF coverage, operators need either HF or satellite communications (SATCOM)).
- (b) Consideration should also be given to the operational control system associated with the use of the aircraft communications addressing and reporting system (ACARS). Two communications systems (e.g. VHF and SATCOM) should be used to support the ACARS functionality to ensure the required degree of independence unless the operator has established contingency procedures for reverting to voice communication only.
- (c) Additional means of communications may be required by other regulations that are not linked to fuel schemes.

Note: For further information, see ICAO Doc 9976 Flight Planning and Fuel Management (FPFM) Manual, Appendix 7 to Chapter 5 A performance-based approach job-aid for an approving authority (1st Edition, 2015).

CAT.OP.MPA.181 Fuel/energy scheme – fuel/energy planning and in-flight re-planning policy – aeroplanes

Regulation (EU) 2021/1296

- (a) The operator shall:
- (1) establish a fuel/energy planning and in-flight re-planning policy as part of the fuel/energy scheme;
 - (2) ensure that the aeroplane carries a sufficient amount of usable fuel/energy to safely complete the planned flight and to allow for deviations from the planned operation;
 - (3) develop procedures for the fuel/energy planning and in-flight re-planning policy that shall be contained in the operations manual.
 - (4) ensure that the fuel/energy planning of the flight is based on:
 - (i) current aircraft-specific data derived from a fuel/energy consumption monitoring system or, if not available;

-
- (ii) data provided by the aeroplane manufacturer.
- (b) The operator shall ensure that the planning of flights includes the operating conditions under which the flight is to be conducted; the operating conditions shall include at least:
- (1) aircraft fuel/energy consumption data;
 - (2) anticipated masses;
 - (3) anticipated meteorological conditions;
 - (4) the effects of deferred maintenance items and/or of configuration deviations;
 - (5) the expected departure and arrival routing and runways; and
 - (6) anticipated delays.
- (c) The operator shall ensure that the pre-flight calculation of the usable fuel/energy that is required for a flight includes:
- (1) taxi fuel/energy that shall not be less than the amount expected to be used prior to take-off;
 - (2) trip fuel/energy that shall be the amount of fuel/energy that is required to enable the aeroplane to fly from take-off, or from the point of in-flight re-planning, to landing at the destination aerodrome;
 - (3) contingency fuel/energy that shall be the amount of fuel/energy required to compensate for unforeseen factors;
 - (4) destination alternate fuel/energy:
 - (i) when a flight is operated with at least one destination alternate aerodrome, it shall be the amount of fuel/energy required to fly from the destination aerodrome to the destination alternate aerodrome; or
 - (ii) when a flight is operated with no destination alternate aerodrome, it shall be the amount of fuel/energy required to hold at the destination aerodrome, while enabling the aeroplane to perform a safe landing, and to allow for deviations from the planned operation; as a minimum, this amount shall be 15-minute fuel/energy at holding speed at 1 500ft (450 m) above the aerodrome elevation in standard conditions, calculated according to the estimated aeroplane mass on arrival at the destination aerodrome;
 - (5) final reserve fuel/energy that shall be the amount of fuel/energy that is calculated at holding speed at 1 500ft (450 m) above the aerodrome elevation in standard conditions according to the aeroplane estimated mass on arrival at the destination alternate aerodrome, or destination aerodrome when no destination alternate aerodrome is required, and shall not be less than:
 - (i) for aeroplanes with reciprocating engines, the fuel/energy to fly for 45 minutes; or
 - (ii) for turbine-engined aeroplanes, the fuel/energy to fly for 30 minutes;
 - (6) additional fuel/energy, if required by the type of operation; it shall be the amount of fuel/energy to enable the aeroplane to land at a fuel/energy en route alternate aerodrome (fuel/energy ERA aerodrome critical scenario) in the event of an aircraft failure that significantly increases the fuel/energy consumption at the most critical point along the route; this additional fuel/energy is required only if the minimum amount of

- fuel/energy that is calculated according to points (c)(2) to (c)(5) is not sufficient for such an event;
- (7) extra fuel/energy to take into account anticipated delays or specific operational constraints; and
 - (8) discretionary fuel/energy, if required by the commander.
- (d) The operator shall ensure that in-flight re-planning procedures for calculating the usable fuel/energy that is required when a flight proceeds along a route or to a destination aerodrome other than the ones originally planned include points (c)(2) to (c)(7).

AMC1 CAT.OP.MPA.181 Fuel/energy scheme — fuel/energy planning and in-flight re-planning policy — aeroplanes

ED Decision 2022/005/R

BASIC FUEL SCHEME — PRE-FLIGHT CALCULATION OF USABLE FUEL FOR PERFORMANCE CLASS A AEROPLANES

For the pre-flight calculation of the usable fuel in accordance with point [CAT.OP.MPA.181](#), the operator should:

- (a) for taxi fuel, take into account the local conditions at the departure aerodrome and the APU consumption;
- (b) for trip fuel, include:
 - (1) fuel for take-off and climb from the aerodrome elevation to the initial cruising level/altitude, taking into account the expected departure routing;
 - (2) fuel from the top of climb to the top of descent, including any step climb/descent;
 - (3) fuel from the top of descent to the point where the approach procedure is initiated, taking into account the expected arrival routing; and
 - (4) fuel for making an approach and landing at the destination aerodrome;
- (c) for contingency fuel, calculate for unforeseen factors either:
 - (1) 5 % of the planned trip fuel or, in the event of in-flight re-planning, 5 % of the trip fuel for the remainder of the flight; or
 - (2) an amount to fly for 5 minutes at holding speed at 1 500 ft (450 m) above the destination aerodrome in standard conditions,whichever is the higher;
- (d) for destination alternate fuel, include:
 - (1) when the aircraft is operated with one destination alternate aerodrome:
 - (i) fuel for a missed approach from the applicable DA/H or MDA/H at the destination aerodrome to the missed-approach altitude, taking into account the complete missed-approach procedure;
 - (ii) fuel for climb from the missed-approach altitude to the cruising level/altitude, taking into account the expected departure routing;
 - (iii) fuel for cruising from the top of climb to the top of descent, taking into account the expected routing;

- (iv) fuel for descent from the top of descent to the point where the approach is initiated, taking into account the expected arrival routing; and
 - (v) fuel for making an approach and landing at the destination alternate aerodrome; and
- (2) when the aircraft is operated with two destination alternate aerodromes, the amount of fuel that is calculated in accordance with point (d)(1), based on the destination alternate aerodrome that requires the greater amount of fuel;
- (e) for FRF, comply with point [CAT.OP.MPA.181\(c\)](#);
 - (f) for additional fuel, include an amount of fuel that allows the aeroplane to proceed, in the event of an engine failure or loss of pressurisation, from the most critical point along the route to a fuel en route alternate (fuel ERA) aerodrome in the relevant aircraft configuration, hold there for 15 minutes at 1 500 ft (450 m) above the aerodrome elevation in standard conditions, make an approach, and land;
 - (g) for extra fuel, include anticipated delays or specific operational constraints that can be predicted; and
 - (h) for discretionary fuel, include a quantity at the sole discretion of the commander.

AMC2 CAT.OP.MPA.181 Fuel/energy scheme — fuel/energy planning and in-flight re-planning policy — aeroplanes

ED Decision 2022/005/R

BASIC FUEL SCHEME — PRE-FLIGHT CALCULATION OF USABLE FUEL FOR PERFORMANCE CLASS B and C AEROPLANES

The pre-flight calculation of required usable fuel should include:

- (a) taxi fuel, if significant;
- (b) trip fuel;
- (c) contingency fuel that is not less than 5 % of the planned trip fuel, or in the event of in-flight re-planning, 5 % of the trip fuel for the remainder of the flight;
- (d) alternate fuel to reach the destination alternate aerodrome via the destination if a destination alternate aerodrome is required;
- (e) FRF to comply with point [CAT.OP.MPA.181\(c\)](#);
- (f) extra fuel if there are anticipated delays or specific operational constraints; and
- (g) discretionary fuel, if required by the commander.

The operating conditions may include rounded-up figures of fuel for all flights.

AMC3 CAT.OP.MPA.181 Fuel/energy scheme — fuel/energy planning and in-flight re-planning policy — aeroplanes

ED Decision 2022/005/R

BASIC FUEL SCHEME — PRE-FLIGHT CALCULATION OF USABLE FUEL FOR ELA2 AEROPLANES

For operations, take-off, and landing at the same aerodrome or operating site under VFR by day, operators should specify the minimum FRF in the OM. This FRF should not be less than the amount needed to fly for a period of 45 minutes. The operating conditions may be rounded up to a single

figure of fuel for all flights. For the pre-flight calculation of the required usable fuel, a single rounded-up figure for the particular flight is needed, which includes trip fuel, contingency fuel, extra fuel, discretionary fuel, and alternate fuel, to reach a destination alternate aerodrome if such an aerodrome is required.

AMC4 CAT.OP.MPA.181 Fuel/energy scheme — Fuel/energy planning and in-flight re-planning policy — aeroplanes

ED Decision 2022/005/R

BASIC FUEL SCHEME — PRE-FLIGHT CALCULATION OF USABLE FUEL

The additional fuel required by the type of operation in the event of an aircraft failure that significantly increases fuel consumption at the most critical point along the route should be calculated according to the engine failure or loss of pressurisation, whichever requires a greater amount of fuel.

AMC5 CAT.OP.MPA.181 Fuel/energy scheme — fuel/energy planning and in-flight re-planning policy — aeroplanes

ED Decision 2022/005/R

BASIC FUEL SCHEME WITH VARIATIONS — TAXI FUEL

To calculate taxi fuel for a basic fuel scheme with variations, the operator may use statistical taxi fuel.

AMC6 CAT.OP.MPA.181 Fuel/energy scheme — fuel/energy planning and in-flight re-planning policy — aeroplanes

ED Decision 2022/005/R

BASIC FUEL SCHEME WITH VARIATIONS — CONTINGENCY FUEL

- (a) Contingency fuel variations are methods of reducing the basic amount of contingency fuel based on established mitigating measures.
- (b) If the operator establishes and maintains a fuel consumption monitoring system for individual aeroplanes, and uses valid data for fuel calculation based on such a system, the operator may use any of the requirements in point (c) or (d) of this AMC to calculate the contingency fuel.
- (c) The contingency fuel should be the fuel described in points (c)(1) or (c)(2) of this AMC, whichever is higher:
 - (1) an amount of fuel that should be either:
 - (i) not less than 3 % of the planned trip fuel, or in the event of in-flight re-planning, 3 % of the trip fuel for the remainder of the flight provided that a fuel en route alternate (fuel ERA) aerodrome is available; or
 - (ii) an amount of fuel sufficient for 20-minute flying time based upon the planned trip fuel consumption; or
 - (iii) an amount of fuel based on a statistical fuel method that ensures an appropriate statistical coverage of the deviation from the planned to the actual trip fuel; prior to implementing a statistical fuel method, a continuous 2-year operation is required during which statistical contingency fuel (SCF) data is recorded — note: to use SCF on a particular city pair/aeroplane combination, sufficient data is required to be statistically significant; the operator should use this method to

monitor the fuel consumption on each city pair/aeroplane combination, and to carry out a statistical analysis to calculate the required contingency fuel for that city pair/aeroplane combination;

or

- (2) an amount of fuel to fly for 5 minutes at holding speed at 1 500 ft (450 m) above the destination aerodrome in standard conditions.
- (d) RCF procedure: if the operator's fuel policy includes pre-flight planning to a destination 1 aerodrome (commercial destination with an RCF procedure using a decision point along the route) and a destination 2 aerodrome (optional refuelling destination), the amount in the pre-flight calculation of the required usable fuel should be greater than the sum in points (d)(1) or (d)(2):
- (1) the sum of:
 - (i) taxi fuel;
 - (ii) trip fuel to the destination 1 aerodrome via the decision point;
 - (iii) contingency fuel equal to not less than 5 % of the fuel that is estimated to be consumed from the decision point to the destination 1 aerodrome;
 - (iv) the amount of fuel specified in [AMC2 CAT.OP.MPA.182](#): destination 1 alternate fuel or no alternate fuel if the remaining flying time from the decision point to destination 1 aerodrome is less than 6 hours;
 - (v) FRF;
 - (vi) additional fuel;
 - (vii) extra fuel if there are anticipated delays or specific operational constraints; and
 - (viii) discretionary fuel, if required by the commander; or
 - (2) the sum of:
 - (i) taxi fuel;
 - (ii) trip fuel to the destination 2 aerodrome via the decision point;
 - (iii) contingency fuel equal to not less than the amount that is calculated in accordance with point (c) of this AMC, from the departure aerodrome to the destination 2 aerodrome;
 - (iv) alternate fuel if a destination 2 alternate aerodrome is required;
 - (v) FRF;
 - (vi) additional fuel;
 - (vii) extra fuel if there are anticipated delays or specific operational constraints; and
 - (viii) discretionary fuel, if required by the commander.

AMC7 CAT.OP.MPA.181 Fuel/energy scheme — fuel/energy planning and in-flight re-planning policy — aeroplanes

ED Decision 2022/005/R

BASIC FUEL SCHEME WITH VARIATIONS — LOCATION OF THE FUEL EN ROUTE ALTERNATE AERODROME TO REDUCE CONTINGENCY FUEL TO 3 %

The fuel en route alternate (fuel ERA) aerodrome should be located within a circle with a radius equal to 20 % of the total flight plan distance; the centre of this circle lies on the planned route at a distance from the destination aerodrome equal to 25 % of the total flight plan distance, or at least 20 % of the total flight plan distance plus 50 NM, whichever is greater. All distances should be calculated in still-air conditions (see Figure 1). The fuel ERA aerodrome should be nominated in the operational flight plan.

Figure 1 — Location of the fuel ERA aerodrome to reduce contingency fuel to 3 %

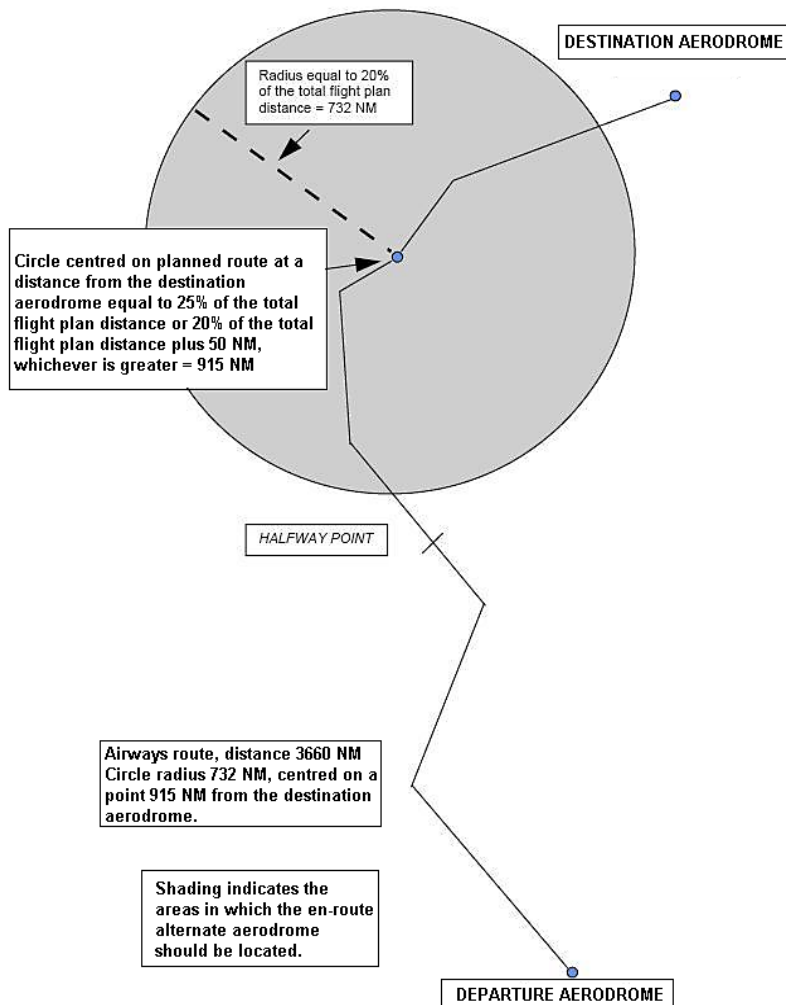

AMC8 CAT.OP.MPA.181 Fuel/energy scheme — fuel/energy planning and in-flight re-planning policy — aeroplanes

ED Decision 2022/005/R

INDIVIDUAL FUEL SCHEME — FUEL CONSUMPTION MONITORING SYSTEM

A fuel consumption monitoring system should be data driven, and should include the following:

- (a) a fuel performance monitoring system;
- (b) a database that contains statistically significant data of at least 2 years;
- (c) statistics and data normalisation; and
- (d) data transparency and verification.

GM1 CAT.OP.MPA.181 Fuel/energy scheme — fuel/energy planning and in-flight re-planning policy — aeroplanes

ED Decision 2022/005/R

BASIC FUEL SCHEME

TAXI FUEL — LOCAL CONDITIONS

- (a) Local conditions, as referred to in point (a) of AMC1 CAT.OP.MPA.181, include NOTAMs, meteorological conditions (e.g. winter operations), ATS procedures (e.g. LVP, collaborative decision-making (CDM)), and any anticipated delay(s).

PLANNING OF FLIGHTS

- (b) A flight should be planned by using the most accurate information available. If aircraft-specific data that is derived from a fuel consumption monitoring system is available, this data is used in preference to data that is provided by the aircraft manufacturer. Data that is provided by the aircraft manufacturer should be used only in specific cases, e.g. when introducing a new aircraft type into service.

FUEL CONSUMPTION MONITORING SYSTEM

- (c) Extensive guidance on a fuel consumption monitoring system is provided in ICAO Doc 9976 Flight Planning and Fuel Management (FPFM) Manual, Appendix 5 to Chapter 5 Example of a fuel consumption monitoring (FCM) programme (1st Edition, 2015). As a basic requirement, the fuel consumption monitoring system (commonly referred to as ‘hull-specific fuel bias’) is a process of comparing an aeroplane’s achieved in-flight performance to an aeroplane’s predicted performance. Variations between the achieved performance and the predicted performance result in a variation of the fuel consumption rate, which should be accounted for by the operator during flight planning and in-flight re-planning.

The fuel consumption monitoring system is used to determine an individual aeroplane’s performance in comparison with its predicted one. In no case, should data that is collected from one aeroplane be used as a basis for varying another aeroplane’s performance figures away from the predicted values.

The data that is collected and used to determine an aeroplane’s actual performance should be collected in a manner acceptable to the competent authority. The operator should demonstrate that the data collected during in-service operation of the aeroplane is accurate. Where possible, the data should be collected automatically; however, manual recording of data does not preclude an operator from participating in a fuel consumption monitoring system.

ANTICIPATED MASSES — LAST-MINUTE CHANGES

- (d) Where appropriate, the operating procedures should include means to revise the fuel quantity and define limits to zero fuel weight (ZFW) changes, beyond which a new operational flight plan should be calculated.

TRIP FUEL — ARRIVAL ROUTING

- (e) POINT MERGE PATTERN

When planning for a STAR to point merge, fuel for the direct STAR to the point merge should be included in the trip fuel. The fuel required to account for the probability that part of or the entire point merge route needs to be flown may be included in the contingency fuel unless there is an anticipated delay, in which case, the fuel required for the route should be included in the extra fuel.

- (f) POINT TROMBONE PATTERN

When planning for a STAR or transition including a trombone pattern, fuel for the reasonably expected route should be included in the trip fuel. The fuel required to account for the probability that an extended part of or the entire trombone pattern route needs to be flown may be included in the contingency fuel unless there is an anticipated delay, in which case, the fuel required for the trombone pattern route should be included in the extra fuel.

UNFORESEEN FACTORS

- (g) According to its definition, contingency fuel is the amount of fuel required to compensate for unforeseen factors.

Unforeseen factors are those that could have an influence on the fuel consumption to the destination aerodrome, such as deviations of an individual aeroplane from the expected fuel consumption data, deviations from forecast meteorological conditions, extended unexpected delays in flight, extended unexpected taxi times, and deviations from planned routings and/or cruising levels.

Unforeseen factors may differ based on the type of fuel scheme adopted by each operator; the higher the capability of the operator, the fewer unforeseen factors there may be.

For example, operators that have a fuel consumption monitoring system should calculate the trip fuel based on the individual fuel consumption. Extended unexpected delays or deviations from forecast meteorological conditions are mitigated by means of statistical data.

DESTINATION ALTERNATE AERODROME

- (h) The departure aerodrome may be selected as the destination alternate aerodrome.

FINAL RESERVE FUEL

- (i) The operator may determine conservative (rounded-up) FRF values for each type and variant of aeroplane that is used in operations. The intent of this recommendation is:
- (1) to provide a reference value for comparing to pre-flight fuel planning computations, and for the purpose of a 'gross error' check; and
 - (2) to provide flight crews with easily referenced and recallable FRF figures to support in-flight fuel monitoring and decision-making activities.

ANTICIPATED DELAYS

- (j) In the context of fuel schemes, an anticipated delay is defined as one that can be predicted based on the information that is provided by the State of the aerodrome and/or ATS provider

before the flight commences. For example, restrictions due to scheduled maintenance work on a runway are likely to cause a delay to the normal flow of inbound traffic. That delay may be promulgated either through NOTAMs or via the aeronautical information publication (AIP), including a specific time and/or date.

Another example is an ATS procedure that requires an operator to fly longer routes, e.g. due to curfew during night-time.

DISCRETIONARY FUEL

- (k) Discretionary fuel is defined as ‘fuel at the sole discretion of the commander’ (PIC). The commander’s discretion over the amount of fuel to be carried is independent and cannot be encouraged or discouraged.

IN-FLIGHT RE-PLANNING

- (l) In the context of fuel policy, in-flight re-planning means voluntarily changing the destination aerodrome, any alternate aerodrome, or the remainder of the route after the flight commences, even when the flight can be completed as originally planned. In-flight re-planning has a broader sense than being obliged to change the intended course of action due to safety issues (remaining fuel, failures, bad weather conditions, etc.). In-flight re-planning allows the operator to modify the filed flight plan after flight commencement for commercial or other reasons. However, the modified flight plan should fulfil all requirements of a new flight plan. The use of en route alternate (ERA) aerodromes to save fuel should comply with the in-flight re-planning requirements.

In-flight re-planning should not apply when the aircraft no longer continues via the flight plan route to the intended destination for reasons that could not be anticipated. In such cases, the in-flight fuel management policy dictates the commander’s course of action.

GM2 CAT.OP.MPA.181 Fuel/energy scheme — fuel/energy planning and in-flight re-planning policy — aeroplanes

ED Decision 2022/005/R

BASIC FUEL SCHEME WITH VARIATIONS — STATISTICAL CONTINGENCY FUEL METHOD

As an example of statistical contingency fuel, the following statistical values of the deviation from the planned to the actual trip fuel provide appropriate statistical coverage:

- (a) 99 % coverage plus 3 % of the trip fuel if the calculated flight time:
- (1) is less than 2 hours; or
 - (2) is more than 2 hours and no fuel ERA aerodrome is available;
- (b) 99 % coverage if the calculated flight time is more than 2 hours and a fuel ERA aerodrome is available; and
- (c) 90 % coverage if:
- (1) the calculated flight time is more than 2 hours;
 - (2) a fuel ERA aerodrome is available; and
 - (3) at the destination aerodrome, two separate runways are available and usable, one of which is suitable for type B instrument approach operations, and the meteorological conditions are in accordance with point [CAT.OP.MPA.182\(e\)](#).

GM3 CAT.OP.MPA.181 Fuel/energy scheme — fuel/energy planning and in-flight re-planning policy — aeroplanes

ED Decision 2022/005/R

INDIVIDUAL FUEL SCHEME — FUEL CONSUMPTION MONITORING SYSTEM

More information can be found in ICAO Doc 9976 Flight Planning and Fuel Management (FPFM) Manual, Appendix 5 to Chapter 5.

GM4 CAT.OP.MPA.181 Fuel/energy scheme — fuel/energy planning and in-flight re-planning policy — aeroplanes

ED Decision 2022/005/R

INDIVIDUAL FUEL SCHEME — ANTICIPATED METEOROLOGICAL CONDITIONS

When determining the extent of the deviation in the area of operation, the operator should monitor the reliability of the meteorological forecast reports. The competent authority should consider restricting or even not allowing a deviation when reliable meteorological information is not available. To this end, tools to predict and improve the reliability of the meteorological forecast reports may be explored to allow for the intended deviation.

CAT.OP.MPA.182 Fuel/energy scheme – aerodrome selection policy – aeroplanes

Regulation (EU) 2021/1296

- (a) At the planning stage, the operator shall ensure that once the flight has commenced, there is reasonable certainty that an aerodrome where a safe landing can be made will be available at the estimated time of use of that aerodrome.
- (b) At the planning stage, to allow for a safe landing in case of an abnormal or emergency situation after take-off, the operator shall select and specify in the operational flight plan a take-off alternate aerodrome if either:
 - (1) the meteorological conditions at the aerodrome of departure are below the operator's established aerodrome landing minima for that operation; or
 - (2) it would be impossible to return to the aerodrome of departure for other reasons.
- (c) The take-off alternate aerodrome shall be located within a distance from the departure aerodrome that minimises the risk of exposure to potential abnormal or emergency situations. In selecting the take-off alternate aerodrome, the operator shall consider at least the following:
 - (1) actual and forecast meteorological conditions;
 - (2) availability and quality of the aerodrome infrastructure;
 - (3) navigation and landing capabilities of the aircraft in abnormal or emergency conditions, taking into account the redundancy of critical systems; and
 - (4) approvals held (e.g. extended range operations with two-engined aeroplanes (ETOPS), low visibility operation (LVO), etc.).
- (d) At the planning stage, for each instrument flight rules (IFR) flight, the operator shall select and specify in the operational and air traffic services (ATS) flight plans one or more aerodromes so that two safe-landing options are available during normal operation when:

- (1) reaching the destination aerodrome; or
- (2) reaching the point of no return, to any available fuel/energy ERA aerodrome during isolated aerodrome operations; a flight to an isolated aerodrome shall not be continued past the point of no return unless a current assessment of meteorological conditions, traffic, and other operational conditions indicates that a safe landing can be made at the destination aerodrome at the estimated time of use.

The operator shall obtain prior approval from the competent authority for the use of an isolated aerodrome as destination aerodrome.

- (e) The operator shall provide appropriate safety margins to flight planning to take into account a possible deterioration of the available forecast meteorological conditions at the estimated time of landing.
- (f) For each IFR flight, the operator shall ensure that sufficient means are available to navigate to and land at the destination aerodrome or at any destination alternate aerodrome in the event of loss of capability for the intended approach and landing operation.

AMC1 CAT.OP.MPA.182 Fuel/energy scheme — aerodrome selection policy — aeroplanes

ED Decision 2022/005/R

BASIC FUEL SCHEME — TAKE-OFF ALTERNATE AERODROME

The take-off alternate aerodrome should not be farther from the departure aerodrome than:

- (a) for two-engined aeroplanes:
 - (1) 1-hour flight time at an one-engine-inoperative (OEI) cruising speed according to the AFM in ISA and still-air conditions using the actual take-off mass; or
 - (2) the extended-range twin operations (ETOPS) diversion time that is approved in accordance with Subpart F of Annex V (Part-SPA) to Regulation (EU) No 965/2012, subject to any minimum equipment list (MEL) restriction, up to a maximum of 2-hour flight time at OEI cruising speed according to the AFM in ISA and still-air conditions using the actual take-off mass; and
- (b) for three- or four-engined aeroplanes, 2-hour flight time at an all-engines-operating cruising speed according to the AFM in ISA and still-air conditions using the actual take-off mass;
- (c) for operations approved in accordance with Annex V (Part-SPA), Subpart L *SINGLE-ENGINE TURBINE AEROPLANE OPERATIONS AT NIGHT OR IN IMC (SET-IMC)*, 30 minutes flying time at normal cruising speed in still-air conditions, based on the actual take-off mass;
- (d) in the case of multi-engined aeroplanes, if the AFM does not contain an OEI cruising speed, the speed to be used for calculation shall be that which is achieved with the remaining engine(s) set at maximum continuous power.

AMC2 CAT.OP.MPA.182 Fuel/energy scheme — aerodrome selection policy — aeroplanes

ED Decision 2022/005/R

BASIC FUEL SCHEME — DESTINATION ALTERNATE AERODROME

- (a) For each IFR flight, the operator should select and specify in the operational and ATS flight plans at least one destination alternate aerodrome.
- (b) For each IFR flight, the operator should select and specify in the operational and ATS flight plans two destination alternate aerodromes when for the selected destination aerodrome, the safety margins for meteorological conditions of [AMC5 CAT.OP.MPA.182](#), and the planning minima of [AMC6 CAT.OP.MPA.182](#) cannot be met, or when no meteorological information is available.
- (c) The operator may operate with no destination alternate aerodrome when the destination aerodrome is an isolated aerodrome or when the following two conditions are met:
 - (1) the duration of the planned flight from take-off to landing does not exceed 6 hours or, in the event of in-flight re-planning, in accordance with point [CAT.OP.MPA.181\(d\)](#), the remaining flying time to destination does not exceed 4 hours; and
 - (2) two separate runways are usable at the destination aerodrome and the appropriate weather reports and/or weather forecasts indicate that for the period from 1 hour before to 1 hour after the expected time of arrival, the ceiling is at least 2 000 ft (600 m) or the circling height 500 ft (150 m), whichever is greater, and ground visibility is at least 5 km.

AMC3 CAT.OP.MPA.182 Fuel/energy scheme — aerodrome selection policy — aeroplanes

ED Decision 2022/005/R

BASIC FUEL SCHEME — AERODROME FORECAST METEOROLOGICAL CONDITIONS

Table 1 — Aerodrome forecasts (TAFs) and landing forecasts (TRENDS) to be used for pre-flight planning

APPLICATION OF AERODROME FORECASTS (TAF AND TREND) TO PRE-FLIGHT PLANNING						
(a) APPLICATION OF INITIAL PART OF TAF						
(1) Application period: from the start of the TAF validity period to the time of applicability of the first subsequent 'FM...*' or 'BECMG', or if no 'FM...' or 'BECMG' is given, to the end of the validity period of the TAF.						
(2) Application of forecast: the forecast of the prevailing weather conditions in the initial part of the TAF should be fully applied, with the exception of mean wind and gusts that should be applied in accordance with the policy under column 'BECMG AT and FM...' in the table below. However, this may be temporarily superseded by a 'TEMPO' or 'PROB**', if applicable according to the table below.						
(b) APPLICATION OF FORECAST FOLLOWING CHANGE INDICATION IN THE TAF AND TREND						
TAF or TREND for AERODROME PLANNED AS:	FM... (alone) and BECMG AT :	BECMG (alone), BECMG FM, BECMG TL, BECMG FM... TL , in case of:		TEMPO (alone), TEMPO FM , TEMPO FM... TL , PROB 30/40 (alone)	PROB TEMPO	
	Deterioration and improvement	Deterioration	Improvement	Deterioration	Improvement	Deterioration and improvement

				Transient/shower conditions in connection with short-lived weather phenomena, e.g. thunderstorms, showers	Persistent conditions in connection with e.g. haze, mist, fog, dust storm/sandstorm, continuous precipitations	In any case	
--	--	--	--	--	---	-------------	--

DESTINATION at ESTIMATED TIME OF ARRIVAL (ETA) ± 1 HR TAKE-OFF ALTERNATE at ETA ± 1 HR DESTINATION ALTERNATE at ETA ± 1 HR FUEL ERA at ETA ± 1 HR	Applicable from the start of change	Applicable from the start of change	Applicable from the end of change	Not applicable	Applicable	Should be disregarded	Deterioration may be disregarded. Improvement should be disregarded including mean wind and gusts.
	Mean wind should be within required limits Gusts exceeding crosswind limits should be fully applied	Mean wind should be within required limits Gusts exceeding crosswind limits should be fully applied	Mean wind should be within required limits Gusts exceeding crosswind limits should be fully applied	Mean wind and gusts exceeding required limits may be disregarded	Mean wind should be within required limits Gusts exceeding crosswind limits should be fully applied		
ETOPS ERA	Applicable from the start of change	Applicable from the start of change	Applicable from the end of change	Applicable if below applicable landing minima	Applicable if below applicable landing minima		
	Mean wind should be within	Mean wind should be within	Mean wind should be within	Mean wind should be within	Mean wind should be within		

From earliest ETA to ETA + 1 HR	required limits	required limits	required limits	required limits	required limits		
	Gusts exceeding crosswind limits should be fully applied	Gusts exceeding crosswind limits should be fully applied	Gusts exceeding crosswind limits should be fully applied	Gusts exceeding limits should be fully applied	Gusts exceeding limits should be fully applied		
<p>* The space following 'FM' should always include a time group, e.g. FM1030.</p> <p>Note 1: 'required limits' are those contained in the OM.</p> <p>Note 2: if promulgated aerodrome forecasts do not comply with the provisions of ICAO Annex 3, operators should ensure that guidance on the application of these reports is provided.</p> <p>Note 3: for the definitions of the meteorological terms used in this table, see ICAO Annex 3.</p>							

AMC4 CAT.OP.MPA.182 Fuel/energy scheme — aerodrome selection policy — aeroplanes

ED Decision 2022/005/R

BASIC FUEL SCHEME — REACHING THE DESTINATION AERODROME

In the context of the basic fuel scheme and basic fuel scheme with variations, 'reaching the destination' means the point at which the aircraft has reached the applicable DA/H or MDA/H at the destination aerodrome.

AMC5 CAT.OP.MPA.182 Fuel/energy scheme — aerodrome selection policy — aeroplanes

ED Decision 2022/005/R

BASIC FUEL SCHEME — SAFETY MARGINS FOR METEOROLOGICAL CONDITIONS

(a) The operator should only select an aerodrome as:

- (1) take-off alternate aerodrome; or
- (2) destination aerodrome

when the appropriate weather reports and/or forecasts indicate that during a period commencing 1 hour before and ending 1 hour after the estimated time of arrival at the aerodrome, the weather conditions will be at or above the applicable landing minima as follows:

- (i) RVR or VIS specified in accordance with point [CAT.OP.MPA.110](#); and
- (ii) for a type A or a circling operation, ceiling at or above MDH.

(b) The operator should only select an aerodrome as:

- (1) destination alternate aerodrome;
- (2) fuel ERA aerodrome; or
- (3) isolated destination aerodrome

when the appropriate weather reports and/or forecasts indicate that during a period commencing 1 hour before and ending 1 hour after the estimated time of arrival at the aerodrome, the weather conditions will be at or above the planning minima.

- (c) For the take-off alternate aerodrome and isolated destination aerodrome, any limitations related to OEI operations should be taken into account.

AMC6 CAT.OP.MPA.182 Fuel/energy scheme — aerodrome selection policy — aeroplanes

ED Decision 2022/005/R

BASIC FUEL SCHEME— PLANNING MINIMA

The operator should select an aerodrome as:

- (a) destination alternate aerodrome;
- (b) fuel ERA aerodrome; or
- (c) isolated destination aerodrome

only when the appropriate weather reports and/or forecasts indicate that the weather conditions will be at or above the planning minima of Table 2 below (any limitations related to OEI operations are also taken into account):

Table 2 — Basic fuel scheme — planning minima — aeroplanes

Destination alternate aerodrome, fuel ERA aerodrome, isolated destination aerodrome

Type of approach operation	Aerodrome ceiling (cloud base or vertical visibility)	RVR/VIS
Type B instrument approach operations	DA/H + 200 ft	RVR/VIS + 800 m
Type A instrument approach operations	DA/H or MDA/H + 400 ft	RVR/VIS + 1 500 m
Circling approach operations	MDA/H + 400 ft	VIS + 1 500 m

Crosswind planning minima: see Table 1 of [AMC3 CAT.OP.MPA.182](#)

Wind limitations should be applied taking into account the runway condition (dry, wet, contaminated).

AMC7 CAT.OP.MPA.182 Fuel/energy scheme — aerodrome selection policy — aeroplanes

ED Decision 2022/005/R

BASIC FUEL SCHEMES WITH VARIATIONS — ISOLATED AERODROME — POINT OF NO RETURN

- (a) Unless destination alternate fuel is carried, the operator should use a destination aerodrome as an isolated aerodrome if the alternate fuel plus the FRF that is required to reach the nearest adequate destination alternate aerodrome is more than:
 - (1) for aeroplanes with reciprocating engines, the amount of fuel required to fly either for 45 minutes plus 15 % of the flying time planned for cruising, including FRF or for 2 hours, whichever is less; or

- (2) for turbine-engined aeroplanes, the amount of fuel required to fly for 2 hours with normal cruise consumption above the destination aerodrome, including the FRF.
- (b) If the operator's fuel planning policy includes an isolated aerodrome, a PNR should be determined by a computerised flight-planning system and specified in the operational flight plan. The required usable fuel for pre-flight calculation should be as indicated in points (b)(1) or (b)(2), whichever is greater:
- (1) the sum of:
- (i) taxi fuel;
 - (ii) trip fuel from the departure aerodrome to the isolated aerodrome via the PNR;
 - (iii) contingency fuel that is calculated in accordance with the operator's current fuel scheme;
 - (iv) additional fuel, if required, but not less than:
 - (A) for aeroplanes with reciprocating engines, the fuel to fly either for 45 minutes plus 15 % of the flight time planned for cruising or for 2 hours, whichever is less; or
 - (B) for turbine-engined aeroplanes, the fuel to fly for 2 hours with normal cruise consumption above the destination aerodrome, including the FRF;
 - (v) extra fuel if there are anticipated delays or specific operational constraints; and
 - (vi) discretionary fuel, if required by the commander;
- (2) the sum of:
- (i) taxi fuel;
 - (ii) trip fuel from the departure aerodrome to the fuel ERA PNR aerodrome via the PNR;
 - (iii) contingency fuel that is calculated in accordance with the operator's current fuel scheme;
 - (iv) additional fuel, if required, but not less than:
 - (A) for aeroplanes with reciprocating engines, fuel to fly for 45 minutes; or
 - (B) for turbine-engined aeroplanes, fuel to fly for 30 minutes at holding speed at 1 500 ft (450 m) above the fuel ERA aerodrome elevation in standard conditions, which should not be less than the FRF;
 - (v) extra fuel if there are anticipated delays or specific operational constraints; and
 - (vi) discretionary fuel, if required by the commander.

AMC8 CAT.OP.MPA.182 Fuel/energy scheme — aerodrome selection policy — aeroplanes

ED Decision 2022/012/R

BASIC FUEL SCHEME WITH VARIATIONS — PLANNING MINIMA

- (a) Variations to the basic fuel schemes in the selection of aerodromes in regard to the planning minima are methods to reduce the meteorological margins based on the established mitigating measures.

- (b) As a minimum, the operator should:
 - (1) use a suitable computerised flight-planning system; and
 - (2) have established an operational control system that includes flight monitoring.
- (c) In addition:
 - (1) the duration of the planned flight from take-off to landing does not exceed 6 hours or, in the event of in-flight re-planning, in accordance with point [CAT.OP.MPA.181\(d\)](#), the remaining flying time to destination does not exceed 4 hours; and
 - (2) the planned flight should have a minimum flight crew of two pilots.
- (d) Additionally, the operator should select an aerodrome as:
 - (1) a destination alternate aerodrome, or
 - (2) a fuel ERA aerodrome,

only when the appropriate weather reports and/or forecasts indicate that the weather conditions will be at or above the planning minima of Table 3 below.

Table 3 — Basic fuel scheme with variations — planning minima — aeroplanes
Destination alternate aerodrome, fuel ERA aerodrome

Row	Type of approach operation	Aerodrome ceiling (cloud base or vertical visibility)	RVR/VIS
1	Type B instrument approach operations	DA/H + 200 ft	RVR/VIS + 550 m
2	3D Type A instrument approach operations, based on a facility with a system minimum of 200 ft or less	DA/H* + 200 ft	RVR/VIS** + 800 m
3	Two or more usable type A instrument approach operations***, each based on a separate navigation aid	DA/H or MDA/H* + 200 ft	RVR/VIS** + 1 000 m
4	Other type A instrument approach operations	DA/H or MDA/H + 400 ft	RVR/VIS + 1 500 m
5	Circling approach operations	MDA/H + 400 ft	VIS + 1 500 m

Crosswind planning minima: see Table 1 of [AMC3 CAT.OP.MPA.182](#)

Wind limitations should be applied taking into account the runway condition (dry, wet, contaminated).

- * The higher of the usable DA/H or MDA/H.
- ** The higher of the usable RVR or VIS.
- *** Compliance with point [CAT.OP.MPA.182\(f\)](#) should be ensured.

Note: The operator may select the most convenient planning minima row. For example, aerodrome with two type A approaches: one ILS CAT I (DA 350 ft/DH250 ft/550 m) another VOR/DME (MDA 650 ft/1 500 m). The operator may use Row 2 instead of Row 3.

AMC9 CAT.OP.MPA.182 Fuel/energy scheme — aerodrome selection policy — aeroplanes

ED Decision 2022/014/R

BASIC FUEL SCHEME WITH VARIATIONS — PLANNING MINIMA

- (a) Variations to the basic fuel schemes in the selection of aerodromes in regard to the planning minima are methods to reduce the meteorological margins based on the established mitigating measures.

- (b) As a minimum, the operator should:
 - (1) use a suitable computerised flight-planning system;
 - (2) hold an approval for low-visibility approach operations for that fleet; and
 - (3) have established an operational control system that includes flight monitoring.
- (c) Additionally, the operator should select an aerodrome as:
 - (1) destination alternate aerodrome;
 - (2) fuel ERA aerodrome; or
 - (3) isolated destination aerodrome

only when the appropriate weather reports and/or forecasts indicate that the weather conditions will be at or above the planning minima of Table 4 below.

Table 4 — Basic fuel scheme with variations — planning minima
Destination alternate aerodrome, fuel ERA aerodrome, isolated destination aerodrome

Row	Type of approach	Aerodrome ceiling (cloud base or vertical VIS)	RVR/VIS
1	Two or more usable type B instrument approach operations to two separate runways***	DA/H* + 100 ft	RVR** + 300 m
2	One usable type B instrument approach operation	DA/H + 150 ft	RVR + 450 m
3	3D Type A instrument approach operations, based on a facility with a system minimum of 200 ft or less	DA/H + 200 ft	RVR/VIS** + 800 m
4	Two or more usable type A instrument approach operations ***, each based on a separate navigation aid	DA/H or MDA/H* + 200 ft	RVR/VIS** + 1 000 m
5	One usable type A instrument approach operation	DA/H or MDA/H + 400 ft	RVR/VIS + 1 500 m
6	Circling approach operations	MDA/H + 400 ft	VIS + 1 500 m
Crosswind planning minima: see Table 1 of AMC3 CAT.OP.MPA.182			
Wind limitations should be applied taking into account the runway condition (dry, wet, contaminated).			

- * The higher of the usable DA/H or MDA/H.
- ** The higher of the usable RVR or VIS.
- *** Compliance with point [CAT.OP.MPA.182\(f\)](#) should be ensured.

Note: The operator may select the most convenient planning minima row. For example, aerodrome with two type B approaches: one CAT3 (0 ft/75 m) another CAT1 (200 ft/550 m). The operator may use Row 2 and use CAT3 (0 + 150 ft/75 + 450 m) instead of Row 1 CAT1 (200 + 100 ft/550 + 300 m).

GM1 CAT.OP.MPA.182 Fuel/energy scheme — aerodrome selection policy — aeroplanes

ED Decision 2022/005/R

BASIC FUEL SCHEME

SAFE-LANDING OPTIONS

- (a) Point [CAT.OP.MPA.182](#) sets out the safety objectives of the selection of aerodromes policy. This GM expands on the intent of that provision.

ONE SAFE-LANDING OPTION

- (b) Point [CAT.OP.MPA.182\(a\)](#) requires the fuel planning and in-flight re-planning policy to ensure that the aircraft can always proceed to at least one aerodrome where landing is possible, even in abnormal operational conditions. This may require additional fuel (point [CAT.OP.MPA.181\(c\)\(6\)](#)) to reach an en route alternate (ERA) aerodrome in case of engine or pressurisation failure.

ONE OR MORE AERODROMES

- (c) Point [CAT.OP.MPA.182\(d\)](#) requires the operator to select one or more aerodromes at the planning stage; the operator may select only one aerodrome, i.e. the destination aerodrome, in compliance with point [CAT.OP.MPA.181\(c\)\(4\)\(ii\)](#).

TWO SAFE-LANDING OPTIONS

- (d) Point [CAT.OP.MPA.182\(d\)](#) requires that when planning the flight, two safe-landing options are expected to remain available until the flight reaches its destination, where a decision will be made to commit to land or divert. This will typically be a runway at the destination aerodrome itself and a runway at a destination alternate aerodrome.

The requirement may also be satisfied by two landing runways at the destination aerodrome, provided that the risk of a single event (such as an aircraft accident) or meteorological deterioration at that single aerodrome will not eliminate both options.

- (e) Point [CAT.OP.MPA.182\(d\)](#) may also be satisfied by two destination alternate aerodromes when the destination aerodrome is not a weather-permissible aerodrome or when there is insufficient weather information at the time of planning.
- (f) In the case of an isolated aerodrome, only one safe-landing option exists beyond the point of no return (PNR), therefore, an exception is set out in point [CAT.OP.MPA.182\(d\)\(2\)](#), where the conditions to proceed beyond the PNR are laid down, and further explained in [AMC7 CAT.OP.MPA.182](#) and in point (b) of [AMC2 CAT.OP.MPA.185\(a\)](#).

SAFETY MARGINS

- (f) Point [CAT.OP.MPA.182\(e\)](#) requires operators to apply safety margins to the aerodrome operating minima to mitigate the risk that the destination alternate aerodromes, isolated aerodromes, or fuel ERA aerodromes fall below aerodrome operating minima due to minor unforeseen weather deteriorations.

GM2 CAT.OP.MPA.182 Fuel/energy scheme — aerodrome selection policy — aeroplanes

ED Decision 2022/005/R

BASIC FUEL SCHEME WITH VARIATIONS — NORMAL CRUISE CONSUMPTION

In the context of [AMC7 CAT.OP.MPA.182](#) on isolated aerodromes, normal cruise consumption is the consumption of fuel for 2 hours above the isolated aerodrome. These two hours include 30-minute FRF, leaving enough fuel for an approximately 90-minute hold over the destination.

More information is provided in ICAO Doc 9976 Flight Planning and Fuel Management (FPFM) Manual (1st Edition, 2015).

GM3 CAT.OP.MPA.182 Fuel/energy scheme — aerodrome selection policy — aeroplanes

ED Decision 2022/005/R

BASIC FUEL SCHEME WITH VARIATIONS — FACILITIES WITH A SYSTEM MINIMUM OF 200 FT OR LESS

- (a) Table 3 in [AMC8 CAT.OP.MPA.182](#) and Table 4 in [AMC9 CAT.OP.MPA.182](#) refer to type A instrument approach operations based on a facility with a system minimum of 200 ft or less. Such facilities include ILS/MLS, GBAS landing system (GLS) and GNSS/SBAS (LPV). The system minima for various facilities are contained in [AMC3 CAT.OP.MPA.110](#), Table 3.
- (b) In regard to system minima and type of instrument approach operation (type A or B), the following should be noted:
 - (1) System minimum is the lowest height to which a facility can be used without visual references. This value is not related to a particular runway or obstacle environment.
 - (2) The type of instrument approach operations is related to each individual runway with its obstacle environment.
- (c) Amongst other things the lowest DH for an instrument approach operation is determined by the system minima for the facility and the obstacle clearance height (OCH). The resulting DH determines the type of approach operation (type A or B). If the DH is 250 ft or more, it will be a type A approach operation; if the DH is less than 250 ft, it will be a type B approach operation. So, while ILS approaches to most runways may be conducted as type B approach operations, difficult obstacle situations, driving up the DH to 250 ft or higher, will result in type A approach operations.
- (d) For example, Row 2 of Table 3 in [AMC8 CAT.OP.MPA.182](#) refers to a case where the obstacle situation and associated OCH result in a DH of 250 ft or more, even though the facility involved supports a DH of 200 ft or less.
- (e) This GM refers only to DH (not MDH) since facilities with a system minimum of 200 ft or less are only operated with a DH (or DA), not an MDH.

GM4 CAT.OP.MPA.182 Fuel/energy scheme — aerodrome selection policy — aeroplanes

ED Decision 2022/005/R

FUEL SCHEMES — PLANNING MINIMA — INSTRUMENT APPROACH OPERATIONS

An instrument approach operation is considered usable for planning minima (e.g. Tables 2, 3 and 4 in [AMC6 CAT.OP.MPA.182](#), [AMC8 CAT.OP.MPA.182](#) and [AMC9 CAT.OP.MPA.182](#) respectively) when the approach facilities are available, the aircraft is equipped to perform such an approach, the flight crew is accordingly trained, and the runway is available for landing.

GM1 CAT.OP.MPA.182(d)(1) Fuel/energy scheme — aerodrome selection policy — aeroplanes

ED Decision 2022/005/R

INDIVIDUAL FUEL SCHEME — REACHING THE DESTINATION AERODROME

In the context of individual fuel schemes, ‘reaching the destination’ means being as close as possible to the destination, but not necessarily overhead the destination, and no farther than IAF of the planned instrument approach procedure for the destination aerodrome.

AMC1 CAT.OP.MPA.182(f) Fuel/energy scheme — aerodrome selection policy — aeroplanes

ED Decision 2022/012/R

BASIC FUEL SCHEME — DESTINATION AERODROMES — PBN OPERATIONS

- (a) To comply with point [CAT.OP.MPA.182\(f\)](#), when the operator intends to use PBN, the operator should select an aerodrome as destination alternate aerodrome only if an instrument approach procedure that does not rely on a GNSS is available either at that aerodrome or at the destination aerodrome.

BASIC FUEL SCHEME — DESTINATION AERODROMES — OPERATIONAL CREDITS

- (b) To comply with point [CAT.OP.MPA.182\(f\)](#), when the operator intends to use ‘operational credits’ (e.g. EFVS, SA CAT I, etc.), the operator should select an aerodrome as destination alternate aerodrome only if an approach procedure that does not rely on the same ‘operational credit’ is available either at that aerodrome or at the destination aerodrome.

GM1 CAT.OP.MPA.182(f) Fuel/energy scheme — aerodrome selection policy — aeroplanes

ED Decision 2022/005/R

BASIC FUEL SCHEME — DESTINATION AERODROMES — PBN OPERATIONS

- (a) Point (a) of [AMC1 CAT.OP.MPA.182\(f\)](#) applies only to destination alternate aerodromes in flights that require a destination alternate aerodrome. A take-off or an ERA aerodrome with instrument approach procedures that rely on a GNSS may be planned without restrictions. A destination aerodrome with all instrument approach procedures that rely solely on a GNSS may be used without a destination alternate aerodrome if the conditions for a flight without a destination alternate aerodrome are met.
- (b) The term ‘sufficient means are available to navigate to and land at’ means that the procedure can be used in the planning stage and should comply with planning minima requirements.

CAT.OP.MPA.185 Fuel/energy scheme — in-flight fuel/energy management policy — aeroplanes

Regulation (EU) 2021/1296

- (a) The operator shall establish procedures for in-flight fuel/energy management that ensure:
- (1) continual validation of the assumptions made during the planning stage (pre-flight or in-flight re-planning, or both);
 - (2) re-analysis and adjustment, if necessary;
 - (3) that the amount of usable fuel/energy remaining on board is protected and not less than the fuel/energy that is required to proceed to an aerodrome where a safe landing can be made; and
 - (4) relevant fuel/energy data for the purpose of points (1), (2), and (3) shall be recorded.
- (b) The operator shall have procedures in place to require the commander to obtain delay information from a reliable source when unforeseen circumstances may result in landing at the destination aerodrome with less than the final reserve fuel/energy plus any:
- (1) fuel/energy to proceed to an alternate aerodrome, if required; or

- (2) fuel/energy required to proceed to an isolated aerodrome.
- (c) The commander shall advise air traffic control (ATC) of a 'minimum fuel/energy' state by declaring 'MINIMUM FUEL' when the commander has:
 - (1) committed to land at a specific aerodrome; and
 - (2) calculated that any change to the existing clearance to that aerodrome may result in landing with less than the planned final reserve fuel/energy.
- (d) The commander shall declare a situation of 'fuel/energy emergency' by broadcasting 'MAYDAY MAYDAY MAYDAY FUEL' when the usable fuel/energy that is calculated to be available upon landing at the nearest aerodrome where a safe landing can be made is less than the planned final reserve fuel/energy.

AMC1 CAT.OP.MPA.185(a) Fuel/energy scheme — in-flight fuel/energy management policy — aeroplanes

ED Decision 2022/005/R

BASIC FUEL SCHEME — PROCEDURES FOR IN-FLIGHT FUEL MANAGEMENT

- (a) In-flight fuel checks
 - (1) The operator should establish a procedure to ensure that in-flight fuel checks are carried out at regular intervals or at specified points indicated in the operational flight plan (one check at least every 60 minutes).
 - (2) The remaining usable fuel should be evaluated to:
 - (i) compare the actual consumption with the planned consumption;
 - (ii) check that the remaining usable fuel is sufficient to complete the flight, in accordance with point (b); and
 - (iii) determine the usable fuel that is expected to remain upon landing at the destination aerodrome.
 - (3) In relation to the recording of relevant data, the operator should:
 - (i) agree with the competent authority on what constitutes relevant data for the purpose of recording;
 - (ii) use the relevant data as safety performance indicators (SPIs) of the current fuel scheme; and
 - (iii) ensure that the recorded data is stored for at least 2 years.

The operator should establish a procedure for the data to be de-identified to a level that ensures the implementation of a 'just culture'.
- (b) In-flight fuel management
 - (1) The flight should be conducted to ensure that the usable fuel expected to remain upon landing at the destination aerodrome is not less than:
 - (i) the required alternate fuel plus the FRF; or
 - (ii) the FRF if no alternate aerodrome is required.
 - (2) If an in-flight fuel check shows that the usable fuel expected to remain upon landing at the destination aerodrome is less than:

- (i) the required alternate fuel plus the FRF, the commander should request delay information from the ATC, and take into account the prevailing traffic and operational conditions at the destination aerodrome, at the destination alternate aerodrome, and at any other adequate aerodrome, to decide whether to proceed to the destination aerodrome or to divert in order to perform a safe landing with not less than the FRF; or
 - (ii) the FRF, if no destination alternate aerodrome is required, the commander should take appropriate action and proceed to an aerodrome where a safe landing can be made with not less than the FRF.
- (c) The use of fuel after flight commencement for objectives other than the ones originally intended during pre-flight planning should require reanalysis and, if applicable, adjustment of the planned operation.

AMC2 CAT.OP.MPA.185(a) Fuel/energy scheme — in-flight fuel/energy management policy — aeroplanes

ED Decision 2022/005/R

BASIC FUEL SCHEME WITH VARIATIONS — PROCEDURES FOR IN-FLIGHT FUEL MANAGEMENT

- (a) In addition to [AMC1 CAT.OP.MPA.185\(a\)](#) and in the context of point (d) of [AMC6 CAT.OP.MPA.181](#), if the RCF procedure is used on a flight to proceed to destination 1 aerodrome, the commander should ensure that the remaining usable fuel at the decision point is at least the total of the following:
- (1) trip fuel from the decision point to destination 1 aerodrome;
 - (2) contingency fuel that is equal to 5 % of the trip fuel from the decision point to destination 1 aerodrome;
 - (3) destination 1 aerodrome alternate fuel if a destination 1 alternate aerodrome is required;
 - (4) additional fuel, if required; and
 - (5) FRF.
- (b) In addition to [AMC1 CAT.OP.MPA.185\(a\)](#), on a flight to an isolated aerodrome, the commander should ensure that the remaining usable fuel at the actual PNR is at least the total of the following:
- (1) trip fuel from the PNR to the destination isolated aerodrome;
 - (2) contingency fuel from the PNR to the destination isolated aerodrome; and
 - (3) the additional fuel required for isolated aerodromes, as described in [AMC7 CAT.OP.MPA.182](#).

AMC3 CAT.OP.MPA.185(a) Fuel/energy scheme — in-flight fuel/energy management policy — aeroplanes

ED Decision 2022/005/R

INDIVIDUAL FUEL SCHEME — COMMITTING TO LAND AT A SPECIFIC AERODROME

The operator should provide relevant safety information to the commander before the commander decides to commit to land at a specific aerodrome.

CAT.OP.MPA.190 Fuel/energy scheme – helicopters

Regulation (EU) 2021/1296

- (a) The operator shall establish, implement, and maintain a fuel/energy scheme that comprises:
 - (1) a fuel/energy planning and in-flight re-planning policy; and
 - (2) an in-flight fuel/energy management policy.
- (b) The fuel/energy scheme shall:
 - (1) be appropriate for the type(s) of operation performed; and
 - (2) correspond to the capability of the operator to support its implementation.
- (c) The fuel/energy scheme and any change to it shall require prior approval by the competent authority.

CAT.OP.MPA.191 Fuel/energy scheme – Fuel/energy planning and in-flight re-planning policy – helicopters

Regulation (EU) 2021/1296

- (a) As part of the fuel/energy scheme, the operator shall establish a fuel/energy planning and in-flight re-planning policy to ensure that the aircraft carries a sufficient amount of usable fuel/energy to safely complete the planned flight and to allow for deviations from the planned operation.
- (b) The operator shall ensure that the fuel/energy planning of flights is based upon at least the following elements:
 - (1) procedures contained in the operations manual as well as:
 - (i) current aircraft-specific data derived from a fuel/energy consumption monitoring system; or
 - (ii) data provided by the aircraft manufacturer; and
 - (2) the operating conditions under which the flight is to be conducted including:
 - (i) aircraft fuel/energy consumption data;
 - (ii) anticipated masses;
 - (iii) anticipated meteorological conditions;
 - (iv) the effects of deferred maintenance items or of configuration deviations, or both; and
 - (v) procedures and restrictions introduced by air navigation service providers.
- (c) The operator shall ensure that the pre-flight calculation of the usable fuel/energy that is required for a flight includes:
 - (1) taxi fuel/energy, which shall not be less than the amount expected to be used prior to take-off;
 - (2) trip fuel/energy;
 - (3) contingency fuel/energy;
 - (4) destination alternate fuel/energy if a destination alternate aerodrome is required;

- (5) final reserve fuel/energy, which shall not be less than:
 - (i) if flying under visual flight rules (VFR) and navigating by day with reference to visual landmarks, 20-minute fuel/energy at best-range speed; or
 - (ii) if flying under VFR and navigating by means other than by reference to visual landmarks or at night, 30-minute fuel/energy at best-range speed; or
 - (iii) if flying under instrument flight rules (IFR), 30-minute fuel/energy at holding speed at 1 500 ft (450m) above the aerodrome elevation in standard conditions, calculated according to the helicopter estimated mass on arrival at the destination alternate aerodrome or at the destination aerodrome when no destination alternate aerodrome is required;
 - (6) extra fuel/energy, to take into account anticipated delays or specific operational constraints; and
 - (7) discretionary fuel/energy, if required by the commander.
- (d) The operator shall ensure that if a flight has to proceed along a route or to a destination aerodrome other than the ones originally planned, in-flight re-planning procedures for calculating the required usable fuel/energy include:
- (1) trip fuel/energy for the remainder of the flight;
 - (2) reserve fuel/energy consisting of:
 - (i) contingency fuel/energy;
 - (ii) alternate fuel/energy if a destination alternate aerodrome is required;
 - (iii) final reserve fuel/energy; and
 - (iv) additional fuel/energy, if required by the type of operation;
 - (3) extra fuel/energy, to take into account anticipated delays or specific operational constraints; and
 - (4) discretionary fuel/energy, if required by the commander.
- (e) As an alternative to points (b) to (d), for helicopters with a maximum certified take-off mass (MCTOM) of 3 175 kg or less, flying by day and over routes navigated by reference to visual landmarks, or for local helicopter operations (LHO), the fuel/energy policy shall ensure that on completion of the flight, or series of flights, the final reserve fuel/energy is sufficient for:
- (1) 30-minute flying time at best-range speed; or
 - (2) 20-minute flying time at best-range speed, if operating within an area providing continuous and suitable operating sites.

AMC1 CAT.OP.MPA.191(b)&(c) Fuel/energy scheme — fuel/energy planning and in-flight re-planning policy — helicopters

ED Decision 2022/005/R

PLANNING CRITERIA

- (a) The pre-flight calculation of the required usable fuel to be carried on board should include the following:

- (1) taxi fuel, which should take into account local conditions at the departure site and the APU consumption;
- (2) trip fuel, which should include fuel:
 - (i) for take-off and climb from the departure site elevation to the initial cruising level/altitude, taking into account the expected departure routing;
 - (ii) from the top of climb to the top of descent, including any step climb/descent;
 - (iii) from the top of descent to the point where the approach procedure is initiated, taking into account the expected arrival procedure; and
 - (iv) for the approach and landing at the destination site;
- (3) contingency fuel, which should be:
 - (i) for IFR flights, or for VFR flights in a hostile environment, 10 % of the planned trip fuel; or
 - (ii) for VFR flights in a non-hostile environment, 5 % of the planned trip fuel;
- (4) alternate fuel, which should be:
 - (i) fuel for a missed approach from the applicable DA/H or MDA/H at the destination to the missed-approach altitude, taking into account the complete missed approach procedure;
 - (ii) fuel for climb from the missed approach altitude to the cruising level/altitude;
 - (iii) fuel for the cruise from the top of climb to the top of descent;
 - (iv) fuel for descent from the top of descent to the point where the approach is initiated, taking into account the expected arrival procedure;
 - (v) fuel for the approach and landing at the destination alternate that is selected in accordance with point [CAT.OP.MPA.192](#); and
 - (vi) for helicopters operating to or from helidecks that are located in a hostile environment, 10 % of points (a)(4)(i) to (a)(4)(v);
- (5) FRF;
- (6) extra fuel if there are anticipated delays or specific operational constraints; and
- (7) discretionary fuel, which should be at the sole discretion of the commander.

(b) Reduced contingency fuel (RCF) IFR procedure

If the operator's fuel scheme includes pre-flight planning to a destination 1 aerodrome (commercial destination) with an RCF procedure using a decision point along the route and a destination 2 aerodrome (optional refuelling destination), the pre-flight calculation of the required usable fuel should be according to points (b)(1) or (b)(2), whichever is greater:

- (1) the sum of:
 - (i) taxi fuel;
 - (ii) trip fuel to the destination 1 aerodrome via the decision point;
 - (iii) contingency fuel equal to not less than 10 % of the estimated fuel consumption from the decision point to the destination 1 aerodrome;
 - (iv) alternate fuel;

- (v) FRF;
 - (vi) extra fuel if there are anticipated delays or specific operational constraints; and
 - (vii) discretionary fuel, which should be at the sole discretion of the commander; or
- (2) the sum of:
- (i) taxi fuel;
 - (ii) trip fuel to the destination 2 aerodrome via the decision point;
 - (iii) contingency fuel equal to not less than 10 % of the estimated fuel consumption from the decision point to the destination 2 aerodrome;
 - (iv) alternate fuel, if a destination 2 alternate aerodrome is required;
 - (v) FRF;
 - (vi) extra fuel if there are anticipated delays or specific operational constraints; and
 - (vii) discretionary fuel, which should be at the sole discretion of the commander.
- (c) Isolated aerodrome IFR procedure
- If the operator's fuel policy includes planning to fly to an isolated aerodrome under IFR or under VFR over routes not navigated by reference to visual landmarks, for which a destination alternate does not exist, the pre-flight calculation of the required usable fuel should include:
- (1) taxi fuel;
 - (2) trip fuel;
 - (3) contingency fuel calculated in accordance with point (a)(3);
 - (4) additional fuel to fly for 2 hours at holding speed, including FRF; and
 - (5) extra fuel if there are anticipated delays or specific operational constraints; and
 - (6) discretionary fuel, which should be at the sole discretion of the commander.
- (d) Sufficient fuel should be carried at all times to ensure that following the failure of an engine that occurs at the most critical point along the route, the helicopter is able to:
- (1) descend as necessary and proceed to an adequate aerodrome;
 - (2) hold for 15 minutes at 1 500 ft (450 m) above aerodrome elevation in standard conditions; and
 - (3) make an approach and land.

CAT.OP.MPA.192 Selection of aerodromes and operating sites – helicopters

Regulation (EU) 2021/1296

- (a) For flights under instrument meteorological conditions (IMC), the operator shall select a take-off alternate aerodrome within one-hour flying time at normal cruising speed if it is not possible to return to the site of departure for meteorological reasons.
- (b) At the planning stage, for each instrument flight rules (IFR) flight, the operator shall select and specify in the operational and air traffic services (ATS) flight plans one or more aerodromes or

operating sites so that two safe-landing options are available during normal operation, except as provided for under point [SPA.HOFO.120\(b\)](#).

- (c) The operator shall apply appropriate safety margins to flight planning to take into account a possible deterioration of the available forecast meteorological conditions at the estimated time of landing.
- (d) For each IFR flight, the operator shall ensure that sufficient means are available to navigate to and land at the destination aerodrome or at any destination alternate aerodrome in the event of loss of capability for the intended approach and landing operation.

AMC1 CAT.OP.MPA.192 Selection of aerodromes and operating sites — helicopters

ED Decision 2022/005/R

PLANNING MINIMA AND SAFETY MARGINS FOR A DESTINATION AERODROME AND SELECTION OF ALTERNATE AERODROMES

- (a) When selecting the destination aerodrome, the operator should ensure that one of the following conditions is met:
 - (1) for a land destination, the duration of the flight and the prevailing meteorological conditions are such that during a period commencing 1 hour before and ending 1 hour after the estimated time of arrival at the aerodrome or operating site, an approach and landing is possible under VMC from the minimum safe altitude at the IAF or before;
 - (2) for a land destination:
 - (i) the available current meteorological information indicates that the following meteorological conditions at the destination aerodrome will exist from 2 hours before to 2 hours after the estimated time of arrival, or from the actual time of departure to 2 hours after the estimated time of arrival, whichever is shorter:
 - (A) a ceiling of at least 120 m (400 ft) above the DA/H or MDA/H of the instrument approach procedure; and
 - (B) visibility of at least 3 000 m;
 - (ii) a runway and two published instrument approaches with independent navigation aids are available at the aerodrome of intended landing; and
 - (iii) fuel planning is based upon the approach procedure that requires the most fuel, and 15-minute fuel is added to the trip fuel;
 - (3) one destination alternate aerodrome is selected, and the appropriate weather reports and/or forecasts indicate that during a period commencing 1 hour before and ending 1 hour after the estimated time of arrival at the destination, the weather conditions at the destination will be at or above the applicable planning minima as follows:
 - (i) RVR or VIS specified in accordance with point [CAT.OP.MPA.110](#); and
 - (ii) for type A instrument approach operations, ceiling at or above (M)DH;
 - (4) one destination alternate aerodrome is selected, and based on the meteorological information that is obtained in accordance with the procedures of the operations manual (OM), there is a reasonable probability of landing at the destination;
 - (5) two destination alternate aerodromes are selected; or

- (6) the destination aerodrome is isolated, and the appropriate weather reports and/or forecasts indicate that during a period commencing 1 hour before and ending 1 hour after the estimated time of arrival at the destination, the weather conditions at the destination will be at or above the applicable planning minima defined in Table 1.
- (b) The operator should specify any alternate aerodrome(s) in the operational flight plan.
- (c) If the site of intended landing is isolated and no alternate aerodrome is available, a PNR should be determined.

PLANNING MINIMA FOR DESTINATION ALTERNATE AERODROMES AND ISOLATED AERODROMES

- (d) The operator should select the destination alternate aerodrome(s) only if the appropriate weather reports and/or forecasts indicate that during a period commencing 1 hour before and ending 1 hour after the estimated time of arrival at the aerodrome or operating site, the weather conditions will be at or above the applicable planning minima as follows:
- (1) if the destination aerodrome is selected by meeting the conditions in points (a)(3) or (a)(5), the planning minima for the destination alternate aerodrome(s) and an isolated aerodrome are as shown in Table 1:

Table 1 — Planning minima for a destination alternate aerodrome and an isolated aerodrome

Type of approach	Planning minima
Type A or type B	RVR/VIS + 400 m Ceiling at or above (M)DH + 200 ft
VFR or visual approach	VFR from a position on the instrument flight path to the destination alternate aerodrome

or

- (2) if the destination aerodrome is selected by meeting the condition in point (a)(4), the planning minima for the destination alternate aerodrome(s) are as shown in Table 2:

Table 2 — Planning minima for a destination alternate aerodrome with a reasonable probability of landing at the destination

Type of approach	Planning minima
Type A or type B	RVR/VIS + 800 m (M)DH + 400 ft
VFR or visual approach	VFR from a position on the instrument flight path to the destination alternate aerodrome

DETERMINATION OF THE METEOROLOGICAL CONDITIONS FOR A SAFE LANDING AT THE DESTINATION

- (e) To assess the probability of landing at the destination, when flying under IFR to heliports/operating sites without the meteorological information from a certified service provider, the operator should use supplemental meteorological information, or the operator should select two destination alternates. Such meteorological information is usually available at aerodromes. In Europe, the certification of service providers is based on Annex V (Part-MET) to [Regulation \(EU\) 2017/373](#). In addition, all the following conditions should be met:
- (1) The operator should establish a system for observing and assessing the weather, as well as for distributing meteorological information.
- (2) The operator should describe in the OM the system defined in point (1).

- (3) The operator should assess the weather at the destination aerodrome, and if different, also at the location of the instrument approach. The assessment should be based on the following:
 - (i) an appropriate weather forecast at an aerodrome where it is reasonable to expect that the local conditions are not significantly different from the conditions at the destination and the location of the instrument approach;
 - (ii) if the aerodrome described in point (e)(3)(i) is farther than 15 NM away from the location of the approach and the destination, the following conditions should be met:
 - (A) supplemental meteorological information should be available and confirm that the current weather conditions at destination and at the location of the instrument approach are expected to remain similar to the conditions at the aerodrome described in point (e)(3)(i); and
 - (B) low-level area forecasts should confirm that the weather is expected to remain similar at destination and at the aerodrome used for the weather assessment, at the expected time of landing; and
 - (iii) any risk of adverse local weather condition forecast in the low-level area forecasts and relevant to the destination and the location of the instrument approach.
- (4) The following should qualify as supplemental meteorological information:
 - (i) a reliable, timestamped image from a serviceable digital camera of known location, bearing, and altitude, which shows the weather conditions in the approach path at destination;
 - (ii) a meteorological observation from a properly trained observer; and
 - (iii) a report from non-certified automatic weather observation systems to which the operator should apply relevant margins based on the reliability and precision of the system.
- (5) The operator should establish that there is a reasonable probability of landing at the destination only if the flight time to the destination and then to the alternate aerodrome is less than 3 hours, and if according to the assessment described in point (e)(3), during a period commencing 1 hour before and ending 1 hour after the estimated time of arrival at the location of the approach, the following conditions are met:
 - (i) the weather conditions will be at or above the planning minima for the approach; and
 - (ii) if the location of the approach is different from that of the destination aerodrome, the weather conditions will allow to continue the flight to the destination.
- (6) Weather observations from the aerodrome described in point (e)(3)(i), or the supplemental meteorological information that is described in point (e)(4), should be available, be no more than 30 minutes old, and be used to assess approach and landing conditions in accordance with point [CAT.OP.MPA.300](#).
- (7) The weather observations or information that are described in point (e)(6) may be transmitted to the flight crew using installed equipment, a T-PED, radio communication with trained personnel, or any equivalent means.

- (8) The operator should store the weather assessments established in point (e)(3) and the weather observations referred to in point (e)(6) for a period of 3 months.
- (9) In case a landing at the destination is not possible due to the weather, even though it was assessed that it would be, the operator should investigate and take all necessary measures to improve future weather assessments.

AMC1 CAT.OP.MPA.192(a) Selection of aerodromes and operating sites — helicopters

ED Decision 2022/005/R

PLANNING MINIMA FOR TAKE-OFF ALTERNATE AERODROMES

The operator should select an aerodrome or landing site as a take-off alternate aerodrome or landing site only when the appropriate weather reports and/or forecasts indicate that during a period commencing 1 hour before and ending 1 hour after the estimated time of arrival at the take-off alternate aerodrome or landing site, the weather conditions will be at or above the applicable landing minima specified in accordance with point [CAT.OP.MPA.110](#). The ceiling should be taken into account when the only available approach operations are type A. Any limitations related to OEI operations should be also taken into account.

GM1 CAT.OP.MPA.192(c)&(d) Selection of aerodromes and operating sites — helicopters

ED Decision 2022/005/R

METEOROLOGICAL INFORMATION

- (a) Meteorological data conforms to ICAO Annex 3 and to Annex V (Part-MET) to [Regulation \(EU\) 2017/373](#). As the following meteorological data is point specific, caution should be exercised when associating it with nearby aerodromes (or helidecks).
- (b) METARs
 - (1) Routine and special meteorological observations at offshore installations should be made during periods and at a frequency agreed between the competent authority of the meteorological services provider and the operator concerned. They should conform to points MET.TR.200 and MET.TR.205 of Part-MET, including the desirable accuracy of observations, which is specified in GM2 MET.TR.210.
 - (2) Routine and selected special reports are exchanged between meteorological offices in the METAR (aerodrome routine meteorological report) or SPECI (aerodrome special meteorological report) code forms that are prescribed by the World Meteorological Organization.
- (c) Aerodrome forecasts (TAFs)
 - (1) The aerodrome forecast consists of a concise statement of the expected meteorological conditions at an aerodrome and any significant changes expected to occur during a specified period of validity, which is usually not less than 9 hours, and not more than 30 hours. The forecast includes surface wind, visibility, weather and cloud, and expected changes of one or more of these elements during the period. Additional elements may be included as agreed between the meteorological authority and the operators concerned. Where these forecasts relate to offshore installations, barometric pressure

and temperature should be included to facilitate the planning of helicopter landing and take-off performance.

- (2) Aerodrome forecasts are most commonly exchanged in the TAF code form, and the detailed description of an aerodrome forecast is promulgated in point MET.TR.220 of Part-MET, together with the operationally desirable accuracy elements that are specified in GM3 MET.TR.220.
- (d) Landing forecasts (TRENDS)
- (1) The landing forecast consists of a concise statement that indicates any significant changes expected to occur at an aerodrome during the 2-hour period immediately following the time of the observation to which it is appended. It contains one or more of the following meteorological elements: surface wind, visibility, weather phenomena, clouds, and other significant information, such as barometric pressure and temperature, as may be agreed between the meteorological authority and the operators concerned.
 - (2) The detailed description of the landing forecast is promulgated in point MET.TR.225 of Part-MET, together with the operationally desirable accuracy of the forecast elements. In particular, the value of the observed cloud height and visibility elements should remain within $\pm 30\%$ of the forecast values in 90% of the cases.
 - (3) Landing forecasts most commonly take the form of a TREND forecast appended to a local routine report, local special report, METAR, or SPECI.

GM2 CAT.OP.MPA.192(c)&(d) Selection of aerodromes and operating sites — helicopters

ED Decision 2022/005/R

SUPPLEMENTAL METEOROLOGICAL INFORMATION USING DIGITAL IMAGERY

- (a) One or more digital images from a digital camera may be considered as supplemental meteorological information if the following criteria are met:
 - (1) the camera has a known altitude, azimuth, elevation, and field of view; if pan, tilt or zoom functions are available, the image includes the elevation, azimuth, and an indication of how much the image is zoomed;
 - (2) the camera is robustly fixed to a solid surface and protected from deliberate or accidental interference; it is secured from the effects of wind and precipitation;
 - (3) the digital image contains date and timestamp information or other means to ensure that the image is up to date; and
 - (4) the digital image has a clearly specified update frequency.
- (b) If the operator uses the digital image to assess ceiling and visibility, the operator should document the height, bearing, and distance of clearly distinguishable features, and provide a reference image taken on a clear day with negligible cloud or mist.
- (c) The operator may achieve the purpose of point (b) with a selectable reference image or a selectable data layer to be superposed on the image. Any selectable reference image should clearly indicate that it is a reference image, and not a current image.
- (d) If the operator uses night-time digital images, the quality of those images should remain sufficient to be compared to the reference image, and the darkness should not obscure the

distinguishable features described in point (b). This may be achieved by adapting the camera to the current luminosity.

- (e) If the digital image is stamped with the value of one or more weather parameters, there should be a means to ensure that each parameter is up to date and provided by a reliable and functional sensor; otherwise, that parameter should not be displayed.
- (f) If the camera is exposed to local meteorological conditions such as the foehn effect, the operator should document these local conditions, or the supplemental meteorological information should only be valid in the immediate vicinity of the camera.

AMC1 CAT.OP.MPA.192(d) Selection of aerodromes and operating sites — helicopters

ED Decision 2022/012/R

PBN OPERATIONS

- (a) To comply with [CAT.OP.MPA.192\(d\)](#), when the operator intends to use PBN, the operator should either:
 - (1) demonstrate that the GNSS is robust against loss of capability; or
 - (2) select an aerodrome as a destination alternate aerodrome only if an instrument approach procedure that does not rely on a GNSS is available either at that aerodrome or at the destination aerodrome.

GNSS ROBUSTNESS AGAINST LOSS OF CAPABILITY — HELICOPTERS

- (b) The operator may demonstrate robustness against the loss of capability of the GNSS if all of the following criteria are met:
 - (1) SBAS or GBAS are available and used.
 - (2) The failure of a single receiver or system should not compromise the navigation capability required for the intended instrument approach.
 - (3) The temporary jamming of all GNSS frequencies should not compromise the navigation capability required for the intended route. The operator should establish a procedure to deal with such cases unless other sensors are available to continue on the intended route.
 - (4) The duration of a jamming event should be determined as follows:
 - (i) Considering the average speed and height of a helicopter flight, the duration of a jamming event may be considered to be less than 2 minutes.
 - (ii) The time needed for the GNSS system to re-start and provide the aircraft position and navigation guidance should also be considered.
 - (iii) Based on (i) and (ii) above, the operator should establish the duration of the loss of GNSS navigation data due to jamming. This duration should be no less than 3 minutes, and may be no longer than 4 minutes.
 - (5) The operator should ensure resilience to jamming for the duration determined in (4) above, as follows:
 - (i) If the altitude of obstacles on both sides of the flight path is higher than the planned altitude for a given segment of the flight, the operator should ensure no excessive drift on either side by relying on navigation sensors such as an inertial system with performance in accordance with the intended function.

- (ii) If (i) does not apply and the operator cannot rely on sensors other than GNSS, the operator should develop a procedure to ensure that a drift from the intended route during the jamming event has no adverse consequences on the safety of the flight. This procedure may involve air traffic services.
- (6) The operator should ensure that no space weather event is predicted to disrupt the GNSS reliability and integrity at both the destination and the alternate aerodrome.
- (7) The operator should verify the availability of RAIM for all phases of flight based on GNSS, including navigation to the alternate aerodrome.
- (8) The operator's MEL should reflect the elements in points (b)(1) and (b)(2).

OPERATIONAL CREDITS

- (c) To comply with point [CAT.OP.MPA.192\(d\)](#), when the operator intends to use 'operational credits' (e.g. EFVS, SA CAT I, etc.), the operator should select an aerodrome as destination alternate aerodrome only if an approach procedure that does not rely on the same 'operational credit' is available either at that aerodrome or at the destination aerodrome.

GM1 CAT.OP.MPA.192(d) Selection of aerodromes and operating sites — helicopters

*ED Decision 2022/005/R***DESTINATION AND DESTINATION ALTERNATE AERODROMES — PBN OPERATIONS**

- (a) [AMC1 CAT.OP.MPA.192\(d\)](#) applies only to destination alternate aerodromes in flights that require a destination alternate aerodrome. A take-off or ERA aerodrome with instrument approach procedures that rely on a GNSS may be planned without restrictions. A destination aerodrome with all instrument approach procedures that rely solely on a GNSS may be used without a destination alternate aerodrome if the conditions for a flight without a destination alternate aerodrome are met.
- (b) The term 'available' means that the procedure can be used in the planning stage and should comply with planning minima requirements.

GM2 CAT.OP.MPA.192(d) Selection of aerodromes and operating sites — helicopters

*ED Decision 2022/012/R***GNSS ROBUSTNESS AGAINST LOSS OF CAPABILITY — HELICOPTERS**

- (a) Redundancy of on-board systems ensures that no single on-board equipment failure (e.g. antenna, GNSS receiver, FMS, or navigation display failure) results in the loss of the GNSS capability.
- (b) Any shadowing of the GNSS signal or jamming of all GNSS frequencies from the ground is expected to be of a very short duration and affect a very small area. Additional sensors or functions, such as inertial coasting, may be used during jamming events. Jamming should be considered on all segments of the intended route, including the approach.
- (c) The availability of GNSS signals can be compromised if space weather events cause 'loss of lock' conditions and more than one satellite signal may be lost on a given GNSS frequency. Until space weather forecasts are available, the operator may use 'nowcasts' as short-term predictions for helicopter flights of short durations.

- (d) SBAS also contributes to the mitigation of space weather effects, by both providing integrity messages and correcting ionosphere-induced errors.
- (e) Even though SBAS should be available and used, RAIM should remain available autonomously. In case of loss of SBAS, the route and the approach to the destination or alternate aerodrome should still be flown with an available RAIM function.
- (f) When available, GNSS based on more than one constellation and more than one frequency may provide better integrity and redundancy regarding failures in the space segment of GNSS, jamming, and resilience to space weather events.

CAT.OP.MPA.195 Fuel/energy scheme – in-flight fuel/energy management policy – helicopters

Regulation (EU) 2021/1296

- (a) The operator shall establish procedures to ensure that in-flight fuel/energy checks and fuel/energy management are performed.
- (b) The commander shall monitor the amount of usable fuel/energy remaining on board to ensure that it is protected and not less than the fuel/energy that is required to proceed to an aerodrome or operating site where a safe landing can be made.
- (c) The commander shall advise air traffic control (ATC) of a ‘minimum fuel/energy’ state by declaring ‘MINIMUM FUEL’ when the commander has:
 - (1) committed to land at an aerodrome or operating site; and
 - (2) calculated that any change to the existing clearance to that aerodrome or operating site, or other air traffic delays, may result in landing with less than the planned final reserve fuel/energy.
- (d) The commander shall declare a situation of ‘fuel/energy emergency’ by broadcasting ‘MAYDAY MAYDAY MAYDAY FUEL’ when the usable fuel/energy estimated to be available upon landing at the nearest aerodrome or operating site where a safe landing can be made is less than the planned final reserve fuel/energy.

AMC1 CAT.OP.MPA.195 Fuel/energy scheme — in-flight fuel/energy management policy — helicopters

ED Decision 2022/005/R

ENSURING A SAFE LANDING FOR COMPLEX MOTOR-POWERED HELICOPTERS IN OTHER THAN LOCAL OPERATIONS

The operator should base in-flight fuel management procedures on the following criteria:

- (a) in-flight fuel checks:
 - (1) the commander should establish a procedure to ensure that in-flight fuel checks are carried out at regular intervals; the remaining usable fuel should be recorded and evaluated to:
 - (i) compare the actual consumption with the planned consumption;
 - (ii) check that the remaining usable fuel is sufficient to complete the flight; and
 - (iii) determine the usable fuel that is expected to remain upon landing at the destination; and

- (2) the relevant fuel data should be recorded;
- (b) in-flight fuel management:
 - (1) if an in-flight fuel check shows that the usable fuel that is expected to remain upon landing at the destination is less than the required alternate fuel plus the FRF, the commander should:
 - (i) divert; or
 - (ii) replan the flight in accordance with point [SPA.HOFO.120\(b\)\(1\)](#) unless the commander considers it safer to proceed to the destination; and
 - (2) at an onshore destination, when two suitable, separate touchdown and lift-off areas are available at the destination, and the expected weather conditions at the destination are as specified for planning in point [CAT.OP.MPA.245\(a\)\(2\)](#), the commander may permit alternate fuel to be used before landing at the destination; and
- (c) if an in-flight fuel check on a flight to an isolated destination shows that the usable fuel expected to remain at the point of the last possible diversion is less than the sum of the following:
 - (1) trip fuel from the point of the last possible diversion to the destination isolated aerodrome;
 - (2) contingency fuel; and
 - (3) FRF, or the additional fuel required for isolated aerodromes,the commander should either divert or proceed to the destination, provided that at onshore destinations, two suitable, separate touchdown and lift-off areas are available at the destination, and the expected weather conditions at the destination are as specified for planning in point [CAT.OP.MPA.245\(a\)](#).

GM1 CAT.OP.MPA.195 Fuel/energy scheme — in-flight fuel/energy management policy — helicopters

ED Decision 2022/005/R

‘MINIMUM FUEL’ DECLARATION

- (a) The ‘MINIMUM FUEL’ declaration informs the ATC that all planned landing-site options have been reduced to a specific aerodrome or operating site of intended landing. It also informs the ATC that no other operating site is available, and that any change to the existing clearance, or air traffic delays, may result in landing with less than the planned FRF. This is not an emergency situation but an indication that an emergency situation is possible, should any additional delay occur.

SAFE LANDING — final reserve fuel PROTECTION

- (b) The protection of the FRF is intended to ensure that a safe landing is made at any aerodrome or operating site when unforeseen circumstances may not allow to safely complete the operation, as originally planned.
- (c) When the FRF can no longer be protected, then a fuel emergency needs to be declared, as per point [CAT.OP.MPA.195\(d\)](#), and any landing option explored, including deviating from rules, operational procedures, and methods in the interest of safety (as per point [CAT.GEN.MPA.105\(b\)](#)).

- (d) The 'MAYDAY MAYDAY MAYDAY FUEL' declaration informs the ATC that all available landing options have been reduced to a specific landing site, and that an FRF portion may be consumed prior to landing.

CAT.OP.MPA.200 Special refuelling or defuelling of the aircraft

Regulation (EU) 2021/1296

- (a) Special refuelling or defuelling shall only be conducted if the operator:
- (1) has performed a risk assessment;
 - (2) has developed procedures; and
 - (3) has established a training programme for its personnel involved in such operations.
- (b) Special refuelling or defuelling applies to:
- (1) refuelling with an engine running or rotors turning;
 - (2) refuelling/defuelling with passengers embarking, on board, or disembarking; and
 - (3) refuelling/defuelling with wide-cut fuel.
- (c) For aeroplanes, any special refuelling or defuelling procedures and any change to them shall require prior approval by the competent authority.
- (d) For helicopters, refuelling procedures with rotors turning and any change to them shall require prior approval by the competent authority.

AMC1 CAT.OP.MPA.200 Special refuelling or defueling of the aircraft

ED Decision 2022/005/R

REFUELLING WITH AN ENGINE RUNNING — AEROPLANES

- (a) Refuelling with an engine running should only be conducted:
- (1) when there are no other sources of electrical or pneumatic power to start the engine if shut down;
 - (2) in accordance with the specific procedures established by the type certificate (TC) holder of the aeroplane;
 - (3) with aeroplanes that use JET A, JET A-1 or TS-1 fuel types or any other fuel type that has a flash point above 38 °C and is approved by the operators' competent authority;
 - (4) with no passengers embarking, on board, or disembarking;
 - (5) with permission from the aerodrome operator; and
 - (6) in the presence of the aerodrome rescue and firefighting services (RFFSs).
- (b) The operator should assess the risks associated with refuelling with an engine running and establish appropriate procedures to be followed by all involved personnel, such as flight crew, cabin crew, and ground operations personnel. These procedures should be specified in the OM.

AMC2 CAT.OP.MPA.200 Special refuelling or defueling of the aircraft

ED Decision 2022/005/R

OPERATIONAL PROCEDURES for REFUELLING WITH AN ENGINE RUNNING — AEROPLANES

- (a) To reduce the likelihood of conducting refuelling with an engine running, the operator should include in the MEL an operational procedure for dispatch criteria in case of an unserviceable APU, if applicable, to prevent a flight from being dispatched to an aerodrome where no suitable ground support equipment is available.
- (b) Appropriate training should be provided to flight crew and maintenance/ground operations personnel that are involved in refuelling with one engine running, as well as to cabin crew, if present on board.

AMC3 CAT.OP.MPA.200 Special refuelling or defueling of the aircraft

ED Decision 2022/005/R

REFUELLING WITH THE ENGINE(S) RUNNING AND/OR ROTORS TURNING — HELICOPTERS

- (a) Refuelling with the engine(s) running and/or rotors turning should only be conducted:
 - (1) with no passengers or technical-crew members embarking or disembarking;
 - (2) if the operator of the aerodrome/operating site allows such operations;
 - (3) in accordance with any specific procedures and limitations in the AFM;
 - (4) using JET A or JET A-1 fuel types; and
 - (5) in the presence of the appropriate rescue and firefighting (RFF) facilities or equipment.
- (b) In addition, operational procedures in the OM should specify that at least the following precautions are taken:
 - (1) all necessary information should be exchanged in advance with the aerodrome operator, operating-site operator, and refuelling operator;
 - (2) the procedures to be used by crew members should be defined;
 - (3) the procedures to be used by the operator's ground operations personnel that may be in charge of refuelling or assisting in emergency evacuations should be described;
 - (4) the operator's training programmes for crew members and for the operator's ground operations personnel should be described;
 - (5) the minimum distance between the helicopter turning parts and the refuelling vehicle or installations should be defined when the refuelling takes place outside an aerodrome or at an aerodrome where there are no such limitations;
 - (6) besides any RFFSs that are required to be available by aerodrome regulations, an additional handheld fire extinguisher with the equivalent of 5 kg of dry powder should be immediately available and ready for use;
 - (7) a means for a two-way communication between the crew and the person in charge of refuelling should be defined and established;
 - (8) if fuel vapour is detected inside the helicopter, or any other hazard arises, refuelling/defuelling should be stopped immediately;
 - (9) one pilot should stay at the controls, constantly monitor the refuelling, and be ready to shut off the engines and evacuate at all times; and

- (10) any additional precautions should be taken, as determined by the risk assessment.

AMC4 CAT.OP.MPA.200 Special refuelling or defueling of the aircraft

ED Decision 2022/005/R

OPERATIONAL PROCEDURES — PASSENGERS ON BOARD for REFUELLING WITH THE ENGINE(S) RUNNING AND/OR ROTORS TURNING — HELICOPTERS

In addition to [AMC3 CAT.OP.MPA.200](#), for refuelling with passengers on board, operational procedures in the OM should specify that at least the following precautions are taken:

- (a) the positioning of the helicopter and the corresponding helicopter evacuation strategy should be defined taking into account the wind as well as the refuelling facilities or vehicles;
- (b) on a heliport, the ground area beneath the exits that are intended for emergency evacuation should be kept clear;
- (c) an additional passenger briefing as well as instructions should be defined, and the 'No smoking' signs should be on unless 'No smoking' placards are installed;
- (d) interior lighting should be set to enable identification of emergency exits;
- (e) the use of doors during refuelling should be defined: doors on the refuelling side should remain closed, while doors on the opposite side should remain unlocked or, weather permitting, open, unless otherwise specified in the AFM;
- (f) at least one suitable person capable of implementing emergency procedures for firefighting, communications, as well as for initiating and directing an evacuation, should remain at a specified location; this person should not be the qualified pilot at the controls or the person performing the refuelling; and
- (g) unless passengers are regularly trained in emergency evacuation procedures, an additional crew member or ground crew member should be assigned to assist in the rapid evacuation of the passengers.

AMC5 CAT.OP.MPA.200 Special refuelling or defueling of the aircraft

ED Decision 2022/005/R

REFUELLING OR DEFUELLING WITH PASSENGERS EMBARKING, ON BOARD OR DISEMBARKING

- (a) When passengers are embarking, on board, or disembarking, an aircraft should not be refuelled/defuelled with avgas (aviation gasoline) or wide-cut type fuel or a mixture of these types of fuel.
- (b) For all other types of fuel, the necessary precautions should be taken, and the aircraft should be properly manned by qualified personnel that should be ready to initiate and direct an evacuation of the aircraft by the most practical and expeditious means available.

AMC6 CAT.OP.MPA.200 Special refuelling or defueling of the aircraft

ED Decision 2022/005/R

OPERATIONAL PROCEDURES WITH PASSENGERS EMBARKING, ON BOARD OR DISEMBARKING — AEROPLANES

- (a) When refuelling/defuelling with passengers on board, ground servicing activities and work inside the aeroplane, such as catering and cleaning, should be conducted in such a manner that they do not create a hazard and allow emergency evacuation through those aisles and exits that are intended for emergency evacuation.

- (b) The deployment of integral aeroplane stairs or the opening of emergency exits are not necessarily a prerequisite to refuelling.
- (c) Operational procedures should specify that at least the following precautions are taken:
- (1) one qualified person should remain at a specified location during refuelling/defuelling operations with passengers on board, and be capable of using emergency procedures for fire protection and firefighting, communications, as well as for initiating and directing an evacuation;
 - (2) two-way communication should be established and remain available through the aeroplane's intercommunications system, or other suitable means, between the ground crew that supervises the refuelling and the qualified personnel on board the aeroplane; all involved personnel should remain within easy reach of the intercommunications system;
 - (3) crew, personnel, and passengers should be warned that refuelling/defuelling will take place;
 - (4) the 'FASTEN SEAT BELT' signs should be off;
 - (5) 'NO SMOKING' signs should be on, together with interior lighting to allow the identification of emergency exits;
 - (6) passengers should be instructed to unfasten their seat belts and refrain from smoking;
 - (7) the minimum required number of cabin crew should be on board and prepared for an immediate emergency evacuation;
 - (8) if fuel vapour is detected inside the aeroplane, or any other hazard arises, refuelling/defuelling should be stopped immediately;
 - (9) the ground area beneath the exits that are intended for emergency evacuation, as well as slide deployment areas, should be kept clear where stairs are not in position for use in the event of evacuation; and
 - (10) provision is made for a safe and rapid evacuation.

AMC7 CAT.OP.MPA.200 Special refuelling or defueling of the aircraft

ED Decision 2022/005/R

OPERATIONAL PROCEDURES FOR REFUELLING WITH PASSENGERS DISEMBARKING OR EMBARKING — HELICOPTERS WITH THE ENGINE(S) AND ROTORS STOPPED

When the helicopter engine(s) and rotors are stopped, the efficiency and speed of passengers disembarking from and re-embarking on board helicopters should be such that disembarking before refuelling and re-embarking after refuelling is the general practice, except for HEMS or air ambulance operations. However, if such operations are needed, the operator should refer to [AMC3 CAT.OP.MPA.200](#) and [AMC4 CAT.OP.MPA.200](#). Operational procedures to be described in the OM should specify that at least the relevant precautions referred to in the aforementioned AMC are taken.

AMC8 CAT.OP.MPA.200 Special refuelling or defueling of the aircraft

ED Decision 2022/005/R

REFUELLING OR DEFUELLING WITH WIDE-CUT FUEL

Refuelling/defuelling with wide-cut fuel should be conducted only if the operator has established appropriate procedures, taking into account the high risk of using wide-cut fuel types.

GM1 CAT.OP.MPA.200 Special refuelling or defueling of the aircraft

ED Decision 2022/005/R

OPERATIONAL PROCEDURES for REFUELLING WITH AN ENGINE RUNNING — AEROPLANES

For the purpose of refuelling with an engine running, the operator's procedures need to be aligned with the specific procedures laid down in the AFM. In case there are no specific procedures for refuelling with an engine running available in the AFM, the operator and the manufacturer may wish to cooperate to establish such procedures.

GM2 CAT.OP.MPA.200 Special refuelling or defueling of the aircraft

ED Decision 2022/005/R

RISK ASSESSMENT for REFUELLING WITH THE ENGINE(S) RUNNING AND/OR ROTORS TURNING — HELICOPTERS

The risk assessment should explain why it is not practical to refuel with the engine(s) and rotors stopped, identify any additional hazards, and describe how the additional risks are controlled. Helicopter emergency medical services (HEMS) and helicopter offshore operations (HOFO) are typical operations where the benefits should outweigh the risks if mitigation measures are taken.

Guidance on safe refuelling practices is contained in ICAO Doc 9137 Airport Services Manual, Parts 1 and 8.

The operators' risk assessment may include, but not be limited to, the following risks, hazards and mitigation measures:

- (a) risk related to refuelling with rotors turning;
- (b) risk related to the shutting down of the engines, including the risk of failures during start-up;
- (c) environmental conditions, such as wind limitations, displacement of exhaust gases, and blade sailing;
- (d) risk related to human factors and fatigue management, especially for single-pilot operations for long periods of time;
- (e) risk mitigation, such as the safety features of the fuel installation, RFF capability, number of personnel members available, ease of emergency evacuation of the helicopter, etc.;
- (f) assessment of the use of radio transmitting equipment;
- (g) determination of the use of passenger seat belts;
- (h) review of the portable electronic device (PED) policy; and
- (i) if passengers are to disembark, consideration of their disembarking before rather than after the refuelling; and
- (j) if passengers are to embark, consideration of their embarking after rather than before the refuelling.

GM3 CAT.OP.MPA.200 Special refuelling or defuelling of the aircraft

ED Decision 2022/005/R

PROCEDURES FOR REFUELLING/DEFUELLING WITH WIDE-CUT FUEL

- (a) 'Wide-cut fuel' (designated JET B, JP-4 or AVTAG) is an aviation turbine fuel that falls between gasoline and kerosene in the distillation range and consequently, compared to kerosene (JET A or JET A1), it has the properties of higher volatility (vapour pressure), lower flash point and lower freezing point.
- (b) Wherever possible, the operator should avoid the use of wide-cut fuel types. If a situation arises such that only wide-cut fuels are available for refuelling/defuelling, operators should be aware that mixtures of wide-cut fuels and kerosene turbine fuels can result in the air/fuel mixture in the tank being in the combustible range at ambient temperatures. The extra precautions set out below are advisable to avoid arcing in the tank due to electrostatic discharge. The risk of this type of arcing can be minimised by the use of a static dissipation additive in the fuel. When this additive is present in the proportions stated in the fuel specification, the normal fuelling precautions set out below are considered adequate.
- (c) Wide-cut fuel is considered to be 'involved' when it is being supplied or when it is already present in aircraft fuel tanks.
- (d) When wide-cut fuel has been used, this should be recorded in the technical log. The next two uplifts of fuel should be treated as though they too involved the use of wide-cut fuel.
- (e) When refuelling/defuelling with turbine fuels not containing a static dissipator, and where wide-cut fuels are involved, a substantial reduction on fuelling flow rate is advisable. Reduced flow rate, as recommended by fuel suppliers and/or aeroplane manufacturers, has the following benefits:
 - (1) it allows more time for any static charge build-up in the fuelling equipment to dissipate before the fuel enters the tank;
 - (2) it reduces any charge which may build up due to splashing; and
 - (3) until the fuel inlet point is immersed, it reduces misting in the tank and consequently the extension of the flammable range of the fuel.
- (f) The flow rate reduction necessary is dependent upon the fuelling equipment in use and the type of filtration employed on the aeroplane fuelling distribution system. It is difficult, therefore, to quote precise flow rates. Reduction in flow rate is advisable whether pressure fuelling or over-wing fuelling is employed.
- (g) With over-wing fuelling, splashing should be avoided by making sure that the delivery nozzle extends as far as practicable into the tank. Caution should be exercised to avoid damaging bag tanks with the nozzle.

CAT.OP.MPA.205 Push back and towing — aeroplanes

Regulation (EU) No 965/2012

Push back and towing procedures specified by the operator shall be conducted in accordance with established aviation standards and procedures.

AMC1 CAT.OP.MPA.205 Push back and towing — aeroplanes

ED Decision 2014/015/R

BARLESS TOWING

- (a) Barless towing should be based on the applicable SAE ARP (Aerospace Recommended Practices), i.e. 4852B/4853B/5283/5284/5285 (as amended).
- (b) Pre- or post-taxi positioning of the aeroplanes should only be executed by barless towing if one of the following conditions are met:
 - (1) an aeroplane is protected by its own design from damage to the nose wheel steering system;
 - (2) a system/procedure is provided to alert the flight crew that damage referred to in (b)(1) may have or has occurred;
 - (3) the towing vehicle is designed to prevent damage to the aeroplane type; or
 - (4) the aeroplane manufacturer has published procedures and these are included in the operations manual.

CAT.OP.MPA.210 Crew members at stations

Regulation (EU) No 965/2012

- (a) *Flight crew members*
 - (1) During take-off and landing each flight crew member required to be on duty in the flight crew compartment shall be at the assigned station.
 - (2) During all other phases of flight each flight crew member required to be on duty in the flight crew compartment shall remain at the assigned station, unless absence is necessary for the performance of duties in connection with the operation or for physiological needs, provided at least one suitably qualified pilot remains at the controls of the aircraft at all times.
 - (3) During all phases of flight each flight crew member required to be on duty in the flight crew compartment shall remain alert. If a lack of alertness is encountered, appropriate countermeasures shall be used. If unexpected fatigue is experienced, a controlled rest procedure, organised by the commander, may be used if workload permits. Controlled rest taken in this way shall not be considered to be part of a rest period for purposes of calculating flight time limitations nor used to justify any extension of the duty period.
- (b) *Cabin crew members*

During critical phases of flight, each cabin crew member shall be seated at the assigned station and shall not perform any activities other than those required for the safe operation of the aircraft.

AMC1 CAT.OP.MPA.210(b) Crew members at stations

ED Decision 2014/015/R

CABIN CREW SEATING POSITIONS

- (a) When determining cabin crew seating positions, the operator should ensure that they are:
 - (1) close to a floor level door/exit;

- (2) provided with a good view of the area(s) of the passenger cabin for which the cabin crew member is responsible; and
 - (3) evenly distributed throughout the cabin, in the above order of priority.
- (b) Item (a) should not be taken as implying that, in the event of there being more cabin crew stations than required cabin crew, the number of cabin crew members should be increased.

GM1 CAT.OP.MPA.210 Crew members at stations

ED Decision 2014/015/R

MITIGATING MEASURES — CONTROLLED REST

- (a) This GM addresses controlled rest taken by the minimum certified flight crew. It is not related to planned in-flight rest by members of an augmented crew.
- (b) Although flight crew members should stay alert at all times during flight, unexpected fatigue can occur as a result of sleep disturbance and circadian disruption. To cover for this unexpected fatigue, and to regain a high level of alertness, a controlled rest procedure in the flight crew compartment, organised by the commander may be used, if workload permits and a controlled rest procedure is described in the operations manual. 'Controlled rest' means a period of time 'off task' that may include actual sleep. The use of controlled rest has been shown to significantly increase the levels of alertness during the later phases of flight, particularly after the top of descent, and is considered to be good use of crew resource management (CRM) principles. Controlled rest should be used in conjunction with other on-board fatigue management countermeasures such as physical exercise, bright cockpit illumination at appropriate times, balanced eating and drinking, and intellectual activity.
- (c) Controlled rest taken in this way should not be considered to be part of a rest period for the purposes of calculating flight time limitations, nor used to justify any duty period. Controlled rest may be used to manage both sudden unexpected fatigue and fatigue that is expected to become more severe during higher workload periods later in the flight. Controlled rest is not related to fatigue management, which is planned before flight.
- (d) Controlled rest periods should be agreed according to individual needs and the accepted principles of CRM; where the involvement of the cabin crew is required, consideration should be given to their workload.
- (e) When applying controlled rest procedures, the commander should ensure that:
 - (1) the other flight crew member(s) is (are) adequately briefed to carry out the duties of the resting flight crew member;
 - (2) one flight crew member is fully able to exercise control of the aircraft at all times; and
 - (3) any system intervention that would normally require a cross-check according to multi-crew principles is avoided until the resting flight crew member resumes his/her duties.
- (f) Controlled rest procedures should satisfy all of the following criteria:
 - (1) Only one flight crew member at a time should take rest at his/her station; the restraint device should be used and the seat positioned to minimise unintentional interference with the controls.
 - (2) The rest period should be no longer than 45 minutes (in order to limit any actual sleep to approximately 30 minutes) to limit deep sleep and associated long recovery time (sleep inertia).

- (3) After this 45-minute period, there should be a recovery period of 20 minutes to overcome sleep inertia during which control of the aircraft should not be entrusted to the flight crew member. At the end of this recovery period, an appropriate briefing should be given.
- (4) In the case of two-crew operations, means should be established to ensure that the non-resting flight crew member remains alert. This may include:
 - (i) appropriate alarm systems;
 - (ii) on-board systems to monitor flight crew activity; and
 - (iii) frequent cabin crew checks. In this case, the commander should inform the senior cabin crew member of the intention of the flight crew member to take controlled rest, and of the time of the end of that rest; frequent contact should be established between the non-resting flight crew member and the cabin crew by communication means, and the cabin crew should check that the resting flight crew member is awake at the end of the period.
- (5) There should be a minimum of 20 minutes between two subsequent controlled rest periods in order to overcome the effects of sleep inertia and allow for adequate briefing.
- (6) If necessary, a flight crew member may take more than one rest period, if time permits, on longer sectors, subject to the restrictions above.
- (7) Controlled rest periods should terminate at least 30 minutes before the top of descent.

CAT.OP.MPA.215 Use of headset — aeroplanes

Regulation (EU) No 965/2012

- (a) Each flight crew member required to be on duty in the flight crew compartment shall wear a headset with boom microphone or equivalent. The headset shall be used as the primary device for voice communications with ATS:
 - (1) when on the ground:
 - (i) when receiving the ATC departure clearance via voice communication; and
 - (ii) when engines are running;
 - (2) when in flight:
 - (i) below transition altitude; or
 - (ii) 10 000 ft, whichever is higher;and
 - (3) whenever deemed necessary by the commander.
- (b) In the conditions of (a), the boom microphone or equivalent shall be in a position that permits its use for two-way radio communications.

CAT.OP.MPA.216 Use of headset — helicopters

Regulation (EU) No 965/2012

Each flight crew member required to be on duty in the flight crew compartment shall wear a headset with boom microphone, or equivalent, and use it as the primary device to communicate with ATS.

CAT.OP.MPA.220 Assisting means for emergency evacuation

Regulation (EU) No 965/2012

The operator shall establish procedures to ensure that before taxiing, take-off and landing and when safe and practicable to do so, all means of assistance for emergency evacuation that deploy automatically are armed.

CAT.OP.MPA.225 Seats, safety belts and restraint systems

Regulation (EU) No 965/2012

(a) Crew members

- (1) During take-off and landing, and whenever decided by the commander in the interest of safety, each crew member shall be properly secured by all safety belts and restraint systems provided.
- (2) During other phases of the flight, each flight crew member in the flight crew compartment shall keep the assigned station safety belt fastened while at his/her station.

(b) Passengers

- (1) Before take-off and landing, and during taxiing, and whenever deemed necessary in the interest of safety, the commander shall be satisfied that each passenger on board occupies a seat or berth with his/her safety belt or restraint system properly secured.
- (2) The operator shall make provisions for multiple occupancy of aircraft seats that is only allowed on specified seats. The commander shall be satisfied that multiple occupancy does not occur other than by one adult and one infant who is properly secured by a supplementary loop belt or other restraint device.

CAT.OP.MPA.230 Securing of passenger compartment and galley(s)

Regulation (EU) No 965/2012

- (a) The operator shall establish procedures to ensure that before taxiing, take-off and landing all exits and escape paths are unobstructed.
- (b) The commander shall ensure that before take-off and landing, and whenever deemed necessary in the interest of safety, all equipment and baggage are properly secured.

CAT.OP.MPA.235 Life-jackets — helicopters

Regulation (EU) No 965/2012

The operator shall establish procedures to ensure that, when operating a helicopter over water in performance class 3, account is taken of the duration of the flight and conditions to be encountered when deciding if life-jackets are to be worn by all occupants.

CAT.OP.MPA.240 Smoking on board

Regulation (EU) No 965/2012

The commander shall not allow smoking on board:

- (a) whenever considered necessary in the interest of safety;
- (b) during refuelling and defuelling of the aircraft;

- (c) while the aircraft is on the surface unless the operator has determined procedures to mitigate the risks during ground operations;
- (d) outside designated smoking areas, in the aisle(s) and lavatory(ies);
- (e) in cargo compartments and/or other areas where cargo is carried that is not stored in flame-resistant containers or covered by flame-resistant canvas; and
- (f) in those areas of the passenger compartment where oxygen is being supplied.

CAT.OP.MPA.245 Meteorological conditions — all aircraft

Regulation (EU) 2021/2237

- (a) On IFR flights, the commander shall only:
 - (1) commence the flight; or
 - (2) continue beyond the point from which a revised ATS flight plan applies in the event of in-flight re-planning,
when information is available indicating that the expected meteorological conditions, at the time of arrival, at the destination and/or required alternate aerodrome(s) are at or above the planning minima.
- (b) On IFR flights, the commander shall only continue towards the planned destination aerodrome when the latest information available indicates that, at the expected time of arrival, the meteorological conditions at the destination, or at least one destination alternate aerodrome, are at or above the applicable aerodrome operating minima.
- (c) On VFR flights, the commander shall only commence the flight when the appropriate meteorological reports and/or forecasts indicate that the meteorological conditions along the part of the route to be flown under VFR will, at the appropriate time, be at or above the VFR limits.

CAT.OP.MPA.246 Meteorological conditions — aeroplanes

Regulation (EU) 2021/2237

In addition to [CAT.OP.MPA.245](#), on IFR flights with aeroplanes, the commander shall only continue beyond:

- (a) the decision point when using the reduced contingency fuel/energy (RCF) procedure; or
- (b) point of no return when using the isolated aerodrome procedure,

when information is available indicating that the expected meteorological conditions, at the time of arrival, at the destination and/or required alternate aerodrome(s) are at or above the applicable aerodrome operating minima.

CAT.OP.MPA.247 Meteorological conditions — helicopters

Regulation (EU) 2021/2237

In addition to [CAT.OP.MPA.245](#):

- (a) On VFR flights overwater out of sight of land with helicopters, the commander shall only commence take-off when the appropriate meteorological reports and/or forecasts indicate that the ceiling will be above 600 ft by day or 1 200 ft by night.
- (b) [deleted with Reg. (EU) 2016/1199]

- (c) Flight with helicopters to a helideck or elevated FATO shall only be operated when the mean wind speed at the helideck or elevated FATO is reported to be less than 60 kt.

CAT.OP.MPA.250 Ice and other contaminants — ground procedures

Regulation (EU) No 965/2012

- (a) The operator shall establish procedures to be followed when ground de-icing and anti-icing and related inspections of the aircraft are necessary to allow the safe operation of the aircraft.
- (b) The commander shall only commence take-off if the aircraft is clear of any deposit that might adversely affect the performance or controllability of the aircraft, except as permitted under (a) and in accordance with the AFM.

GM1 CAT.OP.MPA.250 Ice and other contaminants — ground procedures

ED Decision 2021/005/R

TERMINOLOGY

Terms used in the context of de-icing/anti-icing have the meaning defined in the following subparagraphs.

- (a) 'Anti-icing': the process of protecting the aircraft to prevent contamination due to existing or expected weather, typically by applying anti-icing fluids on uncontaminated aircraft surfaces.
- (b) 'Anti-icing fluid' includes, but is not limited to, the following:
- (1) Typically, Type II, III or IV fluid (neat or diluted), normally applied unheated (*);
 - (2) Type I fluid/water mixture heated to minimum 60°C at the nozzle.
- (*) When de-icing and anti-icing in a one-step process, Type II and Type IV fluids are typically applied diluted and heated.
- (c) 'Clear ice': a coating of ice, generally clear and smooth, but with some air pockets. It forms on exposed objects, the temperatures of which are at, below or slightly above the freezing temperature, by the freezing of super-cooled drizzle, droplets or raindrops. Clear ice is very difficult to be detected visually.
- (d) 'Cold soaked surface frost (CSSF)': frost developed on cold soaked aircraft surfaces by sublimation of air humidity. This effect can take place at ambient temperatures above 0° C. Cold soaked aircraft surfaces are more common on aircraft that have recently landed. External surfaces of fuel tanks (e.g. wing skins) are typical areas of CSSF formation (known in this case as cold soaked fuel frost (CSFF)), due to the thermal inertia of very cold fuel that remains on the tanks after landing.
- (e) 'Conditions conducive to aircraft icing on the ground': freezing fog, freezing precipitation, frost, rain or high humidity (on cold soaked wings), hail, ice pellets, snow or mixed rain and snow, etc.
- (f) 'Contamination': all forms of frozen or semi-frozen deposits on an aircraft, such as frost, snow, slush or ice.
- (g) 'Contamination check': a check of the aircraft for contamination to establish the need for de-icing.
- (h) 'De-icing': the process of eliminating frozen contamination from aircraft surfaces, typically by applying de-icing fluids.

- (i) 'De-icing fluid': such fluid includes, but is not limited to, the following:
- (1) Heated water;
 - (2) Preferably, Type I fluid (neat or diluted (typically));
 - (3) Type II, III or IV fluid (neat or diluted).
- The de-icing fluid is normally applied heated to ensure maximum efficiency and its freezing point should be at the outside air temperature (OAT) or below.
- (j) 'De-icing/anti-icing': this is the combination of de-icing and anti-icing performed in either one or two steps.
- (k) 'Ground ice detection system (GIDS)': a system used during aircraft ground operations to inform the personnel involved in the operation and/or the flight crew about the presence of frost, ice, snow or slush on the aircraft surfaces.
- (l) 'Holdover time (HOT)': the period of time during which an anti-icing fluid provides protection against frozen contamination to the treated aircraft surfaces. It depends among other variables, on the type and intensity of the precipitation, OAT, wind, the particular fluid (or fluid Type) and aircraft design and aircraft configuration during the treatment.
- (m) 'Liquid water equivalent (LWE) system': an automated weather measurement system that determines the LWE precipitation rate in conditions of frozen or freezing precipitation. The system provides flight crew with continuously updated information on the fluid protection capability under varying weather conditions.
- (n) 'Lowest operational use temperature (LOUT)': the lowest temperature at which a fluid has been tested and certified as acceptable in accordance with the appropriate aerodynamic acceptance test whilst still maintaining a freezing point buffer of not less than:
- (1) 10°C for a Type I fluid; or
 - (2) 7°C for Type II, III or IV fluids.
- (o) 'Post-treatment check', 'Post- de-icing check' or 'Post- de-icing/anti-icing check': an external check of the aircraft after de-icing and/or anti-icing treatment accomplished by qualified staff and from suitably elevated observation points (e.g. from the de-icing/anti-icing equipment itself or other elevated equipment) to ensure that the aircraft is free from frost, ice, snow, or slush.
- (p) 'Pre-take-off check': The flight crew should continuously monitor the weather conditions after the de-icing/anti-icing treatment to assess whether the applied holdover time is still appropriate. Within the aircraft's HOT and prior to take-off, the flight crew should check the aircraft's wings or representative aircraft surfaces for frozen contaminants.
- (q) 'Pre-take-off contamination check': a check of the treated surfaces for contamination, performed when the HOT has been exceeded or if any doubt exists regarding the continued effectiveness of the applied anti-icing treatment. It is normally accomplished externally, just before commencement of the take-off run.

ANTI-ICING CODES

- (r) Upon completion of the anti-icing treatment, a qualified staff provides the anti-icing code to the flight crew as follows: 'the fluid Type/the fluid name (except for Type I)/concentration (except for Type I)/local time at start of anti-icing/date (optional)/the statement 'post- de-icing/anti-icing check completed' (if check completed). Example:
- 'TYPE II / MANUFACTURER, BRAND X / 75% / 1335 / 15FEB20 / POST- DE-ICING/ANTI-ICING CHECK COMPLETED'.

- (s) When a two-step de-icing/anti-icing operation has been carried out, the anti-icing code should be determined by the second step fluid.

GM2 CAT.OP.MPA.250 Ice and other contaminants — ground procedures

ED Decision 2021/005/R

DE-ICING/ANTI-ICING — PROCEDURES

- (a) De-icing and/or anti-icing procedures should take into account manufacturer's recommendations, including those that are type-specific and cover:
- (1) contamination checks, including detection of clear ice and under-wing frost; limits on the thickness/area of contamination published in the AFM or other manufacturers' documentation should be followed;
 - (2) procedures to be followed if de-icing and/or anti-icing procedures are interrupted or unsuccessful;
 - (3) post-treatment checks;
 - (4) pre-take-off checks;
 - (5) pre-take-off contamination checks;
 - (6) the recording of any incidents relating to de-icing and/or anti-icing; and
 - (7) the responsibilities of all personnel involved in de-icing and/or anti-icing.
- (b) Operator's procedures should ensure the following:
- (1) When aircraft surfaces are contaminated by ice, frost, slush or snow, they are de-iced prior to take-off according to the prevailing conditions. Removal of contaminants may be performed with mechanical tools, fluids (including hot water), infrared heat or forced air, taking account of aircraft type-specific provisions.
 - (2) Account is taken of the wing skin temperature versus OAT, as this may affect:
 - (i) the need to carry out aircraft de-icing and/or anti-icing; and/or
 - (ii) the performance of the de-icing/anti-icing fluids.
 - (3) When freezing precipitation occurs or there is a risk of freezing precipitation occurring that would contaminate the surfaces at the time of take-off, aircraft surfaces should be anti-iced. Anti-icing fluids (neat or diluted) should not be applied at OAT below their LOUT. If both de-icing and anti-icing are required, the procedure may be performed in a one- or two-step process, depending upon weather conditions, available equipment, available fluids and the desired HOT. One-step de-icing/anti-icing means that de-icing and anti-icing are carried out at the same time, using a mixture of de-icing/anti-icing fluid and water. Two-step de-icing/anti-icing means that de-icing and anti-icing are carried out in two separate steps. The aircraft is first de-iced using heated water only or a heated mixture of de-icing/anti-icing fluid and water. After completion of the de-icing operation, a layer of a mixture of de-icing/anti-icing fluid and water, or of de-icing /anti-icing fluid only, is sprayed over the aircraft surfaces. The second step will be taken before the first step fluid freezes (typically within 3 minutes but severe conditions may shorten this) and, if necessary, area by area.

- (4) When an aircraft is anti-iced and a longer HOT is needed/desired, the use of a less diluted fluid should be considered.
 - (5) All restrictions relative to OAT and fluid application (including, but not necessarily limited to, temperature and pressure) published by the fluid manufacturer and/or aircraft manufacturer, are followed. and procedures, limitations and recommendations to prevent the formation of fluid residues are followed.
 - (6) During conditions conducive to aircraft icing on the ground or after de-icing and/or anti-icing, an aircraft is not dispatched for departure unless it has been given a contamination check or a post-treatment check by a trained and qualified person. This check should cover all treated surfaces of the aircraft and be performed from points offering sufficient visibility to these parts. To ensure that there is no clear ice on suspect areas, it may be necessary to make a physical check (e.g. tactile).
 - (7) The required entry is made in the technical log.
 - (8) The commander continually monitors the environmental situation after the performed treatment. Prior to take-off, he/she performs a pre-take-off check, which is an assessment of whether the applied HOT is still appropriate. This pre-take-off check includes, but is not limited to, factors such as precipitation, wind and OAT.
 - (9) If any doubt exists as to whether a deposit may adversely affect the aircraft's performance and/or controllability characteristics, the commander should arrange for a re-treatment or a pre-take-off contamination check to be performed in order to verify that the aircraft's surfaces are free of contamination. Special methods and/or equipment may be necessary to perform this check, especially at night time or in extremely adverse weather conditions. If this check cannot be performed just before take-off, re-treatment should be applied.
 - (10) When re-treatment is necessary, any residue of the previous treatment should be removed, and a completely new de-icing/anti-icing treatment should be applied.
 - (11) When a ground ice detection system (GIDS) is used to perform an aircraft surfaces check prior to and/or after a treatment, the use of GIDS by suitably trained personnel should be part of the procedure.
- (c) Special operational considerations
- (1) When using thickened de-icing/anti-icing fluids, the operator should consider a two-step de-icing/anti-icing procedure, the first step preferably with hot water and/or un-thickened fluids.
 - (2) The use of de-icing/anti-icing fluids should be in accordance with the aircraft manufacturer's documentation. This is particularly important for thickened fluids to assure sufficient flow-off during take-off. Avoid applying excessive thickened fluid on the horizontal tail of aircraft with unpowered elevator controls.
 - (3) The operator should comply with any type-specific operational provision(s), such as an aircraft mass decrease and/or a take-off speed increase associated with a fluid application.
 - (4) The operator should take into account any flight handling procedures (stick force, rotation speed and rate, take-off speed, aircraft attitude etc.) laid down by the aircraft manufacturer when associated with a fluid application.

- (5) The limitations or handling procedures resulting from (c)(3) and/or (c)(4) above should be part of the flight crew pre take-off briefing.

(d) Communications

- (1) Before aircraft treatment. When the aircraft is to be treated with the flight crew on board, the flight and personnel involved in the operation should confirm the fluid to be used, the extent of treatment required and any aircraft type-specific procedure(s) to be used. Any other information needed to apply the HOT tables should be exchanged.
- (2) Anti-icing code. The operator's procedures should include an anti-icing code, which indicates the treatment the aircraft has received. This code provides the flight crew with the minimum details necessary to estimate a HOT and confirms that the aircraft is free of contamination.
- (3) After treatment. Before reconfiguring or moving the aircraft, the flight crew should receive a confirmation from the personnel involved in the operation that all de-icing and/or anti-icing operations are complete and that all personnel and equipment are clear of the aircraft.

(e) Holdover protection & LWE systems

The operator should publish in the OM, when required, the HOTs in the form of a table or a diagram, to account for the various types of ground icing conditions and the different types and concentrations of fluids used. However, the times of protection shown in these tables are to be used as guidelines only and are normally used in conjunction with the pre-take-off check.

An operator may choose to operate using LWE systems instead of HOT tables whenever the required means for using these systems are in place.

(f) Training

The operator's initial and recurrent de-icing training programmes (including communication training) for flight crew and for other personnel involved in de-icing operations should include additional training if any of the following is introduced:

- (1) a new method, procedure and/or technique;
- (2) a new type of fluid and/or equipment; or
- (3) a new type of aircraft.

(g) Contracting

When the operator contracts de-icing/anti-icing functions, the operator should ensure that the contractor complies with the operator's training/qualification procedures, together with any specific procedures in respect of:

- (1) roles and responsibilities;
- (2) de-icing and/or anti-icing methods and procedures;
- (3) fluids to be used, including precautions for storage, preparation for use and chemical incompatibilities;
- (4) specific aircraft provisions (e.g. no-spray areas, propeller/engine de-icing, APU operation, etc.);
- (5) different checks to be conducted; and
- (6) procedures for communications with flight crew and any other third party involved.

(h) Special maintenance considerations

(1) General

The operator should take proper account of the possible side-effects of fluid use. Such effects may include, but are not necessarily limited to, dried and/or re-hydrated residues, corrosion and the removal of lubricants.

(2) Special considerations regarding residues of dried fluids

The operator should establish procedures to prevent or detect and remove residues of dried fluid. If necessary, the operator should establish appropriate inspection intervals based on the recommendations of the airframe manufacturers and/or the operator's own experience:

(i) Dried fluid residues

Dried fluid residues could occur when surfaces have been treated and the aircraft has not subsequently been flown and has not been subject to precipitation. The fluid may then have dried on the surfaces.

(ii) Re-hydrated fluid residues

Repetitive application of thickened de-icing/anti-icing fluids may lead to the subsequent formation/build-up of a dried residue in aerodynamically quiet areas, such as cavities and gaps. This residue may re-hydrate if exposed to high humidity conditions, precipitation, washing, etc., and increase to many times its original size/volume. This residue will freeze if exposed to conditions at or below 0 °C. This may cause moving parts, such as elevators, ailerons, and flap actuating mechanisms to stiffen or jam in-flight. Re-hydrated residues may also form on exterior surfaces, which can reduce lift, increase drag and stall speed. Re-hydrated residues may also collect inside control surface structures and cause clogging of drain holes or imbalances to flight controls. Residues may also collect in hidden areas, such as around flight control hinges, pulleys, grommets, on cables and in gaps.

(iii) Operators are strongly recommended to obtain information about the fluid dry-out and re-hydration characteristics from the fluid manufacturers and to select products with optimised characteristics.

(iv) Additional information should be obtained from fluid manufacturers for handling, storage, application and testing of their products.

GM3 CAT.OP.MPA.250 Ice and other contaminants — ground procedures

ED Decision 2021/005/R

DE-ICING/ANTI-ICING BACKGROUND INFORMATION

Further guidance material on this issue is given in the ICAO *Manual of Aircraft Ground De-icing/Anti-icing Operations* (Doc 9640).

(a) General

(1) Any deposit of frost, ice, snow or slush on the external surfaces of an aircraft may drastically affect its flying qualities because of reduced aerodynamic lift, increased drag, modified stability and control characteristics. Furthermore, freezing deposits may cause

moving parts, such as elevators, ailerons, flap actuating mechanism etc., to jam and create a potentially hazardous condition. Propeller/engine/auxiliary power unit (APU)/systems performance may deteriorate due to the presence of frozen contaminants on blades, intakes and components. Also, engine operation may be seriously affected by the ingestion of snow or ice, thereby causing engine stall or compressor damage. In addition, ice/frost may form on certain external surfaces (e.g. wing upper and lower surfaces, etc.) due to the effects of cold fuel/structures, even in ambient temperatures well above 0 °C.

- (2) Procedures established by the operator for de-icing and/or anti-icing are intended to ensure that the aircraft is clear of contamination so that degradation of aerodynamic characteristics or mechanical interference will not occur and, following anti-icing, to maintain the airframe in that condition during the appropriate HOT.
- (3) Under certain meteorological conditions, de-icing and/or anti-icing procedures may be ineffective in providing sufficient protection for continued operations. Examples of these conditions are freezing rain, ice pellets and hail snow exceeding certain intensities, high wind velocity, and fast-dropping OAT. No HOT guidelines exist for these conditions.
- (4) Material for establishing operational procedures can be found, for example, in:
 - (i) ICAO Annex 3 'Meteorological Service for International Air Navigation';
 - (ii) ICAO 'Manual of Aircraft Ground De-icing/Anti-icing Operations';
 - (iii) SAE AS6285 'Aircraft Ground Deicing/Anti-Icing Processes';
 - (iv) SAE AS6286 'Aircraft Ground Deicing/Anti-Icing Training and Qualification Program';
 - (iv) SAE AS6332 'Aircraft Ground Deicing/Anti-icing Quality Management';
 - (v) SAE ARP6257 'Aircraft Ground De/Anti-Icing Communication Phraseology for Flight and Ground Crews';
 - (vi) FAA Holdover Time Guidelines
 - (vii) FAA 8900.xxx series Notice 'Revised FAA-Approved Deicing Program Updates, Winter 20xx-20yy'.

(b) Fluids

- (1) Type I fluid: Due to its properties, Type I fluid forms a thin, liquid-wetting film on surfaces to which it is applied which, under certain weather conditions, gives a very limited HOT. For anti-icing purposes the fluid/water mixture should have a freezing point of at least 10 °C below OAT; increasing the concentration of fluid in the fluid/water mix does not provide any extension in HOT.
- (2) Type II and Type IV fluids contain thickeners which enable the fluid to form a thicker liquid-wetting film on surfaces to which it is applied. Generally, this fluid provides a longer HOT than Type I fluids in similar conditions.
- (3) Type III fluid is a thickened fluid especially intended for use on aircraft with low rotation speeds.
- (4) Fluids used for de-icing and/or anti-icing should be acceptable to the operator and the aircraft manufacturer. These fluids normally conform to specifications such as SAE AMS1424 (Type I) or SAE AMS1428 (Types II, III and IV). Use of non-conforming fluids is not recommended due to their characteristics being unknown. The anti-icing and

aerodynamic properties of thickened fluids may be seriously degraded by, for example, inappropriate storage, treatment, application, application equipment, age and in case they are applied on top of non-chemically compatible de-icing fluids.

(c) Hold-over protection

- (1) Hold-over protection is achieved by a layer of anti-icing fluid remaining on and protecting aircraft surfaces for a period of time. With an one-step de-icing/anti-icing procedure, the HOT begins at the commencement of de-icing/anti-icing. With a two-step procedure, the HOT begins at the commencement of the second (anti-icing) step. The hold-over protection runs out:
 - (i) at the commencement of the take-off roll (due to aerodynamic shedding of fluid); or
 - (ii) when frozen deposits start to form or accumulate on treated aircraft surfaces, thereby indicating the loss of effectiveness of the fluid.
- (2) The duration of hold-over protection may vary depending on the influence of factors other than those specified in the HOT tables. Guidance should be provided by the operator to take account of such factors, which may include:
 - (i) atmospheric conditions, e.g. exact type and rate of precipitation, wind direction and velocity, relative humidity and solar radiation; and
 - (ii) the aircraft and its surroundings, such as aircraft component inclination angle, contour and surface roughness, surface temperature, operation in close proximity to other aircraft (jet or propeller blast) and ground equipment and structures.
- (3) HOTs are not meant to imply that flight is safe in the prevailing conditions if the specified HOT has not been exceeded. Certain meteorological conditions, such as freezing drizzle or freezing rain, may be beyond the certification envelope of the aircraft.

CAT.OP.MPA.255 Ice and other contaminants – flight procedures

Regulation (EU) No 965/2012

- (a) The operator shall establish procedures for flights in expected or actual icing conditions.
- (b) The commander shall only commence a flight or intentionally fly into expected or actual icing conditions if the aircraft is certified and equipped to cope with such conditions.
- (c) If icing exceeds the intensity of icing for which the aircraft is certified or if an aircraft not certified for flight in known icing conditions encounters icing, the commander shall exit the icing conditions without delay, by a change of level and/or route, if necessary by declaring an emergency to ATC.

AMC1 CAT.OP.MPA.255 Ice and other contaminants – flight procedures

ED Decision 2014/015/R

FLIGHT IN EXPECTED OR ACTUAL ICING CONDITIONS — AEROPLANES

- (a) In accordance with Article 2(a)5. of Annex IV to Regulation (EC) No 216/2008 (Essential requirements for air operations), in case of flight into known or expected icing conditions, the aircraft must be certified, equipped and/or treated to operate safely in such conditions. The procedures to be established by the operator should take account of the design, the equipment,

the configuration of the aircraft and the necessary training. For these reasons, different aircraft types operated by the same company may require the development of different procedures. In every case, the relevant limitations are those which are defined in the AFM and other documents produced by the manufacturer.

- (b) The operator should ensure that the procedures take account of the following:
- (1) the equipment and instruments which must be serviceable for flight in icing conditions;
 - (2) the limitations on flight in icing conditions for each phase of flight. These limitations may be imposed by the aircraft's de-icing or anti-icing equipment or the necessary performance corrections that have to be made;
 - (3) the criteria the flight crew should use to assess the effect of icing on the performance and/or controllability of the aircraft;
 - (4) the means by which the flight crew detects, by visual cues or the use of the aircraft's ice detection system, that the flight is entering icing conditions; and
 - (5) the action to be taken by the flight crew in a deteriorating situation (which may develop rapidly) resulting in an adverse effect on the performance and/or controllability of the aircraft, due to:
 - (i) the failure of the aircraft's anti-icing or de-icing equipment to control a build-up of ice; and/or
 - (ii) ice build-up on unprotected areas.
- (c) Training for dispatch and flight in expected or actual icing conditions. The content of the operations manual should reflect the training, both conversion and recurrent, which flight crew, cabin crew and all other relevant operational personnel require in order to comply with the procedures for dispatch and flight in icing conditions:
- (1) For the flight crew, the training should include:
 - (i) instruction on how to recognise, from weather reports or forecasts which are available before flight commences or during flight, the risks of encountering icing conditions along the planned route and on how to modify, as necessary, the departure and in-flight routes or profiles;
 - (ii) instruction on the operational and performance limitations or margins;
 - (iii) the use of in-flight ice detection, anti-icing and de-icing systems in both normal and abnormal operation; and
 - (iv) instruction on the differing intensities and forms of ice accretion and the consequent action which should be taken.
 - (2) For the cabin crew, the training should include:
 - (i) awareness of the conditions likely to produce surface contamination; and
 - (ii) the need to inform the flight crew of significant ice accretion.

AMC2 CAT.OP.MPA.255 Ice and other contaminants – flight procedures

ED Decision 2014/015/R

FLIGHT IN EXPECTED OR ACTUAL ICING CONDITIONS — HELICOPTERS

- (a) The procedures to be established by the operator should take account of the design, the equipment and the configuration of the helicopter and also of the training which is needed. For these reasons, different helicopter types operated by the same company may require the development of different procedures. In every case, the relevant limitations are those that are defined in the AFM and other documents produced by the manufacturer.
- (b) For the required entries in the operations manual, the procedural principles that apply to flight in icing conditions are referred to under Subpart MLR of Annex III (ORO.MLR) and should be cross-referenced, where necessary, to supplementary, type-specific data.
- (c) Technical content of the procedures

The operator should ensure that the procedures take account of the following:

- (1) [CAT.IDE.H.165](#);
 - (2) the equipment and instruments that should be serviceable for flight in icing conditions;
 - (3) the limitations on flight in icing conditions for each phase of flight. These limitations may be specified by the helicopter's de-icing or anti-icing equipment or the necessary performance corrections which have to be made;
 - (4) the criteria the flight crew should use to assess the effect of icing on the performance and/or controllability of the helicopter;
 - (5) the means by which the flight crew detects, by visual cues or the use of the helicopter's ice detection system, that the flight is entering icing conditions; and
 - (6) the action to be taken by the flight crew in a deteriorating situation (which may develop rapidly) resulting in an adverse effect on the performance and/or controllability of the helicopter, due to either:
 - (i) the failure of the helicopter's anti-icing or de-icing equipment to control a build-up of ice; and/or
 - (ii) ice build-up on unprotected areas.
- (d) Training for dispatch and flight in expected or actual icing conditions

The content of the operations manual, Part D, should reflect the training, both conversion and recurrent, which flight crew, and all other relevant operational personnel will require in order to comply with the procedures for dispatch and flight in icing conditions.

- (1) For the flight crew, the training should include:
 - (i) instruction on how to recognise, from weather reports or forecasts that are available before flight commences or during flight, the risks of encountering icing conditions along the planned route and on how to modify, as necessary, the departure and in-flight routes or profiles;
 - (ii) instruction on the operational and performance limitations or margins;
 - (iii) the use of in-flight ice detection, anti-icing and de-icing systems in both normal and abnormal operation; and

- (iv) instruction on the differing intensities and forms of ice accretion and the consequent action which should be taken.
- (2) For crew members other than flight crew, the training should include:
 - (i) awareness of the conditions likely to produce surface contamination; and
 - (ii) the need to inform the flight crew of significant ice accretion.

CAT.OP.MPA.260 Fuel/energy and oil supply

Regulation (EU) 2021/1296

The commander shall only commence a flight or continue in the event of in-flight re-planning, when satisfied that the aircraft carries at least the planned amount of usable fuel/energy and oil to safely complete the flight, taking into account the expected operating conditions.

CAT.OP.MPA.265 Take-off conditions

Regulation (EU) 2021/2237

Before commencing take-off, the commander shall be satisfied that:

- (a) the meteorological conditions at the aerodrome or operating site and the condition of the runway/FATO intended to be used will not prevent a safe take-off and departure; and
- (b) the selected aerodrome operating minima are consistent with all of the following:
 - (1) the operative ground equipment;
 - (2) the operative aircraft systems;
 - (3) the aircraft performance;
 - (4) flight crew qualifications.

AMC1 CAT.OP.MPA.265(a) Take-off conditions

ED Decision 2022/012/R

METEOROLOGICAL CONDITIONS FOR TAKE-OFF — RUNWAYS

- (a) The commander should not commence take-off unless the weather conditions at the aerodrome of departure are equal to or better than the applicable minima for landing at that aerodrome unless a weather-permissible take-off alternate aerodrome is available.
- (b) If the reported VIS is below the minimum specified for take-off and RVR is not reported, then take-off should only be commenced if the commander can determine that the visibility along the take-off runway is equal to or better than the required minimum.

CAT.OP.MPA.270 Minimum flight altitudes

Regulation (EU) No 965/2012

The commander or the pilot to whom conduct of the flight has been delegated shall not fly below specified minimum altitudes except when:

- (a) necessary for take-off or landing; or
- (b) descending in accordance with procedures approved by the competent authority.

CAT.OP.MPA.275 Simulated abnormal situations in flight

Regulation (EU) No 965/2012

The operator shall ensure that when carrying passengers or cargo the following are not simulated:

- (a) abnormal or emergency situations that require the application of abnormal or emergency procedures; or
- (b) flight in IMC by artificial means.

CAT.OP.MPA.280

Regulation (EU) 2021/1296

[INTENTIONALLY LEFT BLANK].

CAT.OP.MPA.285 Use of supplemental oxygen

Regulation (EU) No 965/2012

The commander shall ensure that flight crew members engaged in performing duties essential to the safe operation of an aircraft in flight use supplemental oxygen continuously whenever the cabin altitude exceeds 10 000 ft for a period of more than 30 minutes and whenever the cabin altitude exceeds 13 000 ft.

CAT.OP.MPA.290 Ground proximity detection

Regulation (EU) No 965/2012

When undue proximity to the ground is detected by a flight crew member or by a ground proximity warning system, the pilot flying shall take corrective action immediately to establish safe flight conditions.

GM1 CAT.OP.MPA.290 Ground proximity detection

ED Decision 2014/015/R

TERRAIN AWARENESS WARNING SYSTEM (TAWS) FLIGHT CREW TRAINING PROGRAMMES

- (a) Introduction
 - (1) This GM contains performance-based training objectives for TAWS flight crew training.
 - (2) The training objectives cover five areas: theory of operation; pre-flight operations; general in-flight operations; response to TAWS cautions; and response to TAWS warnings.
 - (3) The term 'TAWS' in this GM means a ground proximity warning system (GPWS) enhanced by a forward-looking terrain avoidance function. Alerts include both cautions and warnings.
 - (4) The content of this GM is intended to assist operators who are producing training programmes. The information it contains has not been tailored to any specific aircraft or TAWS equipment, but highlights features which are typically available where such systems are installed. It is the responsibility of the individual operator to determine the applicability of the content of this guidance material to each aircraft and TAWS equipment installed and their operation. Operators should refer to the AFM and/or aircraft/flight crew operating manual (A/FCOM), or similar documents, for information applicable to specific configurations. If there should be any conflict between the content

of this guidance material and that published in the other documents described above, then information contained in the AFM or A/FCOM will take precedence.

(b) Scope

- (1) The scope of this GM is designed to identify training objectives in the areas of: academic training; manoeuvre training; initial evaluation; and recurrent qualification. Under each of these four areas, the training material has been separated into those items which are considered essential training items and those that are considered to be desirable. In each area, objectives and acceptable performance criteria are defined.
- (2) No attempt is made to define how the training programme should be implemented. Instead, objectives are established to define the knowledge that a pilot operating a TAWS is expected to possess and the performance expected from a pilot who has completed TAWS training. However, the guidelines do indicate those areas in which the pilot receiving the training should demonstrate his/her understanding, or performance, using a real-time, interactive training device, i.e. a flight simulator. Where appropriate, notes are included within the performance criteria which amplify or clarify the material addressed by the training objective.

(c) Performance-based training objectives

- (1) TAWS academic training
 - (i) This training is typically conducted in a classroom environment. The knowledge demonstrations specified in this section may be completed through the successful completion of written tests or by providing correct responses to non-real-time computer-based training (CBT) questions.
 - (ii) Theory of operation. The pilot should demonstrate an understanding of TAWS operation and the criteria used for issuing cautions and warnings. This training should address system operation. Objective: To demonstrate knowledge of how a TAWS functions. Criteria: The pilot should demonstrate an understanding of the following functions:
 - (A) Surveillance
 - (a) The GPWS computer processes data supplied from an air data computer, a radio altimeter, an instrument landing system (ILS)/microwave landing system (MLS)/multi-mode (MM) receiver, a roll attitude sensor, and actual position of the surfaces and of the landing gear.
 - (b) The forward-looking terrain avoidance function utilises an accurate source of known aircraft position, such as that which may be provided by a flight management system (FMS) or GPS, or an electronic terrain database. The source and scope of the terrain, obstacle and airport data, and features such as the terrain clearance floor, the runway picker, and geometric altitude (where provided) should all be described.
 - (c) Displays required to deliver TAWS outputs include a loudspeaker for voice announcements, visual alerts (typically amber and red lights), and a terrain awareness display (that may be combined with other displays). In addition, means should be provided for indicating the status of the TAWS and any partial or total failures that may occur.

- (B) Terrain avoidance. Outputs from the TAWS computer provides visual and audio synthetic voice cautions and warnings to alert the flight crew about potential conflicts with terrain and obstacles.
- (C) Alert thresholds. Objective: To demonstrate knowledge of the criteria for issuing cautions and warnings. Criteria: The pilot should be able to demonstrate an understanding of the methodology used by a TAWS to issue cautions and alerts and the general criteria for the issuance of these alerts, including:
 - (a) basic GPWS alerting modes specified in the ICAO Standard:
 - Mode 1: excessive sink rate;
 - Mode 2: excessive terrain closure rate;
 - Mode 3: descent after take-off or go-around;
 - Mode 4: unsafe proximity to terrain;
 - Mode 5: descent below ILS glide slope (caution only); and
 - (b) an additional, optional alert mode — Mode 6: radio altitude call-out (information only); TAWS cautions and warnings which alert the flight crew to obstacles and terrain ahead of the aircraft in line with or adjacent to its projected flight path (forward-looking terrain avoidance (FLTA) and premature descent alert (PDA) functions).
- (D) TAWS limitations. Objective: To verify that the pilot is aware of the limitations of TAWS. Criteria: The pilot should demonstrate knowledge and an understanding of TAWS limitations identified by the manufacturer for the equipment model installed, such as:
 - (a) navigation should not be predicated on the use of the terrain display;
 - (b) unless geometric altitude data are provided, use of predictive TAWS functions is prohibited when altimeter subscale settings display 'QFE';
 - (c) nuisance alerts can be issued if the aerodrome of intended landing is not included in the TAWS airport database;
 - (d) in cold weather operations, corrective procedures should be implemented by the pilot unless the TAWS has in-built compensation, such as geometric altitude data;
 - (e) loss of input data to the TAWS computer could result in partial or total loss of functionality. Where means exist to inform the flight crew that functionality has been degraded, this should be known and the consequences understood;
 - (f) radio signals not associated with the intended flight profile (e.g. ILS glide path transmissions from an adjacent runway) may cause false alerts;
 - (g) inaccurate or low accuracy aircraft position data could lead to false or non-annunciation of terrain or obstacles ahead of the aircraft; and
 - (h) minimum equipment list (MEL) restrictions should be applied in the event of the TAWS becoming partially or completely unserviceable. (It should be noted that basic GPWS has no forward-looking capability.)

- (E) TAWS inhibits. Objective: To verify that the pilot is aware of the conditions under which certain functions of a TAWS are inhibited. Criteria: The pilot should demonstrate knowledge and an understanding of the various TAWS inhibits, including the following means of:
- (a) silencing voice alerts;
 - (b) inhibiting ILS glide path signals (as may be required when executing an ILS back beam approach);
 - (c) inhibiting flap position sensors (as may be required when executing an approach with the flaps not in a normal position for landing);
 - (d) inhibiting the FLTA and PDA functions; and
 - (e) selecting or deselecting the display of terrain information, together with appropriate annunciation of the status of each selection.
- (2) Operating procedures. The pilot should demonstrate the knowledge required to operate TAWS avionics and to interpret the information presented by a TAWS. This training should address the following topics:
- (i) Use of controls. Objective: To verify that the pilot can properly operate all TAWS controls and inhibits. Criteria: The pilot should demonstrate the proper use of controls, including the following means by which:
 - (A) before flight, any equipment self-test functions can be initiated;
 - (B) TAWS information can be selected for display; and
 - (C) all TAWS inhibits can be operated and what the consequent annunciations mean with regard to loss of functionality.
 - (ii) Display interpretation. Objective: To verify that the pilot understands the meaning of all information that can be annunciated or displayed by a TAWS. Criteria: The pilot should demonstrate the ability to properly interpret information annunciated or displayed by a TAWS, including the following:
 - (A) knowledge of all visual and aural indications that may be seen or heard;
 - (B) response required on receipt of a caution;
 - (C) response required on receipt of a warning; and
 - (D) response required on receipt of a notification that partial or total failure of the TAWS has occurred (including annunciation that the present aircraft position is of low accuracy).
 - (iii) Use of basic GPWS or use of the FLTA function only. Objective: To verify that the pilot understands what functionality will remain following loss of the GPWS or of the FLTA function. Criteria: The pilot should demonstrate knowledge of how to recognise the following:
 - (A) un-commanded loss of the GPWS function, or how to isolate this function and how to recognise the level of the remaining controlled flight into terrain (CFIT) protection (essentially, this is the FLTA function); and
 - (B) un-commanded loss of the FLTA function, or how to isolate this function and how to recognise the level of the remaining CFIT protection (essentially, this is the basic GPWS).

-
- (iv) Crew coordination. Objective: To verify that the pilot adequately briefs other flight crew members on how TAWS alerts will be handled. Criteria: The pilot should demonstrate that the pre-flight briefing addresses procedures that will be used in preparation for responding to TAWS cautions and warnings, including the following:
 - (A) the action to be taken, and by whom, in the event that a TAWS caution and/or warning is issued; and
 - (B) how multi-function displays will be used to depict TAWS information at take-off, in the cruise and for the descent, approach, landing (and any go-around). This will be in accordance with procedures specified by the operator, who will recognise that it may be more desirable that other data are displayed at certain phases of flight and that the terrain display has an automatic 'pop-up' mode in the event that an alert is issued.
 - (v) Reporting rules. Objective: To verify that the pilot is aware of the rules for reporting alerts to the controller and other authorities. Criteria: The pilot should demonstrate knowledge of the following:
 - (A) when, following recovery from a TAWS alert or caution, a transmission of information should be made to the appropriate ATC unit; and
 - (B) the type of written report that is required, how it is to be compiled, and whether any cross reference should be made in the aircraft technical log and/or voyage report (in accordance with procedures specified by the operator), following a flight in which the aircraft flight path has been modified in response to a TAWS alert, or if any part of the equipment appears not to have functioned correctly.
 - (vi) Alert thresholds. Objective: To demonstrate knowledge of the criteria for issuing cautions and warnings. Criteria: The pilot should be able to demonstrate an understanding of the methodology used by a TAWS to issue cautions and warnings and the general criteria for the issuance of these alerts, including awareness of the following:
 - (A) modes associated with basic GPWS, including the input data associated with each; and
 - (B) visual and aural annunciations that can be issued by TAWS and how to identify which are cautions and which are warnings.
 - (3) TAWS manoeuvre training. The pilot should demonstrate the knowledge required to respond correctly to TAWS cautions and warnings. This training should address the following topics:
 - (i) Response to cautions:
 - (A) Objective: To verify that the pilot properly interprets and responds to cautions. Criteria: The pilot should demonstrate an understanding of the need, without delay:
 - (a) to initiate action required to correct the condition which has caused the TAWS to issue the caution and to be prepared to respond to a warning, if this should follow; and

- (b) if a warning does not follow the caution, to notify the controller of the new position, heading and/or altitude/flight level of the aircraft, and what the commander intends to do next.
- (B) The correct response to a caution might require the pilot to:
 - (a) reduce a rate of descent and/or to initiate a climb;
 - (b) regain an ILS glide path from below, or to inhibit a glide path signal if an ILS is not being flown;
 - (c) select more flap, or to inhibit a flap sensor if the landing is being conducted with the intent that the normal flap setting will not be used;
 - (d) select gear down; and/or
 - (e) initiate a turn away from the terrain or obstacle ahead and towards an area free of such obstructions if a forward-looking terrain display indicates that this would be a good solution and the entire manoeuvre can be carried out in clear visual conditions.
- (ii) Response to warnings. Objective: To verify that the pilot properly interprets and responds to warnings. Criteria: The pilot should demonstrate an understanding of the following:
 - (A) The need, without delay, to initiate a climb in the manner specified by the operator.
 - (B) The need, without delay, to maintain the climb until visual verification can be made that the aircraft will clear the terrain or obstacle ahead or until above the appropriate sector safe altitude (if certain about the location of the aircraft with respect to terrain) even if the TAWS warning stops. If, subsequently, the aircraft climbs up through the sector safe altitude, but the visibility does not allow the flight crew to confirm that the terrain hazard has ended, checks should be made to verify the location of the aircraft and to confirm that the altimeter subscale settings are correct.
 - (C) When the workload permits that, the flight crew should notify the air traffic controller of the new position and altitude/flight level, and what the commander intends to do next.
 - (D) That the manner in which the climb is made should reflect the type of aircraft and the method specified by the aircraft manufacturer (which should be reflected in the operations manual) for performing the escape manoeuvre. Essential aspects will include the need for an increase in pitch attitude, selection of maximum thrust, confirmation that external sources of drag (e.g. spoilers/speed brakes) are retracted, and respect of the stick shaker or other indication of eroded stall margin.
 - (E) That TAWS warnings should never be ignored. However, the pilot's response may be limited to that which is appropriate for a caution, only if:
 - (a) the aircraft is being operated by day in clear, visual conditions; and
 - (b) it is immediately clear to the pilot that the aircraft is in no danger in respect of its configuration, proximity to terrain or current flight path.

-
- (4) TAWS initial evaluation:
- (i) The flight crew member's understanding of the academic training items should be assessed by means of a written test.
 - (ii) The flight crew member's understanding of the manoeuvre training items should be assessed in a FSTD equipped with TAWS visual and aural displays and inhibit selectors similar in appearance and operation to those in the aircraft which the pilot will fly. The results should be assessed by a synthetic flight instructor, synthetic flight examiner, type rating instructor or type rating examiner.
 - (iii) The range of scenarios should be designed to give confidence that proper and timely responses to TAWS cautions and warnings will result in the aircraft avoiding a CFIT accident. To achieve this objective, the pilot should demonstrate taking the correct action to prevent a caution developing into a warning and, separately, the escape manoeuvre needed in response to a warning. These demonstrations should take place when the external visibility is zero, though there is much to be learnt if, initially, the training is given in 'mountainous' or 'hilly' terrain with clear visibility. This training should comprise a sequence of scenarios, rather than be included in line oriented flight training (LOFT).
 - (iv) A record should be made, after the pilot has demonstrated competence, of the scenarios that were practised.
- (5) TAWS recurrent training:
- (i) TAWS recurrent training ensures that pilots maintain the appropriate TAWS knowledge and skills. In particular, it reminds pilots of the need to act promptly in response to cautions and warnings, and of the unusual attitude associated with flying the escape manoeuvre.
 - (ii) An essential item of recurrent training is the discussion of any significant issues and operational concerns that have been identified by the operator. Recurrent training should also address changes to TAWS logic, parameters or procedures and to any unique TAWS characteristics of which pilots should be aware.
- (6) Reporting procedures:
- (i) Verbal reports. Verbal reports should be made promptly to the appropriate air traffic control unit:
 - (A) whenever any manoeuvre has caused the aircraft to deviate from an air traffic clearance;
 - (B) when, following a manoeuvre which has caused the aircraft to deviate from an air traffic clearance, the aircraft has returned to a flight path which complies with the clearance; and/or
 - (C) when an air traffic control unit issues instructions which, if followed, would cause the pilot to manoeuvre the aircraft towards terrain or obstacle or it would appear from the display that a potential CFIT occurrence is likely to result.
 - (ii) Written reports. Written reports should be submitted in accordance with the operator's occurrence reporting scheme and they also should be recorded in the aircraft technical log:

- (A) whenever the aircraft flight path has been modified in response to a TAWS alert (false, nuisance or genuine);
 - (B) whenever a TAWS alert has been issued and is believed to have been false; and/or
 - (C) if it is believed that a TAWS alert should have been issued, but was not.
- (iii) Within this GM and with regard to reports:
- (A) the term 'false' means that the TAWS issued an alert which could not possibly be justified by the position of the aircraft in respect to terrain and it is probable that a fault or failure in the system (equipment and/or input data) was the cause;
 - (B) the term 'nuisance' means that the TAWS issued an alert which was appropriate, but was not needed because the flight crew could determine by independent means that the flight path was, at that time, safe;
 - (C) the term 'genuine' means that the TAWS issued an alert which was both appropriate and necessary; and
 - (D) the report terms described in (c)(6)(iii) are only meant to be assessed after the occurrence is over, to facilitate subsequent analysis, the adequacy of the equipment and the programmes it contains. The intention is not for the flight crew to attempt to classify an alert into any of these three categories when visual and/or aural cautions or warnings are annunciated.

CAT.OP.MPA.295 Use of airborne collision avoidance system (ACAS)

Regulation (EU) 2016/1199

The operator shall establish operational procedures and training programmes when ACAS is installed and serviceable so that the flight crew is appropriately trained in the avoidance of collisions and competent in the use of ACAS II equipment.

GM1 CAT.OP.MPA.295 Use of airborne collision avoidance system (ACAS)

ED Decision 2019/019/R

GENERAL

- (a) The ACAS operational procedures and training programmes established by the operator should take into account this GM. It incorporates advice contained in:
- (1) ICAO Doc 8168 (PANS-OPS), Volume III¹ Aircraft Operating Procedures, Chapter 3 and Attachment A (ACAS training guidelines for pilots) and Attachment B (ACAS high vertical rate (HVR) encounters) to Section 4, Chapter 3; and
 - (2) ICAO PANS-ATM² Chapters 12 and 15 phraseology requirements;
 - (3) ICAO Annex 10, Volume IV;

¹ ICAO Doc 8168 Procedures for Air Navigation Services-Aircraft Operations, Volume III - Aircraft Operating Procedures, First Edition, 2018.

² ICAO Doc 4444-ATM/501 - PANS-ATM (Procedures for Air Navigation Services-Air Traffic Management) (Fifteenth edition, Amendment 3).

(4) ICAO PANS-ATM.

- (b) Additional guidance material on ACAS may be referred to, including information available from such sources as EUROCONTROL.

ACAS FLIGHT CREW TRAINING PROGRAMMES

- (c) During the implementation of ACAS, several operational issues were identified which had been attributed to deficiencies in flight crew training programmes. As a result, the issue of flight crew training has been discussed within the ICAO, which has developed guidelines for operators to use when designing training programmes.
- (d) This GM contains performance-based training objectives for ACAS II flight crew training. Information contained in this paper related to traffic advisories (TAs) is also applicable to ACAS I and ACAS II users. The training objectives cover five areas: theory of operation; pre-flight operations; general in-flight operations; response to TAs; and response to resolution advisories (RAs).
- (e) The information provided is valid for version 7 and 7.1 (ACAS II). Where differences arise, these are identified.
- (f) The performance-based training objectives are further divided into the areas of: academic training; manoeuvre training; initial evaluation and recurrent qualification. Under each of these four areas, the training material has been separated into those items which are considered essential training items and those which are considered desirable. In each area, objectives and acceptable performance criteria are defined.
- (g) ACAS academic training
- (1) This training is typically conducted in a classroom environment. The knowledge demonstrations specified in this section may be completed through the successful completion of written tests or through providing correct responses to non-real-time computer-based training (CBT) questions.
- (2) Essential items
- (i) Theory of operation. The flight crew member should demonstrate an understanding of ACAS II operation and the criteria used for issuing TAs and RAs. This training should address the following topics:
- (A) System operation
- Objective: to demonstrate knowledge of how ACAS functions.
- Criteria: the flight crew member should demonstrate an understanding of the following functions:
- (a) Surveillance
- (1) ACAS interrogates other transponder-equipped aircraft within a nominal range of 14 NM.
- (2) ACAS surveillance range can be reduced in geographic areas with a large number of ground interrogators and/or ACAS II-equipped aircraft.
- (3) If the operator's ACAS implementation provides for the use of the Mode S extended squitter, the normal surveillance range may be increased beyond the nominal 14 NM. However, this information is not used for collision avoidance purposes.

- (b) Collision avoidance
 - (1) TAs can be issued against any transponder-equipped aircraft which responds to the ICAO Mode C interrogations, even if the aircraft does not have altitude reporting capability.
 - (2) RAs can be issued only against aircraft that are reporting altitude and in the vertical plane only.
 - (3) RAs issued against an ACAS-equipped intruder are co-ordinated to ensure complementary RAs are issued.
 - (4) Failure to respond to an RA deprives own aircraft of the collision protection provided by own ACAS.
 - (5) Additionally, in ACAS-ACAS encounters, failure to respond to an RA also restricts the choices available to the other aircraft's ACAS and thus renders the other aircraft's ACAS less effective than if own aircraft were not ACAS-equipped.

(B) Advisory thresholds

Objective: to demonstrate knowledge of the criteria for issuing TAs and RAs.

Criteria: the flight crew member should demonstrate an understanding of the methodology used by ACAS to issue TAs and RAs and the general criteria for the issuance of these advisories, including the following:

- (a) ACAS advisories are based on time to closest point of approach (CPA) rather than distance. The time should be short and vertical separation should be small, or projected to be small, before an advisory can be issued. The separation standards provided by ATS are different from the miss distances against which ACAS issues alerts.
- (b) Thresholds for issuing a TA or an RA vary with altitude. The thresholds are larger at higher altitudes.
- (c) A TA occurs from 15 to 48 seconds and an RA from 15 to 35 seconds before the projected CPA.
- (d) RAs are chosen to provide the desired vertical miss distance at CPA. As a result, RAs can instruct a climb or descent through the intruder aircraft's altitude.

(C) ACAS limitations

Objective: to verify that the flight crew member is aware of the limitations of ACAS.

Criteria: the flight crew member should demonstrate knowledge and understanding of ACAS limitations, including the following:

- (a) ACAS will neither track nor display non-transponder-equipped aircraft, nor aircraft not responding to ACAS Mode C interrogations.
- (b) ACAS will automatically fail if the input from the aircraft's barometric altimeter, radio altimeter or transponder is lost.
 - (1) In some installations, the loss of information from other on board systems such as an inertial reference system (IRS) or

attitude heading reference system (AHRS) may result in an ACAS failure. Individual operators should ensure that their flight crews are aware of the types of failure that will result in an ACAS failure.

- (2) ACAS may react in an improper manner when false altitude information is provided to own ACAS or transmitted by another aircraft. Individual operators should ensure that their flight crew are aware of the types of unsafe conditions that can arise. Flight crew members should ensure that when they are advised, if their own aircraft is transmitting false altitude reports, an alternative altitude reporting source is selected, or altitude reporting is switched off.
- (c) Some aeroplanes within 380 ft above ground level (AGL) (nominal value) are deemed to be 'on ground' and will not be displayed. If ACAS is able to determine an aircraft below this altitude is airborne, it will be displayed.
- (d) ACAS may not display all proximate transponder-equipped aircraft in areas of high density traffic.
- (e) The bearing displayed by ACAS is not sufficiently accurate to support the initiation of horizontal manoeuvres based solely on the traffic display.
- (f) ACAS will neither track nor display intruders with a vertical speed in excess of 10 000 ft/min. In addition, the design implementation may result in some short-term errors in the tracked vertical speed of an intruder during periods of high vertical acceleration by the intruder.
- (g) Ground proximity warning systems/ground collision avoidance systems (GPWSs/GCASs) warnings and wind shear warnings take precedence over ACAS advisories. When either a GPWS/GCAS or wind shear warning is active, ACAS aural annunciations will be inhibited and ACAS will automatically switch to the 'TA only' mode of operation.

(D) ACAS inhibits

Objective: to verify that the flight crew member is aware of the conditions under which certain functions of ACAS are inhibited.

Criteria: the flight crew member should demonstrate knowledge and understanding of the various ACAS inhibits, including the following:

- (a) 'Increase Descent' RAs are inhibited below 1 450 ft AGL;
- (b) 'Descend' RAs are inhibited below 1 100 ft AGL;
- (c) all RAs are inhibited below 1 000 ft AGL;
- (d) all TA aural annunciations are inhibited below 500 ft AGL; and
- (e) altitude and configuration under which 'Climb' and 'Increase Climb' RAs are inhibited. ACAS can still issue 'Climb' and 'Increase Climb' RAs when operating at the aeroplane's certified ceiling. (In some aircraft types, 'Climb' or 'Increase Climb' RAs are never inhibited.)

(ii) Operating procedures

The flight crew member should demonstrate the knowledge required to operate the ACAS avionics and interpret the information presented by ACAS. This training should address the following:

(A) Use of controls

Objective: to verify that the pilot can properly operate all ACAS and display controls.

Criteria: demonstrate the proper use of controls including:

- (a) aircraft configuration required to initiate a self-test;
- (b) steps required to initiate a self-test;
- (c) recognising when the self-test was successful and when it was unsuccessful. When the self-test is unsuccessful, recognising the reason for the failure and, if possible, correcting the problem;
- (d) recommended usage of range selection. Low ranges are used in the terminal area and the higher display ranges are used in the en-route environment and in the transition between the terminal and en-route environment;
- (e) recognising that the configuration of the display does not affect the ACAS surveillance volume;
- (f) selection of lower ranges when an advisory is issued, to increase display resolution;
- (g) proper configuration to display the appropriate ACAS information without eliminating the display of other needed information;
- (h) if available, recommended usage of the above/below mode selector. The above mode should be used during climb and the below mode should be used during descent; and
- (i) if available, proper selection of the display of absolute or relative altitude and the limitations of using this display if a barometric correction is not provided to ACAS.

(B) Display interpretation

Objective: to verify that the flight crew member understands the meaning of all information that can be displayed by ACAS. The wide variety of display implementations require the tailoring of some criteria. When the training programme is developed, these criteria should be expanded to cover details for the operator's specific display implementation.

Criteria: the flight crew member should demonstrate the ability to properly interpret information displayed by ACAS, including the following:

- (a) other traffic, i.e. traffic within the selected display range that is not proximate traffic, or causing a TA or RA to be issued;
- (b) proximate traffic, i.e. traffic that is within 6 NM and ± 1 200 ft;
- (c) non-altitude reporting traffic;

- (d) no bearing TAs and RAs;
 - (e) off-scale TAs and RAs: the selected range should be changed to ensure that all available information on the intruder is displayed;
 - (f) TAs: the minimum available display range which allows the traffic to be displayed should be selected, to provide the maximum display resolution;
 - (g) RAs (traffic display): the minimum available display range of the traffic display which allows the traffic to be displayed should be selected, to provide the maximum display resolution;
 - (h) RAs (RA display): flight crew members should demonstrate knowledge of the meaning of the red and green areas or the meaning of pitch or flight path angle cues displayed on the RA display. Flight crew members should also demonstrate an understanding of the RA display limitations, i.e. if a vertical speed tape is used and the range of the tape is less than 2 500 ft/min, an increase rate RA cannot be properly displayed; and
 - (i) if appropriate, awareness that navigation displays oriented on 'Track-Up' may require a flight crew member to make a mental adjustment for drift angle when assessing the bearing of proximate traffic.
- (C) Use of the TA-only mode
- Objective: to verify that a flight crew member understands the appropriate times to select the TA-only mode of operation and the limitations associated with using this mode.
- Criteria: the flight crew member should demonstrate the following:
- (a) Knowledge of the operator's guidance for the use of TA only.
 - (b) Reasons for using this mode. If TA only is not selected when an airport is conducting simultaneous operations from parallel runways separated by less than 1 200 ft, and to some intersecting runways, RAs can be expected. If for any reason TA only is not selected and an RA is received in these situations, the response should comply with the operator's approved procedures.
 - (c) All TA aural annunciations are inhibited below 500 ft AGL. As a result, TAs issued below 500 ft AGL may not be noticed unless the TA display is included in the routine instrument scan.
- (D) Crew coordination
- Objective: to verify that the flight crew member understands how ACAS advisories will be handled.
- Criteria: the flight crew member should demonstrate knowledge of the crew procedures that should be used when responding to TAs and RAs, including the following:
- (a) task sharing between the pilot flying and the pilot monitoring;
 - (b) expected call-outs; and
 - (c) communications with ATC.

(E) Phraseology rules

Objective: to verify that the flight crew member is aware of the rules for reporting RAs to the controller.

Criteria: the flight crew member should demonstrate the following:

- (a) the use of the phraseology contained in ICAO PANS-OPS;
- (b) an understanding of the procedures contained in ICAO PANS-ATM and ICAO Annex 2; and
- (c) the understanding that verbal reports should be made promptly to the appropriate ATC unit:
 - (1) whenever any manoeuvre has caused the aeroplane to deviate from an air traffic clearance;
 - (2) when, subsequent to a manoeuvre that has caused the aeroplane to deviate from an air traffic clearance, the aeroplane has returned to a flight path that complies with the clearance; and/or
 - (3) when air traffic issue instructions that, if followed, would cause the crew to manoeuvre the aircraft contrary to an RA with which they are complying.

(F) Reporting rules

Objective: to verify that the flight crew member is aware of the rules for reporting RAs to the operator.

Criteria: the flight crew member should demonstrate knowledge of where information can be obtained regarding the need for making written reports to various states when an RA is issued. Various States have different reporting rules and the material available to the flight crew member should be tailored to the operator's operating environment. For operators involved in commercial operations, this responsibility is satisfied by the flight crew member reporting to the operator according to the applicable reporting rules.

(3) Non-essential items: advisory thresholds

Objective: to demonstrate knowledge of the criteria for issuing TAs and RAs.

Criteria: the flight crew member should demonstrate an understanding of the methodology used by ACAS to issue TAs and RAs and the general criteria for the issuance of these advisories, including the following:

- (i) the minimum and maximum altitudes below/above which TAs will not be issued;
- (ii) when the vertical separation at CPA is projected to be less than the ACAS-desired separation, a corrective RA which requires a change to the existing vertical speed will be issued. This separation varies from 300 ft at low altitude to a maximum of 700 ft at high altitude;
- (iii) when the vertical separation at CPA is projected to be just outside the ACAS-desired separation, a preventive RA that does not require a change to the existing vertical speed will be issued. This separation varies from 600 to 800 ft; and

- (iv) RA fixed range thresholds vary between 0.2 and 1.1 NM.
- (h) ACAS manoeuvre training
- (1) Demonstration of the flight crew member's ability to use ACAS displayed information to properly respond to TAs and RAs should be carried out in a full flight simulator equipped with an ACAS display and controls similar in appearance and operation to those in the aircraft. If a full flight simulator is utilised, CRM should be practised during this training.
 - (2) Alternatively, the required demonstrations can be carried out by means of an interactive CBT with an ACAS display and controls similar in appearance and operation to those in the aircraft. This interactive CBT should depict scenarios in which real-time responses should be made. The flight crew member should be informed whether or not the responses made were correct. If the response was incorrect or inappropriate, the CBT should show what the correct response should be.
 - (3) The scenarios included in the manoeuvre training should include: corrective RAs; initial preventive RAs; maintain rate RAs; altitude crossing RAs; increase rate RAs; RA reversals; weakening RAs; and multi-aircraft encounters. The consequences of failure to respond correctly should be demonstrated by reference to actual incidents such as those publicised in EUROCONTROL ACAS II Bulletins (available on the EUROCONTROL website).
- (i) TA responses
- Objective: to verify that the pilot properly interprets and responds to TAs.
- Criteria: the pilot should demonstrate the following:
- (A) Proper division of responsibilities between the pilot flying and the pilot monitoring. The pilot flying should fly the aircraft using any type-specific procedures and be prepared to respond to any RA that might follow. For aircraft without an RA pitch display, the pilot flying should consider the likely magnitude of an appropriate pitch change. The pilot monitoring should provide updates on the traffic location shown on the ACAS display, using this information to help visually acquire the intruder.
 - (B) Proper interpretation of the displayed information. Flight crew members should confirm that the aircraft they have visually acquired is that which has caused the TA to be issued. Use should be made of all information shown on the display, note being taken of the bearing and range of the intruder (amber circle), whether it is above or below (data tag) and its vertical speed direction (trend arrow).
 - (C) Other available information should be used to assist in visual acquisition, including ATC 'party-line' information, traffic flow in use, etc.
 - (D) Because of the limitations described, the pilot flying should not manoeuvre the aircraft based solely on the information shown on the ACAS display. No attempt should be made to adjust the current flight path in anticipation of what an RA would advise, except that if own aircraft is approaching its cleared level at a high vertical rate with a TA present, vertical rate should be reduced to less than 1 500 ft/min.
 - (E) When visual acquisition is attained, and as long as no RA is received, normal right of way rules should be used to maintain or attain safe separation. No unnecessary manoeuvres should be initiated. The limitations of making manoeuvres based solely on visual acquisition, especially at high altitude or

at night, or without a definite horizon should be demonstrated as being understood.

(ii) RA responses

Objective: to verify that the pilot properly interprets and responds to RAs.

Criteria: the pilot should demonstrate the following:

- (A) Proper response to the RA, even if it is in conflict with an ATC instruction and even if the pilot believes that there is no threat present.
- (B) Proper task sharing between the pilot flying and the pilot monitoring. The pilot flying should respond to a corrective RA with appropriate control inputs. The pilot monitoring should monitor the response to the RA and should provide updates on the traffic location by checking the traffic display. Proper crew resource management (CRM) should be used.
- (C) Proper interpretation of the displayed information. The pilot should recognise the intruder causing the RA to be issued (red square on display). The pilot should respond appropriately.
- (D) For corrective RAs, the response should be initiated in the proper direction within five seconds of the RA being displayed. The change in vertical speed should be accomplished with an acceleration of approximately $\frac{1}{4}$ g (gravitational acceleration of 9.81 m/sec^2).
- (E) Recognition of the initially displayed RA being modified. Response to the modified RA should be properly accomplished, as follows:
 - (a) For increase rate RAs, the vertical speed change should be started within two and a half seconds of the RA being displayed. The change in vertical speed should be accomplished with an acceleration of approximately $\frac{1}{2}$ g.
 - (b) For RA reversals, the vertical speed reversal should be started within two and a half seconds of the RA being displayed. The change in vertical speed should be accomplished with an acceleration of approximately $\frac{1}{2}$ g.
 - (c) For RA weakenings, the vertical speed should be modified to initiate a return towards the original clearance.
 - (d) An acceleration of approximately $\frac{1}{4}$ g will be achieved if the change in pitch attitude corresponding to a change in vertical speed of 1 500 ft/min is accomplished in approximately 5 seconds, and of $\frac{1}{2}$ g if the change is accomplished in approximately three seconds. The change in pitch attitude required to establish a rate of climb or descent of 1 500 ft/min from level flight will be approximately 6° when the true airspeed (TAS) is 150 kt, 4° at 250 kt, and 2° at 500 kt. (These angles are derived from the formula: 1 000 divided by TAS.).
- (F) Recognition of altitude crossing encounters and the proper response to these RAs.
- (G) For preventive RAs, the vertical speed needle or pitch attitude indication should remain outside the red area on the RA display.

- (H) For maintain rate RAs, the vertical speed should not be reduced. Pilots should recognise that a maintain rate RA may result in crossing through the intruder's altitude.
 - (I) When the RA weakens, or when the green 'fly to' indicator changes position, the pilot should initiate a return towards the original clearance and when 'clear of conflict' is annunciated, the pilot should complete the return to the original clearance.
 - (J) The controller should be informed of the RA as soon as time and workload permit, using the standard phraseology.
 - (K) When possible, an ATC clearance should be complied with while responding to an RA. For example, if the aircraft can level at the assigned altitude while responding to RA (an 'adjust vertical speed' RA (version 7) or 'level off' (version 7.1)) it should be done; the horizontal (turn) element of an ATC instruction should be followed.
 - (L) Knowledge of the ACAS multi-aircraft logic and its limitations, and that ACAS can optimise separations from two aircraft by climbing or descending towards one of them. For example, ACAS only considers intruders that it considers to be a threat when selecting an RA. As such, it is possible for ACAS to issue an RA against one intruder that results in a manoeuvre towards another intruder which is not classified as a threat. If the second intruder becomes a threat, the RA will be modified to provide separation from that intruder.
- (i) ACAS initial evaluation
- (1) The flight crew member's understanding of the academic training items should be assessed by means of a written test or interactive CBT that records correct and incorrect responses to phrased questions.
 - (2) The flight crew member's understanding of the manoeuvre training items should be assessed in a full flight simulator equipped with an ACAS display and controls similar in appearance and operation to those in the aircraft the flight crew member will fly, and the results assessed by a qualified instructor, inspector, or check airman. The range of scenarios should include: corrective RAs; initial preventive RAs; maintain rate RAs; altitude crossing RAs; increase rate RAs; RA reversals; weakening RAs; and multi-threat encounters. The scenarios should also include demonstrations of the consequences of not responding to RAs, slow or late responses, and manoeuvring opposite to the direction called for by the displayed RA.
 - (3) Alternatively, exposure to these scenarios can be conducted by means of an interactive CBT with an ACAS display and controls similar in appearance and operation to those in the aircraft the pilot will fly. This interactive CBT should depict scenarios in which real-time responses should be made and a record made of whether or not each response was correct.
- (j) ACAS recurrent training
- (1) ACAS recurrent training ensures that flight crew members maintain the appropriate ACAS knowledge and skills. ACAS recurrent training should be integrated into and/or conducted in conjunction with other established recurrent training programmes. An essential item of recurrent training is the discussion of any significant issues and operational concerns that have been identified by the operator. Recurrent training should also address changes

to ACAS logic, parameters or procedures and to any unique ACAS characteristics which flight crew members should be made aware of.

- (2) It is recommended that the operator's recurrent training programmes using full flight simulators include encounters with conflicting traffic when these simulators are equipped with ACAS. The full range of likely scenarios may be spread over a 2-year period. If a full flight simulator, as described above, is not available, use should be made of interactive CBT that is capable of presenting scenarios to which pilot responses should be made in real time.

CAT.OP.MPA.300 Approach and landing conditions

Regulation (EU) 2021/2237

Before commencing an approach operation, the commander shall be satisfied that:

- (a) the meteorological conditions at the aerodrome or operating site and the condition of the runway/FATO intended to be used will not prevent a safe approach, landing or go-around, considering the performance information contained in the operations manual; and
- (b) the selected aerodrome operating minima are consistent with all of the following:
 - (1) the operative ground equipment;
 - (2) the operative aircraft systems;
 - (3) the aircraft performance;
 - (4) flight crew qualifications.

AMC1 CAT.OP.MPA.300(a) Approach and landing conditions - aeroplanes

ED Decision 2021/005/R

LANDING DISTANCE ASSESSMENT

- (a) The in-flight landing distance assessment should be based on the latest available weather report and runway condition report (RCR) or equivalent information based on the RCR.
- (b) The assessment should be initially carried out when the weather report and the RCR are obtained, usually around top of descent. If the planned duration of the flight does not allow the flight crew to carry out the assessment in non-critical phases of flight, the assessment should be carried out before departure.
- (c) When meteorological conditions may lead to a degradation of the runway surface condition, the assessment should include consideration of how much deterioration in runway surface friction characteristics may be tolerated, so that a quick decision can be made prior to landing.
- (d) The flight crew should monitor the evolution of the actual conditions during the approach, to ensure that they do not degrade below the condition that was previously determined to be the minimum acceptable.

GM1 CAT.OP.MPA.300(a) Approach and landing conditions — aeroplanes

ED Decision 2021/005/R

WIND DATA

The information on wind contained in METAR/SPECI/ATIS reports (average of a 10-minute period) should be the basis for the landing performance calculations, while instant wind information reported by the tower should be monitored during the approach to ensure that the wind speed does not exceed the assumptions made for landing performance calculations.

CAT.OP.MPA.301 Approach and landing conditions – helicopters

Regulation (EU) 2020/1176

Before commencing an approach to land, the commander shall be satisfied that according to the information available to him or her, the weather at the aerodrome and the condition of the final approach and take-off area (FATO) intended to be used would not prevent a safe approach, landing or missed approach, having regard to the performance information contained in the operations manual (OM).

AMC1 CAT.OP.MPA.301 Approach and landing conditions — helicopters

ED Decision 2021/005/R

IN-FLIGHT DETERMINATION OF THE CONDITION OF THE FATO

The in-flight determination of the final approach and take-off area (FATO) suitability for a safe approach, landing or missed approach should be based on the latest available meteorological or runway condition report, preferably no more than 30 minutes before the expected landing time.

CAT.OP.MPA.303 In-flight check of the landing distance at time of arrival – aeroplanes

Regulation (EU) 2020/1176

- (a) No approach to land shall be continued unless the landing distance available (LDA) on the intended runway is at least 115 % of the landing distance at the estimated time of landing, determined in accordance with the performance information for the assessment of the landing distance at time of arrival (LDTA) and the approach to land is performed with performance class A aeroplanes that are certified in accordance with either of the following certification specifications, as indicated in the type-certificate:
- (1) CS-25 or equivalent;
 - (2) CS-23 at level 4 with performance level “High speed” or equivalent.
- (b) For performance class A aeroplanes other than those referred to in point (a), no approach to land shall be continued, except in either of the following situations:
- (1) the LDA on the intended runway is at least 115 % of the landing distance at the estimated time of landing, determined in accordance with the performance information for the assessment of the LDTA;
 - (2) if performance information for the assessment of the LDTA is not available, the LDA on the intended runway at the estimated time of landing is at least the required landing

- distance determined in accordance with point CAT.POL.A.230 or point CAT.POL.A.235, as applicable.
- (c) For performance class B aeroplanes, no approach to land shall be continued, except in either of the following situations:
- (1) the LDA on the intended runway is at least 115 % of the landing distance at the estimated time of landing, determined in accordance with the performance information for the assessment of the LDTA;
 - (2) if performance information for the assessment of the LDTA is not available, the LDA on the intended runway at the estimated time of landing is at least the required landing distance determined in accordance with point CAT.POL.A.330 or point CAT.POL.A.335, as applicable.
- (d) For performance class C aeroplanes, no approach to land shall be continued, except in either of the following situations:
- (1) the LDA on the intended runway is at least 115 % of the landing distance at the estimated time of landing, determined in accordance with the performance information for the assessment of the LDTA;
 - (2) if performance information for the assessment of the LDTA is not available, the LDA on the intended runway at the estimated time of landing is at least the required landing distance determined in accordance with point CAT.POL.A.430 or point CAT.POL.A.435, as applicable.
- (e) Performance information for the assessment of the LDTA shall be based on approved data contained in the AFM. When approved data contained in the AFM are insufficient in respect of the assessment of the LDTA, they shall be supplemented with other data which are either determined in accordance with the applicable certification standards for aeroplanes or determined in line with the AMCs issued by the Agency.
- (f) The operator shall specify in the OM the performance information for the assessment of the LDTA and the assumptions made for its development, including other data that, in accordance with point (e), may be used to supplement that contained in the AFM.

AMC1 CAT.OP.MPA.303 In-flight check of the landing distance at time of arrival — aeroplanes

ED Decision 2021/005/R

ASSESSMENT OF THE LDTA BASED ON DISPATCH CRITERIA

- (a) The required landing distance for dry runways, determined in accordance with CAT.POL.A.230(a), contains adequate margin to fulfil the intent of the assessment of the landing distance at time of arrival (LDTA) on a dry runway, as it includes allowance for the additional parameters considered in that calculation.
- (b) The required landing distance for wet runways also contains adequate margin to fulfil the intent of the assessment of the LDTA on such runways with specific friction-improving characteristics, as it includes allowance for the additional parameters considered in that calculation.
- (c) When at the time of arrival the runway is dry or is a wet runway with specific friction-improving characteristics and the overall conditions, including weather at the aerodrome and runway condition, have been confirmed as not changed significantly compared to those assumed at the

time of dispatch, the assessment of the LDTA may be carried out by confirming that the assumptions made at the time of dispatch are still valid.

- (d) Before taking any performance credit for the assessment of the LDTA for runways with friction-improving characteristics, the operator should verify that the runways intended to be operated on are maintained to the extent necessary to ensure the expected improved friction characteristics.

GM1 CAT.OP.MPA.303 In-flight check of the landing distance at time of arrival — aeroplanes

ED Decision 2021/005/R

GENERAL

The assessment of the LDTA begins with the acquisition of the latest available weather information and the RCR. The information provided in the RCR is divided in two sections:

- (a) The ‘aircraft performance’ section which contains information that is directly relevant in a performance computation.
- (b) The ‘situational awareness’ section which contains information that the flight crew should be aware of for a safe operation, but which does not have a direct impact on the performance assessment.

The ‘aircraft performance’ section of the RCR includes a runway condition code (RWYCC), the contaminant type, depth and coverage for each third of the runway.

The determination of the RWYCC is based on the use of the runway condition assessment matrix (RCAM); however, the presentation of the information in the RCAM is appropriate for use by aerodrome personnel trained and competent in assessing the runway condition in a way that is relevant to aircraft performance.

It is the task of the aerodrome personnel to report the appropriate RWYCC in order to allow the flight crew to assess the landing performance characteristics of the runway in use. When no RWYCC is available in winter conditions, the RCAM provides the flight crew with a combination of the relevant information (runway surface conditions: state and/or contaminant or pilot report of braking action (AIREP)) in order to determine the RWYCC.

Table 1 below is an excerpt of the RCAM and permits to carry out the primary assessment based on the reported contaminant type and depth, as well as on the OAT.

Table 1: Association between the runway surface condition and the RWYCC based on the reported contaminant type and depth and on the OAT

Runway surface condition	Surface condition descriptor	Depth	Notes	RWYCC
Dry		n/a		6
Wet	Damp (any visible dampness)	3 mm or less	Including wet and contaminated runways below 25 % coverage in each runway third	5
	Wet			

Slippery wet				3	
Contaminated	Compacted snow	Any	At or below OAT – 15 °C	3	
			Above OAT – 15 °C	3	
	Dry snow	3 mm or less		5	
			More than 3 mm up to 100 mm	Including when any depth occurs on top of compacted snow	3
			Any	On top of ice	02
	Frost ¹	Any		5	
	Ice	Any	In cold and dry conditions	1	
	Slush	3 mm or less		5	
			More than 3 mm up to 15 mm		2
	Standing water	3 mm or less		5	
			More than 3 mm up to 15 mm		2
			Any	On top of ice	02
	Wet ice	Any		02	
	Wet snow	3 mm or less		5	
			More than 3 mm up to 30 mm	Including when any depth occurs on top of compacted snow	3
Any			On top of ice	02	

Note 1: Under certain conditions, frost may cause the surface to become very slippery.

Note 2: Operations in conditions where less-than-poor braking action prevails are prohibited.

Note 3: The runway surface temperature should preferably be used where available.

A primary assessment may have to be downgraded by the aerodrome operator based on an AIREP of lower braking action than the one typically associated with the type and depth of contaminant on the runway or any other observation.

Upgrading a RWYCC 5, 4, 3 or 2 determined by the aerodrome operator from the observed contaminant type is not allowed.

A RWYCC 1 or 0 maybe be upgraded by the aerodrome operator to a maximum of RWYCC 3. The reason for the upgrade will be specified in the ‘situational awareness’ section of the RCR.

When the aerodrome operator is approved for operations on specially prepared winter runways, in accordance with Annex V (Part-ADR.OPS) to Regulation (EU) No 139/2014, the RWYCC of a runway that is contaminated with compacted snow or ice, may be reported as RWYCC 4 depending upon a specific treatment of the runway. In such cases, the reason for the upgrade will be specified in the ‘situational awareness’ section of the RCR. When the aerodrome operator is approved for specially prepared winter runways, in accordance with Annex IV (Part-ADR.OPS) to Regulation (EU) No 139/2014, a runway that is contaminated with compacted snow or ice and has been treated according to specific procedures, will normally be reported as a maximum of RWYCC 4 SPECIALLY PREPARED WINTER RUNWAY. If the aerodrome operator is in doubt about the quality of the surface, it will be reported with a lower RWYCC, but the runway descriptor will still be SPECIALLY PREPARED WINTER RUNWAY. The term DOWNGRADED will be used in the ‘situational awareness’ section of the RCR. A SPECIALLY PREPARED WINTER RUNWAY has no loose contaminant; hence no contaminant drag on acceleration, and stopping performance corresponding to the reported RWYCC.

Performance information for the assessment of the LDTA correlates the aircraft performance with the RWYCC contained in the RCR, hence the calculation will be based on the RWYCC of the intended runway of landing.

GM2 CAT.OP.MPA.303 In-flight check of the landing distance at time of arrival — aeroplanes

ED Decision 2021/005/R

RUNWAY CONDITION CONSIDERATIONS

When available for the portion of the runway that will be used for landing, the following elements are relevant for consideration:

- (a) RWYCC;
- (b) expected runway conditions (contaminant type and depth);
- (c) other information contained in the RCR related to the following elements:
 - (1) width of the runway to which the RWYCC applies if less than the published runway width;
 - (2) reduced runway length;
 - (3) drifting snow on the runway;
 - (4) loose sand on the runway;
 - (5) chemical treatment on the runway;
 - (6) snowbanks on the runway;
 - (7) snowbanks on taxiways;
 - (8) snowbanks adjacent to the runway;
 - (9) taxiway conditions;
 - (10) apron conditions;
 - (11) State approved and published use of measured friction coefficient;
 - (12) plain language remarks;
- (d) AIREP of braking action.

AIRCRAFT PERFORMANCE CONSIDERATIONS

The following elements may impact landing distance calculations:

- (a) runway slope;
- (b) aerodrome elevation;
- (c) wind;
- (d) temperature;
- (e) aeroplane mass and configuration;
- (f) approach speed at threshold;
- (g) eventual adjustments to the landing distance, such as autoland; and
- (h) planned use of available and operative aeroplane ground deceleration devices.

AUTOBRAKE USAGE

While autobrakes are a part of the aeroplane's landing configuration, the landing distance assessment at the time of arrival is not intended to force a higher-than-necessary autobrake selection. For operations where the RWYCC is 6 or 5, if the manual braking distance provides at least 15 % safety margin, then the braking technique may include a combination of autobrakes and manual braking even if the selected autobrake landing data does not provide a 15 % safety margin.

GENERAL

Background information and further guidance on the in-flight check of the LDTA may be found in ICAO Doc 10064 'Aeroplane Performance Manual'.

GM3 CAT.OP.MPA.303 In-flight check of the landing distance at time of arrival — aeroplanes*ED Decision 2021/005/R***RCR, RWYCC AND RCAM**

A detailed description of the RCR format and content, the RWYCC and the RCAM may be found in Annex V (Part-ADR.OPS) to Regulation (EU) No 139/2014. Further guidance may be found in the following documents:

- (a) ICAO Doc 9981 'PANS Aerodromes';
- (b) ICAO Doc 4444 'PANS ATM';
- (c) ICAO Doc 10064 'Aeroplane Performance Manual'; and
- (d) ICAO Circular 355 'Assessment, Measurement and Reporting of Runway Surface Conditions'.

AMC1 CAT.OP.MPA.303(e) In-flight check of the landing distance at time of arrival — aeroplanes*ED Decision 2021/005/R***PERFORMANCE INFORMATION FOR THE ASSESSMENT OF THE LDTA — APPROVED DATA**

Approved data for the assessment of the LDTA contained in the AFM should be developed in accordance with AMC 25.1592, or equivalent.

PERFORMANCE INFORMATION FOR THE ASSESSMENT OF THE LDTA — SUPPLEMENTARY DATA

When approved data for the assessment of the LDTA contained in the AFM is insufficient, the content of the AFM should be supplemented with one of the following sets of data, provided by the aircraft manufacturer or the type certificate holder (TCH) or an organisation approved under Part 21 and having the relevant privileges within the scope of its organisation approval:

- (a) Data for the assessment of the LDTA produced for aeroplanes not having CS 25.1592 or equivalent in their certification basis. Such data may be presented in terms of runway surface conditions, pilot-reported braking actions, or both, and should include at least:
 - (1) an operational airborne distance;
 - (2) the range of braking actions as related to the RWYCC;
 - (3) the effect of speed increments over threshold;
 - (4) the effect of temperature; and

(5) the effect of runway slope.

When data is provided only in terms of pilot-reported braking actions, instructions should be provided on how to use such data to carry out an assessment of the LDTA in terms of a runway surface condition description.

- (b) Data developed in accordance with FAA AC 25-32.
- (c) Data for wet runways corrected to meet the criteria of LDTA, as listed under point (a), in accordance with a methodology provided by the aircraft manufacturer or the type certificate holder (TCH) or an organisation approved under Part 21 and having the relevant privileges in the scope of its organisation approval.
- (d) Data for contaminated runways developed in compliance with CS 25.1591 or equivalent, which were in use before the implementation of the LDTA, and are corrected to meet the criteria of the LDTA, as listed under point (a), in accordance with a methodology provided by the aircraft manufacturer or the TCH or an organisation approved under Part 21 and having the relevant privileges within the scope of its organisation approval.

PERFORMANCE INFORMATION FOR THE ASSESSMENT OF THE LDTA — DATA DETERMINED BY EASA

When there is no data available for the assessment of the LDTA, performance information for the assessment of the LDTA may be determined by applying the following method:

- (a) Correction factors may be applied to the certified landing distances on dry runway published in the AFM for turbojet-powered aeroplanes and turbopropeller-powered aeroplanes.
- (b) For this purpose, the landing distance factors (LDFs) from Table 1 below may be used:

Table 1: LDFs

Runway condition code (RWYCC)	6	5	4	3	2	1
Runway descriptors	Note 1	Note 1	Note 1	Note 1	Note 1	Note 1
Turbojet without reverse	1.67	2.6	2.8	3.2	4.0	5.1
Turbojet with all reversers operating	1.67	2.2	2.3	2.5	2.9	3.4
Turboprop (see Note 2)	1.67	2.0	2.2	2.4	2.7	2.9

Note 1: Runway descriptors may be found in the RCAM for each RWYCC or braking action.

Note 2: These LDFs apply only to modern turboprops with efficient disk drag. For older turboprops without adequate disk drag, use the LDFs for turbojet without reverse.

Note 3: The LDFs can apply to any type of anti-skid system, i.e. fully-modulating, quasi-modulating or on-off system.

- (1) To find the LD_{TA}, multiply the AFM (dry, unfactored) landing distance by the applicable LDFs from Table 1 above for the runway conditions existing at the time of arrival. If the AFM landing distances are presented as factored landing distances, then that data needs to be adjusted to remove the applicable dispatch factors applied to that data before the LDFs from Table 1 above are applied.

Note 1: Dispatch factors that are sometimes applied in AFMs to landing distances in order to provide factored distances to operators are not intended to be cumulated with the LDFs for the calculation of the LD_{TA}.

- (2) The LDFs given in Table 1 above include a 15 % safety margin and an air distance representative of normal operational practices. They account for variations of temperature up to international standard atmosphere (ISA) + 20 °C, runway slopes between -2 % and +2 %, and an average approach speed increment of 5 up to 20 kt. They may not be conservative for all configurations in case of unfavourable combinations of these parameters.

CAT.OP.MPA.305 Commencement and continuation of approach

Regulation (EU) 2021/2237

- (a) For aeroplanes, if the reported visibility (VIS) or controlling RVR for the runway to be used for landing is less than the applicable minimum, then an instrument approach operation shall not be continued:
 - (1) past a point at which the aeroplane is 1 000 ft above the aerodrome elevation; or
 - (2) into the final approach segment (FAS) if the DH or MDH is higher than 1 000 ft.
- (b) For helicopters, if the reported RVR is less than 550 m and the controlling RVR for the runway to be used for landing is less than the applicable minimum, then an instrument approach operation shall not be continued:
 - (1) past a point at which the helicopter is 1 000 ft above the aerodrome elevation; or
 - (2) into the FAS if the DH or MDH is higher than 1 000 ft.
- (c) If the required visual reference is not established, then a missed approach shall be executed at or before the DA/H or the MDA/H.
- (d) If the required visual reference is not maintained after DA/H or MDA/H, then a go-around shall be executed promptly.
- (e) Notwithstanding point (a), in the case where no RVR is reported, and the reported VIS is less than the applicable minimum, but the converted meteorological visibility (CMV) is equal or greater than the applicable minimum, then the instrument approach can be continued to the DA/H or MDA/H.

GM1 CAT.OP.MPA.305 Commencement and continuation of approach

ED Decision 2022/012/R

APPLICATION OF RVR OR VIS REPORTS — AEROPLANES

- (a) There is no prohibition on the commencement of an approach based on the reported RVR or VIS. The restriction in [CAT.OP.MPA.305](#) applies only if the RVR or VIS is reported and applies to the continuation of the approach past a point where the aircraft is 1 000 ft above the aerodrome elevation or in the FAS, as applicable.

APPLICATION OF RVR OR VIS REPORTS — HELICOPTERS

- (b) There is no prohibition on the commencement of an approach based on the reported RVR. The restriction in [CAT.OP.MPA.305](#) applies to the continuation of the approach past a point where the aircraft is 1 000 ft above the aerodrome elevation or in the final approach segment as applicable.

The prohibition to continue the approach applies only if the RVR is reported and it is below 550 m and below the operating minima. There is no prohibition based on VIS.

- (c) If the reported RVR is 550 m or greater, but it is less than the RVR calculated in accordance with [AMC5 CAT.OP.MPA.110](#), a go-around is likely to be necessary since visual reference may not be established at the DH or MDH. Similarly, in the absence of an RVR report, the reported visibility or a digital image may indicate that a go-around is likely. The commander should consider the available options, based on a thorough assessment of risk, such as diverting to an alternate, before commencing the approach.

APPLICATION OF RVR OR VIS REPORTS — ALL AIRCRAFT

- (d) If a deterioration in the RVR or VIS is reported once the aircraft is below 1 000 ft or in the FAS, as applicable, then there is no requirement for the approach to be discontinued. In this situation, the normal visual reference requirements would apply at the DA/H.
- (e) Where additional RVR information is provided (e.g. midpoint and stop end), this is advisory; such information may be useful to the pilot in order to determine whether there will be sufficient visual reference to control the aircraft during roll-out and taxi. For operations where the aircraft is controlled manually during roll-out, Table 1 in [AMC1 SPA.LVO.100\(a\)](#) provides an indication of the RVR that may be required to allow manual lateral control of the aircraft on the runway.

AMC1 CAT.OP.MPA.305(a) Commencement and continuation of approach

ED Decision 2022/012/R

MINIMUM RVR FOR CONTINUATION OF APPROACH — AEROPLANES

- (a) The touchdown RVR should be the controlling RVR.
- (b) If the touchdown RVR is not reported, then the midpoint RVR should be the controlling RVR.
- (c) Where the RVR is not available, CMV should be used except for the purpose of continuation of an approach in LVO in accordance with [AMC10 CAT.OP.MPA.110](#).

AMC1 CAT.OP.MPA.305(b) Commencement and continuation of approach

ED Decision 2022/012/R

MINIMUM RVR FOR CONTINUATION OF APPROACH — HELICOPTERS

- (a) The touchdown RVR should be the controlling RVR.
- (b) If the touchdown RVR is not reported, then the midpoint RVR should be the controlling RVR.

AMC1 CAT.OP.MPA.305(c) Commencement and continuation of approach

ED Decision 2022/012/R

VISUAL REFERENCES FOR INSTRUMENT APPROACH OPERATIONS

For instrument approach operations Type A and CAT I instrument approach operations Type B, at least one of the visual references specified below should be distinctly visible and identifiable to the pilot at the MDA/H or the DA/H:

- (a) elements of the approach lighting system;
- (b) the threshold;
- (c) the threshold markings;
- (d) the threshold lights;
- (e) the threshold identification lights;
- (f) the visual glide path indicator;
- (g) the TDZ or TDZ markings;
- (h) the TDZ lights;
- (i) the FATO/runway edge lights; or
- (j) for helicopter PinS approaches, the identification beacon light and visual ground reference;
- (k) for helicopter PinS approaches, the identifiable elements of the environment defined on the instrument chart;
- (l) for helicopter PinS approaches with instructions to 'proceed VFR', sufficient visual cues to determine that VFR criteria are met; or
- (m) other visual references specified in the operations manual.

CAT.OP.MPA.310 Operating procedures — threshold crossing height — aeroplanes

Regulation (EU) 2021/2237

The operator shall establish operational procedures designed to ensure that an aeroplane conducting 3D instrument approach operations crosses the threshold of the runway by a safe margin, with the aeroplane in the landing configuration and attitude.

CAT.OP.MPA.311 Reporting on runway braking action

Regulation (EU) 2020/1176

Whenever the runway braking action encountered during the landing roll is not as good as that reported by the aerodrome operator in the runway condition report (RCR), the commander shall notify the air traffic services (ATS) by means of a special air-report (AIREP) as soon as practicable.

AMC1 CAT.OP.MPA.311 Reporting on runway braking action

ED Decision 2021/005/R

GENERAL

Since both the ATC and the aerodrome operator rely on accurate braking action reports, flight crew should use standardised terminology in accordance with ICAO Doc 4444 'PANS ATM'.

The following Table 1 shows the correlation between the terminology to be used in the AIREP to report the braking action and the RWYCC.

Table 1: Association between AIREP and RWYCC

AIREP (braking action)	Description	RWYCC
N/A		6
GOOD	Braking deceleration is normal for the wheel braking effort applied AND directional control is normal.	5
GOOD TO MEDIUM	Braking deceleration OR directional control is between good and medium.	4
MEDIUM	Braking deceleration is noticeably reduced for the wheel braking effort applied OR directional control is noticeably reduced.	3
MEDIUM TO POOR	Braking deceleration OR directional control is between medium and poor.	2
POOR	Braking deceleration is significantly reduced for the wheel braking effort applied OR directional control is significantly reduced.	1
LESS THAN POOR	Braking deceleration is minimal to non-existent for the wheel braking effort applied OR directional control is uncertain.	0

An AIREP should be transmitted to the ATC, in accordance with one of the following specifications, as applicable:

- Good braking action is reported as 'BRAKING ACTION GOOD'.
- Good to medium braking action is reported as 'BRAKING ACTION GOOD TO MEDIUM'.
- Medium braking action is reported as 'BRAKING ACTION MEDIUM'.
- Medium to poor braking action is reported as 'BRAKING ACTION MEDIUM TO POOR'.
- Poor braking action is reported as 'BRAKING ACTION POOR'.
- Less than poor braking action is reported as 'BRAKING ACTION LESS THAN POOR'.

In some cases, the differences between two consecutive levels of the six braking action categories between 'Good' and 'Less than Poor' may be too subtle for the flight crew to detect. It is therefore acceptable for the flight crew to report on a more coarse scale of 'Good', 'Medium' and 'Poor'.

Whenever requested by ATC, or if the braking action encountered during the landing roll is not as previously reported by the aerodrome operator in the RCR, pilots should provide a braking action report. This is especially important and safety relevant where the experienced braking action is worse than the braking action associated with any RWYCC code currently in effect for the portion of the runway concerned.

When the braking action experienced during landing is better than that reported by the aerodrome operator, it is also relevant to report this information, which may trigger further actions for the aerodrome operator in order to update the RCR.

If an aircraft-generated braking action report is available, it should be transmitted, identifying its origin accordingly. If the flight crew have a reason to modify the aircraft-generated braking action report based on their judgement, the commander should be able to amend such report.

A braking action AIREP of 'Less than Poor' leads to a runway closure until the aerodrome operator can improve the runway condition.

An air safety report should be submitted whenever flight safety has been endangered due to low braking action.

GM1 CAT.OP.MPA.311 Reporting on runway braking action

ED Decision 2021/005/R

GENERAL

The role of the flight crew in the runway surface condition reporting process does not end once a safe landing has been achieved. While the aerodrome operator is responsible for generating the RCR, flight crew are responsible for providing accurate braking action reports.

The flight crew braking action reports provide feedback to the aerodrome operator regarding the accuracy of the RCR resulting from the observed runway surface conditions.

ATC passes these braking action reports to the aerodrome operator, which in turn uses them in conjunction with the RCAM to determine if it is necessary to downgrade or upgrade the RWYCC.

During busy times, runway inspections and maintenance may be less frequent and need to be sequenced with arrivals. Therefore, aerodrome operators may depend on braking action reports to confirm that the runway surface condition is not deviating significantly from the published RCR.

AMC1 CAT.OP.MPA.303 & CAT.OP.MPA.311 In-flight check of the landing distance at time of arrival — aeroplanes & Reporting on runway braking action

ED Decision 2021/005/R

FLIGHT CREW TRAINING

Flight crew members should be trained on the use of the RCR, on the use of performance data for the assessment of the LDTA and on reporting braking action using the AIREP format.

GM1 CAT.OP.MPA.303 & CAT.OP.MPA.311 In-flight check of the landing distance at time of arrival — aeroplanes & Reporting on runway braking action

ED Decision 2021/005/R

SYLLABUS

A training syllabus should include, in addition to the requirements of Subpart FC of Annex III (ORO.FC), at least the following elements:

- (a) General
 - (1) Contamination
 - (i) Definition
 - (ii) Contaminants which cause increased drag thus affecting acceleration, and contaminants which cause reduced braking action affecting deceleration
 - (iii) Slippery when wet condition
 - (2) Contaminated runway
 - (i) Runway surface condition descriptors
 - (ii) Operational observations with friction devices
 - (iii) Operator's policy on the usage of:
 - A. reduced take-off thrust
 - B. reports by runway thirds
 - (iv) Stopway
 - (3) Runway condition codes
 - (i) RCAM
 - A. Differences between those published for aerodromes and flight crew
 - B. Format in use
 - C. The use of runway friction measurements
 - D. The use of temperature
 - E. RWYCC
 - F. Downgrade/upgrade criteria
 - G. Difference between a calculation and an assessment
 - (ii) Braking action
 - (iii) Use of aircraft wind limit diagram with contamination
 - (4) Runway condition report
 - (i) Availability
 - (ii) Validity
 - (iii) Performance and situational awareness
 - (iv) Decoding

- (v) Promulgation and reception
- (5) Aeroplane control in take-off and landing
 - (i) Lateral control
 - A. Windcock effect
 - B. Effect of reversers
 - C. Cornering forces
 - D. Crosswind limitations (including operations when the cleared runway width is less than published)
 - (ii) Longitudinal control
 - A. V1 correction in correlation with minimum control speed on ground
 - B. Aquaplaning
 - C. Anti-skid
 - D. Autobrake
- (6) Take-off distance
 - (i) Acceleration and deceleration
 - (ii) Take-off performance limitations
 - (iii) Take-off distance models
 - (iv) Factors affecting TO distance
 - (v) Why to use the type and depth of contaminant instead of the RWYCC
 - (vi) Safety margins
- (7) Landing distance
 - (i) Distance at time of arrival model
 - (ii) Factors affecting landing distance
 - (iii) Safety margins
- (8) Exceptions
 - (i) States that do not comply with ICAO standards for RCR and assessment of the LDTA
- (b) Flight planning
 - (1) Dispatch/in-flight conditions
 - (2) MEL/CDL items affecting take-off and landing performance
 - (3) Operator's policy on variable wind and gusts
 - (4) Landing performance at destination and alternates
 - (i) Selection of alternates if an aerodrome is not available
 - A. En-route alternates
 - B. Destination alternates
 - (ii) Number of alternates

- (iii) Runway condition
- (c) Take-off
 - (1) Runway selection
 - (2) Take-off from a wet or contaminated runway
- (d) In-flight
 - (1) Landing distance
 - (i) Distance at time of arrival calculations
 - A. Considerations for flight crew
 - B. Operator's policy
 - (ii) Factors affecting landing distance
 - (iii) Runway selection for landing
 - (iv) Safety margins
 - (2) Use of aircraft systems
 - (i) Brakes/autobrakes
 - (ii) Difference between friction limited braking and different modes of autobrakes
 - (iii) Reversers
- (e) Landing techniques
 - (1) Flight crew procedures and flying techniques when landing on length limited runway
- (f) Safety considerations
 - (1) Types of errors possible
 - (2) Mindfulness principles to avoid biases that may lead to errors
- (g) Documentation and records
- (h) AIREPs
 - (1) Assessment of braking action
 - (2) Terminology
 - (3) Automated/aircraft-generated braking action reports, if applicable
 - (4) Air safety reports, if flight safety has been endangered due to insufficient braking action

CAT.OP.MPA.312 EFVS 200 operations

Regulation (EU) 2021/2237

- (a) An operator that intends to conduct EFVS 200 operations shall ensure that:
 - (1) the aircraft is certified for the intended operations;
 - (2) only runways, FATO and instrument approach procedures (IAPs) suitable for EFVS operations are used;

- (3) the flight crew members are competent to conduct the intended operation, and a training and checking programme for the flight crew members and relevant personnel involved in the flight preparation is established;
 - (4) operating procedures are established;
 - (5) any relevant information is documented in the minimum equipment list (MEL);
 - (6) any relevant information is documented in the maintenance programme;
 - (7) safety assessments are carried out and performance indicators are established to monitor the level of safety of the operation; and
 - (8) the aerodrome operating minima take into account the capability of the system used.
- (b) The operator shall not conduct EFVS 200 operations when conducting LVOs.
- (c) Notwithstanding point (a)(1), the operator may use EVSs meeting the minimum criteria to conduct EFVS 200 operations, provided that this is approved by the competent authority.

GM1 CAT.OP.MPA.312 EFVS 200 operations

ED Decision 2022/012/R

GENERAL

- (a) EFVS operations exploit the improved visibility provided by the EFVS to extend the visual segment of an instrument approach. EFVSs cannot be used to extend the instrument segment of an approach and thus the DH for EFVS 200 operations is always the same as for the same approach conducted without EFVS.
- (b) Equipment for EFVS 200 operations
- (1) In order to conduct EFVS 200 operations, a certified EFVS is used (EFVS-A or EFVS-L). An EFVS is an enhanced vision system (EVS) that also incorporates a flight guidance system and displays the image on a head-up display (HUD) or equivalent display. The flight guidance system will incorporate aircraft flight information and flight symbology.
 - (2) In multi-pilot operations, a suitable display of EFVS sensory imagery is provided to the pilot monitoring.
- (c) Suitable approach procedures
- (1) Types of approach operation are specified in [AMC1 CAT.OP.MPA.312\(a\)\(2\)](#)
EFVS 200 operations should be conducted as 3D approach operations. This may include operations based on NPA procedures, approach procedures with vertical guidance and precision approach procedures including approach operations requiring specific approvals, provided that the operator holds the necessary approvals.
 - (2) Offset approaches
Refer to [AMC1 CAT.OP.MPA.312\(a\)\(2\)](#).
 - (3) Circling approaches
EFVSs incorporate a HUD or an equivalent system so that the EFVS image of the scene ahead of the aircraft is visible in the pilot's forward external FOV. Circling operations require the pilot to maintain visual references that may not be directly ahead of the aircraft and may not be aligned with the current flight path. EFVSs cannot therefore be used in place of natural visual reference for circling approaches.

- (d) Aerodrome operating minima for EFVS 200 operations determined in accordance with [AMC1 CAT.OP.MPA.312\(a\)\(8\)](#)

The performance of EFVSs depends on the technology used and weather conditions encountered. Table 1 'Operations utilising EFVS: RVR reduction' has been developed after an operational evaluation of two different EVSs both using infrared sensors, along with data and support provided by the FAA. Approaches were flown in a variety of conditions including fog, rain and snow showers, as well as at night to aerodromes located in mountainous terrain. Table 1 contains conservative figures to cater for the expected performance of infrared sensors in the variety of conditions that might be encountered. Some systems may have better capability than those used for the evaluation, but credit cannot be taken for such performance in EFVS 200 operations.

- (e) The conditions for commencement and continuation of the approach in accordance with [CAT.OP.MPA.305](#)

Pilots conducting EFVS 200 operations may commence an approach and continue that approach below 1 000 ft above the aerodrome or into the FAS if the reported RVR or CMV is equal to or greater than the lowest RVR minima determined in accordance with [AMC1 CAT.OP.MPA.312\(a\)\(8\)](#) and if all the conditions for the conduct of EFVS 200 operations are met.

Should any equipment required for EFVS 200 operations be unserviceable or unavailable, the conditions to conduct EFVS 200 operations would not be satisfied, and the approach should not be commenced. In the event of failure of the equipment required for EFVS 200 operations after the aircraft descends below 1 000 ft above the aerodrome or into the FAS, the conditions of [CAT.OP.MPA.305](#) would no longer be satisfied unless the RVR reported prior to commencement of the approach was sufficient for the approach to be flown without EFVS in lieu of natural vision.

- (f) EFVS image requirements at the DA/H specified in [AMC1 CAT.OP.MPA.312\(a\)\(4\)](#)

The requirements for features to be identifiable on the EFVS image in order to continue the approach below the DH are more stringent than the visual reference requirements for the same approach flown without EFVS. The more stringent standard is needed because the EFVS might not display the colour of lights used to identify specific portions of the runway and might not consistently display the runway markings. Any visual approach path indicator using colour-coded lights may be unusable.

- (g) Obstacle clearance in the visual segment

The 'visual segment' is the portion of the approach between the DH or the MAPt and the runway threshold. In the case of EFVS 200 operations, this part of the approach may be flown using the EFVS image as the primary reference and obstacles may not always be identifiable on an EFVS image. The operational assessment specified in [AMC1 CAT.OP.MPA.312\(a\)\(2\)](#) is therefore required to ensure obstacle clearance during the visual segment.

- (h) Visual reference requirements at 200 ft above the threshold

For EFVS 200 operations, natural visual reference is required by a height of 200 ft above the runway threshold. The objective of this requirement is to ensure that the pilot will have sufficient visual reference to land. The visual reference should be the same as that required for the same approach flown without EFVS.

Some EFVSs may have additional requirements that have to be fulfilled at this height to allow the approach to continue, such as a requirement to check that elements of the EFVS display

remain correctly aligned and scaled to the external view. Any such requirements will be detailed in the AFM and included in the operator's procedures.

(i) Specific approval for EFVS

In order to use an EFVS without natural visual reference below 200 ft above the threshold, the operator needs to hold a specific approval in accordance with Part-SPA.

(j) Go-around

A go-around will be promptly executed if the required visual references are not maintained on the EFVS image at any time after the aircraft has descended below the DA/H or if the required visual references are not distinctly visible and identifiable using natural vision after the aircraft is below 200 ft. It is considered more likely that an EFVS 200 operation could result in the initiation of a go-around below DA/H than the equivalent approach flown without EFVS, and thus the operational assessment required by [AMC1 CAT.OP.MPA.312\(a\)\(2\)](#) takes into account the possibility of a balked landing.

An obstacle free zone (OFZ) may be provided for CAT I precision approach procedures. Where an OFZ is not provided for a CAT I precision approach, this will be indicated on the approach chart. NPA procedures and approach procedures with vertical guidance (APV) provide obstacle clearance for the missed approach based on the assumption that a go-around is executed at the MAPt and not below the OCH.

AMC1 CAT.OP.MPA.312(a)(1) EFVS 200 operations

ED Decision 2022/012/R

EQUIPMENT CERTIFICATION

For EFVS 200 operations, the aircraft should be equipped with an approach system using EFVS-A or a landing system using EFVS-L.

AMC1 CAT.OP.MPA.312(a)(2) EFVS 200 operations

ED Decision 2022/012/R

AERODROMES AND INSTRUMENT PROCEDURES SUITABLE FOR EFVS 200 OPERATIONS

- (a) For EFVS 200 operations, the operator should verify the suitability of a runway before authorising EFVS operations to that runway through an operational assessment taking into account the following elements:
- (1) the obstacle situation;
 - (2) the type of aerodrome lighting;
 - (3) the available IAPs;
 - (4) the aerodrome operating minima; and
 - (5) any non-standard conditions that may affect the operations.
- (b) EFVS 200 operations should only be conducted as 3D operations, using an IAP in which the final approach track is offset by a maximum of 3 degrees from the extended centre line of the runway.
- (c) The IAP should be designed in accordance with PANS-OPS, Volume I (ICAO Doc 8168) or equivalent criteria.

AMC2 CAT.OP.MPA.312(a)(2) EFVS 200 operations

ED Decision 2022/014/R

VERIFICATION OF THE SUITABILITY OF RUNWAYS FOR EFVS 200 OPERATIONS

The operational assessment before authorising the use of a runway for EFVS 200 operations should be conducted as follows:

- (a) Check whether the runway has been promulgated as suitable for EFVS operations or is certified as a precision approach runway category II or III by the State of the aerodrome. If this is so, then check whether and where the approach and runway lights installed (notably incandescent or LED lights) are adequate for the EFVS equipment used by the operator.
- (b) If the check in point (a) above comes out negative (the runway is not promulgated as EFVS suitable or is not category II or III), then proceed as follows:
 - (1) For straight-in IAPs, US Standard for Terminal Instrument Procedures (TERPS)¹ may be considered to be acceptable as an equivalent to PANS-OPS. If other design criteria than those in PANS-OPS or US TERPS are used, the operations should not be conducted.
 - (2) If an OFZ is established, this will ensure adequate obstacle protection from 960 m before the threshold. If an OFZ is not established or if the DH for the approach is above 250 ft, then check whether there is a visual segment surface (VSS).
 - (3) VSSs are required for procedures published after 15 March 2007, but the existence of the VSS has to be verified through the aeronautical information publication (AIP), operations manual Part C, or direct contact with the aerodrome. Where the VSS is established, it may not be penetrated by obstacles. If the VSS is not established or is penetrated by obstacles and an OFZ is not established, then the operations should not be conducted. Note: obstacles of a height of less than 50 ft above the threshold may be disregarded when assessing the VSS.
 - (4) Runways with obstacles that require visual identification and avoidance should not be accepted.
 - (5) For the obstacle protection of a balked landing where an OFZ is not established, the operator may specify that pilots follow a departure procedure in the event of a balked landing, in which case it is necessary to verify that the aircraft will be able to comply with the climb gradients published for the instrument departure procedures for the expected landing conditions.
 - (6) Perform an assessment of the suitability of the runway which should include whether the approach and runway lights installed (notably incandescent or LED lights) are adequate for the EFVS equipment used by the operator.
- (c) If the AFM stipulates specific requirements for approach procedures, then the operational assessment should verify that these requirements can be met.

AMC1 CAT.OP.MPA.312(a)(3) EFVS 200 operations

ED Decision 2022/012/R

INITIAL TRAINING FOR EFVS 200 OPERATIONS

Operators should ensure that flight crew members complete the following conversion training before being authorised to conduct EFVS 200 operations unless credits related to training and checking for

¹ https://www.faa.gov/regulations_policies/orders_notices/index.cfm/go/document/information/documentID/1038173

previous experience on similar aircraft types are defined in the operational suitability data established in accordance with [Regulation \(EU\) No 748/2012](#):

- (a) A ground training course including at least the following:
 - (1) characteristics and limitations of HUDs or equivalent display systems including information presentation and symbology;
 - (2) EFVS sensor performance in different weather conditions, sensor limitations, scene interpretation, visual anomalies and other visual effects;
 - (3) EFVS display, control, modes, features, symbology, annunciations and associated systems and components;
 - (4) the interpretation of EFVS imagery;
 - (5) the interpretation of approach and runway lighting systems and display characteristics when using EFVS;
 - (6) pre-flight planning and selection of suitable aerodromes and approach procedures;
 - (7) principles of obstacle clearance requirements;
 - (8) the use and limitations of RVR assessment systems;
 - (9) normal, abnormal and emergency procedures for EFVS operations;
 - (10) the effect of specific aircraft/system malfunctions;
 - (11) human factors aspects of EFVS operations; and
 - (12) qualification requirements for pilots to obtain and retain approval for EFVS 200 operations.
- (b) An aircraft/FSTD training course in two phases as follows:
 - (1) Phase one (EFVS 200 operations with aircraft and all equipment serviceable) — objectives:
 - (i) understand the operation of equipment required for EFVS 200 operations;
 - (ii) understand operating limitations of the installed EFVS;
 - (iii) practise the use of HUD or equivalent display systems;
 - (iv) practise the set-up and adjustment of EFVS equipment in different conditions (e.g. day and night);
 - (v) practise the monitoring of automatic flight control systems, EFVS information and status annunciators;
 - (vi) practise the interpretation of EFVS imagery;
 - (vii) become familiar with the features needed on the EFVS image to continue approach below DH;
 - (viii) practise the identification of visual references using natural vision while using EFVS equipment;
 - (ix) master the manual aircraft handling relevant to EFVS operations including, where appropriate, the use of the flare cue and guidance for landing;
 - (x) practise coordination with other crew members; and

- (xi) become proficient at procedures for EFVS 200 operations.
- (2) Phase one of the training should include the following exercises:
- (i) the required checks for satisfactory functioning of equipment, both on the ground and in flight;
 - (ii) the use of HUD or equivalent display systems during at least approach, landing and go-around;
 - (iii) approach using the EFVSs installed on the aircraft to the appropriate DH and transition to natural vision for continuing approach and landing;
 - (iv) approach with all engines operating using the EFVS, down to the appropriate DH followed by a missed approach, all without external visual reference, as appropriate.
- (3) Phase two (EFVS 200 operations with aircraft and equipment failures and degradations) — objectives:
- (i) understand the effect of known aircraft unserviceabilities including use of the MEL;
 - (ii) understand the effect of failed or downgraded equipment on aerodrome operating minima;
 - (iii) understand the actions required in response to failures and changes in the status of the EFVS including HUD or equivalent display systems;
 - (iv) understand the actions required in response to failures above and below the DH;
 - (v) practise abnormal operations and incapacitation procedures; and
 - (vi) become proficient at dealing with failures and abnormal situations during EFVS 200 operations.
- (4) Phase two of the training should include the following exercises:
- (i) approaches with engine failures at various stages of the approach;
 - (ii) approaches with failures of the EFVS at various stages of the approach, including failures between the DH and the height below which an approach should not be continued if natural visual reference is not acquired, require either:
 - (A) reversion to head down displays to control missed approach; or
 - (B) reversion to flight with downgraded or no guidance to control missed approaches from the DH or below, including those which may result in a touchdown on the runway;
 - (iii) incapacitation procedures appropriate to EFVS 200 operations;
 - (iv) failures and procedures applicable to the specific EFVS installation and aircraft type; and
 - (v) FSTD training including minimum eight approaches.

AMC2 CAT.OP.MPA.312(a)(3) EFVS 200 operations

ED Decision 2022/012/R

RECURRENT TRAINING AND CHECKING FOR EFVS 200 OPERATIONS

- (a) The operator should ensure that the pilots' competence to perform EFVS 200 operations. To do so, pilots should be trained every 6 months by performing at least two approaches on each type of aircraft operated.
- (b) The operator should ensure that the pilots' competence to perform EFVS 200 operations is checked at each required operator proficiency check by performing at least two approaches on each type of aircraft operated, of which one should be flown without natural vision to 200 ft.

AMC3 CAT.OP.MPA.312(a)(3) EFVS 200 operations

ED Decision 2022/012/R

RECENT EXPERIENCE REQUIREMENTS FOR EFVS 200 OPERATIONS

Pilots should complete a minimum of four approaches using the operator's procedures for EFVS 200 operations during the validity period of the operator proficiency check unless credits related to currency are defined in the operational suitability data established in accordance with [Regulation \(EU\) No 748/2012](#).

AMC4 CAT.OP.MPA.312(a)(3) EFVS 200 operations

ED Decision 2022/012/R

DIFFERENCES TRAINING FOR EFVS 200 OPERATIONS

- (a) The operator should ensure that the flight crew members authorised to conduct EFVS 200 operations are provided with differences training or familiarisation whenever there is a change to any of the following:
 - (1) the technology used in the flight guidance and flight control system;
 - (2) the HUD or equivalent display systems;
 - (3) the operating procedures.
- (b) The differences training should:
 - (1) meet the objectives of the appropriate initial training course;
 - (2) take into account the flight crew members' previous experience; and
 - (3) take into account the operational suitability data established in accordance with [Regulation \(EU\) No 748/2012](#).

AMC5 CAT.OP.MPA.312(a)(3) EFVS 200 operations

ED Decision 2022/012/R

TRAINING FOR EFVS 200 OPERATIONS

If a flight crew member is to be authorised to operate as pilot flying and pilot monitoring during EFVS 200 operations, then the flight crew member should complete the required FSTD training for each operating capacity.

GM1 CAT.OP.MPA.312(a)(3) EFVS 200 operations

ED Decision 2022/012/R

RECURRENT CHECKING FOR EFVS 200 OPERATIONS

In order to provide the opportunity to practise decision-making in the event of system failures and failure to acquire natural visual reference, the recurrent training and checking for EFVS 200 operations is recommended to periodically include different combinations of equipment failures, go-around due to loss of visual reference, and landings.

AMC1 CAT.OP.MPA.312(a)(4) EFVS 200 operations

ED Decision 2022/012/R

OPERATING PROCEDURES FOR EFVS 200 OPERATIONS

- (a) When conducting EFVS 200 operations:
- (1) the pilot flying should use the EFVS throughout the approach;
 - (2) in multi-pilot operations, a suitable display of EFVS sensory imagery should be provided to the pilot monitoring;
 - (3) the approach between the FAF and the DA/H should be flown using vertical flight path guidance;
 - (4) the approach may be continued below the DA/H provided that the pilot can identify on the EFVS image either:
 - (i) the approach light system; or
 - (ii) both of the following:
 - (A) the runway threshold identified by the beginning of the runway landing surface, the threshold lights or the runway end identifier lights;
 - (B) the TDZ identified by the TDZ lights, the TDZ runway markings or the runway lights; and
 - (5) a missed approach should be executed promptly if the required visual reference is not distinctly visible and identifiable to the pilot without reliance on the EFVS by 200 ft above the threshold.
- (b) Operating procedures for EFVS 200 operations should:
- (1) be consistent with the AFM;
 - (2) be appropriate to the technology and equipment to be used;
 - (3) specify the duties and responsibilities of each flight crew member in each relevant phase of flight;
 - (4) ensure that the flight crew workload is managed to facilitate effective decision-making and monitoring of the aircraft; and
 - (5) deviate to the minimum extent practicable from normal procedures used for routine operations.
- (c) Operating procedures for EFVS 200 operations should include:
- (1) required checks for the satisfactory functioning of the aircraft equipment, both before departure and in flight;

- (2) correct seating and eye position;
 - (3) determination of aerodrome operating minima;
 - (4) required visual references at the DH;
 - (5) the action to be taken if natural visual reference is not acquired by 200 ft;
 - (6) the action to be taken in the event of loss of the required visual reference; and
 - (7) procedures for balked landing.
- (d) Operating procedures for EFVS 200 operations should be included in the operations manual.

AMC1 CAT.OP.MPA.312(a)(8) EFVS 200 operations

ED Decision 2022/012/R

AERODROME OPERATING MINIMA — EFVS 200 OPERATIONS

When conducting EFVS 200 operations:

- (a) the DA/H used should be the same as for operations without EFVS;
- (b) the lowest RVR minima to be used should be determined by reducing the RVR presented in:
 - (1) Table 9 in [AMC5 CAT.OP.MPA.110](#) in accordance with Table 1 below for aeroplanes;
 - (2) Table 13 in [AMC6 CAT.OP.MPA.110](#) in accordance with Table 1 below for helicopters;
- (c) in case of failed or downgraded equipment, Table 17 in [AMC11 CAT.OP.MPA.110](#) should apply.

Table 1

Operations utilising EFVS: RVR reduction

RVR presented in Table 9 in AMC5 CAT.OP.MPA.110 and Table 13 in AMC6 CAT.OP.MPA.110	RVR (m) for EFVS 200 operations
550	550
600	550
650	550
700	550
750	550
800	550
900	600
1 000	650
1 100	750
1 200	800
1 300	900
1 400	900
1 500	1 000
1 600	1 100
1 700	1 100
1 800	1 200
1 900	1 300
2 000	1 300
2 100	1 400
2 200	1 500

2 300	1 500
2 400	1 600

AMC1 CAT.OP.MPA.312(c) EFVS 200 operations

ED Decision 2022/012/R

EFVS 200 WITH EVSs MEETING THE MINIMUM CRITERIA

The EVS should be certified before 1 January 2022 as ‘EVS with an operational credit’.

GM1 CAT.OP.MPA.312(c) EFVS 200 operations

ED Decision 2022/012/R

The competent authority referred to in [CAT.OP.MPA.312](#) point (c) is the competent authority for the oversight of the operator, as established in [ORO.GEN.105](#).

CAT.OP.MPA.315 Flight hours reporting – helicopters

Regulation (EU) No 965/2012

The operator shall make available to the competent authority the hours flown for each helicopter operated during the previous calendar year.

GM1 CAT.OP.MPA.315 Flight hours reporting — helicopters

ED Decision 2014/015/R

FLIGHT HOURS REPORTING

- (a) The requirement in [CAT.OP.MPA.315](#) may be achieved by making available either:
- (1) the flight hours flown by each helicopter — identified by its serial number and registration mark — during the previous calendar year; or
 - (2) the total flight hours of each helicopter — identified by its serial number and registration mark — on the 31st of December of the previous calendar year.
- (b) Where possible, the operator should have available, for each helicopter, the breakdown of hours for CAT operations. If the exact hours for the functional activity cannot be established, the estimated proportion will be sufficient.

CAT.OP.MPA.320 Aeroplane categories

Regulation (EU) 2019/1384

- (a) Aeroplane categories shall be based on the indicated airspeed at threshold (V_{AT}) which is equal to the stalling speed (V_{SO}) multiplied by 1,3 or one-g (gravity) stall speed (V_{S1g}) multiplied by 1,23 in the landing configuration at the maximum certified landing mass. If both V_{SO} and V_{S1g} are available, the higher resulting V_{AT} shall be used.
- (b) The aeroplane categories specified in the table below shall be used.

Table 1: Aeroplane categories corresponding to V_{AT} values

Aeroplane category	V_{AT}
A	Less than 91 kt
B	From 91 to 120 kt

C	From 121 to 140 kt
D	From 141 to 165 kt
E	From 166 to 210 kt

- (c) The landing configuration that is to be taken into consideration shall be specified in the operations manual.
- (d) The operator may apply a lower landing mass for determining the V_{AT} if approved by the competent authority. Such a lower landing mass shall be a permanent value, independent of the changing conditions of day-to-day operations.

SUBPART C: AIRCRAFT PERFORMANCE AND OPERATING LIMITATIONS

SECTION 1 – AEROPLANES

CHAPTER 1 – GENERAL REQUIREMENTS

CAT.POL.A.100 Performance classes

Regulation (EU) No 965/2012

- (a) The aeroplane shall be operated in accordance with the applicable performance class requirements.
- (b) Where full compliance with the applicable requirements of this Section cannot be shown due to specific design characteristics, the operator shall apply approved performance standards that ensure a level of safety equivalent to that of the appropriate chapter.

CAT.POL.A.105 General

Regulation (EU) 2019/1387

- (a) The mass of the aeroplane:
 - (1) at the start of the take-off; or
 - (2) in the event of in-flight replanning, at the point from which the revised operational flight plan applies,shall not be greater than the mass at which the requirements of the appropriate chapter can be complied with for the flight to be undertaken. Allowance may be made for expected reductions in mass as the flight proceeds and for fuel jettisoning.
- (b) The approved performance data contained in the AFM shall be used to determine compliance with the requirements of the appropriate chapter, supplemented as necessary with other data as prescribed in the relevant chapter. The operator shall specify other data in the operations manual. When applying the factors prescribed in the appropriate chapter, account may be taken of any operational factors already incorporated in the AFM performance data to avoid double application of factors.
- (c) Due account shall be taken of aeroplane configuration, environmental conditions and the operation of systems that have an adverse effect on performance.
- (d) The operator shall take account of charting accuracy when assessing the take-off requirements of the applicable chapters.

CHAPTER 2 – PERFORMANCE CLASS A

CAT.POL.A.200 General

Regulation (EU) No 965/2012

- (a) The approved performance data in the AFM shall be supplemented as necessary with other data if the approved performance data in the AFM is insufficient in respect of items such as:

- (1) accounting for reasonably expected adverse operating conditions such as take-off and landing on contaminated runways; and
 - (2) consideration of engine failure in all flight phases.
- (b) For wet and contaminated runways, performance data determined in accordance with applicable standards on certification of large aeroplanes or equivalent shall be used.
- (c) The use of other data referred to in (a) and equivalent requirements referred to in (b) shall be specified in the operations manual.

AMC1 CAT.POL.A.200 General

ED Decision 2021/005/R

WET AND CONTAMINATED RUNWAY DATA

The determination of take-off performance data for wet and contaminated runways should be based on the reported runway surface condition in terms of contaminant and depth. The determination of landing performance data should be based on information provided in the OM on the reported RWYCC. The RWYCC is determined by the aerodrome operator using the RCAM and associated procedures defined in Annex V (Part-ADR.OPS) to Regulation (EU) No 139/2014. The RWYCC is reported through an RCR in the SNOWTAM format in accordance with ICAO Annex 15.

CAT.POL.A.205 Take-off

Regulation (EU) No 965/2012

- (a) The take-off mass shall not exceed the maximum take-off mass specified in the AFM for the pressure altitude and the ambient temperature at the aerodrome of departure.
- (b) The following requirements shall be met when determining the maximum permitted take-off mass:
- (1) the accelerate-stop distance shall not exceed the accelerate-stop distance available (ASDA);
 - (2) the take-off distance shall not exceed the take-off distance available, with a clearway distance not exceeding half of the take-off run available (TORA);
 - (3) the take-off run shall not exceed the TORA;
 - (4) a single value of V_1 shall be used for the rejected and continued take-off; and
 - (5) on a wet or contaminated runway, the take-off mass shall not exceed that permitted for a take-off on a dry runway under the same conditions.
- (c) When showing compliance with (b), the following shall be taken into account:
- (1) the pressure altitude at the aerodrome;
 - (2) the ambient temperature at the aerodrome;
 - (3) the runway surface condition and the type of runway surface;
 - (4) the runway slope in the direction of take-off;
 - (5) not more than 50 % of the reported headwind component or not less than 150 % of the reported tailwind component; and
 - (6) the loss, if any, of runway length due to alignment of the aeroplane prior to take-off.

AMC1 CAT.POL.A.205 Take-off

ED Decision 2014/015/R

LOSS OF RUNWAY LENGTH DUE TO ALIGNMENT

- (a) The length of the runway that is declared for the calculation of take-off distance available (TODA), accelerate-stop distance available (ASDA) and take-off run available (TORA) does not account for line-up of the aeroplane in the direction of take-off on the runway in use. This alignment distance depends on the aeroplane geometry and access possibility to the runway in use. Accountability is usually required for a 90°-taxiway entry to the runway and 180°-turnaround on the runway. There are two distances to be considered:
- (1) the minimum distance of the main wheels from the start of the runway for determining TODA and TORA, 'L'; and
 - (2) the minimum distance of the most forward wheel(s) from the start of the runway for determining ASDA, 'N'.

Figure 1

Line-up of the aeroplane in the direction of take-off — L and N

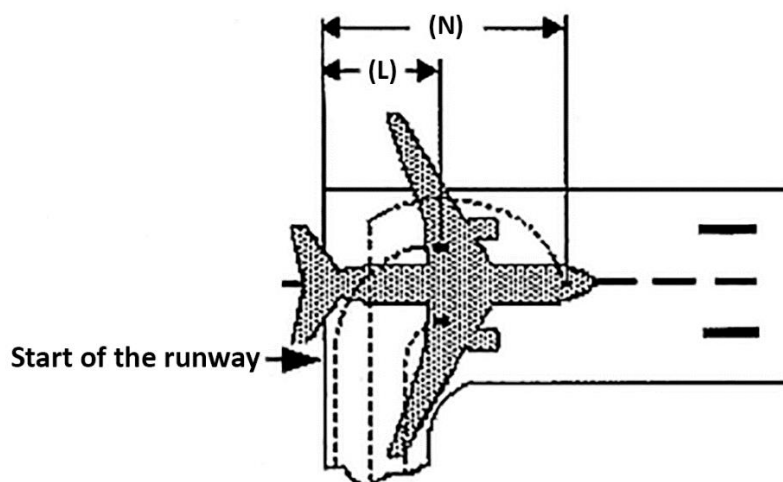

Where the aeroplane manufacturer does not provide the appropriate data, the calculation method given in (b) should be used to determine the alignment distance.

(b) Alignment distance calculation

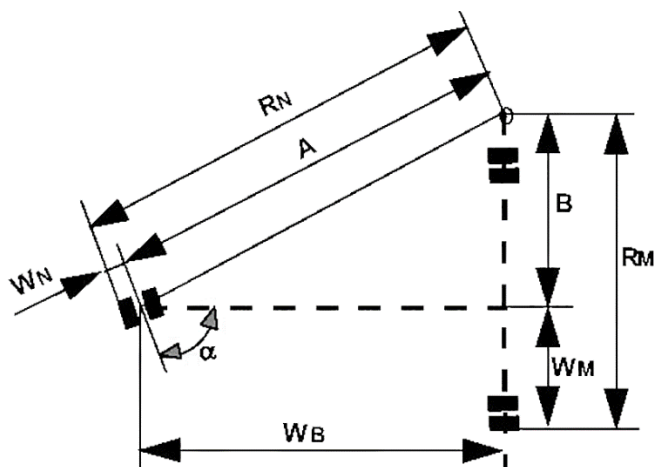

The distances mentioned in (a)(1) and (a)(2) are:

	90° entry	180° turnaround
L=	RM + X	RN + Y
N=	RM + X + WB	RN + Y + WB

where:

$$RN = A + WN = WB / \cos(90^\circ - \alpha) + WN$$

$$RM = B + WM = WB \tan(90^\circ - \alpha) + WM$$

X = safety distance of outer main wheel during turn to the edge of the runway

Y = safety distance of outer nose wheel during turn to the edge of the runway

Note: Minimum edge safety distances for X and Y are specified in FAA AC 150/5300-13 and ICAO Annex 14, 3.8.3

RN = radius of turn of outer nose wheel

RM = radius of turn of outer main wheel

WN = distance from aeroplane centre-line to outer nose wheel

WM = distance from aeroplane centre-line to outer main wheel

WB = wheel base

α = steering angle.

GM1 CAT.POL.A.205 Take-off

ED Decision 2014/015/R

RUNWAY SURFACE CONDITION

- (a) Operation on runways contaminated with water, slush, snow or ice implies uncertainties with regard to runway friction and contaminant drag and, therefore, to the achievable performance and control of the aeroplane during take-off, since the actual conditions may not completely match the assumptions on which the performance information is based. In the case of a contaminated runway, the first option for the commander is to wait until the runway is cleared. If this is impracticable, he/she may consider a take-off, provided that he/she has applied the

applicable performance adjustments, and any further safety measures he/she considers justified under the prevailing conditions.

- (b) An adequate overall level of safety will only be maintained if operations in accordance with AMC 25.1591 or equivalent are limited to rare occasions. Where the frequency of such operations on contaminated runways is not limited to rare occasions, the operator should provide additional measures ensuring an equivalent level of safety. Such measures could include special crew training, additional distance factoring and more restrictive wind limitations.

CAT.POL.A.210 Take-off obstacle clearance

Regulation (EU) No 965/2012

- (a) The net take-off flight path shall be determined in such a way that the aeroplane clears all obstacles by a vertical distance of at least 35 ft or by a horizontal distance of at least 90 m plus $0,125 \times D$, where D is the horizontal distance the aeroplane has travelled from the end of the take-off distance available (TODA) or the end of the take-off distance if a turn is scheduled before the end of the TODA. For aeroplanes with a wingspan of less than 60 m, a horizontal obstacle clearance of half the aeroplane wingspan plus 60 m, plus $0,125 \times D$ may be used.
- (b) When showing compliance with (a):
- (1) The following items shall be taken into account:
 - (i) the mass of the aeroplane at the commencement of the take-off run;
 - (ii) the pressure altitude at the aerodrome;
 - (iii) the ambient temperature at the aerodrome; and
 - (iv) not more than 50 % of the reported headwind component or not less than 150 % of the reported tailwind component.
 - (2) Track changes shall not be allowed up to the point at which the net take-off flight path has achieved a height equal to one half the wingspan but not less than 50 ft above the elevation of the end of the TORA. Thereafter, up to a height of 400 ft it is assumed that the aeroplane is banked by no more than 15°. Above 400 ft height bank angles greater than 15°, but not more than 25° may be scheduled.
 - (3) Any part of the net take-off flight path in which the aeroplane is banked by more than 15° shall clear all obstacles within the horizontal distances specified in (a), (b)(6) and (b)(7) by a vertical distance of at least 50 ft.
 - (4) Operations that apply increased bank angles of not more than 20° between 200 ft and 400 ft, or not more than 30° above 400 ft, shall be carried out in accordance with [CAT.POL.A.240](#).
 - (5) Adequate allowance shall be made for the effect of bank angle on operating speeds and flight path including the distance increments resulting from increased operating speeds.
 - (6) For cases where the intended flight path does not require track changes of more than 15°, the operator does not need to consider those obstacles that have a lateral distance greater than:
 - (i) 300 m, if the pilot is able to maintain the required navigational accuracy through the obstacle accountability area; or
 - (ii) 600 m, for flights under all other conditions.

- (7) For cases where the intended flight path requires track changes of more than 15°, the operator does not need to consider those obstacles that have a lateral distance greater than:
- (i) 600 m, if the pilot is able to maintain the required navigational accuracy through the obstacle accountability area; or
 - (ii) 900 m, for flights under all other conditions.
- (c) The operator shall establish contingency procedures to satisfy the requirements in (a) and (b) and to provide a safe route, avoiding obstacles, to enable the aeroplane to either comply with the en-route requirements of [CAT.POL.A.215](#), or land at either the aerodrome of departure or at a take-off alternate aerodrome.

AMC1 CAT.POL.A.210 Take-off obstacle clearance

ED Decision 2014/015/R

TAKE-OFF OBSTACLE CLEARANCE

- (a) In accordance with the definitions used in preparing the take-off distance and take-off flight path data provided in the AFM:
- (1) The net take-off flight path is considered to begin at a height of 35 ft above the runway or clearway at the end of the take-off distance determined for the aeroplane in accordance with (b) below.
 - (2) The take-off distance is the longest of the following distances:
 - (i) 115 % of the distance with all engines operating from the start of the take-off to the point at which the aeroplane is 35 ft above the runway or clearway;
 - (ii) the distance from the start of the take-off to the point at which the aeroplane is 35 ft above the runway or clearway assuming failure of the critical engine occurs at the point corresponding to the decision speed (V_1) for a dry runway; or
 - (iii) if the runway is wet or contaminated, the distance from the start of the take-off to the point at which the aeroplane is 15 ft above the runway or clearway assuming failure of the critical engine occurs at the point corresponding to the decision speed (V_1) for a wet or contaminated runway.
- (b) The net take-off flight path, determined from the data provided in the AFM in accordance with (a)(1) and (a)(2), should clear all relevant obstacles by a vertical distance of 35 ft. When taking off on a wet or contaminated runway and an engine failure occurs at the point corresponding to the decision speed (V_1) for a wet or contaminated runway, this implies that the aeroplane can initially be as much as 20 ft below the net take-off flight path in accordance with (a) and, therefore, may clear close-in obstacles by only 15 ft. When taking off on wet or contaminated runways, the operator should exercise special care with respect to obstacle assessment, especially if a take-off is obstacle-limited and the obstacle density is high.

AMC2 CAT.POL.A.210 Take-off obstacle clearance

ED Decision 2014/015/R

EFFECT OF BANK ANGLES

- (a) The AFM generally provides a climb gradient decrement for a 15° bank turn. For bank angles of less than 15°, a proportionate amount should be applied unless the manufacturer or AFM has provided other data.
- (b) Unless otherwise specified in the AFM or other performance or operating manuals from the manufacturer, acceptable adjustments to assure adequate stall margins and gradient corrections are provided by the following table:

Table 1

Effect of bank angles

Bank	Speed	Gradient correction
15°	V ₂	1 x AFM 15° gradient loss
20°	V ₂ + 5 kt	2 x AFM 15° gradient loss
25°	V ₂ + 10 kt	3 x AFM 15° gradient loss

AMC3 CAT.POL.A.210 Take-off obstacle clearance

ED Decision 2014/015/R

REQUIRED NAVIGATIONAL ACCURACY

- (a) Navigation systems

The obstacle accountability semi-widths of 300 m and 600 m may be used if the navigation system under OEI conditions provides a two standard deviation accuracy of 150 m and 300 m respectively.
- (b) Visual course guidance
 - (1) The obstacle accountability semi-widths of 300 m and 600 m may be used where navigational accuracy is ensured at all relevant points on the flight path by use of external references. These references may be considered visible from the flight crew compartment if they are situated more than 45° either side of the intended track and with a depression of not greater than 20° from the horizontal.
 - (2) For visual course guidance navigation, the operator should ensure that the weather conditions prevailing at the time of operation, including ceiling and visibility, are such that the obstacle and/or ground reference points can be seen and identified. The operations manual should specify, for the aerodrome(s) concerned, the minimum weather conditions which enable the flight crew to continuously determine and maintain the correct flight path with respect to ground reference points, so as to provide a safe clearance with respect to obstructions and terrain as follows:
 - (i) the procedure should be well-defined with respect to ground reference points so that the track to be flown can be analysed for obstacle clearance requirements;
 - (ii) the procedure should be within the capabilities of the aeroplane with respect to forward speed, bank angle and wind effects;
 - (iii) a written and/or pictorial description of the procedure should be provided for crew use; and

- (iv) the limiting environmental conditions (such as wind, the lowest cloud base, ceiling, visibility, day/night, ambient lighting, obstruction lighting) should be specified.

GM1 CAT.POL.A.210 Take-off obstacle clearance

ED Decision 2014/015/R

CONTINGENCY PROCEDURES FOR OBSTACLES CLEARANCES

If compliance with [CAT.POL.A.210](#) is based on an engine failure route that differs from the all engine departure route or SID normal departure, a 'deviation point' can be identified where the engine failure route deviates from the normal departure route. Adequate obstacle clearance along the normal departure route with failure of the critical engine at the deviation point will normally be available. However, in certain situations the obstacle clearance along the normal departure route may be marginal and should be checked to ensure that, in case of an engine failure after the deviation point, a flight can safely proceed along the normal departure route.

CAT.POL.A.215 En-route – one-engine-inoperative (OEI)

Regulation (EU) 2019/1387

- (a) The OEI en-route net flight path data shown in the AFM, appropriate to the meteorological conditions expected for the flight, shall allow demonstration of compliance with (b) or (c) at all points along the route. The net flight path shall have a positive gradient at 1 500 ft above the aerodrome where the landing is assumed to be made after engine failure. In meteorological conditions requiring the operation of ice protection systems, the effect of their use on the net flight path shall be taken into account.
- (b) The gradient of the en-route net flight path shall be positive at least 1 000 ft above all terrain and obstructions along the route within 9,3 km (5 NM) on either side of the intended track.
- (c) The en-route net flight path shall permit the aeroplane to continue flight from the cruising altitude to an aerodrome where a landing can be made in accordance with point [CAT.POL.A.230](#) or [CAT.POL.A.235](#), as appropriate. The en-route net flight path shall clear vertically, by at least 2 000 ft, all terrain and obstructions along the route within 9,3 km (5 NM) on either side of the intended track, taking into account the following elements:
- (1) the engine is assumed to fail at the most critical point along the route;
 - (2) account is taken of the effects of winds on the flight path;
 - (3) fuel jettisoning is permitted to an extent consistent with reaching the aerodrome where the aeroplane is assumed to land after engine failure with the required fuel reserves in accordance with point [CAT.OP.MPA.150](#), appropriate for an alternate aerodrome, if a safe procedure is used;
 - (4) the aerodrome, where the aeroplane is assumed to land after engine failure, shall meet the following criteria:
 - (i) the performance requirements for the expected landing mass are met;
 - (ii) weather reports or forecasts and runway condition reports indicate that a safe landing can be accomplished at the estimated time of landing;
 - (5) if the AFM does not contain en-route net flight path data, the gross OEI en-route flight path shall be reduced by a climb gradient of 1,1 % for two-engined aeroplanes, 1,4 % for three-engined aeroplanes, and 1,6 % for four-engined aeroplanes.

- (d) The operator shall increase the width margins provided for in points (b) and (c) to 18,5 km (10 NM) if the navigational accuracy does not meet at least navigation specification RNAV 5.

AMC1 CAT.POL.A.215 En-route – one-engine-inoperative (OEI)

ED Decision 2021/005/R

ROUTE ANALYSIS

- (a) The high terrain or obstacle analysis required should be carried out by a detailed analysis of the route.
- (b) A detailed analysis of the route should be made using contour maps of the high terrain and plotting the highest points within the prescribed corridor’s width along the route. The next step is to determine whether it is possible to maintain level flight with OEI 1 000 ft above the highest point of the crossing. If this is not possible, or if the associated weight penalties are unacceptable, a drift down procedure should be worked out, based on engine failure at the most critical point and clearing critical obstacles during the drift down by at least 2 000 ft. The minimum cruise altitude is determined by the intersection of the two drift down paths, taking into account allowances for decision making (see Figure 1). This method is time-consuming and requires the availability of detailed terrain maps.
- (c) Alternatively, the published minimum flight altitudes (MEA or minimum off-route altitude (MORA)) should be used for determining whether OEI level flight is feasible at the minimum flight altitude, or if it is necessary to use the published minimum flight altitudes as the basis for the drift down construction (see Figure 1). This procedure avoids a detailed high terrain contour analysis, but could be more penalising than taking the actual terrain profile into account as in (b).
- (d) In order to comply with [CAT.POL.A.215](#) (c), one means of compliance is the use of MORA and, with CAT.POL.A.215 (d), MEA provided that the aeroplane meets the navigational equipment standard assumed in the definition of MEA.

Figure 1

Intersection of the two drift down paths

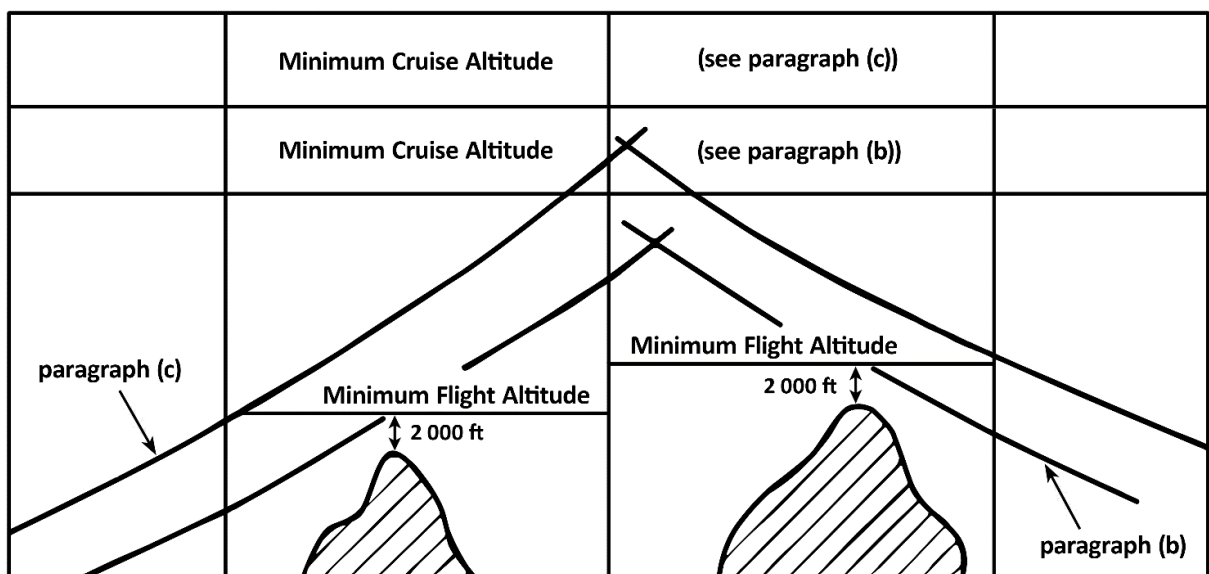

Note: MEA or MORA normally provide the required 2 000 ft obstacle clearance for drift down. However, at and below 6 000 ft altitude, MEA and MORA cannot be used directly as only 1 000 ft clearance is ensured.

CAT.POL.A.220 En-route – aeroplanes with three or more engines, two engines inoperative

Regulation (EU) 2021/1296

- (a) An aeroplane that has three or more engines shall not be away from an aerodrome at which the requirements of points [CAT.POL.A.230](#) or [CAT.POL.A.235\(a\)](#) for the expected landing mass are met accordingly, at any point along the intended track for more than 90 minutes, with all engines operating at cruising power or thrust, as appropriate, at standard temperature in still air, unless points (b) to (f) of this point are complied with.
- (b) The two-engines-inoperative en-route net flight path data shall allow the aeroplane to continue the flight, in the expected meteorological conditions, from the point where two engines are assumed to fail simultaneously to an aerodrome at which it is possible to land and come to a complete stop when using the prescribed procedure for a landing with two engines inoperative. The en-route net flight path shall clear vertically, by at least 2 000 ft, all terrain and obstructions along the route within 9,3 km (5 NM) on either side of the intended track. At altitudes and in meteorological conditions that require ice protection systems to be operable, the effect of their use on the en-route net flight path data shall be taken into account. If the navigational accuracy does not meet at least navigation specification RNAV 5, the operator shall increase the prescribed width margin provided for in the second sentence to 18,5 km (10 NM).
- (c) The two engines shall be assumed to fail at the most critical point of that portion of the route where the aeroplane is operated for more than 90 minutes, with all engines operating at cruising power or thrust, as appropriate, at standard temperature in still air, away from the aerodrome referred to in point (a).
- (d) The net flight path shall have a positive gradient at 1 500 ft above the aerodrome where the landing is assumed to be made after the failure of two engines.
- (e) Fuel jettisoning shall be permitted to an extent consistent with reaching the aerodrome with the required fuel reserves referred to in point (f), if a safe procedure is used.
- (f) The expected mass of the aeroplane at the point where the two engines are assumed to fail shall not be less than that which would include sufficient fuel/energy to proceed to an aerodrome where the landing is assumed to be made, and to arrive there at an altitude of at least 1 500 ft (450 m) directly over the landing area, and thereafter, to fly for 15 minutes at cruising power or thrust, as appropriate.

CAT.POL.A.225 Landing – destination and alternate aerodromes

Regulation (EU) No 965/2012

- (a) The landing mass of the aeroplane determined in accordance with [CAT.POL.A.105\(a\)](#) shall not exceed the maximum landing mass specified for the altitude and the ambient temperature expected for the estimated time of landing at the destination aerodrome and alternate aerodrome.

AMC1 CAT.POL.A.225 Landing – destination and alternate aerodromes

ED Decision 2014/015/R

ALTITUDE MEASURING

The operator should use either pressure altitude or geometric altitude for its operation and this should be reflected in the operations manual.

AMC2 CAT.POL.A.225 Landing – destination and alternate aerodromes

ED Decision 2014/015/R

MISSED APPROACH

- (a) For instrument approaches with a missed approach climb gradient greater than 2.5 %, the operator should verify that the expected landing mass of the aeroplane allows for a missed approach with a climb gradient equal to or greater than the applicable missed approach gradient in the OEI missed approach configuration and at the associated speed.
- (b) For instrument approaches with DH below 200 ft, the operator should verify that the expected landing mass of the aeroplane allows a missed approach gradient of climb, with the critical engine failed and with the speed and configuration used for a missed approach of at least 2.5 %, or the published gradient, whichever is greater.

GM1 CAT.POL.A.225 Landing – destination and alternate aerodromes

ED Decision 2014/015/R

MISSED APPROACH GRADIENT

- (a) Where an aeroplane cannot achieve the missed approach gradient specified in [AMC2 CAT.POL.A.225](#), when operating at or near maximum certificated landing mass and in engine-out conditions, the operator has the opportunity to propose an alternative means of compliance to the competent authority demonstrating that a missed approach can be executed safely taking into account appropriate mitigating measures.
- (b) The proposal for an alternative means of compliance may involve the following:
 - (1) considerations to mass, altitude and temperature limitations and wind for the missed approach;
 - (2) a proposal to increase the DA/H or MDA/H; and
 - (3) a contingency procedure ensuring a safe route and avoiding obstacles.

CAT.POL.A.230 Landing – dry runways

Regulation (EU) 2019/1387

- (a) The landing mass of the aeroplane determined in accordance with point [CAT.POL.A.105\(a\)](#) for the estimated time of landing at the destination aerodrome and at any alternate aerodrome shall allow a full-stop landing from 50 ft above the threshold:
 - (1) for turbojet-powered aeroplanes, within 60 % of the landing distance available (LDA);

- (2) for turbopropeller-powered aeroplanes, within 70 % of the LDA;
- (3) by way of derogation from points (a)(1) and (a)(2), for aeroplanes that are approved for reduced landing distance operations under point [CAT.POL.A.255](#), within 80 % of the LDA.
- (b) For steep approach operations, the operator shall use the landing distance data factored in accordance with point (a)(1) or (a)(2), as applicable, based on a screen height of less than 60 ft, but not less than 35 ft, and shall comply with point [CAT.POL.A.245](#).
- (c) For short landing operations, the operator shall use the landing distance data factored in accordance with point (a)(1) or (a)(2), as applicable, and shall comply with point [CAT.POL.A.250](#).
- (d) When determining the landing mass, the operator shall take into account the following:
 - (1) not more than 50 % of the headwind component or not less than 150 % of the tailwind component;
 - (2) corrections as provided in the AFM.
- (e) For dispatching the aeroplane, the aeroplane shall either:
 - (1) land on the most favourable runway, in still air;
 - (2) land on the runway most likely to be assigned, considering the probable wind speed and direction, the ground-handling characteristics of the aeroplane and other conditions such as landing aids and terrain.
- (f) If the operator is unable to comply with point (e)(2) for the destination aerodrome, the aeroplane shall only be dispatched if an alternate aerodrome is designated that allows full compliance with one of the following:
 - (1) points (a) to (d), if the runway at the estimated time of arrival is dry;
 - (2) points [CAT.POL.A.235\(a\)](#) to (d), if the runway at the estimated time of arrival is wet or contaminated.

AMC1 CAT.POL.A.230 Landing — dry runways

ED Decision 2022/012/R

FACTORING OF AUTOMATIC LANDING DISTANCE PERFORMANCE DATA

In those cases where the landing requires the use of an automatic landing system, and the distance published in the AFM includes safety margins equivalent to those contained in [CAT.POL.A.230\(a\)\(1\)](#) and [CAT.POL.A.230\(a\)\(2\)](#), the landing mass of the aeroplane should be the lesser of:

- (a) the landing mass determined in accordance with [CAT.POL.A.230\(a\)\(1\)](#) and [CAT.POL.A.230\(a\)\(2\)](#);
or
- (b) the landing mass determined for the automatic landing distance for the appropriate surface condition, as given in the AFM or equivalent document. Increments due to system features such as beam location or elevations, or procedures such as use of overspeed, should also be included.

AMC2 CAT.POL.A.230 Landing — dry runways

ED Decision 2022/012/R

FACTORING OF LANDING DISTANCE PERFORMANCE DATA WHEN USING A HEAD-UP DISPLAY (HUD) OR AN EQUIVALENT DISPLAY WITH FLARE CUE

In those cases where the landing requires the use of a HUD or an equivalent display with flare cue, and the landing distance published in the AFM includes safety factors, the landing mass of the aeroplane should be the lesser of:

- (a) the landing mass determined in accordance with [CAT.POL.A.230\(a\)\(1\)](#); or
- (b) the landing mass determined, when using a HUD or an equivalent display with flare cue for the appropriate surface condition, as given in the AFM or equivalent document.

GM1 CAT.POL.A.230 Landing – dry runways

ED Decision 2021/005/R

LANDING MASS

[CAT.POL.A.230](#) establishes two considerations in determining the maximum permissible landing mass at the destination and alternate aerodromes:

- (a) Firstly, the aeroplane mass will be such that on arrival the aeroplane can be landed within 60 %, 70 %, or 80 % (as applicable) of the landing distance available (LDA) on the most favourable (normally the longest) runway in still air. Regardless of the wind conditions, the maximum landing mass for an aerodrome/aeroplane configuration at a particular aerodrome cannot be exceeded.
- (b) Secondly, consideration should be given to anticipated conditions and circumstances. The expected wind, or ATC and noise abatement procedures, may indicate the use of a different runway. These factors may result in a lower landing mass than that permitted under (a), in which case dispatch should be based on this lesser mass.
- (c) The expected wind referred to in (b) is the wind expected to exist at the time of arrival.

GM1 CAT.POL.A.230 & CAT.POL.A.235 Landing — dry runways & Landing — wet and contaminated runways

ED Decision 2021/005/R

WORKFLOW OF THE LANDING DISTANCE ASSESSMENT AT THE TIME OF DISPATCH — GENERAL

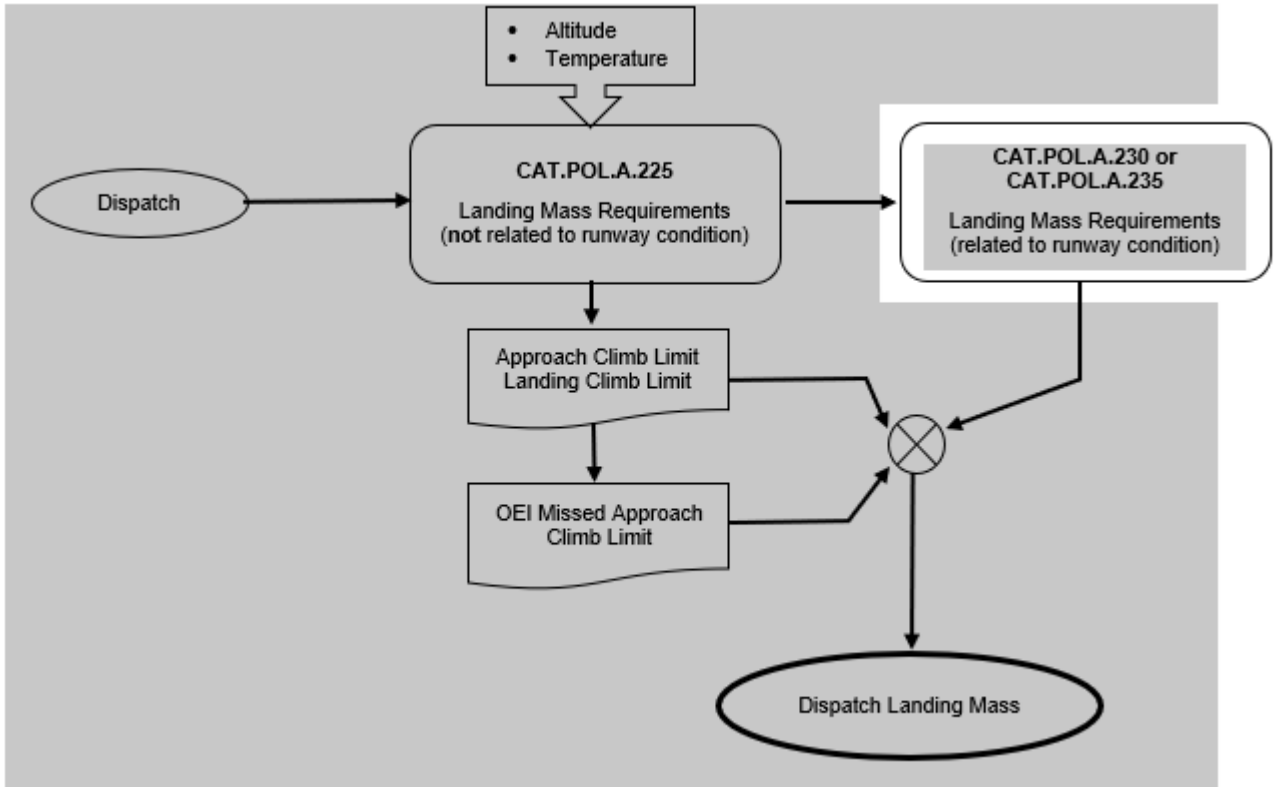

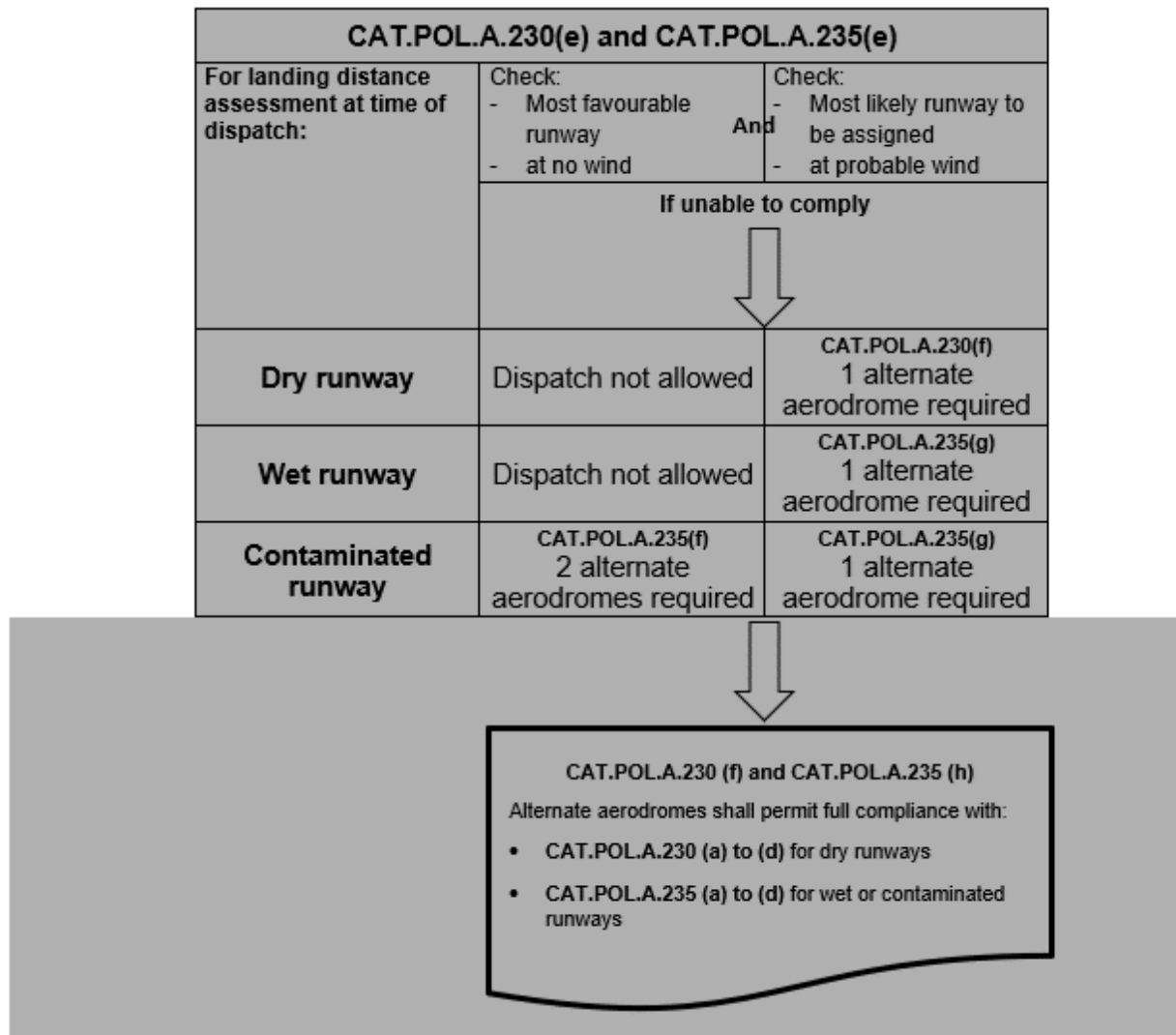
WORKFLOW OF THE LANDING DISTANCE ASSESSMENT AT THE TIME OF DISPATCH — RUNWAY SUITABILITY CHECK

WORKFLOW OF THE LANDING DISTANCE ASSESSMENT AT THE TIME OF DISPATCH — DRY RUNWAYS

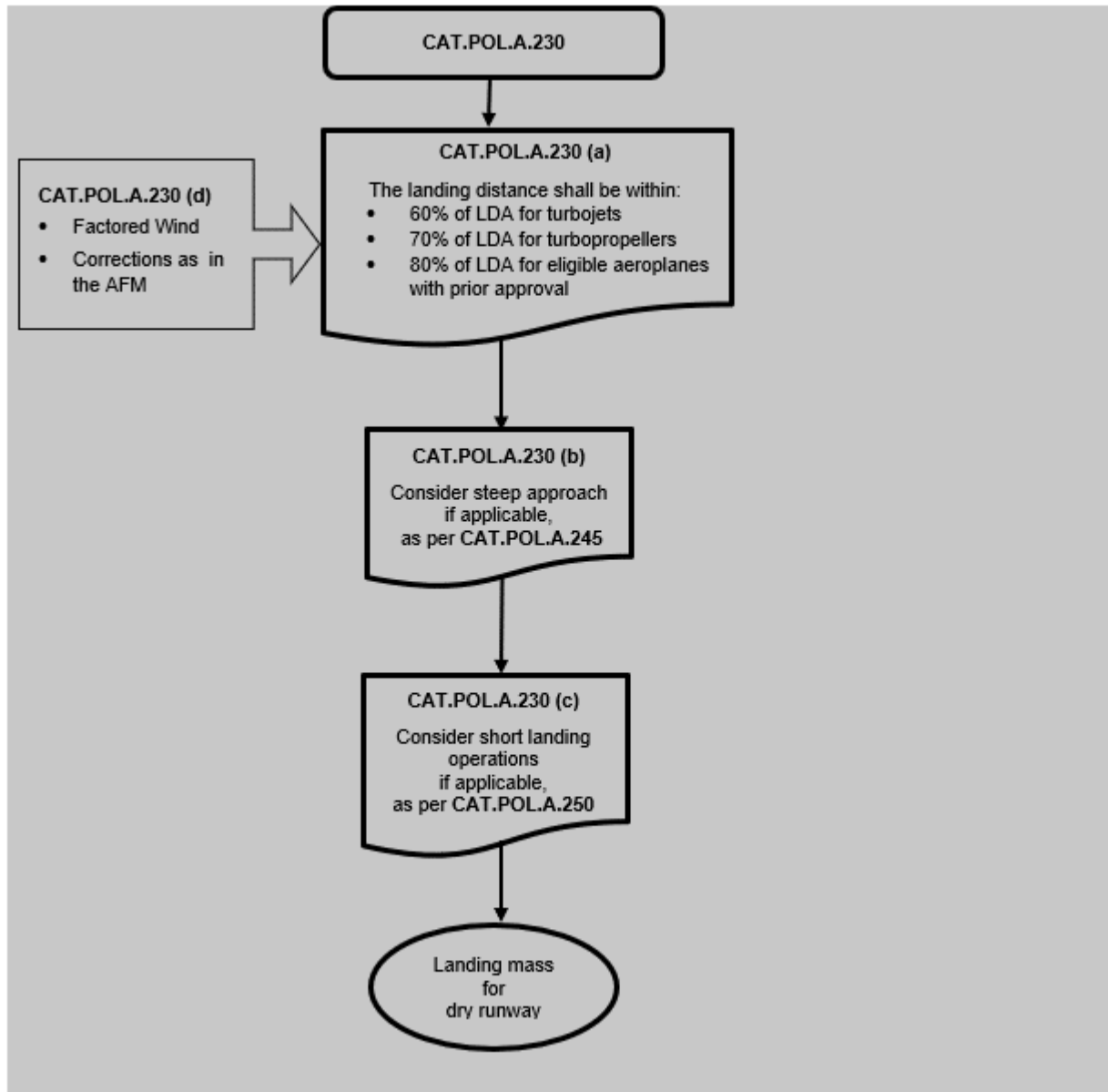

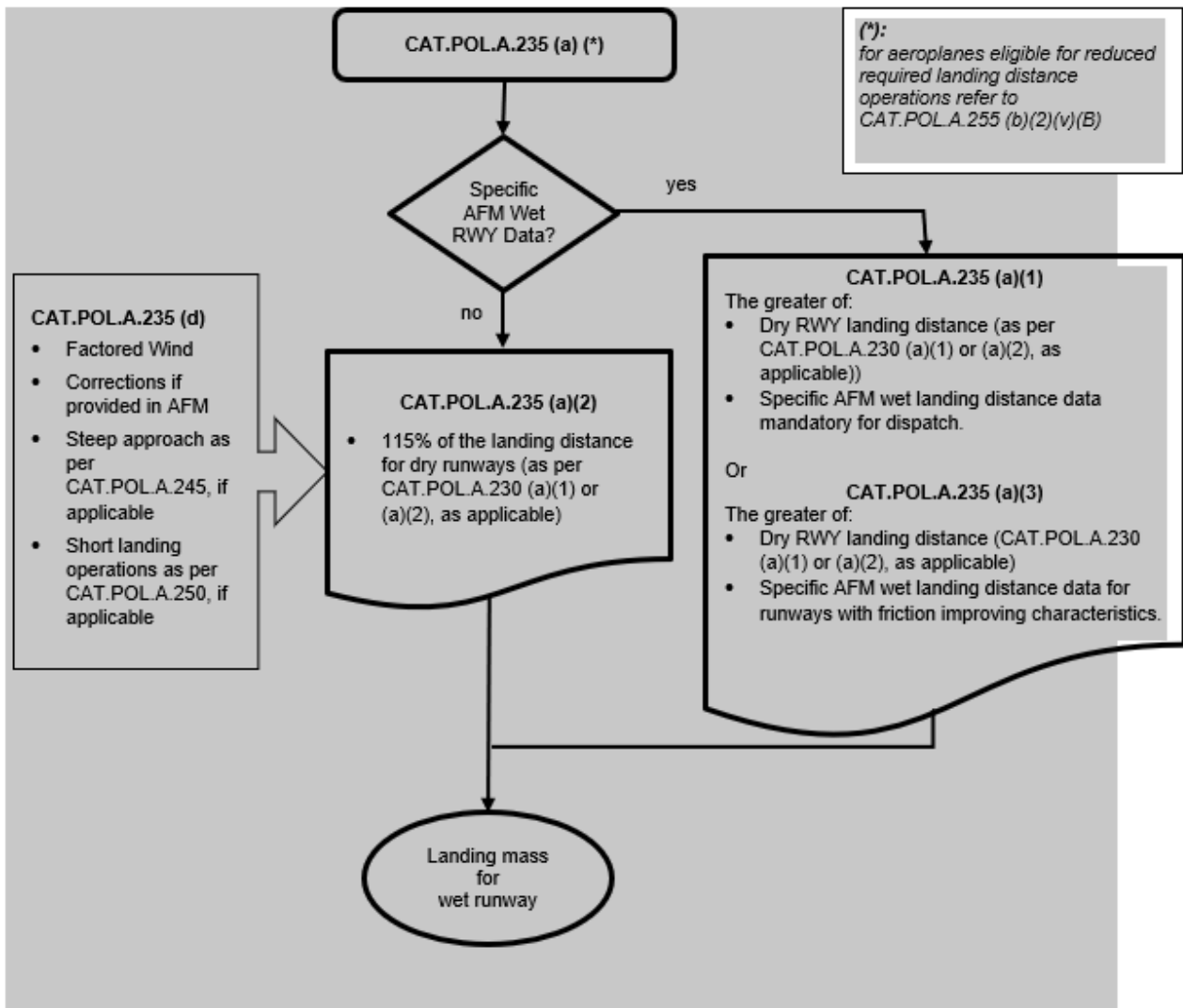
WORKFLOW OF THE LANDING DISTANCE ASSESSMENT AT THE TIME OF DISPATCH — WET RUNWAYS

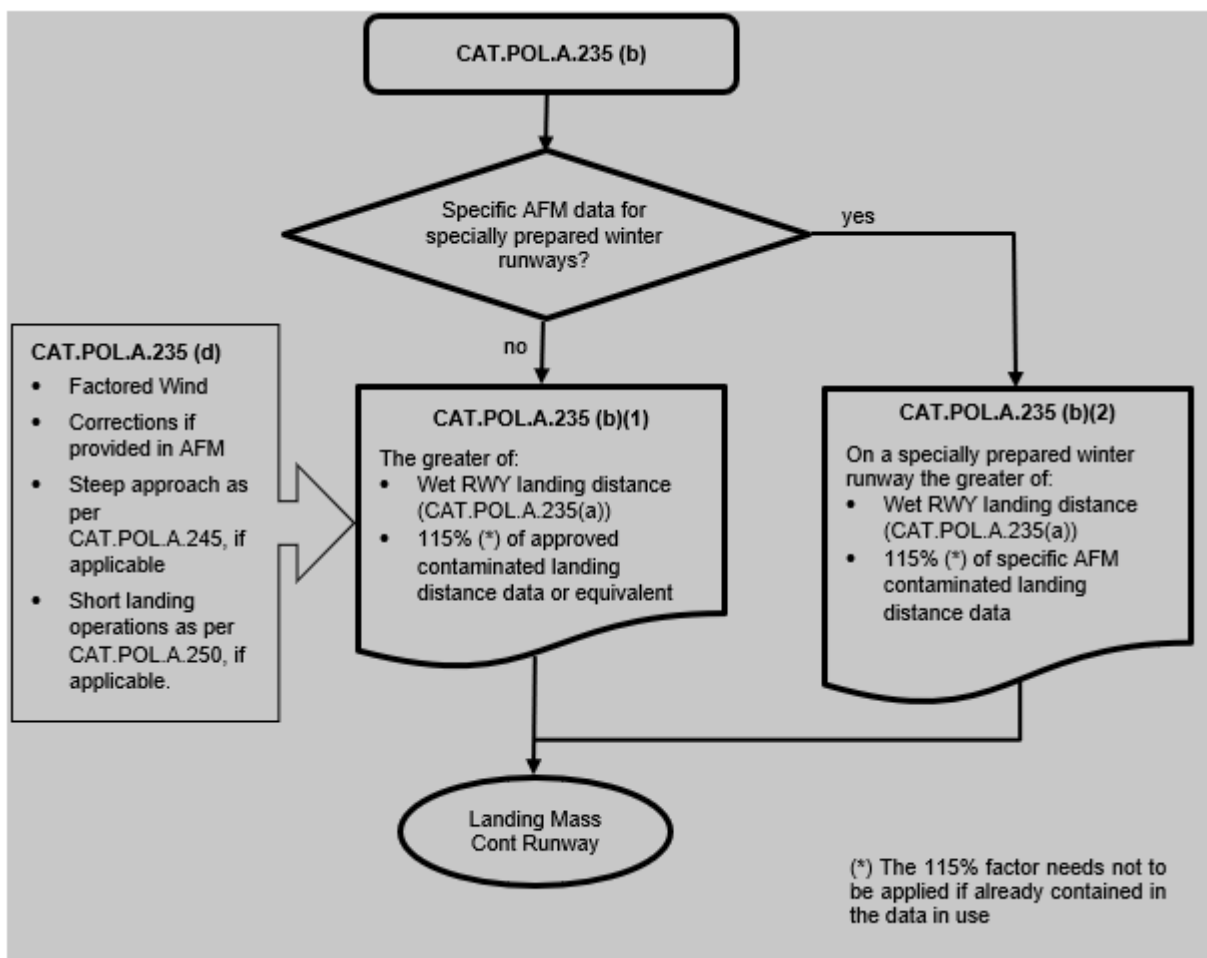
WORKFLOW OF THE LANDING DISTANCE ASSESSMENT AT THE TIME OF DISPATCH — CONTAMINATED RUNWAYS

GM2 CAT.POL.A.230 & CAT.POL.A.235 Landing — dry runways & Landing — wet and contaminated runways

ED Decision 2021/005/R

LANDING DISTANCES AND CORRECTIVE FACTORS

The AFM provides performance data for landing distance under conditions defined in the applicable certification standards. This distance, commonly referred to as the actual landing distance (ALD), is the distance from the position on the runway of the screen height to the point where the aeroplane comes to a full stop on a dry runway.

The determination of the ALD is based on the assumption that the landing is performed in accordance with the conditions and the procedures set out in the AFM on the basis of the applicable certification standards.

As a matter of fact, any particular landing may be different from the landing technique that is assumed in the AFM for certification purposes. The aircraft may approach the runway faster and/or higher than assumed; the aircraft may touch down further along the runway than the optimum point; the actual winds and other weather factors may be different from those assumed in the calculation of the ALD;

and maximum braking may not be always achievable. For this reason, the LDA is required by [CAT.POL.A.230](#) and [CAT.POL.A.235](#) to be longer than the ALD.

The margins by which the LDA shall exceed the ALD on dry runways, in accordance with [CAT.POL.A.230](#), are shown in the following Table 1.

Table 1: Corrective factors for dry runways

Aeroplane category	Required margin (dry runway)	Resulting factor (dry runway)
Turbojet-powered aeroplanes	ALD < 60 % of the LDA	LDA = at least 1.67 x ALD
Turbopropeller-powered aeroplanes	ALD < 70 % of the LDA	LDA = at least 1.43 x ALD
Aeroplanes approved under CAT.POL.A.255	ALD < 80 % of the LDA	LDA = at least 1.25 x ALD

If the runway is wet and the AFM does not provide specific performance data for dispatch on wet runways, a further increase of 15 % of the landing distance on dry runways has to be applied, in accordance with [CAT.POL.A.235](#), as shown in the following Table 2.

Table 2: Corrective factors for wet runways

Aeroplane category	Resulting factor (dry runway)
Turbojet-powered aeroplanes	LDA = at least 1.15 x 1.67 x ALD = 1.92 x ALD
Turbopropeller-powered aeroplanes	LDA = at least 1.15 x 1.43 x ALD = 1.64 x ALD
Aeroplanes approved under CAT.POL.A.255	LDA = at least 1.15 x 1.25 x ALD = 1.44 x ALD

However, for aeroplanes that are approved under [CAT.POL.A.255](#), when landing on wet runways, [CAT.POL.A.255](#) further requires the flight crew to apply the longer of the landing distance resulting from the above table and the landing distance resulting from the application of [CAT.OP.MPA.303\(a\)](#) or [\(b\)](#) as applicable. If performance information for the assessment of LDTA is not available as per [CAT.OP.MPA.303\(b\)\(2\)](#), the required landing distance on wet runways should be at least: 1.15 x 1.67 x ALD for turbojet-powered aircraft and 1.15 x 1.43 x ALD for turbopropeller-powered aircraft.

GM1 CAT.POL.A.230(a) Landing — dry runways

ED Decision 2021/005/R

ALTERNATE AERODROMES

The alternate aerodromes for which the landing mass is required to be determined in accordance with [CAT.POL.A.230](#) are:

- (a) destination alternate aerodromes;
- (b) fuel ERA aerodromes; and

- (c) re-dispatch or re-clearance aerodromes.

GM1 CAT.POL.A.230(d)(2) Landing — dry runways

ED Decision 2021/005/R

AFM LANDING PERFORMANCE CORRECTIONS

Landing performance data is provided in the AFM at least for the certified range of pressure altitudes. AFM data may include other influence parameters such as, but not limited to, runway slope and temperature. The effect of speed increments over threshold should also be accounted for when these increments are required by the applicable AFM procedures, such as autoland or steep approach.

CAT.POL.A.235 Landing – wet and contaminated runways

Regulation (EU) 2019/1387

- (a) When the appropriate weather reports or forecasts, or both, indicate that the runway at the estimated time of arrival may be wet, the LDA shall be one of the following distances:
- (1) a landing distance provided in the AFM for use on wet runways at time of dispatch, but not less than that required by point [CAT.POL.A.230\(a\)\(1\)](#) or (a)(2), as applicable;
 - (2) if a landing distance is not provided in the AFM for use on wet runways at time of dispatch, at least 115 % of the required landing distance, determined in accordance with point [CAT.POL.A.230\(a\)\(1\)](#) or (a)(2), as applicable;
 - (3) a landing distance shorter than that required by point (a)(2), but not less than that required by point [CAT.POL.A.230\(a\)\(1\)](#) or (a)(2), as applicable, if the runway has specific friction-improving characteristics and the AFM includes specific additional information for landing distance on that runway type;
 - (4) by way of derogation from points (a)(1), (a)(2) and (a)(3), for aeroplanes that are approved for reduced landing distance operations under point [CAT.POL.A.255](#), the landing distance determined in accordance with point [CAT.POL.A.255\(b\)\(2\)\(v\)\(B\)](#).
- (b) When the appropriate weather reports or forecasts indicate that the runway at the estimated time of arrival may be contaminated, the LDA shall be one of the following distances:
- (1) at least the landing distance determined in accordance with point (a), or at least 115 % of the landing distance determined in accordance with approved contaminated landing distance data or equivalent, whichever is greater;
 - (2) on specially prepared winter runways, a landing distance shorter than that required by point (b)(1), but not less than that required by point (a), may be used if the AFM includes specific additional information about landing distances on contaminated runways. Such landing distance shall be at least 115 % of the landing distance contained in the AFM.
- (c) By way of derogation from point (b), the increment of 15 % needs not to be applied if it is already included in the approved landing distance data or equivalent.
- (d) For points (a) and (b), the criteria of points [CAT.POL.A.230\(b\)](#), (c) and (d) shall apply accordingly.
- (e) For dispatching the aeroplane, the aeroplane shall either:
- (1) land on the most favourable runway, in still air;

- (2) land on the runway most likely to be assigned, considering the probable wind speed and direction, the ground-handling characteristics of the aeroplane and other conditions such as landing aids and terrain.
- (f) If the operator is unable to comply with point (e)(1) for a destination aerodrome where the appropriate weather reports or forecasts indicate that the runway at the estimated time of arrival may be contaminated and where a landing depends upon a specific wind component, the aeroplane shall only be dispatched if two alternate aerodromes are designated.
- (g) If the operator is unable to comply with point (e)(2) for the destination aerodrome where the appropriate weather reports or forecasts indicate that the runway at the estimated time of arrival may be wet or contaminated, the aeroplane shall only be dispatched if an alternate aerodrome is designated.
- (h) For points (f) and (g), the designated alternate aerodrome or aerodromes shall allow compliance with one of the following:
 - (1) points [CAT.POL.A.230\(a\)](#) to (d), if the runway at the estimated time of arrival is dry;
 - (2) points [CAT.POL.A.235\(a\)](#) to (d), if the runway at the estimated time of arrival is wet or contaminated.

AMC1 CAT.POL.A.235 Landing — dry runways

ED Decision 2022/012/R

FACTORING OF AUTOMATIC LANDING DISTANCE PERFORMANCE DATA

In those cases where the landing requires the use of an automatic landing system, and the distance published in the AFM includes safety margins equivalent to those contained in [CAT.POL.A.235](#), the landing mass of the aeroplane should be the lesser of:

- (a) the landing mass determined in accordance with [CAT.POL.A.235](#); or
- (b) the landing mass determined for the automatic landing distance for the appropriate surface condition, as given in the AFM or equivalent document. Increments due to system features such as beam location or elevations, or procedures such as use of overspeed, should also be included.

AMC2 CAT.POL.A.235 Landing — wet and contaminated runways

ED Decision 2022/012/R

FACTORING OF LANDING DISTANCE PERFORMANCE DATA WHEN A USING HEAD-UP DISPLAY (HUD) OR AN EQUIVALENT DISPLAY WITH FLARE CUE

In those cases where the landing requires the use of a HUD or an equivalent display with flare cue, and the landing distance published in the AFM includes safety factors, the landing mass of the aeroplane should be the lesser of:

- (a) the landing mass determined in accordance with [CAT.POL.A.235](#); or
- (b) the landing mass determined, when using a HUD or an equivalent display with flare cue for the appropriate surface condition, as given in the AFM or equivalent document.

GM1 CAT.POL.A.235(a) and (b) Landing — wet and contaminated runways

ED Decision 2021/005/R

DISPATCH CONSIDERATIONS FOR MARGINAL CASES

The LDTA required by [CAT.OP.MPA.303](#) may, in some cases, and in particular on wet or contaminated runways, exceed the landing distance considered at the time of dispatch. The requirements for dispatch remain unchanged, however, when the conditions at the time of arrival are expected to be marginal, it is a good practice to carry out at the time of dispatch a preliminary calculation of the LDTA.

GM1 CAT.POL.A.235(a)(1) Landing — wet and contaminated runways

ED Decision 2021/005/R

AFM LANDING DISTANCES FOR WET RUNWAYS

Specific landing distances provided in the AFM for dispatch on wet runways, unless otherwise indicated, include a safety factor, which renders not necessary the application of the 15 % safety factor used in [CAT.POL.A.235\(a\)\(2\)](#). This implies that the AFM distance may be presented as factored distance. When the AFM distance is not factored, a safety factor of 15 % should be applied. These distances may be longer or shorter than those resulting from [CAT.POL.A.235\(a\)\(2\)](#), but when provided, they are intended as a replacement of [CAT.POL.A.235\(a\)\(2\)](#) and mandatory for use at the time of dispatch.

AMC1 CAT.POL.A.235(a)(3) Landing — wet and contaminated runways

ED Decision 2021/005/R

RUNWAYS WITH FRICTION IMPROVING CHARACTERISTICS

Materials or construction techniques meant to improve the friction characteristics of a runway may be grooved runways, runways treated with porous friction course (PFC) or other materials or techniques for which the AFM provides specific performance data.

Before taking the AFM performance credit for such runways, the operator should verify that the runways intended to be operated on are maintained to the extent necessary to ensure the expected improved friction characteristics.

CAT.POL.A.240 Approval of operations with increased bank angles

Regulation (EU) No 379/2014

- (a) Operations with increased bank angles require prior approval by the competent authority.
- (b) To obtain the approval, the operator shall provide evidence that the following conditions are met:
 - (1) the AFM contains approved data for the required increase of operating speed and data to allow the construction of the flight path considering the increased bank angles and speeds;
 - (2) visual guidance is available for navigation accuracy;

- (3) weather minima and wind limitations are specified for each runway; and
- (4) the flight crew has obtained adequate knowledge of the route to be flown and of the procedures to be used in accordance with Subpart FC of Part-ORO.

CAT.POL.A.245 Approval of steep approach operations

Regulation (EU) No 965/2012

- (a) Steep approach operations using glideslope angles of 4,5° or more and with screen heights of less than 60 ft, but not less than 35 ft, require prior approval by the competent authority.
- (b) To obtain the approval, the operator shall provide evidence that the following conditions are met:
 - (1) the AFM states the maximum approved glideslope angle, any other limitations, normal, abnormal or emergency procedures for the steep approach as well as amendments to the field length data when using steep approach criteria;
 - (2) for each aerodrome at which steep approach operations are to be conducted:
 - (i) a suitable glide path reference system comprising at least a visual glide path indicating system shall be available;
 - (ii) weather minima shall be specified; and
 - (iii) the following items shall be taken into consideration:
 - (A) the obstacle situation;
 - (B) the type of glide path reference and runway guidance;
 - (C) the minimum visual reference to be required at decision height (DH) and MDA;
 - (D) available airborne equipment;
 - (E) pilot qualification and special aerodrome familiarisation;
 - (F) AFM limitations and procedures; and
 - (G) missed approach criteria.

GM1 CAT.POL.A.245(a) Approval of steep approach operations

ED Decision 2021/005/R

SCREEN HEIGHT

For the purpose of steep approach operations, the screen height is the reference height above the runway surface, typically above the runway threshold, from which the landing distance is measured. The screen height is set at 50 ft for normal operations and at another value between 60 ft and 35 ft for steep approach operations.

CAT.POL.A.250 Approval of short landing operations

Regulation (EU) 2019/1387

- (a) Short landing operations require prior approval by the competent authority.
- (b) To obtain the approval, the operator shall provide evidence that the following conditions are met:

- (1) the distance used for the calculation of the permitted landing mass may consist of the usable length of the declared safe area plus the declared LDA;
- (2) the State of the aerodrome has determined a public interest and operational necessity for the operation, either due to the remoteness of the aerodrome or to physical limitations relating to extending the runway;
- (3) the vertical distance between the path of the pilot's eye and the path of the lowest part of the wheels, with the aeroplane established on the normal glide path, does not exceed 3 m;
- (4) RVR/VIS minimum shall not be less than 1 500 m and wind limitations are specified in the operations manual;
- (5) minimum pilot experience, training and special aerodrome familiarisation requirements are specified and met;
- (6) the crossing height over the beginning of the usable length of the declared safe area is 50 ft;
- (7) the use of the declared safe area is approved by the State of the aerodrome;
- (8) the usable length of the declared safe area does not exceed 90 m;
- (9) the width of the declared safe area is not less than twice the runway width or twice the wing span, whichever is greater, centred on the extended runway centre line;
- (10) the declared safe area is clear of obstructions or depressions that would endanger an aeroplane undershooting the runway and no mobile object is permitted on the declared safe area while the runway is being used for short landing operations;
- (11) the slope of the declared safe area does not exceed 5 % upward nor 2 % downward in the direction of landing;
- (11a) reduced required landing distance operations in accordance with [CAT.POL.A.255](#) are prohibited; and
- (12) additional conditions, if specified by the competent authority, taking into account aeroplane type characteristics, orographic characteristics in the approach area, available approach aids and missed approach/balked landing considerations.

CAT.POL.A.255 Approval of reduced required landing distance operations

Regulation (EU) 2020/1176

- (a) An aeroplane operator may conduct landing operations within 80 % of the landing distance available (LDA) if it complies with the following conditions:
 - (1) the airplane has an MOPSC of 19 or less;
 - (2) the airplane has an eligibility statement for reduced required landing distance in the AFM;
 - (3) the airplane is used in non-scheduled on-demand commercial air transport (CAT) operations;
 - (4) the landing mass of the aeroplane allows a full-stop landing within that reduced landing distance;
 - (5) the operator has obtained a prior approval of the competent authority.

- (b) To obtain the approval referred to in point (a)(5), the operator shall provide evidence of either of the following circumstances:
- (1) that a risk assessment has been conducted to demonstrate that a level of safety equivalent to that intended by point [CAT.POL.A.230\(a\)\(1\)](#) or (2), as applicable, is achieved;
 - (2) that the following conditions are met:
 - (i) special-approach procedures, such as steep approaches, planned screen heights higher than 60 ft or lower than 35 ft, low-visibility operations, approaches outside stabilised approach criteria approved under point [CAT.OP.MPA.115\(a\)](#), are prohibited;
 - (ii) short landing operations in accordance with point [CAT.POL.A.250](#) are prohibited;
 - (iii) landing on contaminated runways is prohibited;
 - (iv) an adequate training, checking and monitoring process for the flight crew is established;
 - (v) an aerodrome landing analysis programme (ALAP) is established by the operator to ensure that the following conditions are met:
 - (A) no tailwind is forecast at the expected time of arrival;
 - (B) if the runway is forecast to be wet at the expected time of arrival, the landing distance at dispatch shall either be determined in accordance with point [CAT.OP.MPA.303\(a\)](#) or (b) as applicable, or shall be 115 % of the landing distance determined for dry runways, whichever is longer;
 - (C) no forecast contaminated runway conditions exist at the expected time of arrival;
 - (D) no forecast adverse weather conditions exist at the expected time of arrival;
 - (vi) all the equipment that affects landing performance is operative before commencing the flight;
 - (vii) the flight crew is composed of at least two qualified and trained pilots that have recency in reduced required landing distance operations;
 - (viii) based on the prevailing conditions for the intended flight, the commander shall make the final decision to conduct reduced required landing distance operations and may decide not to do so when he or she considers that to be in the interest of safety;
 - (ix) additional aerodrome conditions, if specified by the competent authority that has certified the aerodrome, taking into account orographic characteristics of the approach area, available approach aids, missed-approach and bailed-landing considerations.

GM1 CAT.POL.A.255(a)(2) Approval of reduced required landing distance operations

ED Decision 2021/005/R

AEROPLANE ELIGIBILITY

The factors required by CAT.POL.A.230(a)(1) or (a)(2), as applicable, provide an operational safety margin to take into account landing distance operational variability in normal operations compared to the conditions and procedures set out to determine the actual landing distances during the certification of the aeroplane. The reduction of this margin, allowed when operating with reduced required landing distance, is based on a set of mitigating conditions required by CAT.POL.A.255.

However, if the factors required by CAT.POL.A.230(a)(1) or (a)(2), as applicable, have been used during the certification of the aeroplane to demonstrate compliance with certification standards such as, but not limited to, CS 25.1309 or equivalent, the aeroplane is not eligible for a reduction of the margin provided by those factors.

Furthermore, certification methods offer different options for the determination of the air distance portion of the landing distance in terms of assumption that can be made for parameters such as, but not limited to, glide path angle and sink rate at touchdown. The assumptions made during the certification of the aeroplane may increase the landing distance operational variability in normal operations. The effect of parameters such as temperature or runway slope, when these were not considered during certification, may as well increase the landing distances achievable in normal operations. Overall, the set of assumptions made during the certification of the aeroplane may not be always compatible with the operational safety margin reduction allowed in reduced required landing distance operations under CAT.POL.A.255.

Whether the factors required by CAT.POL.A.230(a)(1) or (a)(2), as applicable, have been used to demonstrate compliance with certification standards, or the set of assumptions made to determine actual landing distances during the certification of the aeroplane are compatible with reduced landing distance operations, may be only declared by the aeroplane manufacturer or by the TC/STC holder.

GM1 CAT.POL.A.255(a)(3) Approval of reduced required landing distance operations

ED Decision 2021/005/R

NON-SCHEDULED ON-DEMAND COMMERCIAL AIR TRANSPORT (CAT) OPERATIONS

For the purpose of reduced required landing distance operations, non-scheduled on-demand CAT operations are those CAT operations conducted upon request of the customer.

Non-scheduled on-demand CAT operations eligible for reduced required landing distance operations do not include holiday charters, i.e. charter flights that are part of a holiday travel package.

AMC1 CAT.POL.A.255(b)(1) Approval of reduced required landing distance operations

ED Decision 2021/005/R

EQUIVALENT LEVEL OF SAFETY

A level of safety equivalent to that intended by CAT.POL.A.230(a)(1) or CAT.POL.A.230(a)(2), as applicable, may be achieved when conducting reduced required landing distance operations if mitigating measures are established and implemented. Such measures should address flight crew,

aircraft characteristics and performance, aerodromes and operations. It is, however, essential that all conditions established are adhered to as it is the combination of said conditions that achieves the intended level of safety. The operator should in fact also consider the interrelation of the various mitigating measures.

The mitigating measures may be determined by the operator by using a risk assessment or by fulfilling all the conditions established under CAT.POL.A.255(b)(2). An operator willing to establish a set of conditions different from those under CAT.POL.A.255(b)(2) needs to demonstrate to the competent authority the equivalent level of safety through a risk assessment.

The risk assessment required by CAT.POL.A.255(b)(1) should include at least the following elements:

- (a) flight crew qualification in terms of training, checking and recency;
- (b) flight crew composition;
- (c) runway surface conditions;
- (d) dispatch criteria;
- (e) weather conditions and limitations, including crosswind;
- (f) aerodrome characteristics, including available approach guidance;
- (g) aeroplane characteristics and limitations;
- (h) aeroplane equipment and systems affecting landing performance;
- (i) aeroplane performance data;
- (j) operating procedures and operating minima; and
- (k) analysis of operators's performance and occurrence reports related to unstable approaches and long landings.

The competent authority may require other mitigating measures in addition to those proposed by the operator.

AMC1 CAT.POL.A.255(b)(2)(iv) Approval of reduced required landing distance operations

ED Decision 2021/005/R

GENERAL

- (a) The operator should ensure that flight crew training programmes for reduced required landing distance operations include ground training, flight simulation training device (FSTD), and/or flight training.
- (b) Flight crew with no reduced required landing distance operations experience should have completed the full training programme of (a) above.
- (c) Flight crew with previous reduced required landing distance operations experience of a similar type of operation with another EU operator, may undertake the following:
 - (1) an abbreviated ground training course if operating an aircraft of a type or class different from that of the aircraft on which the previous reduced required landing distance operations experience was gained;
 - (2) an abbreviated ground, FSTD and/or flight training course if operating the same type or class and variant of the same aircraft type or class on which the previous reduced

required landing distance operations experience was gained; this course should include at least the provisions of the conversion training contained in this AMC; the operator may reduce the number of approaches/landings required by the conversion training if the type/class or the variant of the aircraft type or class has the same or similar operating procedures, handling characteristics and performance characteristics as the previously operated aircraft type or class.

- (d) Flight crew with reduced required landing distance operations experience with the operator may undertake an abbreviated ground, FSTD and/or flight training course according to the following conditions:
- (1) when changing aircraft type or class, the abbreviated course should include at least the content of the conversion training;
 - (2) when changing to a different variant of aircraft within the same type or class rating that has the same or similar operating procedures, handling characteristics and performance characteristics, as the previously operated aircraft type or class, a difference course or familiarisation appropriate to the change of variant should fulfil the abbreviated course's purposes; and
 - (3) when changing to a different variant of aircraft within the same type or class rating that has significantly different operating procedures, handling characteristics and performance characteristics, the abbreviated course should include the content of the conversion training.

GROUND TRAINING

- (a) The initial ground training course for reduced required landing distance operations should include at least the following:
- (1) operational procedures and limitations, including flight preparation and planning;
 - (2) characteristics of the runway visual aids and runway markings;
 - (3) aircraft performance related to reduced required landing distance operations, including:
 - (i) aircraft-specific decelerating devices and equipment;
 - (ii) items that increase the aircraft landing distance, e.g. excess speed at touchdown, threshold crossing height, delayed brake application, delayed spoiler/speed brake or thrust reverser application; and
 - (iii) runway surface conditions;
 - (4) in-flight assessment of landing performance, including maximum landing masses and runway conditions;
 - (5) stabilised approach criteria;
 - (6) correct vertical flight path after the DA/MDA;
 - (7) correct flare, touchdown and braking techniques;
 - (8) touchdown within the appropriate touchdown zone;
 - (9) recognition of failure of aircraft equipment affecting aircraft performance, and action to be taken in that event;
 - (10) flight crew task allocation and pilot monitoring duties, including monitoring of the activation of deceleration devices;

- (11) go-around/balked-landing criteria and decision-making;
- (12) selection of precision approaches versus non-precision approaches if both are available; and
- (13) qualification requirements for pilots to obtain and retain reduced required landing distance operations, including aerodrome landing analysis programme (ALAP) procedures.

FSTD TRAINING AND/OR FLIGHT TRAINING

- (a) FSTD and/or flight training should be undertaken by all flight crew on flight duty at the controls during landing when performing reduced required landing distance operations.
- (b) FSTD and/or flight training for reduced required landing distance operations should include checks of equipment functionality, both on the ground and in flight.
- (c) Initial reduced required landing distance operations training should consist of a minimum of two approaches and landings to include at least the following exercises which may be combined:
 - (1) an approach and landing at the maximum landing mass;
 - (2) an approach and landing without the use of visual approach;
 - (3) a landing on a wet runway;
 - (4) a landing with crosswind;
 - (5) a malfunction of a stopping device on landing; and
 - (6) a go-around/balked landing.
- (d) Special emphasis should be given to the following items:
 - (1) in-flight assessment of landing performance;
 - (2) stabilised approach, recognition of an unstable approach and, consequentially, a go-around;
 - (3) flight crew task allocation and pilot monitoring duties, including monitoring of the activation of deceleration devices;
 - (4) timely and correct activation of deceleration devices;
 - (5) correct flare technique; and
 - (6) landing within the appropriate touchdown zone.

CONVERSION TRAINING

Flight crew members should complete the following reduced required landing distance operations training if converting to a new type or class or variant of aircraft in which reduced required landing distance operations will be conducted.

- (a) Ground training, taking into account the flight crew member's reduced required landing distance operations experience.
- (b) FSTD training and/or flight training.

RECURRENT TRAINING AND CHECKING

- (a) The operator should ensure that in conjunction with the normal recurrent training and operator's proficiency checks, the pilot's knowledge and ability to perform the tasks associated with reduced required landing distance operations are adequate.
- (b) The items of the ground training should cover a 3-year period.
- (c) An annual reduced required landing distance operations training should consist of a minimum of two approaches and landings so that it includes at least the following exercises which may be combined:
 - (1) an approach and landing at the maximum landing mass;
 - (2) an approach and landing without the use of visual approach;
 - (3) a landing on a wet runway;
 - (4) a malfunction of a stopping device on landing; and
 - (5) a go-around/balked landing.
 - (6) Operations in crosswind conditions

FLIGHT CREW QUALIFICATION AND EXPERIENCE

- (a) Flight crew qualification and experience are specific to the operator and type of aircraft operated.
- (b) The operator should ensure that each flight crew member successfully completes the specified FSTD and/or flight training before conducting reduced required landing distance operations.
- (c) The operator should ensure that no inexperienced flight crew members, as defined in AMC1.ORO.FC.200(a), perform an approach and landing with reduced required landing distance operations.

AMC2 CAT.POL.A.255(b)(2)(iv) Approval of reduced required landing distance operations

ED Decision 2021/005/R

MONITORING

- (a) Reduced required landing distance operations should be continuously monitored by the operator to detect any undesirable trends before they become hazardous.
- (b) A flight data monitoring (FDM) programme, as required by ORO.AOC.130, is an acceptable method to monitor operational risks related to reduced required landing distance operations.
- (c) When an FDM programme is in use, it should include FDM events or FDM measurements relevant for monitoring the risk of runway excursions at landing.
- (d) When FDM is neither required by ORO.AOC.130, nor implemented on a voluntary basis, flight crew reports should be used. Specific guidance for reporting events and exceedances during reduced required landing distance operations should be provided to the flight crew.

GM1 CAT.POL.A.255(b)(2)(iv) Approval of reduced required landing distance operations

ED Decision 2021/005/R

GENERAL

Flight crew training should be conducted preferably at aerodromes representative of the intended operations. An FSTD generic aerodrome with the same characteristics of an aerodrome requiring the reduced required landing distance is also acceptable for the initial and recurrent training.

GM2 CAT.POL.A.255(b)(2)(iv) Approval of reduced required landing distance operations

ED Decision 2021/005/R

MONITORING

- (a) Although ORO.AOC.130 requires an FDM programme only for aeroplanes with a maximum certified take-off mass (MCTOM) of more than 27 000 kg, FDM may be used voluntarily on aeroplanes having a lower MCTOM. It is recommended for all operators conducting reduced required landing distance operations.
- (b) Guidance on the definition of FDM events and FDM measurements relevant for monitoring the risk of runway excursion at landing may be found in the publications of the European Operators Flight Data Monitoring (EOFDM) forum.

AMC1 CAT.POL.A.255(b)(2)(v) Approval of reduced required landing distance operations

ED Decision 2021/005/R

AERODROME LANDING ANALYSIS PROGRAMME (ALAP)

The intent of an ALAP is to ensure that the aerodrome critical data related to landing performance in reduced required landing distance operations is known and taken into account in order to avoid any further increase of the landing distance. Two important aerodrome-related variables largely contribute to increasing the landing distance: landing (ground) speed and deceleration capability. Related factors to consider should include at least the following elements:

(a) Topography

Terrain around the aerodrome should be considered. High, fast-rising terrain may require special approach or decision points, missed approach or balked landing procedures and may affect landing performance. Aerodromes located on top of hilly terrain or downwind of mountainous terrain may occasionally experience conditions of wind shear and gusts. Such conditions are particularly relevant during the landing manoeuvre, particularly during the flare, and may increase landing distance.

(b) Runway conditions

Runway characteristics, such as unknown slope and surface composition, can cause the actual landing distance to be longer than the calculated landing distance. The braking action always impacts the landing distance required as it deteriorates. To this regard, consideration should be given to, and information obtained on, the maintenance status of the runway, as a wet runway surface may be significantly degraded due to poor aerodrome maintenance.

(c) Aerodrome or area weather

Some aerodromes may not have current weather reports and forecast available for flight planning. Others may have automated observations for operational use. Others may depend on the weather forecast of a nearby aerodrome. Area forecasts are also valuable in evaluating weather conditions for a particular operation. Comparing forecasted conditions to current conditions provides insight on upcoming changes as weather systems move and forecasts are updated. Longer flight segments may lean more heavily on the forecast for the estimated time of arrival (ETA), as current conditions may change significantly as weather systems move. The most important factors that should be considered are contained in AMC1 CAT.OP.MPA.300(a), AMC1 CAT.OP.MPA.311, GM1 CAT.OP.MPA.311, GM1 CAT.OP.MPA.303 and GM2 CAT.OP.MPA.303.

(d) Adverse weather

Adverse weather conditions include, but are not restricted to, thunderstorms, showers, downbursts, squall lines, tornadoes, moderate or severe turbulence on approach, heavy precipitation, wind shear and icing conditions. In general, all weather phenomena having the potential to increase the landing distance should be carefully assessed. Among these, tailwind is particularly relevant.

Wind variations should be carefully monitored as they may lead to variations in the reported and/or actual wind at the touchdown zone. Due consideration should be given also to the crosswind perpendicular to the landing runway as a slight variation in the direction of the crosswind may result in a considerable tailwind component.

(e) Runway safety margins

Displaced thresholds, aerodrome construction, and temporary obstacles (such as cranes and drawbridges) may impact the runway length available for landing. Notices to airmen (NOTAMs) must be consulted during the flight preparation. Another safety margin is the size and adequacy of the runway strip and the runway end safety area (RESA). A well-designed and well-maintained runway strip and RESA decrease the risk of damaging the aircraft in case of a runway excursion. ICAO Annex 14 provides the Standards and Recommended Practices (SARPs) to this regard.

GM1 CAT.POL.A.255(b)(2)(v) Approval of reduced required landing distance operations

ED Decision 2021/005/R

AERODROME LANDING ANALYSIS PROGRAMME (ALAP) — AERODROME FACILITIES

The ALAP may also consider the services that are available at the aerodrome. Services such as communications, maintenance, and fuelling, availability of adequate rescue and firefighting services (RFFS) and medical services may have an impact on operations to and from that aerodrome, though not directly related to the landing distance. It is also worth considering whether the aerodrome is only meeting ICAO and national standards or also ICAO recommendations, as well as when the aerodrome bearing ratios are below the design and maintenance criteria indicated in ICAO Doc 9157 'Aerodrome Design Manual'.

AMC1 CAT.POL.A.255(b)(2)(vi) Approval of reduced required landing distance operations

ED Decision 2021/005/R

EQUIPMENT AFFECTING LANDING PERFORMANCE

Equipment affecting landing performance typically includes flaps, slats, spoilers, brakes, anti-skid, autobrakes, reversers, etc. The operator should establish procedures to identify, based on the aircraft characteristics, those systems and the equipment that are performance relevant, and to ensure that they are verified to be operative before commencing the flight. Appropriate entries should be included in the minimum equipment list (MEL) to prohibit dispatch with such equipment inoperative when conducting reduced required landing distance operations.

GM1 CAT.POL.A.255(b)(2)(vi) Approval of reduced required landing distance operations

ED Decision 2021/005/R

EQUIPMENT AFFECTING LANDING PERFORMANCE

Should any item of equipment affecting landing performance become inoperative during flight, the failure will be dealt with in accordance with the abnormal/emergency procedures established in the OM and, based on the prevailing conditions for the remainder of the flight, the commander will decide upon the discontinuation of the planned operation of reduced required landing distance.

AMC1 CAT.POL.A.255(b)(2)(vii) Approval of reduced required landing distance operations

ED Decision 2021/005/R

REGENCY

Flight crew conducting reduced landing distance operations should perform at least two landings with reduced landing distance, either in actual operations or in an FSTD, performed within the validity period of the operator proficiency check (OPC).

AMC1 CAT.POL.A.255(b)(2)(ix) Approval of reduced required landing distance operations

ED Decision 2021/005/R

ADDITIONAL AERODROME CONDITIONS

- (a) Operators should establish procedures to ensure that:
- (1) the aerodrome information is obtained from an authoritative source, or when this is not available, from a source that has been verified by the operator to meet quality standards that are adequate for the intended use;
 - (2) any change reducing landing distances that has been declared by the aerodrome operator has been taken into account; and
 - (3) no steep approaches, screen heights lower than 35 ft or higher than 60 ft, operations outside the stabilised approach criteria, or low-visibility operations are required at the aerodrome when reduced required landing distance operations are conducted.

- (b) Additional aerodrome conditions related to aeroplane type characteristics, orographic characteristics in the approach area, available approach aids and missed approach/balked landing considerations, as well as operating limitations, should also be taken into account.
- (c) When assessing the aerodrome characteristics and the level of risk of the aeroplane undershooting or overrunning the runway, the operator should consider the nature and location of any hazard beyond the runway end, including the topography and obstruction environment beyond the runway strip, the length of the RESA and the effectiveness of any other mitigation measures that may be in place to reduce the likelihood and the consequences of a runway overrun.

CHAPTER 3 – PERFORMANCE CLASS B

CAT.POL.A.300 General

Regulation (EU) 2017/363

- (a) Unless approved by the competent authority in accordance with Annex V (Part-SPA), Subpart L — SINGLE- ENGINED TURBINE AEROPLANE OPERATIONS AT NIGHT OR IN IMC (SET-IMC), the operator shall not operate a single-engined aeroplane:
 - (1) at night; or
 - (2) in IMC, except under special VFR.
- (b) The operator shall treat two-engined aeroplanes that do not meet the climb requirements of [CAT.POL.A.340](#) as single-engined aeroplanes.

CAT.POL.A.305 Take-off

Regulation (EU) No 965/2012

- (a) The take-off mass shall not exceed the maximum take-off mass specified in the AFM for the pressure altitude and the ambient temperature at the aerodrome of departure.
- (b) The unfactored take-off distance, specified in the AFM, shall not exceed:
 - (1) when multiplied by a factor of 1,25, the take-off run available (TORA); or
 - (2) when stop way and/or clearway is available, the following:
 - (i) the TORA;
 - (ii) when multiplied by a factor of 1,15, the take-off distance available (TODA); or
 - (iii) when multiplied by a factor of 1,3, the ASDA.
- (c) When showing compliance with (b), the following shall be taken into account:
 - (1) the mass of the aeroplane at the commencement of the take-off run;
 - (2) the pressure altitude at the aerodrome;
 - (3) the ambient temperature at the aerodrome;
 - (4) the runway surface condition and the type of runway surface;
 - (5) the runway slope in the direction of take-off; and
 - (6) not more than 50 % of the reported headwind component or not less than 150 % of the reported tailwind component.

AMC1 CAT.POL.A.305 Take-off

ED Decision 2021/005/R

RUNWAY SURFACE CONDITION

- (a) Unless otherwise specified in the AFM or other performance or operating manuals from the manufacturer, the variables affecting the take-off performance and the associated factors that should be applied to the AFM data are shown in Table 1 below. They should be applied in addition to the operational factors as prescribed in [CAT.POL.A.305](#).

Table 1

Runway surface condition — Variables

Surface type	Condition	Factor
Grass (on firm soil) up to 20 cm long	Dry	1.2
up to 20 cm long	Wet	1.3
Paved	Wet	1.0

- (b) The soil should be considered firm when there are wheel impressions but no rutting.
- (c) When taking off on grass with a single-engined aeroplane, care should be taken to assess the rate of acceleration and consequent distance increase.
- (d) When making a rejected take-off on very short grass that is wet and with a firm subsoil, the surface may be slippery, in which case the distances may increase significantly.
- (e) The determination of take-off performance data for wet and contaminated runways, when such data is available, should be based on the reported runway surface condition in terms of contaminant and depth.

AMC2 CAT.POL.A.305 Take-off

ED Decision 2014/015/R

RUNWAY SLOPE

Unless otherwise specified in the AFM, or other performance or operating manuals from the manufacturer, the take-off distance should be increased by 5 % for each 1 % of upslope except that correction factors for runways with slopes in excess of 2 % should only be applied when the operator has demonstrated to the competent authority that the necessary data in the AFM or the operations manual contain the appropriated procedures and the crew is trained to take-off in runway with slopes in excess of 2 %.

GM1 CAT.POL.A.305 Take-off

ED Decision 2014/015/R

RUNWAY SURFACE CONDITION

- (a) Due to the inherent risks, operations from contaminated runways are inadvisable, and should be avoided whenever possible. Therefore, it is advisable to delay the take-off until the runway is cleared.
- (b) Where this is impracticable, the commander should also consider the excess runway length available including the criticality of the overrun area.

CAT.POL.A.310 Take-off obstacle clearance – multi-engined aeroplanes

Regulation (EU) No 379/2014

- (a) The take-off flight path of aeroplanes with two or more engines shall be determined in such a way that the aeroplane clears all obstacles by a vertical distance of at least 50 ft, or by a horizontal distance of at least 90 m plus $0,125 \times D$, where D is the horizontal distance travelled by the aeroplane from the end of the TODA or the end of the take-off distance if a turn is scheduled before the end of the TODA, except as provided in (b) and (c). For aeroplanes with a wingspan of less than 60 m, a horizontal obstacle clearance of half the aeroplane wingspan plus 60 m plus $0,125 \times D$ may be used. It shall be assumed that:
- (1) the take-off flight path begins at a height of 50 ft above the surface at the end of the take-off distance required by [CAT.POL.A.305\(b\)](#) and ends at a height of 1 500 ft above the surface;
 - (2) the aeroplane is not banked before the aeroplane has reached a height of 50 ft above the surface, and thereafter the angle of bank does not exceed 15°;
 - (3) failure of the critical engine occurs at the point on the all engine take-off flight path where visual reference for the purpose of avoiding obstacles is expected to be lost;
 - (4) the gradient of the take-off flight path from 50 ft to the assumed engine failure height is equal to the average all-engines gradient during climb and transition to the en-route configuration, multiplied by a factor of 0,77; and
 - (5) the gradient of the take-off flight path from the height reached in accordance with (a)(4) to the end of the take-off flight path is equal to the OEI en-route climb gradient shown in the AFM.
- (b) For cases where the intended flight path does not require track changes of more than 15°, the operator does not need to consider those obstacles that have a lateral distance greater than:
- (1) 300 m, if the flight is conducted under conditions allowing visual course guidance navigation, or if navigational aids are available enabling the pilot to maintain the intended flight path with the same accuracy; or
 - (2) 600 m, for flights under all other conditions.
- (c) For cases where the intended flight path requires track changes of more than 15°, the operator does not need to consider those obstacles that have a lateral distance greater than:
- (1) 600 m, for flights under conditions allowing visual course guidance navigation; or
 - (2) 900 m, for flights under all other conditions.
- (d) When showing compliance with (a) to (c), the following shall be taken into account:
- (1) the mass of the aeroplane at the commencement of the take-off run;
 - (2) the pressure altitude at the aerodrome;
 - (3) the ambient temperature at the aerodrome; and
 - (4) not more than 50 % of the reported headwind component or not less than 150 % of the reported tailwind component.
- (e) The requirements in (a)(3), (a)(4), (a)(5), (b)(2) and (c)(2) shall not be applicable to VFR operations by day.

AMC1 CAT.POL.A.310 Take-off obstacle clearance – multi-engined aeroplanes

ED Decision 2014/015/R

TAKE-OFF FLIGHT PATH — VISUAL COURSE GUIDANCE NAVIGATION

- (a) In order to allow visual course guidance navigation, the weather conditions prevailing at the time of operation, including ceiling and visibility, should be such that the obstacle and/or ground reference points can be seen and identified. For VFR operations by night, the visual course guidance should be considered available when the flight visibility is 1 500 m or more.
- (b) The operations manual should specify, for the aerodrome(s) concerned, the minimum weather conditions that enable the flight crew to continuously determine and maintain the correct flight path with respect to ground reference points so as to provide a safe clearance with respect to obstructions and terrain as follows:
 - (1) the procedure should be well defined with respect to ground reference points so that the track to be flown can be analysed for obstacle clearance requirements;
 - (2) the procedure should be within the capabilities of the aeroplane with respect to forward speed, bank angle and wind effects;
 - (3) a written and/or pictorial description of the procedure should be provided for crew use; and
 - (4) the limiting environmental conditions should be specified (e.g. wind, cloud, visibility, day/night, ambient lighting, obstruction lighting).

AMC2 CAT.POL.A.310 Take-off obstacle clearance – multi-engined aeroplanes

ED Decision 2014/015/R

TAKE-OFF FLIGHT PATH CONSTRUCTION

- (a) For demonstrating that the aeroplane clears all obstacles vertically, a flight path should be constructed consisting of an all-engines segment to the assumed engine failure height, followed by an engine-out segment. Where the AFM does not contain the appropriate data, the approximation given in (b) may be used for the all-engines segment for an assumed engine failure height of 200 ft, 300 ft, or higher.
- (b) Flight path construction
 - (1) All-engines segment (50 ft to 300 ft)

The average all-engines gradient for the all-engines flight path segment starting at an altitude of 50 ft at the end of the take-off distance ending at or passing through the 300 ft point is given by the following formula:

$$Y_{300} = \frac{0 \cdot 57(Y_{ERC})}{1 + (V_{ERC}^2 - V_2^2)/5647}$$

The factor of 0.77 as required by [CAT.POL.A.310](#) is already included where:

Y_{300} = average all-engines gradient from 50 ft to 300 ft;

Y_{ERC} = scheduled all engines en-route gross climb gradient;

V_{ERC} = en-route climb speed, all engines knots true airspeed (TAS);

V_2 = take-off speed at 50 ft, knots TAS;

- (2) All-engines segment (50 ft to 200 ft)

This may be used as an alternative to (b)(1) where weather minima permit. The average all-engines gradient for the all-engines flight path segment starting at an altitude of 50 ft at the end of the take-off distance ending at or passing through the 200 ft point is given by the following formula:

$$Y_{200} = \frac{0.77(Y_{ERC})}{1 + (V_{ERC}^2 - V_2^2)/3388}$$

The factor of 0.77 as required by [CAT.POL.A.310](#) is already included where:

Y_{200} = average all-engines gradient from 50 ft to 200 ft;

Y_{ERC} = scheduled all engines en-route gross climb gradient;

V_{ERC} = en-route climb speed, all engines, knots TAS;

V_2 = take-off speed at 50 ft, knots TAS.

- (3) All-engines segment (above 300 ft)

The all-engines flight path segment continuing from an altitude of 300 ft is given by the AFM en-route gross climb gradient, multiplied by a factor of 0.77.

- (4) The OEI flight path

The OEI flight path is given by the OEI gradient chart contained in the AFM.

GM1 CAT.POL.A.310 Take-off obstacle clearance – multi-engined aeroplanes

ED Decision 2014/015/R

OBSTACLE CLEARANCE IN LIMITED VISIBILITY

- (a) Unlike the Certification Specifications applicable for performance class A aeroplanes, those for performance class B aeroplanes do not necessarily provide for engine failure in all phases of flight. It is accepted that performance accountability for engine failure need not be considered until a height of 300 ft is reached.
- (b) The weather minima given up to and including 300 ft imply that if a take-off is undertaken with minima below 300 ft, an OEI flight path should be plotted starting on the all-engines take-off flight path at the assumed engine failure height. This path should meet the vertical and lateral obstacle clearance specified in [CAT.POL.A.310](#). Should engine failure occur below this height, the associated visibility is taken as being the minimum that would enable the pilot to make, if necessary, a forced landing broadly in the direction of the take-off. At or below 300 ft, a circle and land procedure is extremely inadvisable. The weather minima provisions specify that, if the assumed engine failure height is more than 300 ft, the visibility should be at least 1 500 m and, to allow for manoeuvring, the same minimum visibility should apply whenever the obstacle clearance criteria for a continued take-off cannot be met.

GM2 CAT.POL.A.310 Take-off obstacle clearance – multi-engined aeroplanes

ED Decision 2014/015/R

TAKE-OFF FLIGHT PATH CONSTRUCTION

(a) This GM provides examples to illustrate the method of take-off flight path construction given in [AMC2 CAT.POL.A.310](#). The examples are based on an aeroplane for which the AFM shows, at a given mass, altitude, temperature and wind component the following performance data:

- factored take-off distance – 1 000 m;
- take-off speed, V_2 – 90 kt;
- en-route climb speed, V_{ERC} – 120 kt;
- en-route all-engines climb gradient, Y_{ERC} – 0.2;
- en-route OEI climb gradient, Y_{ERC-1} – 0.032.

(1) Assumed engine failure height 300 ft

The average all-engines gradient from 50 ft to 300 ft may be read from Figure 1 or calculated with the following formula:

$$Y_{300} = \frac{0 \cdot 57(Y_{ERC})}{1 + (V_{ERC}^2 - V_2^2)/5647}$$

The factor of 0.77 as required by [CAT.POL.A.310](#) is already included where:

- Y_{300} = average all-engines gradient from 50 ft to 300 ft;
- Y_{ERC} = scheduled all engines en-route gross climb gradient;
- V_{ERC} = en-route climb speed, all engines knots TAS; and
- V_2 = take-off speed at 50 ft, knots TAS.

Figure 1

Assumed engine failure height 300 ft

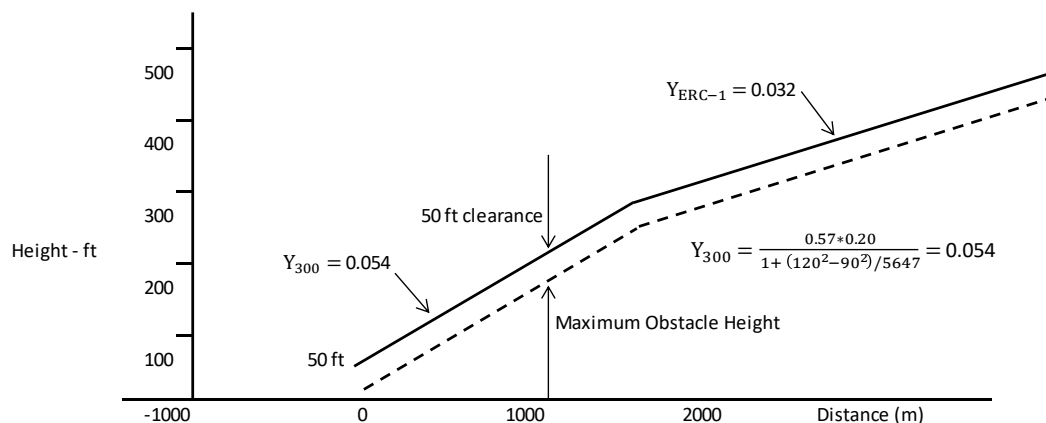

(2) Assumed engine failure height 200 ft

The average all-engines gradient from 50 ft to 200 ft may be read from Figure 2 or calculated with the following formula:

$$Y_{200} = \frac{0 \cdot 51(Y_{ERC})}{1 + (V_{ERC}^2 - V_2^2)/3388}$$

The factor of 0.77 as required by [CAT.POL.A.310](#) is already included where:

- Y_{200} = average all-engines gradient from 50 ft to 200 ft;
- Y_{ERC} = scheduled all engines en-route gross gradient;
- V_{ERC} = en-route climb speed, all engines, knots TAS; and
- V_2 = take-off speed at 50 ft, knots TAS.

Figure 2

Assumed engine failure height 200 ft

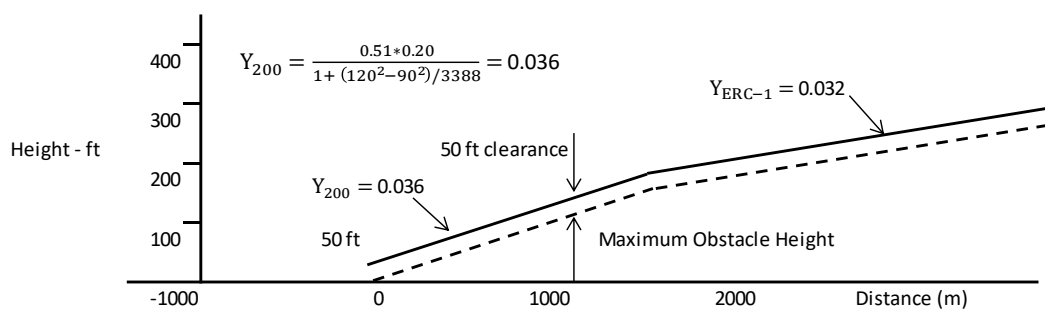

- (3) Assumed engine failure height less than 200 ft

Construction of a take-off flight path is only possible if the AFM contains the required flight path data.

- (4) Assumed engine failure height more than 300 ft

The construction of a take-off flight path for an assumed engine failure height of 400 ft is illustrated below.

Figure 3

Assumed engine failure height less than 200 ft

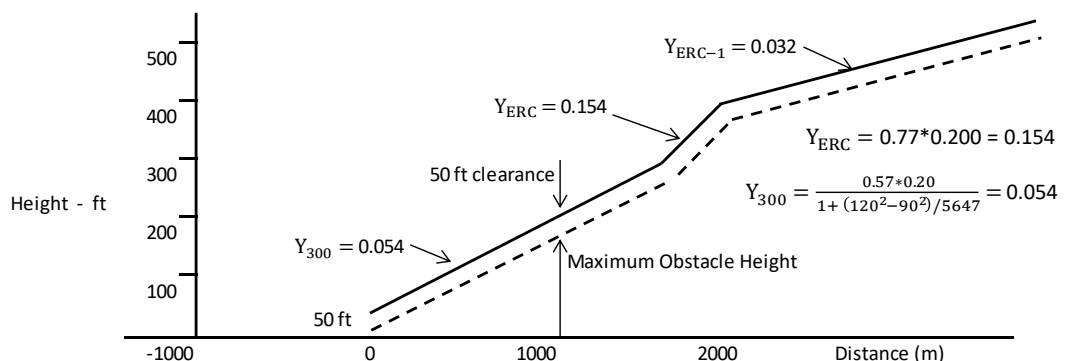

CAT.POL.A.315 En-route – multi-engined aeroplanes

Regulation (EU) No 965/2012

- (a) The aeroplane, in the meteorological conditions expected for the flight and in the event of the failure of one engine, with the remaining engines operating within the maximum continuous power conditions specified, shall be capable of continuing flight at or above the relevant minimum altitudes for safe flight stated in the operations manual to a point of 1 000 ft above an aerodrome at which the performance requirements can be met.
- (b) It shall be assumed that, at the point of engine failure:
 - (1) the aeroplane is not flying at an altitude exceeding that at which the rate of climb equals 300 ft per minute with all engines operating within the maximum continuous power conditions specified; and
 - (2) the en-route gradient with OEI shall be the gross gradient of descent or climb, as appropriate, respectively increased by a gradient of 0,5 %, or decreased by a gradient of 0,5 %.

GM1 CAT.POL.A.315 En-route – multi-engined aeroplanes

ED Decision 2014/015/R

CRUISING ALTITUDE

- (a) The altitude at which the rate of climb equals 300 ft per minute is not a restriction on the maximum cruising altitude at which the aeroplane can fly in practice, it is merely the maximum altitude from which the driftdown procedure can be planned to start.
- (b) Aeroplanes may be planned to clear en-route obstacles assuming a driftdown procedure, having first increased the scheduled en-route OEI descent data by 0.5 % gradient.

CAT.POL.A.320 En-route – single-engined aeroplanes

Regulation (EU) 2017/363

- (a) In the meteorological conditions expected for the flight, and in the event of engine failure, the aeroplane shall be capable of reaching a place at which a safe forced landing can be made, unless the operator is approved by the competent authority in accordance with Annex V (Part-SPA), Subpart L — SINGLE-ENGINE TURBINE AEROPLANE OPERATIONS AT NIGHT OR IN IMC (SET-IMC) and makes use of a risk period.
- (b) For the purposes of point (a), it shall be assumed that, at the point of engine failure:
 - (1) the aeroplane is not flying at an altitude exceeding that at which the rate of climb equals 300 ft per minute, with the engine operating within the maximum continuous power conditions specified; and
 - (2) the en-route gradient is the gross gradient of descent increased by a gradient of 0,5 %.

AMC1 CAT.POL.A.320 En-route – single-engined aeroplanes

ED Decision 2017/004/R

ENGINE FAILURE

[CAT.POL.A.320](#) requires the operator not approved by the competent authority in accordance with Subpart L (SET-IMC) of Annex V (Part-SPA) to Regulation (EU) No 965/2012, and not making use of a risk period, to ensure that in the event of an engine failure, the aeroplane should be capable of

reaching a point from which a safe forced landing can be made. Unless otherwise specified by the competent authority, this point should be 1 000 ft above the intended landing area.

GM1 CAT.POL.A.320 En-route – single-engined aeroplanes

ED Decision 2017/004/R

ENGINE FAILURE

Considerations for the operator not approved by the competent authority in accordance with Subpart L (SET-IMC) of Annex V (Part-SPA) to Regulation (EU) No 965/2012, and not making use of a risk period:

- (a) In the event of an engine failure, single-engined aeroplanes have to rely on gliding to a point suitable for a safe forced landing. Such a procedure is clearly incompatible with flight above a cloud layer that extends below the relevant minimum safe altitude.
- (b) The operator should first increase the scheduled engine-inoperative gliding performance data by 0.5 % gradient when verifying the en-route clearance of obstacles and the ability to reach a suitable place for a forced landing.
- (c) The altitude at which the rate of climb equals 300 ft per minute is not a restriction on the maximum cruising altitude at which the aeroplane can fly in practice, it is merely the maximum altitude from which the engine-inoperative procedure can be planned to start.

GM2 CAT.POL.A.320 En-route – single-engined aeroplanes

ED Decision 2017/004/R

RISK PERIOD

In the context of commercial air transport operations with single-engined turbine aeroplanes in instrument meteorological conditions or at night (CAT SET-IMC), a risk period is a period of flight during which no landing site has been selected by the operator.

CAT.POL.A.325 Landing – destination and alternate aerodromes

Regulation (EU) No 965/2012

The landing mass of the aeroplane determined in accordance with [CAT.POL.A.105\(a\)](#) shall not exceed the maximum landing mass specified for the altitude and the ambient temperature expected at the estimated time of landing at the destination aerodrome and alternate aerodrome.

AMC1 CAT.POL.A.325 Landing – destination and alternate aerodromes

ED Decision 2014/015/R

ALTITUDE MEASURING

The operator should use either pressure altitude or geometric altitude for its operation and this should be reflected in the operations manual.

CAT.POL.A.330 Landing – dry runways

Regulation (EU) 2019/1387

- (a) The landing mass of the aeroplane determined in accordance with point [CAT.POL.A.105\(a\)](#) for the estimated time of landing at the destination aerodrome and at any alternate aerodrome shall allow a full-stop landing from 50 ft above the threshold within 70 % of the LDA.
- (b) By way of derogation from point (a), and where point CAT.POL.A.355 is complied with, the landing mass of the aeroplane determined in accordance with point CAT.POL.A.105(a) for the estimated time of landing at the destination aerodrome shall be such as to allow a full-stop landing from 50 ft above the threshold within 80 % of the LDA.
- (c) When determining the landing mass, the operator shall take the following into account:
 - (1) the altitude at the aerodrome;
 - (2) not more than 50 % of the headwind component or not less than 150 % of the tailwind component;
 - (3) the type of runway surface;
 - (4) the runway slope in the direction of landing.
- (d) For steep approach operations, the operator shall use landing distance data factored in accordance with point (a), based on a screen height of less than 60 ft, but not less than 35 ft, and comply with point CAT.POL.A.345.
- (e) For short landing operations, the operator shall use landing distance data factored in accordance with point (a), and comply with point CAT.POL.A.350.
- (f) For dispatching the aeroplane, the aeroplane shall either:
 - (1) land on the most favourable runway, in still air;
 - (2) land on the runway most likely to be assigned considering the probable wind speed and direction, the ground-handling characteristics of the aeroplane and other conditions such as landing aids and terrain.
- (g) If the operator is unable to comply with point (f)(2) for the destination aerodrome, the aeroplane shall only be dispatched if an alternate aerodrome is designated that permits full compliance with points (a) to (f).

AMC1 CAT.POL.A.330 Landing – dry runways

ED Decision 2021/005/R

LANDING DISTANCE CORRECTION FACTORS

- (a) Unless otherwise specified in the AFM, or other performance or operating manuals from the manufacturers, the variable affecting the landing performance and the associated factor that should be applied to the AFM data are shown in the table below. It should be applied in addition to the operational factors as prescribed in [CAT.POL.A.330 \(a\)](#) and [CAT.POL.A.330\(b\)](#).

Table 1

Landing distance correction factors

Surface type	Factor
Grass (on firm soil up to 20 cm long)	1.15

- (b) The soil should be considered firm when there are wheel impressions but no rutting.

AMC2 CAT.POL.A.330 Landing – dry runways

ED Decision 2014/015/R

RUNWAY SLOPE

Unless otherwise specified in the AFM, or other performance or operating manuals from the manufacturer, the landing distances required should be increased by 5 % for each 1 % of downslope.

GM1 CAT.POL.A.330 Landing — dry runways

ED Decision 2021/005/R

LANDING MASS

[CAT.POL.A.330](#) establishes two considerations in determining the maximum permissible landing mass at the destination and alternate aerodromes.

- (a) Firstly, the aeroplane mass will be such that on arrival the aeroplane can be landed within 70 % or 80 %, as applicable, of the LDA on the most favourable (normally the longest) runway in still air. Regardless of the wind conditions, the maximum landing mass for an aerodrome/aeroplane configuration at a particular aerodrome cannot be exceeded.
- (b) Secondly, consideration should be given to anticipated conditions and circumstances. The expected wind, or ATC and noise abatement procedures, may indicate the use of a different runway. These factors may result in a lower landing mass than that permitted under (a), in which case dispatch should be based on this lesser mass.
- (c) The expected wind referred to in (b) is the wind expected to exist at the time of arrival.

GM1 CAT.POL.A.330(a) Landing — dry runways

ED Decision 2021/005/R

ALTERNATE AERODROMES

The alternate aerodromes for which the landing mass is required to be determined in accordance with [CAT.POL.A.330](#) are:

- (a) destination alternate aerodromes;
- (b) fuel ERA aerodromes; and
- (c) re-dispatch or re-clearance aerodromes.

CAT.POL.A.335 Landing – wet and contaminated runways

Regulation (EU) 2019/1387

- (a) When the appropriate weather reports or forecasts indicate that the runway at the estimated time of arrival may be wet, the LDA shall be one of the following distances:
- (1) a landing distance provided in the AFM for use on wet runways at time of dispatch, but not less than that required by point [CAT.POL.A.330](#);
 - (2) if a landing distance is not provided in the AFM for use on wet runways at time of dispatch, at least 115 % of the required landing distance, determined in accordance with point [CAT.POL.A.330\(a\)](#);

- (3) a landing distance shorter than that required by point (a)(2), but not less than that required by point [CAT.POL.A.330\(a\)](#), as applicable, if the runway has specific friction improving characteristics and the AFM includes specific additional information for landing distance on that runway type;
 - (4) by way of derogation from points (a)(1), (a)(2) and (a)(3), for aeroplanes that are approved for reduced landing distance operations under point [CAT.POL.A.355](#), the landing distance determined in accordance with point CAT.POL.A.355(b)(7)(iii).
- (b) When the appropriate weather reports or forecasts indicate that the runway at the estimated time of arrival may be contaminated, the landing distance shall not exceed the LDA. The operator shall specify in the operations manual the landing distance data to be applied.

AMC1 CAT.POL.A.335 Landing — wet and contaminated runways

ED Decision 2021/005/R

WET AND CONTAMINATED RUNWAY DATA

The determination of landing performance data should be based on information provided in the OM on the reported RWYCC. The RWYCC is determined by the aerodrome operator using the RCAM and associated procedures defined in Annex V (Part-ADR.OPS) to Regulation (EU) No 139/2014. The RWYCC is reported through an RCR in the SNOWTAM format in accordance with ICAO Annex 15.

GM1 CAT.POL.A.335 Landing — wet and contaminated runways

ED Decision 2014/015/R

LANDING ON WET GRASS RUNWAYS

- (a) When landing on very short grass that is wet and with a firm subsoil, the surface may be slippery, in which case the distances may increase by as much as 60 % (1.60 factor).
- (b) As it may not be possible for a pilot to determine accurately the degree of wetness of the grass, particularly when airborne, in cases of doubt, the use of the wet factor (1.15) is recommended.

GM2 CAT.POL.A.335 Landing — wet and contaminated runways

ED Decision 2021/005/R

DISPATCH CONSIDERATIONS FOR MARGINAL CASES

The LDTA required by [CAT.OP.MPA.303](#) may, in some cases, and in particular on wet or contaminated runways, exceeds the landing distance considered at the time of dispatch. The requirements for dispatch remain unchanged; however, when the conditions at the time of arrival are expected to be marginal, it is a good practice to carry out at the time of dispatch a preliminary calculation of the LDTA.

GM1 CAT.POL.A.335(a)(1) Landing — wet and contaminated runways

ED Decision 2021/005/R

AFM LANDING DISTANCES FOR WET RUNWAYS

Specific landing distances provided in the AFM for dispatch on wet runways, unless otherwise indicated, include a safety factor, which renders the application of the 15 % safety factor used in [CAT.POL.A.335\(a\)\(2\)](#) not necessary. This implies that the AFM distance may be presented as factored distance. When the AFM distance is not factored, a safety factor of 15 % should be applied. These

distances may be longer or shorter than those resulting from CAT.POL.A.335(a)(2), but when provided, they are intended as a replacement of [CAT.POL.A.335\(a\)\(2\)](#) and it is mandatory to be used at the time of dispatch.

AMC1 CAT.POL.A.335(a)(3) Landing — wet and contaminated runways

ED Decision 2021/005/R

RUNWAYS WITH FRICTION IMPROVING CHARACTERISTICS

- (a) Materials or construction techniques meant to improve the friction characteristics of a runway may be grooved runways, runways treated with PFC or other materials or techniques for which the AFM provides specific performance data.
- (b) Before taking the AFM performance credit for such runways, the operator should verify that the runways intended to be operated on are maintained to the extent necessary to ensure the expected improved friction characteristics.

GM1 CAT.POL.A.330 & CAT.POL.A.335 Landing — dry runways & Landing — wet and contaminated runways

ED Decision 2021/005/R

LANDING DISTANCES AND CORRECTIVE FACTORS

The AFM provides performance data for the landing distance under conditions defined in the applicable certification standards. This distance, commonly referred to as the ALD, is the distance from the position on the runway of the screen height to the point where the aeroplane comes to a full stop on a dry runway.

The determination of the ALD is based on the assumption that the landing is performed in accordance with the conditions and the procedures set out in the AFM on the basis of the applicable certification standards.

As a matter of fact, any particular landing may be different from the landing technique that is assumed in the AFM for certification purposes. The aircraft may approach the runway faster and/or higher than assumed; the aircraft may touch down further along the runway than the optimum point; the actual winds and other weather factors may be different from those assumed in the calculation of the ALD; and maximum braking may not be always achievable. For this reason, the LDA is required by [CAT.POL.A.330](#) and [CAT.POL.A.335](#) to be longer than the ALD.

The margins by which the LDA shall exceed the ALD on dry runways, in accordance with CAT.POL.A.330, are shown in the following Table 1.

Table 1: Corrective factors for dry runways

Aeroplane category	Required Margin (dry runway)	Resulting factor (dry runway)
All aeroplanes	ALD < 70 % of the LDA	LDA = at least 1.43 x ALD
Aeroplanes approved under CAT.POL.A.355	ALD < 80 % of the LDA	LDA = at least 1.25 x ALD

If the runway is wet and the AFM does not provide specific performance data for dispatch on wet runways, a further increase of 15 % of the landing distance on dry runways has to be applied, in accordance with CAT.POL.A.335, as shown in the following Table 2:

Table 2: Corrective factors for wet runways

Aeroplane category	Resulting factor (dry runway)
All aeroplanes	LDA = at least 1.15 x 1.43 x ALD = 1.64 x ALD
Aeroplanes approved under CAT.POL.A.355	LDA = at least 1.15 x 1.25 X ALD = 1.44 x ALD

However, for aeroplanes approved under [CAT.POL.A.355](#), when landing on wet runways, CAT.POL.A.355 further requires the flight crew to apply the longer of the landing distance resulting from the above table and the landing distance resulting from the application of [CAT.OP.MPA.303\(b\)](#). If performance information for the assessment of LDTA is not available as per CAT.OP.MPA.303(b)(2), the required landing distance on wet runways should be at least: 1.15 x 1.67 x ALD for turbojet-powered aircraft and 1.15 x 1.43 x ALD for turbopropeller-powered aircraft.

CAT.POL.A.340 Take-off and landing climb requirements

Regulation (EU) No 965/2012

The operator of a two-engined aeroplane shall fulfil the following take-off and landing climb requirements.

(a) *Take-off climb*

(1) All engines operating

(i) The steady gradient of climb after take-off shall be at least 4 % with:

- (A) take-off power on each engine;
- (B) the landing gear extended, except that if the landing gear can be retracted in not more than seven seconds, it may be assumed to be retracted;
- (C) the wing flaps in the take-off position(s); and
- (D) a climb speed not less than the greater of 1,1 V_{MC} (minimum control speed on or near ground) and 1,2 V_{S1} (stall speed or minimum steady flight speed in the landing configuration).

(2) OEI

(i) The steady gradient of climb at an altitude of 400 ft above the take-off surface shall be measurably positive with:

- (A) the critical engine inoperative and its propeller in the minimum drag position;
- (B) the remaining engine at take-off power;
- (C) the landing gear retracted;
- (D) the wing flaps in the take-off position(s); and
- (E) a climb speed equal to that achieved at 50 ft.

- (ii) The steady gradient of climb shall be not less than 0,75 % at an altitude of 1 500 ft above the take-off surface with:
 - (A) the critical engine inoperative and its propeller in the minimum drag position;
 - (B) the remaining engine at not more than maximum continuous power;
 - (C) the landing gear retracted;
 - (D) the wing flaps retracted; and
 - (E) a climb speed not less than $1,2 V_{S1}$.
- (b) *Landing climb*
 - (1) All engines operating
 - (i) The steady gradient of climb shall be at least 2,5 % with:
 - (A) not more than the power or thrust that is available eight seconds after initiation of movement of the power controls from the minimum flight idle position;
 - (B) the landing gear extended;
 - (C) the wing flaps in the landing position; and
 - (D) a climb speed equal to V_{REF} (reference landing speed).
 - (2) OEI
 - (i) The steady gradient of climb shall be not less than 0,75 % at an altitude of 1 500 ft above the landing surface with:
 - (A) the critical engine inoperative and its propeller in the minimum drag position;
 - (B) the remaining engine at not more than maximum continuous power;
 - (C) the landing gear retracted;
 - (D) the wing flaps retracted; and
 - (E) a climb speed not less than $1,2 V_{S1}$.

CAT.POL.A.345 Approval of steep approach operations

Regulation (EU) No 965/2012

- (a) Steep approach operations using glideslope angles of $4,5^\circ$ or more and with screen heights of less than 60 ft, but not less than 35 ft, require prior approval by the competent authority.
- (b) To obtain the approval, the operator shall provide evidence that the following conditions are met:
 - (1) the AFM states the maximum approved glideslope angle, any other limitations, normal, abnormal or emergency procedures for the steep approach as well as amendments to the field length data when using steep approach criteria; and
 - (2) for each aerodrome at which steep approach operations are to be conducted:
 - (i) a suitable glide path reference system, comprising at least a visual glide path indicating system, is available;

- (ii) weather minima are specified; and
- (iii) the following items are taken into consideration:
 - (A) the obstacle situation;
 - (B) the type of glide path reference and runway guidance;
 - (C) the minimum visual reference to be required at DH and MDA;
 - (D) available airborne equipment;
 - (E) pilot qualification and special aerodrome familiarisation;
 - (F) AFM limitations and procedures; and
 - (G) missed approach criteria.

GM1 CAT.POL.A.345(a) Approval of steep approach operations

ED Decision 2021/005/R

SCREEN HEIGHT

For the purpose of steep approach operations, the screen height is the reference height above the runway surface, typically above the runway threshold, from which the landing distance is measured. The screen height is set at 50 ft for normal operations and at another value between 60 ft and 35 ft for steep approach operations.

CAT.POL.A.350 Approval of short landing operations

Regulation (EU) No 965/2012

- (a) Short landing operations require prior approval by the competent authority.
- (b) To obtain the approval, the operator shall provide evidence that the following conditions are met:
 - (1) the distance used for the calculation of the permitted landing mass may consist of the usable length of the declared safe area plus the declared LDA;
 - (2) the use of the declared safe area is approved by the State of the aerodrome;
 - (3) the declared safe area is clear of obstructions or depressions that would endanger an aeroplane undershooting the runway and no mobile object is permitted on the declared safe area while the runway is being used for short landing operations;
 - (4) the slope of the declared safe area does not exceed 5 % upward nor 2 % downward slope in the direction of landing;
 - (5) the usable length of the declared safe area does not exceed 90 m;
 - (6) the width of the declared safe area is not less than twice the runway width, centred on the extended runway centreline;
 - (7) the crossing height over the beginning of the usable length of the declared safe area is not less than 50 ft;
 - (8) weather minima are specified for each runway to be used and are not less than the greater of VFR or NPA minima;
 - (9) pilot experience, training and special aerodrome familiarisation requirements are specified and met;

- (10) additional conditions, if specified by the competent authority, taking into account the aeroplane type characteristics, orographic characteristics in the approach area, available approach aids and missed approach/balked landing considerations.

CAT.POL.A.355 Approval of reduced required landing distance operations

Regulation (EU) 2020/1176

- (a) Operations with a landing mass of the aeroplane that allows a full-stop landing within 80 % of the landing distance available (LDA) require prior approval by the competent authority. Such approval shall be obtained for each runway on which operations with reduced required landing distance are conducted.
- (b) To obtain the approval referred to in point (a), the operator shall conduct a risk assessment to demonstrate that a level of safety equivalent to that intended by point CAT.POL.A.330(a) is achieved and at least the following conditions are met:
- (1) the State of the aerodrome has determined a public interest and operational necessity for the operation, either due to the remoteness of the aerodrome or to physical limitations relating to the extension of the runway;
 - (2) short landing operations in accordance with point CAT.POL.A.350 and approaches outside stabilised approach criteria approved under point CAT.OP.MPA.115(a) are prohibited;
 - (3) landing on contaminated runways is prohibited;
 - (4) a specific control procedure of the touchdown area is defined in the operations manual (OM) and implemented; this procedure shall include adequate go-around and balked-landing instructions when touchdown in the defined area cannot be achieved;
 - (5) an adequate aerodrome training and checking programme for the flight crew is established;
 - (6) the flight crew is qualified and has recency in reduced required landing distance operations at the aerodrome concerned;
 - (7) an aerodrome landing analysis programme (ALAP) is established by the operator to ensure that the following conditions are met:
 - (i) no tailwind is forecast at the expected time of arrival;
 - (ii) if the runway is forecast to be wet at the expected time of arrival, the landing distance at dispatch shall either be determined in accordance with point CAT.OP.MPA.303(c), or shall be 115 % of the landing distance determined for dry runways, whichever is longer;
 - (iii) no forecast contaminated runway conditions exist at the expected time of arrival;
 - (iv) no forecast adverse weather conditions exist at the expected time of arrival;
 - (8) operational procedures are established to ensure that:
 - (i) all the equipment that affects landing performance and landing distance is operative before commencing the flight;
 - (ii) deceleration devices are correctly used by the flight crew;

- (9) specific maintenance instructions and operational procedures are established for the aeroplane's deceleration devices to enhance the reliability of those systems;
- (10) the final approach and landing are conducted under visual meteorological conditions (VMC) only;
- (11) additional aerodrome conditions, if specified by the competent authority that has certified the aerodrome, taking into account orographic characteristics of the approach area, available approach aids, missed-approach and balked-landing considerations.

GM1 CAT.POL.A.355(b) Approval of reduced required landing distance operations

ED Decision 2021/005/R

EQUIVALENT LEVEL OF SAFETY

A level of safety equivalent to that intended by CAT.POL.A.330(a) may be achieved when conducting reduced required landing distance operations if mitigating measures are established and implemented. Such measures should address flight crew, aircraft characteristics and performance, aerodromes and operations. It is, however, essential that all conditions established are adhered to as it is the combination of said conditions that achieves the intended level of safety. The operator should in fact also consider the interrelation of the various mitigating measures.

The competent authority may require other mitigating measures in addition to those proposed by the operator.

AMC1 CAT.POL.A.355(b)(4) Approval of reduced required landing distance operations

ED Decision 2021/005/R

CONTROL OF THE TOUCHDOWN AREA

The control of the touchdown area may be ensured by using external references visible from the flight crew compartment. The end of the designated touchdown area should be clearly identified with a ground reference point beyond which a go-around is required. Adequate go-around and balked landing instructions should be established in the OM. A written and/or pictorial description of the procedure should be provided for crew use.

AMC1 CAT.POL.A.355(b)(5) and (b)(6) Approval of reduced required landing distance operations

ED Decision 2021/005/R

TYPE EXPERIENCE

The operator should specify in the OM the minimum pilot's experience on the aircraft type or class used to conduct such operations.

TRAINING PROGRAMME

- (a) Initial training
 - (1) The aerodrome training programme shall include ground and flight training with a suitably qualified instructor.

- (2) Flight training should be carried out on the runway of the intended operations, and should include a suitable number of:
 - (i) approaches and landings; and
 - (ii) missed approach/balked landings.
- (3) When performing approaches and landings, particular emphasis should be placed on:
 - (i) stabilised approach criteria;
 - (ii) accuracy of flare and touchdown;
 - (iii) positive identification of the ground reference point controlling the touchdown area; and
 - (iv) correct use of deceleration devices.
- (4) These exercises should be conducted in accordance with the specific control procedure of the touchdown area established by the operator and should enable the flight crew to identify the external visual references and the designated touchdown area.

(b) Recurrent training

The operator should ensure that in conjunction with the recurrent training and checking programme required by Subpart FC of Annex III (Part-ORO) to Regulation (EU) No 965/2012, the pilot's knowledge and ability to perform the tasks associated with this particular operation, for which the pilot is authorised by the operator, are verified.

REGENCY

The operator should define in the OM appropriate recent-experience requirements to ensure that the pilot's ability to perform an approach to and landing on the intended runway is maintained.

GM1 CAT.POL.A.355(b)(7) Approval of reduced required landing distance operations

ED Decision 2021/005/R

AERODROME LANDING ANALYSIS PROGRAMME (ALAP)

The intent of an ALAP is to ensure that the aerodrome critical data related to landing performance in reduced required landing distance operations is known and taken into account in order to avoid any further increase of the landing distance. Two important aerodrome-related variables largely contribute to increasing the landing distance: landing (ground) speed and deceleration capability. Related factors to consider should include at least the following elements:

(a) Topography

Terrain around the aerodrome should be considered. High, fast-rising terrain may require special approach or decision points, missed approach or balked landing procedures and may affect landing performance. Aerodromes located on top of hilly terrain or downwind of mountainous terrain may occasionally experience conditions of wind shear and gusts. Such conditions are particularly relevant during the landing manoeuvre, particularly during the flare, and may increase landing distance.

(b) Runway conditions

Runway characteristics, such as unknown slope and surface composition, can cause the actual landing distance to be longer than the calculated landing distance. Braking action always

impacts the landing distance required as it deteriorates. To this regard, consideration should be given to, and information obtained on, the maintenance status of the runway, as a wet runway surface may be significantly degraded due to poor aerodrome maintenance.

(c) Aerodrome or area weather

Some aerodromes may not have current weather reports and forecast available for flight planning. Others may have automated observations for operational use. Others may depend on the weather forecast of a nearby aerodrome. Area forecasts are also valuable in evaluating weather conditions for a particular operation. Comparing forecasted conditions to current conditions provides insight on upcoming changes as weather systems move and forecasts are updated. Longer flight segments may lean more heavily on the forecast for the ETA, as current conditions may change significantly as weather systems move. The most important factors that should be considered are contained in AMC1 CAT.OP.MPA.300(a), AMC1 CAT.OP.MPA.311, GM1 CAT.OP.MPA.311, GM1 CAT.OP.MPA.303 and GM2 CAT.OP.MPA.303.

(d) Adverse weather

Adverse weather conditions include, but are not restricted to, thunderstorms, showers, downbursts, squall lines, tornadoes, moderate or severe turbulence on approach, heavy precipitation, wind shear and icing conditions. In general, all weather phenomena having the potential to increase the landing distance should be carefully assessed. Among these, tailwind is particularly relevant.

Wind variations should be carefully monitored as they may lead to variations in the reported and/or actual wind at the touchdown zone. Due consideration should be given also to the crosswind perpendicular to the landing runway as a slight variation in the direction of the crosswind may result in a considerable tailwind component.

(e) Runway safety margins

Displaced thresholds, aerodrome construction, and temporary obstacles (such as cranes and drawbridges) may impact the runway length available for landing. NOTAMs must be consulted during the flight preparation. Another safety margin is the size and adequacy of the runway strip and the RESA. A well-designed and well-maintained runway strip and RESA decrease the risk of damaging

GM1 CAT.POL.A.355(b)(7) Approval of reduced required landing distance operations

ED Decision 2021/005/R

AERODROME LANDING ANALYSIS PROGRAMME (ALAP) — AERODROME FACILITIES

The ALAP may also consider the services that are available at the aerodrome. Services such as communications, maintenance, and fuelling, availability of adequate RFFS and medical services may have an impact on operations to and from that aerodrome, though not directly related to the landing distance. It is also worth considering whether the aerodrome is only meeting ICAO and national standards or also ICAO recommendations, as well as when the aerodrome bearing ratios are below the design and maintenance criteria indicated in ICAO Doc 9157 'Aerodrome Design Manual'.

AMC1 CAT.POL.A.355(b)(8)(i) Approval of reduced required landing distance operations

ED Decision 2021/005/R

EQUIPMENT AFFECTING LANDING PERFORMANCE

Equipment affecting landing performance typically includes flaps, slats, spoilers, brakes, anti-skid, autobrakes, reversers, etc. The operator should establish procedures to identify, based on the aircraft characteristics, those systems and the equipment that are performance relevant, and to ensure that they are verified to be operative before commencing the flight. Appropriate entries should be included in the MEL to prohibit dispatch with such equipment inoperative when conducting reduced required landing distance operations.

GM1 CAT.POL.A.355(b)(8)(i) Approval of reduced required landing distance operations

ED Decision 2021/005/R

EQUIPMENT AFFECTING LANDING PERFORMANCE

Should any item of equipment affecting landing performance become inoperative during flight, the failure will be dealt with in accordance with the abnormal/emergency procedures established in the OM and, based on the prevailing conditions for the remainder of the flight, the commander will decide upon the discontinuation of the planned operation of reduced required landing distance.

GM1 CAT.POL.A.355(b)(8)(ii) Approval of reduced required landing distance operations

ED Decision 2021/005/R

CORRECT USE OF DECELERATION DEVICES

Flight crew should use full reverse when landing, irrespective of any noise-related restriction on its use, unless this affects the controllability of the aircraft. The use of all stopping devices, including reverse thrust, should commence immediately after touchdown without any delay.

AMC1 CAT.POL.A.355(b)(9) Approval of reduced required landing distance operations

ED Decision 2021/005/R

SPECIFIC MAINTENANCE INSTRUCTIONS

Additional maintenance instructions, such as, but not limited to, more frequent checks for the aircraft's deceleration devices, especially for the reverse system, should be established by the operator in accordance with the manufacturer's recommendations, and be included in the operator's maintenance programme in accordance with Annex I (Part-M) to Regulation (EU) No 1321/2014.

SPECIFIC OPERATIONAL PROCEDURES

The operator should establish procedures for the flight crew to check before take-off the correct deployment of the deceleration devices, such as the reverse system.

AMC1 CAT.POL.A.355(b)(11) Approval of reduced required landing distance operations

ED Decision 2021/005/R

ADDITIONAL AERODROME CONDITIONS

- (a) Operators should establish procedures to ensure that:
- (1) the aerodrome information is obtained from an authoritative source, or when this is not available, from a source that has been verified by the operator to meet quality standards that are adequate for the intended use; and
 - (2) any change reducing landing distances that has been declared by the aerodrome operator has been taken into account.
- (b) Additional aerodrome conditions related to aeroplane type characteristics, orographic characteristics in the approach area, available approach aids and missed approach/balked landing considerations, as well as operating limitations, should also be taken into account.
- (c) When assessing the aerodrome characteristics and the level of risk of the aeroplane undershooting or overrunning the runway, the operator should consider the nature and location of any hazard beyond the runway end, including the topography and obstruction environment beyond the runway strip, the length of the RESA and the effectiveness of any other mitigation measures that may be in place to reduce the likelihood and the consequences of a runway overrun.

CHAPTER 4 – PERFORMANCE CLASS C

CAT.POL.A.400 Take-off

Regulation (EU) No 965/2012

- (a) The take-off mass shall not exceed the maximum take-off mass specified in the AFM for the pressure altitude and the ambient temperature at the aerodrome of departure.
- (b) For aeroplanes that have take-off field length data contained in their AFM that do not include engine failure accountability, the distance from the start of the take-off roll required by the aeroplane to reach a height of 50 ft above the surface with all engines operating within the maximum take-off power conditions specified, when multiplied by a factor of either:
- (1) 1,33 for aeroplanes having two engines;
 - (2) 1,25 for aeroplanes having three engines; or
 - (3) 1,18 for aeroplanes having four engines,
- shall not exceed the take-off run available (TORA) at the aerodrome at which the take-off is to be made.
- (c) For aeroplanes that have take-off field length data contained in their AFM which accounts for engine failure, the following requirements shall be met in accordance with the specifications in the AFM:
- (1) the accelerate-stop distance shall not exceed the ASDA;
 - (2) the take-off distance shall not exceed the take-off distance available (TODA), with a clearway distance not exceeding half of the TORA;

- (3) the take-off run shall not exceed the TORA;
 - (4) a single value of V_1 for the rejected and continued take-off shall be used; and
 - (5) on a wet or contaminated runway the take-off mass shall not exceed that permitted for a take-off on a dry runway under the same conditions.
- (d) The following shall be taken into account:
- (1) the pressure altitude at the aerodrome;
 - (2) the ambient temperature at the aerodrome;
 - (3) the runway surface condition and the type of runway surface;
 - (4) the runway slope in the direction of take-off;
 - (5) not more than 50 % of the reported headwind component or not less than 150 % of the reported tailwind component; and
 - (6) the loss, if any, of runway length due to alignment of the aeroplane prior to take-off.

AMC1 CAT.POL.A.400 Take-off

ED Decision 2021/005/R

LOSS OF RUNWAY LENGTH DUE TO ALIGNMENT

- (a) The length of the runway that is declared for the calculation of TODA, ASDA and TORA does not account for line-up of the aeroplane in the direction of take-off on the runway in use. This alignment distance depends on the aeroplane geometry and access possibility to the runway in use. Accountability is usually required for a 90°-taxiway entry to the runway and 180°-turnaround on the runway. There are two distances to be considered:
- (1) the minimum distance of the main wheels from the start of the runway for determining TODA and TORA, 'L'; and
 - (2) the minimum distance of the most forward wheel(s) from the start of the runway for determining ASDA, 'N'.

Figure 1

Line-up of the aeroplane in the direction of take-off — L and N

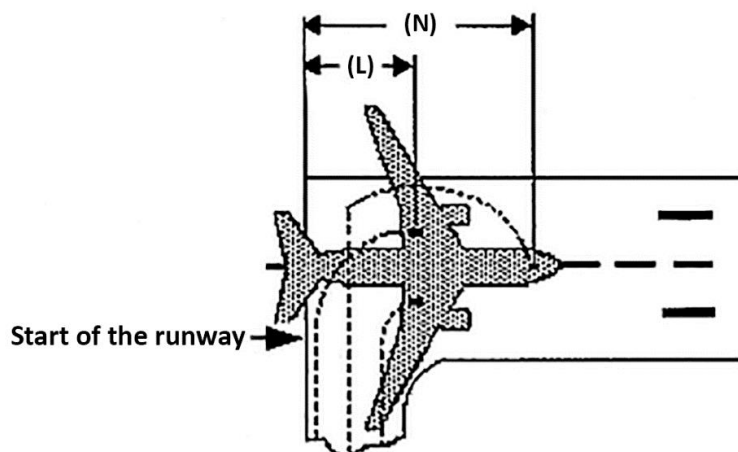

Where the aeroplane manufacturer does not provide the appropriate data, the calculation method given in (b) may be used to determine the alignment distance.

(b) Alignment distance calculation

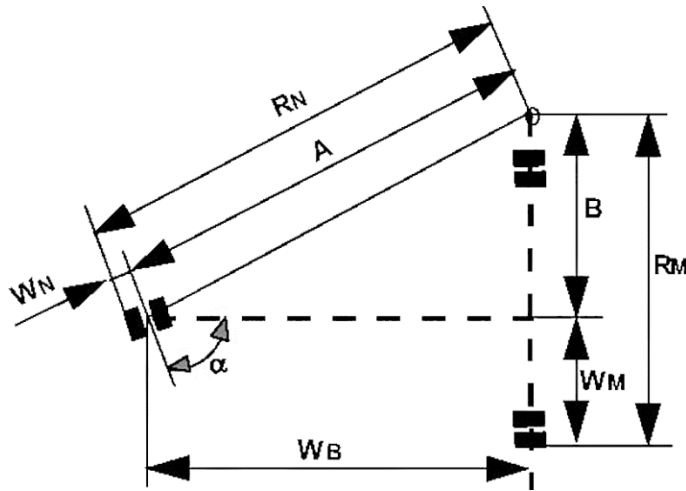

The distances mentioned in (a)(1) and (a)(2) above are:

	90°-entry	180°-turnaround
L =	RM + X	RN + Y
N =	RM + X + WB	RN + Y + WB

where:

$$RN = A + WN = \frac{WB}{\cos(90^\circ - \alpha)}$$

$$RN = A + WN = WB/\cos(90^\circ - \alpha) + WN$$

X = safety distance of outer main wheel during turn to the edge of the runway

Y = safety distance of outer nose wheel during turn to the edge of the runway

Note: Minimum edge safety distances for X and Y are specified in FAA AC 150/5300-13 and ICAO Annex 14, 3.8.3

RN = radius of turn of outer nose wheel

RM = radius of turn of outer main wheel

WN = distance from aeroplane centre-line to outer nose wheel

WM = distance from aeroplane centre-line to outer main wheel

WB = wheel base

α = steering angle.

AMC2 CAT.POL.A.400 Take-off

ED Decision 2014/015/R

RUNWAY SLOPE

Unless otherwise specified in the AFM, or other performance or operating manuals from the manufacturers, the take-off distance should be increased by 5 % for each 1 % of upslope. However, correction factors for runways with slopes in excess of 2 % should only be applied when:

- (a) the operator has demonstrated to the competent authority that the necessary data in the AFM or the operations manual contain the appropriated procedures; and
- (b) the crew is trained to take-off on runways with slopes in excess of 2 %.

AMC3 CAT.POL.A.400 Take-off

ED Decision 2021/005/R

RUNWAY SURFACE CONDITION

The determination of take-off performance data for wet and contaminated runways, when such data is available, should be based on the reported runway surface condition in terms of contaminant and depth.

GM1 CAT.POL.A.400 Take-off

ED Decision 2014/015/R

RUNWAY SURFACE CONDITION

Operation on runways contaminated with water, slush, snow or ice implies uncertainties with regard to runway friction and contaminant drag and, therefore, to the achievable performance and control of the aeroplane during take-off, since the actual conditions may not completely match the assumptions on which the performance information is based. An adequate overall level of safety can, therefore, only be maintained if such operations are limited to rare occasions. In case of a contaminated runway, the first option for the commander is to wait until the runway is cleared. If this is impracticable, he/she may consider a take-off, provided that he/she has applied the applicable performance adjustments, and any further safety measures he/she considers justified under the prevailing conditions.

CAT.POL.A.405 Take-off obstacle clearance

Regulation (EU) No 379/2014

- (a) The take-off flight path with OEI shall be determined such that the aeroplane clears all obstacles by a vertical distance of at least 50 ft plus $0,01 \times D$, or by a horizontal distance of at least 90 m plus $0,125 \times D$, where D is the horizontal distance the aeroplane has travelled from the end of the TODA. For aeroplanes with a wingspan of less than 60 m, a horizontal obstacle clearance of half the aeroplane wingspan plus 60 m plus $0,125 \times D$ may be used.
- (b) The take-off flight path shall begin at a height of 50 ft above the surface at the end of the take-off distance required by [CAT.POL.A.400\(b\) or \(c\)](#), as applicable, and end at a height of 1500 ft above the surface.
- (c) When showing compliance with (a), the following shall be taken into account:
 - (1) the mass of the aeroplane at the commencement of the take-off run;
 - (2) the pressure altitude at the aerodrome;

- (3) the ambient temperature at the aerodrome; and
 - (4) not more than 50 % of the reported headwind component or not less than 150 % of the reported tailwind component.
- (d) Track changes shall not be allowed up to that point of the take-off flight path where a height of 50 ft above the surface has been achieved. Thereafter, up to a height of 400 ft it is assumed that the aeroplane is banked by no more than 15°. Above 400 ft height bank angles greater than 15°, but not more than 25°, may be scheduled. Adequate allowance shall be made for the effect of bank angle on operating speeds and flight path, including the distance increments resulting from increased operating speeds.
- (e) For cases that do not require track changes of more than 15°, the operator does not need to consider those obstacles that have a lateral distance greater than:
- (1) 300 m, if the pilot is able to maintain the required navigational accuracy through the obstacle accountability area; or
 - (2) 600 m, for flights under all other conditions.
- (f) For cases that do require track changes of more than 15°, the operator does not need to consider those obstacles that have a lateral distance greater than:
- (1) 600 m, if the pilot is able to maintain the required navigational accuracy through the obstacle accountability area; or
 - (2) 900 m, for flights under all other conditions.
- (g) The operator shall establish contingency procedures to satisfy (a) to (f) and to provide a safe route, avoiding obstacles, to enable the aeroplane to either comply with the en-route requirements of [CAT.POL.A.410](#), or land at either the aerodrome of departure or at a take-off alternate aerodrome.

AMC1 CAT.POL.A.405 Take-off obstacle clearance

ED Decision 2014/015/R

EFFECT OF BANK ANGLES

- (a) The AFM generally provides a climb gradient decrement for a 15° bank turn. Unless otherwise specified in the AFM or other performance or operating manuals from the manufacturer, acceptable adjustments to assure adequate stall margins and gradient corrections are provided by the following:

Table 1

Effect of bank angles

Bank	Speed	Gradient correction
15°	V_2	1 x AFM 15° gradient loss
20°	$V_2 + 5$ kt	2 x AFM 15° gradient loss
25°	$V_2 + 10$ kt	3 x AFM 15° gradient loss

- (b) For bank angles of less than 15°, a proportionate amount may be applied, unless the manufacturer or AFM has provided other data.

AMC2 CAT.POL.A.405 Take-off obstacle clearance

ED Decision 2014/015/R

REQUIRED NAVIGATIONAL ACCURACY

(a) Navigation systems

The obstacle accountability semi-widths of 300 m and 600 m may be used if the navigation system under OEI conditions provides a two-standard deviation accuracy of 150 m and 300 m respectively.

(b) Visual course guidance

(1) The obstacle accountability semi-widths of 300 m and 600 m may be used where navigational accuracy is ensured at all relevant points on the flight path by use of external references. These references may be considered visible from the flight crew compartment if they are situated more than 45° either side of the intended track and with a depression of not greater than 20° from the horizontal.

(2) For visual course guidance navigation, the operator should ensure that the weather conditions prevailing at the time of operation, including ceiling and visibility, are such that the obstacle and/or ground reference points can be seen and identified. The operations manual should specify, for the aerodrome(s) concerned, the minimum weather conditions that enable the flight crew to continuously determine and maintain the correct flight path with respect to ground reference points, so as to provide a safe clearance with respect to obstructions and terrain as follows:

- (i) the procedure should be well defined with respect to ground reference points so that the track to be flown can be analysed for obstacle clearance requirements;
- (ii) the procedure should be within the capabilities of the aeroplane with respect to forward speed, bank angle and wind effects;
- (iii) a written and/or pictorial description of the procedure should be provided for crew use; and
- (iv) the limiting environmental conditions (such as wind, the lowest cloud base, ceiling, visibility, day/night, ambient lighting, obstruction lighting) should be specified.

CAT.POL.A.410 En-route – all engines operating

Regulation (EU) No 965/2012

(a) In the meteorological conditions expected for the flight, at any point on its route or on any planned diversion therefrom, the aeroplane shall be capable of a rate of climb of at least 300 ft per minute with all engines operating within the maximum continuous power conditions specified at:

- (1) the minimum altitudes for safe flight on each stage of the route to be flown, or of any planned diversion therefrom, specified in or calculated from the information contained in the operations manual relating to the aeroplane; and
- (2) the minimum altitudes necessary for compliance with the conditions prescribed in [CAT.POL.A.415](#) and 420, as appropriate.

CAT.POL.A.415 En-route – OEI

Regulation (EU) 2019/1387

- (a) In the meteorological conditions expected for the flight, in the event of any one engine becoming inoperative at any point on its route or on any planned diversion therefrom and with the other engine(s) operating within the maximum continuous power conditions specified, the aeroplane shall be capable of continuing the flight from the cruising altitude to an aerodrome where a landing can be made in accordance with [CAT.POL.A.430](#) or [CAT.POL.A.435](#), as appropriate. The aeroplane shall clear obstacles within 9,3 km (5 NM) either side of the intended track by a vertical interval of at least:
- (1) 1 000 ft, when the rate of climb is zero or greater; or
 - (2) 2 000 ft, when the rate of climb is less than zero.
- (b) The flight path shall have a positive slope at an altitude of 450 m (1 500 ft) above the aerodrome where the landing is assumed to be made after the failure of one engine.
- (c) The available rate of climb of the aeroplane shall be taken to be 150 ft per minute less than the gross rate of climb specified.
- (d) The width margins provided for in point (a) shall be increased to 18,5 km (10 NM) if the navigational accuracy does not meet at least navigation specification RNAV 5.
- (e) Fuel jettisoning is permitted to an extent consistent with reaching the aerodrome where the aeroplane is assumed to land after engine failure with the required fuel reserves in accordance with point [CAT.OP.MPA.150](#), appropriate for an alternate aerodrome, if a safe procedure is used.

AMC1 CAT.POL.A.415 En-route – OEI

ED Decision 2014/015/R

ROUTE ANALYSIS

The high terrain or obstacle analysis should be carried out by making a detailed analysis of the route using contour maps of the high terrain, and plotting the highest points within the prescribed corridor width along the route. The next step is to determine whether it is possible to maintain level flight with OEI 1 000 ft above the highest point of the crossing. If this is not possible, or if the associated weight penalties are unacceptable, a drift down procedure must be evaluated, based on engine failure at the most critical point, and must show obstacle clearance during the drift down by at least 2 000 ft. The minimum cruise altitude is determined from the drift down path, taking into account allowances for decision making, and the reduction in the scheduled rate of climb (See Figure 1).

Figure 1

Intersection of the drift down paths

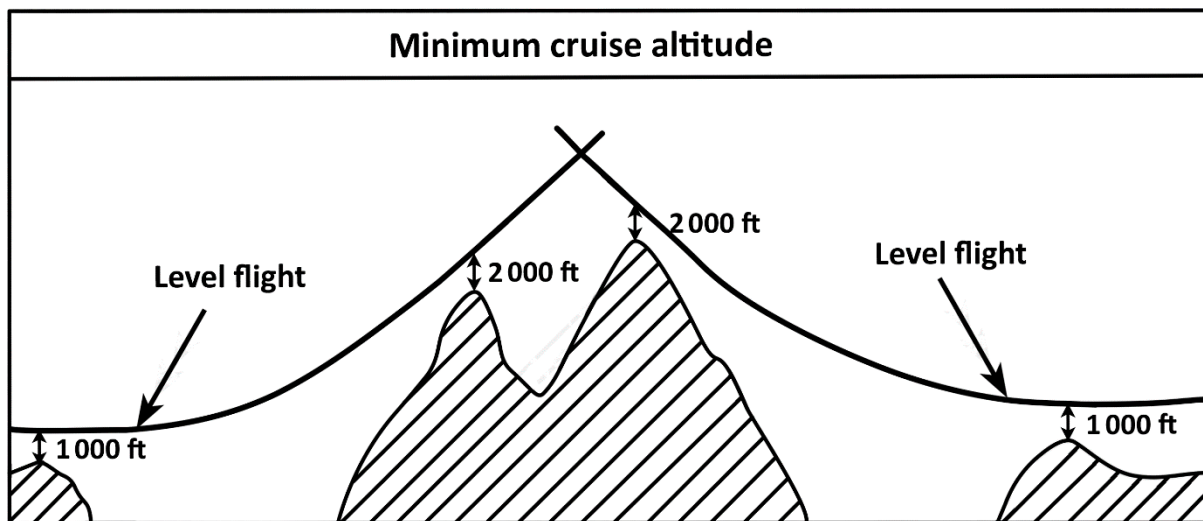

CAT.POL.A.420 En-route – aeroplanes with three or more engines, two engines inoperative

Regulation (EU) 2021/1296

- (a) An aeroplane that has three or more engines shall not be away from an aerodrome at which the requirements of point [CAT.POL.A.430](#) for the expected landing mass are met, at any point along the intended track for more than 90 minutes with all engines operating at cruising power or thrust, as appropriate, at standard temperature in still air, unless points (b) to (e) of this point are complied with.
- (b) The two-engines-inoperative flight path shall permit the aeroplane to continue the flight, in the expected meteorological conditions, clearing all obstacles within 9,3 km (5 NM) on either side of the intended track by a vertical interval of at least 2 000 ft, to an aerodrome at which the performance requirements applicable for the expected landing mass are met.
- (c) The two engines shall be assumed to fail at the most critical point of that portion of the route where the aeroplane is operated for more than 90 minutes, with all engines operating at cruising power or thrust, as appropriate, at standard temperature in still air, away from the aerodrome referred to in point (a).
- (d) The expected mass of the aeroplane at the point where the two engines are assumed to fail shall not be less than that which would include sufficient fuel/energy to proceed to an aerodrome where the landing is assumed to be made, and to arrive there at an altitude of at least 1 500 ft (450 m) directly over the landing area, and thereafter, to fly for 15 minutes at cruising power or thrust, as appropriate.
- (e) The available rate of climb of the aeroplane shall be 150 ft per minute less than that specified.
- (f) The width margins provided for in point (b) shall be increased to 18,5 km (10 NM) if the navigational accuracy does not meet at least navigation specification RNAV 5.
- (g) Fuel jettisoning is permitted to an extent consistent with reaching the aerodrome with the required fuel reserves in accordance with point (d), if a safe procedure is used.

CAT.POL.A.425 Landing – destination and alternate aerodromes

Regulation (EU) No 965/2012

The landing mass of the aeroplane determined in accordance with [CAT.POL.A.105\(a\)](#) shall not exceed the maximum landing mass specified in the AFM for the altitude and, if accounted for in the AFM, the ambient temperature expected for the estimated time of landing at the destination aerodrome and alternate aerodrome.

AMC1 CAT.POL.A.425 Landing – destination and alternate aerodromes

ED Decision 2014/015/R

ALTITUDE MEASURING

The operator should use either pressure altitude or geometric altitude for its operation and this should be reflected in the operations manual.

CAT.POL.A.430 Landing – dry runways

Regulation (EU) 2019/1387

- (a) The landing mass of the aeroplane determined in accordance with [CAT.POL.A.105\(a\)](#) for the estimated time of landing at the destination aerodrome and any alternate aerodrome shall allow a full stop landing from 50 ft above the threshold within 70 % of the LDA taking into account:
- (1) the altitude at the aerodrome;
 - (2) not more than 50 % of the headwind component or not less than 150 % of the tailwind component;
 - (3) the type of runway surface; and
 - (4) the runway slope in the direction of landing.
- (b) For dispatching the aeroplane it shall be assumed that:
- (1) the aeroplane will land on the most favourable runway in still air; and
 - (2) the aeroplane will land on the runway most likely to be assigned considering the probable wind speed and direction, the ground handling characteristics of the aeroplane and other conditions such as landing aids and terrain.
- (c) If the operator is unable to comply with (b)(2) for the destination aerodrome, the aeroplane shall only be dispatched if an alternate aerodrome is designated that permits full compliance with (a) and (b).

AMC1 CAT.POL.A.430 Landing – dry runways

ED Decision 2014/015/R

LANDING DISTANCE CORRECTION FACTORS

- (a) Unless otherwise specified in the AFM or other performance or operating manuals from the manufacturers, the variables affecting the landing performance and the associated factors to be applied to the AFM data are shown in the table below. It should be applied in addition to the factor specified in [CAT.POL.A.430](#).

Table 1

Landing distance correction factor

Surface type	factor
Grass (on firm soil up to 20 cm long)	1.2

- (b) The soil should be considered firm when there are wheel impressions, but no rutting.

AMC2 CAT.POL.A.430 Landing – dry runways

ED Decision 2014/015/R

RUNWAY SLOPE

Unless otherwise specified in the AFM, or other performance or operating manuals from the manufacturer, the landing distances required should be increased by 5 % for each 1 % of downslope.

GM1 CAT.POL.A.430 Landing – dry runways

ED Decision 2014/015/R

LANDING MASS

[CAT.POL.A.430](#) establishes two considerations in determining the maximum permissible landing mass at the destination and alternate aerodromes.

- (a) Firstly, the aeroplane mass will be such that on arrival the aeroplane can be landed within 70 % of the LDA on the most favourable (normally the longest) runway in still air. Regardless of the wind conditions, the maximum landing mass for an aerodrome/aeroplane configuration at a particular aerodrome cannot be exceeded.
- (b) Secondly, consideration should be given to anticipated conditions and circumstances. The expected wind, or ATC and noise abatement procedures may indicate the use of a different runway. These factors may result in a lower landing mass than that permitted under (a), in which case dispatch should be based on this lesser mass.
- (c) The expected wind referred to in (b) is the wind expected to exist at the time of arrival.

GM1 CAT.POL.A.430(a) Landing — dry runways

ED Decision 2021/005/R

ALTERNATE AERODROMES

The alternate aerodromes for which the landing mass is required to be determined in accordance with [CAT.POL.A.430](#) are:

- (a) destination alternate aerodromes;
- (b) fuel ERA aerodromes; and
- (c) re-dispatch or re-clearance aerodromes.

CAT.POL.A.435 Landing – wet and contaminated runways

Regulation (EU) 2019/1387

- (a) When the appropriate weather reports or forecasts indicate that the runway at the estimated time of arrival may be wet, the LDA shall be one of the following distances:

- (1) a landing distance provided in the AFM for use on wet runways at time of dispatch, but not less than that required by point [CAT.POL.A.430](#);
 - (2) if a landing distance is not provided in the AFM for use on wet runways at time of dispatch, at least 115 % of the required landing distance, determined in accordance with point [CAT.POL.A.430](#).
- (b) When the appropriate weather reports and/or forecasts indicate that the runway at the estimated time of arrival may be contaminated, the landing distance shall not exceed the LDA. The operator shall specify in the operations manual the landing distance data to be applied.

AMC1 CAT.POL.A.435 Landing — wet and contaminated runways

ED Decision 2021/005/R

WET AND CONTAMINATED RUNWAY DATA

The determination of landing performance data should be based on information provided in the OM on the reported RWYCC. The RWYCC is determined by the aerodrome operator using the RCAM and associated procedures defined in Annex V (Part-ADR.OPS) to Regulation (EU) No 139/2014. The RWYCC is reported through an RCR in the SNOWTAM format in accordance with ICAO Annex 15.

GM1 CAT.POL.A.435 Landing — wet and contaminated runways

ED Decision 2021/005/R

DISPATCH CONSIDERATIONS FOR MARGINAL CASES

The LD_{TA} required by [CAT.OP.MPA.303](#) may, in some cases, and in particular on wet or contaminated runways, exceeds the landing distance considered at the time of dispatch. The requirements for dispatch remain unchanged; however, when the conditions at the time of arrival are expected to be marginal, it is a good practice to carry out at the time of dispatch a preliminary calculation of the LD_{TA}.

GM1 CAT.POL.A.435(a)(1) Landing — wet and contaminated runways

ED Decision 2021/005/R

AFM LANDING DISTANCES FOR WET RUNWAYS

Specific landing distances provided in the AFM for dispatch on wet runways, unless otherwise indicated, include a safety factor, which renders the application of the 15% safety factor used in [CAT.POL.A.435\(a\)\(2\)](#) not necessary. This implies that the AFM distance may be presented as factored distance. When the AFM distance is not factored, a safety factor of 15 % should be applied. These distances may be longer or shorter than those resulting from [CAT.POL.A.435\(a\)\(2\)](#), but when provided they are intended as a replacement of [CAT.POL.A.435\(a\)\(2\)](#) and it is mandatory to be used at the time of dispatch.

GM1 CAT.POL.A.430 & CAT.POL.A.435 Landing — dry runways & Landing — wet and contaminated runways

ED Decision 2021/005/R

LANDING DISTANCES AND CORRECTIVE FACTORS

The AFM provides performance data for landing distance under conditions defined in the applicable certification standards. This distance, commonly referred to as the ALD, is the distance from the

position on the runway of the screen height to the point where the aeroplane comes to a full stop on a dry runway.

The determination of the ALD is based on the assumption that the landing is performed in accordance with the conditions and the procedures set out in the AFM on the basis of the applicable certification standards.

As a matter of fact, any particular landing may be different from the landing technique that is assumed in the AFM for certification purposes. The aircraft may approach the runway faster and/or higher than assumed; the aircraft may touch down further along the runway than the optimum point; the actual winds and other weather factors may be different from those assumed in the calculation of the ALD; and maximum braking may not be always achievable. For this reason, the LDA is required by [CAT.POL.A.430](#) and [CAT.POL.A.435](#) to be longer than the ALD.

The margins by which the LDA shall exceed the ALD on dry runways, in accordance with CAT.POL.A.430, are shown in the following Table 1.

Table 1: — Corrective factors for dry runways

Aeroplane category	Required Margin (dry runway)	Resulting factor (dry runway)
All aeroplanes	ALD < 70 % of the LDA	LDA = at least 1.43 x ALD

If the runway is wet and the AFM does not provide specific performance data for dispatch on wet runways, a further increase of 15 % of the landing distance on dry runways has to be applied, in accordance with CAT.POL.A.435, as shown in the following Table 2.

Table 2: Corrective factors for wet runways

Aeroplane category	Resulting factor (dry runway)
All aeroplanes	LDA = at least 1.15 x 1.43 x ALD = 1.64 x ALD

SECTION 2 – HELICOPTERS

CHAPTER 1 – GENERAL REQUIREMENTS

CAT.POL.H.100 Applicability

Regulation (EU) No 965/2012

- (a) Helicopters shall be operated in accordance with the applicable performance class requirements.
- (b) Helicopters shall be operated in performance class 1:
 - (1) when operated to/from aerodromes or operating sites located in a congested hostile environment, except when operated to/from a public interest site (PIS) in accordance with [CAT.POL.H.225](#); or

- (2) when having an MOPSC of more than 19, except when operated to/from a helideck in performance class 2 under an approval in accordance with [CAT.POL.H.305](#).
- (c) Unless otherwise prescribed by (b), helicopters that have an MOPSC of 19 or less but more than nine shall be operated in performance class 1 or 2.
- (d) Unless otherwise prescribed by (b), helicopters that have an MOPSC of nine or less shall be operated in performance class 1, 2 or 3.

CAT.POL.H.105 General

Regulation (EU) No 965/2012

- (a) The mass of the helicopter:
 - (1) at the start of the take-off; or
 - (2) in the event of in-flight replanning, at the point from which the revised operational flight plan applies,

shall not be greater than the mass at which the applicable requirements of this Section can be complied with for the flight to be undertaken, taking into account expected reductions in mass as the flight proceeds and such fuel jettisoning as is provided for in the relevant requirement.
- (b) The approved performance data contained in the AFM shall be used to determine compliance with the requirements of this Section, supplemented as necessary with other data as prescribed in the relevant requirement. The operator shall specify such other data in the operations manual. When applying the factors prescribed in this Section, account may be taken of any operational factors already incorporated in the AFM performance data to avoid double application of factors.
- (c) When showing compliance with the requirements of this Section, account shall be taken of the following parameters:
 - (1) mass of the helicopter;
 - (2) the helicopter configuration;
 - (3) the environmental conditions, in particular:
 - (i) pressure altitude and temperature;
 - (ii) wind:
 - (A) except as provided in (C), for take-off, take-off flight path and landing requirements, accountability for wind shall be no more than 50 % of any reported steady headwind component of 5 kt or more;
 - (B) where take-off and landing with a tailwind component is permitted in the AFM, and in all cases for the take-off flight path, not less than 150 % of any reported tailwind component shall be taken into account; and
 - (C) where precise wind measuring equipment enables accurate measurement of wind velocity over the point of take-off and landing, wind components in excess of 50 % may be established by the operator, provided that the operator demonstrates to the competent authority that the proximity to the FATO and accuracy enhancements of the wind measuring equipment provide an equivalent level of safety;
 - (4) the operating techniques; and

- (5) the operation of any systems that have an adverse effect on performance.

GM1 CAT.POL.H.105(c)(3)(ii)(A) General

ED Decision 2014/015/R

REPORTED HEADWIND COMPONENT

The reported headwind component should be interpreted as being that reported at the time of flight planning and may be used, provided there is no significant change of unfactored wind prior to take-off.

CAT.POL.H.110 Obstacle accountability

Regulation (EU) No 965/2012

- (a) For the purpose of obstacle clearance requirements, an obstacle located beyond the FATO, in the take-off flight path, or the missed approach flight path shall be considered if its lateral distance from the nearest point on the surface below the intended flight path is not further than the following:
- (1) For operations under VFR:
 - (i) half of the minimum width defined in the AFM — or, when no width is defined, '0,75 × D', where D is the largest dimension of the helicopter when the rotors are turning;
 - (ii) plus, the greater of '0,25 × D' or '3 m';
 - (iii) plus:
 - (A) 0,10 × distance DR for operations under VFR by day; or
 - (B) 0,15 × distance DR for operations under VFR at night.
 - (2) For operations under IFR:
 - (i) '1,5 D' or 30 m, whichever is greater, plus:
 - (A) 0,10 × distance DR, for operations under IFR with accurate course guidance;
 - (B) 0,15 × distance DR, for operations under IFR with standard course guidance; or
 - (C) 0,30 × distance DR for operations under IFR without course guidance.
 - (ii) When considering the missed approach flight path, the divergence of the obstacle accountability area only applies after the end of the take-off distance available.
 - (3) For operations with initial take-off conducted visually and converted to IFR/IMC at a transition point, the criteria required in (1) apply up to the transition point, and the criteria required in (2) apply after the transition point. The transition point cannot be located before the end of the take-off distance required for helicopters (TODRH) operating in performance class 1 or before the defined point after take-off (DPATO) for helicopters operating in performance class 2.
- (b) For take-off using a back-up or a lateral transition procedure, for the purpose of obstacle clearance requirements, an obstacle located in the back-up or lateral transition area shall be considered if its lateral distance from the nearest point on the surface below the intended flight path is not further than:

- (1) half of the minimum width defined in the AFM or, when no width is defined, '0,75 × D';
 - (2) plus the greater of '0,25 × D' or '3 m';
 - (3) plus:
 - (i) for operations under VFR by day 0,10 × the distance travelled from the back of the FATO, or
 - (ii) for operations under VFR at night 0,15 × the distance travelled from the back of the FATO.
- (c) Obstacles may be disregarded if they are situated beyond:
- (1) 7 × rotor radius (R) for day operations, if it is assured that navigational accuracy can be achieved by reference to suitable visual cues during the climb;
 - (2) 10 × R for night operations, if it is assured that navigational accuracy can be achieved by reference to suitable visual cues during the climb;
 - (3) 300 m if navigational accuracy can be achieved by appropriate navigation aids; or
 - (4) 900 m in all other cases.

GM1 CAT.POL.H.110(a)(2)(i) Obstacle accountability

ED Decision 2014/015/R

COURSE GUIDANCE

Standard course guidance includes automatic direction finder (ADF) and VHF omnidirectional radio range (VOR) guidance.

Accurate course guidance includes ILS, MLS or other course guidance providing an equivalent navigational accuracy.

CHAPTER 2 – PERFORMANCE CLASS 1

CAT.POL.H.200 General

Regulation (EU) No 965/2012

Helicopters operated in performance class 1 shall be certified in category A or equivalent as determined by the Agency.

GM1 CAT.POL.H.200 & CAT.POL.H.300 & CAT.POL.H.400 General

ED Decision 2014/015/R

CATEGORY A AND CATEGORY B

- (a) Helicopters that have been certified according to any of the following standards are considered to satisfy the Category A criteria. Provided that they have the necessary performance information scheduled in the AFM, such helicopters are, therefore, eligible for performance class 1 or 2 operations:
- (1) certification as Category A under CS-27 or CS-29;
 - (2) certification as Category A under JAR-27 or JAR-29;
 - (3) certification as Category A under FAR Part 29;

- (4) certification as group A under BCAR Section G; and
 - (5) certification as group A under BCAR-29.
- (b) In addition to the above, certain helicopters have been certified under FAR Part 27 and with compliance with FAR Part 29 engine isolation requirements as specified in FAA Advisory Circular AC 27-1. Provided that compliance is established with the following additional requirements of CS-29:
- (1) CS 29.1027(a) Independence of engine and rotor drive system lubrication;
 - (2) CS 29.1187(e);
 - (3) CS 29.1195(a) & (b) Provision of a one-shot fire extinguishing system for each engine;
 - (i) The requirement to fit a fire extinguishing system may be waived if the helicopter manufacturer can demonstrate equivalent safety, based on service experience for the entire fleet showing that the actual incidence of fires in the engine fire zones has been negligible.
 - (4) CS 29.1197;
 - (5) CS 29.1199;
 - (6) CS 29.1201; and
 - (7) CS 29.1323(c)(1) Ability of the airspeed indicator to consistently identify the take-off decision point,
- these helicopters are considered to satisfy the requirement to be certified as equivalent to Category A.
- (c) The performance operating rules of JAR-OPS 3, which were transposed into this Part, were drafted in conjunction with the performance requirements of JAR-29 Issue 1 and FAR Part 29 at amendment 29-39. For helicopters certificated under FAR Part 29 at an earlier amendment, or under BCAR section G or BCAR-29, performance data will have been scheduled in the AFM according to these earlier requirements. This earlier scheduled data may not be fully compatible with this Part.
- (d) Before any AOC is issued under which performance class 1 or 2 operations are conducted, it should be established that scheduled performance data are available that are compatible with the requirements of performance class 1 and 2 respectively.
- (e) Any properly certified helicopter is considered to satisfy the Category B criteria. If appropriately equipped (in accordance with CAT.IDE.H), such helicopters are, therefore, eligible for performance class 3 operations.

CAT.POL.H.205 Take-off

Regulation (EU) No 965/2012

- (a) The take-off mass shall not exceed the maximum take-off mass specified in the AFM for the procedure to be used.
- (b) The take-off mass shall be such that:
 - (1) it is possible to reject the take-off and land on the FATO in case of the critical engine failure being recognised at or before the take-off decision point (TDP);

- (2) the rejected take-off distance required (RTODRH) does not exceed the rejected take-off distance available (RTODAH); and
 - (3) the TODRH does not exceed the take-off distance available (TODAH).
 - (4) Notwithstanding (b)(3), the TODRH may exceed the TODAH if the helicopter, with the critical engine failure recognised at TDP can, when continuing the take-off, clear all obstacles to the end of the TODRH by a vertical margin of not less than 10,7 m (35 ft).
- (c) When showing compliance with (a) and (b), account shall be taken of the appropriate parameters of [CAT.POL.H.105\(c\)](#) at the aerodrome or operating site of departure.
 - (d) That part of the take-off up to and including TDP shall be conducted in sight of the surface such that a rejected take-off can be carried out.
 - (e) For take-off using a backup or lateral transition procedure, with the critical engine failure recognition at or before the TDP, all obstacles in the back-up or lateral transition area shall be cleared by an adequate margin.

AMC1 CAT.POL.H.205(b)(4) Take-off

ED Decision 2014/015/R

THE APPLICATION OF TODRH

The selected height should be determined with the use of AFM data, and be at least 10.7 m (35 ft) above:

- (a) the take-off surface; or
- (b) as an alternative, a level height defined by the highest obstacle in the take-off distance required.

GM1 CAT.POL.H.205(b)(4) Take-off

ED Decision 2014/015/R

THE APPLICATION OF TODRH

- (a) Introduction

Original definitions for helicopter performance were derived from aeroplanes; hence, the definition of take-off distance owes much to operations from runways. Helicopters on the other hand can operate from runways, confined and restricted areas and rooftop FATOs — all bounded by obstacles. As an analogy, this is equivalent to a take-off from a runway with obstacles on and surrounding it.

It can, therefore, be said that unless the original definitions from aeroplanes are tailored for helicopters, the flexibility of the helicopter might be constrained by the language of operational performance.

This GM concentrates on the critical term ‘take-off distance required (TODRH)’ and describes the methods to achieve compliance with it and, in particular, the alternative procedure described in ICAO Annex 6 Attachment A 4.1.1.3:

- (1) the take-off distance required does not exceed the take-off distance available; or
- (2) as an alternative, the take-off distance required may be disregarded provided that the helicopter with the critical engine failure recognised at TDP can, when continuing the take-off, clear all obstacles between the end of the take-off distance available and the point at which it becomes established in a climb at V_{Toss} by a vertical margin of 10.7 m

(35 ft) or more. An obstacle is considered to be in the path of the helicopter if its distance from the nearest point on the surface below the intended line of flight does not exceed 30 m or 1.5 times the maximum dimension of the helicopter, whichever is greater.

(b) Definition of TODRH

The definition of TODRH from [Annex I](#) is as follows:

‘Take-off distance required (TODRH)’ in the case of helicopters means the horizontal distance required from the start of the take-off to the point at which take-off safety speed (V_{Toss}), a selected height and a positive climb gradient are achieved, following failure of the critical engine being recognised at the TDP, the remaining engines operating within approved operating limits.

[AMC1 CAT.POL.H.205\(b\)\(4\)](#) states how the specified height should be determined.

The original definition of TODRH was based only on the first part of this definition.

(c) The clear area procedure (runway)

In the past, helicopters certified in Category A would have had, at the least, a ‘clear area’ procedure. This procedure is analogous to an aeroplane Category A procedure and assumes a runway (either metalled or grass) with a smooth surface suitable for an aeroplane take-off (see Figure 1).

The helicopter is assumed to accelerate down the FATO (runway) outside of the height velocity (HV) diagram. If the helicopter has an engine failure before TDP, it must be able to land back on the FATO (runway) without damage to helicopter or passengers; if there is a failure at or after TDP the aircraft is permitted to lose height — providing it does not descend below a specified height above the surface (usually 15 ft if the TDP is above 15 ft). Errors by the pilot are taken into consideration, but the smooth surface of the FATO limits serious damage if the error margin is eroded (e.g. by a change of wind conditions).

Figure 1

Clear Area take – off

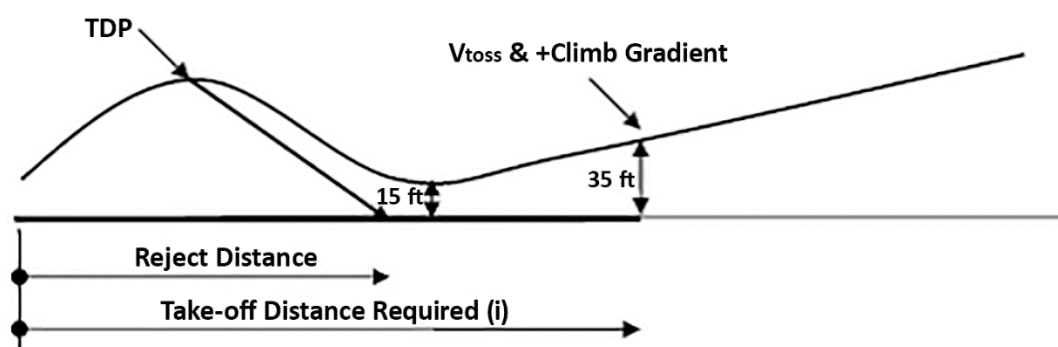

The operator only has to establish that the distances required are within the distance available (take-off distance and reject distance). The original definition of TODRH meets this case exactly.

From the end of the TODRH obstacle clearance is given by the climb gradient of the first or second climb segment meeting the requirement of [CAT.POL.H.210](#) (or for performance class 2 (PC2): [CAT.POL.H.315](#)). The clearance margin from obstacles in the take-off flight path takes account of the distance travelled from the end of the take-off distance required and operational conditions (IMC or VMC).

(d) Category A procedures other-than-clear area

Procedures other-than-the-clear area are treated somewhat differently. However, the short field procedure is somewhat of a hybrid as either (a) or (b) of [AMC1 CAT.POL.H.205\(b\)\(4\)](#) can be utilised (the term ‘helipad’ is used in the following section to illustrate the principle only, it is not intended as a replacement for ‘aerodrome’ or ‘FATO’).

(1) Limited area, restricted area and helipad procedures (other than elevated)

The exact names of the procedure used for other-than-clear area are as many as there are manufacturers. However, principles for obstacle clearance are generic and the name is unimportant.

These procedures (see Figure 2 and Figure 3) are usually associated with an obstacle in the continued take-off area — usually shown as a line of trees or some other natural obstacle. As clearance above such obstacles is not readily associated with an accelerative procedure, as described in (c), a procedure using a vertical climb (or a steep climb in the forward, sideways or rearward direction) is utilised.

Figure 2

Short Field take-off

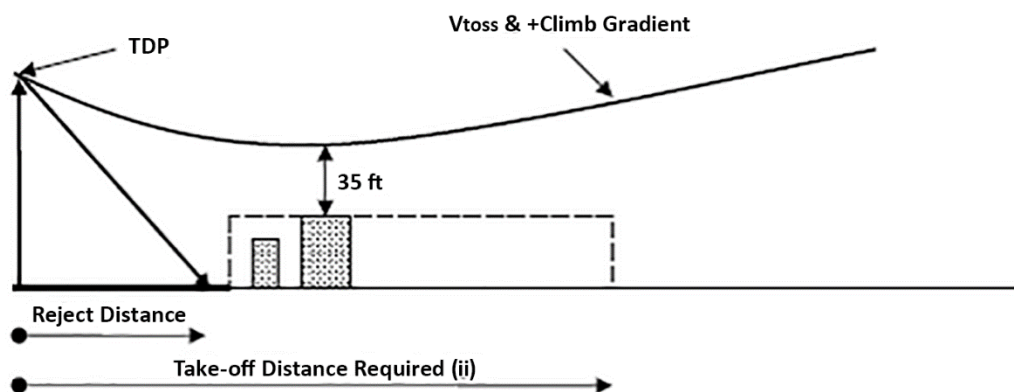

With the added complication of a TDP principally defined by height together with obstacles in the continued take off area, a drop down to within 15 ft of the take-off surface is not deemed appropriate and the required obstacle clearance is set to 35 ft (usually called ‘min-dip’). The distance to the obstacle does not need to be calculated (provided it is outside the rejected distance required), as clearance above all obstacles is provided by ensuring that helicopter does not descend below the min-dip associated with a level defined by the highest obstacle in the continued take-off area.

Figure 3

Helipad take-off

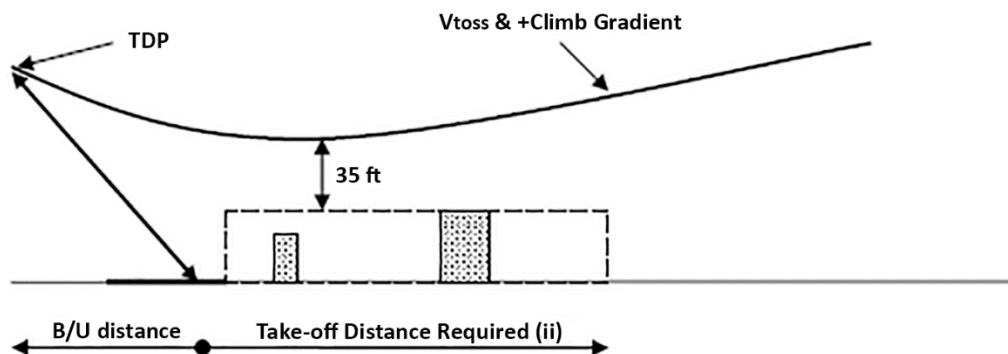

These procedures depend upon (b) of [AMC1 CAT.POL.H.205\(b\)\(4\)](#).

As shown in Figure 3, the point at which V_{TOSS} and a positive rate of climb are met defines the TODRH. Obstacle clearance from that point is assured by meeting the requirement of [CAT.POL.H.210](#) (or for PC2, [CAT.POL.H.315](#)). Also shown in Figure 3 is the distance behind the helipad which is the backup distance (B/U distance).

(2) Elevated helipad procedures

The elevated helipad procedure (see Figure 4) is a special case of the ground level helipad procedure discussed above.

Figure 4

Elevate Helipad take-off

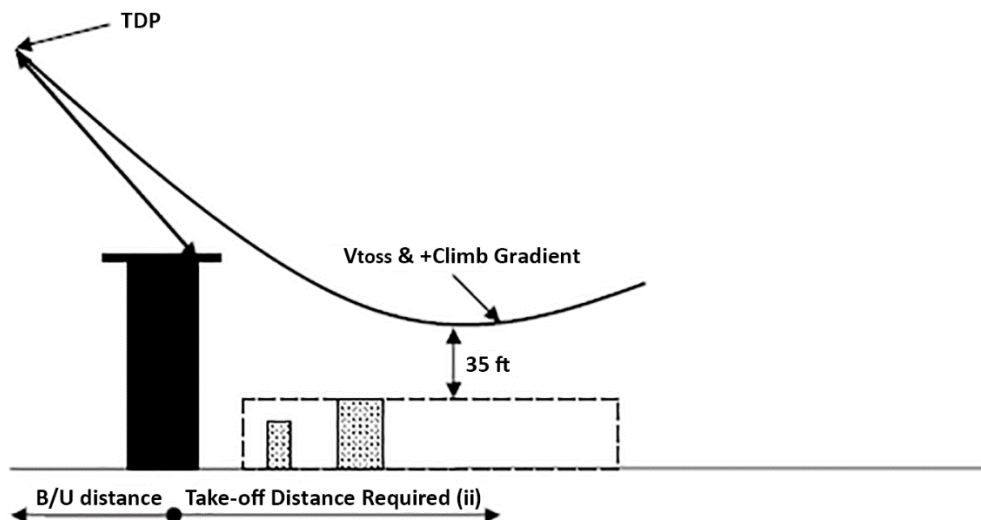

The main difference is that drop down below the level of the take-off surface is permitted. In the drop down phase, the Category A procedure ensures deck-edge clearance but, once clear of the deck-edge, the 35 ft clearance from obstacles relies upon the calculation of drop down. Subparagraph (b) of [AMC1 CAT.POL.H.205\(b\)\(4\)](#) is applied.

Although 35 ft is used throughout the requirements, it may be inadequate at particular elevated FATOs that are subject to adverse airflow effects, turbulence, etc.

AMC1 CAT.POL.H.205(e) Take-off

ED Decision 2014/015/R

OBSTACLE CLEARANCE IN THE BACKUP AREA

- (a) The requirement in [CAT.POL.H.205\(e\)](#) has been established in order to take into account the following factors:
 - (1) in the backup: the pilot has few visual cues and has to rely upon the altimeter and sight picture through the front window (if flight path guidance is not provided) to achieve an accurate rearward flight path;
 - (2) in the rejected take-off: the pilot has to be able to manage the descent against a varying forward speed whilst still ensuring an adequate clearance from obstacles until the helicopter gets in close proximity for landing on the FATO; and
 - (3) in the continued take-off; the pilot has to be able to accelerate to V_{TOSS} (take-off safety speed for Category A helicopters) whilst ensuring an adequate clearance from obstacles.
- (b) The requirements of [CAT.POL.H.205\(e\)](#) may be achieved by establishing that:
 - (1) in the backup area no obstacles are located within the safety zone below the rearward flight path when described in the AFM (see Figure 1, in the absence of such data in the AFM, the operator should contact the manufacturer in order to define a safety zone); or
 - (2) during the backup, the rejected take-off and the continued take-off manoeuvres, obstacle clearance is demonstrated to the competent authority.

Figure 1

Rearward flight path

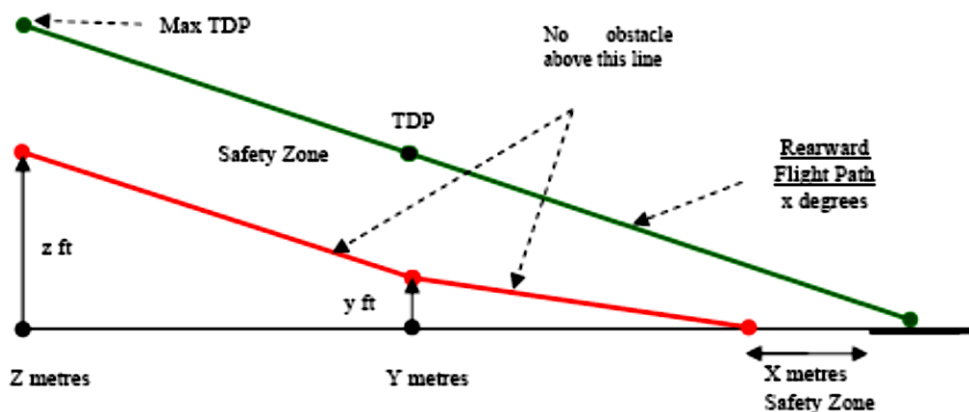

- (c) An obstacle, in the backup area, is considered if its lateral distance from the nearest point on the surface below the intended flight path is not further than:
 - (1) half of the minimum FATO (or the equivalent term used in the AFM) width defined in the AFM (or, when no width is defined 0.75 D, where D is the largest dimension of the helicopter when the rotors are turning); plus
 - (2) 0.25 times D (or 3 m, whichever is greater); plus
 - (3) 0.10 for VFR day, or 0.15 for VFR night, of the distance travelled from the back of the FATO (see Figure 2).

Figure 2

Obstacle accountability

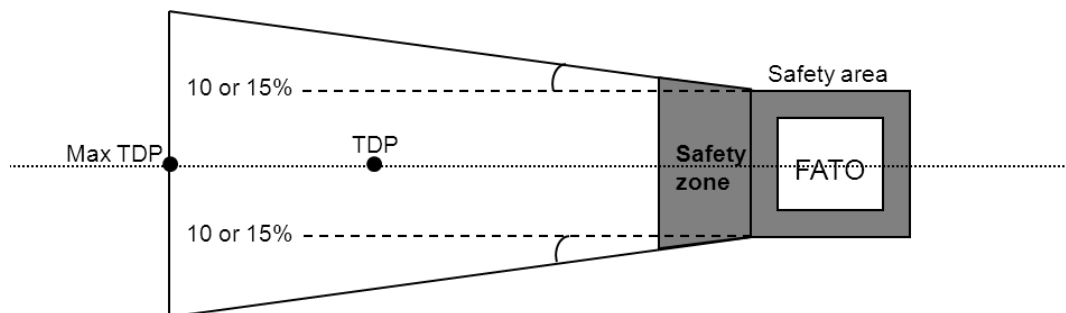

AMC1 CAT.POL.H.205 & CAT.POL.H.220 Take-off and landing

ED Decision 2014/015/R

APPLICATION FOR ALTERNATIVE TAKE-OFF AND LANDING PROCEDURES

- (a) A reduction in the size of the take-off surface may be applied when the operator has demonstrated to the competent authority that compliance with the requirements of [CAT.POL.H.205](#), 210 and 220 can be assured with:
- (1) a procedure based upon an appropriate Category A take-off and landing profile scheduled in the AFM;
 - (2) a take-off or landing mass not exceeding the mass scheduled in the AFM for a hover-out-of-ground-effect one-engine-inoperative (HOGE OEI) ensuring that:
 - (i) following an engine failure at or before TDP, there are adequate external references to ensure that the helicopter can be landed in a controlled manner; and
 - (ii) following an engine failure at or after the landing decision point (LDP), there are adequate external references to ensure that the helicopter can be landed in a controlled manner.
- (b) An upwards shift of the TDP and LDP may be applied when the operator has demonstrated to the competent authority that compliance with the requirements of [CAT.POL.H.205](#), 210 and 220 can be assured with:
- (1) a procedure based upon an appropriate Category A take-off and landing profile scheduled in the AFM;
 - (2) a take-off or landing mass not exceeding the mass scheduled in the AFM for a HOGE OEI ensuring that:
 - (i) following an engine failure at or after TDP compliance with the obstacle clearance requirements of [CAT.POL.H.205](#) (b)(4) and [CAT.POL.H.210](#) can be met; and
 - (ii) following an engine failure at or before the LDP the balked landing obstacle clearance requirements of [CAT.POL.H.220](#) (b) and [CAT.POL.H.210](#) can be met.
- (c) The Category A ground level surface area requirement may be applied at a specific elevated FATO when the operator can demonstrate to the competent authority that the usable cue environment at that aerodrome/operating site would permit such a reduction in size.

GM1 CAT.POL.H.205&CAT.POL.H.220 Take-off and landing

ED Decision 2014/015/R

APPLICATION FOR ALTERNATIVE TAKE-OFF AND LANDING PROCEDURES

The manufacturer's Category A procedure defines profiles and scheduled data for take-off, climb, performance at minimum operating speed and landing, under specific environmental conditions and masses.

Associated with these profiles and conditions are minimum operating surfaces, take-off distances, climb performance and landing distances; these are provided (usually in graphic form) with the take-off and landing masses and the take-off decision point (TDP) and landing decision point (LDP).

The landing surface and the height of the TDP are directly related to the ability of the helicopter — following an engine failure before or at TDP — to reject onto the surface under forced landing conditions. The main considerations in establishing the minimum size of the landing surface are the scatter during flight testing of the reject manoeuvre, with the remaining engine operating within approved limits, and the required usable cue environment.

Hence, an elevated site with few visual cues — apart from the surface itself — would require a greater surface area in order that the helicopter can be accurately positioned during the reject manoeuvre within the specified area. This usually results in the stipulation of a larger surface for an elevated site than for a ground level site (where lateral cues may be present).

This could have the unfortunate side effect that a FATO that is built 3 m above the surface (and, therefore, elevated by definition) might be out of operational scope for some helicopters — even though there might be a rich visual cue environment where rejects are not problematical. The presence of elevated sites where ground level surface requirements might be more appropriate could be brought to the attention of the competent authority.

It can be seen that the size of the surface is directly related to the requirement of the helicopter to complete a rejected take-off following an engine failure. If the helicopter has sufficient power such that a failure before or at TDP will not lead to a requirement for rejected take-off, the need for large surfaces is removed; sufficient power for the purpose of this GM is considered to be the power required for hover-out-of-ground-effect one-engine-inoperative (HOGE OEI).

Following an engine failure at or after the TDP, the continued take-off path provides OEI clearance from the take-off surface and the distance to reach a point from where climb performance in the first, and subsequent segments, is assured.

If HOGE OEI performance exists at the height of the TDP, it follows that the continued take-off profile, which has been defined for a helicopter with a mass such that a rejected take-off would be required following an engine failure at or before TDP, would provide the same, or better, obstacle clearance and the same, or less, distance to reach a point where climb performance in the first, and subsequent segments, is assured.

If the TDP is shifted upwards, provided that the HOGE OEI performance is established at the revised TDP, it will not affect the shape of the continued take-off profile but should shift the min-dip upwards by the same amount that the revised TDP has been increased — with respect to the basic TDP.

Such assertions are concerned only with the vertical or the backup procedures and can be regarded as achievable under the following circumstances:

- (a) when the procedure is flown, it is based upon a profile contained in the AFM — with the exception of the necessity to perform a rejected take-off;

- (b) the TDP, if shifted upwards (or upwards and backward in the backup procedure) will be the height at which the HOGE OEI performance is established; and
- (c) if obstacles are permitted in the backup area, they should continue to be permitted with a revised TDP.

CAT.POL.H.210 Take-off flight path

Regulation (EU) No 965/2012

- (a) From the end of the TODRH with the critical engine failure recognised at the TDP:
 - (1) The take-off mass shall be such that the take-off flight path provides a vertical clearance, above all obstacles located in the climb path, of not less than 10,7 m (35 ft) for operations under VFR and $10,7 \text{ m (35 ft)} + 0,01 \times \text{distance DR}$ for operations under IFR. Only obstacles as specified in [CAT.POL.H.110](#) have to be considered.
 - (2) Where a change of direction of more than 15° is made, adequate allowance shall be made for the effect of bank angle on the ability to comply with the obstacle clearance requirements. This turn is not to be initiated before reaching a height of 61 m (200 ft) above the take-off surface unless it is part of an approved procedure in the AFM.
- (b) When showing compliance with (a), account shall be taken of the appropriate parameters of [CAT.POL.H.105\(c\)](#) at the aerodrome or operating site of departure.

CAT.POL.H.215 En-route – critical engine inoperative

Regulation (EU) No 965/2012

- (a) The mass of the helicopter and flight path at all points along the route, with the critical engine inoperative and the meteorological conditions expected for the flight, shall permit compliance with (1), (2) or (3):
 - (1) When it is intended that the flight will be conducted at any time out of sight of the surface, the mass of the helicopter permits a rate of climb of at least 50 ft/minute with the critical engine inoperative at an altitude of at least 300 m (1 000 ft), or 600 m (2 000 ft) in areas of mountainous terrain, above all terrain and obstacles along the route within 9,3 km (5 NM) on either side of the intended track.
 - (2) When it is intended that the flight will be conducted without the surface in sight, the flight path permits the helicopter to continue flight from the cruising altitude to a height of 300 m (1 000 ft) above a landing site where a landing can be made in accordance with [CAT.POL.H.220](#). The flight path clears vertically, by at least 300 m (1 000 ft) or 600 m (2 000 ft) in areas of mountainous terrain, all terrain and obstacles along the route within 9,3 km (5 NM) on either side of the intended track. Drift-down techniques may be used.
 - (3) When it is intended that the flight will be conducted in VMC with the surface in sight, the flight path permits the helicopter to continue flight from the cruising altitude to a height of 300 m (1 000 ft) above a landing site where a landing can be made in accordance with [CAT.POL.H.220](#), without flying at any time below the appropriate minimum flight altitude. Obstacles within 900 m on either side of the route need to be considered.
- (b) When showing compliance with (a)(2) or (a)(3):
 - (1) the critical engine is assumed to fail at the most critical point along the route;
 - (2) account is taken of the effects of winds on the flight path;

- (3) fuel jettisoning is planned to take place only to an extent consistent with reaching the aerodrome or operating site with the required fuel reserves and using a safe procedure; and
 - (4) fuel jettisoning is not planned below 1 000 ft above terrain.
- (c) The width margins of (a)(1) and (a)(2) shall be increased to 18,5 km (10 NM) if the navigational accuracy cannot be met for 95 % of the total flight time.

GM1 CAT.POL.H.215(b)(3) En-route — critical engine inoperative

ED Decision 2022/005/R

FUEL JETTISON

The presence of obstacles along the en route flight path may preclude compliance with point [CAT.POL.H.215\(a\)\(1\)](#) with the planned mass at the critical point along the route. In this case, fuel jettison at the most critical point may be planned, provided that the procedures of point (d) of [AMC1 CAT.OP.MPA.191\(b\)&\(c\)](#) are complied with.

CAT.POL.H.220 Landing

Regulation (EU) No 965/2012

- (a) The landing mass of the helicopter at the estimated time of landing shall not exceed the maximum mass specified in the AFM for the procedure to be used.
- (b) In the event of the critical engine failure being recognised at any point at or before the landing decision point (LDP), it is possible either to land and stop within the FATO, or to perform a balked landing and clear all obstacles in the flight path by a vertical margin of 10,7 m (35 ft). Only obstacles as specified in [CAT.POL.H.110](#) have to be considered.
- (c) In the event of the critical engine failure being recognised at any point at or after the LDP, it is possible to:
 - (1) clear all obstacles in the approach path; and
 - (2) land and stop within the FATO.
- (d) When showing compliance with (a) to (c), account shall be taken of the appropriate parameters of [CAT.POL.H.105\(c\)](#) for the estimated time of landing at the destination aerodrome or operating site, or any alternate if required.
- (e) That part of the landing from the LDP to touchdown shall be conducted in sight of the surface.

GM1 CAT.POL.H.205&CAT.POL.H.220 Take-off and landing

ED Decision 2014/015/R

APPLICATION FOR ALTERNATIVE TAKE-OFF AND LANDING PROCEDURES

The manufacturer's Category A procedure defines profiles and scheduled data for take-off, climb, performance at minimum operating speed and landing, under specific environmental conditions and masses.

Associated with these profiles and conditions are minimum operating surfaces, take-off distances, climb performance and landing distances; these are provided (usually in graphic form) with the take-off and landing masses and the take-off decision point (TDP) and landing decision point (LDP).

The landing surface and the height of the TDP are directly related to the ability of the helicopter — following an engine failure before or at TDP — to reject onto the surface under forced landing conditions. The main considerations in establishing the minimum size of the landing surface are the scatter during flight testing of the reject manoeuvre, with the remaining engine operating within approved limits, and the required usable cue environment.

Hence, an elevated site with few visual cues — apart from the surface itself — would require a greater surface area in order that the helicopter can be accurately positioned during the reject manoeuvre within the specified area. This usually results in the stipulation of a larger surface for an elevated site than for a ground level site (where lateral cues may be present).

This could have the unfortunate side effect that a FATO that is built 3 m above the surface (and, therefore, elevated by definition) might be out of operational scope for some helicopters — even though there might be a rich visual cue environment where rejects are not problematical. The presence of elevated sites where ground level surface requirements might be more appropriate could be brought to the attention of the competent authority.

It can be seen that the size of the surface is directly related to the requirement of the helicopter to complete a rejected take-off following an engine failure. If the helicopter has sufficient power such that a failure before or at TDP will not lead to a requirement for rejected take-off, the need for large surfaces is removed; sufficient power for the purpose of this GM is considered to be the power required for hover-out-of-ground-effect one-engine-inoperative (HOGE OEI).

Following an engine failure at or after the TDP, the continued take-off path provides OEI clearance from the take-off surface and the distance to reach a point from where climb performance in the first, and subsequent segments, is assured.

If HOGE OEI performance exists at the height of the TDP, it follows that the continued take-off profile, which has been defined for a helicopter with a mass such that a rejected take-off would be required following an engine failure at or before TDP, would provide the same, or better, obstacle clearance and the same, or less, distance to reach a point where climb performance in the first, and subsequent segments, is assured.

If the TDP is shifted upwards, provided that the HOGE OEI performance is established at the revised TDP, it will not affect the shape of the continued take-off profile but should shift the min-dip upwards by the same amount that the revised TDP has been increased — with respect to the basic TDP.

Such assertions are concerned only with the vertical or the backup procedures and can be regarded as achievable under the following circumstances:

- (a) when the procedure is flown, it is based upon a profile contained in the AFM — with the exception of the necessity to perform a rejected take-off;
- (b) the TDP, if shifted upwards (or upwards and backward in the backup procedure) will be the height at which the HOGE OEI performance is established; and
- (c) if obstacles are permitted in the backup area, they should continue to be permitted with a revised TDP.

CAT.POL.H.225 Helicopter operations to/from a public interest site

Regulation (EU) No 965/2012

- (a) Operations to/from a public interest site (PIS) may be conducted in performance class 2, without complying with [CAT.POL.H.310\(b\)](#) or [CAT.POL.H.325\(b\)](#), provided that all of the following are complied with:

- (1) the PIS was in use before 1 July 2002;
 - (2) the size of the PIS or obstacle environment does not permit compliance with the requirements for operation in performance class 1;
 - (3) the operation is conducted with a helicopter with an MOPSC of six or less;
 - (4) the operator complies with [CAT.POL.H.305\(b\)\(2\) and \(b\)\(3\)](#);
 - (5) the helicopter mass does not exceed the maximum mass specified in the AFM for a climb gradient of 8 % in still air at the appropriate take-off safety speed (V_{TOSS}) with the critical engine inoperative and the remaining engines operating at an appropriate power rating; and
 - (6) the operator has obtained prior approval for the operation from the competent authority. Before such operations take place in another Member State, the operator shall obtain an endorsement from the competent authority of that State.
- (b) Site-specific procedures shall be established in the operations manual to minimise the period during which there would be danger to helicopter occupants and persons on the surface in the event of an engine failure during take-off and landing.
- (c) The operations manual shall contain for each PIS: a diagram or annotated photograph, showing the main aspects, the dimensions, the non-conformance with the requirements performance class 1, the main hazards and the contingency plan should an incident occur.

AMC1 CAT.POL.H.225(a)(5) Helicopter operations to/from a public interest site

ED Decision 2014/015/R

HELICOPTER MASS LIMITATION

- (a) The helicopter mass limitation at take-off or landing specified in CAT.POL.H.225(a)(5) should be determined using the climb performance data from 35 ft to 200 ft at V_{TOSS} (first segment of the take-off flight path) contained in the Category A supplement of the AFM (or equivalent manufacturer data acceptable in accordance with GM1-CAT.POL.H.200 & CAT.POL.H.300 & CAT.POL.H.400).
- (b) The first segment climb data to be considered is established for a climb at the take-off safety speed V_{TOSS} , with the landing gear extended (when the landing gear is retractable), with the critical engine inoperative and the remaining engines operating at an appropriate power rating (the 2 min 30 sec or 2 min OEI power rating, depending on the helicopter type certification). The appropriate V_{TOSS} , is the value specified in the Category A performance section of the AFM for vertical take-off and landing procedures (VTOL, helipad or equivalent manufacturer terminology).
- (c) The ambient conditions at the site (pressure-altitude and temperature) should be taken into account.
- (d) The data are usually provided in charts in one of the following ways:
 - (1) Height gain in ft over a horizontal distance of 100 ft in the first segment configuration (35 ft to 200 ft, V_{TOSS} , 2 min 30 sec/2 min OEI power rating). This chart should be entered with a height gain of 8 ft per 100 ft horizontally travelled, resulting in a mass value for every pressure-altitude/temperature combination considered.

- (2) Horizontal distance to climb from 35 ft to 200 ft in the first segment configuration (V_{TOSS} , 2 min 30 sec/2 min OEI power rating). This chart should be entered with a horizontally distance of 628 m (2 062 ft), resulting in a mass value for every pressure-altitude/temperature combination considered.
- (3) Rate of climb in the first segment configuration (35 ft to 200 ft, V_{TOSS} , 2 min 30 sec/2 min OEI power rating). This chart can be entered with a rate of climb equal to the climb speed (V_{TOSS}) value in knots (converted to true airspeed) multiplied by 8.1, resulting in a mass value for every pressure-altitude/temperature combination considered.

GM1 CAT.POL.H.225 Helicopter operations to/from a public interest site

ED Decision 2014/015/R

UNDERLYING PRINCIPLES

(a) General

The original Joint Aviation Authorities (JAA) Appendix 1 to JAR-OPS 3.005(i) was introduced in January 2002 to address problems that had been encountered by Member States at hospital sites due to the applicable performance requirements of JAR-OPS 3 Subparts G and H. These problems were enumerated in ACJ to Appendix 1 to JAR-OPS 3.005(d) paragraph 8, part of which is reproduced below.

'8 Problems with hospital sites

During implementation of JAR-OPS 3, it was established that a number of States had encountered problems with the impact of performance rules where helicopters were operated for HEMS. Although States accept that progress should be made towards operations where risks associated with a critical power unit failure are eliminated, or limited by the exposure time concept, a number of landing sites exist which do not (or never can) allow operations to performance class 1 or 2 requirements.

These sites are generally found in a congested hostile environment:

- *in the grounds of hospitals; or*
- *on hospital buildings;*

The problem of hospital sites is mainly historical and, whilst the Authority could insist that such sites not be used - or used at such a low weight that critical power unit failure performance is assured, it would seriously curtail a number of existing operations.

Even though the rule for the use of such sites in hospital grounds for HEMS operations (Appendix 1 to JAR-OPS 3.005(d) sub-paragraph (c)(2)(i)(A)) attracts alleviation until 2005, it is only partial and will still impact upon present operations.

Because such operations are performed in the public interest, it was felt that the Authority should be able to exercise its discretion so as to allow continued use of such sites provided that it is satisfied that an adequate level of safety can be maintained - notwithstanding that the site does not allow operations to performance class 1 or 2 standards. However, it is in the interest of continuing improvements in safety that the alleviation of such operations be constrained to existing sites, and for a limited period.'

As stated in this ACJ and embodied in the text of the appendix, the solution was short-term (until 31 December 2004). During the commenting period of JAA NPA 18, representations were

made to the JAA that the alleviation should be extended to 2009. The review committee, in not accepting this request, had in mind that this was a short-term solution to address an immediate problem, and a permanent solution should be sought.

(b) After 1 January 2005

Although elimination of such sites would remove the problem, it is recognised that phasing out, or rebuilding existing hospital sites, is a long-term goal which may not be cost-effective, or even possible, in some Member States.

It should be noted, however, that [CAT.POL.H.225\(a\)](#) limits the problem by confining approvals to hospital sites established before 1 July 2002 (established in this context means either: built before that date, or brought into service before that date — this precise wording was used to avoid problems associated with a ground level aerodrome/operating site where no building would be required). Thus the problem of these sites is contained and reducing in severity. This date was set approximately 6 months after the intended implementation of the original JAR-OPS 3 appendix.

EASA adopted the JAA philosophy that, from 1st January 2005, approval would be confined to those sites where a CAT A procedure alone cannot solve the problem. The determination of whether the helicopter can or cannot be operated in accordance with performance class 1 should be established with the helicopter at a realistic payload and fuel to complete the mission. However, in order to reduce the risk at those sites, the application of the requirements contained in [CAT.POL.H.225\(a\)](#) should be applied.

Additionally and in order to promote understanding of the problem, the text contained in [CAT.POL.H.225\(c\)](#) refers to the performance class and not to ICAO Annex 14. Thus, Part C of the operations manual should reflect the non-conformance with performance class 1, as well as the site-specific procedures (approach and departure paths) to minimise the danger to third parties in the event of an incident.

The following paragraphs explain the problem and solutions.

(c) The problem associated with such sites

There is a number of problems: some of which can be solved with the use of appropriate helicopters and procedures; and others which, because of the size of the site or the obstacle environment, cannot. They consist of:

- (1) the size of the surface of the site (smaller than that required by the manufacturer's procedure);
- (2) an obstacle environment that prevents the use of the manufacturer's procedure (obstacles in the backup area); and
- (3) an obstacle environment that does not allow recovery following an engine failure in the critical phase of take-off (a line of buildings requiring a demanding gradient of climb) at a realistic payload and fuel to complete the mission.
 - Problems associated with (c)(1): the inability to climb and conduct a rejected landing back to the site following an engine failure before the Decision Point (DP).
 - Problems associated with (c)(2): as in (c)(1).
 - Problems associated with (c)(3): climb into an obstacle following an engine failure after DP.

Problems cannot be solved in the immediate future, but can, when mitigated with the use of the latest generation of helicopters (operated at a weight that can allow useful payloads and endurance), minimise exposure to risk.

(d) Long-term solution

Although not offering a complete solution, it was felt that a significant increase in safety could be achieved by applying an additional performance margin to such operations. This solution allowed the time restriction of 2004 to be removed.

The required performance level of 8 % climb gradient in the first segment reflects ICAO Annex 14 Volume II in 'Table 4-3 'Dimensions and slopes of obstacle limitations surfaces' for performance class 2.

The performance delta is achieved without the provision of further manufacturer's data by using existing graphs to provide the reduced take-off mass (RTOM).

If the solution in relation to the original problem is examined, the effects can be seen.

- (1) Solution with relation to (c)(1): although the problem still exists, the safest procedure is a dynamic take-off reducing the time taken to achieve V_{stayup} and thus allowing VFR recovery — if the failure occurs at or after V_y and 200 ft, an IFR recovery is possible.
- (2) Solution with relation to (c)(2): as in (c)(1) above.
- (3) Solution with relation to (c)(3): once again this does not give a complete solution, however, the performance delta minimises the time during which a climb over the obstacle cannot be achieved.

GM1 CAT.POL.H.225(a)(6) Helicopter operations to/from a public interest site

ED Decision 2014/015/R

ENDORSEMENT FROM ANOTHER STATE

(a) Application to another State

To obtain an endorsement from another State, the operator should submit to that State:

- (1) the reasons that preclude compliance with the requirements for operations in performance class 1;
- (2) the site-specific procedures to minimise the period during which there would be danger to helicopter occupants and person on the surface in the event of an engine failure during take-off and landing; and
- (3) the extract from the operations manual to comply with [CAT.POL.H.225\(c\)](#).

(b) Endorsement from another State

Upon receiving the endorsement from another State, the operator should submit it together with the site-specific procedures and the reasons and justification that preclude the use of performance class 1 criteria to the competent authority issuing the AOC to obtain the approval or extend the approval to a new public interest site.

CHAPTER 3 – PERFORMANCE CLASS 2

CAT.POL.H.300 General

Regulation (EU) No 965/2012

Helicopters operated in performance class 2 shall be certified in category A or equivalent as determined by the Agency.

GM to Section 2, Chapter 3 performance class 2

ED Decision 2014/015/R

OPERATIONS IN PERFORMANCE CLASS 2

(a) Introduction

This GM describes performance class 2 as established in Part-CAT. It has been produced for the purpose of:

- (1) explaining the underlying philosophy of operations in performance class 2;
- (2) showing simple means of compliance; and
- (3) explaining how to determine — with examples and diagrams:
 - (i) the take-off and landing masses;
 - (ii) the length of the safe forced landing area;
 - (iii) distances to establish obstacle clearance; and
 - (iv) entry point(s) into performance class 1.

It explains the derivation of performance class 2 from ICAO Annex 6 Part III and describes an alleviation that may be approved in accordance with [CAT.POL.H.305](#) following a risk assessment.

It examines the basic requirements, discusses the limits of operation, and considers the benefits of the use of performance class 2.

It contains examples of performance class 2 in specific circumstances, and explains how these examples may be generalised to provide operators with methods of calculating landing distances and obstacle clearance.

(b) Definitions used in this GM

The definitions for the following terms, used in this GM, are contained in Annex I and its AMC:

- (1) distance DR;
- (2) defined point after take-off (DPATO);
- (3) defined point before landing (DPBL);
- (4) landing distance available (LDAH);
- (5) landing distance required (LDRH);
- (6) performance class 2;
- (7) safe forced landing (SFL); and
- (8) take-off distance available (TODAH).

The following terms, which are not defined Annex I, are used in this GM:

- V_T : a target speed at which to aim at the point of minimum ground clearance (min-dip) during acceleration from TDP to V_{TOSS} ;
- V_{50} : a target speed and height utilised to establish an AFM distance (in compliance with the requirement of CS/JAR 29.63) from which climb out is possible; and
- V_{stayup} : a colloquial term used to indicate a speed at which a descent would not result following an engine failure. This speed is several knots lower than V_{TOSS} at the equivalent take-off mass.

(c) What defines performance class 2

Performance class 2 can be considered as performance class 3 take-off or landing, and performance class 1 climb, cruise and descent. It comprises an all-engines-operating (AEO) obstacle clearance regime for the take-off or landing phases, and a OEI obstacle clearance regime for the climb, cruise, descent, approach and missed approach phases.

For the purpose of performance calculations in Part-CAT, the CS/JAR 29.67 Category A climb performance criteria is used:

- 150 ft/min at 1 000 ft (at V_y);

and depending on the choice of DPATO:

- 100 ft/min up to 200 ft (at V_{TOSS})

at the appropriate power settings.

(1) Comparison of obstacle clearance in all performance classes

Figure 1 shows the profiles of the three performance classes — superimposed on one diagram.

- Performance class 1 (PC1): from TDP, requires OEI obstacle clearance in all phases of flight; the construction of Category A procedures, provides for a flight path to the first climb segment, a level acceleration segment to V_y (which may be shown concurrent with the first segment), followed by the second climb segment from V_y at 200 ft (see Figure 1).

Figure 1

All Performance Classes (a comparison)

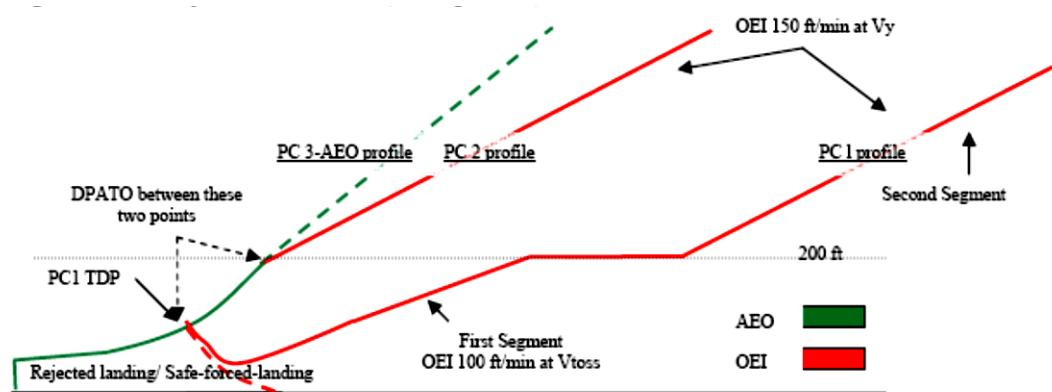

- Performance class 2 (PC2): requires AEO obstacle clearance to DPATO and OEI from then on. The take-off mass has the PC1 second segment climb performance at its basis

therefore, at the point where V_y at 200 ft is reached, Performance Class 1 is achieved (see also Figure 3).

- Performance class 3 (PC3): requires AEO obstacle clearance in all phases.

Figure 2

Performance Class 1 distances

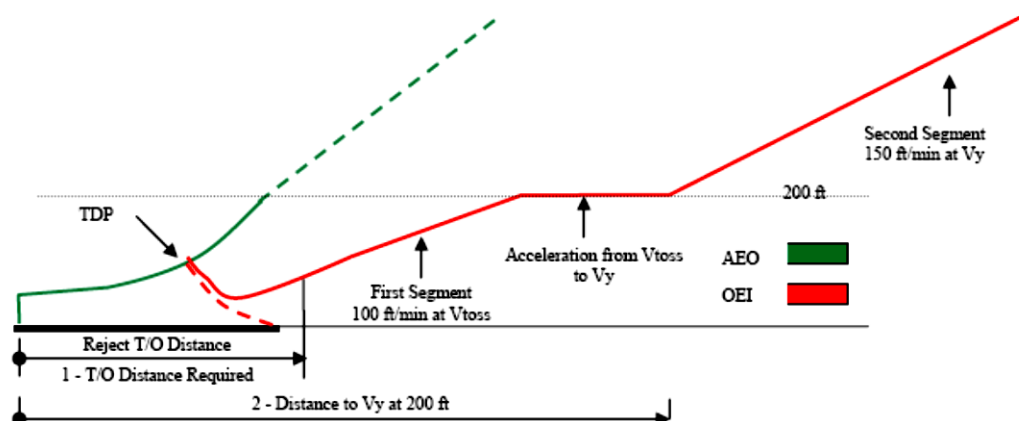

- (2) Comparison of the discontinued take-off in all performance classes

- (i) PC1 — requires a prepared surface on which a rejected landing can be undertaken (no damage); and
- (ii) PC2 and 3 — require a safe forced landing surface (some damage can be tolerated, but there must be a reasonable expectancy of no injuries to persons in the aircraft or third parties on the surface).

- (d) The derivation of performance class 2

PC2 is primarily based on the text of ICAO Annex 6 Part III Section II and its attachments which provide for the following:

- (1) obstacle clearance before DPATO: the helicopter shall be able, with all engines operating, to clear all obstacles by an adequate margin until it is in a position to comply with (2);
- (2) obstacle clearance after DPATO: the helicopter shall be able, in the event of the critical engine becoming inoperative at any time after reaching DPATO, to continue the take-off clearing all obstacles along the flight path by an adequate margin until it is able to comply with en-route clearances; and
- (3) engine failure before DPATO: before the DPATO, failure of the critical engine may cause the helicopter to force land; therefore, a safe forced landing should be possible (this is analogous to the requirement for a reject in performance class 1, but where some damage to the helicopter can be tolerated.)

- (e) Benefits of performance class 2

Operations in performance class 2 permit advantage to be taken of an AEO procedure for a short period during take-off and landing — whilst retaining engine failure accountability in the climb, descent and cruise. The benefits include the ability to:

- (1) use (the reduced) distances scheduled for the AEO — thus permitting operations to take place at smaller aerodromes and allowing airspace requirements to be reduced;
- (2) operate when the safe forced landing distance available is located outside the boundary of the aerodrome;
- (3) operate when the take-off distance required is located outside the boundary of the aerodrome; and
- (4) use existing Category A profiles and distances when the surface conditions are not adequate for a reject, but are suitable for a safe forced landing (for example, when the ground is waterlogged).

Additionally, following a risk assessment when the use of exposure is approved by the competent authority the ability to:

- (i) operate when a safe forced landing is not assured in the take-off phase; and
 - (ii) penetrate the HV curve for short periods during take-off or landing.
- (f) Implementation of performance class 2 in Part-CAT

The following sections explain the principles of the implementation of performance class 2.

- (1) Does ICAO spell it all out?

ICAO Annex 6 does not give guidance on how DPATO should be calculated nor does it require that distances be established for the take-off. However, it does require that, up to DPATO AEO, and from DPATO OEI, obstacle clearance is established (see Figure 3 and Figure 4 which are simplified versions of the diagrams contained in Annex 6 Part III, Attachment A).

(ICAO Annex 8 – Airworthiness of Aircraft (IVA 2.2.3.1.4' and 'IVB 2.2.7 d) requires that an AEO distance be scheduled for all helicopters operating in performance classes 2 & 3. ICAO Annex 6 is dependent upon the scheduling of the AEO distances, required in Annex 8, to provide data for the location of DPATO.)

When showing obstacle clearance, the divergent obstacle clearance height required for IFR is — as in performance class 1 — achieved by the application of the additional obstacle clearance of 0.01 distance DR (the distance from the end of 'take-off-distance-available' — see the pictorial representation in Figure 4 and the definition in Annex I).

As can also be seen from Figure 4, flight must be conducted in VFR until DPATO has been achieved (and deduced that if an engine failure occurs before DPATO, entry into IFR is not permitted (as the OEI climb gradient will not have been established)).

Figure 3

Performance Class 2 Obstacle Clearance

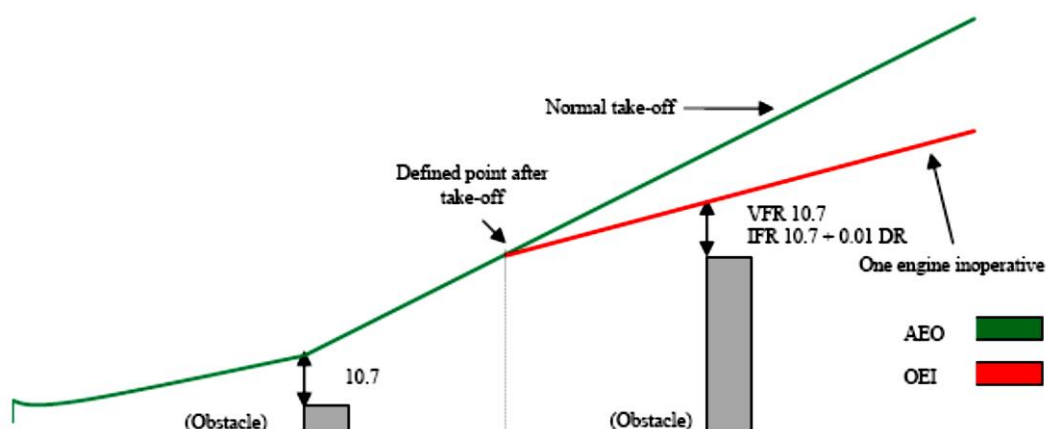
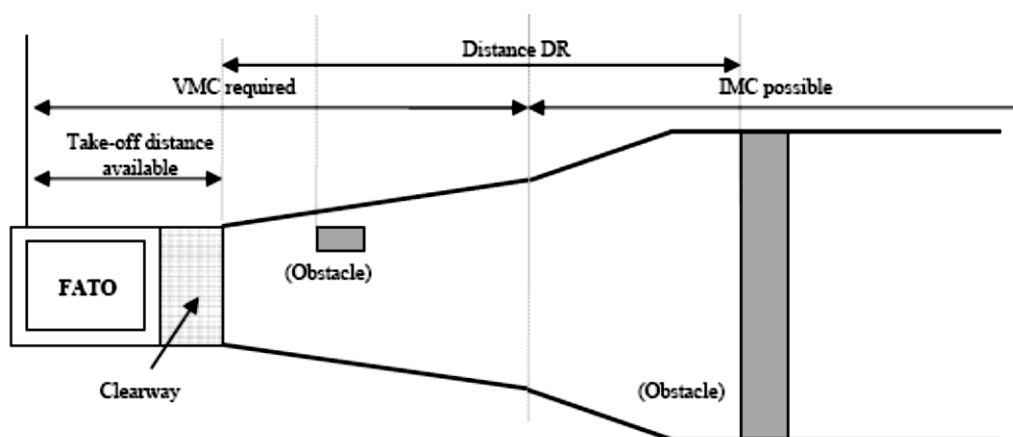

Figure 4

Performance Class 2 Obstacle Clearance (plan view)



(2) Function of DPATO

From the preceding paragraphs, it can be seen that DPATO is germane to PC2. It can also be seen that, in view of the many aspects of DPATO, it has, potentially, to satisfy a number of requirements that are not necessarily synchronised (nor need to be).

It is clear that it is only possible to establish a single point for DPATO, satisfying the requirement of (d)(2) & (d)(3), when:

- accepting the TDP of a Category A procedure; or
- extending the safe forced landing requirement beyond required distances (if data are available to permit the calculation of the distance for a safe forced landing from the DPATO).

It could be argued that the essential requirement for DPATO is contained in section (d)(2) — OEI obstacle clearance. From careful examination of the flight path reproduced in Figure 3 above, it may be reasonably deduced that DPATO is the point at which adequate climb performance is established (examination of Category A procedures would indicate

that this could be (in terms of mass, speed and height above the take-off surface) the conditions at the start of the first or second segments — or any point between.)

(The diagrams in Attachment A of ICAO Annex 6 do not appear to take account of drop down — permitted under Category A procedures; similarly with helideck departures, the potential for acceleration in drop down below deck level (once the deck edge has been cleared) is also not shown. These omissions could be regarded as a simplification of the diagram, as drop down is discussed and accepted in the accompanying ICAO text.)

It may reasonably be argued that, during the take-off and before reaching an appropriate climb speed (V_{TOSS} or V_y), V_{stayup} will already have been achieved (where V_{stayup} is the ability to continue the flight and accelerate without descent — shown in some Category A procedures as VT or target speed) and where, in the event of an engine failure, no landing would be required.

It is postulated that, to practically satisfy all the requirements of (d)(1), (2) and (3), DPATO does not need to be defined at one synchronised point; provisions can be met separately, i.e. defining the distance for a safe forced landing, and then establishing the OEI obstacle clearance flight path.

As the point at which the helicopter's ability to continue the flight safely, with the critical engine inoperative is the critical element, it is that for which DPATO is used in this text.

Figure 5

The three elements in a PC 2 take-off

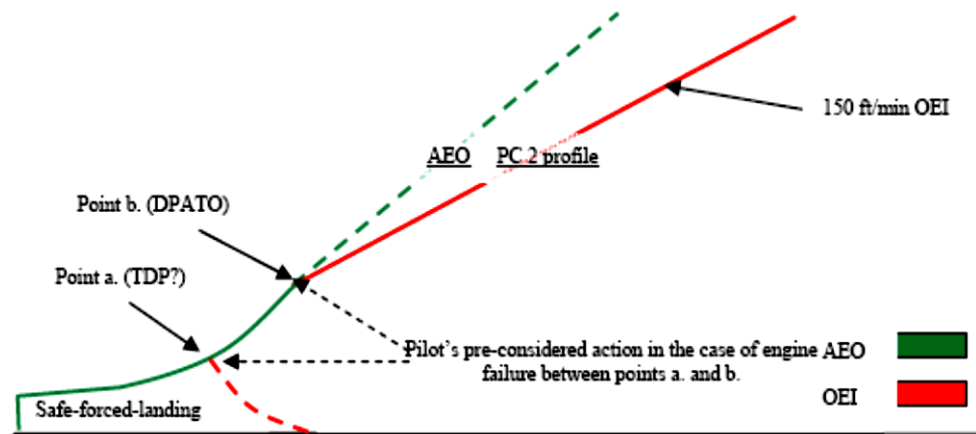

(i) The three elements from the pilot's perspective

When seen from the pilot's perspective (see Figure 5), there are three elements of the PC 2 take-off — each with associated related actions which need to be considered in the case of an engine failure:

- (A) action in the event of an engine failure — up to the point where a forced-landing will be required;
- (B) action in the event of an engine failure — from the point where OEI obstacle clearance is established (DPATO); and
- (C) pre-considered action in the event of an engine failure — in the period between (A) and (B)

The action of the pilot in (A) and (B) is deterministic, i.e. it remains the same for every occasion. For pre-consideration of the action at point (C), as is likely that the planned flight path will have to be abandoned (the point at which obstacle clearance using the OEI climb gradients not yet being reached), the pilot must (before take-off) have considered his/her options and the associated risks, and have in mind the course of action that will be pursued in the event of an engine failure during that short period. (As it is likely that any action will involve turning manoeuvres, the effect of turns on performance must be considered.)

(3) Take-off mass for performance class 2

As previously stated, performance class 2 is an AEO take-off that, from DPATO, has to meet the requirement for OEI obstacle clearance in the climb and en-route phases. Take-off mass is, therefore, the mass that gives at least the minimum climb performance of 150 ft/min at V_y , at 1 000 ft above the take-off point, and obstacle clearance.

As can be seen in Figure 6 below, the take-off mass may have to be modified when it does not provide the required OEI clearance from obstacles in the take-off-flight path (exactly as in performance class 1). This could occur when taking off from an aerodrome/operating site where the flight path has to clear an obstacle such a ridge line (or line of buildings) that can neither be:

- (i) flown around using VFR and see and avoid; nor
- (ii) cleared using the minimum climb gradient given by the take-off mass (150 ft/min at 1 000 ft).

In this case, the take-off mass has to be modified (using data contained in the AFM) to give an appropriate climb gradient.

Figure 6

Performance Class 2 (enhanced climb gradient)

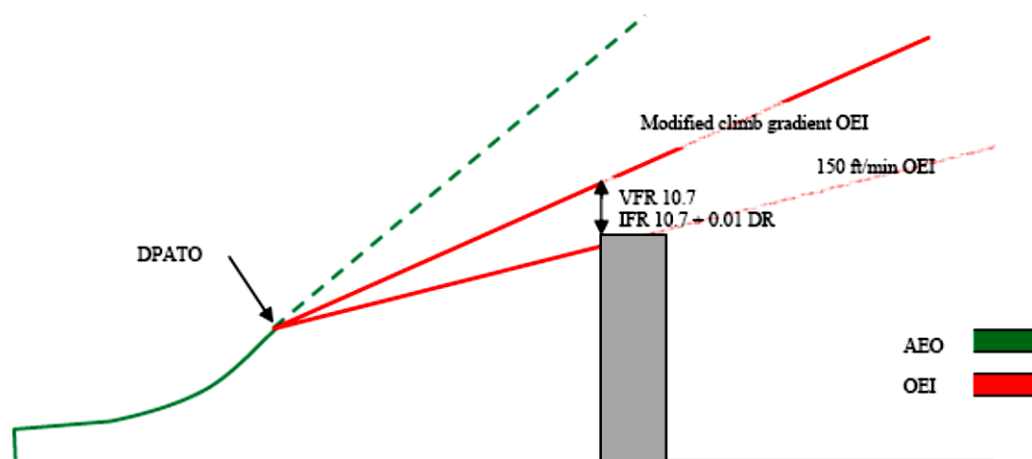

(4) Do distances have to be calculated?

Distances do not have to be calculated if, by using pilot judgement or standard practice, it can be established that:

- (i) a safe forced landing is possible following an engine failure (notwithstanding that there might be obstacles in the take-off path); and

- (ii) obstacles can be cleared (or avoided) — AEO in the take-off phase and OEI in the climb.

If early entry (in the sense of cloud base) into IMC is expected, an IFR departure should be planned. However, standard masses and departures can be used when described in the operations manual.

- (5) The use of Category A data

In Category A procedures, TDP is the point at which either a rejected landing or a safe continuation of the flight, with OEI obstacle clearance, can be performed.

For PC2 (when using Category A data), only the safe forced landing (reject) distance depends on the equivalent of the TDP; if an engine fails between TDP and DPATO, the pilot has to decide what action is required. It is not necessary for a safe forced landing distance to be established from beyond the equivalent of TDP (see Figure 5 and discussion in (f)(2)(ii)(A)).

Category A procedures based on a fixed V_{TOSS} are usually optimised either for the reduction of the rejected take-off distance, or the take-off distance. Category A procedures based on a variable V_{TOSS} allow either a reduction in required distances (low V_{TOSS}) or an improvement in OEI climb capability (high V_{TOSS}). These optimisations may be beneficial in PC2 to satisfy the dimensions of the take-off site.

In view of the different requirements for PC2 (from PC1), it is perfectly acceptable for the two calculations (one to establish the safe forced landing distance and the other to establish DPATO) to be based upon different Category A procedures. However, if this method is used, the mass resulting from the calculation cannot be more than the mass from the more limiting of the procedures.

- (6) DPATO and obstacle clearance

If it is necessary for OEI obstacle clearance to be established in the climb, the starting point (DPATO) for the (obstacle clearance) gradient has to be established. Once DPATO is defined, the OEI obstacle clearance is relatively easy to calculate with data from the AFM.

- (i) DPATO based on AEO distance

In the simplest case; if provided, the scheduled AEO to 200 ft at V_y can be used (see Figure 7).

Figure 7

Suggested AEO locations for DPATO

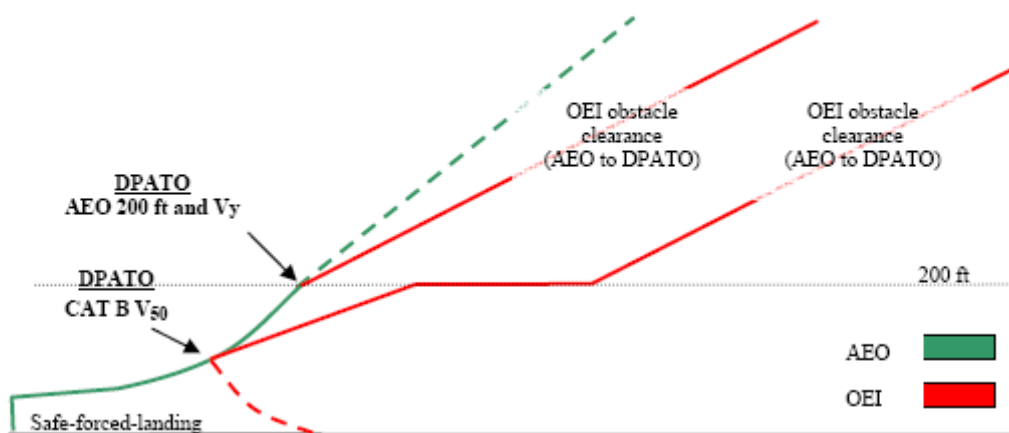

Otherwise, and if scheduled in the AFM, the AEO distance to 50 ft (V_{50}) — determined in accordance with CS/JAR 29.63 — can be used (see Figure 7). Where this distance is used, it will be necessary to ensure that the V_{50} climb out speed is associated with a speed and mass for which OEI climb data are available so that, from V_{50} , the OEI flight path can be constructed.

- (ii) DPATO based on Category A distances

It is not necessary for specific AEO distances to be used (although for obvious reasons it is preferable); if they are not available, a flight path (with OEI obstacle clearance) can be established using Category A distances (see Figure 8 and Figure 9) — which will then be conservative.

Figure 8

Using Cat A data; actual and apparent position of DPATO (V_{toss} and start of first segment)

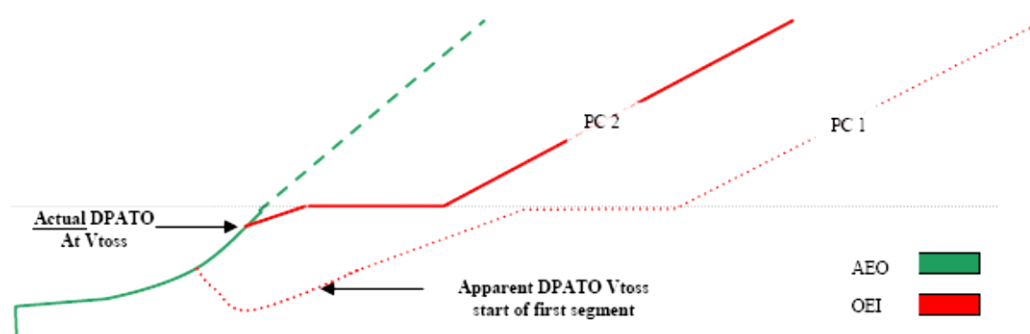

The apparent DPATO is for planning purposes only in the case where AEO data are not available to construct the take-off flight path. The actual OEI flight path will provide better obstacle clearance than the apparent one (used to demonstrate the minimum requirement) — as seen from the firm and dashed lines in the above figure.

Figure 9

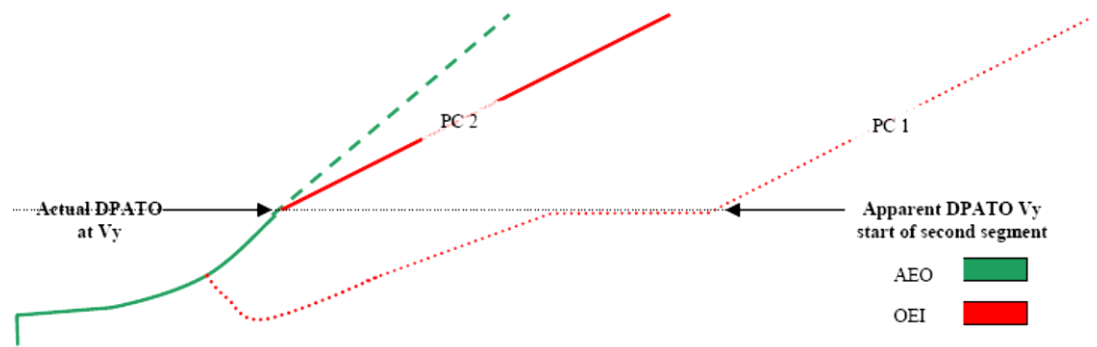
 Using Cat A data; actual and apparent position of DPATO (V_y and start of second segment)

- (iii) Use of most favourable Category A data

The use of AEO data are recommended for calculating DPATO. However, where an AEO distance is not provided in the flight manual, distance to V_y at 200 ft, from the most favourable of the Category A procedures, can be used to construct a flight path (provided it can be demonstrated that AEO distance to 200 ft at V_y is always closer to the take-off point than the CAT A OEI flight path).

In order to satisfy the requirement of [CAT.POL.H.315](#), the last point from where the start of OEI obstacle clearance can be shown is at 200 ft.

- (7) The calculation of DPATO — a summary

DPATO should be defined in terms of speed and height above the take-off surface and should be selected such that AFM data (or equivalent data) are available to establish the distance from the start of the take-off up to the DPATO (conservatively if necessary).

- (i) First method

DPATO is selected as the AFM Category B take-off distance (V_{50} speed or any other take-off distance scheduled in accordance with CS/JAR 29.63) provided that within the distance the helicopter can achieve:

- (A) one of the V_{TOSS} values (or the unique V_{TOSS} value if it is not variable) provided in the AFM, selected so as to assure a climb capability according to Category A criteria; or
- (B) V_y .

Compliance with [CAT.POL.H.315](#) would be shown from V_{50} (or the scheduled Category B take-off distance).

- (ii) Second method

DPATO is selected as equivalent to the TDP of a Category A 'clear area' take-off procedure conducted in the same conditions.

Compliance with [CAT.POL.H.315](#) would be shown from the point at which V_{TOSS} , a height of at least 35 ft above the take-off surface and a positive climb gradient are achieved (which is the Category A 'clear area' take-off distance).

Safe forced landing areas should be available from the start of the take-off, to a distance equal to the Category A 'clear area' rejected take-off distance.

(iii) Third method

As an alternative, DPATO could be selected such that AFM OEI data are available to establish a flight path initiated with a climb at that speed. This speed should then be:

- (A) one of the V_{TOSS} values (or the unique V_{TOSS} value if it is not variable) provided in the AFM, selected so as to assure a climb capability according to Category A criteria; or
- (B) V_y

The height of the DPATO should be at least 35 ft and can be selected up to 200 ft. Compliance with [CAT.POL.H.315](#) would be shown from the selected height.

(8) Safe forced landing distance

Except as provided in (f)(7)(ii), the establishment of the safe forced landing distance could be problematical as it is not likely that PC2 specific data will be available in the AFM.

By definition, the Category A reject distance may be used when the surface is not suitable for a reject, but may be satisfactory for a safe forced landing (for example, where the surface is flooded or is covered with vegetation).

Any Category A (or other accepted) data may be used to establish the distance. However, once established, it remains valid only if the Category A mass (or the mass from the accepted data) is used and the Category A (or accepted) AEO profile to the TDP is flown. In view of these constraints, the likeliest Category A procedures are the clear area or the short field (restricted area/site) procedures.

From Figure 10, it can be seen that if the Category B V_{50} procedure is used to establish DPATO, the combination of the distance to 50 ft and the Category A 'clear area' landing distance, required by CS/JAR 29.81 (the horizontal distance required to land and come to a complete stop from a point 50 ft above the landing surface), will give a good indication of the maximum safe-forced-landing distance required (see also the explanation on V_{stayup} above).

Figure 10

Category B (V_{50}) safe-forced-landing distance

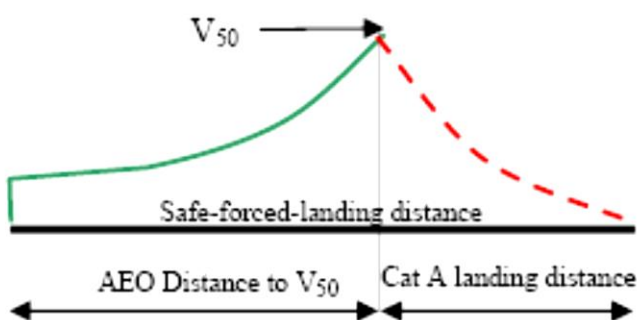

(9) Performance class 2 landing

For other than PC2 operations to elevated FATOs or helidecks (see section (g)(4)(i)), the principles for the landing case are much simpler. As the performance requirements for PC1 and PC2 landings are virtually identical, the condition of the landing surface is the main issue.

If the engine fails at any time during the approach, the helicopter must be able either: to perform a go-around meeting the requirements of [CAT.POL.H.315](#); or perform a safe forced landing on the surface. In view of this, and if using PC1 data, the LDP should not be lower than the corresponding TDP (particularly in the case of a variable TDP).

The landing mass will be identical to the take-off mass for the same site (with consideration for any reduction due to obstacle clearance — as shown in Figure 6 above).

In the case of a balked landing (i.e. the landing site becomes blocked or unavailable during the approach), the full requirement for take-off obstacle clearance must be met.

(g) Operations in performance class 2 with exposure

The Implementing Rules offer an opportunity to discount the requirement for an assured safe forced landing area in the take-off or landing phase — subject to an approval from the competent authority. The following sections deal with this option:

(1) Limit of exposure

As stated above, performance class 2 has to ensure AEO obstacle clearance to DPATO and OEI obstacle clearance from that point. This does not change with the application of exposure.

It can, therefore, be stated that operations with exposure are concerned only with alleviation from the requirement for the provision of a safe forced landing.

The absolute limit of exposure is 200 ft — from which point OEI obstacle clearance must be shown.

(2) The principle of risk assessment

ICAO Annex 6 Part III Chapter 3.1.2 states that:

‘3.1.2 In conditions where the safe continuation of flight is not ensured in the event of a critical engine failure, helicopter operations shall be conducted in a manner that gives appropriate consideration for achieving a safe forced landing.’

Although a safe forced landing may no longer be the (absolute) Standard, it is considered that risk assessment is obligatory to satisfy the amended requirement for ‘appropriate consideration’.

Risk assessment used for fulfilment of this proposed Standard is consistent with principles described in ‘AS/NZS 4360:1999’. Terms used in this text and defined in the AS/NZS Standard are shown in Sentence Case e.g. risk assessment or risk reduction.

(3) The application of risk assessment to performance class 2

Under circumstances where no risk attributable to engine failure (beyond that inherent in the safe forced landing) is present, operations in performance class 2 may be conducted in accordance with the non-alleviated requirements contained above — and a safe forced landing will be possible.

Under circumstances where such risk would be present, i.e. operations to an elevated FATO (deck edge strike); or, when permitted, operations from a site where a safe forced landing cannot be accomplished because the surface is inadequate; or where there is penetration into the HV curve for a short period during take-off or landing (a limitation in CS/JAR 29 AFMs), operations have to be conducted under a specific approval.

Provided such operations are risk assessed and can be conducted to an established safety target, they may be approved in accordance with [CAT.POL.H.305](#).

(i) The elements of the risk management

The approval process consists of an operational risk assessment and the application of four principles:

- (A) a safety target;
- (B) a helicopter reliability assessment;
- (C) continuing airworthiness; and
- (D) mitigating procedures.

(ii) The safety target

The main element of the risk assessment when exposure was initially introduced by the JAA into JAR-OPS 3 (NPA OPS⁸), was the assumption that turbine engines in helicopters would have failure rates of about 1:100 000 per flying hour, which would permit (against the agreed safety target of 5×10^{-8} per event) an exposure of about 9 seconds for twins during the take-off or landing event. (When choosing this target it was assumed that the majority of current well-maintained turbine powered helicopters would be capable of meeting the event target — it, therefore, represents the residual risk).

(Residual risk is considered to be the risk that remains when all mitigating procedures — airworthiness and operational — are applied (see sections (g)(3)(iv) and (g)(3)(v))).

(iii) The reliability assessment

The reliability assessment was initiated to test the hypothesis (stated in (g)(3)(ii)) that the majority of turbine powered types would be able to meet the safety target. This hypothesis could only be confirmed by an examination of the manufacturers' power-loss data.

(iv) Mitigating procedures (airworthiness)

Mitigating procedures consist of a number of elements:

- (A) the fulfilment of all manufacturers' safety modifications;
- (B) a comprehensive reporting system (both failures and usage data); and
- (C) the implementation of a usage monitoring system (UMS).

Each of these elements is to ensure that engines, once shown to be sufficiently reliable to meet the safety target, will sustain such reliability (or improve upon it).

The monitoring system is felt to be particularly important as it had already been demonstrated that when such systems are in place it inculcates a more considered

approach to operations. In addition, the elimination of ‘hot starts’, prevented by the UMS, itself minimises the incidents of turbine burst failures.

(v) Mitigating procedures (operations)

Operational and training procedures, to mitigate the risk — or minimise the consequences — are required of the operator. Such procedures are intended to minimise risk by ensuring that:

- (A) the helicopter is operated within the exposed region for the minimum time; and
- (B) simple but effective procedures are followed to minimise the consequence should an engine failure occur.

(4) Operation with exposure

When operating with exposure, there is alleviation from the requirement to establish a safe forced landing area (which extends to landing as well as take-off). However, the requirement for obstacle clearance — AEO in the take-off and from DPATO OEI in the climb and en-route phases — remains (both for take-off and landing).

The take-off mass is obtained from the more limiting of the following:

- the climb performance of 150 ft/min at 1 000 ft above the take-off point; or
- obstacle clearance (in accordance with (f)(3) above); or
- AEO hover out of ground effect (HOGE) performance at the appropriate power setting. (AEO HOGE is required to ensure acceleration when (near) vertical dynamic take-off techniques are being used. Additionally, for elevated FATO or helidecks, it ensures a power reserve to offset ground cushion dissipation; and ensures that, during the landing manoeuvre, a stabilised HOGE is available — should it be required.)

(i) Operations to elevated FATO or helidecks

PC2 operations to elevated FATO and helidecks are a specific case of operations with exposure. In these operations, the alleviation covers the possibility of:

- (A) a deck-edge strike if the engine fails early in the take-off or late in the landing;
- (B) penetration into the HV Curve during take-off and landing; and
- (C) forced landing with obstacles on the surface (hostile water conditions) below the elevated FATO (helideck). The take-off mass is as stated above and relevant techniques are as described in [GM1 CAT.POL.H.310\(c\)](#) & [CAT.POL.H.325\(c\)](#).

It is unlikely that the DPATO will have to be calculated with operations to helidecks (due to the absence of obstacles in the take-off path).

(ii) Additional requirements for operations to helidecks in a hostile environment

For a number of reasons (e.g. the deck size, and the helideck environment — including obstacles and wind vectors), it was not anticipated that operations in PC1 would be technically feasible or economically justifiable by the projected JAA deadline of 2010 (OEI HOGE could have provided a method of compliance, but this would have resulted in a severe and unwarranted restriction on payload/range).

However, due to the severe consequences of an engine failure to helicopters involved in take-off and landings to helidecks located in hostile sea areas (such as the North Sea or the North Atlantic), a policy of risk reduction is called for. As a result, enhanced class 2 take-off and landing masses together with techniques that provide a high confidence of safety due to:

- (A) deck-edge avoidance; and
 - (B) drop-down that provides continued flight clear of the sea,
- are seen as practical measures.

For helicopters which have a Category A elevated helideck procedure, certification is satisfied by demonstrating a procedure and adjusted masses (adjusted for wind as well as temperature and pressure) that assure a 15-ft deck edge clearance on take-off and landing. It is, therefore, recommended that manufacturers, when providing enhanced PC2 procedures, use the provision of this deck-edge clearance as their benchmark.

As the height of the helideck above the sea is a variable, drop down has to be calculated; once clear of the helideck, a helicopter operating in PC1 would be expected to meet the 35-ft obstacle clearance. Under circumstances other than open sea areas and with less complex environmental conditions, this would not present difficulties. As the provision of drop down takes no account of operational circumstances, standard drop down graphs for enhanced PC2 — similar to those in existence for Category A procedures — are anticipated.

Under conditions of offshore operations, calculation of drop down is not a trivial matter — the following examples indicate some of the problems which might be encountered in hostile environments:

- (A) Occasions when tide is not taken into account and the sea is running irregularly — the level of the obstacle (i.e. the sea) is indefinable making a true calculation of drop down impossible.
- (B) Occasions when it would not be possible — for operational reasons — for the approach and departure paths to be clear of obstacles — the ‘standard’ calculation of drop-down could not be applied.

Under these circumstances, practicality indicates that drop down should be based upon the height of the deck AMSL and the 35-ft clearance should be applied.

There are, however, other and more complex issues which will also affect the deck-edge clearance and drop down calculations.

- (C) When operating to moving decks on vessels, a recommended landing or take-off profile might not be possible because the helicopter might have to hover alongside in order that the rise and fall of the ship is mentally mapped; or, on take-off re-landing in the case of an engine failure might not be an option.

Under these circumstances, the commander might adjust the profiles to address a hazard more serious or more likely than that presented by an engine failure.

It is because of these and other (unforeseen) circumstances that a prescriptive requirement is not used. However, the target remains a 15-ft deck-edge clearance and a 35-ft obstacle clearance and data should be provided such that, where practically possible, these clearances can be planned.

As accident/incident history indicates that the main hazard is collision with obstacles on the helideck due to human error, simple and reproducible take-off and landing procedures are recommended.

In view of the reasons stated above, the future requirement for PC1 was replaced by the new requirement that the take-off mass takes into account:

- the procedure;
- deck-edge miss; and
- drop down appropriate to the height of the helideck.

This will require calculation of take-off mass from information produced by manufacturers reflecting these elements. It is expected that such information will be produced by performance modelling/simulation using a model validated through limited flight testing.

- (iii) Operations to helidecks for helicopters with a maximum operational passenger seating configuration (MOPSC) of more than 19

The original requirement for operations of helicopters with an MOPSC of more than 19 was PC1 (as set out in [CAT.POL.H.100\(b\)\(2\)](#)).

However, when operating to helidecks, the problems enumerated in (g)(4)(ii) above are equally applicable to these helicopters. In view of this, but taking into account that increased numbers are (potentially) being carried, such operations are permitted in PC2 ([CAT.POL.H.100\(b\)\(2\)](#)) but, in all helideck environments (both hostile and non-hostile), have to satisfy, the additional requirements, set out in (g)(4)(ii) above.

CAT.POL.H.305 Operations without an assured safe forced landing capability

Regulation (EU) No 965/2012

- (a) Operations without an assured safe forced landing capability during the take-off and landing phases shall only be conducted if the operator has been granted an approval by the competent authority.
- (b) To obtain and maintain such approval the operator shall:
- (1) conduct a risk assessment, specifying:
 - (i) the type of helicopter; and
 - (ii) the type of operations;
 - (2) implement the following set of conditions:
 - (i) attain and maintain the helicopter/engine modification standard defined by the manufacturer;
 - (ii) conduct the preventive maintenance actions recommended by the helicopter or engine manufacturer;
 - (iii) include take-off and landing procedures in the operations manual, where they do not already exist in the AFM;
 - (iv) specify training for flight crew; and

- (v) provide a system for reporting to the manufacturer loss of power, engine shutdown or engine failure events;
- and
- (3) implement a usage monitoring system (UMS).

AMC1 CAT.POL.H.305(a) Operations without an assured safe forced landing capability

ED Decision 2016/022/R

VALIDITY OF THE RISK ASSESSMENT

The operator should periodically review and update the procedures and associated risk assessments, pertaining to the granting of the [CAT.POL.H.305\(a\)](#) approval, to ensure that they are adequate and remain relevant for the operation.

AMC1 CAT.POL.H.305(b) Helicopter operations without an assured safe forced landing capability

ED Decision 2014/015/R

ENGINE RELIABILITY STATISTICS

- (a) As part of the risk assessment prior to granting an approval under [CAT.POL.H.305](#), the operator should provide appropriate engine reliability statistics available for the helicopter type and the engine type.
- (b) Except in the case of new engines, such data should show sudden power loss from the set of in-flight shutdown (IFSD) events not exceeding 1 per 100 000 engine hours in a 5 year moving window. However, a rate in excess of this value, but not exceeding 3 per 100 000 engine hours, may be accepted by the competent authority after an assessment showing an improving trend.
- (c) New engines should be assessed on a case-by-case basis.
- (d) After the initial assessment, updated statistics should be periodically reassessed; any adverse sustained trend will require an immediate evaluation to be accomplished by the operator in consultation with the competent authority and the manufacturers concerned. The evaluation may result in corrective action or operational restrictions being applied.
- (e) The purpose of this paragraph is to provide guidance on how the in-service power plant sudden power loss rate is determined.
 - (1) Share of roles between the helicopter and engine type certificate holders (TCH)
 - (i) The provision of documents establishing the in-service sudden power loss rate for the helicopter/engine installation; the interface with the operational authority of the State of the operator should be the engine TCH or the helicopter TCH depending on the way they share the corresponding analysis work.
 - (ii) The engine TCH should provide the helicopter TCH with a document including: the list of in-service power loss events, the applicability factor for each event (if used), and the assumptions made on the efficiency of any corrective actions implemented (if used).

- (iii) The engine or helicopter TCH should provide the operational authority of the State of the operator, with a document that details the calculation results taking into account the following:
 - (A) events caused by the engine and the events caused by the engine installation;
 - (B) applicability factor for each event (if used), the assumptions made on the efficiency of any corrective actions implemented on the engine and on the helicopter (if used); and
 - (C) calculation of the power plant power loss rate.
- (2) Documentation

The following documentation should be updated every year:

 - (i) the document with detailed methodology and calculation as distributed to the authority of the State of design;
 - (ii) a summary document with results of computation as made available on request to any operational authority; and
 - (iii) a service letter establishing the eligibility for such operation and defining the corresponding required configuration as provided to the operators.
- (3) Definition of 'sudden in-service power loss'

Sudden in-service power loss is an engine power loss:

 - (i) larger than 30 % of the take-off power;
 - (ii) occurring during operation; and
 - (iii) without the occurrence of an early intelligible warning to inform and give sufficient time for the pilot to take any appropriate action.
- (4) Database documentation

Each power loss event should be documented, by the engine and/or helicopter TCHs, as follows:

 - (i) incident report number;
 - (ii) engine type;
 - (iii) engine serial number;
 - (iv) helicopter serial number;
 - (v) date;
 - (vi) event type (demanded IFSD, un-demanded IFSD);
 - (vii) presumed cause;
 - (viii) applicability factor when used; and
 - (ix) reference and assumed efficiency of the corrective actions that will have to be applied (if any).

(5) Counting methodology

Various methodologies for counting engine power loss rate have been accepted by authorities. The following is an example of one of these methodologies.

(i) The events resulting from:

- (A) unknown causes (wreckage not found or totally destroyed, undocumented or unproven statements);
- (B) where the engine or the elements of the engine installation have not been investigated (for example, when the engine has not been returned by the customer); or
- (C) an unsuitable or non-representative use (operation or maintenance) of the helicopter or the engine,

are not counted as engine in-service sudden power loss and the applicability factor is 0 %.

(ii) The events caused by:

- (A) the engine or the engine installation; or
- (B) the engine or helicopter maintenance, when the applied maintenance was compliant with the maintenance manuals,

are counted as engine in-service sudden power loss and the applicability factor is 100 %.

(iii) For the events where the engine or an element of the engine installation has been submitted for investigation, but where this investigation subsequently failed to define a presumed cause, the applicability factor is 50 %.

(6) Efficiency of corrective actions

The corrective actions made by the engine and helicopter manufacturers on the definition or maintenance of the engine or its installation may be defined as mandatory for specific operations. In this case, the associated reliability improvement may be considered as a mitigating factor for the event.

A factor defining the efficiency of the corrective action may be applied to the applicability factor of the concerned event.

(7) Method of calculation of the power plant power loss rate

The detailed method of calculation of the power plant power loss rate should be documented by engine or helicopter TCH and accepted by the relevant authority.

AMC2 CAT.POL.H.305(b) Helicopter operations without an assured safe forced landing capability

ED Decision 2014/015/R

IMPLEMENTATION OF THE SET OF CONDITIONS

To obtain an approval under [CAT.POL.H.305\(a\)](#), the operator conducting operations without an assured safe forced landing capability should implement the following:

-
- (a) Attain and then maintain the helicopter/engine modification standard defined by the manufacturer that has been designated to enhance reliability during the take-off and landing phases.
- (b) Conduct the preventive maintenance actions recommended by the helicopter or engine manufacturer as follows:
- (1) engine oil spectrometric and debris analysis — as appropriate;
 - (2) engine trend monitoring, based on available power assurance checks;
 - (3) engine vibration analysis (plus any other vibration monitoring systems where fitted); and
 - (4) oil consumption monitoring.
- (c) The usage monitoring system should fulfil at least the following:
- (1) Recording of the following data:
 - (i) date and time of recording, or a reliable means of establishing these parameters;
 - (ii) amount of flight hours recorded during the day plus total flight time;
 - (iii) N_1 (gas producer RPM) cycle count;
 - (iv) N_2 (power turbine RPM) cycle count (if the engine features a free turbine);
 - (v) turbine temperature exceedance: value, duration;
 - (vi) power-shaft torque exceedance: value, duration (if a torque sensor is fitted);
 - (vii) engine shafts speed exceedance: value, duration.
 - (2) Data storage of the above parameters, if applicable, covering the maximum flight time in a day, and not less than 5 flight hours, with an appropriate sampling interval for each parameter.
 - (3) The system should include a comprehensive self-test function with a malfunction indicator and a detection of power-off or sensor input disconnection.
 - (4) A means should be available for downloading and analysis of the recorded parameters. Frequency of downloading should be sufficient to ensure data are not lost through overwriting.
 - (5) The analysis of parameters gathered by the usage monitoring system, the frequency of such analysis and subsequent maintenance actions should be described in the maintenance documentation.
 - (6) The data should be stored in an acceptable form and accessible to the competent authority for at least 24 months.
- (d) The training for flight crew should include the discussion, demonstration, use and practice of the techniques necessary to minimise the risks.
- (e) Report to the manufacturer any loss of power control, engine shutdown (precautionary or otherwise) or engine failure for any cause (excluding simulation of engine failure during training). The content of each report should provide:
- (1) date and time;
 - (2) operator (and maintenance organisations where relevant);
 - (3) type of helicopter and description of operations;

- (4) registration and serial number of airframe;
- (5) engine type and serial number;
- (6) power unit modification standard where relevant to failure;
- (7) engine position;
- (8) symptoms leading up to the event;
- (9) circumstances of engine failure including phase of flight or ground operation;
- (10) consequences of the event;
- (11) weather/environmental conditions;
- (12) reason for engine failure — if known;
- (13) in case of an in-flight shutdown (IFSD), nature of the IFSD (demanded/un-demanded);
- (14) procedure applied and any comment regarding engine restart potential;
- (15) engine hours and cycles (from new and last overhaul);
- (16) airframe flight hours;
- (17) rectification actions applied including, if any, component changes with part number and serial number of the removed equipment; and
- (18) any other relevant information.

GM1 CAT.POL.H.305(b) Helicopter operations without an assured safe forced landing capability

ED Decision 2014/015/R

USE OF FULL AUTHORITY DIGITAL ENGINE CONTROL (FADEC)

Current technology increasingly allows for the recording function required in (c)(1) of [AMC2 CAT.POL.H.305\(b\)](#) to be incorporated in the full authority digital engine control (FADEC).

Where a FADEC is capable of recording some of the parameters required by (c)(1) of [AMC2 CAT.POL.H.305\(b\)](#), it is not intended that the recording of the parameters is to be duplicated.

Providing that the functions as set out in (c) of [AMC2 CAT.POL.H.305\(b\)](#) are satisfied, the FADEC may partially, or in whole, fulfil the requirement for recording and storing parameters in a usage monitoring system.

CAT.POL.H.310 Take-off

Regulation (EU) No 965/2012

- (a) The take-off mass shall not exceed the maximum mass specified for a rate of climb of 150 ft/min at 300 m (1 000 ft) above the level of the aerodrome or operating site with the critical engine inoperative and the remaining engine(s) operating at an appropriate power rating.
- (b) For operations other than those specified in [CAT.POL.H.305](#), the take-off shall be conducted such that a safe forced landing can be executed until the point where safe continuation of the flight is possible.

- (c) For operations in accordance with [CAT.POL.H.305](#), in addition to the requirements of (a):
- (1) the take-off mass shall not exceed the maximum mass specified in the AFM for an all engines operative out of ground effect (AEO OGE) hover in still air with all engines operating at an appropriate power rating; or
 - (2) for operations from a helideck:
 - (i) with a helicopter that has an MOPSC of more than 19; or
 - (ii) any helicopter operated from a helideck located in a hostile environment,the take-off mass shall take into account: the procedure; deck-edge miss and drop down appropriate to the height of the helideck with the critical engine(s) inoperative and the remaining engines operating at an appropriate power rating.
- (d) When showing compliance with (a) to (c), account shall be taken of the appropriate parameters of [CAT.POL.H.105\(c\)](#) at the point of departure.
- (e) That part of the take-off before the requirement of [CAT.POL.H.315](#) is met shall be conducted in sight of the surface.

GM1 CAT.POL.H.310(c) & CAT.POL.H.325(c) Take-off and landing

ED Decision 2014/015/R

PROCEDURE FOR CONTINUED OPERATIONS TO HELIDECKS

- (a) Factors to be considered when taking off from or landing on a helideck
- (1) In order to take account of the considerable number of variables associated with the helideck environment, each take-off and landing may require a slightly different profile. Factors such as helicopter mass and centre of gravity, wind velocity, turbulence, deck size, deck elevation and orientation, obstructions, power margins, platform gas turbine exhaust plumes etc., will influence both the take-off and landing. In particular, for the landing, additional considerations such as the need for a clear go-around flight path, visibility and cloud base, etc. will affect the commander's decision on the choice of landing profile. Profiles may be modified, taking account of the relevant factors noted above and the characteristics of individual helicopter types.
- (b) Performance
- (1) To perform the following take-off and landing profiles, adequate all engines operating (AEO) hover performance at the helideck is required. In order to provide a minimum level of performance, data (derived from the AFM AEO out of ground effect (OGE)) should be used to provide the maximum take-off or landing mass. Where a helideck is affected by downdrafts or turbulence or hot gases, or where the take-off or landing profile is obstructed, or the approach or take-off cannot be made into wind, it may be necessary to decrease this take-off or landing mass by using a suitable calculation method. The helicopter mass should not exceed that required by [CAT.POL.H.310\(a\)](#) or [CAT.POL.H.325\(a\)](#).

(For helicopter types no longer supported by the manufacturer, data may be established by the operator, provided it is acceptable to the competent authority.)
- (c) Take-off profile
- (1) The take-off should be performed in a dynamic manner ensuring that the helicopter continuously moves vertically from the hover to the rotation point (RP) and thence into

forward flight. If the manoeuvre is too dynamic, then there is an increased risk of losing spatial awareness (through loss of visual cues) in the event of a rejected take-off, particularly at night.

- (2) If the transition to forward flight is too slow, the helicopter is exposed to an increased risk of contacting the deck edge in the event of an engine failure at or just after the point of cyclic input (RP).
- (3) It has been found that the climb to RP is best made between 110 % and 120 % of the power required in the hover. This power offers a rate of climb that assists with deck-edge clearance following engine failure at RP, whilst minimising ballooning following a failure before RP. Individual types will require selection of different values within this range.

Figure 1

Take-off profile

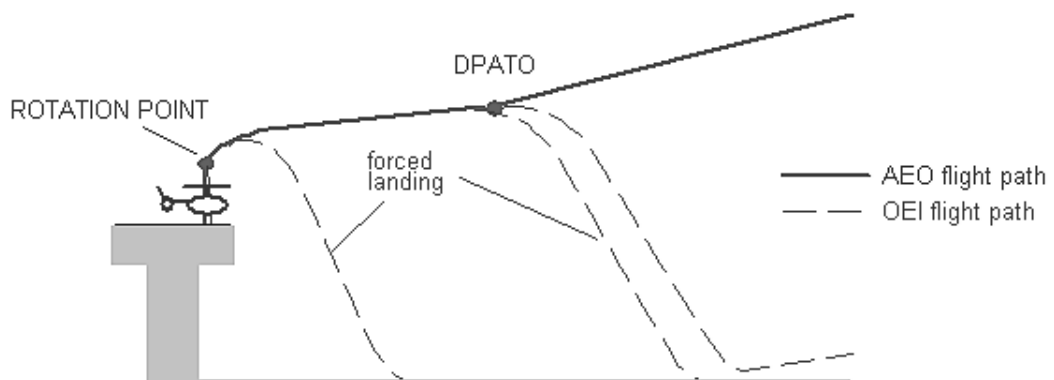

(d) Selection of a lateral visual cue

- (1) In order to obtain the maximum performance in the event of an engine failure being recognised at or just after RP, the RP should be at its optimum value, consistent with maintaining the necessary visual cues. If an engine failure is recognised just before RP, the helicopter, if operating at a low mass, may 'balloon' a significant height before the reject action has any effect. It is, therefore, important that the pilot flying selects a lateral visual marker and maintains it until the RP is achieved, particularly on decks with few visual cues. In the event of a rejected take-off, the lateral marker will be a vital visual cue in assisting the pilot to carry out a successful landing.

(e) Selection of the rotation point

- (1) The optimum RP should be selected to ensure that the take-off path will continue upwards and away from the deck with AEO, but minimising the possibility of hitting the deck edge due to the height loss in the event of an engine failure at or just after RP.
- (2) The optimum RP may vary from type to type. Lowering the RP will result in a reduced deck edge clearance in the event of an engine failure being recognised at or just after RP. Raising the RP will result in possible loss of visual cues, or a hard landing in the event of an engine failure just prior to RP.

(f) Pilot reaction times

- (1) Pilot reaction time is an important factor affecting deck edge clearance in the event of an engine failure prior to or at RP. Simulation has shown that a delay of 1 second can result in a loss of up to 15 ft in deck edge clearance.

-
- (g) Variation of wind speed
- (1) Relative wind is an important parameter in the achieved take-off path following an engine failure; wherever practicable, take-off should be made into wind. Simulation has shown that a 10-kt wind can give an extra 5-ft deck edge clearance compared to a zero wind condition.
- (h) Position of the helicopter relative to the deck edge
- (1) It is important to position the helicopter as close to the deck edge (including safety nets) as possible whilst maintaining sufficient visual cues, particularly a lateral marker.
 - (2) The ideal position is normally achieved when the rotor tips are positioned at the forward deck edge. This position minimises the risk of striking the deck edge following recognition of an engine failure at or just after RP. Any take-off heading which causes the helicopter to fly over obstructions below and beyond the deck edge should be avoided if possible. Therefore, the final take-off heading and position will be a compromise between the take-off path for least obstructions, relative wind, turbulence and lateral marker cue considerations.
- (i) Actions in the event of an engine failure at or just after RP
- (1) Once committed to the continued take-off, it is important, in the event of an engine failure, to rotate the aircraft to the optimum attitude in order to give the best chance of missing the deck edge. The optimum pitch rates and absolute pitch attitudes should be detailed in the profile for the specific type.
- (j) Take-off from helidecks that have significant movement
- (1) This technique should be used when the helideck movement and any other factors, e.g. insufficient visual cues, makes a successful rejected take-off unlikely. Weight should be reduced to permit an improved one-engine-inoperative capability, as necessary.
 - (2) The optimum take-off moment is when the helideck is level and at its highest point, e.g. horizontal on top of the swell. Collective pitch should be applied positively and sufficiently to make an immediate transition to climbing forward flight. Because of the lack of a hover, the take-off profile should be planned and briefed prior to lift off from the deck.
- (k) Standard landing profile
- (1) The approach should be commenced into wind to a point outboard of the helideck. Rotor tip clearance from the helideck edge should be maintained until the aircraft approaches this position at the requisite height (type dependent) with approximately 10 kt of ground-speed and a minimal rate of descent. The aircraft is then flown on a flight path to pass over the deck edge and into a hover over the safe landing area.

Figure 2

Standard landing profile

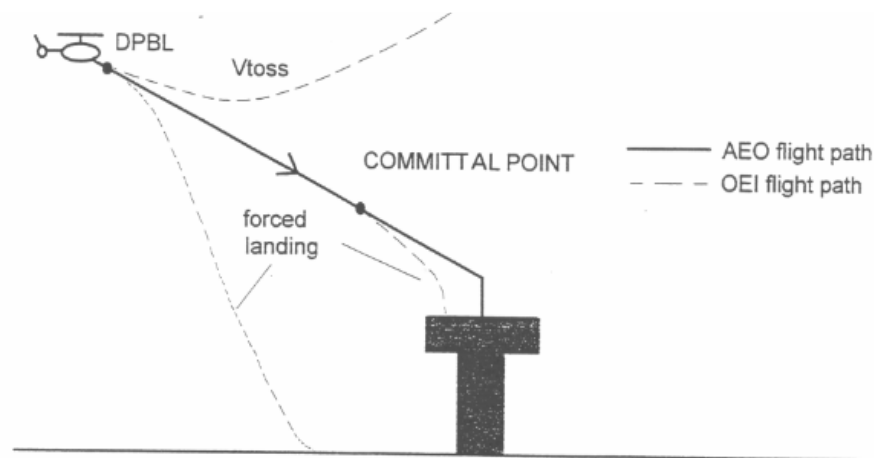

(l) Offset landing profile

- (1) If the normal landing profile is impracticable due to obstructions and the prevailing wind velocity, the offset procedure may be used. This should involve flying to a hover position, approximately 90° offset from the landing point, at the appropriate height and maintaining rotor tip clearance from the deck edge. The helicopter should then be flown slowly but positively sideways and down to position in a low hover over the landing point. Normally, the committal point (CP) will be the point at which helicopter begins to transition over the helideck edge.

(m) Training

- (1) These techniques should be covered in the training required by Annex III (Part-ORO).

GM1 CAT.POL.H.310 & CAT.POL.H.325 Take-off and landing

ED Decision 2014/015/R

TAKE-OFF AND LANDING TECHNIQUES

- (a) This GM describes three types of operation to/from helidecks and elevated FATOs by helicopters operating in performance class 2.
- (b) In two cases of take-off and landing, exposure time is used. During the exposure time (which is only approved for use when complying with [CAT.POL.H.305](#)), the probability of an engine failure is regarded as extremely remote. If an engine failure occurs during the exposure time, a safe forced landing may not be possible.
- (c) Take-off — non-hostile environment (without an approval to operate with an exposure time) [CAT.POL.H.310\(b\)](#).
 - (1) Figure 1 shows a typical take-off profile for performance class 2 operations from a helideck or an elevated FATO in a non-hostile environment.
 - (2) If an engine failure occurs during the climb to the rotation point, compliance with [CAT.POL.H.310\(b\)](#) will enable a safe landing or a safe forced landing on the deck.
 - (3) If an engine failure occurs between the rotation point and the DPATO, compliance with [CAT.POL.H.310\(b\)](#) will enable a safe forced landing on the surface, clearing the deck edge.

- (4) At or after the DPATO, the OEI flight path should clear all obstacles by the margins specified in [CAT.POL.H.315](#).

Figure 1

Typical take-off profile PC2 from a helideck/elevated FATO, non-hostile environment

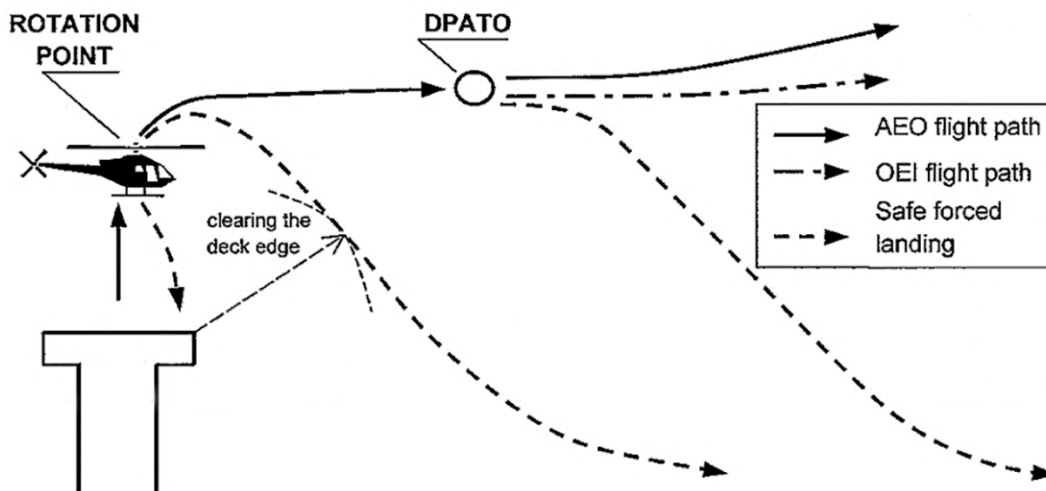

- (d) Take-off — non-hostile environment (with exposure time) [CAT.POL.H.310\(c\)](#)
- (1) Figure 2 shows a typical take-off profile for performance class 2 operations from a helideck or an elevated FATO in a non-hostile environment (with exposure time).
 - (2) If an engine failure occurs after the exposure time and before DPATO, compliance with CAT.POL.H.310(c) will enable a safe forced landing on the surface.
 - (3) At or after the DPATO, the OEI flight path should clear all obstacles by the margins specified in [CAT.POL.H.315](#).

Figure 2

Typical take-off profile PC2 from a helideck/elevated FATO with exposure time, non-hostile environment

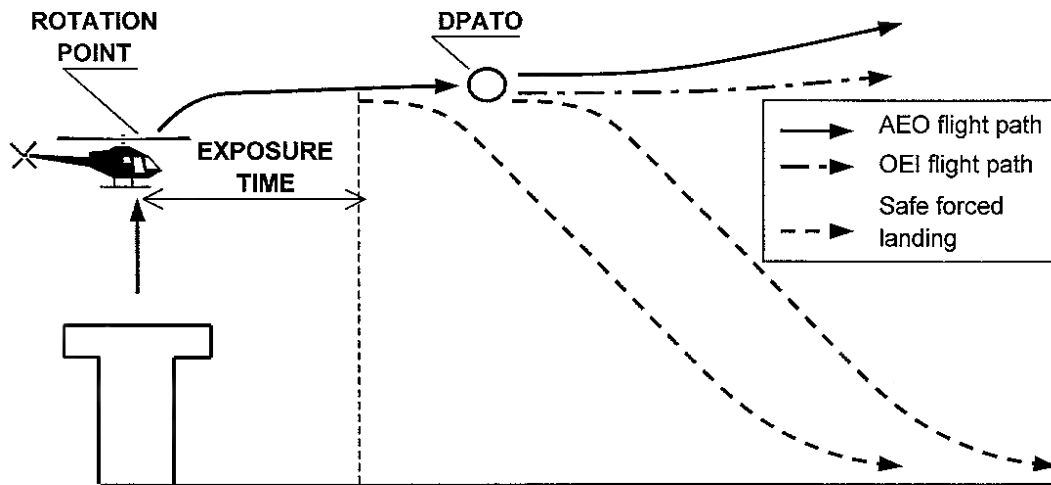

- (e) Take-off — non-congested hostile environment (with exposure time) [CAT.POL.H.310\(c\)](#)
- (1) Figure 3 shows a typical take off profile for performance class 2 operations from a helideck or an elevated FATO in a non-congested hostile environment (with exposure time).
 - (2) If an engine failure occurs after the exposure time, the helicopter is capable of a safe forced landing or safe continuation of the flight.
 - (3) At or after the DPATO, the OEI flight path should clear all obstacles by the margins specified in [CAT.POL.H.315](#).

Figure 3

Typical take-off profile PC2 from a helideck/elevated FATO, non-congested hostile environment

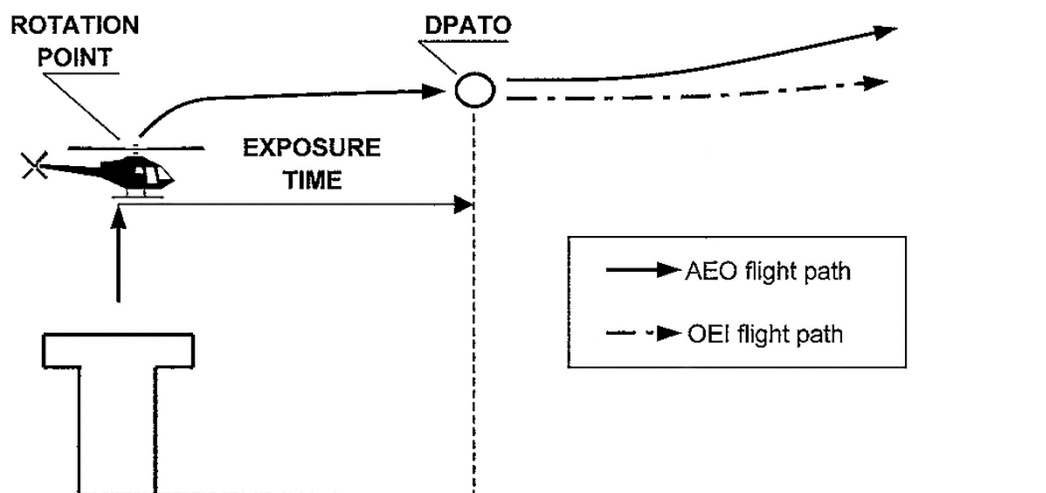

- (f) Landing — non-hostile environment (without an approval to operate with an exposure time) [CAT.POL.H.325\(b\)](#)
- (1) Figure 4 shows a typical landing profile for performance class 2 operations to a helideck or an elevated FATO in a non-hostile environment.
 - (2) The DPBL is defined as a ‘window’ in terms of airspeed, rate of descent, and height above the landing surface. If an engine failure occurs before the DPBL, the pilot may elect to land or to execute a bailed landing.
 - (3) In the event of an engine failure being recognised after the DPBL and before the committal point, compliance with CAT.POL.H.325(b) will enable a safe forced landing on the surface.
 - (4) In the event of an engine failure at or after the committal point, compliance with CAT.POL.H.325(b) will enable a safe forced landing on the deck.

Figure 4

Typical landing profile PC2 to a helideck/elevated FATO, non-hostile environment

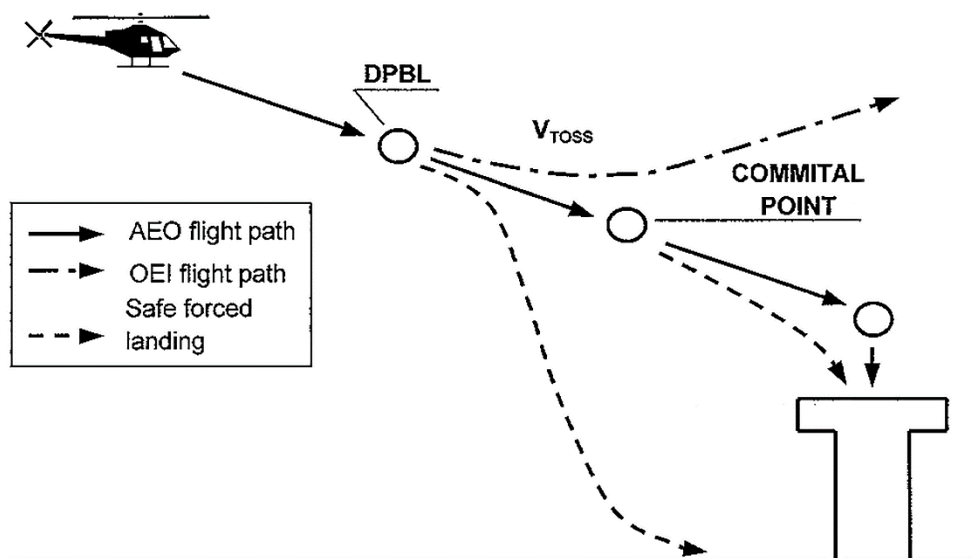

- (g) Landing — non-hostile environment (with exposure time) [CAT.POL.H.325\(c\)](#)
- (1) Figure 5 shows a typical landing profile for performance class 2 operations to a helideck or an elevated FATO in a non-hostile environment (with exposure time).
 - (2) The DPBL is defined as a ‘window’ in terms of airspeed, rate of descent, and height above the landing surface. If an engine failure occurs before the DPBL, the pilot may elect to land or to execute a bailed landing.
 - (3) In the event of an engine failure being recognised before the exposure time, compliance with CAT.POL.H.325(c) will enable a safe forced landing on the surface.
 - (4) In the event of an engine failure after the exposure time, compliance with CAT.POL.H.325(c) will enable a safe forced landing on the deck.

Figure 5

Typical landing profile PC2 to a helideck/elevated FATO with exposure time, non-hostile environment

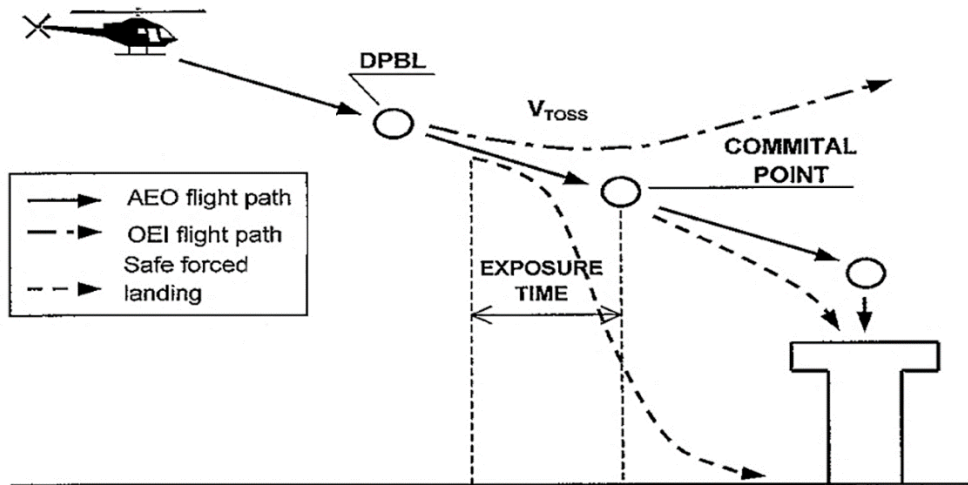

(h) Landing — non-congested hostile environment (with exposure time) [CAT.POL.H.325\(c\)](#)

- (1) Figure 6 shows a typical landing profile for performance class 2 operations to a helideck or an elevated FATO in a non-congested hostile environment (with exposure time).
- (2) In the event of an engine failure at any point during the approach and landing phase up to the start of exposure time, compliance with CAT.POL.H.325(b) will enable the helicopter, after clearing all obstacles under the flight path, to continue the flight.
- (3) In the event of an engine failure after the exposure time (i.e. at or after the committal point), a safe forced landing should be possible on the deck.

Figure 6

Typical landing profile PC2 to a helideck/elevated FATO with exposure time, non-congested hostile environment

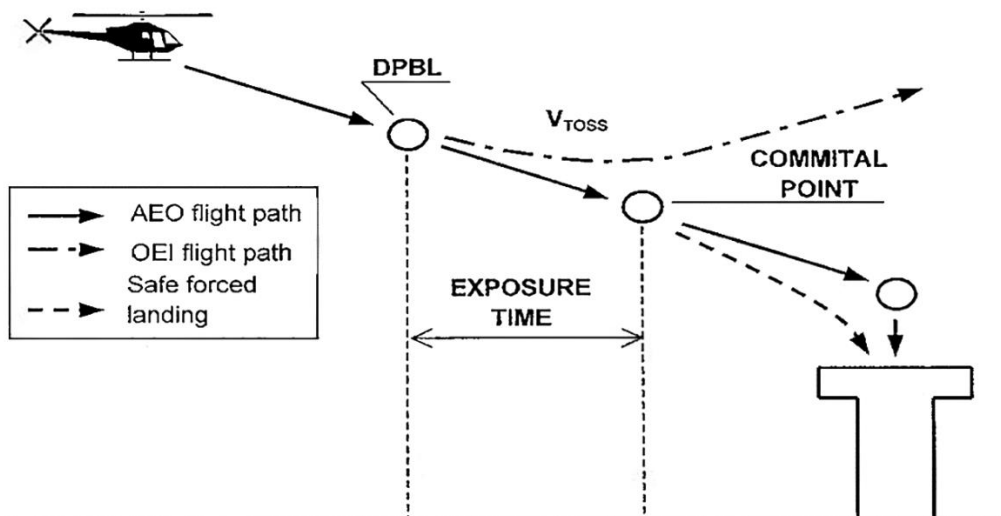

AMC1 CAT.POL.H.310(c)(2) and CAT.POL.H.325(c)(2) Take-off and landing

ED Decision 2016/022/R

FACTORS

- (a) To ensure that the necessary factors are taken into account, the operator should:
- (1) use take-off and landing procedures that are appropriate to the circumstances, and that minimise the risks of collision with obstacles at the individual offshore location under the prevailing conditions; and
 - (2) use the aircraft flight manual (AFM) performance data or, where such data is not available, alternative data approved by the competent authority, which show take-off and landing masses that take into account drop-down and take-off deck-edge miss, under varying conditions of pressure altitude, temperature, and wind.
- (b) Replanning of offshore location take-off or landing masses during the flight should only be performed in accordance with procedures established in the operations manual (OM). These procedures should be simple and safe to carry out, with no significant increase in the crew workload during critical phases of the flight.

CAT.POL.H.315 Take-off flight path

Regulation (EU) No 965/2012

From the defined point after take-off (DPATO) or, as an alternative, no later than 200 ft above the take-off surface, with the critical engine inoperative, the requirements of [CAT.POL.H.210\(a\)\(1\)](#), [\(a\)\(2\)](#) and [\(b\)](#) shall be complied with.

CAT.POL.H.320 En-route – critical engine inoperative

Regulation (EU) No 965/2012

The requirement of [CAT.POL.H.215](#) shall be complied with.

CAT.POL.H.325 Landing

Regulation (EU) No 965/2012

- (a) The landing mass at the estimated time of landing shall not exceed the maximum mass specified for a rate of climb of 150 ft/min at 300 m (1 000 ft) above the level of the aerodrome or operating site with the critical engine inoperative and the remaining engine(s) operating at an appropriate power rating.
- (b) If the critical engine fails at any point in the approach path:
- (1) a balked landing can be carried out meeting the requirement of [CAT.POL.H.315](#); or
 - (2) for operations other than those specified in [CAT.POL.H.305](#), the helicopter can perform a safe forced landing.
- (c) For operations in accordance with [CAT.POL.H.305](#), in addition to the requirements of (a):
- (1) the landing mass shall not exceed the maximum mass specified in the AFM for an AEO OGE hover in still air with all engines operating at an appropriate power rating; or

- (2) for operations to a helideck:
 - (i) with a helicopter that has an MOPSC of more than 19; or
 - (ii) any helicopter operated to a helideck located in a hostile environment,the landing mass shall take into account the procedure and drop down appropriate to the height of the helideck with the critical engine inoperative and the remaining engine(s) operating at an appropriate power rating.
- (d) When showing compliance with (a) to (c), account shall be taken of the appropriate parameters of [CAT.POL.H.105\(c\)](#) at the destination aerodrome or any alternate, if required.
- (e) That part of the landing after which the requirement of (b)(1) cannot be met shall be conducted in sight of the surface.

GM1 CAT.POL.H.310 & CAT.POL.H.325 Take-off and landing

ED Decision 2014/015/R

TAKE-OFF AND LANDING TECHNIQUES

- (a) This GM describes three types of operation to/from helidecks and elevated FATOs by helicopters operating in performance class 2.
- (b) In two cases of take-off and landing, exposure time is used. During the exposure time (which is only approved for use when complying with [CAT.POL.H.305](#)), the probability of an engine failure is regarded as extremely remote. If an engine failure occurs during the exposure time, a safe forced landing may not be possible.
- (c) Take-off — non-hostile environment (without an approval to operate with an exposure time) [CAT.POL.H.310\(b\)](#).
 - (1) Figure 1 shows a typical take-off profile for performance class 2 operations from a helideck or an elevated FATO in a non-hostile environment.
 - (2) If an engine failure occurs during the climb to the rotation point, compliance with [CAT.POL.H.310\(b\)](#) will enable a safe landing or a safe forced landing on the deck.
 - (3) If an engine failure occurs between the rotation point and the DPATO, compliance with [CAT.POL.H.310\(b\)](#) will enable a safe forced landing on the surface, clearing the deck edge.
 - (4) At or after the DPATO, the OEI flight path should clear all obstacles by the margins specified in [CAT.POL.H.315](#).

Figure 1

Typical take-off profile PC2 from a helideck/elevated FATO, non-hostile environment

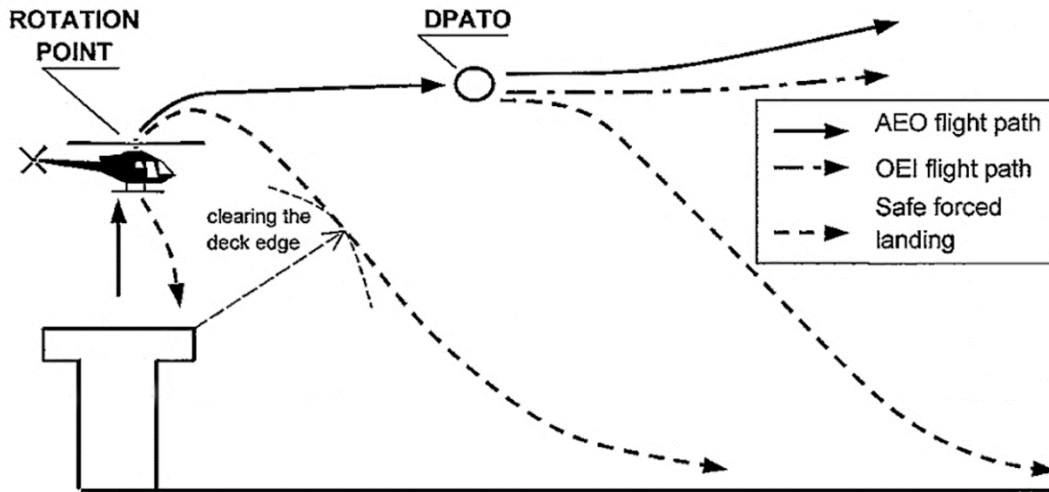

(d) Take-off — non-hostile environment (with exposure time) [CAT.POL.H.310\(c\)](#)

- (1) Figure 2 shows a typical take-off profile for performance class 2 operations from a helideck or an elevated FATO in a non-hostile environment (with exposure time).
- (2) If an engine failure occurs after the exposure time and before DPATO, compliance with CAT.POL.H.310(c) will enable a safe forced landing on the surface.
- (3) At or after the DPATO, the OEI flight path should clear all obstacles by the margins specified in [CAT.POL.H.315](#).

Figure 2

Typical take-off profile PC2 from a helideck/elevated FATO with exposure time, non-hostile environment

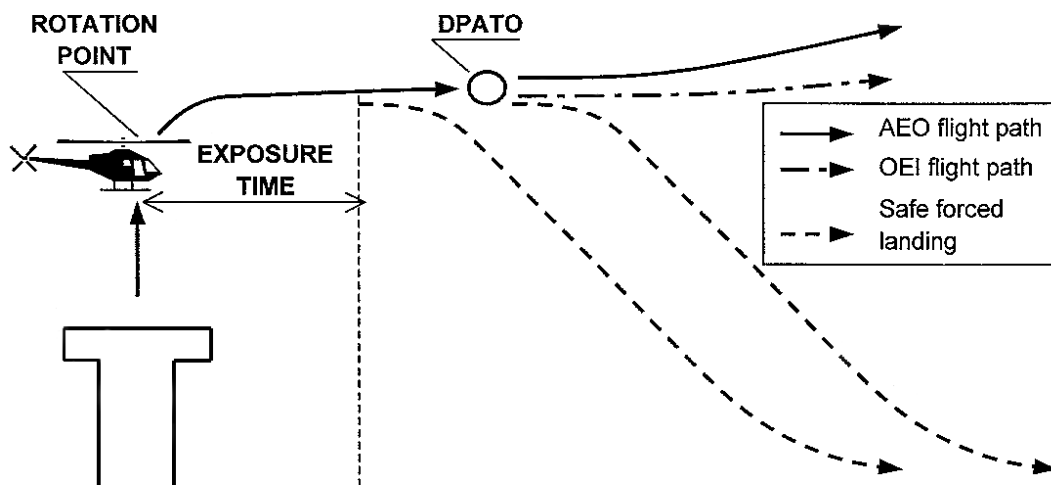

- (e) Take-off — non-congested hostile environment (with exposure time) [CAT.POL.H.310\(c\)](#)
 - (1) Figure 3 shows a typical take off profile for performance class 2 operations from a helideck or an elevated FATO in a non-congested hostile environment (with exposure time).
 - (2) If an engine failure occurs after the exposure time, the helicopter is capable of a safe forced landing or safe continuation of the flight.
 - (3) At or after the DPATO, the OEI flight path should clear all obstacles by the margins specified in [CAT.POL.H.315](#).

Figure 3

Typical take-off profile PC2 from a helideck/elevated FATO, non-congested hostile environment

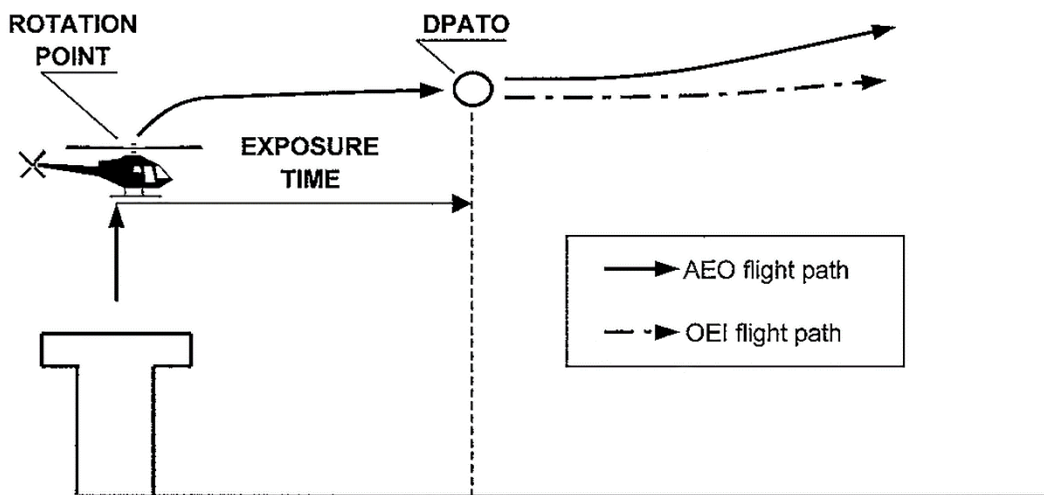

- (f) Landing — non-hostile environment (without an approval to operate with an exposure time) [CAT.POL.H.325\(b\)](#)
 - (1) Figure 4 shows a typical landing profile for performance class 2 operations to a helideck or an elevated FATO in a non-hostile environment.
 - (2) The DPBL is defined as a ‘window’ in terms of airspeed, rate of descent, and height above the landing surface. If an engine failure occurs before the DPBL, the pilot may elect to land or to execute a balked landing.
 - (3) In the event of an engine failure being recognised after the DPBL and before the committal point, compliance with CAT.POL.H.325(b) will enable a safe forced landing on the surface.
 - (4) In the event of an engine failure at or after the committal point, compliance with CAT.POL.H.325(b) will enable a safe forced landing on the deck.

Figure 4

Typical landing profile PC2 to a helideck/elevated FATO, non-hostile environment

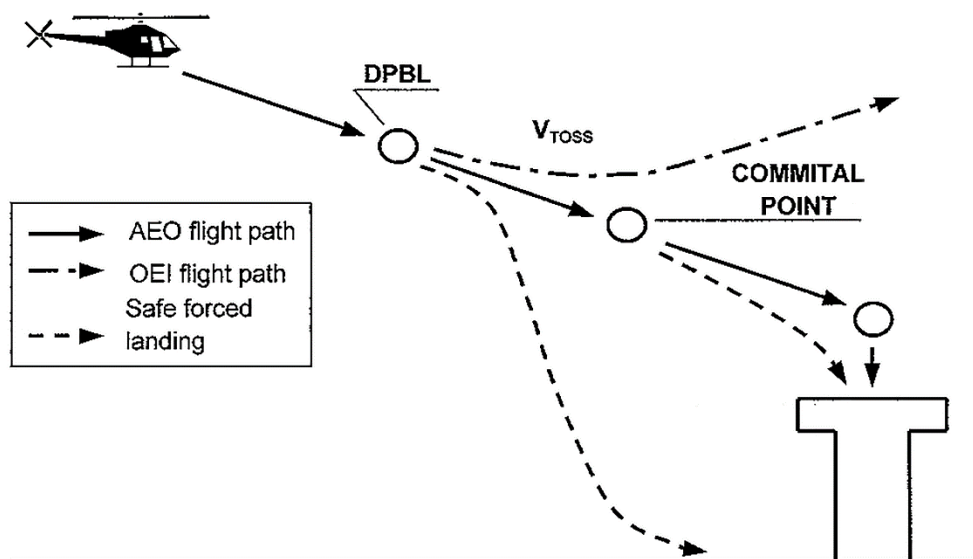

(g) Landing — non-hostile environment (with exposure time) [CAT.POL.H.325\(c\)](#)

- (1) Figure 5 shows a typical landing profile for performance class 2 operations to a helideck or an elevated FATO in a non-hostile environment (with exposure time).
- (2) The DPBL is defined as a 'window' in terms of airspeed, rate of descent, and height above the landing surface. If an engine failure occurs before the DPBL, the pilot may elect to land or to execute a bailed landing.
- (3) In the event of an engine failure being recognised before the exposure time, compliance with CAT.POL.H.325(c) will enable a safe forced landing on the surface.
- (4) In the event of an engine failure after the exposure time, compliance with CAT.POL.H.325(c) will enable a safe forced landing on the deck.

Figure 5

Typical landing profile PC2 to a helideck/elevated FATO with exposure time, non-hostile environment

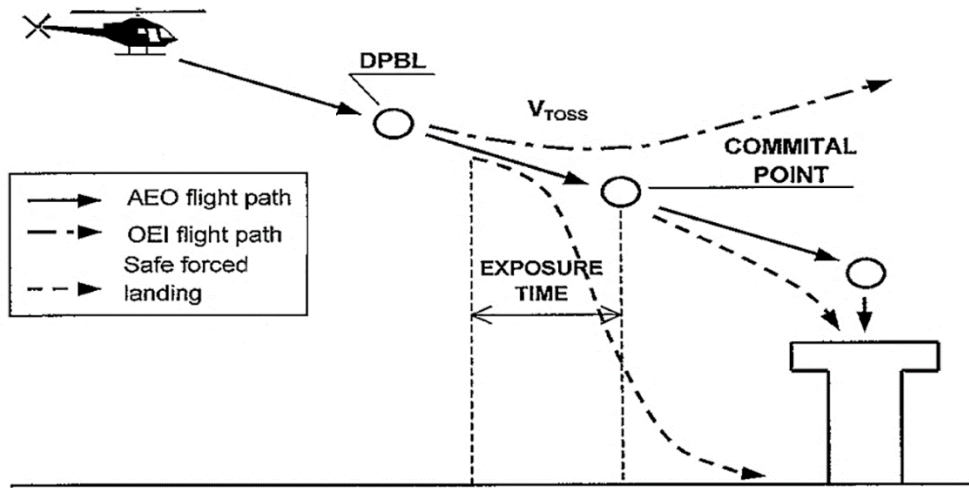

(h) Landing — non-congested hostile environment (with exposure time) [CAT.POL.H.325\(c\)](#)

- (1) Figure 6 shows a typical landing profile for performance class 2 operations to a helideck or an elevated FATO in a non-congested hostile environment (with exposure time).
- (2) In the event of an engine failure at any point during the approach and landing phase up to the start of exposure time, compliance with CAT.POL.H.325(b) will enable the helicopter, after clearing all obstacles under the flight path, to continue the flight.
- (3) In the event of an engine failure after the exposure time (i.e. at or after the committal point), a safe forced landing should be possible on the deck.

Figure 6

Typical landing profile PC2 to a helideck/elevated FATO with exposure time, non-congested hostile environment

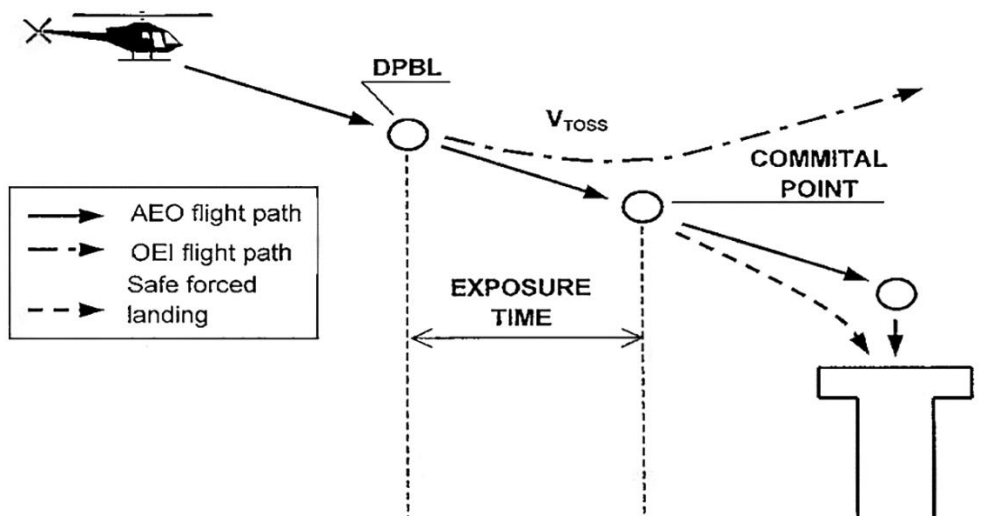

CHAPTER 4 – PERFORMANCE CLASS 3

CAT.POL.H.400 General

Regulation (EU) No 965/2012

- (a) Helicopters operated in performance class 3 shall be certified in category A or equivalent as determined by the Agency, or category B.
- (b) Operations shall only be conducted in a non-hostile environment, except:
 - (1) when operating in accordance with [CAT.POL.H.420](#); or
 - (2) for the take-off and landing phase, when operating in accordance with (c).
- (c) Provided the operator is approved in accordance with [CAT.POL.H.305](#), operations may be conducted to/from an aerodrome or operating site located outside a congested hostile environment without an assured safe forced landing capability:
 - (1) during take-off, before reaching V_y (speed for best rate of climb) or 200 ft above the take-off surface; or
 - (2) during landing, below 200 ft above the landing surface.
- (d) Operations shall not be conducted:
 - (1) out of sight of the surface;
 - (2) at night;
 - (3) when the ceiling is less than 600 ft; or
 - (4) when the visibility is less than 800 m.

GM1 CAT.POL.H.400(c) General

ED Decision 2022/012/R

THE TAKE-OFF AND LANDING PHASES (PERFORMANCE CLASS 3)

- (a) To understand the use of ground level exposure in performance class 3, it is important first to be aware of the logic behind the use of ‘take-off and landing phases’. Once this is clear, it is easier to appreciate the aspects and limits of the use of ground level exposure. This GM shows the derivation of the term from the ICAO definition of the ‘en-route phase’ and then gives practical examples of the use, and limitations on the use, of ground level exposure in CAT.POL.400(c).
- (b) The take-off phase in performance class 1 and performance class 2 may be considered to be bounded by ‘the specified point in the take-off’ from which the take-off flight path begins.
 - (1) In performance class 1, this specified point is defined as ‘the end of the take-off distance required’.
 - (2) In performance class 2, this specified point is defined as DPATO or, as an alternative, no later than 200 ft above the take-off surface.
 - (3) There is no simple equivalent point for bounding of the landing in performance classes 1 & 2.
- (c) Take-off flight path is not used in performance class 3 and, consequently, the term ‘take-off and landing phases’ is used to bound the limit of exposure. For the purpose of performance class 3,

the take-off and landing phases are as set out in [CAT.POL.H.400\(c\)](#) and are considered to be bounded by:

- (1) during take-off before reaching V_y (speed for best rate of climb) or 200 ft above the take-off surface; and
- (2) during landing, below 200 ft above the landing surface.

(ICAO Annex 6 Part III, defines en-route phase as being ‘That part of the flight from the end of the take-off and initial climb phase to the commencement of the approach and landing phase.’ The use of take-off and landing phase in this text is used to distinguish the take-off from the initial climb, and the landing from the approach: they are considered to be complementary and not contradictory.)

- (d) Ground level exposure — and exposure for elevated FATOs or helidecks in a non-hostile environment — is permitted for operations under an approval in accordance with [CAT.POL.H.305](#). Exposure in this case is limited to the ‘take-off and landing phases’.

The practical effect of bounding of exposure can be illustrated with the following examples:

- (1) A clearing: the operator may consider a take-off/landing in a clearing when there is sufficient power, with all engines operating, to clear all obstacles in the take-off path by an adequate margin (this, in ICAO, is meant to indicate 35 ft). Thus, the clearing may be bounded by bushes, fences, wires and, in the extreme, by power lines, high trees, etc. Once the obstacle has been cleared, by using a steep or a vertical climb (which itself may infringe the height velocity (HV) diagram), the helicopter reaches V_y or 200 ft, and from that point a safe forced landing must be possible. The effect is that whilst operation to a clearing is possible, operation to a clearing in the middle of a forest is not (except when operated in accordance with [CAT.POL.H.420](#)).
 - (2) An aerodrome/operating site surrounded by rocks: the same applies when operating to a landing site that is surrounded by rocky ground. Once V_y or 200 ft has been reached, a safe forced landing must be possible.
 - (3) An elevated FATO or helideck: when operating to an elevated FATO or helideck in performance class 3, exposure is considered to be twofold: firstly, to a deck-edge strike if the engine fails after the decision to transition has been taken; and secondly, to operations in the HV diagram due to the height of the FATO or helideck. Once the take-off surface has been cleared and the helicopter has reached the knee of the HV diagram, the helicopter should be capable of making a safe forced landing.
- (e) Operation in accordance with [CAT.POL.400\(b\)](#) does not permit excursions into a hostile environment as such and is specifically concerned with the absence of space to abort the take-off or landing when the take-off and landing space are limited; or when operating in the HV diagram.
 - (f) Specifically, the use of this exception to the requirement for a safe forced landing (during take-off or landing) does not permit semi-continuous operations over a hostile environment such as a forest or hostile sea area.

CAT.POL.H.405 Take-off

Regulation (EU) No 965/2012

- (a) The take-off mass shall be the lower of:
 - (1) the MCTOM; or

- (2) the maximum take-off mass specified for a hover in ground effect with all engines operating at take-off power, or if conditions are such that a hover in ground effect is not likely to be established, the take-off mass specified for a hover out of ground effect with all engines operating at take-off power.
- (b) Except as provided in [CAT.POL.H.400\(b\)](#), in the event of an engine failure the helicopter shall be able to perform a safe forced landing.

CAT.POL.H.410 En-route

Regulation (EU) No 965/2012

- (a) The helicopter shall be able, with all engines operating within the maximum continuous power conditions, to continue along its intended route or to a planned diversion without flying at any point below the appropriate minimum flight altitude.
- (b) Except as provided in [CAT.POL.H.420](#), in the event of an engine failure the helicopter shall be able to perform a safe forced landing.

CAT.POL.H.415 Landing

Regulation (EU) No 965/2012

- (a) The landing mass of the helicopter at the estimated time of landing shall be the lower of:
 - (1) the maximum certified landing mass; or
 - (2) the maximum landing mass specified for a hover in ground effect, with all engines operating at take-off power, or if conditions are such that a hover in ground effect is not likely to be established, the landing mass for a hover out of ground effect with all engines operating at take-off power.
- (b) Except as provided in [CAT.POL.H.400\(b\)](#), in the event of an engine failure, the helicopter shall be able to perform a safe forced landing.

CAT.POL.H.420 Helicopter operations over a hostile environment located outside a congested area

Regulation (EU) No 965/2012

- (a) Operations over a non-congested hostile environment without a safe forced landing capability with turbine-powered helicopters with an MOPSC of six or less shall only be conducted if the operator has been granted an approval by the competent authority, following a safety risk assessment performed by the operator. Before such operations take place in another Member State, the operator shall obtain an endorsement from the competent authority of that State.
- (b) To obtain and maintain such approval the operator shall:
 - (1) only conduct these operations in the areas and under the conditions specified in the approval;
 - (2) not conduct these operations under a HEMS approval;
 - (3) substantiate that helicopter limitations, or other justifiable considerations, preclude the use of the appropriate performance criteria; and
 - (4) be approved in accordance with [CAT.POL.H.305\(b\)](#).

- (c) Notwithstanding [CAT.IDE.H.240](#), such operations may be conducted without supplemental oxygen equipment, provided the cabin altitude does not exceed 10 000 ft for a period in excess of 30 minutes and never exceeds 13 000 ft pressure altitude.

AMC1 CAT.POL.H.420 Helicopter operations over a hostile environment located outside a congested area

ED Decision 2014/015/R

SAFETY RISK ASSESSMENT

- (a) Introduction

Two cases that are deemed to be acceptable for the alleviation under the conditions of [CAT.POL.H.420](#) for the en-route phase of the flight (operations without an assured safe forced landing capability during take-off and landing phases are subject to a separate approval under [CAT.POL.H.400\(c\)](#)) are flights over mountainous areas and remote areas, both already having been considered by the JAA in comparison to ground transport in the case of remote areas and respectively to multi-engined helicopters in the case of mountain areas.

- (1) Remote areas

Remote area operation is acceptable when alternative surface transportation does not provide the same level of safety as helicopter transportation. In this case, the operator should demonstrate why the economic circumstances do not justify replacement of single-engined helicopters by multi-engined helicopters.

- (2) Mountainous areas

Current generation twin-engined helicopters may not be able to meet the performance class 1 or 2 requirements at the operational altitude; consequently, the outcome of an engine failure is the same as a single-engined helicopter. In this case, the operator should justify the use of exposure in the en-route phase.

- (b) Other areas of operation

For other areas of operations to be considered for the operational approval, a risk assessment should be conducted by the operator that should, at least, consider the following factors:

- (1) type of operations and the circumstances of the flight;
- (2) area/terrain over which the flight is being conducted;
- (3) probability of an engine failure and the consequence of such an event;
- (4) safety target;
- (5) procedures to maintain the reliability of the engine(s);
- (6) installation and utilisation of a usage monitoring system; and
- (7) when considered relevant, any available publications on (analysis of) accident or other safety data.

GM1 CAT.POL.H.420 Helicopter operations over a hostile environment located outside a congested area

ED Decision 2014/015/R

EXAMPLE OF A SAFETY RISK ASSESSMENT

(a) Introduction

Where it can be substantiated that helicopter limitations, or other justifiable considerations, preclude the use of appropriate performance, the approval effectively alleviates from compliance with the requirement in [CAT.OP.MPA.137](#), that requires the availability of surfaces that permit a safe forced landing to be executed.

Circumstances where an engine failure will result in a catastrophic event are those defined for a hostile environment:

- (1) a lack of adequate surfaces to perform a safe landing;
- (2) the inability to protect the occupants of the helicopter from the elements; or
- (3) a lack of search and rescue services to provide rescue consistent with the expected survival time in such environment.

(b) The elements of the risk assessment

The risk assessment process consists of the application of three principles:

- a safety target;
- a helicopter reliability assessment; and
- continuing airworthiness.

(1) The safety target

The main element of the risk assessment when exposure was initially introduced by the JAA into JAR-OPS 3 (NPA OPS-8), was the assumption that turbine engines in helicopters would have failure rates of about 1:100 000 per flying hour — which would permit (against the agreed safety target of 5×10^{-8} per event) an exposure of about 9 seconds for twin-engined helicopters and 18 seconds for single-engined helicopters during the take-off or landing event.

An engine failure in the en-route phase over a hostile environment will inevitably result in a higher risk (in the order of magnitude of 1×10^{-5} per flying hour) to a catastrophic event.

The approval to operate with this high risk of endangering the helicopter occupants should, therefore, only be granted against a comparative risk assessment (i.e. compared to other means of transport, the risk is demonstrated to be lower), or where there is no economic justification to replace single-engined helicopters by multi-engined helicopters.

(2) The reliability assessment

The purpose of the reliability assessment is to ensure that the engine reliability remains at or better than 1×10^{-5} .

(3) Continuing airworthiness

Mitigating procedures consist of a number of elements:

- (i) the fulfilment of all manufacturers' safety modifications;

- (ii) a comprehensive reporting system (both failures and usage data); and
- (iii) the implementation of a usage monitoring system (UMS).

Each of these elements is to ensure that engines, once shown to be sufficiently reliable to meet the safety target, will sustain such reliability (or improve upon it).

The monitoring system is felt to be particularly important as it had already been demonstrated that when such systems are in place, it inculcates a more considered approach to operations. In addition, the elimination of 'hot starts', prevented by the UMS, itself minimises the incidents of turbine burst failures.

GM2 CAT.POL.H.420(a) Helicopter operations over a hostile environment located outside a congested area

ED Decision 2014/015/R

ENDORSEMENT FROM ANOTHER STATE

- (a) Application to another State

To obtain an endorsement from another State, the operator should submit to that State the safety risk assessment and the reasons and justification that preclude the use of appropriate performance criteria, over those hostile areas outside a congested area over which the operator is planning to conduct operations.

- (b) Endorsement from another State

Upon receiving the endorsement from another State, the operator should submit it together with the safety risk assessment and the reasons and justification that preclude the use of appropriate performance criteria, to the competent authority issuing the AOC to obtain the approval or extend the existing approval to a new area.

SECTION 3 – MASS AND BALANCE

CHAPTER 1 – MOTOR-POWERED AIRCRAFT

CAT.POL.MAB.100 Mass and balance, loading

Regulation (EU) No 965/2012

- (a) During any phase of operation, the loading, mass and centre of gravity (CG) of the aircraft shall comply with the limitations specified in the AFM, or the operations manual if more restrictive.
- (b) The operator shall establish the mass and the CG of any aircraft by actual weighing prior to initial entry into service and thereafter at intervals of four years if individual aircraft masses are used, or nine years if fleet masses are used. The accumulated effects of modifications and repairs on the mass and balance shall be accounted for and properly documented. Aircraft shall be reweighed if the effect of modifications on the mass and balance is not accurately known.
- (c) The weighing shall be accomplished by the manufacturer of the aircraft or by an approved maintenance organisation.
- (d) The operator shall determine the mass of all operating items and crew members included in the aircraft dry operating mass by weighing or by using standard masses. The influence of their position on the aircraft's CG shall be determined.

- (e) The operator shall establish the mass of the traffic load, including any ballast, by actual weighing or by determining the mass of the traffic load in accordance with standard passenger and baggage masses.
- (f) In addition to standard masses for passengers and checked baggage, the operator can use standard masses for other load items, if it demonstrates to the competent authority that these items have the same mass or that their masses are within specified tolerances.
- (g) The operator shall determine the mass of the fuel load by using the actual density or, if not known, the density calculated in accordance with a method specified in the operations manual.
- (h) The operator shall ensure that the loading of:
 - (1) its aircraft is performed under the supervision of qualified personnel; and
 - (2) traffic load is consistent with the data used for the calculation of the aircraft mass and balance.
- (i) The operator shall comply with additional structural limits such as the floor strength limitations, the maximum load per running metre, the maximum mass per cargo compartment and the maximum seating limit. For helicopters, in addition, the operator shall take account of in-flight changes in loading.
- (j) The operator shall specify, in the operations manual, the principles and methods involved in the loading and in the mass and balance system that meet the requirements contained in (a) to (i). This system shall cover all types of intended operations.

AMC1 CAT.POL.MAB.100(a) Mass and balance, loading

ED Decision 2014/015/R

CENTRE OF GRAVITY LIMITS — OPERATIONAL CG ENVELOPE AND IN-FLIGHT CG

In the Certificate Limitations section of the AFM, forward and aft CG limits are specified. These limits ensure that the certification stability and control criteria are met throughout the whole flight and allow the proper trim setting for take-off. The operator should ensure that these limits are respected by:

- (a) Defining and applying operational margins to the certified CG envelope in order to compensate for the following deviations and errors:
 - (1) Deviations of actual CG at empty or operating mass from published values due, for example, to weighing errors, unaccounted modifications and/or equipment variations.
 - (2) Deviations in fuel distribution in tanks from the applicable schedule.
 - (3) Deviations in the distribution of baggage and cargo in the various compartments as compared with the assumed load distribution as well as inaccuracies in the actual mass of baggage and cargo.
 - (4) Deviations in actual passenger seating from the seating distribution assumed when preparing the mass and balance documentation. Large CG errors may occur when 'free seating', i.e. freedom of passengers to select any seat when entering the aircraft, is permitted. Although in most cases reasonably even longitudinal passenger seating can be expected, there is a risk of an extreme forward or aft seat selection causing very large and unacceptable CG errors, assuming that the balance calculation is done on the basis of an assumed even distribution. The largest errors may occur at a load factor of approximately 50% if all passengers are seated in either the forward or aft half of the

cabin. Statistical analysis indicates that the risk of such extreme seating adversely affecting the CG is greatest on small aircraft.

- (5) Deviations of the actual CG of cargo and passenger load within individual cargo compartments or cabin sections from the normally assumed mid position.
 - (6) Deviations of the CG caused by gear and flap positions and by application of the prescribed fuel usage procedure, unless already covered by the certified limits.
 - (7) Deviations caused by in-flight movement of cabin crew, galley equipment and passengers.
 - (8) On small aeroplanes, deviations caused by the difference between actual passenger masses and standard passenger masses when such masses are used.
- (b) Defining and applying operational procedures in order to:
- (1) ensure an even distribution of passengers in the cabin;
 - (2) take into account any significant CG travel during flight caused by passenger/crew movement; and
 - (3) take into account any significant CG travel during flight caused by fuel consumption/transfer.

AMC1 CAT.POL.MAB.100(b) Mass and balance, loading

ED Decision 2014/015/R

WEIGHING OF AN AIRCRAFT

- (a) New aircraft that have been weighed at the factory may be placed into operation without reweighing if the mass and balance records have been adjusted for alterations or modifications to the aircraft. Aircraft transferred from one EU operator to another EU operator do not have to be weighed prior to use by the receiving operator unless more than 4 years have elapsed since the last weighing.
- (b) The mass and centre of gravity (CG) position of an aircraft should be revised whenever the cumulative changes to the dry operating mass exceed $\pm 0.5\%$ of the maximum landing mass or, for aeroplanes, the cumulative change in CG position exceeds 0.5% of the mean aerodynamic chord. This may be done by weighing the aircraft or by calculation. If the AFM requires to record changes to mass and CG position below these thresholds, or to record changes in any case, and make them known to the commander, mass and CG position should be revised accordingly and made known to the commander.
- (c) When weighing an aircraft, normal precautions should be taken consistent with good practices such as:
 - (1) checking for completeness of the aircraft and equipment;
 - (2) determining that fluids are properly accounted for;
 - (3) ensuring that the aircraft is clean; and
 - (4) ensuring that weighing is accomplished in an enclosed building.
- (d) Any equipment used for weighing should be properly calibrated, zeroed, and used in accordance with the manufacturer's instructions. Each scale should be calibrated either by the manufacturer, by a civil department of weights and measures or by an appropriately authorised organisation within two years or within a time period defined by the manufacturer of the

weighing equipment, whichever is less. The equipment should enable the mass of the aircraft to be established accurately. One single accuracy criterion for weighing equipment cannot be given. However, the weighing accuracy is considered satisfactory if the accuracy criteria in Table 1 are met by the individual scales/cells of the weighing equipment used:

Table 1

Accuracy criteria for weighing equipment

For a scale/cell load	An accuracy of
below 2 000 kg	±1 %
from 2 000 kg to 20 000 kg	±20 kg
above 20 000 kg	±0.1 %

AMC2 CAT.POL.MAB.100(b) Mass and balance, loading

ED Decision 2014/015/R

FLEET MASS AND CG POSITION — AEROPLANES

- (a) For a group of aeroplanes of the same model and configuration, an average dry operating mass and CG position may be used as the fleet mass and CG position, provided that:
 - (1) the dry operating mass of an individual aeroplane does not differ by more than ±0.5 % of the maximum structural landing mass from the established dry operating fleet mass; or
 - (2) the CG position of an individual aeroplane does not differ by more than ±0.5 % of the mean aerodynamic chord from the established fleet CG.
- (b) The operator should verify that, after an equipment or configuration change or after weighing, the aeroplane falls within the tolerances above.
- (c) To add an aeroplane to a fleet operated with fleet values, the operator should verify by weighing or calculation that its actual values fall within the tolerances specified in (a)(1) and (2).
- (d) To obtain fleet values, the operator should weigh, in the period between two fleet mass evaluations, a certain number of aeroplanes as specified in Table 1, where 'n' is the number of aeroplanes in the fleet using fleet values. Those aeroplanes in the fleet that have not been weighed for the longest time should be selected first.

Table 1

Minimum number of weighings to obtain fleet values

Number of aeroplanes in the fleet	Minimum number of weighings
2 or 3	n
4 to 9	(n + 3)/2
10 or more	(n + 51)/10

- (e) The interval between two fleet mass evaluations should not exceed 48 months.
- (f) The fleet values should be updated at least at the end of each fleet mass evaluation.
- (g) Aeroplanes that have not been weighed since the last fleet mass evaluation may be kept in a fleet operated with fleet values, provided that the individual values are revised by calculation and stay within the tolerances above. If these individual values no longer fall within the

tolerances, the operator should determine new fleet values or operate aeroplanes not falling within the limits with their individual values.

- (h) If an individual aeroplane mass is within the dry operating fleet mass tolerance but its CG position exceeds the tolerance, the aeroplane may be operated under the applicable dry operating fleet mass but with an individual CG position.
- (i) Aeroplanes for which no mean aerodynamic chord has been published, should be operated with their individual mass and CG position values. They may be operated under the dry operating fleet mass and CG position, provided that a risk assessment has been completed.

AMC1 CAT.POL.MAB.100(d) Mass and balance, loading

ED Decision 2014/015/R

DRY OPERATING MASS

The dry operating mass includes:

- (a) crew and crew baggage;
- (b) catering and removable passenger service equipment; and
- (c) tank water and lavatory chemicals.

AMC2 CAT.POL.MAB.100(d) Mass and balance, loading

ED Decision 2014/015/R

MASS VALUES FOR CREW MEMBERS

- (a) The operator should use the following mass values for crew to determine the dry operating mass:
 - (1) actual masses including any crew baggage; or
 - (2) standard masses, including hand baggage, of 85 kg for flight crew/technical crew members and 75 kg for cabin crew members.
- (b) The operator should correct the dry operating mass to account for any additional baggage. The position of this additional baggage should be accounted for when establishing the centre of gravity of the aeroplane.

AMC1 CAT.POL.MAB.100(e) Mass and balance, loading

ED Decision 2021/005/R

MASS VALUES FOR PASSENGERS AND BAGGAGE

- (a) When the number of passenger seats available is:
 - (1) less than 10 for aeroplanes; or
 - (2) less than 6 for helicopters,

passenger mass may be calculated on the basis of a statement by, or on behalf of, each passenger, adding to it a predetermined mass to account for hand baggage and clothing.

The predetermined mass for hand baggage and clothing should be established by the operator on the basis of studies relevant to his particular operation. In any case, it should not be less than:

- (1) 4 kg for clothing; and
- (2) 6 kg for hand baggage.

The passengers' stated mass and the mass of passengers' clothing and hand baggage should be checked prior to boarding and adjusted, if necessary. The operator should establish a procedure in the operations manual when to select actual or standard masses and the procedure to be followed when using verbal statements.

- (b) When determining the actual mass by weighing, passengers' personal belongings and hand baggage should be included. Such weighing should be conducted immediately prior to boarding the aircraft.
- (c) When determining the mass of passengers by using standard mass values, the standard mass values in Tables 1 and 2 below should be used. The standard masses include hand baggage and the mass of any infant carried by an adult on one passenger seat. Infants occupying separate passenger seats should be considered as children for the purpose of this AMC. When the total number of passenger seats available on an aircraft is 20 or more, the standard masses for males and females in Table 1 should be used. As an alternative, in cases where the total number of passenger seats available is 30 or more, the 'All Adult' mass values in Table 1 may be used.

Table 1

Standard masses for passengers — aircraft with a total number of passenger seats of 20 or more

Passenger seats:	20 and more		30 and more
	Male	Female	All adult
All flights except holiday charters	88 kg	70 kg	84 kg
Holiday charters(*)	83 kg	69 kg	76 kg
Children	35 kg	35 kg	35 kg

- (*) Holiday charter means a charter flight that is part of a holiday travel package. On such flights the entire passenger capacity is hired by one or more charterer(s) for the carriage of passengers who are travelling, all or in part by air, on a round- or circle-trip basis for holiday purposes. The holiday charter mass values apply provided that not more than 5 % of passenger seats installed in the aircraft are used for the non-revenue carriage of certain categories of passengers. Categories of passengers such as company personnel, tour operators' staff, representatives of the press, authority officials, etc. can be included within the 5% without negating the use of holiday charter mass values.

Table 2

Standard masses for passengers — aircraft with a total number of passenger seats of 19 or less

Passenger seats:	1 - 5	6 - 9	10 - 19
Male	104 kg	96 kg	92 kg
Female	86 kg	78 kg	74 kg
Children	35 kg	35 kg	35 kg

- (1) On aeroplane flights with 19 passenger seats or less and all helicopter flights where no hand baggage is carried in the cabin or where hand baggage is accounted for separately, 6 kg may be deducted from male and female masses in Table 2. Articles such as an overcoat, an umbrella, a small handbag or purse, reading material or a small camera are not considered as hand baggage.

- (2) For helicopter operations in which a survival suit is provided to passengers, 3 kg should be added to the passenger mass value.
- (d) Mass values for baggage
- (1) Aeroplanes. When the total number of passenger seats available on the aeroplane is 20 or more, the standard mass values for checked baggage of Table 3 should be used.
- (2) Helicopters. When the total number of passenger seats available on the helicopters is 20 or more, the standard mass value for checked baggage should be 13 kg.
- (3) For aircraft with 19 passenger seats or less, the actual mass of checked baggage should be determined by weighing.

Table 3

Standard masses for baggage — aeroplanes with a total number of passenger seats of 20 or more

Type of flight	Baggage standard mass
Domestic	11 kg
Within the European region	13 kg
Intercontinental	15 kg
All other	13 kg

- (4) For the purpose of Table 3:
- (i) domestic flight means a flight with origin and destination within the borders of one State;
- (ii) flights within the European region mean flights, other than domestic flights, whose origin and destination are within the area specified in (d)(5); and
- (iii) intercontinental flight means flights beyond the European region with origin and destination in different continents.
- (5) Flights within the European region are flights conducted within the following area:
- | | | |
|---|-------|--------|
| — | N7200 | E04500 |
| — | N4000 | E04500 |
| — | N3500 | E03700 |
| — | N3000 | E03700 |
| — | N3000 | W00600 |
| — | N2700 | W00900 |
| — | N2700 | W03000 |
| — | N6700 | W03000 |
| — | N7200 | W01000 |
| — | N7200 | E04500 |
- as depicted in Figure 1.

Figure 1

The European region

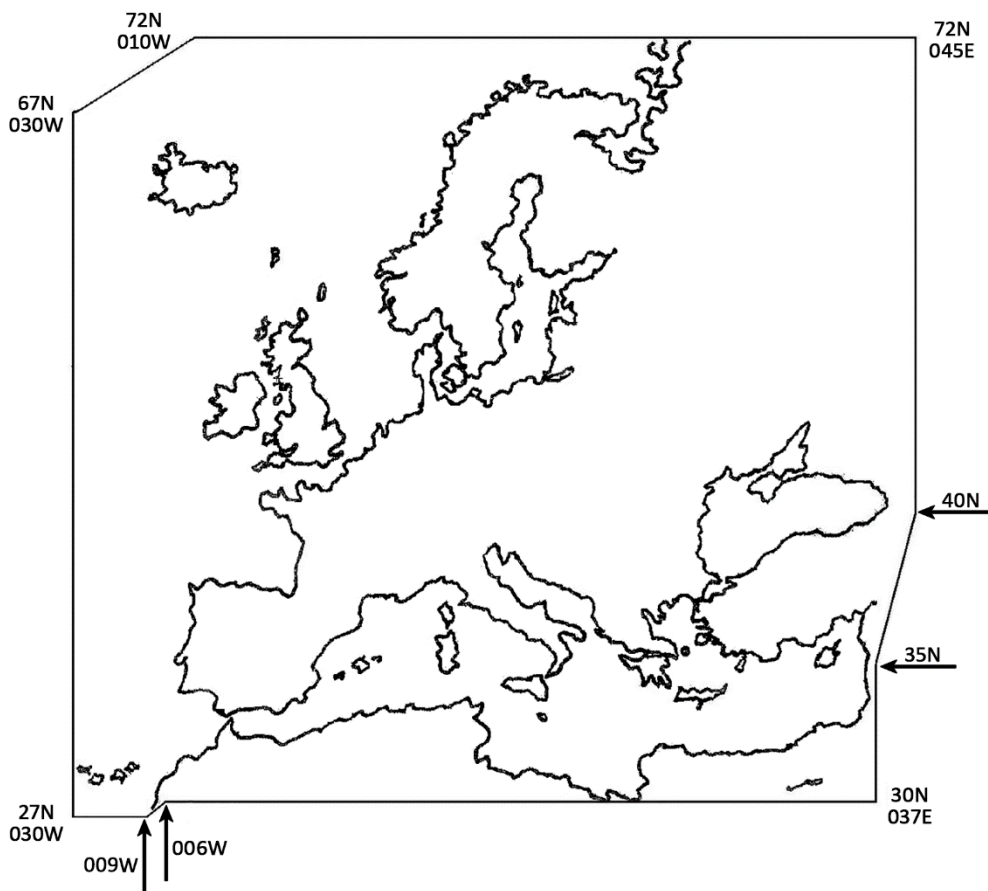

- (e) Other standard masses may be used provided they are calculated on the basis of a detailed weighing survey plan and a reliable statistical analysis method is applied. The operator should advise the competent authority about the intent of the passenger weighing survey and explain the survey plan in general terms. The revised standard mass values should only be used in circumstances comparable with those under which the survey was conducted. Where the revised standard masses exceed those in Tables 1, 2 and 3 of, then such higher values should be used.
- (f) On any flight identified as carrying a significant number of passengers whose masses, including hand baggage, are expected to significantly deviate from the standard passenger mass, the operator should determine the actual mass of such passengers by weighing or by adding an adequate mass increment.
- (g) If standard mass values for checked baggage are used and a significant number of passengers checked baggage is expected to significantly deviate from the standard baggage mass, the operator should determine the actual mass of such baggage by weighing or by adding an adequate mass increment.

AMC2 CAT.POL.MAB.100(e) Mass and balance, loading

ED Decision 2014/015/R

PROCEDURE FOR ESTABLISHING REVISED STANDARD MASS VALUES FOR PASSENGERS AND BAGGAGE

- (a) Passengers
- (1) Weight sampling method. The average mass of passengers and their hand baggage should be determined by weighing, taking random samples. The selection of random samples should by nature and extent be representative of the passenger volume, considering the type of operation, the frequency of flights on various routes, in/outbound flights, applicable season and seat capacity of the aircraft.
 - (2) Sample size. The survey plan should cover the weighing of at least the greatest of:
 - (i) a number of passengers calculated from a pilot sample, using normal statistical procedures and based on a relative confidence range (accuracy) of 1 % for all adult and 2 % for separate male and female average masses; and
 - (ii) for aircraft:
 - (A) with a passenger seating capacity of 40 or more, a total of 2 000 passengers; or
 - (B) with a passenger seating capacity of less than 40, a total number of 50 multiplied by the passenger seating capacity.
 - (3) Passenger masses. Passenger masses should include the mass of the passengers' belongings that are carried when entering the aircraft. When taking random samples of passenger masses, infants should be weighted together with the accompanying adult.
 - (4) Weighing location. The location for the weighing of passengers should be selected as close as possible to the aircraft, at a point where a change in the passenger mass by disposing of or by acquiring more personal belongings is unlikely to occur before the passengers board the aircraft.
 - (5) Weighing machine. The weighing machine used for passenger weighing should have a capacity of at least 150 kg. The mass should be displayed at minimum graduations of 500 g. The weighing machine should have an accuracy of at least 0.5 % or 200 g, whichever is greater.
 - (6) Recording of mass values. For each flight included in the survey the mass of the passengers, the corresponding passenger category (i.e. male/female/children) and the flight number should be recorded.
- (b) Checked baggage. The statistical procedure for determining revised standard baggage mass values based on average baggage masses of the minimum required sample size should comply with (a)(1) and (a)(2). For baggage, the relative confidence range (accuracy) should amount to 1 %. A minimum of 2 000 pieces of checked baggage should be weighed.
- (c) Determination of revised standard mass values for passengers and checked baggage
- (1) To ensure that, in preference to the use of actual masses determined by weighing, the use of revised standard mass values for passengers and checked baggage does not adversely affect operational safety, a statistical analysis should be carried out. Such an analysis should generate average mass values for passengers and baggage as well as other data.

- (2) On aircraft with 20 or more passenger seats, these averages apply as revised standard male and female mass values.
- (3) On aircraft with 19 passenger seats or less, the increments in Table 1 should be added to the average passenger mass to obtain the revised standard mass values.

Table 1

Increments for revised standard masses values

Number of passenger seats	Required mass increment
1 – 5 incl.	16 kg
6 – 9 incl.	8 kg
10 – 19 incl.	4 kg

Alternatively, all adult revised standard (average) mass values may be applied on aircraft with 30 or more passenger seats. Revised standard (average) checked baggage mass values are applicable to aircraft with 20 or more passenger seats.

- (4) The revised standard masses should be reviewed at intervals not exceeding 5 years.
- (5) All adult revised standard mass values should be based on a male/female ratio of 80/20 in respect of all flights except holiday charters that are 50/50. A different ratio on specific routes or flights may be used, provided supporting data shows that the alternative male/female ratio is conservative and covers at least 84 % of the actual male/female ratios on a sample of at least 100 representative flights.
- (6) The resulting average mass values should be rounded to the nearest whole number in kg. Checked baggage mass values should be rounded to the nearest 0.5 kg figure, as appropriate.
- (7) When operating on similar routes or networks, operators may pool their weighing surveys provided that in addition to the joint weighing survey results, results from individual operators participating in the joint survey are separately indicated in order to validate the joint survey results.

GM1 CAT.POL.MAB.100(e) Mass and balance, loading

ED Decision 2014/015/R

ADJUSTMENT OF STANDARD MASSES

When standard mass values are used, [AMC1 CAT.POL.MAB.100\(e\)](#) subparagraph (g) states that the operator should identify and adjust the passenger and checked baggage masses in cases where significant numbers of passengers or quantities of baggage are suspected of significantly deviating from the standard values. Therefore, the operations manual should contain instructions to ensure that:

- (a) check-in, operations and cabin staff and loading personnel report or take appropriate action when a flight is identified as carrying a significant number of passengers whose masses, including hand baggage, are expected to significantly deviate from the standard passenger mass, and/or groups of passengers carrying exceptionally heavy baggage (e.g. military personnel or sports teams); and
- (b) on small aircraft, where the risks of overload and/or CG errors are the greatest, pilots pay special attention to the load and its distribution and make proper adjustments.

GM2 CAT.POL.MAB.100(e) Mass and Balance, Loading

ED Decision 2015/007/R

STATISTICAL EVALUATION OF PASSENGERS AND BAGGAGE DATA

(a) Sample size

- (1) For calculating the required sample size, it is necessary to make an estimate of the standard deviation on the basis of standard deviations calculated for similar populations or for preliminary surveys. The precision of a sample estimate is calculated for 95 % reliability or 'significance', i.e. there is a 95 % probability that the true value falls within the specified confidence interval around the estimated value. This standard deviation value is also used for calculating the standard passenger mass.
- (2) As a consequence, for the parameters of mass distribution, i.e. mean and standard deviation, three cases have to be distinguished:
 - (i) μ, σ = the true values of the average passenger mass and standard deviation, which are unknown and which are to be estimated by weighing passenger samples.
 - (ii) μ', σ' = the 'a priori' estimates of the average passenger mass and the standard deviation, i.e. values resulting from an earlier survey, which are needed to determine the current sample size.
 - (iii) \bar{x}, s = the estimates for the current true values of μ and σ , calculated from the sample.

The sample size can then be calculated using the following formula:

$$n \geq \frac{(1.96 * \sigma' * 100)^2}{(e_r' * \mu')^2}$$

where:

n = number of passengers to be weighed (sample size)

e_r' = allowed relative confidence range (accuracy) for the estimate of μ by \bar{x} (see also equation in (c)). The allowed relative confidence range specifies the accuracy to be achieved when estimating the true mean. For example, if it is proposed to estimate the true mean to within ± 1 %, then e_r' will be 1 in the above formula.

1.96 = value from the Gaussian distribution for 95 % significance level of the resulting confidence interval.

- (b) Calculation of average mass and standard deviation. If the sample of passengers weighed is drawn at random, then the arithmetic mean of the sample (\bar{x}) is an unbiased estimate of the true average mass (μ) of the population.

- (1) Arithmetic mean of sample where:

$$\bar{x} = \frac{\sum_{j=1}^n x_j}{n}$$

x_j = mass values of individual passengers (sampling units).

(2) Standard deviation where:

$$S = \sqrt{\frac{\sum_{j=1}^n (x_j - \bar{x})^2}{n - 1}}$$

$x_j - \bar{x}$ = deviation of the individual value from the sample mean.

(c) Checking the accuracy of the sample mean. The accuracy (confidence range) which can be ascribed to the sample mean as an indicator of the true mean is a function of the standard deviation of the sample which has to be checked after the sample has been evaluated. This is done using the formula:

$$e_r = \frac{1.96 * S * 100}{\sqrt{n} * \bar{x}} (\%)$$

whereby e_r should not exceed 1 % for an all adult average mass and 2 % for an average male and/or female mass. The result of this calculation gives the relative accuracy of the estimate of μ at the 95 % significance level. This means that with 95 % probability, the true average mass μ lies within the interval:

$$\bar{x} \pm \frac{1.96 * S}{\sqrt{n}}$$

(d) Example of determination of the required sample size and average passenger mass

(1) Introduction. Standard passenger mass values for mass and balance purposes require passenger weighing programs to be carried out. The following example shows the various steps required for establishing the sample size and evaluating the sample data. It is provided primarily for those who are not well versed in statistical computations. All mass figures used throughout the example are entirely fictitious.

(2) Determination of required sample size. For calculating the required sample size, estimates of the standard (average) passenger mass and the standard deviation are needed. The 'a priori' estimates from an earlier survey may be used for this purpose. If such estimates are not available, a small representative sample of about 100 passengers should be weighed so that the required values can be calculated. The latter has been assumed for the example.

Step 1: Estimated average passenger mass.

n	x_j (kg)
1	79.9
2	68.1
3	77.9
4	74.5
5	54.1
6	62.2
7	89.3
8	108.7
.	.
85	63.2
86	75.4

$\sum_{j=1}^{86} .$	6 071.6
---------------------	---------

$$\begin{aligned} \mu' = \bar{x} &= \frac{\sum x_j}{n} = \frac{6071.6}{86} \\ &= 70.6 \text{ kg} \end{aligned}$$

Step 2: Estimated standard deviation.

n	x_j	$(x_j - \bar{x})$	$(x_j - \bar{x})^2$
1	79.9	+9.3	86.49
2	68.1	-2.5	6.25
3	77.9	+7.3	53.29
4	74.5	+3.9	15.21
5	54.1	-16.5	272.25
6	62.2	-8.4	70.56
7	89.3	+18.7	349.69
8	108.7	+38.1	1 451.61
.	.	.	.
85	63.2	-7.4	54.76
86	75.4	-4.8	23.04
$\sum_{j=1}^{86} .$	6 071.6		34 683.40

$$\sigma' = \sqrt{\frac{\sum (x_j - \bar{x})^2}{n - 1}}$$

$$\sigma' = \sqrt{\frac{34\,683.40}{86 - 1}}$$

$$\sigma' = 20.20 \text{ kg}$$

Step 3: Required sample size.

The required number of passengers to be weighed should be such that the confidence range, e'_r does not exceed 1 %, as specified in (c).

$$n \geq \frac{(1.96 * \sigma' * 100)^2}{(e'_r * \mu')^2}$$

$$n \geq \frac{(1.96 * 20.20 * 100)^2}{(1 * 70.6)^2}$$

$$n \geq 3145$$

The result shows that at least 3 145 passengers should be weighed to achieve the required accuracy. If e'_r is chosen as 2 % the result would be $n \geq 786$.

Step 4: After having established the required sample size, a plan for weighing the passengers is to be worked out.

(3) Determination of the passenger average mass

Step 1: Having collected the required number of passenger mass values, the average passenger mass can be calculated. For the purpose of this example, it has been assumed that 3 180 passengers were weighed. The sum of the individual masses amounts to 231 186.2 kg.

$$n = 3\,180$$

$$\sum_{j=1}^{3180} X_j = 231\,186.2 \text{ kg}$$

$$\bar{x} = \frac{\sum x_j}{n} = \frac{231\,186.2}{3\,180} \text{ kg}$$

$$\bar{x} = 72.7 \text{ kg}$$

Step 2: Calculation of the standard deviation

For calculating the standard deviation, the method shown in paragraph (2) step 2 should be applied.

$$\sum (x_j - \bar{x})^2 = 745\,145.20$$

$$s = \sqrt{\frac{\sum (x_j - \bar{x})^2}{n - 1}}$$

$$s = \sqrt{\frac{745\,145.20}{3\,180 - 1}}$$

$$s = 15.31 \text{ kg}$$

Step 3: Calculation of the accuracy of the sample mean

$$e_r = \frac{1.96 * s * 100}{\sqrt{n} * \bar{x}} \%$$

$$e_r = \frac{1.96 * 15.31 * 100}{\sqrt{3\,180} * 72.7} \%$$

$$e_r = 0.73 \%$$

Step 4: Calculation of the confidence range of the sample mean

$$\bar{x} \pm \frac{1.96 * s}{\sqrt{n}}$$

$$\bar{x} \pm \frac{1.96 * 15.31}{\sqrt{3180}} \text{ kg}$$

$$72.7 \pm 0.5 \text{ kg}$$

The result of this calculation shows that there is a 95 % probability of the actual mean for all passengers lying within the range 72.2 kg to 73.2 kg.

GM3 CAT.POL.MAB.100(e) Mass and balance, loading

ED Decision 2014/015/R

GUIDANCE ON PASSENGER WEIGHING SURVEYS

(a) Detailed survey plan

- (1) The operator should establish and submit to the competent authority a detailed weighing survey plan that is fully representative of the operation, i.e. the network or route under consideration and the survey should involve the weighing of an adequate number of passengers.
- (2) A representative survey plan means a weighing plan specified in terms of weighing locations, dates and flight numbers giving a reasonable reflection of the operator's timetable and/or area of operation.
- (3) The minimum number of passengers to be weighed is the highest of the following:
 - (i) The number that follows from the means of compliance that the sample should be representative of the total operation to which the results will be applied; this will often prove to be the overriding requirement.
 - (ii) The number that follows from the statistical requirement specifying the accuracy of the resulting mean values, which should be at least 2 % for male and female standard masses and 1 % for all adult standard masses, where applicable. The required sample size can be estimated on the basis of a pilot sample (at least 100 passengers) or from a previous survey. If analysis of the results of the survey indicates that the requirements on the accuracy of the mean values for male or female standard masses or all adult standard masses, as applicable, are not met, an additional number of representative passengers should be weighed in order to satisfy the statistical requirements.
- (4) To avoid unrealistically small samples, a minimum sample size of 2 000 passengers (males + females) is also required, except for small aircraft where in view of the burden of the large number of flights to be weighed to cover 2 000 passengers, a lesser number is considered acceptable.

- (b) Execution of weighing programme
- (1) At the beginning of the weighing programme, it is important to note, and to account for, the data requirements of the weighing survey report (see (e)).
 - (2) As far as is practicable, the weighing programme should be conducted in accordance with the specified survey plan.
 - (3) Passengers and all their personal belongings should be weighed as close as possible to the boarding point and the mass, as well as the associated passenger category (male/female/child), should be recorded.
- (c) Analysis of results of weighing survey. The data of the weighing survey should be analysed as explained in this GM. To obtain an insight to variations per flight, per route, etc. this analysis should be carried out in several stages, i.e. by flight, by route, by area, inbound/outbound, etc. Significant deviations from the weighing survey plan should be explained as well as their possible effect(s) on the results.
- (d) Results of the weighing survey
- (1) The results of the weighing survey should be summarised. Conclusions and any proposed deviations from published standard mass values should be justified. The results of a passenger weighing survey are average masses for passengers, including hand baggage, which may lead to proposals to adjust the standard mass values given in [AMC1 CAT.POL.MAB.100\(e\)](#) Tables 1 and 2. These averages, rounded to the nearest whole number may, in principle, be applied as standard mass values for males and females on aircraft with 20 or more passenger seats. Because of variations in actual passenger masses, the total passenger load also varies and statistical analysis indicates that the risk of a significant overload becomes unacceptable for aircraft with less than 20 seats. This is the reason for passenger mass increments on small aircraft.
 - (2) The average masses of males and females differ by some 15 kg or more. Because of uncertainties in the male/female ratio, the variation of the total passenger load is greater if all adult standard masses are used than when using separate male and female standard masses. Statistical analysis indicates that the use of all adult standard mass values should be limited to aircraft with 30 passenger seats or more.
 - (3) Standard mass values for all adults must be based on the averages for males and females found in the sample, taking into account a reference male/female ratio of 80/20 for all flights except holiday charters where a ratio of 50/50 applies. The operator may, based on the data from his weighing programme, or by proving a different male/female ratio, apply for approval of a different ratio on specific routes or flights.
- (e) Weighing survey report
- The weighing survey report, reflecting the content of (d)(1) - (3), should be prepared in a standard format as follows:

WEIGHING SURVEY REPORT

1 Introduction

Objective and brief description of the weighing survey.

2 Weighing survey plan

Discussion of the selected flight number, airports, dates, etc.
Determination of the minimum number of passengers to be weighed.
Survey plan.

3 Analysis and discussion of weighing survey results

Significant deviations from survey plan (if any).
Variations in means and standard deviations in the network.
Discussion of the (summary of) results.

4 Summary of results and conclusions

Main results and conclusions.
Proposed deviations from published standard mass values.

Attachment 1

Applicable summer and/or winter timetables or flight programmes.

Attachment 2

Weighing results per flight (showing individual passenger masses and sex); means and standard deviations per flight, per route, per area and for the total network.

GM1 CAT.POL.MAB.100(g) Mass and balance, loading

ED Decision 2014/015/R

FUEL DENSITY

- (a) If the actual fuel density is not known, the operator may use standard fuel density values for determining the mass of the fuel load. Such standard values should be based on current fuel density measurements for the airports or areas concerned.
- (b) Typical fuel density values are:
- | | | |
|-----------------------------------|---|------|
| (1) Gasoline (piston engine fuel) | – | 0.71 |
| (2) JET A1 (Jet fuel JP 1) | – | 0.79 |
| (3) JET B (Jet fuel JP 4) | – | 0.76 |
| (4) Oil | – | 0.88 |

GM1 CAT.POL.MAB.100(i) Mass and balance, loading

ED Decision 2014/015/R

IN-FLIGHT CHANGES IN LOADING — HELICOPTERS

In-flight changes in loading may occur in hoist operations.

CAT.POL.MAB.105 Mass and balance data and documentation

Regulation (EU) 2018/1975

- (a) The operator shall establish mass and balance data and produce mass and balance documentation prior to each flight specifying the load and its distribution. The mass and balance documentation shall enable the commander to determine that the load and its distribution is such that the mass and balance limits of the aircraft are not exceeded. The mass and balance documentation shall contain the following information:
- (1) Aircraft registration and type;
 - (2) Flight identification, number and date;
 - (3) Name of the commander;
 - (4) Name of the person who prepared the document;
 - (5) Dry operating mass and the corresponding CG of the aircraft:

- (i) for performance class B aeroplanes and for helicopters the CG position may not need to be on the mass and balance documentation if, for example, the load distribution is in accordance with a pre-calculated balance table or if it can be shown that for the planned operations a correct balance can be ensured, whatever the real load is;
 - (6) Mass of the fuel at take-off and the mass of trip fuel;
 - (7) Mass of consumables other than fuel, if applicable;
 - (8) Load components including passengers, baggage, freight and ballast;
 - (9) Take-off mass, landing mass and zero fuel mass;
 - (10) Applicable aircraft CG positions; and
 - (11) The limiting mass and CG values.
The information above shall be available in flight planning documents or mass and balance systems. Some of this information may be contained in other documents readily available for use.
- (b) Where mass and balance data and documentation is generated by a computerised mass and balance system, the operator shall:
 - (1) verify the integrity of the output data to ensure that the data are within AFM limitations; and
 - (2) specify the instructions and procedures for its use in its operations manual.
 - (c) The person supervising the loading of the aircraft shall confirm by hand signature or equivalent that the load and its distribution are in accordance with the mass and balance documentation given to the commander. The commander shall indicate his/her acceptance by hand signature or equivalent.
 - (d) The operator shall specify procedures for last minute changes to the load to ensure that:
 - (1) any last minute change after the completion of the mass and balance documentation is brought to the attention of the commander and entered in the flight planning documents containing the mass and balance documentation;
 - (2) the maximum last minute change allowed in passenger numbers or hold load is specified; and
 - (3) new mass and balance documentation is prepared if this maximum number is exceeded.

AMC1 CAT.POL.MAB.105(a) Mass and balance data and documentation

ED Decision 2014/015/R

CONTENTS

The mass and balance documentation should include advice to the commander whenever a non-standard method has been used for determining the mass of the load.

AMC1 CAT.POL.MAB.105(b) Mass and balance data and documentation

ED Decision 2014/015/R

INTEGRITY

The operator should verify the integrity of mass and balance data and documentation generated by a computerised mass and balance system, at intervals not exceeding 6 months. The operator should establish a system to check that amendments of its input data are incorporated properly in the system and that the system is operating correctly on a continuous basis.

AMC1 CAT.POL.MAB.105(c) Mass and balance data and documentation

ED Decision 2014/015/R

SIGNATURE OR EQUIVALENT

Where a signature by hand is impracticable or it is desirable to arrange the equivalent verification by electronic means, the following conditions should be applied in order to make an electronic signature the equivalent of a conventional hand-written signature:

- (a) electronic 'signing' by entering a personal identification number (PIN) code with appropriate security, etc.;
- (b) entering the PIN code generates a print-out of the individual's name and professional capacity on the relevant document(s) in such a way that it is evident, to anyone having a need for that information, who has signed the document;
- (c) the computer system logs information to indicate when and where each PIN code has been entered;
- (d) the use of the PIN code is, from a legal and responsibility point of view, considered to be fully equivalent to signature by hand;
- (e) the requirements for record keeping remain unchanged; and.
- (f) all personnel concerned are made aware of the conditions associated with electronic signature and this is documented.

AMC2 CAT.POL.MAB.105(c) Mass and balance data and documentation

ED Decision 2014/015/R

MASS AND BALANCE DOCUMENTATION SENT VIA DATA LINK

Whenever the mass and balance documentation is sent to the aircraft via data link, a copy of the final mass and balance documentation, as accepted by the commander, should be available on the ground.

SUBPART D: INSTRUMENTS, DATA, EQUIPMENT

SECTION 1 – AEROPLANES

CAT.IDE.A.100 Instruments and equipment – general

Regulation (EU) 2019/1384

- (a) Instruments and equipment required by this Subpart shall be approved in accordance with the applicable airworthiness requirements except for the following items:
- (1) Spare fuses;
 - (2) Independent portable lights;
 - (3) An accurate time piece;
 - (4) Chart holder;
 - (5) First-aid kits;
 - (6) Emergency medical kit;
 - (7) Megaphones;
 - (8) Survival and signalling equipment;
 - (9) Sea anchors and equipment for mooring; and
 - (10) Child restraint devices.
- (b) Instruments and equipment not required under this Annex (Part-CAT) as well as any other equipment which is not required under this Regulation, but carried on a flight, shall comply with the following requirements:
- (1) the information provided by those instruments, equipment or accessories shall not be used by the flight crew members to comply with Annex II to Regulation (EU) 2018/1139 or points [CAT.IDE.A.330](#), [CAT.IDE.A.335](#), [CAT.IDE.A.340](#) and [CAT.IDE.A.345](#) of this Annex;
 - (2) the instruments and equipment shall not affect the airworthiness of the aeroplane, even in the case of failures or malfunction.
- (c) If equipment is to be used by one flight crew member at his/her station during flight, it shall be readily operable from that station. When a single item of equipment is required to be operated by more than one flight crew member it shall be installed so that the equipment is readily operable from any station at which the equipment is required to be operated.
- (d) Those instruments that are used by any flight crew member shall be so arranged as to permit the flight crew member to see the indications readily from his/her station, with the minimum practicable deviation from the position and line of vision that he/she normally assumes when looking forward along the flight path.
- (e) All required emergency equipment shall be easily accessible for immediate use.

GM1 CAT.IDE.A.100(a) Instruments and equipment – general

ED Decision 2014/015/R

REQUIRED INSTRUMENTS AND EQUIPMENT THAT DO NOT NEED TO BE APPROVED IN ACCORDANCE WITH COMMISSION REGULATION (EU) NO 748/2012

The functionality of non-installed instruments and equipment required by this Subpart and that do not need an equipment approval, as listed in [CAT.IDE.A.100\(a\)](#), should be checked against recognised industry standards appropriate to the intended purpose. The operator is responsible for ensuring the maintenance of these instruments and equipment.

GM1 CAT.IDE.A.100(b) Instruments and equipment – general

ED Decision 2014/015/R

NOT REQUIRED INSTRUMENTS AND EQUIPMENT THAT DO NOT NEED TO BE APPROVED IN ACCORDANCE WITH COMMISSION REGULATION (EU) NO 748/2012, BUT ARE CARRIED ON A FLIGHT

- (a) The provision of this paragraph does not exempt any installed instrument or item of equipment from complying with Commission Regulation (EU) No 748/2012¹. In this case, the installation should be approved as required in Commission Regulation (EU) No 748/2012 and should comply with the applicable Certification Specifications as required under the same Regulation.
- (b) The failure of additional non-installed instruments or equipment not required by this Part or by Commission Regulation (EU) No 748/2012 or any applicable airspace requirements should not adversely affect the airworthiness and/or the safe operation of the aeroplane. Examples may be the following:
 - (1) portable electronic flight bag (EFB);
 - (2) portable electronic devices carried by flight crew or cabin crew; and
 - (3) non-installed passenger entertainment equipment.

GM1 CAT.IDE.A.100(d) Instruments and equipment – general

ED Decision 2014/015/R

POSITIONING OF INSTRUMENTS

This requirement implies that whenever a single instrument is required to be installed in an aeroplane operated in a multi-crew environment, the instrument needs to be visible from each flight crew station.

CAT.IDE.A.105 Minimum equipment for flight

Regulation (EU) 2019/1384

A flight shall not be commenced when any of the aeroplane's instruments, items of equipment or functions required for the intended flight are inoperative or missing, unless:

- (a) the aeroplane is operated in accordance with the operator's MEL; or

¹ Commission Regulation (EU) No 748/2012 of 3 August 2012 laying down implementing rules for the airworthiness and environmental certification of aircraft and related products, parts and appliances, as well as for the certification of design and production organisations (OJ L 224, 21.8.2012, p. 1)

- (b) the operator is approved by the competent authority to operate the aeroplane within the constraints of the master minimum equipment list (MMEL) in accordance with point [ORO.MLR.105\(j\)](#) of Annex III.

AMC1 CAT.IDE.A.105 Minimum equipment for flight

ED Decision 2021/005/R

MANAGEMENT OF THE STATUS OF CERTAIN INSTRUMENTS, EQUIPMENT OR FUNCTIONS

The operator should control and retain the status of the instruments, equipment or functions required for the intended operation, that are not controlled for the purpose of continuing airworthiness management.

GM1 CAT.IDE.A.105 Minimum equipment for flight

ED Decision 2021/005/R

MANAGEMENT OF THE STATUS OF CERTAIN INSTRUMENTS, EQUIPMENT OR FUNCTIONS

- (a) The operator should define responsibilities and procedures to retain and control the status of instruments, equipment or functions required for the intended operation, that are not controlled for the purpose of continuing airworthiness management.
- (b) Examples of such instruments, equipment or functions may be, but are not limited to, equipment related to navigation approvals as FM immunity or certain software versions.

CAT.IDE.A.110 Spare electrical fuses

Regulation (EU) No 965/2012

- (a) Aeroplanes shall be equipped with spare electrical fuses, of the ratings required for complete circuit protection, for replacement of those fuses that are allowed to be replaced in flight.
- (b) The number of spare fuses that are required to be carried shall be the higher of:
- (1) 10 % of the number of fuses of each rating; or
 - (2) three fuses for each rating.

GM1 CAT.IDE.A.110 Spare electrical fuses

ED Decision 2014/015/R

FUSES

A 'spare electrical fuse' means a replaceable fuse in the flight crew compartment, not an automatic circuit breaker, or circuit breakers in the electric compartments.

CAT.IDE.A.115 Operating lights

Regulation (EU) No 965/2012

- (a) Aeroplanes operated by day shall be equipped with:
- (1) an anti-collision light system;
 - (2) lighting supplied from the aeroplane's electrical system to provide adequate illumination for all instruments and equipment essential to the safe operation of the aeroplane;

- (3) lighting supplied from the aeroplane's electrical system to provide illumination in all passenger compartments; and
 - (4) an independent portable light for each required crew member readily accessible to crew members when seated at their designated stations.
- (b) Aeroplanes operated at night shall in addition be equipped with:
- (1) navigation/position lights;
 - (2) two landing lights or a single light having two separately energised filaments; and
 - (3) lights to conform with the International Regulations for Preventing Collisions at Sea if the aeroplane is operated as a seaplane.

CAT.IDE.A.120 Equipment to clear windshield

Regulation (EU) No 965/2012

Aeroplanes with an MCTOM of more than 5 700 kg shall be equipped at each pilot station with a means to maintain a clear portion of the windshield during precipitation.

AMC1 CAT.IDE.A.120 Equipment to clear windshield

ED Decision 2014/015/R

MEANS TO MAINTAIN A CLEAR PORTION OF THE WINDSHIELD DURING PRECIPITATION

The means used to maintain a clear portion of the windshield during precipitation should be windshield wipers or an equivalent.

CAT.IDE.A.125 Operations under VFR by day – flight and navigational instruments and associated equipment

Regulation (EU) 2019/1384

- (a) Aeroplanes operated under VFR by day shall be equipped with the following equipment, available at the pilot's station:
- (1) A means of measuring and displaying:
 - (i) Magnetic heading;
 - (ii) Time in hours, minutes, and seconds;
 - (iii) Barometric altitude;
 - (iv) Indicated airspeed;
 - (v) Vertical speed;
 - (vi) Turn and slip;
 - (vii) Attitude;
 - (viii) Heading;
 - (ix) Outside air temperature; and
 - (x) Mach number whenever speed limitations are expressed in terms of Mach number.

- (2) A means of indicating when the supply of power to the required flight instruments is not adequate.
- (b) Whenever two pilots are required for the operation, an additional separate means of displaying the following shall be available for the second pilot:
 - (1) Barometric altitude;
 - (2) Indicated airspeed;
 - (3) Vertical speed;
 - (4) Turn and slip;
 - (5) Attitude; and
 - (6) Heading.
- (c) A means for preventing malfunction of the airspeed indicating systems due to condensation or icing shall be available for:
 - (1) aeroplanes with an MCTOM of more than 5 700 kg or an MOPSC of more than nine; and
 - (2) aeroplanes first issued with an individual CofA on or after 1 April 1999.
- (d) Single engine aeroplanes first issued with an individual CofA before 22 May 1995 are exempted from the requirements of (a)(1)(vi), (a)(1)(vii), (a)(1)(viii) and (a)(1)(ix) if the compliance would require retrofitting.

AMC1 CAT.IDE.A.125 & CAT.IDE.A.130 Operations under VFR by day & Operations under IFR or at night – flight and navigational instruments and associated equipment

ED Decision 2014/015/R

INTEGRATED INSTRUMENTS

- (a) Individual equipment requirements may be met by combinations of instruments, by integrated flight systems or by a combination of parameters on electronic displays, provided that the information so available to each required pilot is not less than that required in the applicable operational requirements, and the equivalent safety of the installation has been shown during type certification approval of the aeroplane for the intended type of operation.
- (b) The means of measuring and indicating turn and slip, aeroplane attitude and stabilised aeroplane heading may be met by combinations of instruments or by integrated flight director systems, provided that the safeguards against total failure, inherent in the three separate instruments, are retained.

AMC2 CAT.IDE.A.125 Operations under VFR by day — flight and navigational instruments and associated equipment

ED Decision 2014/015/R

LOCAL FLIGHTS

For flights that do not exceed 60 minutes' duration, that take off and land at the same aerodrome and that remain within 50 NM of that aerodrome, an equivalent means of complying with [CAT.IDE.A.125 \(a\)\(1\)\(vi\)](#) may be:

- (a) a turn and slip indicator;
- (b) a turn coordinator; or
- (c) both an attitude indicator and a slip indicator.

AMC1 CAT.IDE.A.125(a)(1)(i) & CAT.IDE.A.130(a)(1) Operations under VFR by day & Operations under IFR or at night – flight and navigational instruments and associated equipment

ED Decision 2014/015/R

MEANS OF MEASURING AND DISPLAYING MAGNETIC HEADING

The means of measuring and displaying magnetic direction should be a magnetic compass or equivalent.

AMC1 CAT.IDE.A.125(a)(1)(ii) & CAT.IDE.A.130(a)(2) Operations under VFR by day & Operations under IFR or at night – flight and navigational instruments and associated equipment

ED Decision 2014/015/R

MEANS OF MEASURING AND DISPLAYING THE TIME

An acceptable means of compliance is a clock displaying hours, minutes and seconds, with a sweep-second pointer or digital presentation.

AMC1 CAT.IDE.A.125(a)(1)(iii) & CAT.IDE.A.130(b) Operations under VFR by day & Operations under IFR or at night – flight and navigational instruments and associated equipment

ED Decision 2019/019/R

CALIBRATION OF THE MEANS OF MEASURING AND DISPLAYING PRESSURE ALTITUDE

The instrument measuring and displaying barometric altitude should be of a sensitive type calibrated in feet (ft), with a sub-scale setting, calibrated in hectopascals/millibars, adjustable for any barometric pressure likely to be set during flight.

AMC1 CAT.IDE.A.125(a)(1)(iv) & CAT.IDE.A.130(a)(3) Operations under VFR by day & Operations under IFR or at night – flight and navigational instruments and associated equipment

ED Decision 2014/015/R

CALIBRATION OF THE INSTRUMENT INDICATING AIRSPEED

The instrument indicating airspeed should be calibrated in knots (kt).

AMC1 CAT.IDE.A.125(a)(1)(ix) & CAT.IDE.A.130(a)(8) Operations under VFR by day & operations under IFR or at night – flight and navigational instruments and associated equipment

ED Decision 2014/015/R

MEANS OF DISPLAYING OUTSIDE AIR TEMPERATURE

- (a) The means of displaying outside air temperature should be calibrated in degrees Celsius.
- (b) The means of displaying outside air temperature may be an air temperature indicator that provides indications that are convertible to outside air temperature.

AMC1 CAT.IDE.A.125(b) & CAT.IDE.A.130(h) Operations under VFR by day & Operations under IFR or at night – flight and navigational instruments and associated equipment

ED Decision 2014/015/R

MULTI-PILOT OPERATIONS — DUPLICATE INSTRUMENTS

Duplicate instruments should include separate displays for each pilot and separate selectors or other associated equipment where appropriate.

AMC1 CAT.IDE.A.125(c) & CAT.IDE.A.130(d) Operations under VFR by day & Operations under IFR or at night – flight and navigational instruments and associated equipment

ED Decision 2014/015/R

MEANS OF PREVENTING MALFUNCTION DUE TO CONDENSATION OR ICING

The means of preventing malfunction due to either condensation or icing of the airspeed indicating system should be a heated pitot tube or equivalent.

GM1 CAT.IDE.A.125 & CAT.IDE.A.130 Operations under VFR by day & Operations under IFR or at night – flight and navigational instruments and associated equipment

ED Decision 2017/008/R

SUMMARY TABLE

Table 1

Flight and navigational instruments and associated equipment

SERIAL INSTRUMENT		FLIGHTS UNDER VFR		FLIGHTS UNDER IFR OR AT NIGHT	
		SINGLE-PILOT	TWO PILOTS REQUIRED	SINGLE-PILOT	TWO PILOTS REQUIRED
1	Magnetic direction	1	1	1	1
2	Time	1	1	1	1
3	Pressure altitude	1	2	2 Note (5)	2 Note (5)
4	Indicated airspeed	1	2	1	2

SERIAL		FLIGHTS UNDER VFR		FLIGHTS UNDER IFROR AT NIGHT	
INSTRUMENT		SINGLE-PILOT	TWO PILOTS REQUIRED	SINGLE-PILOT	TWO PILOTS REQUIRED
5	Vertical speed	1	2	1	2
6	Turn and slip or turn coordinator	1 Note (1)	2 Note (1) & Note (2)	1 Note (4)	2 Note (4)
7	Attitude	1 Note (1)	2 Note (1) & Note (2)	1	2
8	Stabilised direction	1 Note (1)	2 Note (1) & Note (2)	1	2
9	Outside air temperature	1	1	1	1
10	Mach number indicator	See Note (3)			
11	Airspeed icing protection	1 Note (6)	2 Note (6)	1	2
12	Airspeed icing protection failure indicating			1 Note (7)	2 Note (7)
13	Static pressure source			2	2
14	Standby attitude indicator			1 Note (8)	1 Note (8)
15	Chart holder			1 Note (6)	1 Note (6)

Note (1) For local flights (A to A, 50 NM radius, not more than 60 minutes' duration), the instruments at serials (a)(6) and (a)(8) may be replaced by either a turn and slip indicator, or a turn coordinator, or both an attitude indicator and a slip indicator.

Note (2) The substitute instruments permitted by Note (1) above should be provided at each pilot's station.

Note (3) A Mach number indicator is required for each pilot whenever compressibility limitations are not otherwise indicated by airspeed indicators.

Note (4) For IFR or at night, a turn and slip indicator, or a slip indicator and a third (standby) attitude indicator certified according to CS 25.1303 (b)(4) or equivalent, is required.

Note (5) Except for unpressurised aeroplanes operating below 10 000 ft, neither three pointers, nor drum-pointer altimeters satisfy the requirement.

Note (6) Applicable only to aeroplanes with a maximum certified take-off mass (MCTOM) of more than 5 700 kg, or with an MOPSC of more than 9. It also applies to all aeroplanes first issued with an individual certificate of airworthiness (CofA) on or after 1 April 1999.

Note (7) The pitot heater failure annunciation applies to any aeroplane issued with an individual CofA on or after 1 April 1998. It also applies before that date when: the aeroplane has an MCTOM of more than 5 700 kg and an MOPSC greater than 9.

Note (8) Applicable only to aeroplanes with an MCTOM of more than 5 700 kg, or with an MOPSC of more than 9.

CAT.IDE.A.130 Operations under IFR or at night – flight and navigational instruments and associated equipment

Regulation (EU) 2019/1384

Aeroplanes operated under VFR at night or under IFR shall be equipped with the following equipment, available at the pilot's station:

- (a) A means of measuring and displaying:
 - (1) Magnetic heading;
 - (2) Time in hours, minutes and seconds;
 - (3) Indicated airspeed;
 - (4) Vertical speed;
 - (5) Turn and slip, or in the case of aeroplanes equipped with a standby means of measuring and displaying attitude, slip;
 - (6) Attitude;
 - (7) Stabilised heading;
 - (8) Outside air temperature; and
 - (9) Mach number whenever speed limitations are expressed in terms of Mach number.
- (b) Two means of measuring and displaying barometric altitude.
- (c) A means of indicating when the supply of power to the required flight instruments is not adequate.
- (d) A means for preventing malfunction of the airspeed indicating systems required in (a)(3) and (h)(2) due to condensation or icing.
- (e) A means of annunciating to the flight crew the failure of the means required in (d) for aeroplanes:
 - (1) issued with an individual CofA on or after 1 April 1998; or
 - (2) issued with an individual CofA before 1 April 1998 with an MCTOM of more than 5 700 kg, and with an MOPSC of more than nine.
- (f) Except for propeller-driven aeroplanes with an MCTOM of 5 700 kg or less, two independent static pressure systems.
- (g) One static pressure system and one alternate source of static pressure for propeller-driven aeroplanes with an MCTOM of 5 700 kg or less.
- (h) Whenever two pilots are required for the operation, a separate means of displaying for the second pilot:
 - (1) Barometric altitude;
 - (2) Indicated airspeed;
 - (3) Vertical speed;
 - (4) Turn and slip;
 - (5) Attitude; and
 - (6) Stabilised heading.

- (i) A standby means of measuring and displaying attitude capable of being used from either pilot's station for aeroplanes with an MCTOM of more than 5 700 kg or an MOPSC of more than nine that:
- (1) is powered continuously during normal operation and, after a total failure of the normal electrical generating system, is powered from a source independent from the normal electrical generating system;
 - (2) provides reliable operation for a minimum of 30 minutes after total failure of the normal electrical generating system, taking into account other loads on the emergency power supply and operational procedures;
 - (3) operates independently of any other means of measuring and displaying attitude;
 - (4) is operative automatically after total failure of the normal electrical generating system;
 - (5) is appropriately illuminated during all phases of operation, except for aeroplanes with an MCTOM of 5 700 kg or less, already registered in a Member State on 1 April 1995 and equipped with a standby attitude indicator in the left-hand instrument panel;
 - (6) is clearly evident to the flight crew when the standby attitude indicator is being operated by emergency power; and
 - (7) where the standby attitude indicator has its own dedicated power supply, has an associated indication, either on the instrument or on the instrument panel, when this supply is in use.
- (j) A chart holder in an easily readable position that can be illuminated for night operations.

AMC1 CAT.IDE.A.125 & CAT.IDE.A.130 Operations under VFR by day & Operations under IFR or at night – flight and navigational instruments and associated equipment

ED Decision 2014/015/R

INTEGRATED INSTRUMENTS

- (a) Individual equipment requirements may be met by combinations of instruments, by integrated flight systems or by a combination of parameters on electronic displays, provided that the information so available to each required pilot is not less than that required in the applicable operational requirements, and the equivalent safety of the installation has been shown during type certification approval of the aeroplane for the intended type of operation.
- (b) The means of measuring and indicating turn and slip, aeroplane attitude and stabilised aeroplane heading may be met by combinations of instruments or by integrated flight director systems, provided that the safeguards against total failure, inherent in the three separate instruments, are retained.

AMC1 CAT.IDE.A.125(a)(1)(i) & CAT.IDE.A.130(a)(1) Operations under VFR by day & Operations under IFR or at night – flight and navigational instruments and associated equipment

ED Decision 2014/015/R

MEANS OF MEASURING AND DISPLAYING MAGNETIC HEADING

The means of measuring and displaying magnetic direction should be a magnetic compass or equivalent.

AMC1 CAT.IDE.A.125(a)(1)(ii) & CAT.IDE.A.130(a)(2) Operations under VFR by day & Operations under IFR or at night – flight and navigational instruments and associated equipment

ED Decision 2014/015/R

MEANS OF MEASURING AND DISPLAYING THE TIME

An acceptable means of compliance is a clock displaying hours, minutes and seconds, with a sweep-second pointer or digital presentation.

AMC1 CAT.IDE.A.125(a)(1)(iv) & CAT.IDE.A.130(a)(3) Operations under VFR by day & Operations under IFR or at night – flight and navigational instruments and associated equipment

ED Decision 2014/015/R

CALIBRATION OF THE INSTRUMENT INDICATING AIRSPEED

The instrument indicating airspeed should be calibrated in knots (kt).

AMC1 CAT.IDE.A.130(a)(5) Operations under IFR or at night – flight and navigational instruments and associated equipment

ED Decision 2014/015/R

SLIP INDICATOR

If only slip indication is provided, the means of measuring and displaying standby attitude should be certified according to CS 25.1303(b)(4) or equivalent.

AMC1 CAT.IDE.A.125(a)(1)(ix) & CAT.IDE.A.130(a)(8) Operations under VFR by day & operations under IFR or at night – flight and navigational instruments and associated equipment

ED Decision 2014/015/R

MEANS OF DISPLAYING OUTSIDE AIR TEMPERATURE

- (a) The means of displaying outside air temperature should be calibrated in degrees Celsius.
- (b) The means of displaying outside air temperature may be an air temperature indicator that provides indications that are convertible to outside air temperature.

AMC1 CAT.IDE.A.125(a)(1)(iii) & CAT.IDE.A.130(b) Operations under VFR by day & Operations under IFR or at night – flight and navigational instruments and associated equipment

ED Decision 2019/019/R

CALIBRATION OF THE MEANS OF MEASURING AND DISPLAYING PRESSURE ALTITUDE

The instrument measuring and displaying barometric altitude should be of a sensitive type calibrated in feet (ft), with a sub-scale setting, calibrated in hectopascals/millibars, adjustable for any barometric pressure likely to be set during flight.

AMC2 CAT.IDE.A.130(b) Operations under IFR or at night – flight and navigational instruments and associated equipment

ED Decision 2014/015/R

ALTIMETERS — IFR OR NIGHT OPERATIONS

Except for unpressurised aeroplanes operating below 10 000 ft, the altimeters of aeroplanes operating under IFR or at night should have counter drum-pointer or equivalent presentation.

AMC1 CAT.IDE.A.125(c) & CAT.IDE.A.130(d) Operations under VFR by day & Operations under IFR or at night – flight and navigational instruments and associated equipment

ED Decision 2014/015/R

MEANS OF PREVENTING MALFUNCTION DUE TO CONDENSATION OR ICING

The means of preventing malfunction due to either condensation or icing of the airspeed indicating system should be a heated pitot tube or equivalent.

AMC1 CAT.IDE.A.130(e) Operations under IFR or at night – flight and navigational instruments and associated equipment

ED Decision 2014/015/R

MEANS OF INDICATING FAILURE OF THE AIRSPEED INDICATING SYSTEM'S MEANS OF PREVENTING MALFUNCTION DUE TO EITHER CONDENSATION OR ICING

A combined means of indicating failure of the airspeed indicating system's means of preventing malfunction due to either condensation or icing is acceptable provided that it is visible from each flight crew station and that there is a means to identify the failed heater in systems with two or more sensors.

AMC1 CAT.IDE.A.125(b) & CAT.IDE.A.130(h) Operations under VFR by day & Operations under IFR or at night – flight and navigational instruments and associated equipment

ED Decision 2014/015/R

MULTI-PILOT OPERATIONS — DUPLICATE INSTRUMENTS

Duplicate instruments should include separate displays for each pilot and separate selectors or other associated equipment where appropriate.

AMC1 CAT.IDE.A.130(i)(5) Operations under IFR or at night – flight and navigational instruments and associated equipment

ED Decision 2014/015/R

ILLUMINATION OF STANDBY MEANS OF MEASURING AND DISPLAYING ATTITUDE

The standby means of measuring and displaying attitude should be illuminated so as to be clearly visible under all conditions of daylight and artificial lighting.

AMC1 CAT.IDE.A.130(j) Operations under IFR or at night – flight and navigational instruments and associated equipment

ED Decision 2014/015/R

CHART HOLDER

An acceptable means of compliance with the chart holder requirement is to display a pre-composed chart on an electronic flight bag (EFB).

GM1 CAT.IDE.A.125 & CAT.IDE.A.130 Operations under VFR by day & Operations under IFR or at night – flight and navigational instruments and associated equipment

ED Decision 2017/008/R

SUMMARY TABLE

Table 1

Flight and navigational instruments and associated equipment

SERIAL		FLIGHTS UNDER VFR		FLIGHTS UNDER IFR OR AT NIGHT	
		SINGLE-PILOT	TWO PILOTS REQUIRED	SINGLE-PILOT	TWO PILOTS REQUIRED
1	Magnetic direction	1	1	1	1
2	Time	1	1	1	1
3	Pressure altitude	1	2	2 Note (5)	2 Note (5)
4	Indicated airspeed	1	2	1	2
5	Vertical speed	1	2	1	2
6	Turn and slip or turn coordinator	1 Note (1)	2 Note (1) & Note (2)	1 Note (4)	2 Note (4)
7	Attitude	1 Note (1)	2 Note (1) & Note (2)	1	2
8	Stabilised direction	1 Note (1)	2 Note (1) & Note (2)	1	2
9	Outside air temperature	1	1	1	1
10	Mach number indicator	See Note (3)			
11	Airspeed icing protection	1 Note (6)	2 Note (6)	1	2

SERIAL		FLIGHTS UNDER VFR		FLIGHTS UNDER IFR OR AT NIGHT	
		SINGLE-PILOT	TWO PILOTS REQUIRED	SINGLE-PILOT	TWO PILOTS REQUIRED
12	Airspeed icing protection failure indicating			1 Note (7)	2 Note (7)
13	Static pressure source			2	2
14	Standby attitude indicator			1 Note (8)	1 Note (8)
15	Chart holder			1 Note (6)	1 Note (6)

Note (1) For local flights (A to A, 50 NM radius, not more than 60 minutes' duration), the instruments at serials (a)(6) and (a)(8) may be replaced by either a turn and slip indicator, or a turn coordinator, or both an attitude indicator and a slip indicator.

Note (2) The substitute instruments permitted by Note (1) above should be provided at each pilot's station.

Note (3) A Mach number indicator is required for each pilot whenever compressibility limitations are not otherwise indicated by airspeed indicators.

Note (4) For IFR or at night, a turn and slip indicator, or a slip indicator and a third (standby) attitude indicator certified according to CS 25.1303 (b)(4) or equivalent, is required.

Note (5) Except for unpressurised aeroplanes operating below 10 000 ft, neither three pointers, nor drum-pointer altimeters satisfy the requirement.

Note (6) Applicable only to aeroplanes with a maximum certified take-off mass (MCTOM) of more than 5 700 kg, or with an MOPSC of more than 9. It also applies to all aeroplanes first issued with an individual certificate of airworthiness (CofA) on or after 1 April 1999.

Note (7) The pitot heater failure annunciation applies to any aeroplane issued with an individual CofA on or after 1 April 1998. It also applies before that date when: the aeroplane has an MCTOM of more than 5 700 kg and an MOPSC greater than 9.

Note (8) Applicable only to aeroplanes with an MCTOM of more than 5 700 kg, or with an MOPSC of more than 9.

CAT.IDE.A.135 Additional equipment for single-pilot operation under IFR

Regulation (EU) No 965/2012

Aeroplanes operated under IFR with a single-pilot shall be equipped with an autopilot with at least altitude hold and heading mode.

CAT.IDE.A.140 Altitude alerting system

Regulation (EU) No 965/2012

- (a) The following aeroplanes shall be equipped with an altitude alerting system:
 - (1) turbine propeller powered aeroplanes with an MCTOM of more than 5 700 kg or having an MOPSC of more than nine; and
 - (2) aeroplanes powered by turbo-jet engines.
- (b) The altitude alerting system shall be capable of:
 - (1) alerting the flight crew when approaching a preselected altitude; and

- (2) alerting the flight crew by at least an aural signal, when deviating from a preselected altitude.
- (c) Notwithstanding (a), aeroplanes with an MCTOM of 5 700 kg or less, having an MOPSC of more than nine, first issued with an individual CofA before 1 April 1972 and already registered in a Member State on 1 April 1995 are exempted from being equipped with an altitude alerting system.

CAT.IDE.A.150 Terrain awareness warning system (TAWS)

Regulation (EU) 2018/1042

- (a) Turbine-powered aeroplanes having an MCTOM of more than 5 700 kg or an MOPSC of more than nine shall be equipped with a TAWS that meets the requirements for Class A equipment as specified in an acceptable standard.
- (b) Reciprocating-engine-powered aeroplanes with an MCTOM of more than 5 700 kg or an MOPSC of more than nine shall be equipped with a TAWS that meets the requirement for Class B equipment as specified in an acceptable standard.
- (c) Turbine-powered aeroplanes for which the individual certificate of airworthiness (CofA) was first issued after 1 January 2019 and having an MCTOM of 5 700 kg or less and an MOPSC of six to nine shall be equipped with a TAWS that meets the requirements for Class B equipment, as specified in an acceptable standard.

AMC1 CAT.IDE.A.150 Terrain awareness warning system (TAWS)

ED Decision 2014/015/R

EXCESSIVE DOWNWARDS GLIDE SLOPE DEVIATION WARNING FOR CLASS A TAWS

The requirement for a Class A TAWS to provide a warning to the flight crew for excessive downwards glide slope deviation should apply to all final approach glide slopes with angular vertical navigation (VNAV) guidance, whether provided by the instrument landing system (ILS), microwave landing system (MLS), satellite based augmentation system approach procedure with vertical guidance (SBAS APV (localiser performance with vertical guidance approach LPV)), ground-based augmentation system (GBAS (GPS landing system, GLS) or any other systems providing similar guidance. The same requirement should not apply to systems providing vertical guidance based on barometric VNAV.

GM1 CAT.IDE.A.150 Terrain awareness warning system (TAWS)

ED Decision 2014/015/R

ACCEPTABLE STANDARD FOR TAWS

An acceptable standard for Class A and Class B TAWS may be the applicable European technical standards order (ETSO) issued by the Agency or equivalent.

CAT.IDE.A.155 Airborne collision avoidance system (ACAS)

Regulation (EU) No 965/2012

Unless otherwise provided for by Regulation (EU) No 1332/2011, turbine-powered aeroplanes with an MCTOM of more than 5 700 kg or an MOPSC of more than 19 shall be equipped with ACAS II.

CAT.IDE.A.160 Airborne weather detecting equipment

Regulation (EU) No 965/2012

The following shall be equipped with airborne weather detecting equipment when operated at night or in IMC in areas where thunderstorms or other potentially hazardous weather conditions, regarded as detectable with airborne weather detecting equipment, may be expected to exist along the route:

- (a) pressurised aeroplanes;
- (b) non-pressurised aeroplanes with an MCTOM of more than 5 700 kg; and
- (c) non-pressurised aeroplanes with an MOPSC of more than nine.

AMC1 CAT.IDE.A.160 Airborne weather detecting equipment

ED Decision 2014/015/R

GENERAL

The airborne weather detecting equipment should be an airborne weather radar, except for propeller-driven pressurised aeroplanes with an MCTOM not more than 5 700 kg and an MOPSC of not more than 9, for which other equipment capable of detecting thunderstorms and other potentially hazardous weather conditions, regarded as detectable with airborne weather radar equipment, are also acceptable.

CAT.IDE.A.165 Additional equipment for operations in icing conditions at night

Regulation (EU) No 965/2012

- (a) Aeroplanes operated in expected or actual icing conditions at night shall be equipped with a means to illuminate or detect the formation of ice.
- (b) The means to illuminate the formation of ice shall not cause glare or reflection that would handicap crew members in the performance of their duties.

CAT.IDE.A.170 Flight crew interphone system

Regulation (EU) No 965/2012

Aeroplanes operated by more than one flight crew member shall be equipped with a flight crew interphone system, including headsets and microphones for use by all flight crew members.

AMC1 CAT.IDE.A.170 Flight crew interphone system

ED Decision 2014/015/R

TYPE OF FLIGHT CREW INTERPHONE

The flight crew interphone system should not be of a handheld type.

CAT.IDE.A.175 Crew member interphone system

Regulation (EU) No 965/2012

Aeroplanes with an MCTOM of more than 15 000 kg, or with an MOPSC of more than 19 shall be equipped with a crew member interphone system, except for aeroplanes first issued with an individual CofA before 1 April 1965 and already registered in a Member State on 1 April 1995.

AMC1 CAT.IDE.A.175 Crew member interphone system

ED Decision 2014/015/R

SPECIFICATIONS

The crew member interphone system should:

- (a) operate independently of the public address system except for handsets, headsets, microphones, selector switches and signalling devices;
- (b) in the case of aeroplanes where at least one cabin crew member is required, be readily accessible for use at required cabin crew member stations close to each separate or pair of floor level emergency exits;
- (c) in the case of aeroplanes where at least one cabin crew member is required, have an alerting system incorporating aural or visual signals for use by flight and cabin crew;
- (d) have a means for the recipient of a call to determine whether it is a normal call or an emergency call that uses one or a combination of the following:
 - (1) lights of different colours;
 - (2) codes defined by the operator (e.g. different number of rings for normal and emergency calls); or
 - (3) any other indicating signal specified in the operations manual;
- (e) provide two-way communication between:
 - (1) the flight crew compartment and each passenger compartment, in the case of aeroplanes where at least one cabin crew member is required;
 - (2) the flight crew compartment and each galley located other than on a passenger deck level, in the case of aeroplanes where at least one cabin crew member is required;
 - (3) the flight crew compartment and each remote crew compartment and crew member station that is not on the passenger deck and is not accessible from a passenger compartment; and
 - (4) ground personnel and at least two flight crew members. This interphone system for use by the ground personnel should be, where practicable, so located that the personnel using the system may avoid detection from within the aeroplane; and
- (f) be readily accessible for use from each required flight crew station in the flight crew compartment.

CAT.IDE.A.180 Public address system

Regulation (EU) No 965/2012

Aeroplanes with an MOPSC of more than 19 shall be equipped with a public address system.

AMC1 CAT.IDE.A.180 Public address system

ED Decision 2014/015/R

SPECIFICATIONS

The public address system should:

- (a) operate independently of the interphone systems except for handsets, headsets, microphones, selector switches and signalling devices;

- (b) be readily accessible for immediate use from each required flight crew station;
- (c) have, for each floor level passenger emergency exit that has an adjacent cabin crew seat, a microphone operable by the seated cabin crew member, except that one microphone may serve more than one exit, provided the proximity of exits allows unassisted verbal communication between seated cabin crew members;
- (d) be operable within 10 seconds by a cabin crew member at each of those stations; and
- (e) be audible at all passenger seats, lavatories, galleys, cabin crew seats and work stations, and other crew remote areas.

CAT.IDE.A.185 Cockpit voice recorder

Regulation (EU) 2020/2036

- (a) The following aeroplanes shall be equipped with a cockpit voice recorder (CVR):
 - (1) aeroplanes with an MCTOM of more than 5 700 kg; and
 - (2) multi-engined turbine-powered aeroplanes with an MCTOM of 5 700 kg or less, with an MOPSC of more than nine and first issued with an individual CofA on or after 1 January 1990.
- (b) Until 31 December 2018, the CVR shall be capable of retaining the data recorded during at least:
 - (1) the preceding 2 hours in the case of aeroplanes referred to in (a)(1) when the individual CofA has been issued on or after 1 April 1998;
 - (2) the preceding 30 minutes for aeroplanes referred to in (a)(1) when the individual CofA has been issued before 1 April 1998; or
 - (3) the preceding 30 minutes, in the case of aeroplanes referred to in (a)(2).
- (c) By 1 January 2019 at the latest, the CVR shall be capable of retaining the data recorded during at least:
 - (1) the preceding 25 hours for aeroplanes with an MCTOM of more than 27 000 kg and first issued with an individual CofA on or after 1 January 2022; or
 - (2) the preceding 2 hours in all other cases.
- (d) By 1 January 2019 at the latest, the CVR shall record on means other than magnetic tape or magnetic wire.
- (e) The CVR shall record with reference to a timescale:
 - (1) voice communications transmitted from or received in the flight crew compartment by radio;
 - (2) flight crew members' voice communications using the interphone system and the public address system, if installed;
 - (3) the aural environment of the flight crew compartment, including without interruption:
 - (i) for aeroplanes first issued with an individual CofA on or after 1 April 1998, the audio signals received from each boom and mask microphone in use;
 - (ii) for aeroplanes referred to in (a)(2) and first issued with an individual CofA before 1 April 1998, the audio signals received from each boom and mask microphone, where practicable;

- (4) voice or audio signals identifying navigation or approach aids introduced into a headset or speaker.
- (f) The CVR shall start to record prior to the aeroplane moving under its own power and shall continue to record until the termination of the flight when the aeroplane is no longer capable of moving under its own power. In addition, in the case of aeroplanes issued with an individual CofA on or after 1 April 1998, the CVR shall start automatically to record prior to the aeroplane moving under its own power and continue to record until the termination of the flight when the aeroplane is no longer capable of moving under its own power.
- (g) In addition to (f), depending on the availability of electrical power, the CVR shall start to record as early as possible during the cockpit checks prior to engine start at the beginning of the flight until the cockpit checks immediately following engine shutdown at the end of the flight, in the case of:
 - (1) aeroplanes referred to in (a)(1) and issued with an individual CofA on or after 1 April 1998; or
 - (2) aeroplanes referred to in (a)(2).
- (h) If the CVR is not deployable, it shall have a device to assist in locating it under water. By 16 June 2018 at the latest, this device shall have a minimum underwater transmission time of 90 days. If the CVR is deployable, it shall have an automatic emergency locator transmitter.
- (i) Aeroplanes with an MCTOM of over 27 000 kg and first issued with an individual CofA on or after 5 September 2022 shall be equipped with an alternate power source to which the CVR and the cockpit-mounted area microphone are switched automatically in the event that all other power to the CVR is interrupted.

AMC1 CAT.IDE.A.185 Cockpit voice recorder

ED Decision 2021/005/R

OPERATIONAL PERFORMANCE REQUIREMENTS

- (a) For aeroplanes first issued with an individual CofA on or after 1 April 1998 and before 1 January 2016, the operational performance requirements for cockpit voice recorders (CVRs) and their dedicated equipment should be those laid down in the European Organisation for Civil Aviation Equipment (EUROCAE) Document ED-56A (Minimum Operational Performance Requirements For Cockpit Voice Recorder Systems) dated December 1993, or EUROCAE Document ED-112 (Minimum Operational Performance Specification for Crash Protected Airborne Recorder Systems) dated March 2003, including Amendments No 1 and No 2, or any later equivalent standard produced by EUROCAE.
- (b) For aeroplanes first issued with an individual CofA on or after 1 January 2016:
 - (1) the operational performance requirements for CVRs should be those laid down in EUROCAE Document ED-112 (Minimum Operational Performance Specification for Crash Protected Airborne Recorder Systems) dated March 2003, including Amendments No 1 and No 2, or any later equivalent standard produced by EUROCAE; and
 - (2) the operational performance requirements for equipment dedicated to the CVR should be those laid down in the European Organisation for Civil Aviation Equipment (EUROCAE) Document ED-56A (Minimum Operational Performance Requirements For Cockpit Voice Recorder Systems) dated December 1993, or EUROCAE Document ED-112 (Minimum Operational Performance Specification for Crash Protected Airborne Recorder Systems)

dated March 2003, including Amendments n°1 and n°2, or any later equivalent standard produced by EUROCAE.

- (c) If required to be installed, the alternate power source should provide electrical power to operate both the CVR and the cockpit-mounted area microphone for at least 10 minutes, with a tolerance of 1 minute.

GM1 CAT.IDE.A.185 Cockpit voice recorder

ED Decision 2021/005/R

TERMINOLOGY

The terms used in CAT.IDE.A.185 should be understood as follows:

- (a) 'Alternate power source' means a power source that is different from the source(s) that normally provides (provide) power to the cockpit voice recorder function.
- (b) 'Cockpit-mounted area microphone' means a microphone located in the flight crew compartment for the purpose of recording voice communications originating at the first and second pilot stations and voice communications of other crew members in the flight crew compartment when directed to those stations.

CAT.IDE.A.190 Flight data recorder

Regulation (EU) 2015/2338

- (a) The following aeroplanes shall be equipped with a flight data recorder (FDR) that uses a digital method of recording and storing data and for which a method of readily retrieving that data from the storage medium is available:
- (1) aeroplanes with an MCTOM of more than 5 700 kg and first issued with an individual CofA on or after 1 June 1990;
 - (2) turbine-engined aeroplanes with an MCTOM of more than 5 700 kg and first issued with an individual CofA before 1 June 1990; and
 - (3) multi-engined turbine-powered aeroplanes with an MCTOM of 5 700 kg or less, with an MOPSC of more than nine and first issued with an individual CofA on or after 1 April 1998.
- (b) The FDR shall record:
- (1) time, altitude, airspeed, normal acceleration and heading and be capable of retaining the data recorded during at least the preceding 25 hours for aeroplanes referred to in (a)(2) with an MCTOM of less than 27 000 kg;
 - (2) the parameters required to determine accurately the aeroplane flight path, speed, attitude, engine power and configuration of lift and drag devices and be capable of retaining the data recorded during at least the preceding 25 hours, for aeroplanes referred to in (a)(1) with an MCTOM of less than 27 000 kg and first issued with an individual CofA before 1 January 2016;
 - (3) the parameters required to determine accurately the aeroplane flight path, speed, attitude, engine power, configuration and operation and be capable of retaining the data recorded during at least the preceding 25 hours, for aeroplanes referred to in (a)(1) and (a)(2) with an MCTOM of over 27 000 kg and first issued with an individual CofA before 1 January 2016;

- (4) the parameters required to determine accurately the aeroplane flight path, speed, attitude, engine power and configuration of lift and drag devices and be capable of retaining the data recorded during at least the preceding 10 hours, in the case of aeroplanes referred to in (a)(3) and first issued with an individual CofA before 1 January 2016; or
 - (5) the parameters required to determine accurately the aeroplane flight path, speed, attitude, engine power, configuration and operation and be capable of retaining the data recorded during at least the preceding 25 hours, for aeroplanes referred to in (a)(1) and (a)(3) and first issued with an individual CofA on or after 1 January 2016.
- (c) Data shall be obtained from aeroplane sources that enable accurate correlation with information displayed to the flight crew.
 - (d) The FDR shall start to record the data prior to the aeroplane being capable of moving under its own power and shall stop after the aeroplane is incapable of moving under its own power. In addition, in the case of aeroplanes issued with an individual CofA on or after 1 April 1998, the FDR shall start automatically to record the data prior to the aeroplane being capable of moving under its own power and shall stop automatically after the aeroplane is incapable of moving under its own power.
 - (e) If the FDR is not deployable, it shall have a device to assist in locating it under water. By 16 June 2018 at the latest, this device shall have a minimum underwater transmission time of 90 days. If the FDR is deployable, it shall have an automatic emergency locator transmitter.

AMC1.1 CAT.IDE.A.190 Flight data recorder

ED Decision 2016/012/R

OPERATIONAL PERFORMANCE REQUIREMENTS FOR AEROPLANES FIRST ISSUED WITH AN INDIVIDUAL CofA ON OR AFTER 1 JANUARY 2016 AND BEFORE 1 JANUARY 2023

- (a) The operational performance requirements for flight data recorders (FDRs) should be those laid down in EUROCAE Document ED-112 (Minimum Operational Performance Specification for Crash Protected Airborne Recorder Systems) dated March 2003, including amendments No 1 and No 2, or any later equivalent standard produced by EUROCAE.
- (b) The FDR should record with reference to a timescale the list of parameters in Table 1 and Table 2, as applicable.
- (c) The parameters to be recorded should meet the performance specifications (range, sampling intervals, accuracy limits and resolution in read-out) as defined in the relevant tables of EUROCAE Document ED-112, including amendments No 1 and No 2, or any later equivalent standard produced by EUROCAE.

Table 1

FDR — all aeroplanes

No*	Parameter
1a	Time; or
1b	Relative time count
1c	Global navigation satellite system (GNSS) time synchronisation
2	Pressure altitude
3a	Indicated airspeed; or Calibrated airspeed

No*	Parameter
4	Heading (primary flight crew reference) — when true or magnetic heading can be selected, the primary heading reference, a discrete indicating selection, should be recorded
5	Normal acceleration
6	Pitch attitude
7	Roll attitude
8	Manual radio transmission keying and CVR/FDR synchronisation reference
9	Engine thrust/power
9a	Parameters required to determine propulsive thrust/power on each engine
9b	Flight crew compartment thrust/power lever position for aeroplanes with non-mechanically linked flight crew compartment — engine control
14	Total or outside air temperature
16	Longitudinal acceleration (body axis)
17	Lateral acceleration
18	Primary flight control surface and/or primary flight control pilot input (for aeroplanes with control systems in which movement of a control surface will back drive the pilot's control, 'or' applies. For aeroplanes with control systems in which movement of a control surface will not back drive the pilot's control, 'and' applies. For multiple or split surfaces, a suitable combination of inputs is acceptable in lieu of recording each surface separately. For aeroplanes that have a flight control break-away capability that allows either pilot to operate the controls independently, record both inputs):
18a	Pitch axis
18b	Roll axis
18c	Yaw axis
19	Pitch trim surface position
23	Marker beacon passage
24	Warnings — in addition to the master warning, each 'red' warning (including smoke warnings from other compartments) should be recorded when the warning condition cannot be determined from other parameters or from the CVR
25	Each navigation receiver frequency selection
27	Air—ground status. Air—ground status and a sensor of each landing gear if installed

* The number in the left hand column reflects the serial number depicted in EUROCAE ED-112.

Table 2

FDR — Aeroplanes for which the data source for the parameter is either used by aeroplane systems or is available on the instrument panel for use by the flight crew to operate the aeroplane

No*	Parameter
10	Flaps
10a	Trailing edge flap position
10b	Flight crew compartment control selection
11	Slats
11a	Leading edge flap (slat) position
11b	Flight crew compartment control selection
12	Thrust reverse status
13	Ground spoiler and speed brake
13a	Ground spoiler position
13b	Ground spoiler selection
13c	Speed brake position
13d	Speed brake selection

No*	Parameter
15	Autopilot, autothrottle and automatic flight control system (AFCS) mode and engagement status
20	Radio altitude. For auto-land/Category III operations, each radio altimeter should be recorded.
21	Vertical deviation — the approach aid in use should be recorded. For auto-land/Category III operations, each system should be recorded.
21a	ILS/GPS/GLS glide path
21b	MLS elevation
21c	Integrated approach navigation (IAN)/integrated area navigation (IRNAV), vertical deviation
22	Horizontal deviation — the approach aid in use should be recorded. For auto land/Category III operations, each system should be recorded.
22a	ILS/GPS/GLS localiser
22b	MLS azimuth
22c	GNSS approach path/IRNAV lateral deviation
26	Distance measuring equipment (DME) 1 and 2 distances
26a	Distance to runway threshold (GLS)
26b	Distance to missed approach point (IRNAV/IAN)
28	Ground proximity warning system (GPWS)/terrain awareness warning system (TAWS)/ground collision avoidance system (GCAS) status:
28a	Selection of terrain display mode, including pop-up display status
28b	Terrain alerts, including cautions and warnings and advisories
28c	On/off switch position
29	Angle of attack
30	Low pressure warning (each system):
30a	Hydraulic pressure
30b	Pneumatic pressure
31	Ground speed
32	Landing gear:
32a	Landing gear position
32b	Gear selector position
33	Navigation data:
33a	Drift angle
33b	Wind speed
33c	Wind direction
33d	Latitude
33e	Longitude
33f	GNSS augmentation in use
34	Brakes:
34a	Left and right brake pressure
34b	Left and right brake pedal position
35	Additional engine parameters (if not already recorded in parameter 9 of Table 1 of AMC1 CAT.IDE.190.A, and if the aeroplane is equipped with a suitable data source):
35a	Engine pressure ratio (EPR)
35b	N1
35c	Indicated vibration level
35d	N2
35e	Exhaust gas temperature (EGT)
35f	Fuel flow
35g	Fuel cut-off lever position
35h	N3
36	Traffic alert and collision avoidance system (TCAS)/airborne collision avoidance system (ACAS) — a suitable combination of discrettes should be recorded to determine the status of the system:
36a	Combined control

No*	Parameter
36b	Vertical control
36c	Up advisory
36d	Down advisory
36e	Sensitivity level
37	Wind shear warning
38	Selected barometric setting
38a	Pilot selected barometric setting
38b	Co-pilot selected barometric setting
39	Selected altitude (all pilot selectable modes of operation) — to be recorded for the aeroplane where the parameter is displayed electronically
40	Selected speed (all pilot selectable modes of operation) — to be recorded for the aeroplane where the parameter is displayed electronically
41	Selected Mach (all pilot selectable modes of operation) — to be recorded for the aeroplane where the parameter is displayed electronically
42	Selected vertical speed (all pilot selectable modes of operation) — to be recorded for the aeroplane where the parameter is displayed electronically
43	Selected heading (all pilot selectable modes of operation) — to be recorded for the aeroplane where the parameter is displayed electronically
44	Selected flight path (All pilot selectable modes of operation) — to be recorded for the aeroplane where the parameter is displayed electronically
44a	Course/desired track (DSTRK)
44b	Path angle
44c	Coordinates of final approach path (IRNAV/IAN)
45	Selected decision height — to be recorded for the aeroplane where the parameter is displayed electronically
46	Electronic flight instrument system (EFIS) display format:
46a	Pilot
46b	Co-pilot
47	Multi-function/engine/alerts display format
48	Alternating current (AC) electrical bus status — each bus
49	Direct current (DC) electrical bus status — each bus
50	Engine bleed valve position
51	Auxiliary power unit (APU) bleed valve position
52	Computer failure — (all critical flight and engine control systems)
53	Engine thrust command
54	Engine thrust target
55	Computed centre of gravity (CG)
56	Fuel quantity in CG trim tank
57	Head up display in use
58	Para visual display on
59	Operational stall protection, stick shaker and pusher activation
60	Primary navigation system reference:
60a	GNSS
60b	Inertial navigational system (INS)
60c	VHF omnidirectional radio range (VOR)/distance measuring equipment (DME)
60d	MLS
60e	Loran C
60f	ILS
61	Ice detection

No*	Parameter
62	Engine warning — each engine vibration
63	Engine warning — each engine over temperature
64	Engine warning — each engine oil pressure low
65	Engine warning — each engine over speed
66	Yaw trim surface position
67	Roll trim surface position
68	Yaw or sideslip angle
69	De-icing and/or anti-icing systems selection
70	Hydraulic pressure — each system
71	Loss of cabin pressure
72	Trim control input position in the flight crew compartment, pitch — when mechanical means for control inputs are not available, displayed trim position or trim command should be recorded.
73	Trim control input position in the flight crew compartment, roll — when mechanical means for control inputs are not available, displayed trim position or trim command should be recorded.
74	Trim control input position in the flight crew compartment, yaw — when mechanical means for control inputs are not available, displayed trim position or trim command should be recorded.
75	All flight control input forces (for fly-by-wire flight control systems, where control surface position is a function of the displacement of the control input device only, it is not necessary to record this parameter):
75a	Control wheel
75b	Control column
75c	Rudder pedal
76	Event marker
77	Date
78	Actual navigation performance (ANP) or estimate of position error (EPE) or estimate of position uncertainty (EPU)

* The number in the left hand column reflects the serial number depicted in EUROCAE Document ED-112.

AMC1.2 CAT.IDE.A.190 Flight data recorder

ED Decision 2021/005/R

OPERATIONAL PERFORMANCE REQUIREMENTS FOR AEROPLANES FIRST ISSUED WITH AN INDIVIDUAL CofA ON OR AFTER 1 JANUARY 2023

- (a) The operational performance requirements for FDRs should be those laid down in EUROCAE Document 112A (Minimum Operational Performance Specification for Crash Protected Airborne Recorder Systems) dated September 2013, or any later equivalent standard produced by EUROCAE.
- (b) The FDR should, with reference to a timescale, record:
 - (1) the list of parameters in Table 1 below;
 - (2) the additional parameters listed in Table 2 below, when the information data source for the parameter is used by aeroplane systems or is available on the instrument panel for use by the flight crew to operate the aeroplane; and
 - (3) any dedicated parameters related to novel or unique design or operational characteristics of the aeroplane as determined by the Agency.

- (c) The parameters to be recorded should meet the performance specifications (range, sampling intervals, accuracy limits and resolution in read-out) as defined in the relevant tables of EUROCAE Document 112A, or any later equivalent standard produced by EUROCAE.

Table 1: FDR — All aeroplanes

No*	Parameter
1a	Time; or
1b	Relative time count
1c	Global navigation satellite system (GNSS) time synchronisation
2	Pressure altitude (including altitude values displayed on each flight crew member's primary flight display, unless the aeroplane is type certified before 1 January 2023 and recording the values displayed at the captain position or the first officer position would require extensive modification)
3	Indicated airspeed or calibrated airspeed (including values of indicated airspeed or calibrated airspeed displayed on each flight crew member's primary flight display, unless the aeroplane is type certified before 1 January 2023 and recording the values displayed at the captain position or the first officer position would require extensive modification)
4	Heading (primary flight crew reference) — when true or magnetic heading can be selected as the primary heading reference, a discrete indicating selection should be recorded.
5	Normal acceleration
6	Pitch attitude — pitch attitude values displayed on each flight crew member's primary flight display should be recorded, unless the aeroplane is type certified before 1 January 2023 and recording the values displayed at the captain position or the first officer position would require extensive modification.
7	Roll attitude — roll attitude values displayed on each flight crew member's primary flight display should be recorded, unless the aeroplane is type certified before 1 January 2023 and recording the values displayed at the captain position or the first officer position would require extensive modification.
8	Manual radio transmission keying and CVR/FDR synchronisation reference
9	Engine thrust/power:
9a	Parameters required to determine propulsive thrust/power on each engine, in both normal and reverse thrust
9b	Flight crew compartment thrust/power lever position (for aeroplanes with non-mechanically linked engine controls in the flight crew compartment)
14	Total or outside air temperature
16	Longitudinal acceleration (body axis)
17	Lateral acceleration
18	Primary flight control surface and/or primary flight control pilot input (For aeroplanes with control systems in which the movement of a control surface will back drive the pilot's control, 'or' applies. For aeroplanes with control systems in which the movement of a control surface will not back drive the pilot's control, 'and' applies. For multiple or split surfaces, a suitable combination of inputs is acceptable in lieu of recording each surface separately. For aeroplanes that have a flight control break-away capability that allows either pilot to operate the controls independently, record both inputs):
18a	Pitch axis
18b	Roll axis
18c	Yaw axis
19	Pitch trim surface position
23	Marker beacon passage
24	Warnings — In addition to the master warning, each 'red' warning that cannot be determined from other parameters or from the CVR and each smoke warning from other compartments should be recorded.

25	Each navigation receiver frequency selection
27	Air–ground status. Air–ground status and a sensor of each landing gear if installed

* The number in the left-hand column reflects the serial number depicted in EUROCAE Document 112A.

Table 2: FDR — Aeroplanes for which the data source for the parameter is either used by the aeroplane systems or is available on the instrument panel for use by the flight crew to operate the aeroplane

No*	Parameter
10	Flaps:
10a	Trailing edge flap position
10b	Flight crew compartment control selection
11	Slats:
11a	Leading edge flap (slat) position
11b	Flight crew compartment control selection
12	Thrust reverse status
13	Ground spoiler and speed brake:
13a	Ground spoiler position
13b	Ground spoiler selection
13c	Speed brake position
13d	Speed brake selection
15	Autopilot, autothrottle and automatic flight control system (AFCS): mode and engagement status (showing which systems are engaged and which primary modes are controlling the flight path and speed of the aircraft)
20	Radio altitude. For auto-land/category III operations, each radio altimeter should be recorded.
21	Vertical deviation — the approach aid in use should be recorded. For auto-land/category III operations, each system should be recorded:
21a	ILS/GPS/GLS glide path
21b	MLS elevation
21c	Integrated approach navigation (IAN) /Integrated Area Navigation (IRNAV), vertical deviation
22	Horizontal deviation — the approach aid in use should be recorded. For auto-land/category III operations, each system should be recorded:
22a	ILS/GPS/GLS localiser
22b	MLS azimuth
22c	GNSS approach path/IRNAV lateral deviation
26	Distance measuring equipment (DME) 1 and 2 distances:
26a	Distance to runway threshold (GLS)
26b	Distance to missed approach point (IRNAV/IAN)
28	Ground proximity warning system (GPWS)/terrain awareness warning system (TAWS)/ground collision avoidance system (GCAS) status — a suitable combination of discretes unless recorder capacity is limited in which case a single discrete for all modes is acceptable:
28a	Selection of terrain display mode, including pop-up display status
28b	Terrain alerts, including cautions and warnings and advisories
28c	On/off switch position
29	Angle of attack
30	Low pressure warning (each system):
30a	Hydraulic pressure
30b	Pneumatic pressure
31	Ground speed
32	Landing gear:
32a	Landing gear position
32b	Gear selector position

No*	Parameter
33	Navigation data:
33a	Drift angle
33b	Wind speed
33c	Wind direction
33d	Latitude
33e	Longitude
33f	GNSS augmentation in use
34	Brakes:
34a	Left and right brake pressure
34b	Left and right brake pedal position
35	Additional engine parameters (if not already recorded in parameter 9 of Table 1, and if the aeroplane is equipped with a suitable data source):
35a	Engine pressure ratio (EPR)
35b	N1
35c	Indicated vibration level
35d	N2
35e	Exhaust gas temperature (EGT)
35f	Fuel flow
35g	Fuel cut-off lever position
35h	N3
35i	Engine fuel metering valve position (or equivalent parameter from the system that directly controls the flow of fuel into the engine) – for aeroplanes type certified before 1 January 2023, to be recorded only if this does not require extensive modification.
36	Traffic alert and collision avoidance system (TCAS)/airborne collision avoidance system (ACAS) — a suitable combination of discrettes should be recorded to determine the status of the system:
36a	Combined control
36b	Vertical control
36c	Up advisory
36d	Down advisory
36e	Sensitivity level
37	Wind shear warning
38	Selected barometric setting — to be recorded for the aeroplane where the parameter is displayed electronically:
38a	Pilot selected barometric setting
38b	Co-pilot selected barometric setting
39	Selected altitude (all pilot selectable modes of operation) — to be recorded for the aeroplane where the parameter is displayed electronically
40	Selected speed (all pilot selectable modes of operation) — to be recorded for the aeroplane where the parameter is displayed electronically
41	Selected Mach (all pilot selectable modes of operation) — to be recorded for the aeroplane where the parameter is displayed electronically
42	Selected vertical speed (all pilot selectable modes of operation) — to be recorded for the aeroplane where the parameter is displayed electronically
43	Selected heading (all pilot selectable modes of operation) — to be recorded for the aeroplane where the parameter is displayed electronically
44	Selected flight path (all pilot selectable modes of operation) — to be recorded for the aeroplane where the parameter is displayed electronically:
44a	Course/desired track (DSTRK)
44b	Path angle
44c	Coordinates of final approach path (IRNAV/IAN)

No*	Parameter
45	Selected decision height — to be recorded for the aeroplane where the parameter is displayed electronically
46	Electronic flight instrument system (EFIS) display format, showing the display system status:
46a	Pilot
46b	Co-pilot
47	Multi-function/engine/alerts display format, showing the display system status
48	Alternating current (AC) electrical bus status — each bus
49	Direct current (DC) electrical bus status — each bus
50	Engine bleed valve(s) position
51	Auxiliary power unit (APU) bleed valve(s) position
52	Computer failure — all critical flight and engine control systems
53	Engine thrust command
54	Engine thrust target
55	Computed centre of gravity (CG)
56	Fuel quantity in CG trim tank
57	Head-up display in use
58	Paravisual display on
59	Operational stall protection, stick shaker and pusher activation
60	Primary navigation system reference:
60a	GNSS
60b	Inertial navigational system (INS)
60c	VHF omnidirectional radio range (VOR)/distance measuring equipment (DME)
60d	MLS
60e	Loran C
60f	ILS
61	Ice detection
62	Engine warning — each engine vibration
63	Engine warning — each engine over temperature
64	Engine warning — each engine oil pressure low
65	Engine warning — each engine overspeed
66	Yaw trim surface position
67	Roll trim surface position
68	Yaw or sideslip angle
69	De-icing and/or anti-icing systems selection
70	Hydraulic pressure — each system
71	Loss of cabin pressure
72	Trim control input position in the flight crew compartment, pitch — when mechanical means for control inputs are not available, displayed trim position or trim command should be recorded.
73	Trim control input position in the flight crew compartment, roll — when mechanical means for control inputs are not available, displayed trim position or trim command should be recorded.
74	Trim control input position in the flight crew compartment, yaw — when mechanical means for control inputs are not available, displayed trim position or trim command should be recorded.
75	All flight control input forces (for fly-by-wire flight control systems, where control surface position is a function of the displacement of the control input device only, it is not necessary to record this parameter):
75a	Control wheel input forces
75b	Control column input forces
75c	Rudder pedal input forces

No*	Parameter
76	Event marker
77	Date
78	Actual navigation performance (ANP) or estimate of position error (EPE) or estimate of position uncertainty (EPU)
79	Cabin pressure altitude – for aeroplanes type certified before 1 January 2023, to be recorded only if this does not require extensive modification
80	Aeroplane computed weight – for aeroplanes type certified before 1 January 2023, to be recorded only if this does not require extensive modification
81	Flight director command:
81a	Left flight director pitch command – for aeroplanes type certified before 1 January 2023, to be recorded only if this does not require extensive modification
81b	Left flight director roll command – for aeroplanes type certified before 1 January 2023, to be recorded only if this does not require extensive modification
81c	Right flight director pitch command – for aeroplanes type certified before 1 January 2023, to be recorded only if this does not require extensive modification
81d	Right flight director roll command – for aeroplanes type certified before 1 January 2023, to be recorded only if this does not require extensive modification
82	Vertical speed – for aeroplanes type certified before 1 January 2023, to be recorded only if this does not require extensive modification

* The number in the left-hand column reflects the serial number depicted in EUROCAE Document 112A.

AMC2 CAT.IDE.A.190 Flight data recorder

ED Decision 2022/012/R

OPERATIONAL PERFORMANCE REQUIREMENTS FOR AEROPLANES FIRST ISSUED WITH AN INDIVIDUAL CofA ON OR AFTER 1 APRIL 1998 AND BEFORE 1 JANUARY 2016

- (a) The operational performance requirements for FDRs should be those laid down in EUROCAE Document ED-55 (Minimum Operational Performance Requirements For Flight Data Recorder Systems) dated May 1990, or EUROCAE Document ED-112 (Minimum Operational Performance Specification for Crash Protected Airborne Recorder Systems) dated March 2003, including amendments No 1 and No², or any later equivalent standard produced by EUROCAE.
- (b) The FDR should record, with reference to a timescale:
- (1) the parameters listed in Table 1a or Table 1b below, as applicable;
 - (2) the additional parameters listed in Table 2 below, for those aeroplanes with an MCTOM exceeding 27 000 kg;
 - (3) any dedicated parameters relating to novel or unique design or operational characteristics of the aeroplane as determined by the competent authority; and
 - (4) the additional parameters listed in Table 3 below, for those aeroplanes equipped with electronic display systems.
- (c) The FDR of aeroplanes first issued with an individual CofA before 20 August 2002 and equipped with an electronic display system does not need to record those parameters listed in Table 3 for which:
- (1) the sensor is not available;
 - (2) the aeroplane system or equipment generating the data needs to be modified; or
 - (3) the signals are incompatible with the recording system;

- (d) The FDR of aeroplanes first issued with an individual CofA on or after 1 April 1998 but not later than 1 April 2001 is not required to comply with (b) above if:
- (1) compliance with (a) cannot be achieved without extensive modification to the aeroplane system and equipment other than the flight recording system; and
 - (2) the FDR of the aeroplane can comply with [AMC4 CAT.IDE.A.190](#)(a) except that parameter 15b in Table 1 of [AMC4 CAT.IDE.A.190](#) need not be recorded.
- (e) The parameters to be recorded should meet, as far as practicable, the performance specifications (ranges, sampling intervals, accuracy limits, and resolution in read-out) defined in Table 1 of [AMC3 CAT.IDE.A.190](#).
- (f) For aeroplanes with novel or unique design or operational characteristics, the additional parameters should be those required in accordance with applicable Certification Specifications during type or supplemental certification or validation.
- (g) If recording capacity is available, as many as possible of the additional parameters specified in table II-A.1 of EUROCAE Document ED 112 dated March 2003 should be recorded.

Table 1a

FDR — Aeroplanes with an MCTOM of more than 5 700 kg

No	Parameter
1	Time or relative time count
2	Pressure altitude
3	Indicated airspeed or calibrated airspeed
4	Heading
5	Normal acceleration
6	Pitch attitude
7	Roll attitude
8	Manual radio transmission keying
9	Propulsive thrust/power on each engine and flight crew compartment thrust/power lever position if applicable
10	Trailing edge flap or flight crew compartment control selection
11	Leading edge flap or flight crew compartment control selection
12	Thrust reverse status
13	Ground spoiler position and/or speed brake selection
14	Total or outside air temperature
15	Autopilot, autothrottle and AFCS mode and engagement status
16	Longitudinal acceleration (body axis)
17	Lateral acceleration

Table 1b

FDR — Aeroplanes with an MCTOM 5 700 kg or below

No	Parameter
1	Time or relative time count
2	Pressure altitude
3	Indicated airspeed or calibrated airspeed
4	Heading

No	Parameter
5	Normal acceleration
6	Pitch attitude
7	Roll attitude
8	Manual radio transmission keying
9	Propulsive thrust/power on each engine and flight crew compartment thrust/power lever position if applicable
10	Trailing edge flap or flight crew compartment control selection
11	Leading edge flap or flight crew compartment control selection
12	Thrust reverse status
13	Ground spoiler position and/or speed brake selection
14	Total or outside air temperature
15	Autopilot/autothrottle engagement status
16	Longitudinal acceleration (body axis)
17	Angle of attack (if a suitable sensor is available)

Table 2

FDR — Additional parameters for aeroplanes with an MCTOM of more than 27 000 kg

No	Parameter
18	Primary flight controls — control surface position and/or pilot input (pitch, roll, yaw)
19	Pitch trim position
20	Radio altitude
21	Vertical beam deviation (ILS or GLS glide path or MLS elevation)
22	Horizontal beam deviation (ILS localiser or GLS lateral deviation or MLS azimuth)
23	Marker beacon passage
24	Warnings
25	Reserved (navigation receiver frequency selection or GLS channel is recommended)
26	Reserved (DME or GLS distance is recommended)
27	Landing gear squat switch status or air/ground status
28	Ground proximity warning system
29	Angle of attack
30	Low pressure warning (hydraulic and pneumatic power)
31	Groundspeed
32	Landing gear or gear selector position

Table 3

FDR — Aeroplanes equipped with electronic display systems

No	Parameter
33	Selected barometric setting (each pilot station)
34	Selected altitude
35	Selected speed
36	Selected Mach
37	Selected vertical speed
38	Selected heading

No	Parameter
39	Selected flight path
40	Selected decision height
41	EFIS display format
42	Multi-function/engine/alerts display format

AMC3 CAT.IDE.A.190 Flight data recorder

ED Decision 2022/012/R

PERFORMANCE SPECIFICATIONS FOR THE PARAMETERS TO BE RECORDED FOR AEROPLANES FIRST ISSUED WITH AN INDIVIDUAL CofA ON OR AFTER 1 APRIL 1998 AND BEFORE 1 JANUARY 2016

Table 1: FDR

No	Parameter	Range	Sampling interval in seconds	Accuracy limits (sensor input compared to FDR readout)	Recommended resolution in readout	Remarks
1a or	Time	24 hours	4	± 0.125 % per hour	1 second	(a) UTC time preferred where available.
1b	Relative time count	0 to 4 095	4	± 0.125 % per hour		(b) Counter increments every 4 seconds of system operation.
2	Pressure altitude	-1 000 ft to maximum certificated altitude of aircraft +5 000 ft	1	±100 ft to ±700 ft Refer to Table II-A.3 of EUROCAE Document ED-112	5 ft	Should be obtained from air data computer when installed.
3	Indicated airspeed or calibrated airspeed	50 kt or minimum value installed pitot static system to Max V _{SO} Max V _{SO} to 1.2 V _D	1	±5 % ±3 %	1 kt (0.5 kt recommended)	Should be obtained from air data computer when installed. V _{SO} : stalling speed or minimum steady flight speed in the landing configuration V _D design diving speed
4	Heading	360 degrees	1	±2 degrees	0.5 degrees	
5	Normal acceleration	-3 g to +6 g	0.125	1 % of maximum range excluding a datum error of 5 %	0.004 g	The recording resolution may be rounded from 0.004 g to 0.01 g provided that one sample is recorded at full resolution at least every 4 seconds.
6	Pitch attitude	±75 degrees	0.25	±2 degrees	0.5 degrees	
7	Roll attitude	±180 degrees	0.5	±2 degrees	0.5 degrees	

No	Parameter	Range	Sampling interval in seconds	Accuracy limits (sensor input compared to FDR readout)	Recommended resolution in readout	Remarks
8	Manual radio transmission keying	Discrete	1	-	-	Preferably each crew member but one discrete acceptable for all transmissions provided that the replay of a recording made by any required recorder can be synchronised in time with any other required recording to within 1 second.
9a	Propulsive thrust/power on each engine	Full range	Each engine each second	±2 %	0.2 % of full range	Sufficient parameters, e.g. EPR/N _P , or Torque/N _P as appropriate to the particular engine must be recorded to determine power in both normal and reverse thrust. A margin for possible overspeed should be provided.
9b	Flight crew compartment thrust/power lever position	Full range	Each lever each second	±2 % or sufficient to determine any gated position	2 % of full range	Parameter 9b must be recorded for aeroplanes with non-mechanically linked cockpit-engine controls, otherwise recommended.
10	Trailing edge flap or flight crew compartment control selection	Full range or each discrete position	2	±3° or as pilot's indicator and sufficient to determine each discrete position	0.5 % of full range	Flap position and cockpit control may be sampled at 4-second intervals so as to give a data point each 2 seconds.
11	Leading edge flap or flight crew compartment control selection	Full range or each discrete position	1	±3° or as pilot's indicator and sufficient to determine each discrete position	0.5 % of full range	Left and right sides, or flap position and cockpit control may be sampled at 2-second intervals so as to give a data point each second.
12	Thrust reverser status	Turbo-jet: stowed, in transit and reverse Turbo-prop: reverse	Each reverser each second	-	-	Turbo-jet: 2 discretises enable the 3 states to be determined Turbo-prop: 1 discrete
13	Ground spoiler and/or speed brake selection	Full range or each discrete position	0.5	±2° unless higher accuracy uniquely required	0.2 % of full range	Sufficient to determine use of the cockpit selector and the activation and positions of the surfaces

No	Parameter	Range	Sampling interval in seconds	Accuracy limits (sensor input compared to FDR readout)	Recommended resolution in readout	Remarks
14	Outside air temperatures or total air temperature	-50°C to +90°C or available sensor range	2	±2°C	0.3°C	
15	Autopilot/Autothrottle /AFCS mode and engagement status	A suitable combination of discrettes	1	-	-	Discrettes should show which systems are engaged and which primary modes are controlling the flight path and speed of the aircraft.
16	Longitudinal acceleration (Body axis)	± 1 g	0.25	±1.5 % of maximum range excluding a datum error of ±5 %	0.004 g	The recording resolution may be rounded from 0.004 g to 0.01 g provided that one sample is recorded at full resolution at least every 4 seconds.
17	Lateral acceleration	±1 g	0.25	±1.5 % of maximum range excluding a datum error of ±5 %	0.004 g	The recording resolution may be rounded from 0.004 g to 0.01 g provided that one sample is recorded at full resolution at least every 4 seconds.
18	Primary flight controls, control surface positions and/or* pilot input	Full range	1	±2° unless higher accuracy uniquely required	0.2 % of full range	*For aeroplanes that can demonstrate the capability of deriving either the control input or control movement (one from the other) for all modes of operation and flight regimes, the 'or' applies. For aeroplanes with non-mechanical control systems, the 'and' applies.
18a	Pitch axis		0.25			Where the input controls for each pilot can be operated independently, both inputs will need to be recorded. For multiple or split surfaces, a suitable combination of inputs is acceptable in lieu of recording each surface separately.
18b	Roll axis		0.25			
18c	Yaw axis		0.5			
19	Pitch trim position	Full range	1	±3 % unless higher accuracy uniquely required	0.3 % of full range	Where dual surfaces are provided it is permissible to record each surface alternately.

No	Parameter	Range	Sampling interval in seconds	Accuracy limits (sensor input compared to FDR readout)	Recommended resolution in readout	Remarks
20	Radio altitude	-20 ft to +2 500 ft	1	As installed ±2 ft or ±3 % whichever is greater below 500 ft and ±5 % above 500 ft recommended.	1 ft below 500 ft, 1 ft +0.5 % of full range above 500 ft	For auto-land/category III operations, each radio altimeter should be recorded, but arranged so that at least one is recorded each second.
21	Vertical beam deviation		1	As installed ±3 % recommended	0.3 % of full range	Data from all of the ILS, GLS and MLS systems need not to be recorded at the same time. The approach aid in use should be recorded. For auto-land/ category III operations, each radio altimeter should be recorded, but arranged so that at least one is recorded each second.
21a	ILS or GLS glide path	±0.22 DDM or available sensor range as installed				
21b	MLS elevation	0.9° to 30°				
22	Horizontal beam deviation	Signal range	1	As installed ±3 % recommended	0.3 % of full range	See parameter 21 remarks.
22a	ILS localiser or GLS lateral deviation	±0.22 DDM or available sensor range as installed				
22b	MLS azimuth	±62°				
23	Marker beacon passage	Discrete	1	—	—	A single discrete is acceptable for all markers.
24	Warnings	Discretes	1	—	—	A discrete must be recorded for the master warning. Each 'red' warning (including lavatory smoke) should be recorded when the warning condition cannot be determined from other parameters or from the cockpit voice recorder.
25	Reserved	—	—	—	—	
26	Reserved	—	—	—	—	
27	Landing gear squat switch status	Discrete(s)	1 (0.25 recommended for main gears)	—	—	Discretes should be recorded for the nose and main landing gears.

No	Parameter	Range	Sampling interval in seconds	Accuracy limits (sensor input compared to FDR readout)	Recommended resolution in readout	Remarks
28	Ground proximity warning system (GPWS)	Discrete	1	–	–	A suitable combination of discretely unless recorder capacity is limited in which case a single discrete for all modes is acceptable.
29	Angle of attack	As installed	0.5	As installed	0.3 % of full range	If left and right sensors are available, each may be recorded at 1-second intervals so as to give a data point each half second.
30	Low pressure warning	Discrete(s) or available sensor range	2	-	0.5 % of full range	Each essential system to be recorded.
30a	Hydraulic power					
30b	Pneumatic power					
31	Groundspeed	As installed	1	Data should be obtained from the most accurate system	1 kt	
32	Landing gear or gear selector position	Discrete(s)	4	-	–	A suitable combination of discretely should be recorded.
33	Selected barometric setting (each pilot station)	As installed	64	As installed	1 mb	Where practicable, a sampling interval of 4 seconds is recommended
33a	Pilot					
33b	Co-pilot					
34	Selected altitude	As installed	1	As installed	100 ft	Where capacity is limited, a sampling interval of 64 seconds is permissible.
34a	Manual					
34b	Automatic					
35	Selected speed	As installed	1	As installed	1 kt	Where capacity is limited, a sampling interval of 64 seconds is permissible.
35a	Manual					
35b	Automatic					
36	Selected Mach	As installed	1	As installed	0.01	Where capacity is limited, a sampling interval of 64 seconds is permissible.
36a	Manual					
36b	Automatic					

No	Parameter	Range	Sampling interval in seconds	Accuracy limits (sensor input compared to FDR readout)	Recommended resolution in readout	Remarks
37	Selected vertical speed	As installed	1	As installed	100 ft/min	Where capacity is limited, a sampling interval of 64 seconds is permissible.
37a	Manual					
37b	Automatic					
38	Selected heading	360 degrees	1	As installed	1 degree	Where capacity is limited, a sampling interval of 64 seconds is permissible.
39	Selected flight path	360 degrees	1	As installed		Where capacity is limited, a sampling interval of 64 seconds is permissible.
39a	Course/DSTRK					
39b	Path Angle					
40	Selected decision height	0-500 ft	64	As installed	1 ft	
41	EFIS display format	Discrete(s)	4	–	–	Discretes should show the display system status e.g. off, normal, fail, composite, sector, plan, rose, nav aids, wxr, range, copy.
41a	Pilot					
41b	Co-pilot					
42	Multifunction/Engine/ Alerts display format	Discrete(s)	4	–	–	Discretes should show the display system status e.g. off, normal, fail, and the identity of display pages for emergency procedures and checklists. Information in checklists and procedures need not be recorded.

AMC4 CAT.IDE.A.190 Flight data recorder

ED Decision 2019/019/R

LIST OF PARAMETERS TO BE RECORDED FOR AEROPLANES FIRST ISSUED WITH AN INDIVIDUAL CofA ON OR AFTER 1 JUNE 1990 UP TO AND INCLUDING 31 MARCH 1998

- (a) The FDR should, with reference to a timescale, record:
 - (1) the parameters listed in Table 1 below; and
 - (2) the additional parameters listed in Table 2 below for those aeroplanes with an MCTOM exceeding 27 000 kg.
- (b) The FDR of aeroplanes having an MCTOM of 27 000 kg or below does not need to record parameters 14 and 15b of Table 1 below if any of the following conditions are met:
 - (1) the sensor is not readily available;
 - (2) sufficient capacity is not available in the flight recorder system; or
 - (3) a change is required in the equipment that generates the data.
- (c) The FDR of aeroplanes having an MCTOM exceeding 27 000 kg does not need to record parameter 15b of Table 1 below, and parameters 23, 24, 25, 26, 27, 28, 29, 30 and 31 of Table 2 below, if any of the following conditions are met:
 - (1) the sensor is not readily available;
 - (2) sufficient capacity is not available in the FDR system;
 - (3) a change is required in the equipment that generates the data; or
 - (4) for navigational data (NAV frequency selection, DME distance, latitude, longitude, ground speed and drift), the signals are not available in digital form.
- (d) The FDR does not need to record individual parameters that can be derived by calculation from the other recorded parameters.
- (e) The parameters to be recorded should meet, as far as practicable, the performance specifications (range, sampling intervals, accuracy limits, and resolution in read-out) defined in Table 1 of [AMC5 CAT.IDE.A.190](#).

Table 1

Flight data recorder — Aeroplanes with an MCTOM of more than 5 700 kg

No	Parameter
1	Time or relative time count
2	Pressure altitude
3	Indicated airspeed or calibrated airspeed
4	Heading
5	Normal acceleration
6	Pitch attitude
7	Roll attitude
8	Manual radio transmission keying unless an alternate means to synchronise FDR and CVR recordings is provided
9	Power on each engine
10	Trailing edge flap or flight crew compartment control selection

11	Leading edge flap or flight crew compartment control selection
12	Thrust reverse position (for turbojet aeroplanes only)
13	Ground spoiler position and/or speed brake selection
14	Outside air temperature or total air temperature
15a	Autopilot engagement status
15b	Autopilot operating modes, autothrottle and AFCS systems engagement status and operating modes.

Table 2

Flight data recorder — Additional parameters for aeroplanes with an MCTOM of more than 27 000 kg

No	Parameter
16	Longitudinal acceleration
17	Lateral acceleration
18	Primary flight controls — control surface position and/or pilot input (pitch, roll and yaw)
19	Pitch trim position
20	Radio altitude
21	Glide path deviation
22	Localiser deviation
23	Marker beacon passage
24	Master warning
25	NAV 1 and NAV 2 frequency selection
26	DME 1 and DME 2 distance
27	Landing gear squat switch status
28	Ground proximity warning system (GPWS)
29	Angle of attack
30	Hydraulics, each system (low pressure)
31	Navigation data
32	Landing gear or gear selector position

AMC5 CAT.IDE.A.190 Flight data recorder

ED Decision 2015/007/R

PERFORMANCE SPECIFICATIONS FOR THE PARAMETERS TO BE RECORDED FOR AEROPLANES FIRST ISSUED WITH AN INDIVIDUAL COFA UP TO AND INCLUDING 31 MARCH 1998

Table 1: Flight data recorder

No	Parameter	Range	Sampling interval in seconds	Accuracy limits (sensor input compared to FDR readout)	Recommended resolution in readout	Remarks
1	Time or relative time count	24 hours	4	±0.125 % per hour	1 second	Coordinated universal time (UTC) preferred where available, otherwise elapsed time
2	Pressure altitude	-1 000 ft to maximum certificated altitude of aircraft +5 000 ft	1	±100 ft to ±700 ft	5 ft	For altitude record error see EASA ETSO-C124a
3	Indicated airspeed or calibrated airspeed	50 kt to max V _{SO} Max V _{SO} to 1.2 V _D	1	±5 % ±3 %	1 kt	V _{SO} stalling speed or minimum steady flight speed in the landing configuration V _D design diving speed
4	Heading	360 degrees	1	±2 degrees	0.5 degrees	
5	Normal acceleration	-3 g to +6 g	0.125 ±	±1 % of maximum range excluding a datum error of ±5 %	0.004 g	
6	Pitch attitude	±75 degrees	1	±2 degrees	0.5 degrees	
7	Roll attitude	±180 degrees	1	±2 degrees	0.5 degrees	
8	Manual radio transmission keying	Discrete	1	-	-	On-off (one discrete). An FDR/CVR time synchronisation signal complying with 4.2.1 of EUROCAE ED-55 is considered to be an acceptable alternative means of compliance.
9	Power on each engine	Full range	Each engine each second	±2 %	0.2 % of full range	Sufficient parameters e.g. EPR/N, or Torque/N _p as appropriate to the particular engine should be recorded to determine power.

No	Parameter	Range	Sampling interval in seconds	Accuracy limits (sensor input compared to FDR readout)	Recommended resolution in readout	Remarks
10	Trailing edge flap or flight crew compartment control selection	Full range or each discrete position	2	±5 % or as pilot's indicator	0.5 % of full range	
11	Leading edge flap or flight crew compartment control selection	Full range or each discrete position	2	-	0.5 % of full range	
12	Thrust reverser position	Stowed, in transit and reverse	Each reverser each second	±2 % unless higher accuracy uniquely required	-	
13	Ground spoiler and/or speed brake selection	Full range or each discrete position	1	±2 degrees	0.2 % of full range	
14	Outside air temperatures or total air temperature	Sensor range	2	-	0.3°C	
15a	Autopilot engagement status	A suitable combination of discrettes	1		-	
15b	Autopilot operating modes, auto-throttle and AFCS systems engagement status and operating modes					
16	Longitudinal acceleration	± 1 g	0.25	±1.5 % of maximum range excluding a datum error of ±5 %	0.004 g	
17	Lateral acceleration	±1 g	0.25	±1.5 % of maximum range excluding a datum error of ±5 %	0.004 g	
18	Primary flight controls, control surface positions and/or pilot input (pitch, roll, yaw)	Full range	1	±2 degrees unless higher accuracy uniquely required	0.2 % of full range	For aeroplanes with conventional control systems, 'or' applies. For aeroplanes with non-mechanical control systems, 'and' applies.

No	Parameter	Range	Sampling interval in seconds	Accuracy limits (sensor input compared to FDR readout)	Recommended resolution in readout	Remarks
						For aeroplanes with split surfaces, a suitable combination of inputs is acceptable in lieu of recording each surface separately.
19	Pitch trim position	Full range	1	±3 % unless higher accuracy uniquely required	0.3 % of full range	
20	Radio altitude	-20 ft to +2 500 ft	1	±2 ft or ±3 % whichever is greater below 500 ft and ±5 % above 500 ft	1 ft below 500 ft, 1 ft +5 % of full range above 500 ft	As installed. Accuracy limits are recommended
21	Glide path deviation	Signal range	1	±3 %	0.3 % of full range	As installed. Accuracy limits are recommended
22	Localiser deviation	Signal range	1	±3 %	0.3 % of full range	As installed. Accuracy limits are recommended.
23	Marker beacon passage	Discrete	1	–	–	A single discrete is acceptable for all markers.
24	Master warning	Discrete	1	–	–	
25	NAV 1 and 2 frequency selection	Full range	4	As installed	–	
26	DME 1 and 2 distance	0-200 NM	4	As installed	–	Recording of latitude and longitude from INS or other navigation system is a preferred alternative.
27	Landing gear squat switch status	Discrete	1	–	–	
28	Ground proximity warning system (GPWS)	Discrete	1	–	–	
29	Angle of attack	Full range	0.5	As installed	0.3 % of full range	
30	Hydraulics	Discrete(s)	2	–	–	
31	Navigation data	As installed	1	As installed	–	

No	Parameter	Range	Sampling interval in seconds	Accuracy limits (sensor input compared to FDR readout)	Recommended resolution in readout	Remarks
32	Landing gear or gear selector position	Discrete	4	As installed	–	

* The number in the left hand column reflects the serial number depicted in EUROCAE Document ED-112.

AMC6 CAT.IDE.A.190 Flight data recorder
ED Decision 2019/019/R
LIST OF PARAMETERS TO BE RECORDED FOR AEROPLANES FIRST ISSUED WITH AN INDIVIDUAL CofA BEFORE 1 JUNE 1990

- (a) The FDR should, with reference to a timescale, record:
 - (1) the parameters listed in Table 1 below;
 - (2) the additional parameters 6 to 15b of Table 2 below, for aeroplanes with an MCTOM exceeding 5 700 kg but not exceeding 27 000 kg and first issued with an individual CofA on or after 1 January 1989, when the following conditions are met:
 - (i) sufficient capacity is available on a flight recorder system;
 - (ii) the sensor is readily available; and
 - (iii) a change is not required in the equipment that generates the data;
 - (3) the additional parameters from 6 to 15b of Table 2 below, for aeroplanes with a maximum certificated take-off mass exceeding 27 000 kg that are of a type first type certified after 30 September 1969; and
 - (4) the additional parameters listed in Table 2 below for aeroplanes with an MCTOM exceeding 27 000 kg and first issued with an individual CofA on or after 1 January 1987, when the following conditions are met:
 - (i) sufficient capacity is available on a flight recorder system;
 - (ii) the sensor is readily available; and
 - (iii) a change is not required in the equipment that generates the data.
- (b) The FDR of aeroplanes with an MCTOM exceeding 27 000 kg that are of a type first type certified after 30 September 1969 does not need to record the parameters 13, 14 and 15b in Table 2 below, when any of the following conditions are met:
 - (1) sufficient capacity is not available on a flight recorder system;
 - (2) the sensor is not readily available; and
 - (3) a change is required in the equipment that generates the data.
- (c) The parameters to be recorded should meet, as far as practicable, the performance specifications (range, sampling intervals, accuracy limits, and resolution in read-out) defined in Table 1 of [AMC5 CAT.IDE.A.190](#).
- (d) When so determined by the Agency, the FDR does not need to record individual parameters that can be derived by calculation from the other recorded parameters.

Table 1

Flight data recorder — aeroplanes with an MCTOM exceeding 5 700 kg

No	Parameter
1	Time or relative time count
2	Pressure altitude
3	Indicated airspeed or calibrated airspeed
4	Heading

No	Parameter
5	Normal acceleration

* The number in the left hand column reflects the serial number depicted in EUROCAE Document ED-112.

Table 2

Additional parameters for aeroplanes under conditions of AMC6 CAT.IDE.A.190, 1 & 2

No	Parameter
6	Pitch attitude
7	Roll attitude
8	Manual radio transmission keying unless an alternate means to synchronise the FDR and CVR recordings is provided
9	Power on each engine
10	Trailing edge flap or flight crew compartment control selection
11	Leading edge flap or flight crew compartment control selection
12	Thrust reverse position (for turbojet aeroplanes only)
13	Ground spoiler position and/or speed brake selection
14	Outside air temperature (OAT) or total air temperature
15a	Autopilot engagement status
15b	Autopilot operating modes, autothrottle and AFCS, systems engagement status and operating modes.
16	Longitudinal acceleration
17	Lateral acceleration
18	Primary flight controls — control surface position and/or pilot input (pitch, roll and yaw)
19	Pitch trim position
20	Radio altitude
21	Glide path deviation
22	Localiser deviation
23	Marker beacon passage
24	Master warning
25	NAV 1 and NAV 2 frequency selection
26	DME 1 and DME 2 distance
27	Landing gear squat switch status
28	Ground proximity warning system (GPWS)
29	Angle of attack
30	Hydraulics, each system (low pressure)
31	Navigation data (latitude, longitude, ground speed and drift angle)
32	Landing gear or gear selector position

* The number in the left hand column reflects the serial number depicted in EUROCAE Document ED-112.

GM1 CAT.IDE.A.190 Flight data recorder

ED Decision 2014/015/R

GENERAL

- (a) The alleviation of [AMC2 CAT.IDE.A.190\(d\)](#) affects a small number of aeroplanes first issued with an individual CofA on or after 1 April 1998 that were either constructed prior to this date or to a specification in force just prior to this date. These aeroplanes may not comply fully with [AMC2 CAT.IDE.A.190\(b\)](#), but are able to comply with [AMC4 CAT.IDE.A.190](#). In addition, this

alleviation applies only if compliance with [AMC2 CAT.IDE.A.190\(b\)](#) would imply significant modifications to the aeroplane with a severe re-certification effort.

- (b) Flight data recorder systems installed on board aeroplanes first issued with an individual CofA up to and including 31 March 1998, and for which the recorded parameters do not comply with the performance specifications of Table 1 of [AMC5 CAT.IDE.A.190](#) (i.e. range, sampling intervals, accuracy limits and recommended resolution readout) may be acceptable to the Agency.
- (c) The alleviations of [AMC4 CAT.IDE.A.190\(b\)](#) and (c), and [AMC6 CAT.IDE.A.190\(b\)](#), are acceptable only if adding the recording of missing parameters to the existing flight data recorder system would require a major upgrade of the system itself. Account is taken of the following:
 - (1) The extent of the modification required;
 - (2) The downtime period; and
 - (3) Equipment software development.
- (d) For the purpose of [AMC4 CAT.IDE.A.190\(b\)](#) and (c), and [AMC6 CAT.IDE.A.190\(a\)](#) and (b), 'capacity available' refers to the space on both the flight data acquisition unit and the flight data recorder not allocated for recording the required parameters, or the parameters recorded for the purpose of the Flight Data Monitoring programme, as determined by the Agency.
- (e) For the purpose of [AMC4 CAT.IDE.A.190\(b\)](#) and (c), and [AMC6 CAT.IDE.A.190\(a\)](#) and (b), a sensor is considered 'readily available' when it is already available or can be easily incorporated.
- (f) For aeroplanes first issued with an individual CofA up to and including 31 March 1998, the recording of the following additional parameters may be considered:
 - (1) Remaining parameters in Table 2 of [AMC4 CAT.IDE.A.190](#) or Table 2 of [AMC6 CAT.IDE.A.190](#) as applicable;
 - (2) Any dedicated parameter relating to novel or unique design or operational characteristics of the aeroplane;
 - (3) operational information from electronic display systems, such as EFIS, ECAM or EICAS, with the following order of priority:
 - (i) parameters selected by the flight crew relating to the desired flight path, e.g. barometric pressure setting, selected altitude, selected airspeed, decision height, and autoflight system engagement and mode indications if not recorded from another source;
 - (ii) display system selection/status, e.g. SECTOR, PLAN, ROSE, NAV, WXR, COMPOSITE, COPY, etc.;
 - (iii) warning and alerts;
 - (iv) the identity of displayed pages from emergency procedures and checklists.
 - (4) retardation information including brake application for use in the investigation of landing overruns or rejected take offs; and
 - (5) additional engine parameters (EPR, N1, EGT, fuel flow, etc.).

CAT.IDE.A.191 Lightweight flight recorder

Regulation (EU) 2019/1387

- (a) Turbine-engined aeroplanes with an MCTOM of 2 250 kg or more and aeroplanes with an MOPSC of more than 9 shall be equipped with a flight recorder if all of the following conditions are met:
 - (1) they are not within the scope of point [CAT.IDE.A.190\(a\)](#);
 - (2) they are first issued with an individual CofA on or after 5 September 2022.
- (b) The flight recorder shall record, by means of flight data or images, information that is sufficient to determine the flight path and aircraft speed.
- (c) The flight recorder shall be capable of retaining the flight data and the images recorded during at least the preceding 5 hours.
- (d) The flight recorder shall automatically start to record prior to the aeroplane being capable of moving under its own power and shall stop automatically after the aeroplane is no longer capable of moving under its own power.
- (e) If the flight recorder records images or audio of the flight crew compartment, then a function shall be provided which can be operated by the commander and which modifies image and audio recordings made before the operation of that function, so that those recordings cannot be retrieved using normal replay or copying techniques.

AMC1 CAT.IDE.A.191 Lightweight flight recorder

ED Decision 2021/005/R

OPERATIONAL PERFORMANCE REQUIREMENTS

- (a) If the flight recorder records flight data, it should record at least the following parameters:
 - (1) pitch attitude or pitch rate,
 - (2) roll attitude or roll rate,
 - (3) heading (magnetic or true) or yaw rate,
 - (4) latitude,
 - (5) longitude,
 - (6) positioning system: estimated error (if available),
 - (7) pressure altitude or altitude from a positioning system,
 - (8) time,
 - (10) ground speed,
 - (11) positioning system: track (if available),
 - (12) normal acceleration,
 - (13) longitudinal acceleration, and
 - (14) lateral acceleration.
- (b) If the flight recorder records images, it should capture views of the main instrument displays at the pilot station, or at both pilot stations when the aeroplane is certified for operation with a

minimum crew of two pilots. The recorded image quality should allow reading the following indications during most of the flight:

- (1) magnetic heading,
 - (2) time,
 - (3) pressure altitude,
 - (4) indicated airspeed,
 - (5) vertical speed,
 - (6) turn and slip,
 - (7) attitude,
 - (8) Mach number (if displayed),
 - (9) stabilised heading, and
 - (10) tachometer indication or equivalent indication of propulsive thrust or power.
- (c) If the flight recorder records a combination of images and flight data, each flight parameter listed in (a) should be recorded as flight data or by means of images.
- (d) The flight parameters listed in (a), which are recorded as flight data, should meet the performance specifications (range, sampling intervals, accuracy limits and resolution in read-out) as defined in the relevant table of EUROCAE Document ED-112 'Minimum Operational Performance Specification for Crash Protected Airborne Recorder Systems', dated March 2003, or EUROCAE Document ED-155 'Minimum Operational Performance Specification for Lightweight Flight Recording Systems', dated July 2009, or any later equivalent standard accepted by EASA.
- (e) The operational performance requirements for the flight recorder should be those laid down in:
- (1) EUROCAE Document ED-155 or any later equivalent standard accepted by EASA for lightweight flight recorders; or
 - (2) EUROCAE Document ED-112 or any later equivalent standard accepted by EASA for crash-protected flight recorders.

GM1 CAT.IDE.A.191 Lightweight flight recorder

ED Decision 2021/005/R

ADDITIONAL USEFUL INFORMATION

- (a) Experience has shown the usefulness, for analysing incidents and for training purposes, of recording additional information. In particular, audio of the flight crew compartment and information on the handling of the aircraft (such as position of flight controls, position of engine controls, fuel and oil indications, aircraft configuration selection), and an external view are very useful for such purposes. To capture such information, simple equipment such as an integrated microphone and integrated camera may be sufficient.
- (b) If the flight recorder includes optional capabilities such as described in (a), their recording duration is recommended to be at least 2 hours.
- (c) If the flight recorder is capable of acquiring flight parameters from some aircraft systems, it is advised to give priority to the flight parameters listed in Annex II-B to EUROCAE Document ED-

155 or the flight parameters listed in Annex II-A to EUROCAE Document ED-112. Indeed, these flight parameters were selected based on their relevance in many safety investigations.

GM2 CAT.IDE.A.191 Lightweight flight recorder

ED Decision 2021/005/R

INSTALLATION OF CAMERAS

When cameras are installed for the purpose of [CAT.IDA.A.191](#), it is advised to install them so that they do not capture images of head and shoulders of the flight crew members whilst seated in their normal operating position.

GM3 CAT.IDE.A.191 Lightweight flight recorder

ED Decision 2021/005/R

RECORDING ACCURACY OF ATTITUDE RATE PARAMETERS

In the case of attitude rate parameters (pitch rate parameter, yaw rate parameter, roll rate parameter), the accuracy limit specified in EUROCAE Document ED-155, dated July 2009, was found to be unclear. Therefore, the following additional guidance is provided:

- (a) If the attitude rate parameter is provided by an approved system of the aeroplane, accuracy greater than as provided by this system is not expected for this attitude rate parameter.
- (b) If the attitude rate parameter is provided by a dedicated gyroscope, it is advisable that the gyroscope meets the following performance:
 - (1) errors caused by linear accelerations less than $\pm 3^\circ/\text{sec}$ (equivalent to $\pm 1\%$ of $300^\circ/\text{sec}$ recording range) for all combinations of parameter values and linear acceleration values in the respective ranges $[-300^\circ/\text{sec}; +300^\circ/\text{sec}]$ and $[-3g; +6g]$;
 - (2) errors caused by temperature less than $\pm 5^\circ/\text{sec}$ for all combinations of parameter values and temperature values in the respective ranges $[-300^\circ/\text{sec}; +300^\circ/\text{sec}]$ and $[-40^\circ\text{C}; +85^\circ\text{C}]$;
 - (3) angular random walk of the gyroscope equal to or less than $2^\circ/\sqrt{\text{hour}}$; and
 - (4) bias stability of the gyroscope significantly less than $360^\circ/\text{hour}$ (for instance, $50^\circ/\text{hour}$).

GM1 CAT.IDE.A.191(e) Lightweight flight recorder

ED Decision 2021/005/R

FUNCTION TO MODIFY IMAGE AND AUDIO RECORDINGS

The purpose of the function modifying the image and audio recordings is to allow the flight crew to protect their privacy by making such recordings inaccessible using normal techniques. The activation of this function is subject to the commander's approval (refer to [CAT.GEN.MPA.105](#)). However, the equipment manufacturer or a safety investigation authority might still be able to retrieve these recordings using special techniques.

CAT.IDE.A.195 Data link recording

Regulation (EU) 2021/1296

- (a) Aeroplanes first issued with an individual CofA on or after 8 April 2014 that have the capability to operate data link communications and are required to be equipped with a CVR, shall record on a recorder, where applicable:

- (1) data link communication messages related to ATS communications to and from the aeroplane, including messages applying to the following applications:
 - (i) data link initiation;
 - (ii) controller-pilot communication;
 - (iii) addressed surveillance;
 - (iv) flight information;
 - (v) as far as is practicable, given the architecture of the system, aircraft broadcast surveillance;
 - (vi) as far as is practicable, given the architecture of the system, aircraft operational control data; and
 - (vii) as far as is practicable, given the architecture of the system, graphics;
 - (2) information that enables correlation to any associated records related to data link communications and stored separately from the aeroplane; and
 - (3) information on the time and priority of data link communications messages, taking into account the system's architecture.
- (b) The recorder shall use a digital method of recording and storing data and information and a method for retrieving that data. The recording method shall allow the data to match the data recorded on the ground.
 - (c) The recorder shall be capable of retaining data recorded for at least the same duration as set out for CVRs in [CAT.IDE.A.185](#).
 - (d) If the recorder is not deployable, it shall have a device to assist in locating it under water. By 16 June 2018 at the latest, this device shall have a minimum underwater transmission time of 90 days. If the recorder is deployable, it shall have an automatic emergency locator transmitter.
 - (e) The requirements applicable to the start and stop logic of the data link recorder are the same as the requirements applicable to the start and stop logic of the cockpit voice recorder (CVR) that are contained in point [CAT.IDE.A.185](#).

AMC1 CAT.IDE.A.195 Data link recording

ED Decision 2014/015/R

GENERAL

- (a) As a means of compliance with [CAT.IDE.A.195\(a\)](#), the recorder on which the data link messages is recorded may be:
 - (1) the CVR;
 - (2) the FDR;
 - (3) a combination recorder when [CAT.IDE.A.200](#) is applicable; or
 - (4) a dedicated flight recorder. In that case, the operational performance requirements for this recorder should be those laid down in EUROCAE Document ED-112 (Minimum Operational Performance Specification for Crash Protected Airborne Recorder Systems) dated March 2003, including amendments No 1 and No 2, or any later equivalent standard produced by EUROCAE.

- (b) As a means of compliance with [CAT.IDE.A.195\(a\)\(2\)](#), the operator should enable correlation by providing information that allows an accident investigator to understand what data was provided to the aeroplane and, when the provider identification is contained in the message, by which provider.
- (c) The timing information associated with the data link communications messages required to be recorded by [CAT.IDE.A.195\(a\)\(3\)](#) should be capable of being determined from the airborne-based recordings. This timing information should include at least the following:
- (1) the time each message was generated;
 - (2) the time any message was available to be displayed by the crew;
 - (3) the time each message was actually displayed or recalled from a queue; and
 - (4) the time of each status change.
- (d) The message priority should be recorded when it is defined by the protocol of the data link communication message being recorded.
- (e) The expression ‘taking into account the system architecture’, in [CAT.IDE.A.195\(a\)\(3\)](#), means that the recording of the specified information may be omitted if the existing source systems involved would require a major upgrade. The following should be considered:
- (1) the extent of the modification required;
 - (2) the down-time period; and
 - (3) equipment software development.
- The intention is that new designs of source systems should include this functionality and support the full recording of the required information.
- (f) Data link communications messages that support the applications in Table 1 below should be recorded.
- (g) Further details on the recording requirements can be found in the recording requirement matrix in Appendix D.2 of EUROCAE Document ED-93 (Minimum Aviation System Performance Specification for CNS/ATM Recorder Systems, dated November 1998).

Table 1

Applications

Item No	Application Type	Application Description	Required Recording Content
1	Data link initiation	This includes any application used to log on to, or initiate, a data link service. In future air navigation system (FANS)-1/A and air traffic navigation (ATN), these are ATS facilities notification (AFN) and context management (CM) respectively.	C
2	Controller/pilot communication	This includes any application used to exchange requests, clearances, instructions and reports between the flight crew and air traffic controllers. In FANS-1/A and ATN, this includes the controller pilot data link communications (CPDLC) application. It also includes applications used for the exchange of oceanic (OCL) and departure clearances (DCL) as well as data link delivery of taxi clearances.	C

3	Addressed surveillance	This includes any surveillance application in which the ground sets up contracts for delivery of surveillance data. In FANS-1/A and ATN, this includes the automatic dependent surveillance-contract (ADS-C) application.	C, F2
4	Flight information	This includes any application used for delivery of flight information data to specific aeroplanes. This includes for example, digital automatic terminal information service (D-ATIS), data link operational terminal information service (D-OTIS), digital weather information services (D-METAR or TWIP), data link flight information service (D-FIS), and Notice to Airmen (electronic NOTAM) delivery.	C
5	Aircraft broadcast surveillance	This includes elementary and enhanced surveillance systems, as well as automatic dependent surveillance-broadcast (ADS-B) output data.	M*, F2
6	Aeronautical operational control (AOC) data	This includes any application transmitting or receiving data used for AOC purposes (in accordance with the ICAO definition of AOC). Such systems may also process AAC messages, but there is no requirement to record AAC messages.	M*
7	Graphics	This includes any application receiving graphical data to be used for operational purposes (i.e. excluding applications that are receiving such things as updates to manuals).	M* F1

GM1 CAT.IDE.A.195 Data link recording

ED Decision 2014/015/R

DEFINITIONS AND ACRONYMS

(a) The letters and expressions in Table 1 of [AMC1 CAT.IDE.A.195](#) have the following meaning:

C: complete contents recorded

M: information that enables correlation with any associated records stored separately from the aeroplane.

*: Applications that are to be recorded only as far as is practicable, given the architecture of the system.

F1: graphics applications may be considered as AOC messages when they are part of a data link communications application service run on an individual basis by the operator itself in the framework of the operational control.

F2: where parametric data sent by the aeroplane, such as Mode S, is reported within the message, it should be recorded unless data from the same source is recorded on the FDR.

(b) The definitions of the applications type in Table 1 of [AMC1 CAT.IDE.A.195](#) are described in Table 1 below.

Table 1

Definitions of applications type

Item No	Application Type	Messages	Comments
1	CM		CM is an ATN service
2	AFN		AFN is a FANS 1/A service

Item No	Application Type	Messages	Comments
3	CPDLC		All implemented up and downlink messages to be recorded
4	ADS-C	ADS-C reports	All contract requests and reports recorded
		Position reports	Only used within FANS 1/A. Only used in oceanic and remote areas.
5	ADS-B	Surveillance data	Information that enables correlation with any associated records stored separately from the aeroplane.
6	D-FIS		D-FIS is an ATN service. All implemented up and downlink messages to be recorded
7	TWIP	TWIP messages	Terminal weather information for pilots
8	D-ATIS	ATIS messages	Refer to EUROCAE Document ED-89A dated December 2003. Data Link Application System Document (DLASD) for the 'ATIS' Data Link Service
9	OCL	OCL messages	Refer to EUROCAE Document ED-106A dated March 2004. Data Link Application System Document (DLASD) for 'Oceanic Clearance' Data Link Service
10	DCL	DCL messages	Refer to EUROCAE Document ED-85A dated December 2003. Data Link Application System Document (DLASD) for 'Departure Clearance' Data Link Service
11	Graphics	Weather maps & other graphics	Graphics exchanged in the framework of procedures within the operational control, as specified in Part-ORO. Information that enables correlation with any associated records stored separately from the aeroplane.
12	AOC	Aeronautical operational control messages	Messages exchanged in the framework of procedures within the operational control, as specified in Part-ORO. Information that enables correlation with any associated records stored separately from the aeroplane. Definition in EUROCAE Document ED-112, dated March 2003.
13	Surveillance	Downlinked aircraft parameters (DAP)	As defined in ICAO Annex 10 Volume IV (Surveillance systems and ACAS).

AAC	aeronautical administrative communications
ADS-B	automatic dependent surveillance — broadcast
ADS-C	automatic dependent surveillance — contract
AFN	aircraft flight notification
AOC	aeronautical operational control
ATIS	automatic terminal information service
ATSC	air traffic service communication
CAP	controller access parameters
CPDLC	controller pilot data link communications
CM	configuration/context management
D-ATIS	digital ATIS
D-FIS	data link flight information service
D-METAR	data link meteorological airport report
DCL	departure clearance
FANS	Future Air Navigation System
FLIPCY	flight plan consistency
OCL	oceanic clearance
SAP	system access parameters
TWIP	terminal weather information for pilots

GM1 CAT.IDE.A.195(a) Data link recording

ED Decision 2015/030/R

APPLICABILITY OF THE DATA LINK RECORDING REQUIREMENT

- (a) If it is certain that the aeroplane cannot use data link communication messages for ATS communications corresponding to any application designated by [CAT.IDE.A.195\(a\)\(1\)](#), then the data link recording requirement does not apply.
- (b) Examples where the aeroplane cannot use data link communication messages for ATS communications include but are not limited to the cases where:
 - (1) the aeroplane data link communication capability is disabled permanently and in a way that it cannot be enabled again during the flight;
 - (2) data link communications are not used to support air traffic service (ATS) in the area of operation of the aeroplane; and
 - (3) the aeroplane's data link communication equipment cannot communicate with the equipment used by ATS in the area of operation of the aeroplane.

CAT.IDE.A.200 Combination recorder

Regulation (EU) No 965/2012

Compliance with CVR and FDR requirements may be achieved by:

- (a) one flight data and cockpit voice combination recorder in the case of aeroplanes required to be equipped with a CVR or an FDR;
- (b) one flight data and cockpit voice combination recorder in the case of aeroplanes with an MCTOM of 5 700 kg or less and required to be equipped with a CVR and an FDR; or
- (c) two flight data and cockpit voice combination recorders in the case of aeroplanes with an MCTOM of more than 5 700 kg and required to be equipped with a CVR and an FDR.

AMC1 CAT.IDE.A.200 Combination recorder

ED Decision 2021/005/R

GENERAL

- (a) When two flight data and cockpit voice combination recorders are installed, one should be located near the flight crew compartment, in order to minimise the risk of data loss due to a failure of the wiring that gathers data to the recorder. The other should be located at the rear section of the aeroplane, in order to minimise the risk of data loss due to recorder damage in the case of a crash.
- (b) When two flight data and cockpit voice combination recorders are installed and an alternate power source is required for the CVR function, it is acceptable to provide this alternate power source only to the cockpit-mounted area microphone and to one recorder.

GM1 CAT.IDE.A.200 Combination recorder

ED Decision 2014/015/R

GENERAL

- (a) A flight data and cockpit voice combination recorder is a flight recorder that records:
- (1) all voice communications and aural environment required by [CAT.IDE.A.185](#) regarding CVRs; and
 - (2) all parameters required by [CAT.IDE.A.190](#) regarding FDRs, with the same specifications required by those paragraphs.
- (b) In addition, a flight data and cockpit voice combination recorder may record data link communication messages and related information required by [CAT.IDE.A.195](#).

CAT.IDE.A.205 Seats, seat safety belts, restraint systems and child restraint devices

Regulation (EU) 2019/1384

- (a) Aeroplanes shall be equipped with:
- (1) a seat or berth for each person on board who is aged 24 months or more;
 - (2) a seat belt on each passenger seat and restraining belts for each berth except as specified in (3);
 - (3) a seat belt with upper torso restraint system on each passenger seat and restraining belts on each berth in the case of aeroplanes with an MCTOM of 5 700 kg or less and with an MOPSC of nine or less, having an individual CofA first issued on or after 8 April 2015;
 - (4) a child restraint device (CRD) for each person on board younger than 24 months;
 - (5) a seat belt with upper torso restraint system incorporating a device that will automatically restrain the occupant's torso in the event of rapid deceleration:
 - (i) on each flight crew seat and on any seat alongside a pilot's seat;
 - (ii) on each observer seat located in the flight crew compartment;
 - (6) a seat belt with upper torso restraint system on each seat for the minimum required cabin crew.
- (b) A seat belt with upper torso restraint system shall have:
- (1) a single point release;
 - (2) on the seats for the minimum required cabin crew, two shoulder straps and a seat belt that may be used independently; and
 - (3) on flight crew members' seats and on any seat alongside a pilot's seat, either of the following:
 - (i) two shoulder straps and a seat belt that may be used independently;
 - (ii) a diagonal shoulder strap and a seat belt that may be used independently for the following aeroplanes:

- (A) aeroplanes with an MCTOM of 5 700 kg or less and with an MOPSC of nine or less that are compliant with the emergency landing dynamic conditions defined in the applicable certification specification;
- (B) aeroplanes with an MCTOM of 5 700 kg or less and with an MOPSC of nine or less that are not compliant with the emergency landing dynamic conditions defined in the applicable certification specification and having an individual CofA first issued before 28 October 2014;
- (C) aeroplanes certified in accordance with CS-VLA or equivalent and CS-LSA or equivalent.

AMC1 CAT.IDE.A.205 Seats, seat safety belts, restraint systems and child restraint devices

ED Decision 2019/019/R

CHILD RESTRAINT DEVICES (CRDs)

- (a) A CRD is considered to be acceptable if:
 - (1) it is a 'supplementary loop belt' manufactured with the same techniques and the same materials as the approved safety belts; or
 - (2) it complies with (b).
- (b) Provided the CRD can be installed properly on the respective aircraft seat, the following CRDs are considered acceptable:
 - (1) CRDs approved for use in aircraft according to the European Technical Standard Order ETSO-C100c on Aviation Child Safety Device (ACSD);
 - (2) CRDs approved by EASA through a Type Certificate or Supplemental Type Certificate;
 - (3) Child seats approved for use in motor vehicles on the basis of the technical standard specified in point (i) below. The child seat must be also approved for use in aircraft on the basis of the technical standard specified in either point (ii) or point (iii):
 - (i) UN Standard ECE R44-04 (or 03), or ECE R129 bearing the respective 'ECE R' label; and
 - (ii) German 'Qualification Procedure for Child Restraint Systems for Use in Aircraft' (TÜV/958-01/2001) bearing the label 'For Use in Aircraft'; or
 - (iii) Other technical standard acceptable to the competent authority. The child seat should hold a qualification sign that it can be used in aircraft.
 - (4) Child seats approved for use in motor vehicles and aircraft according to Canadian CMVSS 213/213.1 bearing the respective label;
 - (5) Child seats approved for use in motor vehicles and aircraft according to US FMVSS No 213 and bearing one or two labels displaying the following two sentences:
 - (i) 'THIS CHILD RESTRAINT SYSTEM CONFORMS TO ALL APPLICABLE FEDERAL MOTOR VEHICLE SAFETY STANDARDS'; and
 - (ii) in red letters 'THIS RESTRAINT IS CERTIFIED FOR USE IN MOTOR VEHICLES AND AIRCRAFT';

- (6) Child seats approved for use in motor vehicles and aircraft according to Australia/New Zealand's technical standard AS/NZS 1754:2013 bearing the green part on the label displaying 'For Use in Aircraft'; and
 - (7) CRDs manufactured and tested according to other technical standards equivalent to those listed above. The devices should be marked with an associated qualification sign, which shows the name of the qualification organisation and a specific identification number, related to the associated qualification project. The qualifying organisation should be a competent and independent organisation that is acceptable to the competent authority.
- (c) Location
- (1) Forward-facing child seats may be installed on both forward-and rearward-facing passenger seats, but only when fitted in the same direction as the passenger seat on which they are positioned. Rearward-facing child seats should only be installed on forward-facing passenger seats. A child seat should not be installed within the radius of action of an airbag unless it is obvious that the airbag is de-activated or it can be demonstrated that there is no negative impact from the airbag.
 - (2) An infant/child in a CRD should be located in the vicinity of a floor level exit.
 - (3) An infant/child in a CRD should not hinder evacuation for any passenger.
 - (4) An infant/child in a CRD should neither be located in the row (where rows are existing) leading to an emergency exit nor located in a row immediately forward or aft of an emergency exit. A window passenger seat is the preferred location. An aisle passenger seat or a cross aisle passenger seat that forms part of the evacuation route to exits is not recommended. Other locations may be acceptable provided the access of neighbour passengers to the nearest aisle is not obstructed by the CRD.
 - (5) In general, only one CRD per row segment is recommended. More than one CRD per row segment is allowed if the infants/children are from the same family or travelling group provided the infants/children are accompanied by a responsible adult sitting next to them in the same row segment.
 - (6) A row segment is one or more seats side-by-side separated from the next row segment by an aisle.
- (d) Installation
- (1) CRDs tested and approved for use in aircraft should only be installed on a suitable passenger seat by the method shown in the manufacturer's instructions provided with each CRD and with the type of connecting device they are approved for the installation in aircraft. CRDs designed to be installed only by means of rigid bar lower anchorages (ISOFIX or equivalent) should only be used on passenger seats equipped with such connecting devices and should not be secured by passenger seat lap belt.
 - (2) All safety and installation instructions should be followed carefully by the responsible adult accompanying the infant/child. Operators should prohibit the use of a CRD not installed on the passenger seat according to the manufacturer's instructions or not approved for use in aircraft.
 - (3) If a forward-facing child seat with a rigid backrest is to be fastened by a seat lap belt, the restraint device should be fastened when the backrest of the passenger seat on which it rests is in a reclined position. Thereafter, the backrest is to be positioned upright. This

procedure ensures better tightening of the child seat on the aircraft seat if the aircraft seat is reclinable.

- (4) The buckle of the adult safety belt must be easily accessible for both opening and closing, and must be in line with the seat belt halves (not canted) after tightening.
 - (5) Forward-facing restraint devices with an integral harness must not be installed such that the adult safety belt is secured over the infant.
- (e) Operation
- (1) Each CRD should remain secured to a passenger seat during all phases of flight unless it is properly stowed when not in use.
 - (2) Where a child seat is adjustable in recline, it must be in an upright position for all occasions when passenger restraint devices are required.

AMC2 CAT.IDE.A.205 Seats, seat safety belts, restraint systems and child restraint devices

ED Decision 2016/015/R

UPPER TORSO RESTRAINT SYSTEM

- (a) A restraint system, including a seat belt, two shoulder straps and additional straps is deemed to be compliant with the requirement for restraint systems with two shoulder straps.
- (b) An upper torso restraint system which restrains permanently the torso of the occupant is deemed to be compliant with the requirement for an upper torso restraint system incorporating a device that will automatically restrain the occupant's torso in the event of rapid deceleration.
- (c) The use of the upper torso restraint independently from the use of the seat belt is intended as an option for the comfort of the occupant of the seat in those phases of flight where only the seat belt is required to be fastened. A restraint system including a seat belt and an upper torso restraint that both remain permanently fastened is also acceptable.

SEAT BELT

- (d) A seat belt with a diagonal shoulder strap (three anchorage points) is deemed to be compliant with the requirement for a seat belt (two anchorage points).

AMC3 CAT.IDE.A.205 Seats, seat safety belts, restraint systems and child restraint devices

ED Decision 2014/015/R

SEATS FOR MINIMUM REQUIRED CABIN CREW

- (a) Seats for the minimum required cabin crew members should be located near required floor level emergency exits, except if the emergency evacuation of passengers would be enhanced by seating cabin crew members elsewhere. In this case, other locations are acceptable.
- (b) Such seats should be forward-or rearward-facing within 15° of the longitudinal axis of the aeroplane.

GM1 CAT.IDE.A.205 Seats, seat safety belts, restraint systems and child restraint devices

ED Decision 2016/015/R

EMERGENCY LANDING DYNAMIC CONDITIONS

Emergency landing dynamic conditions are defined in 23.562 of CS-23 or equivalent and in 25.562 of CS-25 or equivalent.

GM2 CAT.IDE.A.205 Seats, seat safety belts, restraint systems and child restraint devices

ED Decision 2019/019/R

USE OF CHILD SEATS ON BOARD

Guidance on child restraint devices and facilitation of mutual acceptance of these devices can be found in ICAO Doc 10049 'Manual on the approval and use of child restraint systems'.

CAT.IDE.A.210 Fasten seat belt and no smoking signs

Regulation (EU) No 965/2012

Aeroplanes in which not all passenger seats are visible from the flight crew seat(s) shall be equipped with a means of indicating to all passengers and cabin crew when seat belts shall be fastened and when smoking is not allowed.

CAT.IDE.A.215 Internal doors and curtains

Regulation (EU) No 379/2014

Aeroplanes shall be equipped with:

- (a) in the case of aeroplanes with an MOPSC of more than 19, a door between the passenger compartment and the flight crew compartment, with a placard indicating 'crew only' and a locking means to prevent passengers from opening it without the permission of a member of the flight crew;
- (b) a readily accessible means for opening each door that separates a passenger compartment from another compartment that has emergency exits;
- (c) a means for securing in the open position any doorway or curtain separating the passenger compartment from other areas that need to be accessed to reach any required emergency exit from any passenger seat;
- (d) a placard on each internal door or adjacent to a curtain that is the means of access to a passenger emergency exit, to indicate that it shall be secured open during take-off and landing; and
- (e) a means for any member of the crew to unlock any door that is normally accessible to passengers and that can be locked by passengers.

CAT.IDE.A.220 First-aid kit

Regulation (EU) No 965/2012

- (a) Aeroplanes shall be equipped with first-aid kits, in accordance with Table 1.

Table 1

Number of first-aid kits required

Number of passenger seats installed	Number of first-aid kits required
0-100	1
101-200	2
201-300	3
301-400	4
401-500	5
501 or more	6

- (b) First-aid kits shall be:
- (1) readily accessible for use; and
 - (2) kept up to date.

AMC1 CAT.IDE.A.220 First-aid kit

ED Decision 2021/005/R

CONTENT OF FIRST-AID KITS

- (a) First-aid kits should be equipped with appropriate and sufficient medications and instrumentation. However, these kits should be supplemented by the operator according to the characteristics of the operation (scope of operation, flight duration, number and demographics of passengers, number of decks, etc.).
- (b) The following should be included in the first-aid kit:
- (1) Equipment
 - (i) bandages (assorted sizes, including a triangular bandage);
 - (ii) burns dressings (unspecified);
 - (iii) wound dressings (large and small);
 - (iv) adhesive dressings (assorted sizes);
 - (v) adhesive tape;
 - (vi) adhesive wound closures;
 - (vii) safety pins;
 - (viii) safety scissors;
 - (ix) antiseptic wound cleaner;
 - (x) disposable resuscitation aid;
 - (xi) disposable gloves;
 - (xii) tweezers: splinter;
 - (xiii) thermometers (non-mercury); and

- (xiv) surgical masks.
- (2) Medications
 - (i) simple analgesic (including paediatric form);
 - (ii) antiemetic — non-injectable (including paediatric form);
 - (iii) nasal decongestant;
 - (iv) gastrointestinal antacid, in the case of aeroplanes carrying more than 9 passengers;
 - (v) anti-diarrhoeal medication, in the case of aeroplanes carrying more than 9 passengers; and
 - (vi) antihistamine (including paediatric form).
- (3) Other content. The operator should make the instructions readily available. If an electronic format is available, then all instructions should be kept on the same device. If a paper format is used, then the instructions should be kept in the same kit with the applicable equipment and medication. The instructions should include, as a minimum, the following:
 - (i) a list of contents in at least two languages (English and one other). This should include information on the effects and side effects of medications carried;
 - (ii) first-aid handbook, current edition;
 - (iii) Basic life support instructions cards (summarising and depicting the current algorithm for basic life support); and
 - (iv) medical incident report form.
- (4) Additional equipment. The following additional equipment should be carried on board each aircraft equipped with a first-aid kit, though not necessarily in the first-aid kit. When operating multi-deck aircraft, operators should assess if the additional equipment is needed on each deck. The additional equipment should include, as a minimum:
 - (i) automated external defibrillator (AED) on all aircraft required to carry at least one cabin crew;
 - (ii) bag-valve masks (masks in three sizes: one for adults, one for children, and one for infants);
 - (iii) suitable airway management device (e.g. supraglottic airway devices, oropharyngeal or nasopharyngeal airways);
 - (iv) eye irrigator;
 - (v) biohazard disposal bags; and
 - (vi) basic delivery kit (including sterile umbilical cord scissors and a pair of cord clamps) on all aircraft required to carry at least one cabin crew.

AMC2 CAT.IDE.A.220 First-aid kit

ED Decision 2014/015/R

MAINTENANCE OF FIRST-AID KITS

To be kept up to date, first-aid kits should be:

- (a) inspected periodically to confirm, to the extent possible, that contents are maintained in the condition necessary for their intended use;
- (b) replenished at regular intervals, in accordance with instructions contained on their labels, or as circumstances warrant; and
- (c) replenished after use in-flight at the first opportunity where replacement items are available.

GM1 CAT.IDE.A.220 First-aid kit

ED Decision 2021/005/R

LOCATION

The location of the first-aid kit in the cabin is normally indicated using internationally recognisable signs.

GM2 CAT.IDE.A.220 First-aid kit

ED Decision 2021/005/R

STORAGE

As a best practice and wherever practicable, the emergency medical equipment listed under [AMC1 CAT.IDE.A.220](#) should be kept close together.

GM3 CAT.IDE.A.220 First-aid kit

ED Decision 2021/005/R

CONTENT OF FIRST-AID KITS

The operator may supplement first-aid kits according to the characteristics of the operation based on a risk assessment. The assessment does not require an approval by the competent authority.

GM4 CAT.IDE.A.220 First-aid kit

ED Decision 2021/005/R

LITHIUM BATTERIES

Risks related to the presence of lithium batteries should be assessed. All equipment powered by lithium batteries carried on an aeroplane should comply with the provisions of [AMC1 CAT.GEN.MPA.140\(f\)](#) including applicable technical standards such as (E)TSO-C142.

CAT.IDE.A.225 Emergency medical kit

Regulation (EU) No 965/2012

- (a) Aeroplanes with an MOPSC of more than 30 shall be equipped with an emergency medical kit when any point on the planned route is more than 60 minutes flying time at normal cruising speed from an aerodrome at which qualified medical assistance could be expected to be available.
- (b) The commander shall ensure that drugs are only administered by appropriately qualified persons.
- (c) The emergency medical kit referred to in (a) shall be:
 - (1) dust and moisture proof;

- (2) carried in a way that prevents unauthorised access; and
- (3) kept up to date.

AMC1 CAT.IDE.A.225 Emergency medical kit

ED Decision 2021/005/R

CONTENT OF EMERGENCY MEDICAL KITS

- (a) Emergency medical kits should be equipped with appropriate and sufficient medications and instrumentation. However, these kits should be supplemented by the operator according to the characteristics of the operation (scope of operation, flight duration, number and demographics of passengers, number of decks, etc.).
- (b) The following should be included in the emergency medical kit:
 - (1) Equipment
 - (i) sphygmomanometer — electronic recommended;
 - (ii) stethoscope;
 - (iii) syringes and needles;
 - (iv) intravenous cannulae (a sufficient supply of intravenous cannulae should be available, subject to the amount of intravenous fluids carried on board);
 - (v) tourniquet;
 - (vi) disposable gloves;
 - (vii) needle disposal box;
 - (viii) one or more urinary catheter(s), appropriate for either sex, and anaesthetic gel;
 - (ix) aspirator;
 - (x) blood glucose testing equipment;
 - (xi) scalpel;
 - (xii) pulse oximeter; and
 - (xiii) pneumothorax set.
 - (2) Instructions: the instructions should contain a list of contents (medications in trade names and generic names) in at least two languages (English and one other). This should include information on the effects and side effects of medications carried. There should also be basic instructions for use of the medications in the kit and guidance for conversion of units for the blood glucose test. The operator should make the instructions readily available. If an electronic format is available, then all instructions should be kept on the same device. If a paper format is used, then the instructions should be kept in the same kit with the applicable equipment and medication.
 - (3) Medications
 - (i) coronary vasodilator e.g. glyceriltrinitrate-oral;
 - (ii) antispasmodic;
 - (iii) epinephrine/adrenaline 1:1 000;

- (iv) adrenocorticoid;
- (v) major analgesic;
- (vi) diuretic — injectable;
- (vii) antihistamine — oral and injectable (including paediatric form);
- (viii) sedative/anticonvulsant — oral plus injectable and/or rectal sedative;
- (ix) medication for hypoglycaemia (e.g. hypertonic glucose);
- (x) antiemetic — injectable;
- (xi) antibiotic — injectable form — Ceftriaxone or Cefotaxime;
- (xii) bronchial dilator — inhaled (disposable collapsible spacer);
- (xiii) IV fluids in appropriate quantity e.g. sodium chloride 0.9 % (minimum 250 ml); and
- (xiv) acetylsalicylic acid — oral — for coronary use.

AMC2 CAT.IDE.A.225 Emergency medical kit

ED Decision 2017/008/R

CARRIAGE UNDER SECURE CONDITIONS

The emergency medical kit should be kept either in the flight crew compartment or in another secure location in the cabin that prevents unauthorised access to it.

AMC3 CAT.IDE.A.225 Emergency medical kit

ED Decision 2021/005/R

ACCESS TO THE EMERGENCY MEDICAL KIT

- (a) When the actual situation on board so requires, the commander should limit access to the emergency medical kit.
- (b) Drugs should be administered by medical doctors, qualified nurses, paramedics or emergency medical technicians.
- (c) Medical students, student paramedics, student emergency medical technicians or nurses aides should only administer drugs if no person mentioned in (b) is on board the flight and appropriate advice has been received.
- (d) Whenever allowed under the operator's national legislation, drugs may be administered by suitably trained persons, other than medical doctors.
- (e) Oral drugs should not be denied in medical emergency situations where no medically qualified persons are on board the flight.

AMC4 CAT.IDE.A.225 Emergency medical kit

ED Decision 2014/015/R

MAINTENANCE OF EMERGENCY MEDICAL KIT

To be kept up to date, the emergency medical kit should be:

- (a) inspected periodically to confirm, to the extent possible, that the contents are maintained in the condition necessary for their intended use;

- (b) replenished at regular intervals, in accordance with instructions contained on their labels, or as circumstances warrant; and
- (c) replenished after use-in-flight at the first opportunity where replacement items are available.

GM1 CAT.IDE.A.225 Emergency medical kit

ED Decision 2017/008/R

SECURE LOCATION

‘Secure location’ refers to a location in the cabin that is not intended for the use by passengers and preferably to which passengers do not have access.

GM2 CAT.IDE.A.225 Emergency medical kit

ED Decision 2021/005/R

CONTENT OF EMERGENCY MEDICAL KITS

The operator may supplement emergency medical kits according to the characteristics of the operation based on a risk assessment. The assessment does not require an approval by the competent authority.

GM3 CAT.IDE.A.225 Emergency medical kit

ED Decision 2021/005/R

LITHIUM BATTERIES

Risks related to the presence of lithium batteries should be assessed. All equipment powered by lithium batteries carried on an aeroplane should comply with the provisions of [AMC1 CAT.GEN.MPA.140\(f\)](#) including applicable technical standards such as (E)TSO-C142.

CAT.IDE.A.230 First-aid oxygen

Regulation (EU) 2019/1387

- (a) Pressurised aeroplanes operated at pressure altitudes above 25 000 ft, in the case of operations for which a cabin crew member is required, shall be equipped with a supply of undiluted oxygen for passengers who, for physiological reasons, might require oxygen following a cabin depressurisation.
- (b) The oxygen supply referred to in (a) shall be sufficient for the remainder of the flight after cabin depressurisation when the cabin altitude exceeds 8 000 ft but does not exceed 15 000 ft, for at least 2 % of the passengers carried, but in no case for less than one person.
- (c) There shall be a sufficient number of dispensing units, but in no case less than two, with a means for cabin crew to use the supply.
- (d) The first-aid oxygen equipment shall be capable of generating a mass flow to each person.

GM1 CAT.IDE.A.230 First-aid oxygen

ED Decision 2021/005/R

GENERAL

- (a) First-aid oxygen is intended for those passengers who still need to breath oxygen when the amount of supplemental oxygen required under [CAT.IDE.A.235](#) or [CAT.IDE.A.240](#) has been exhausted.
- (b) When calculating the amount of first-aid oxygen, the operator should take into account the fact that, following a cabin depressurisation, supplemental oxygen as calculated in accordance with Table 1 of [CAT.IDE.A.235](#) and Table 1 of [CAT.IDE.A.240](#) should be sufficient to cope with potential effects of hypoxia for:
 - (1) all passengers when the cabin altitude is above 15 000 ft;
 - (2) at least 30 % of the passengers, for any period when, in the event of loss of pressurisation and taking into account the circumstances of the flight, the pressure altitude in the passenger compartment will be between 14 000 ft and 15 000 ft; and
 - (3) at least 10 % of the passengers for any period in excess of 30 minutes when the pressure altitude in the passenger compartment will be between 10 000 ft and 14 000 ft.
- (c) For the above reasons, the amount of first-aid oxygen should be calculated for the part of the flight after cabin depressurisation during which the cabin altitude is between 8 000 ft and 15 000 ft, when supplemental oxygen may no longer be available.
- (d) Moreover, following cabin depressurisation, an emergency descent should be carried out to the lowest altitude compatible with the safety of the flight. In addition, in these circumstances, the aeroplane should land at the first available aerodrome at the earliest opportunity.
- (e) The conditions above may reduce the period of time during which the first-aid oxygen may be required and consequently may limit the amount of first-aid oxygen to be carried on board.

AMC1 CAT.IDE.A.230(d) First-aid oxygen

ED Decision 2021/005/R

GENERAL

- (a) The mass flow of oxygen should be in accordance with CS-25.1443 or equivalent.
- (b) The oxygen supply may be calculated by assuming an average flow rate of at least 3 litres standard temperature pressure dry (STPD)/minute/person, or equivalent, as demonstrated during the certification of the dispensing unit.

CAT.IDE.A.235 Supplemental oxygen – pressurised aeroplanes

Regulation (EU) No 965/2012

- (a) Pressurised aeroplanes operated at pressure altitudes above 10 000 ft shall be equipped with supplemental oxygen equipment that is capable of storing and dispensing the oxygen supplies in accordance with Table 1.
- (b) Pressurised aeroplanes operated at pressure altitudes above 25 000 ft shall be equipped with:
 - (1) quick donning types of masks for flight crew members;

- (2) sufficient spare outlets and masks or portable oxygen units with masks distributed evenly throughout the passenger compartment, to ensure immediate availability of oxygen for use by each required cabin crew member;
 - (3) an oxygen dispensing unit connected to oxygen supply terminals immediately available to each cabin crew member, additional crew member and occupants of passenger seats, wherever seated; and
 - (4) a device to provide a warning indication to the flight crew of any loss of pressurisation.
- (c) In the case of pressurised aeroplanes first issued with an individual CofA after 8 November 1998 and operated at pressure altitudes above 25 000 ft, or operated at pressure altitudes at, or below 25 000 ft under conditions that would not allow them to descend safely to 13 000 ft within four minutes, the individual oxygen dispensing units referred to in (b)(3) shall be automatically deployable.
- (d) The total number of dispensing units and outlets referred to in (b)(3) and (c) shall exceed the number of seats by at least 10 %. The extra units shall be evenly distributed throughout the passenger compartment.
- (e) Notwithstanding (a), the oxygen supply requirements for cabin crew member(s), additional crew member(s) and passenger(s), in the case of aeroplanes not certified to fly at altitudes above 25 000 ft, may be reduced to the entire flying time between 10 000 ft and 13 000 ft cabin pressure altitudes for all required cabin crew members and for at least 10 % of the passengers if, at all points along the route to be flown, the aeroplane is able to descend safely within four minutes to a cabin pressure altitude of 13 000 ft.
- (f) The required minimum supply in Table 1, row 1 item (b)(1) and row 2, shall cover the quantity of oxygen necessary for a constant rate of descent from the aeroplane's maximum certified operating altitude to 10 000 ft in 10 minutes and followed by 20 minutes at 10 000 ft.
- (g) The required minimum supply in Table 1, row 1 item 1(b)(2), shall cover the quantity of oxygen necessary for a constant rate of descent from the aeroplane's maximum certified operating altitude to 10 000 ft in 10 minutes followed by 110 minutes at 10 000 ft.
- (h) The required minimum supply in Table 1, row 3, shall cover the quantity of oxygen necessary for a constant rate of descent from the aeroplane's maximum certified operating altitude to 15 000 ft in 10 minutes.

Table 1

Oxygen minimum requirements for pressurised aeroplanes

Supply for	Duration and cabin pressure altitude
1. Occupants of flight crew compartment seats on flight crew compartment duty	(a) The entire flying time when the cabin pressure altitude exceeds 13 000 ft.
	(b) The remainder of the flying time when the cabin pressure altitude exceeds 10 000 ft but does not exceed 13 000 ft, after the initial 30 minutes at these altitudes, but in no case less than: <ul style="list-style-type: none"> (1) 30 minutes' supply for aeroplanes certified to fly at altitudes not exceeding 25 000 ft; and (2) 2 hours' supply for aeroplanes certified to fly at altitudes of more than 25 000 ft.
2. Required cabin crew members	(a) The entire flying time when the cabin pressure altitude exceeds 13 000 ft, but not less than 30 minutes' supply.

Supply for	Duration and cabin pressure altitude
	(b) The remainder of the flying time when the cabin pressure altitude exceeds 10 000 ft but does not exceed 13 000 ft, after the initial 30 minutes at these altitudes.
3. 100 % of passengers ⁽¹⁾	The entire flying time when the cabin pressure altitude exceeds 15 000 ft, but in no case less than 10 minutes' supply.
4. 30 % of passengers ⁽¹⁾	The entire flying time when the cabin pressure altitude exceeds 14 000 ft but does not exceed 15 000 ft.
5. 10 % of passengers ⁽¹⁾	The remainder of the flying time when the cabin pressure altitude exceeds 10 000 ft but does not exceed 14 000 ft, after the initial 30 minutes at these altitudes.
⁽¹⁾ Passenger numbers in Table 1 refer to passengers actually carried on board, including persons younger than 24 months.	

AMC1 CAT.IDE.A.235 Supplemental oxygen – pressurised aeroplanes

ED Decision 2014/015/R

DETERMINATION OF OXYGEN

- (a) In the determination of the amount of supplemental oxygen required for the routes to be flown, it is assumed that the aeroplane will descend in accordance with the emergency procedures specified in the operations manual, without exceeding its operating limitations, to a flight altitude that will allow the flight to be completed safely (i.e. flight altitudes ensuring adequate terrain clearance, navigational accuracy, hazardous weather avoidance, etc.).
- (b) The amount of supplemental oxygen should be determined on the basis of cabin pressure altitude, flight duration and on the assumption that a cabin pressurisation failure will occur at the pressure altitude or point of flight that is most critical from the standpoint of oxygen need.
- (c) Following a cabin pressurisation failure, the cabin pressure altitude should be considered to be the same as the aeroplane pressure altitude unless it can be demonstrated to the competent authority that no probable failure of the cabin or pressurisation system will result in a cabin pressure altitude equal to the aeroplane pressure altitude. Under these circumstances, the demonstrated maximum cabin pressure altitude may be used as a basis for determination of oxygen supply.

AMC2 CAT.IDE.A.235 Supplemental oxygen – pressurised aeroplanes

ED Decision 2014/015/R

OXYGEN REQUIREMENTS FOR FLIGHT CREW COMPARTMENT SEAT OCCUPANTS AND CABIN CREW IN ADDITION TO THE REQUIRED MINIMUM NUMBER OF CABIN CREW

- (a) For the purpose of supplemental oxygen supply, flight crew compartment seat occupants who are:
 - (1) supplied with oxygen from the flight crew source of oxygen should be considered as flight crew members; and
 - (2) not supplied with oxygen by the flight crew source of oxygen should be considered as passengers.
- (b) Cabin crew members in addition to the minimum number of cabin crew and additional crew members should be considered as passengers for the purpose of supplemental oxygen supply.

GM1 CAT.IDE.A.235(b)(1) Supplemental oxygen – pressurised aeroplanes

ED Decision 2014/015/R

QUICK DONNING MASKS

A quick donning mask is a type of mask that:

- (a) can be placed on the face from its ready position, properly secured, sealed and supplying oxygen upon demand, with one hand and within 5 seconds and will thereafter remain in position, both hands being free;
- (b) can be donned without disturbing eye glasses and without delaying the flight crew member from proceeding with assigned emergency duties;
- (c) once donned, does not prevent immediate communication between the flight crew members and other crew members over the aircraft intercommunication system; and
- (d) does not inhibit radio communications.

AMC1 CAT.IDE.A.235(c) Supplemental oxygen – pressurised aeroplanes

ED Decision 2017/004/R

AEROPLANES WITHOUT AUTOMATIC DEPLOYABLE OXYGEN-DISPENSING UNITS

- (a) For operations approved in accordance with Subpart L (SET-IMC) of Annex V (Part-SPA) to Regulation (EU) No 965/2012 with aeroplanes first issued with an individual certificate of airworthiness (CofA) after 8 November 1998, operated at pressure altitudes at or below 25 000 ft, and not fitted with automatic deployable oxygen-dispensing units, the flight crew should manage the descent in case of a loss of power in order to ensure that the cabin pressure altitude is not higher than 13 000 ft for more than 4 min.
- (b) The operator should specify in the operations manual (OM) the aircraft capability in terms of cabin pressure leak rate in case of engine power loss, as well as the relevant procedures.

GM1 CAT.IDE.A.235(c) Supplemental oxygen – pressurised aeroplanes

ED Decision 2017/004/R

AEROPLANES WITHOUT AUTOMATIC DEPLOYABLE OXYGEN-DISPENSING UNITS

For operations approved in accordance with Subpart L (SET-IMC) of Annex V (Part-SPA) to Regulation (EU) No 965/2012, should a loss of engine power occur, it is required that sufficient supplemental oxygen for all occupants is available to allow descent from the maximum certified cruising altitude, performed at the best-range gliding speed and in the best gliding configuration, assuming the maximum cabin pressure leak rate, during the entire flying time when the cabin pressure altitude exceeds 13 000 ft.

In the case of pressurised aeroplanes first issued with an individual certificate of airworthiness (CofA) after 8 November 1998, with a maximum certified cruising altitude above 25 000 ft, and not fitted with automatically deployable oxygen-dispensing units, the amount of supplemental oxygen should be based on a cruising altitude of 25 000 ft as [CAT.IDE.A.235\(c\)](#) limits the operations of such aeroplanes to the aforementioned altitude.

For such single-engined turbine aeroplanes, with the energy source of the pressurisation system being lost (this is at least the case of pressurisation systems relying on bleed air inflow), the cabin pressure altitude increases at a rate dependent upon the pressurisation system design and the cabin pressure leak rate.

Therefore, following an engine failure during such operations, the cabin pressure altitude will remain below 13 000 ft for a certain duration, which should allow the flight crew to descend at the best gliding speed during this period.

The intent of the [CAT.IDE.A.235\(c\)](#) requirement is to ensure that this does not result in any unsafe conditions for the passengers, as the cabin pressure altitude might increase above 13 000 ft, as well as not jeopardise the safety of operations approved in accordance with Subpart L (SET-IMC) of Annex V (Part-SPA) to Regulation (EU) No 965/2012 by maximising the chances of reaching an appropriate landing site.

AMC1 CAT.IDE.A.235(e) Supplemental oxygen – pressurised aeroplanes

ED Decision 2014/015/R

AEROPLANES NOT CERTIFIED TO FLY ABOVE 25 000 ft

- (a) With respect to [CAT.IDE.A.235\(e\)](#), the maximum altitude up to which an aeroplane can operate without a passenger oxygen system being installed and capable of providing oxygen to each cabin occupant, should be established using an emergency descent profile that takes into account the following conditions:
- (1) 17 seconds' time delay for pilot's recognition and reaction, including mask donning, for trouble shooting and configuring the aeroplane for the emergency descent (emergency descent data/charts established by the aeroplane manufacturer and published in the aircraft flight manual (AFM), and/or the AFM should be used to ensure uniform application of the option); and
 - (2) maximum operational speed (V_{MO}) or the airspeed approved in the AFM for emergency descent, (emergency descent data/charts established by the aeroplane manufacturer and published in the AFM, and/or AFM should be used to ensure uniform application of the option), whichever is the less;
- (b) On routes where oxygen is necessary to be carried for 10 % of the passengers for the flight time between 10 000 ft and 13 000 ft, the oxygen should be provided either by:
- (1) a plug-in or drop-out oxygen system with sufficient outlets and dispensing units uniformly distributed throughout the cabin so as to provide oxygen to each passenger at his/her own discretion when seated on his/her assigned seat; or
 - (2) portable bottles, when a cabin crew member is required on board such flight.

CAT.IDE.A.240 Supplemental oxygen – non-pressurised aeroplanes

Regulation (EU) No 965/2012

Non-pressurised aeroplanes operated at pressure altitudes above 10 000 ft shall be equipped with supplemental oxygen equipment capable of storing and dispensing the oxygen supplies in accordance with Table 1.

Table 1

Oxygen minimum requirements for non-pressurised aeroplanes

Supply for	Duration and cabin pressure altitude
1. Occupants of flight crew compartment seats on flight crew compartment duty and crew members assisting flight crew in their duties	The entire flying time at pressure altitudes above 10 000 ft.
2. Required cabin crew members	The entire flying time at pressure altitudes above 13 000 ft and for any period exceeding 30 minutes at pressure altitudes above 10 000 ft but not exceeding 13 000 ft.
3. Additional crew members and 100 % of passengers ⁽¹⁾	The entire flying time at pressure altitudes above 13 000 ft.
4. 10 % of passengers ⁽¹⁾	The entire flying time after 30 minutes at pressure altitudes above 10 000 ft but not exceeding 13 000 ft.
⁽¹⁾ Passenger numbers in Table 1 refer to passengers actually carried on board, including persons younger than 24 months.	

AMC1 CAT.IDE.A.240 Supplemental oxygen – non-pressurised aeroplanes

ED Decision 2014/015/R

AMOUNT OF SUPPLEMENTAL OXYGEN

The amount of supplemental oxygen for sustenance for a particular operation should be determined on the basis of flight altitudes and flight duration, consistent with the operating procedures, including emergency procedures, established for each operation and the routes to be flown, as specified in the operations manual.

CAT.IDE.A.245 Crew protective breathing equipment

Regulation (EU) 2019/1384

- (a) All pressurised aeroplanes and those unpressurised aeroplanes with an MCTOM of more than 5 700 kg or having an MOPSC of more than 19 seats shall be equipped with protective breathing equipment (PBE) to protect the eyes, nose and mouth and to provide for a period of at least 15 minutes:
 - (1) oxygen for each flight crew member on duty in the flight crew compartment;
 - (2) breathing gas for each required cabin crew member, adjacent to his/her assigned station; and
 - (3) breathing gas from a portable PBE for one member of the flight crew, adjacent to his/her assigned station, in the case of aeroplanes operated with a flight crew of more than one and no cabin crew member.
- (b) A PBE intended for flight crew use shall be installed in the flight crew compartment and be accessible for immediate use by each required flight crew member at his/her assigned station.
- (c) A PBE intended for cabin crew use shall be installed adjacent to each required cabin crew member station.

- (d) Aeroplanes shall be equipped with an additional portable PBE installed adjacent to the hand fire extinguisher referred to in points [CAT.IDE.A.250](#) (b) and (c), or adjacent to the entrance of the cargo compartment, in case the hand fire extinguisher is installed in a cargo compartment.
- (e) A PBE while in use shall not prevent the use of the means of communication referred to in [CAT.IDE.A.170](#), [CAT.IDE.A.175](#), [CAT.IDE.A.270](#) and [CAT.IDE.A.330](#).

AMC1 CAT.IDE.A.245 Crew protective breathing equipment

ED Decision 2014/015/R

PROTECTIVE BREATHING EQUIPMENT (PBE)

The supply for PBE for the flight crew members may be provided by the supplemental oxygen required in [CAT.IDE.A.235](#) or [CAT.IDE.A.240](#).

CAT.IDE.A.250 Hand fire extinguishers

Regulation (EU) No 965/2012

- (a) Aeroplanes shall be equipped with at least one hand fire extinguisher in the flight crew compartment.
- (b) At least one hand fire extinguisher shall be located in, or readily accessible for use in, each galley not located on the main passenger compartment.
- (c) At least one hand fire extinguisher shall be available for use in each class A or class B cargo or baggage compartment and in each class E cargo compartment that is accessible to crew members in flight.
- (d) The type and quantity of extinguishing agent for the required fire extinguishers shall be suitable for the type of fire likely to occur in the compartment where the extinguisher is intended to be used and to minimise the hazard of toxic gas concentration in compartments occupied by persons.
- (e) Aeroplanes shall be equipped with at least a number of hand fire extinguishers in accordance with Table 1, conveniently located to provide adequate availability for use in each passenger compartment.

Table 1

Number of hand fire extinguishers

MOPSC	Number of extinguishers
7-30	1
31-60	2
61-200	3
201-300	4
301-400	5
401-500	6
501-600	7
601 or more	8

AMC1 CAT.IDE.A.250 Hand fire extinguishers

ED Decision 2014/015/R

NUMBER, LOCATION AND TYPE

- (a) The number and location of hand fire extinguishers should be such as to provide adequate availability for use, account being taken of the number and size of the passenger compartments, the need to minimise the hazard of toxic gas concentrations and the location of lavatories, galleys, etc. These considerations may result in a number of fire extinguishers greater than the minimum required.
- (b) There should be at least one hand fire extinguisher installed in the flight crew compartment and this should be suitable for fighting both flammable fluid and electrical equipment fires. Additional hand fire extinguishers may be required for the protection of other compartments accessible to the crew in flight. Dry chemical fire extinguishers should not be used in the flight crew compartment, or in any compartment not separated by a partition from the flight crew compartment, because of the adverse effect on vision during discharge and, if conductive, interference with electrical contacts by the chemical residues.
- (c) Where only one hand fire extinguisher is required in the passenger compartments, it should be located near the cabin crew member's station, where provided.
- (d) Where two or more hand fire extinguishers are required in the passenger compartments and their location is not otherwise dictated by consideration of [CAT.IDE.A.250\(b\)](#), an extinguisher should be located near each end of the cabin with the remainder distributed throughout the cabin as evenly as is practicable.
- (e) Unless an extinguisher is clearly visible, its location should be indicated by a placard or sign. Appropriate symbols may also be used to supplement such a placard or sign.

CAT.IDE.A.255 Crash axe and crowbar

Regulation (EU) No 965/2012

- (a) Aeroplanes with an MCTOM of more than 5 700 kg or with an MOPSC of more than nine shall be equipped with at least one crash axe or crowbar located in the flight crew compartment.
- (b) In the case of aeroplanes with an MOPSC of more than 200, an additional crash axe or crowbar shall be installed in or near the rearmost galley area.
- (c) Crash axes and crowbars located in the passenger compartment shall not be visible to passengers.

AMC1 CAT.IDE.A.255 Crash axe and crowbar

ED Decision 2014/015/R

STORAGE OF CRASH AXES AND CROWBARS

Crash axes and crowbars located in the passenger compartment should be stored in a position not visible to passengers.

CAT.IDE.A.260 Marking of break-in points

Regulation (EU) No 379/2014

If areas of the aeroplane's fuselage suitable for break-in by rescue crews in an emergency are marked, such areas shall be marked as shown in Figure 1.

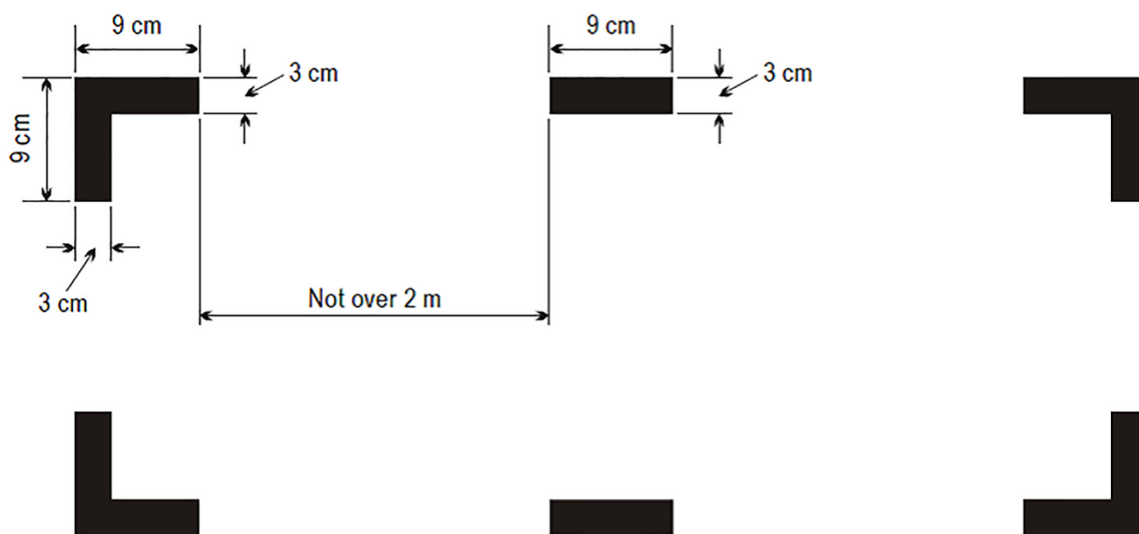
Figure 1

AMC1 CAT.IDE.A.260 Marking of break-in points

ED Decision 2014/015/R

MARKINGS — COLOUR AND CORNERS

- (a) The colour of the markings should be red or yellow and, if necessary, should be outlined in white to contrast with the background.
- (b) If the corner markings are more than 2 m apart, intermediate lines 9 cm x 3 cm should be inserted so that there is no more than 2 m between adjacent markings.

CAT.IDE.A.265 Means for emergency evacuation

Regulation (EU) No 965/2012

- (a) Aeroplanes with passenger emergency exit sill heights of more than 1,83 m (6 ft) above the ground shall be equipped at each of those exits with a means to enable passengers and crew to reach the ground safely in an emergency.
- (b) Notwithstanding (a), such means are not required at overwing exits if the designated place on the aeroplane structure at which the escape route terminates is less than 1,83 m (6 ft) from the ground with the aeroplane on the ground, the landing gear extended, and the flaps in the take-off or landing position, whichever flap position is higher from the ground.
- (c) Aeroplanes required to have a separate emergency exit for the flight crew for which the lowest point of the emergency exit is more than 1,83 m (6 ft) above the ground shall have a means to assist all flight crew members in descending to reach the ground safely in an emergency.
- (d) The heights referred to in (a) and (c) shall be measured:
 - (1) with the landing gear extended; and
 - (2) after the collapse of, or failure to extend of, one or more legs of the landing gear, in the case of aeroplanes with a type certificate issued after 31 March 2000.

CAT.IDE.A.270 Megaphones

Regulation (EU) No 965/2012

Aeroplanes with an MOPSC of more than 60 and carrying at least one passenger shall be equipped with the following quantities of portable battery-powered megaphones readily accessible for use by crew members during an emergency evacuation:

- (a) For each passenger deck:

Table 1

Number of megaphones

Passenger seating configuration	Number of megaphones
61 to 99	1
100 or more	2

- (b) For aeroplanes with more than one passenger deck, in all cases when the total passenger seating configuration is more than 60, at least one megaphone.

AMC1 CAT.IDE.A.270 Megaphones

ED Decision 2014/015/R

LOCATION OF MEGAPHONES

- (a) Where one megaphone is required, it should be readily accessible at the assigned seat of a cabin crew member or crew members other than flight crew.
- (b) Where two or more megaphones are required, they should be suitably distributed in the passenger compartment(s) and readily accessible to crew members assigned to direct emergency evacuations.
- (c) This does not necessarily require megaphones to be positioned such that they can be physically reached by a crew member when strapped in a cabin crew member's seat.

CAT.IDE.A.275 Emergency lighting and marking

Regulation (EU) 2019/1384

- (a) Aeroplanes with an MOPSC of more than nine shall be equipped with an emergency lighting system having an independent power supply to facilitate the evacuation of the aeroplane.
- (b) In the case of aeroplanes with an MOPSC of more than 19, the emergency lighting system, referred to in (a) shall include:
- (1) sources of general cabin illumination;
 - (2) internal lighting in floor level emergency exit areas;
 - (3) illuminated emergency exit marking and locating signs;
 - (4) in the case of aeroplanes for which the application for the type certificate or equivalent was filed before 1 May 1972, when operated by night, exterior emergency lighting at all overwing exits and at exits where descent assist means are required;
 - (5) in the case of aeroplanes for which the application for the type certificate or equivalent was filed after 30 April 1972, when operated by night, exterior emergency lighting at all passenger emergency exits; and

- (6) in the case of aeroplanes for which the type certificate was first issued on or after 31 December 1957, floor proximity emergency escape path marking system(s) in the passenger compartments.
- (c) For aeroplanes with an MOPSC of 19 or less and type certified on the basis of the Agency's certification specification, the emergency lighting system referred to in point (a) shall include the equipment referred to in points (1), (2) and (3) of point (b).
- (d) For aeroplanes with an MOPSC of 19 or less that are not certified on the basis of the Agency's certification specification, the emergency lighting system referred to in point (a) shall include the equipment referred to in point (b)(1).
- (e) Aeroplanes with an MOPSC of nine or less, operated at night, shall be equipped with a source of general cabin illumination to facilitate the evacuation of the aeroplane.

CAT.IDE.A.280 Emergency locator transmitter (ELT)

Regulation (EU) 2015/2338

- (a) Aeroplanes with an MOPSC of more than 19 shall be equipped with at least:
 - (1) two ELTs, one of which shall be automatic, or one ELT and one aircraft localisation means meeting the requirement of [CAT.GEN.MPA.210](#), in the case of aeroplanes first issued with an individual CofA after 1 July 2008; or
 - (2) one automatic ELT or two ELTs of any type or one aircraft localisation means meeting the requirement of [CAT.GEN.MPA.210](#), in the case of aeroplanes first issued with an individual CofA on or before 1 July 2008.
- (b) Aeroplanes with an MOPSC of 19 or less shall be equipped with at least:
 - (1) one automatic ELT or one aircraft localisation means meeting the requirement of [CAT.GEN.MPA.210](#), in the case of aeroplanes first issued with an individual CofA after 1 July 2008; or
 - (2) one ELT of any type or one aircraft localisation means meeting the requirement of [CAT.GEN.MPA.210](#), in the case of aeroplanes first issued with an individual CofA on or before 1 July 2008.
- (c) An ELT of any type shall be capable of transmitting simultaneously on 121,5 MHz and 406 MHz.

AMC1 CAT.IDE.A.280 Emergency locator transmitter (ELT)

ED Decision 2014/015/R

BATTERIES

- (a) All batteries used in ELTs should be replaced (or recharged if the battery is rechargeable) when the equipment has been in use for more than 1 cumulative hour or in the following cases:
 - (1) Batteries specifically designed for use in ELTs and having an airworthiness release certificate (EASA Form 1 or equivalent) should be replaced (or recharged if the battery is rechargeable) before the end of their useful life in accordance with the maintenance instructions applicable to the ELT.
 - (2) Standard batteries manufactured in accordance with an industry standard and not having an airworthiness release certificate (EASA Form 1 or equivalent), when used in ELTs should be replaced (or recharged if the battery is rechargeable) when 50 % of their useful

- life (or for rechargeable, 50 % of their useful life of charge), as established by the battery manufacturer, has expired.
- (3) The battery useful life (or useful life of charge) criteria in (1) and (2) do not apply to batteries (such as water-activated batteries) that are essentially unaffected during probable storage intervals.
- (b) The new expiry date for a replaced (or recharged) battery should be legibly marked on the outside of the equipment.

AMC2 CAT.IDE.A.280 Emergency locator transmitter (ELT)

ED Decision 2021/008/R

TYPES OF ELTs AND GENERAL TECHNICAL SPECIFICATIONS

- (a) The ELT required by this provision should be one of the following:
- (1) Automatic fixed (ELT(AF)). An automatically activated ELT that is permanently attached to an aircraft and is designed to aid search and rescue (SAR) teams in locating the crash site.
 - (2) Automatic portable (ELT(AP)). An automatically activated ELT, that is rigidly attached to an aircraft before a crash, but is readily removable from the aircraft after a crash. It functions as an ELT during the crash sequence. If the ELT(AP) does not employ an integral antenna, the aircraft-mounted antenna may be disconnected and an auxiliary antenna (stored on the ELT case) attached to the ELT. The ELT can be tethered to a survivor or a life-raft. This type of ELT is intended to aid SAR teams in locating the crash site or survivor(s).
 - (3) Automatic deployable (ELT(AD)). An ELT that is rigidly attached to the aircraft before the crash and that is automatically deployed and activated by an impact, and, in some cases, also by water sensors. This type of ELT should float in water and is intended to aid SAR teams in locating the crash site. The ELT(AD) may be either a stand-alone beacon or an inseparable part of a deployable recorder.
 - (4) Distress tracking ELT (ELT(DT)). An ELT that is designed to be activated upon automatic detection of conditions indicative of a distress situation. This type of ELT is intended to provide information prior to the crash, to aid SAR teams in locating the crash site and/or any survivor(s).
 - (5) Survival ELT (ELT(S)). An ELT that is removable from an aircraft, stowed so as to facilitate its ready use in an emergency, and manually activated by a survivor. An ELT(S) may be activated manually or automatically (e.g. by water activation). It should be designed either to be tethered to a life-raft or a survivor. A water-activated ELT(S) is not an ELT(AP).
- (b) To minimise the possibility of damage in the event of a crash impact, the ELT(AF), ELT(AP), ELT(AD), or ELT(DT) should be rigidly fixed to the aircraft structure, as far aft as practicable, with its antenna and connections arranged so as to maximise the probability of the signal being transmitted after a crash.
- (c) Unless an automatic ELT is installed, the ELT(DT) should have capability C (crash survivability) and capability H1 (121.5-MHz homing signal) as specified in EUROCAE ED-62B 'Minimum Operational Performance Standard for Aircraft Emergency Locator Transmitters', dated December 2018, or in any later equivalent standard that is produced by EUROCAE.

- (d) Any ELT carried should operate in accordance with the relevant provisions of ICAO Annex 10, Volume III communications systems and should be registered with the national agency responsible for initiating search and rescue or other nominated agency.

GM1 CAT.IDE.A.280 Emergency locator transmitter (ELT)

ED Decision 2021/008/R

TERMINOLOGY

- (a) An 'automatic ELT' means an ELT(AF), ELT(AP), or ELT(AD). Other types of ELTs are not considered 'automatic ELTs'.
- (b) A 'water sensor' means a sensor that detects water immersion, including at low depth.

GM2 CAT.IDE.A.280 Emergency locator transmitter (ELT)

ED Decision 2021/008/R

ADDITIONAL GUIDANCE

- (a) It is advisable to install automatic ELTs that transmit encoded position data and that meet the operational performance requirements of EUROCAE Document ED-62B, or RTCA DO-204B, or any later equivalent standard.
- (b) Guidance material for the inspection of an ELT can be found in FAA Advisory Circular (AC) 91-44A 'Installation and Inspection Procedures for Emergency Locator Transmitters and Receivers', Change 1, dated February 2018.

CAT.IDE.A.285 Flight over water

Regulation (EU) 2019/1384

- (a) The following aeroplanes shall be equipped with a life-jacket for each person on board or equivalent flotation device for each person on board younger than 24 months, stowed in a position that is readily accessible from the seat or berth of the person for whose use it is provided:
- (1) landplanes operated over water at a distance of more than 50 NM from the shore or taking off or landing at an aerodrome where the take-off or approach path is so disposed over water that there would be a likelihood of a ditching; and
 - (2) seaplanes operated over water.
- (b) Each life-jacket or equivalent individual flotation device shall be equipped with a means of electric illumination for the purpose of facilitating the location of persons.
- (c) Seaplanes operated over water shall be equipped with the following:
- (1) a sea anchor and other equipment necessary to facilitate mooring, anchoring or manoeuvring the seaplane on water, appropriate to its size, mass and handling characteristics;
 - (2) equipment for making the sound signals as prescribed in the International Regulations for Preventing Collisions at Sea, where applicable.

- (d) Aeroplanes operated over water at a distance away from land suitable for making an emergency landing, greater than that corresponding to:
- (1) 120 minutes at cruising speed or 400 NM, whichever is the lesser, in the case of aeroplanes capable of continuing the flight to an aerodrome with the critical engine(s) becoming inoperative at any point along the route or planned diversions; or
 - (2) for all other aeroplanes, 30 minutes at cruising speed or 100 NM, whichever is the lesser, shall be equipped with the equipment specified in (e).
- (e) Aeroplanes complying with (d) shall carry the following equipment:
- (1) life-rafts in sufficient numbers to carry all persons on board, stowed so as to facilitate their ready use in an emergency, and being of sufficient size to accommodate all the survivors in the event of a loss of one raft of the largest rated capacity;
 - (2) a survivor locator light in each life-raft;
 - (3) life-saving equipment to provide the means for sustaining life, as appropriate for the flight to be undertaken; and
 - (4) at least two survival ELTs (ELT(S)).
- (f) By 1 January 2019 at the latest, aeroplanes with an MCTOM of more than 27 000 kg and with an MOPSC of more than 19 and all aeroplanes with an MCTOM of more than 45 500 kg shall be fitted with a securely attached underwater locating device that operates at a frequency of $8,8 \text{ kHz} \pm 1 \text{ kHz}$, unless:
- (1) the aeroplane is operated over routes on which it is at no point at a distance of more than 180 NM from the shore; or
 - (2) the aeroplane is equipped with robust and automatic means to accurately determine, following an accident where the aeroplane is severely damaged, the location of the point of end of flight.

AMC1 CAT.IDE.A.285 Flight over water

ED Decision 2014/015/R

LIFE RAFTS AND EQUIPMENT FOR MAKING DISTRESS SIGNALS

- (a) The following should be readily available with each life-raft:
- (1) means for maintaining buoyancy;
 - (2) a sea anchor;
 - (3) life-lines and means of attaching one life-raft to another;
 - (4) paddles for life-rafts with a capacity of six or less;
 - (5) means of protecting the occupants from the elements;
 - (6) a water-resistant torch;
 - (7) signalling equipment to make the pyrotechnic distress signals described in ICAO Annex 2, 'Rules of the Air';
 - (8) 100 g of glucose tablets for each four, or fraction of four, persons that the life-raft is designed to carry;

- (9) at least 2 litres of drinkable water provided in durable containers or means of making sea water drinkable or a combination of both; and
 - (10) first-aid equipment.
- (b) As far as practicable, items listed in (a) should be contained in a pack.

AMC1 CAT.IDE.A.285(e)(4) & CAT.IDE.A.305(a)(2) Flight over water & Survival equipment

ED Decision 2014/015/R

SURVIVAL ELT

An ELT(AP) may be used to replace one required ELT(S) provided that it meets the ELT(S) requirements. A water-activated ELT(S) is not an ELT(AP).

AMC1 CAT.IDE.A.285(a) Flight over water

ED Decision 2014/015/R

ACCESSIBILITY OF LIFE-JACKETS

The life-jacket should be accessible from the seat or berth of the person for whose use it is provided, with a safety belt or restraint system fastened.

AMC2 CAT.IDE.A.285(a) Flight over water

ED Decision 2014/015/R

ELECTRIC ILLUMINATION OF LIFE-JACKETS

The means of electric illumination should be a survivor locator light as defined in the applicable ETSO issued by the Agency or equivalent.

GM1 CAT.IDE.A.285(a) Flight over water

ED Decision 2014/015/R

SEAT CUSHIONS

Seat cushions are not considered to be flotation devices.

AMC1 CAT.IDE.A.285(f) Flight over water

ED Decision 2015/030/R

LOW-FREQUENCY UNDERWATER LOCATING DEVICE

- (a) The underwater locating device should be compliant with ETSO-C200 or equivalent.
- (b) The underwater locating device should not be installed in wings or empennage.

AMC2 CAT.IDE.A.285(f) Flight over water

ED Decision 2021/008/R

ROBUST AND AUTOMATIC MEANS TO LOCATE THE POINT OF END OF FLIGHT AFTER AN ACCIDENT

The 'robust and automatic means to accurately determine, following an accident where the aeroplane is severely damaged, the location of the point of end of flight' should comply with point [CAT.GEN.MPA.210](#).

GM1 CAT.IDE.A.285(f)(2) Flight over water

ED Decision 2017/023/R

ROBUST AND AUTOMATIC MEANS TO LOCATE THE POINT OF END OF FLIGHT AFTER AN ACCIDENT

[CAT.IDE.A.285\(f\)\(2\)](#) refers to means such as required by [CAT.GEN.MPA.210](#) 'Location of an aircraft in distress'. The adjective 'robust' in [CAT.IDE.A.285\(f\)\(2\)](#) indicates that this means is designed to provide the location of the point of end of flight in non-survivable accident scenarios as well as in survivable accident scenarios.

CAT.IDE.A.305 Survival equipment

Regulation (EU) No 965/2012

- (a) Aeroplanes operated over areas in which search and rescue would be especially difficult shall be equipped with:
 - (1) signalling equipment to make the distress signals;
 - (2) at least one ELT(S); and
 - (3) additional survival equipment for the route to be flown taking account of the number of persons on board.
- (b) The additional survival equipment specified in (a)(3) does not need to be carried when the aeroplane:
 - (1) remains within a distance from an area where search and rescue is not especially difficult corresponding to:
 - (i) 120 minutes at one-engine-inoperative (OEI) cruising speed for aeroplanes capable of continuing the flight to an aerodrome with the critical engine(s) becoming inoperative at any point along the route or planned diversion routes; or
 - (ii) 30 minutes at cruising speed for all other aeroplanes;
 - (2) remains within a distance no greater than that corresponding to 90 minutes at cruising speed from an area suitable for making an emergency landing, for aeroplanes certified in accordance with the applicable airworthiness standard.

AMC1 CAT.IDE.A.305 Survival equipment

ED Decision 2014/015/R

ADDITIONAL SURVIVAL EQUIPMENT

- (a) The following additional survival equipment should be carried when required:
 - (1) 2 litres of drinkable water for each 50, or fraction of 50, persons on board provided in durable containers;
 - (2) one knife;
 - (3) first-aid equipment; and
 - (4) one set of air/ground codes.
- (b) In addition, when polar conditions are expected, the following should be carried:
 - (1) a means for melting snow;
 - (2) one snow shovel and one ice saw;

- (3) sleeping bags for use by 1/3 of all persons on board and space blankets for the remainder or space blankets for all passengers on board; and
 - (4) one arctic/polar suit for each crew member.
- (c) If any item of equipment contained in the above list is already carried on board the aeroplane in accordance with another requirement, there is no need for this to be duplicated.

AMC1 CAT.IDE.A.285(e)(4) & CAT.IDE.A.305(a)(2) Flight over water & Survival equipment

ED Decision 2014/015/R

SURVIVAL ELT

An ELT(AP) may be used to replace one required ELT(S) provided that it meets the ELT(S) requirements. A water-activated ELT(S) is not an ELT(AP).

AMC1 CAT.IDE.A.305(b)(2) Survival equipment

ED Decision 2014/015/R

APPLICABLE AIRWORTHINESS STANDARD

The applicable airworthiness standard should be CS-25 or equivalent.

GM1 CAT.IDE.A.305 Survival equipment

ED Decision 2014/015/R

SIGNALLING EQUIPMENT

The signalling equipment for making distress signals is described in ICAO Annex 2, Rules of the Air.

GM2 CAT.IDE.A.305 Survival equipment

ED Decision 2014/015/R

AREAS IN WHICH SEARCH AND RESCUE WOULD BE ESPECIALLY DIFFICULT

The expression 'areas in which search and rescue would be especially difficult' should be interpreted, in this context, as meaning:

- (a) areas so designated by the authority responsible for managing search and rescue; or
- (b) areas that are largely uninhabited and where:
 - (1) the authority referred to in (a) has not published any information to confirm whether search and rescue would be or would not be especially difficult; and
 - (2) the authority referred to in (a) does not, as a matter of policy, designate areas as being especially difficult for search and rescue.

CAT.IDE.A.325 Headset

Regulation (EU) No 965/2012

- (a) Aeroplanes shall be equipped with a headset with a boom or throat microphone or equivalent for each flight crew member at their assigned station in the flight crew compartment.
- (b) Aeroplanes operated under IFR or at night shall be equipped with a transmit button on the manual pitch and roll control for each required flight crew member.

AMC1 CAT.IDE.A.325 Headset

ED Decision 2014/015/R

GENERAL

- (a) A headset consists of a communication device that includes two earphones to receive and a microphone to transmit audio signals to the aeroplane's communication system. To comply with the minimum performance requirements, the earphones and microphone should match the communication system's characteristics and the flight crew compartment environment. The headset should be sufficiently adjustable to fit the pilot's head. Headset boom microphones should be of the noise cancelling type.
- (b) If the intention is to utilise noise cancelling earphones, the operator should ensure that the earphones do not attenuate any aural warnings or sounds necessary for alerting the flight crew on matters related to the safe operation of the aeroplane.

GM1 CAT.IDE.A.325 Headset

ED Decision 2014/015/R

GENERAL

The term 'headset' includes any aviation helmet incorporating headphones and microphone worn by a flight crew member.

CAT.IDE.A.330 Radio communication equipment

Regulation (EU) No 965/2012

- (a) Aeroplanes shall be equipped with the radio communication equipment required by the applicable airspace requirements.
- (b) The radio communication equipment shall provide for communication on the aeronautical emergency frequency 121,5 MHz.

CAT.IDE.A.335 Audio selector panel

Regulation (EU) No 965/2012

Aeroplanes operated under IFR shall be equipped with an audio selector panel operable from each required flight crew member station.

CAT.IDE.A.340 Radio equipment for operations under VFR over routes navigated by reference to visual landmarks

Regulation (EU) No 965/2012

Aeroplanes operated under VFR over routes navigated by reference to visual landmarks shall be equipped with radio communication equipment necessary under normal radio propagation conditions to fulfil the following:

- (a) communicate with appropriate ground stations;
- (b) communicate with appropriate ATC stations from any point in controlled airspace within which flights are intended; and
- (c) receive meteorological information.

CAT.IDE.A.345 Communication, navigation and surveillance equipment for operations under IFR or under VFR over routes not navigated by reference to visual landmarks

Regulation (EU) 2019/1387

- (a) Aeroplanes operated under IFR or under VFR over routes that cannot be navigated by reference to visual landmarks shall be equipped with radio communication, navigation and surveillance equipment in accordance with the applicable airspace requirements.
- (b) Radio communication equipment shall include at least two independent radio communication systems necessary under normal operating conditions to communicate with an appropriate ground station from any point on the route, including diversions.
- (c) Notwithstanding point (b), aeroplanes operated for short haul operations in the North Atlantic high-level (NAT HLA) airspace and not crossing the North Atlantic shall be equipped with at least one long range communication system, in case alternative communication procedures are published for the airspace concerned.
- (d) Aeroplanes shall have sufficient navigation equipment to ensure that, in the event of the failure of one item of equipment at any stage of the flight, the remaining equipment shall allow safe navigation in accordance with the flight plan.
- (e) Aeroplanes operated on flights in which it is intended to land in IMC shall be equipped with suitable equipment capable of providing guidance to a point from which a visual landing can be performed for each aerodrome at which it is intended to land in IMC and for any designated alternate aerodrome.
- (f) For PBN operations the aircraft shall meet the airworthiness certification requirements for the appropriate navigation specification.

AMC1 CAT.IDE.A.345 Communication and navigation equipment for operations under IFR or under VFR over routes not navigated by reference to visual landmarks

ED Decision 2014/015/R

TWO INDEPENDENT MEANS OF COMMUNICATION

Whenever two independent means of communication are required, each system should have an independent antenna installation, except where rigidly supported non-wire antennae or other antenna installations of equivalent reliability are used.

AMC2 CAT.IDE.A.345 Communication and navigation equipment for operations under IFR or under VFR over routes not navigated by reference to visual landmarks

ED Decision 2014/015/R

ACCEPTABLE NUMBER AND TYPE OF COMMUNICATION AND NAVIGATION EQUIPMENT

- (a) An acceptable number and type of communication and navigation equipment is:
 - (1) one VHF omnidirectional radio range (VOR) receiving system, one automatic direction finder (ADF) system, one distance measuring equipment (DME), except that an ADF

- system need not be installed provided that the use of ADF is not required in any phase of the planned flight;
- (2) one instrument landing system (ILS) or microwave landing system (MLS) where ILS or MLS is required for approach navigation purposes;
 - (3) one marker beacon receiving system where a marker beacon is required for approach navigation purposes;
 - (4) area navigation equipment when area navigation is required for the route being flown (e.g. equipment required by Part-SPA);
 - (5) an additional DME system on any route, or part thereof, where navigation is based only on DME signals;
 - (6) an additional VOR receiving system on any route, or part thereof, where navigation is based only on VOR signals; and
 - (7) an additional ADF system on any route, or part thereof, where navigation is based only on non-directional beacon (NDB) signals.
- (b) Aeroplanes may be operated without the navigation equipment specified in (6) and (7) provided they are equipped with alternative equipment. The reliability and the accuracy of alternative equipment should allow safe navigation for the intended route.
- (c) The operator conducting extended range operations with two-engined aeroplanes (ETOPS) should ensure that the aeroplanes have a communication means capable of communicating with an appropriate ground station at normal and planned contingency altitudes. For ETOPS routes where voice communication facilities are available, voice communications should be provided. For all ETOPS operations beyond 180 minutes, reliable communication technology, either voice-based or data link, should be installed. Where voice communication facilities are not available and where voice communication is not possible or is of poor quality, communications using alternative systems should be ensured.
- (d) To perform IFR operations without an ADF system installed, the operator should consider the following guidelines on equipment carriage, operational procedures and training criteria.
- (1) ADF equipment may only be removed from or not installed in an aeroplane intended to be used for IFR operations when it is not essential for navigation, and provided that alternative equipment giving equivalent or enhanced navigation capability is carried. This may be accomplished by the carriage of an additional VOR receiver or a GNSS receiver approved for IFR operations.
 - (2) For IFR operations without ADF, the operator should ensure that:
 - (i) route segments that rely solely on ADF for navigation are not flown;
 - (ii) ADF/NDB procedures are not flown;
 - (iii) the minimum equipment list (MEL) has been amended to take account of the non-carriage of ADF;
 - (iv) the operations manual does not refer to any procedures based on NDB signals for the aeroplanes concerned; and
 - (v) flight planning and dispatch procedures are consistent with the above mentioned criteria.

- (3) The removal of ADF should be taken into account by the operator in the initial and recurrent training of flight crew.
- (e) VHF communication equipment, ILS localiser and VOR receivers installed on aeroplanes to be operated in IFR should comply with the following FM immunity performance standards:
- (1) ICAO Annex 10, Volume I - Radio Navigation Aids, and Volume III, Part II - Voice Communications Systems; and
 - (2) acceptable equipment standards contained in EUROCAE Minimum Operational Performance Specifications, documents ED-22B for VOR receivers, ED-23B for VHF communication receivers and ED-46B for LOC receivers and the corresponding Radio Technical Commission for Aeronautics (RTCA) documents DO-186, DO-195 and DO-196.

AMC3 CAT.IDE.A.345 Communication and navigation equipment for operations under IFR or under VFR over routes not navigated by reference to visual landmarks

ED Decision 2014/015/R

FAILURE OF A SINGLE UNIT

Required communication and navigation equipment should be installed such that the failure of any single unit required for either communication or navigation purposes, or both, will not result in the failure of another unit required for communications or navigation purposes.

AMC4 CAT.IDE.A.345 Communication and navigation equipment for operations under IFR or under VFR over routes not navigated by reference to visual landmarks

ED Decision 2014/015/R

LONG RANGE COMMUNICATION SYSTEMS

- (a) The long range communication system should be either a high frequency/HF-system or another two-way communication system if allowed by the relevant airspace procedures.
- (b) When using one communication system only, the competent authority may restrict the minimum navigation performance specifications (MNPS) approval to the use of the specific routes.

GM1 CAT.IDE.A.345 Communication and navigation equipment for operations under IFR or under VFR over routes not navigated by reference to visual landmarks

ED Decision 2014/015/R

APPLICABLE AIRSPACE REQUIREMENTS

For aeroplanes being operated under European air traffic control, the applicable airspace requirements include the Single European Sky legislation.

GM2 CAT.IDE.A.345 Communication and navigation equipment for operations under IFR or under VFR over routes not navigated by reference to visual landmarks

ED Decision 2016/015/R

AIRCRAFT ELIGIBILITY FOR PBN SPECIFICATION NOT REQUIRING SPECIFIC APPROVAL

- (a) The performance of the aircraft is usually stated in the AFM.
- (b) Where such a reference cannot be found in the AFM, other information provided by the aircraft manufacturer as TC holder, the STC holder or the design organisation having a privilege to approve minor changes may be considered.
- (c) The following documents are considered acceptable sources of information:
 - (1) AFM, supplements thereto, and documents directly referenced in the AFM;
 - (2) FCOM or similar document;
 - (3) Service Bulletin or Service Letter issued by the TC holder or STC holder;
 - (4) approved design data or data issued in support of a design change approval;
 - (5) any other formal document issued by the TC or STC holders stating compliance with PBN specifications, AMC, Advisory Circulars (AC) or similar documents issued by the State of Design; and
 - (6) written evidence obtained from the State of Design.
- (d) Equipment qualification data, in itself, is not sufficient to assess the PBN capabilities of the aircraft, since the latter depend on installation and integration.
- (e) As some PBN equipment and installations may have been certified prior to the publication of the PBN Manual and the adoption of its terminology for the navigation specifications, it is not always possible to find a clear statement of aircraft PBN capability in the AFM. However, aircraft eligibility for certain PBN specifications can rely on the aircraft performance certified for PBN procedures and routes prior to the publication of the PBN Manual.
- (f) Below, various references are listed which may be found in the AFM or other acceptable documents (see listing above) in order to consider the aircraft's eligibility for a specific PBN specification if the specific term is not used.
- (g) RNAV 5
 - (1) If a statement of compliance with any of the following specifications or standards is found in the acceptable documentation as listed above, the aircraft is eligible for RNAV 5 operations.
 - (i) B-RNAV;
 - (ii) RNAV 1;
 - (iii) RNP APCH;
 - (iv) RNP 4;
 - (v) A-RNP;
 - (vi) AMC 20-4;
 - (vii) JAA TEMPORARY GUIDANCE MATERIAL, LEAFLET NO. 2 (TGL 2);

-
- (viii) JAA AMJ 20X2;
 - (ix) FAA AC 20-130A for en route operations;
 - (x) FAA AC 20-138 for en route operations; and
 - (xi) FAA AC 90-96.
- (h) RNAV 1/RNAV 2
- (1) If a statement of compliance with any of the following specifications or standards is found in the acceptable documentation as listed above, the aircraft is eligible for RNAV 1/RNAV 2 operations.
 - (i) RNAV 1;
 - (ii) PRNAV;
 - (iii) US RNAV type A;
 - (iv) FAA AC 20-138 for the appropriate navigation specification;
 - (v) FAA AC 90-100A;
 - (vi) JAA TEMPORARY GUIDANCE MATERIAL, LEAFLET NO. 10 Rev1 (TGL 10); and
 - (vii) FAA AC 90-100.
 - (2) However, if position determination is exclusively computed based on VOR-DME, the aircraft is not eligible for RNAV 1/RNAV 2 operations.
- (i) RNP 1/RNP 2 continental
- (1) If a statement of compliance with any of the following specifications or standards is found in the acceptable documentation as listed above, the aircraft is eligible for RNP 1/RNP 2 continental operations.
 - (i) A-RNP;
 - (ii) FAA AC 20-138 for the appropriate navigation specification; and
 - (iii) FAA AC 90-105.
 - (2) Alternatively, if a statement of compliance with any of the following specifications or standards is found in the acceptable documentation as listed above and position determination is primarily based on GNSS, the aircraft is eligible for RNP 1/RNP 2 continental operations. However, in these cases, loss of GNSS implies loss of RNP 1/RNP 2 capability.
 - (i) JAA TEMPORARY GUIDANCE MATERIAL, LEAFLET NO. 10 (TGL 10) (any revision); and
 - (ii) FAA AC 90-100.
- (j) RNP APCH — LNAV minima
- (1) If a statement of compliance with any of the following specifications or standards is found in the acceptable documentation as listed above, the aircraft is eligible for RNP APCH — LNAV operations.
 - (i) A-RNP;
 - (ii) AMC 20-27;

- (iii) AMC 20-28;
 - (iv) FAA AC 20-138 for the appropriate navigation specification; and
 - (v) FAA AC 90-105 for the appropriate navigation specification.
 - (2) Alternatively, if a statement of compliance with RNP 0.3 GNSS approaches in accordance with any of the following specifications or standards is found in the acceptable documentation as listed above, the aircraft is eligible for RNP APCH — LNAV operations. Any limitation such as ‘within the US National Airspace’ may be ignored since RNP APCH procedures are assumed to meet the same ICAO criteria around the world.
 - (i) JAA TEMPORARY GUIDANCE MATERIAL, LEAFLET NO. 3 (TGL 3);
 - (ii) AMC 20-4;
 - (iii) FAA AC 20-130A; and
 - (iv) FAA AC 20-138.
- (k) RNP APCH — LNAV/VNAV minima
- (1) If a statement of compliance with any of the following specifications or standards is found in the acceptable documentation as listed above, the aircraft is eligible for RNP APCH — LNAV/VNAV operations.
 - (i) A-RNP;
 - (ii) AMC 20-27 with Baro VNAV;
 - (iii) AMC 20-28;
 - (iv) FAA AC 20-138; and
 - (v) FAA AC 90-105 for the appropriate navigation specification.
 - (2) Alternatively, if a statement of compliance with FAA AC 20-129 is found in the acceptable documentation as listed above, and the aircraft complies with the requirements and limitations of EASA SIB 2014-041, the aircraft is eligible for RNP APCH — LNAV/VNAV operations. Any limitation such as ‘within the US National Airspace’ may be ignored since RNP APCH procedures are assumed to meet the same ICAO criteria around the world.
- (l) RNP APCH — LPV minima
- (1) If a statement of compliance with any of the following specifications or standards is found in the acceptable documentation as listed above, the aircraft is eligible for RNP APCH — LPV operations.
 - (i) AMC 20-28;
 - (ii) FAA AC 20-138 for the appropriate navigation specification; and
 - (iii) FAA AC 90-107.
 - (2) For aircraft that have a TAWS Class A installed and do not provide Mode-5 protection on an LPV approach, the DH is limited to 250 ft.

¹ <http://ad.easa.europa.eu/ad/2014-04>

-
- (m) RNAV 10
- (1) If a statement of compliance with any of the following specifications or standards is found in the acceptable documentation as listed above, the aircraft is eligible for RNAV 10 operations.
- (i) RNP 10;
 - (ii) FAA AC 20-138 for the appropriate navigation specification;
 - (iii) AMC 20-12;
 - (iv) FAA Order 8400.12 (or later revision); and
 - (v) FAA AC 90-105.
- (n) RNP 4
- (1) If a statement of compliance with any of the following specifications or standards is found in the acceptable documentation as listed above, the aircraft is eligible for RNP 4 operations.
- (i) FAA AC 20-138B or later, for the appropriate navigation specification;
 - (ii) FAA Order 8400.33; and
 - (iii) FAA AC 90-105 for the appropriate navigation specification.
- (o) RNP 2 oceanic
- (1) If a statement of compliance with FAA AC 90-105 for the appropriate navigation specification is found in the acceptable documentation as listed above, the aircraft is eligible for RNP 2 oceanic operations.
- (2) If the aircraft has been assessed eligible for RNP 4, the aircraft is eligible for RNP 2 oceanic.
- (p) Special features
- (1) RF in terminal operations (used in RNP 1 and in the initial segment of the RNP APCH)
- (i) If a statement of demonstrated capability to perform an RF leg, certified in accordance with any of the following specifications or standards, is found in the acceptable documentation as listed above, the aircraft is eligible for RF in terminal operations:
 - (A) AMC 20-26; and
 - (B) FAA AC 20-138B or later.
 - (ii) If there is a reference to RF and a reference to compliance with AC 90-105, then the aircraft is eligible for such operations.
- (q) Other considerations
- (1) In all cases, the limitations in the AFM need to be checked; in particular, the use of AP or FD which can be required to reduce the FTE primarily for RNP APCH, RNAV 1, and RNP 1.
- (2) Any limitation such as 'within the US National Airspace' may be ignored since RNP APCH procedures are assumed to meet the same ICAO criteria around the world.

GM3 CAT.IDE.A.345 Communication and navigation equipment for operations under IFR or under VFR over routes not navigated by reference to visual landmarks

ED Decision 2016/015/R

GENERAL

- (a) The PBN specifications for which the aircraft complies with the relevant airworthiness criteria are set out in the AFM, together with any limitations to be observed.
- (b) Because functional and performance requirements are defined for each navigation specification, an aircraft approved for an RNP specification is not automatically approved for all RNAV specifications. Similarly, an aircraft approved for an RNP or RNAV specification having a stringent accuracy requirement (e.g. RNP 0.3 specification) is not automatically approved for a navigation specification having a less stringent accuracy requirement (e.g. RNP 4).

RNP 4

- (c) For RNP 4, at least two LRNSs, capable of navigating to RNP 4, and listed in the AFM, may be operational at the entry point of the RNP 4 airspace. If an item of equipment required for RNP 4 operations is unserviceable, then the flight crew may consider an alternate route or diversion for repairs. For multi-sensor systems, the AFM may permit entry if one GNSS sensor is lost after departure, provided one GNSS and one inertial sensor remain available.

GM1 CAT.IDE.A.345(c) Communication and navigation equipment for operations under IFR or under VFR over routes not navigated by reference to visual landmarks

ED Decision 2014/015/R

SHORT HAUL OPERATIONS

The term 'short haul operations' refers to operations not crossing the North Atlantic.

AMC1 CAT.IDE.A.345(a) Communication, navigation and surveillance equipment for operations under IFR or under VFR over routes not navigated by reference to visual landmarks

ED Decision 2021/005/R

PERFORMANCE-BASED COMMUNICATION AND SURVEILLANCE (PBCS) OPERATIONS

For operations in airspaces where required communication performance (RCP) and required surveillance performance (RSP) for PBCS have been prescribed, the operator should:

- (a) ensure that the communication equipment and surveillance equipment meet the prescribed RCP and RSP specifications respectively, as shown by an AFM statement or equivalent;
- (b) ensure that operational constraints are reflected in the MEL;
- (c) establish and include in the OM:
 - (1) normal, abnormal and contingency procedures;
 - (2) the flight crew qualification and proficiency constraints; and
 - (3) a training programme for relevant personnel consistent with the intended operations;

- (d) ensure continued airworthiness of the communication equipment and surveillance equipment in accordance with the appropriate RCP and RSP specifications respectively;
- (e) ensure that the contracted communication service provider (CSP) for the airspace being flown complies with the required RCP and RSP specifications as well as with monitoring, recording and notification requirements; and
- (f) participate to monitoring programmes established in the airspace being flown in order to:
 - (1) submit the relevant reports of observed communication and surveillance performance respectively; and
 - (2) establish a process for immediate corrective action in case non-compliance with the appropriate RCP or RSP specifications is detected.

GM1 CAT.IDE.A.345(a) Communication, navigation and surveillance equipment for operations under IFR or under VFR over routes not navigated by reference to visual landmarks

ED Decision 2021/005/R

PBCS OPERATIONS — GENERAL

Detailed guidance material on PBCS operations may be found in the following documents:

- (a) ICAO Doc 9869 'Performance-based Communication and Surveillance (PBCS) Manual'
- (b) ICAO Doc 10037 'Global Operational Data Link (GOLD) Manual'

PBCS OPERATIONS — AIRCRAFT ELIGIBILITY

- (a) The aircraft eligibility for compliance with the required RCP/RSP specifications should be demonstrated by the aircraft manufacturer or equipment supplier and be specific to each individual aircraft or the combination of the aircraft type and the equipment. The demonstrated compliance with specific RCP/RSP specifications may be documented in one of the following documents:
 - (1) the type certificate (TC);
 - (2) the supplemental type certificate (STC);
 - (3) the aeroplane flight manual (AFM) or AFM Supplement;
 - (4) a compliance statement from the manufacturer or the holder of the design approval of the data link installation, approved by the State of Design; or
- (b) In addition to the indication of compliance with specific RCP/RSP specifications, the operator should comply with any associated operating limitations, information and procedures specified by the aircraft manufacturer or equipment supplier in the AFM or other appropriate documents.

PBCS OPERATIONS — MEL ENTRIES

- (a) The operator should amend the MEL, in accordance with the items identified by the aircraft manufacturer or equipment supplier in the master minimum equipment list (MMEL) or MMEL supplement, in relation to PBCS capability, to address the impact of losing an associated system/sub-system on data link operational capability.
- (b) As an example, equipment required in current FANS 1/A-capable aircraft, potentially affecting RCP and RSP capabilities, may be the following:

- (1) VHF, SATCOM, or HF/DL1 radios, as applicable;
- (2) ACARS management unit (MU)/communications management unit (CMU);
- (3) flight management computer (FMC) integration; and
- (4) printer, if procedures require its use.

PBCS OPERATIONS — OPERATING PROCEDURES

The operator should establish operating procedures for the flight crew and other relevant personnel, such as but not limited to, flight dispatchers and maintenance personnel. These procedures should cover the usage of PBCS-relevant systems and include as a minimum:

- (a) pre-flight planning requirements including MEL consideration and flight plan filing;
- (b) actions to be taken in the data link operation, to include specific RCP/RSP required cases;
- (c) actions to be taken for the loss of data link capability while in and prior to entering the airspace requiring specific RCP/RSP specifications. Examples may be found in ICAO Doc 10037;
- (d) problem reporting procedures to the local/regional PBCS monitoring body or central reporting body as applicable; and
- (e) compliance with specific regional requirements and procedures, if applicable.

PBCS OPERATIONS — QUALIFICATION AND TRAINING

- (a) The operator should ensure that flight crew and other relevant personnel such as flight dispatchers and maintenance personnel are proficient with PBCS operations. A separate training programme is not required if data link communication is integrated in the current training programme. However, the operator should ensure that the existing training programme incorporates a basic PBCS concept and requirements for flight crew and other personnel that have direct impact on overall data link performance required for the provisions of air traffic services such as reduced separation.
- (b) The elements covered during the training should be as a minimum:
 - (1) Flight crew
 - (i) Data link communication system theory relevant to operational use;
 - (ii) AFM limitations;
 - (iii) Normal pilot response to data link communication messages;
 - (iv) Message elements in the message set used in each environment;
 - (v) RCP/RSP specifications and their performance requirements;
 - (vi) Implementation of performance-based reduced separation with associated RCP/RSP specifications or other possible performance requirements associated with their routes;
 - (vii) Other ATM operations involving data link communication services;
 - (viii) Normal, non-normal and contingency procedures; and
 - (ix) Data link communication failure/problem and reporting.

Note (1) If flight crew has already been trained on data link operations, additional training only on PBCS is required, addressing a basic concept and requirements that

have direct impact on overall data link performance required for provisions of air traffic services (e.g. reduced separation).

Note (2) Training may be provided through training material and other means that simulate the functionality.

- (2) Dispatchers/flight operations officers
 - (i) Proper use of data link and PBCS flight plan designators;
 - (ii) Air traffic service provider's separation criteria and procedures relevant to RCP/RSP specifications;
 - (iii) MEL remarks or exceptions based on data link communication;
 - (iv) Procedures for transitioning to voice communication and other contingency procedures related to the operation in the event of abnormal behaviour of the data link communication;
 - (v) Coordination with the ATS unit related to, or following a special data link communication exceptional event (e.g. log-on or connection failures); and
 - (vi) Contingency procedures to transition to a different separation standard when data link communication fails.
- (3) Engineering and maintenance personnel
 - (i) Data link communication equipment including its installation, maintenance and modification;
 - (ii) MEL relief and procedures for return to service authorisations; and
 - (iii) Correction of reported non-performance of data link system.

PBCS OPERATIONS — CONTINUED AIRWORTHINESS

- (a) The operator should ensure that aircraft systems are properly maintained to continue to meet the applicable RCP/RSP specifications.
- (b) The operator should ensure that the following elements are documented and managed appropriately:
 - (1) configuration and equipment list detailing the pertinent hardware and software components for the aircraft/fleet(s) applicable to the specific RCP/RSP operation;
 - (2) configuration control for subnetwork, communication media and routing policies; and
 - (3) description of systems including display and alerting functions (including message sets).

PBCS OPERATIONS — CSP COMPLIANCE

- (a) The operator should ensure that their contracted CSPs notify the ATS units of any failure condition that may have an impact on PBCS operations. Notification should be made to all relevant ATS units regardless of whether the CSP has a contract with them.
- (b) The operator may demonstrate the compliance of their contracted CSP through service level agreements (SLAs)/contractual arrangements for data link services or through a joint agreement among PBCS stakeholders such as a Memorandum of Understanding (MOU) or a PBCS Charter.

PBCS OPERATIONS — PBCS CHARTER

A PBCS charter has been developed by PBCS stakeholders and is available as an alternative to SLAs in order to validate the agreement between the operator and the CSP for compliance with RCP/RSP required for PBCS operations. The charter is hosted on the website www.FANS-CRA.com where operators and CSPs can subscribe.

PBCS OPERATIONS — PARTICIPATION IN MONITORING PROGRAMMES

- (a) The operator should establish a process to participate in local or regional PBCS monitoring programmes and provide the following information, including any subsequent changes, to monitoring bodies:
 - (1) operator name;
 - (2) operator contact details; and
 - (3) other coordination information as applicable, including appropriate information means for the CSP/SSP service fail notification.
- (b) The process should also address the actions to be taken with respect to problem reporting and resolution of deficiencies, such as:
 - (1) reporting problems identified by the flight crew or other personnel to the PBCS monitoring bodies associated with the route of the flight on which the problem occurred;
 - (2) disclosing operational data in a timely manner to the appropriate PBCS monitoring bodies when requested for the purposes of investigating a reported problem; and
 - (3) investigating and resolving the cause of the deficiencies reported by the PBCS monitoring bodies

CAT.IDE.A.350 Transponder*Regulation (EU) No 965/2012*

Aeroplanes shall be equipped with a pressure altitude reporting secondary surveillance radar (SSR) transponder and any other SSR transponder capability required for the route being flown.

AMC1 CAT.IDE.A.350 Transponder*ED Decision 2014/015/R***SSR TRANSPONDER**

- (a) The secondary surveillance radar (SSR) transponders of aeroplanes being operated under European air traffic control should comply with any applicable Single European Sky legislation.
- (b) If the Single European Sky legislation is not applicable, the SSR transponders should operate in accordance with the relevant provisions of Volume IV of ICAO Annex 10.

CAT.IDE.A.355 Management of aeronautical databases*Regulation (EU) 2016/1199*

- (a) Aeronautical databases used on certified aircraft system applications shall meet data quality requirements that are adequate for the intended use of the data.
- (b) The operator shall ensure the timely distribution and insertion of current and unaltered aeronautical databases to all aircraft that require them.

- (c) Notwithstanding any other occurrence reporting requirements as defined in Regulation (EU) No 376/2014, the operator shall report to the database provider instances of erroneous, inconsistent or missing data that might be reasonably expected to constitute a hazard to flight.

In such cases, the operator shall inform flight crew and other personnel concerned, and shall ensure that the affected data is not used.

AMC1 CAT.IDE.A.355 Management of aeronautical databases

ED Decision 2017/003/R

AERONAUTICAL DATABASES

When the operator of an aircraft uses an aeronautical database that supports an airborne navigation application as a primary means of navigation used to meet the airspace usage requirements, the database provider should be a Type 2 DAT provider certified in accordance with Regulation (EU) 2017/373 or equivalent.

GM1 CAT.IDE.A.355 Management of aeronautical databases

ED Decision 2017/003/R

AERONAUTICAL DATABASE APPLICATION

- (a) Applications using aeronautical databases for which Type 2 DAT providers should be certified in accordance with Regulation (EU) 2017/373 may be found in GM1 DAT.OR.100.
- (b) The certification of a Type 2 DAT provider in accordance with Regulation (EU) 2017/373 ensures data integrity and compatibility with the certified aircraft application/equipment.

GM2 CAT.IDE.A.355 Management of aeronautical databases

ED Decision 2017/003/R

TIMELY DISTRIBUTION

The operator should distribute current and unaltered aeronautical databases to all aircraft requiring them in accordance with the validity period of the databases or in accordance with a procedure established in the operations manual if no validity period is defined.

GM3 CAT.IDE.A.355 Management of aeronautical databases

ED Decision 2017/003/R

STANDARDS FOR AERONAUTICAL DATABASES AND DAT PROVIDERS

- (a) A 'Type 2 DAT provider' is an organisation as defined in Article 2(5)(b) of Regulation (EU) 2017/373.
- (b) Equivalent to a certified 'Type 2 DAT provider' is defined in any Aviation Safety Agreement between the European Union and a third country, including any Technical Implementation Procedures, or any Working Arrangements between EASA and the competent authority of a third country.

SECTION 2 – HELICOPTERS

CAT.IDE.H.100 Instruments and equipment – general

Regulation (EU) 2019/1384

- (a) Instruments and equipment required by this Subpart shall be approved in accordance with the applicable airworthiness requirements, except for the following items:
- (1) independent portable lights;
 - (2) an accurate time piece;
 - (3) chart holder;
 - (4) first-aid kit;
 - (5) megaphones;
 - (6) survival and signalling equipment;
 - (7) sea anchors and equipment for mooring;
 - (8) child restraint devices.
- (b) Instruments and equipment not required under this Annex (Part-CAT) as well as any other equipment which is not required under this Regulation, but carried on a flight, shall comply with the following requirements:
- (1) the information provided by those instruments, equipment or accessories shall not be used by the flight crew members to comply with Annex II to Regulation (EU) 2018/1139 or points [CAT.IDE.H.330](#), [CAT.IDE.H.335](#), [CAT.IDE.H.340](#) and [CAT.IDE.H.345](#) of this Annex;
 - (2) the instruments and equipment shall not affect the airworthiness of the helicopter, even in the case of failures or malfunction.
- (c) If equipment is to be used by one flight crew member at his/her station during flight, it shall be readily operable from that station. When a single item of equipment is required to be operated by more than one flight crew member it shall be installed so that the equipment is readily operable from any station at which the equipment is required to be operated.
- (d) Those instruments that are used by any flight crew member shall be so arranged as to permit the flight crew member to see the indications readily from his/her station, with the minimum practicable deviation from the position and line of vision that he/she normally assumes when looking forward along the flight path.
- (e) All required emergency equipment shall be easily accessible for immediate use.

GM1 CAT.IDE.H.100(a) Instruments and equipment – general

ED Decision 2014/015/R

REQUIRED INSTRUMENTS AND EQUIPMENT THAT DO NOT NEED TO BE APPROVED IN ACCORDANCE WITH COMMISSION REGULATION (EU) NO 748/2012

The functionality of non-installed instruments and equipment required by this Subpart and that do not need an equipment approval, as listed in [CAT.IDE.H.100\(a\)](#), should be checked against recognised industry standards appropriate to the intended purpose. The operator is responsible for ensuring the maintenance of these instruments and equipment.

GM1 CAT.IDE.H.100(b) Instruments and equipment – general

ED Decision 2014/015/R

NOT REQUIRED INSTRUMENTS AND EQUIPMENT THAT DO NOT NEED TO BE APPROVED IN ACCORDANCE WITH COMMISSION REGULATION (EU) NO 748/2012, BUT ARE CARRIED ON A FLIGHT

- (a) The provision of this paragraph does not exempt any installed instrument or item of equipment from complying with Commission Regulation (EU) No 748/2012. In this case, the installation should be approved as required in Commission Regulation (EU) No 748/2012 and should comply with the applicable Certification Specifications as required under that Regulation.
- (b) The failure of additional non-installed instruments or equipment not required by this Part or the Certification Specifications as required under Commission Regulation (EU) No 748/2012 or any applicable airspace requirements should not adversely affect the airworthiness and/or the safe operation of the aircraft. Examples may be the following:
 - (1) portable electronic flight bag (EFB);
 - (2) portable electronic devices carried by flight crew or cabin crew; and
 - (3) non-installed passenger entertainment equipment.

GM1 CAT.IDE.H.100(d) Instruments and equipment — general

ED Decision 2014/015/R

POSITIONING OF INSTRUMENTS

This requirement implies that whenever a single instrument is required to be installed in a helicopter operated in a multi-crew environment, the instrument needs to be visible from each flight crew station.

CAT.IDE.H.105 Minimum equipment for flight

Regulation (EU) 2019/1384

A flight shall not be commenced when any of the helicopter's instruments, items of equipment or functions required for the intended flight are inoperative or missing, unless:

- (a) the helicopter is operated in accordance with the operator's MEL; or
- (b) the operator is approved by the competent authority to operate the helicopter within the constraints of the MMEL in accordance with point [ORO.MLR.105\(j\)](#) of Annex III.

AMC1 CAT.IDE.H.105 Minimum equipment for flight

ED Decision 2021/005/R

MANAGEMENT OF THE STATUS OF CERTAIN INSTRUMENTS, EQUIPMENT OR FUNCTIONS

The operator should control and retain the status of the instruments, equipment or functions required for the intended operation, that are not controlled for the purpose of continuing airworthiness management.

GM1 CAT.IDE.H.105 Minimum equipment for flight

ED Decision 2021/005/R

MANAGEMENT OF THE STATUS OF CERTAIN INSTRUMENTS, EQUIPMENT OR FUNCTIONS

- (a) The operator should define responsibilities and procedures to retain and control the status of instruments, equipment or functions required for the intended operation, that are not controlled for the purpose of continuing airworthiness management.
- (b) Examples of such instruments, equipment or functions may be, but are not limited to, equipment related to navigation approvals as FM immunity or certain software versions.

CAT.IDE.H.115 Operating lights

Regulation (EU) No 965/2012

- (a) Helicopters operated under VFR by day shall be equipped with an anti-collision light system.
- (b) Helicopters operated at night or under IFR shall, in addition to (a), be equipped with:
 - (1) lighting supplied from the helicopter's electrical system to provide adequate illumination for all instruments and equipment essential to the safe operation of the helicopter;
 - (2) lighting supplied from the helicopter's electrical system to provide illumination in all passenger compartments;
 - (3) an independent portable light for each required crew member readily accessible to crew members when seated at their designated stations;
 - (4) navigation/position lights;
 - (5) two landing lights of which at least one is adjustable in flight so as to illuminate the ground in front of and below the helicopter and the ground on either side of the helicopter; and
 - (6) lights to conform with the International Regulations for Preventing Collisions at Sea if the helicopter is amphibious.

CAT.IDE.H.125 Operations under VFR by day – flight and navigational instruments and associated equipment

Regulation (EU) 2019/1384

- (a) Helicopters operated under VFR by day shall be equipped with the following equipment, available at the pilot's station:
 - (1) A means of measuring and displaying:
 - (i) Magnetic heading;
 - (ii) Time in hours, minutes, and seconds;
 - (iii) Barometric altitude;
 - (iv) Indicated airspeed;
 - (v) Vertical speed;
 - (vi) Slip; and
 - (vii) Outside air temperature.

- (2) A means of indicating when the supply of power to the required flight instruments is not adequate.
- (b) Whenever two pilots are required for the operation, an additional separate means of displaying the following shall be available for the second pilot:
 - (1) Barometric altitude;
 - (2) Indicated airspeed;
 - (3) Vertical speed; and
 - (4) Slip.
- (c) Helicopters with an MCTOM of more than 3 175 kg or any helicopter operating over water when out of sight of land or when the visibility is less than 1 500 m, shall be equipped with a means of measuring and displaying:
 - (1) Attitude; and
 - (2) Heading.
- (d) A means for preventing malfunction of the airspeed indicating systems due to condensation or icing shall be available for helicopters with an MCTOM of more than 3 175 kg or an MOPSC of more than nine.

AMC1 CAT.IDE.H.125 & CAT.IDE.H.130 Operations under VFR by day & Operations under IFR or at night – flight and navigational instruments and associated equipment

ED Decision 2014/015/R

INTEGRATED INSTRUMENTS

- (a) Individual equipment requirements may be met by combinations of instruments or by integrated flight systems or by a combination of parameters on electronic displays, provided that the information so available to each required pilot is not less than the required in the applicable operational requirements, and the equivalent safety of the installation has been shown during type certification approval of the helicopter for the intended type of operation.
- (b) The means of measuring and indicating slip, helicopter attitude and stabilised helicopter heading may be met by combinations of instruments or by integrated flight director systems, provided that the safeguards against total failure, inherent in the three separate instruments, are retained.

AMC1 CAT.IDE.H.125(a)(1)(i) & CAT.IDE.H.130(a)(1) Operations under VFR by day & Operations under IFR or at night — flight and navigational instruments and associated equipment

ED Decision 2014/015/R

MEANS OF MEASURING AND DISPLAYING MAGNETIC HEADING

The means of measuring and displaying magnetic direction should be a magnetic compass or equivalent.

AMC1 CAT.IDE.H.125(a)(1)(ii) & CAT.IDE.H.130(a)(2) Operations under VFR by day & Operations under IFR or at night – flight and navigational instruments and associated equipment

ED Decision 2014/015/R

MEANS OF MEASURING AND DISPLAYING THE TIME

An acceptable means of compliance is a clock displaying hours, minutes and seconds, with a sweep-second pointer or digital presentation.

AMC1 CAT.IDE.H.125(a)(1)(iii) & CAT.IDE.H.130(b) Operations under VFR by day & Operations under IFR or at night – flight and navigational instruments and associated equipment

ED Decision 2014/015/R

CALIBRATION OF THE MEANS OF MEASURING AND DISPLAYING PRESSURE ALTITUDE

The instrument measuring and displaying pressure altitude should be of a sensitive type calibrated in feet (ft), with a sub-scale setting, calibrated in hectopascals/millibars, adjustable for any barometric pressure likely to be set during flight.

AMC1 CAT.IDE.H.125(a)(1)(iv) & CAT.IDE.H.130(a)(3) Operations under VFR by day & Operations under IFR or at night – flight and navigational instruments and associated equipment

ED Decision 2014/015/R

CALIBRATION OF THE INSTRUMENT INDICATING AIRSPEED

The instrument indicating airspeed should be calibrated in knots (kt).

AMC1 CAT.IDE.H.125(a)(1)(vii) & CAT.IDE.H.130(a)(8) Operations under VFR by day & Operations under IFR or at night – flight and navigational instruments and associated equipment

ED Decision 2014/015/R

OUTSIDE AIR TEMPERATURE

- (a) The means of displaying outside air temperature should be calibrated in degrees Celsius.
- (b) The means of displaying outside air temperature may be an air temperature indicator that provides indications that are convertible to outside air temperature.

AMC1 CAT.IDE.H.125(b) & CAT.IDE.H.130(h) Operations under VFR by day & Operations under IFR or at night – flight and navigational instruments and associated equipment

ED Decision 2015/007/R

MULTI-PILOT OPERATIONS — DUPLICATE INSTRUMENTS

Duplicate instruments should include separate displays for each pilot and separate selectors or other associated equipment where appropriate.

GM1 CAT.IDE.H.125(b) Operations under VFR by day — flight and navigational instruments and associated equipment

ED Decision 2022/012/R

MULTI-PILOT OPERATIONS

- (a) Two pilots are required for the operation if required by the one of the following:
- (1) the AFM;
 - (2) point [ORO.FC.200](#).

MULTI-PILOT OPERATIONS ON A VOLUNTARY BASIS — HELICOPTERS OPERATED UNDER VFR BY DAY

- (b) If the AFM permits single-pilot operations, and the operator decides that the crew composition is more than one pilot, then point [CAT.IDE.H.125\(b\)](#) does not apply. However, additional means to display instruments referred to in [CAT.IDE.H.125\(b\)](#) may be required by point [CAT.IDE.H.100\(d\)](#).

AMC1 CAT.IDE.H.125(c)(2) & CAT.IDE.H.130(a)(7) Operations under VFR by day & Operations under IFR or at night – flight and navigational instruments and associated equipment

ED Decision 2014/015/R

STABILISED HEADING

Stabilised heading should be achieved for VFR flights by a gyroscopic heading indicator, whereas for IFR flights, this should be achieved through a magnetic gyroscopic heading indicator.

AMC1 CAT.IDE.H.125(d) & CAT.IDE.H.130(d) Operations under VFR by day & Operations under IFR or at night operations – flight and navigational instruments and associated equipment

ED Decision 2014/015/R

MEANS OF PREVENTING MALFUNCTION DUE TO CONDENSATION OR ICING

The means of preventing malfunction due to either condensation or icing of the airspeed indicating system should be a heated pitot tube or equivalent.

GM1 CAT.IDE.H.125 & CAT.IDE.H.130 Operations under VFR by day & Operations under IFR or at night – flight and navigational instruments and associated equipment

ED Decision 2014/015/R

SUMMARY TABLE
Table 1

Flight and navigational instruments and associated equipment

SERIAL		FLIGHTS UNDER VFR		FLIGHTS UNDER IFR OR AT NIGHT	
INSTRUMENT		SINGLE-PILOT	TWO PILOTS REQUIRED	SINGLE-PILOT	TWO PILOTS REQUIRED
(a)		(b)	(c)	(d)	(e)
1	Magnetic direction	1	1	1	1
2	time	1	1	1	1
3	Pressure altitude	1	2	2 Note (1)	2
4	Indicated airspeed	1	2	1	2
5	Vertical speed	1	2	1	2
6	Slip	1	2	1	2
7	Attitude	1 Note (2)	2 Note(2)	1	2
8	Stabilised direction	1 Note (2)	2 Note(2)	1	2
9	Outside air temperature	1	1	1	1
10	Airspeed icing protection	1 Note (3)	2 Note (3)	1	2
11	Airspeed icing protection failure indicating			1 Note (4)	2 Note (4)
12	Static pressure source			2	2
13	Standby attitude			1 Note (5)	1 Note (5)
14	Chart holder			1 Note (6)	1 Note (6)

Note (1) For single-pilot night operation under VFR, one means of measuring and displaying pressure altitude may be substituted by a means of measuring and displaying radio altitude.

Note (2) Applicable only to helicopters with a maximum certified take-off mass (MCTOM) of more than 3 175 kg; or helicopters operated over water when out of sight of land or when the visibility is less than 1 500 m.

Note (3) Applicable only to helicopters with an MCTOM of more than 3 175 kg, or with an MOPSC of more than 9.

Note (4) The pitot heater failure annunciation applies to any helicopter issued with an individual CofA on or after 1 August 1999. It also applies before that date when: the helicopter has a MCTOM of more than 3 175 kg and an MOPSC of more than 9.

Note (5) For helicopters with an MCTOM of more than 3 175 kg, CS 29.1303(g) may require either a gyroscopic rate-of-turn indicator combined with a slip-skid indicator (turn and bank indicator) or a standby attitude

indicator satisfying the requirements. In any case, the original type certification standard should be referred to determine the exact requirement.

Note (6) Applicable only to helicopters operating under IFR.

CAT.IDE.H.130 Operations under IFR or at night – flight and navigational instruments and associated equipment

Regulation (EU) 2019/1384

Helicopters operated under VFR at night or under IFR shall be equipped with the following equipment, available at the pilot's station:

- (a) A means of measuring and displaying:
 - (1) Magnetic heading;
 - (2) Time in hours, minutes and seconds;
 - (3) Indicated airspeed;
 - (4) Vertical speed;
 - (5) Slip;
 - (6) Attitude;
 - (7) Stabilised heading; and
 - (8) Outside air temperature.
- (b) Two means of measuring and displaying barometric altitude. For single-pilot operations under VFR at night one pressure altimeter may be substituted by a radio altimeter.
- (c) A means of indicating when the supply of power to the required flight instruments is not adequate.
- (d) A means of preventing malfunction of the airspeed indicating systems required in (a)(3) and (h)(2) due to either condensation or icing.
- (e) A means of annunciating to the flight crew the failure of the means required in (d) for helicopters:
 - (1) issued with an individual CofA on or after 1 August 1999; or
 - (2) issued with an individual CofA before 1 August 1999 with an MCTOM of more than 3 175 kg, and with an MOPSC of more than nine.
- (f) A standby means of measuring and displaying attitude that:
 - (1) is powered continuously during normal operation and, in the event of a total failure of the normal electrical generating system, is powered from a source independent of the normal electrical generating system;
 - (2) operates independently of any other means of measuring and displaying attitude;
 - (3) is capable of being used from either pilot's station;
 - (4) is operative automatically after total failure of the normal electrical generating system;
 - (5) provides reliable operation for a minimum of 30 minutes or the time required to fly to a suitable alternate landing site when operating over hostile terrain or offshore, whichever

- is greater, after total failure of the normal electrical generating system, taking into account other loads on the emergency power supply and operational procedures;
- (6) is appropriately illuminated during all phases of operation; and
 - (7) is associated with a means to alert the flight crew when operating under its dedicated power supply, including when operated by emergency power.
- (g) An alternate source of static pressure for the means of measuring altitude, airspeed and vertical speed.
- (h) Whenever two pilots are required for the operation, a separate means for displaying for the second pilot:
- (1) Barometric altitude;
 - (2) Indicated airspeed;
 - (3) Vertical speed;
 - (4) Slip;
 - (5) Attitude; and
 - (6) Stabilised heading.
- (i) For IFR operations, a chart holder in an easily readable position that can be illuminated for night operations.

GM1 CAT.IDE.H.130(a)(3) Operations under IFR — flight and navigational instruments and associated equipment

ED Decision 2017/008/R

ALTIMETERS

Altimeters with counter drum-pointer or equivalent presentation are considered to be less susceptible to misinterpretation for helicopters operating above 10 000 ft.

AMC1 CAT.IDE.H.130(e) Operations under IFR or at night – flight and navigational instruments and associated equipment

ED Decision 2014/015/R

MEANS OF INDICATING FAILURE OF THE AIRSPEED INDICATING SYSTEM'S MEANS OF PREVENTING MALFUNCTION DUE TO EITHER CONDENSATION OR ICING

A combined means of indicating failure of the airspeed indicating system's means of preventing malfunction due to either condensation or icing is acceptable provided that it is visible from each flight crew station and that there it is a means to identify the failed heater in systems with two or more sensors.

AMC1 CAT.IDE.H.130(f)(6) Operations under IFR or at night – flight and navigational instruments and associated equipment

ED Decision 2014/015/R

ILLUMINATION OF STANDBY MEANS OF MEASURING AND DISPLAYING ATTITUDE

The standby means of measuring and displaying attitude should be illuminated so as to be clearly visible under all conditions of daylight and artificial lighting.

GM1 CAT.IDE.H.130(h) Operations under IFR or at night – flight and navigational instruments and associated equipment

ED Decision 2022/012/R

MULTI-PILOT OPERATIONS

Two pilots are required for the operation if required by the one of the following:

- (a) the AFM;
- (b) the operations manual.

AMC1 CAT.IDE.H.130(i) Operations under IFR or at night – flight and navigational instruments and associated equipment

ED Decision 2014/015/R

CHART HOLDER

An acceptable means of compliance with the chart holder requirement is to display a pre-composed chart on an electronic flight bag (EFB).

GM1 CAT.IDE.H.125 & CAT.IDE.H.130 Operations under VFR by day & Operations under IFR or at night – flight and navigational instruments and associated equipment

ED Decision 2014/015/R

SUMMARY TABLE

Table 1

Flight and navigational instruments and associated equipment

SERIAL		FLIGHTS UNDER VFR		FLIGHTS UNDER IFR OR AT NIGHT	
INSTRUMENT		SINGLE-PILOT	TWO PILOTS REQUIRED	SINGLE-PILOT	TWO PILOTS REQUIRED
(a)		(b)	(c)	(d)	(e)
1	Magnetic direction	1	1	1	1
2	time	1	1	1	1
3	Pressure altitude	1	2	2 Note (1)	2
4	Indicated airspeed	1	2	1	2
5	Vertical speed	1	2	1	2
6	Slip	1	2	1	2

SERIAL		FLIGHTS UNDER VFR		FLIGHTS UNDER IFR OR AT NIGHT	
INSTRUMENT		SINGLE-PILOT	TWO PILOTS REQUIRED	SINGLE-PILOT	TWO PILOTS REQUIRED
7	Attitude	1 Note (2)	2 Note(2)	1	2
8	Stabilised direction	1 Note (2)	2 Note(2)	1	2
9	Outside air temperature	1	1	1	1
10	Airspeed icing protection	1 Note (3)	2 Note (3)	1	2
11	Airspeed icing protection failure indicating			1 Note (4)	2 Note (4)
12	Static pressure source			2	2
13	Standby attitude			1 Note (5)	1 Note (5)
14	Chart holder			1 Note (6)	1 Note (6)

Note (1) For single-pilot night operation under VFR, one means of measuring and displaying pressure altitude may be substituted by a means of measuring and displaying radio altitude.

Note (2) Applicable only to helicopters with a maximum certified take-off mass (MCTOM) of more than 3 175 kg; or helicopters operated over water when out of sight of land or when the visibility is less than 1 500 m.

Note (3) Applicable only to helicopters with an MCTOM of more than 3 175 kg, or with an MOPSC of more than 9.

Note (4) The pitot heater failure annunciation applies to any helicopter issued with an individual CofA on or after 1 August 1999. It also applies before that date when: the helicopter has a MCTOM of more than 3 175 kg and an MOPSC of more than 9.

Note (5) For helicopters with an MCTOM of more than 3 175 kg, CS 29.1303(g) may require either a gyroscopic rate-of-turn indicator combined with a slip-skid indicator (turn and bank indicator) or a standby attitude indicator satisfying the requirements. In any case, the original type certification standard should be referred to determine the exact requirement.

Note (6) Applicable only to helicopters operating under IFR.

CAT.IDE.H.135 Additional equipment for single-pilot operation under IFR

Regulation (EU) No 965/2012

Helicopters operated under IFR with a single-pilot shall be equipped with an autopilot with at least altitude hold and heading mode.

CAT.IDE.H.145 Radio altimeters

Regulation (EU) No 965/2012

(a) Helicopters on flights over water shall be equipped with a radio altimeter capable of emitting an audio warning below a pre-set height and a visual warning at a height selectable by the pilot, when operating:

- (1) out of sight of the land;
- (2) in a visibility of less than 1 500 m;

- (3) at night; or
- (4) at a distance from land corresponding to more than three minutes at normal cruising speed.

AMC1 CAT.IDE.H.145 Radio altimeters

ED Decision 2016/022/R

AUDIO WARNING DEVICE

- (a) The audio warning should be a voice warning.
- (b) The audio warning may be provided by a helicopter terrain awareness and warning system (HTAWS).

AMC2 CAT.IDE.H.145 Radio altimeters

ED Decision 2016/022/R

RADIO ALTIMETER DISPLAY

The radio altimeter should be of an analogue type display presentation that requires minimal interpretation for both an instantaneous impression of absolute height and rate of change of height.

GM1 CAT.IDE.H.145 Radio altimeters

ED Decision 2016/022/R

AUDIO-VOICE-ALERTING DEVICE

- (a) To be effective, the voice warning alert should be distinguishable from other warnings and should contain a clear and concise voice message.
- (b) The warning format should meet the following conditions:
 - (1) the warning should be unique (i.e. voice);
 - (2) it should not be inhibited by any other audio warnings, except by higher priority alerts such as helicopter terrain awareness and warning system (HTAWS); and
 - (3) the urgency of the warning should be adequate to draw attention but not such as to cause undue annoyance during deliberate descents through the datum height.
- (c) The criteria above can be satisfactorily met if the warning format incorporates all of the following features:
 - (1) a unique tone should precede the voice message; a further tone after the voice may enhance uniqueness and attract more attention without causing undue annoyance;
 - (2) the perceived tone and voice should be moderately urgent;
 - (3) the message should be compact as opposed to lengthy provided that the meaning is not compromised, e.g. 'One fifty feet' as opposed to 'One hundred and fifty feet';
 - (4) an information message is preferable (e.g. 'One hundred feet'); messages such as 'Low height' do not convey the correct impression during deliberate descents through the datum height;
 - (5) command messages (e.g. 'Pull up, pull up') should not be used unless they relate specifically to height monitoring (e.g. 'Check height'); and

- (6) the volume of the warning should be adequate and not variable below an acceptable minimum value.
- (d) Every effort should be made to prevent spurious warnings.
- (e) The height at which the audio warning is triggered by the radio altimeter should be such as to provide adequate warning for the pilot to take corrective action. It is envisaged that most installations will adopt a height in the range of 100–160 ft. The datum should not be adjustable in flight.
- (f) The preset datum height should not be set in a way that it coincides with commonly used instrument approach minima (i.e. 200 ft). Once triggered, the message should sound within 0.5 sec.
- (g) The voice warning should be triggered only whilst descending through the preset datum height and be inhibited whilst ascending.

GM2 CAT.IDE.H.145 Radio altimeters

ED Decision 2016/022/R

RADIO ALTIMETER DISPLAY

An analogue type display presentation may be, for example, a representation of a dial, ribbon or bar, but not a display that provides numbers only. An analogue type display may be embedded into an electronic flight instrument system (EFIS).

CAT.IDE.H.160 Airborne weather detecting equipment

Regulation (EU) No 965/2012

Helicopters with an MOPSC of more than nine and operated under IFR or at night shall be equipped with airborne weather detecting equipment when current weather reports indicate that thunderstorms or other potentially hazardous weather conditions, regarded as detectable with airborne weather detecting equipment, may be expected to exist along the route to be flown.

AMC1 CAT.IDE.H.160 Airborne weather detecting equipment

ED Decision 2014/015/R

GENERAL

The airborne weather detecting equipment should be an airborne weather radar.

CAT.IDE.H.165 Additional equipment for operations in icing conditions at night

Regulation (EU) No 965/2012

- (a) Helicopters operated in expected or actual icing conditions at night shall be equipped with a means to illuminate or detect the formation of ice.
- (b) The means to illuminate the formation of ice shall not cause glare or reflection that would handicap crew members in the performance of their duties.

CAT.IDE.H.170 Flight crew interphone system

Regulation (EU) No 965/2012

Helicopters operated by more than one flight crew member shall be equipped with a flight crew interphone system, including headsets and microphones for use by all flight crew members.

AMC1 CAT.IDE.H.170 Flight crew interphone system

ED Decision 2014/015/R

TYPE OF FLIGHT CREW INTERPHONE

The flight crew interphone system should not be of a handheld type.

CAT.IDE.H.175 Crew member interphone system

Regulation (EU) No 965/2012

Helicopters shall be equipped with a crew member interphone system when carrying a crew member other than a flight crew member.

AMC1 CAT.IDE.H.175 Crew member interphone system

ED Decision 2014/015/R

SPECIFICATIONS

The crew member interphone system should:

- (a) operate independently of the public address system except for handsets, headsets, microphones, selector switches and signalling devices;
- (b) in the case of helicopters where at least one cabin crew member is required, be readily accessible for use at required cabin crew stations close to each separate or pair of floor level emergency exits;
- (c) in the case of helicopters where at least one cabin crew member is required, have an alerting system incorporating aural or visual signals for use by flight and cabin crew;
- (d) have a means for the recipient of a call to determine whether it is a normal call or an emergency call that uses one or a combination of the following:
 - (1) lights of different colours;
 - (2) codes defined by the operator (e.g. different number of rings for normal and emergency calls); or
 - (3) any other indicating signal specified in the operations manual;
- (e) provide a means of two-way communication between the flight crew compartment and each crew member station; and
- (f) be readily accessible for use from each required flight crew station in the flight crew compartment.

CAT.IDE.H.180 Public address system

Regulation (EU) No 965/2012

- (a) Helicopters with an MOPSC of more than nine shall be equipped with a public address system, with the exception of (b).

- (b) Notwithstanding (a) helicopters with an MOPSC of more than nine and less than 20 are exempted from having a public address system, if:
- (1) the helicopter is designed without a bulkhead between pilot and passengers; and
 - (2) the operator is able to demonstrate that when in flight, the pilot's voice is audible and intelligible at all passengers' seats.

AMC1 CAT.IDE.H.180 Public address system

ED Decision 2014/015/R

SPECIFICATIONS

The public address system should:

- (a) operate independently of the interphone systems except for handsets, headsets, microphones, selector switches and signalling devices;
- (b) be readily accessible for immediate use from each required flight crew station;
- (c) have, for each floor level passenger emergency exit that has an adjacent cabin crew seat, a microphone operable by the seated cabin crew member, except that one microphone may serve more than one exit, provided the proximity of exits allows unassisted verbal communication between seated cabin crew members;
- (d) be operable within ten seconds by a cabin crew member at each of those stations;
- (e) be audible at all passenger seats, lavatories, cabin crew seats and work stations and any other location or compartment that may be occupied by persons; and
- (f) following a total failure of the normal electrical generating system, provide reliable operation for a minimum of ten minutes.

CAT.IDE.H.185 Cockpit voice recorder

Regulation (EU) 2015/2338

- (a) The following helicopter types shall be equipped with a cockpit voice recorder (CVR):
 - (1) all helicopters with an MCTOM of more than 7 000 kg; and
 - (2) helicopters with an MCTOM of more than 3 175 kg and first issued with an individual CofA on or after 1 January 1987.
- (b) The CVR shall be capable of retaining the data recorded during at least:
 - (1) the preceding two hours for helicopters referred to in (a)(1) and (a)(2), when first issued with an individual CofA on or after 1 January 2016;
 - (2) the preceding one hour for helicopters referred to in (a)(1), when first issued with an individual CofA on or after 1 August 1999 and before 1 January 2016;
 - (3) the preceding 30 minutes for helicopters referred to in (a)(1), when first issued with an individual CofA before 1 August 1999; or
 - (4) the preceding 30 minutes for helicopters referred to in (a)(2), when first issued with an individual CofA before 1 January 2016.
- (c) By 1 January 2019 at the latest, the CVR shall record on means other than magnetic tape or magnetic wire.

- (d) The CVR shall record with reference to a timescale:
- (1) voice communications transmitted from or received in the flight crew compartment by radio;
 - (2) flight crew members' voice communications using the interphone system and the public address system, if installed;
 - (3) the aural environment of the flight crew compartment, including without interruption:
 - (i) for helicopters first issued with an individual CofA on or after 1 August 1999, the audio signals received from each crew microphone;
 - (ii) for helicopters first issued with an individual CofA before 1 August 1999, the audio signals received from each crew microphone, where practicable;
 - (4) voice or audio signals identifying navigation or approach aids introduced into a headset or speaker.
- (e) The CVR shall start to record prior to the helicopter moving under its own power and shall continue to record until the termination of the flight when the helicopter is no longer capable of moving under its own power.
- (f) In addition to (e), for helicopters referred to in (a)(2) issued with an individual CofA on or after 1 August 1999:
- (1) the CVR shall start automatically to record prior to the helicopter moving under its own power and continue to record until the termination of the flight when the helicopter is no longer capable of moving under its own power; and
 - (2) depending on the availability of electrical power, the CVR shall start to record as early as possible during the cockpit checks prior to engine start at the beginning of the flight until the cockpit checks immediately following engine shutdown at the end of the flight.
- (g) If the CVR is not deployable, it shall have a device to assist in locating it under water. By 1 January 2020 at the latest, this device shall have a minimum underwater transmission time of 90 days. If the CVR is deployable, it shall have an automatic emergency locator transmitter.

AMC1 CAT.IDE.H.185 Cockpit voice recorder

ED Decision 2015/021/R

OPERATIONAL PERFORMANCE REQUIREMENTS

- (a) For helicopters first issued with an individual CofA on or after 1 January 2016, the operational performance requirements for cockpit voice recorders (CVRs) should be those laid down in EUROCAE Document ED-112 Minimum Operational Performance Specification for Crash Protected Airborne Recorder Systems dated March 2003, including Amendments No 1 and No 2, or any later equivalent standard produced by EUROCAE; and
- (b) the operational performance requirements for equipment dedicated to the CVR should be those laid down in the European Organisation for Civil Aviation Equipment (EUROCAE) Document ED-56A (Minimum Operational Performance Requirements For Cockpit Voice Recorder Systems) dated December 1993, or EUROCAE Document ED-112 (Minimum Operational Performance Specification for Crash Protected Airborne Recorder Systems) dated March 2003, including Amendments No^o1 and No^o2, or any later equivalent standard produced by EUROCAE.

CAT.IDE.H.190 Flight data recorder

Regulation (EU) 2015/2338

- (a) The following helicopters shall be equipped with an FDR that uses a digital method of recording and storing data and for which a method of readily retrieving that data from the storage medium is available:
 - (1) helicopters with an MCTOM of more than 3 175 kg and first issued with an individual CofA on or after 1 August 1999;
 - (2) helicopters with an MCTOM of more than 7 000 kg, or an MOPSC of more than nine, and first issued with an individual CofA on or after 1 January 1989 but before 1 August 1999.
- (b) The FDR shall record the parameters required to determine accurately the:
 - (1) flight path, speed, attitude, engine power, operation and configuration and be capable of retaining the data recorded during at least the preceding 10 hours, for helicopters referred to in (a)(1) and first issued with an individual CofA on or after 1 January 2016;
 - (2) flight path, speed, attitude, engine power and operation and be capable of retaining the data recorded during at least the preceding eight hours, for helicopters referred to in (a)(1) and first issued with an individual CofA before 1 January 2016;
 - (3) flight path, speed, attitude, engine power and operation and be capable of retaining the data recorded during at least the preceding five hours, for helicopters referred to in (a)(2).
- (c) Data shall be obtained from helicopter sources that enable accurate correlation with information displayed to the flight crew.
- (d) The FDR shall automatically start to record the data prior to the helicopter being capable of moving under its own power and shall stop automatically after the helicopter is incapable of moving under its own power.
- (e) If the FDR is not deployable, it shall have a device to assist in locating it under water. By 1 January 2020 at the latest, this device shall have a minimum underwater transmission time of 90 days. If the FDR is deployable, it shall have an automatic emergency locator transmitter.

AMC1.1 CAT.IDE.H.190 Flight data recorder

ED Decision 2016/012/R

OPERATIONAL PERFORMANCE REQUIREMENTS FOR HELICOPTERS HAVING AN MCTOM OF MORE THAN 3 175 KG AND FIRST ISSUED WITH AN INDIVIDUAL CofA ON OR AFTER 1 JANUARY 2016 AND BEFORE 1 JANUARY 2023

- (a) The operational performance requirements for flight data recorders (FDRs) should be those laid down in EUROCAE Document ED-112 (Minimum Operational Performance Specification for Crash Protected Airborne Recorder Systems) dated March 2003, including amendments No 1 and No 2, or any later equivalent standard produced by EUROCAE.
- (b) The FDR should, with reference to a timescale, record:
 - (1) the parameters listed in Table 1 below;
 - (2) the additional parameters listed in Table 2 below, when the information data source for the parameter is used by helicopter systems or is available on the instrument panel for use by the flight crew to operate the helicopter; and
 - (3) any dedicated parameters related to novel or unique design or operational characteristics of the helicopter as determined by the Agency.

- (c) The FDR parameters should meet, as far as practicable, the performance specifications (range, sampling intervals, accuracy limits and minimum resolution in read-out) defined in the operational performance requirements and specifications of EUROCAE Document 112, including amendments No 1 and No 2, or any later equivalent standard produced by EUROCAE.
- (d) FDR systems for which some recorded parameters do not meet the performance specifications of EUROCAE Document ED-112 may be acceptable to the Agency.

Table 1

FDR — all helicopters

No*	Parameter
1	Time or relative time count
2	Pressure altitude
3	Indicated airspeed or calibrated airspeed
4	Heading
5	Normal acceleration
6	Pitch attitude
7	Roll attitude
8	Manual radio transmission keying CVR/FDR synchronisation reference
9	Power on each engine
9a	Free power turbine speed (N_F)
9b	Engine torque
9c	Engine gas generator speed (N_G)
9d	Flight crew compartment power control position
9e	Other parameters to enable engine power to be determined
10	Rotor:
10a	Main rotor speed
10b	Rotor brake (if installed)
11	Primary flight controls — Pilot input and/or control output position (if applicable)
11a	Collective pitch
11b	Longitudinal cyclic pitch
11c	Lateral cyclic pitch
11d	Tail rotor pedal
11e	Controllable stabiliser (if applicable)
11f	Hydraulic selection
12	Hydraulics low pressure (each system should be recorded)
13	Outside air temperature
18	Yaw rate or yaw acceleration
20	Longitudinal acceleration (body axis)
21	Lateral acceleration
25	Marker beacon passage
26	Warnings — a discrete should be recorded for the master warning, gearbox low oil pressure and stability augmentation system failure. Other 'red' warnings should be recorded where the warning condition cannot be determined from other parameters or from the cockpit voice recorder.
27	Each navigation receiver frequency selection
37	Engine control modes

* The number in the left hand column reflects the serial numbers depicted in EUROCAE Document ED-112

Table 2

Helicopters for which the data source for the parameter is either used by helicopter systems or is available on the instrument panel for use by the flight crew to operate the helicopter

No*	Parameter
14	AFCS mode and engagement status
15	Stability augmentation system engagement (each system should be recorded)
16	Main gear box oil pressure
17	Gear box oil temperature
17a	Main gear box oil temperature
17b	Intermediate gear box oil temperature
17c	Tail rotor gear box oil temperature
19	Indicated sling load force (if signals readily available)
22	Radio altitude
23	Vertical deviation — the approach aid in use should be recorded.
23a	ILS glide path
23b	MLS elevation
23c	GNSS approach path
24	Horizontal deviation — the approach aid in use should be recorded.
24a	ILS localiser
24b	MLS azimuth
24c	GNSS approach path
28	DME 1 & 2 distances
29	Navigation data
29a	Drift angle
29b	Wind speed
29c	Wind direction
29d	Latitude
29e	Longitude
29f	Ground speed
30	Landing gear or gear selector position
31	Engine exhaust gas temperature (T ₄)
32	Turbine inlet temperature (TIT/ITT)
33	Fuel contents
34	Altitude rate (vertical speed) — only necessary when available from cockpit instruments
35	Ice detection
36	Helicopter health and usage monitor system (HUMS)
36a	Engine data
36b	Chip detector
36c	Track timing
36d	Exceedance discretes
36e	Broadband average engine vibration
38	Selected barometric setting — to be recorded for helicopters where the parameter is displayed electronically
38a	Pilot
38b	Co-pilot
39	Selected altitude (all pilot selectable modes of operation) — to be recorded for the helicopters where the parameter is displayed electronically
40	Selected speed (all pilot selectable modes of operation) — to be recorded for the helicopters where the parameter is displayed electronically

No*	Parameter
41	Selected Mach (all pilot selectable modes of operation) — to be recorded for the helicopters where the parameter is displayed electronically
42	Selected vertical speed (all pilot selectable modes of operation) — to be recorded for the helicopters where the parameter is displayed electronically
43	Selected heading (all pilot selectable modes of operation) — to be recorded for the helicopters where the parameter is displayed electronically
44	Selected flight path (all pilot selectable modes of operation) — to be recorded for the helicopters where the parameter is displayed electronically
45	Selected decision height (all pilot selectable modes of operation) — to be recorded for the helicopters where the parameter is displayed electronically
46	EFIS display format
47	Multi-function/engine/alerts display format
48	Event marker

* The number in the left hand column reflects the serial numbers depicted in EUROCAE Document ED-112

AMC1.2 CAT.IDE.H.190 Flight data recorder

ED Decision 2016/012/R

OPERATIONAL PERFORMANCE REQUIREMENTS FOR HELICOPTERS HAVING AN MCTOM OF MORE THAN 3 175 KG AND FIRST ISSUED WITH AN INDIVIDUAL CoFA ON OR AFTER 1 JANUARY 2023

- (a) The operational performance requirements for FDRs should be those laid down in EUROCAE Document 112A (Minimum Operational Performance Specification for Crash Protected Airborne Recorder Systems) dated September 2013, or any later equivalent standard produced by EUROCAE.
- (b) The FDR should, with reference to a timescale, record:
 - (1) the list of parameters in Table 1 below;
 - (2) the additional parameters listed in Table 2 below, when the information data source for the parameter is used by helicopter systems or is available on the instrument panel for use by the flight crew to operate the helicopter; and
 - (3) any dedicated parameters related to novel or unique design or operational characteristics of the helicopter as determined by the Agency.
- (c) The parameters to be recorded should meet the performance specifications (range, sampling intervals, accuracy limits and resolution in read-out) as defined in the relevant tables of EUROCAE Document 112A, or any later equivalent standard produced by EUROCAE.

Table 1: FDR — All helicopters

No*	Parameter
1	Time or relative time count
2	Pressure altitude
3	Indicated airspeed or calibrated airspeed
4	Heading
5	Normal acceleration
6	Pitch attitude
7	Roll attitude
8	Manual radio transmission keying CVR/FDR synchronisation reference

No*	Parameter
9	Power on each engine:
9a	Free power turbine speed (N _F)
9b	Engine torque
9c	Engine gas generator speed (N _G)
9d	Flight crew compartment power control position
9e	Other parameters to enable engine power to be determined
10	Rotor:
10a	Main rotor speed
10b	Rotor brake (if installed)
11	Primary flight controls — pilot input or control output position if it is possible to derive either the control input or the control movement (one from the other) for all modes of operation and flight regimes. Otherwise, pilot input and control output position:
11a	Collective pitch
11b	Longitudinal cyclic pitch
11c	Lateral cyclic pitch
11d	Tail rotor pedal
11e	Controllable stabilator (if applicable)
11f	Hydraulic selection
12	Hydraulics low pressure (each system should be recorded)
13	Outside air temperature
18	Yaw rate or yaw acceleration
20	Longitudinal acceleration (body axis)
21	Lateral acceleration
25	Marker beacon passage
26	Warnings — including master warning, gearbox low oil pressure and stability augmentation system failure, and other ‘red’ warnings where the warning condition cannot be determined from other parameters or from the cockpit voice recorder
27	Each navigation receiver frequency selection
37	Engine control modes

* The number in the left-hand column reflects the serial numbers depicted in EUROCAE Document 112A.

Table 2: FDR - Helicopters for which the data source for the parameter is either used by the helicopter systems or is available on the instrument panel for use by the flight crew to operate the helicopter

No*	Parameter
14	AFCS mode and engagement status (showing which systems are engaged and which primary modes are controlling the flight path)
15	Stability augmentation system engagement (each system should be recorded)
16	Main gear box oil pressure
17	Gear box oil temperature:
17a	Main gear box oil temperature
17b	Intermediate gear box oil temperature
17c	Tail rotor gear box oil temperature
19	Indicated sling load force (if signals are readily available)
22	Radio altitude
23	Vertical deviation — the approach aid in use should be recorded:
23a	ILS glide path
23b	MLS elevation
23c	GNSS approach path

No*	Parameter
24	Horizontal deviation — the approach aid in use should be recorded:
24a	ILS localiser
24b	MLS azimuth
24c	GNSS approach path
28	DME 1 & 2 distances
29	Navigation data:
29a	Drift angle
29b	Wind speed
29c	Wind direction
29d	Latitude
29e	Longitude
29f	Ground speed
30	Landing gear or gear selector position
31	Engine exhaust gas temperature (T_4)
32	Turbine inlet temperature (TIT)/interstage turbine temperature ITT)
33	Fuel contents
34	Altitude rate (vertical speed) — only necessary when available from cockpit instruments
35	Ice detection
36	Helicopter health and usage monitor system (HUMS):
36a	Engine data
36b	Chip detector
36c	Track timing
36d	Exceedance discretes
36e	Broadband average engine vibration
38	Selected barometric setting — to be recorded for helicopters where the parameter is displayed electronically:
38a	Pilot
38b	Co-pilot
39	Selected altitude (all pilot selectable modes of operation) — to be recorded for the helicopters where the parameter is displayed electronically
40	Selected speed (all pilot selectable modes of operation) — to be recorded for the helicopters where the parameter is displayed electronically
41	Selected Mach (all pilot selectable modes of operation) — to be recorded for the helicopters where the parameter is displayed electronically
42	Selected vertical speed (all pilot selectable modes of operation) — to be recorded for the helicopters where the parameter is displayed electronically
43	Selected heading (all pilot selectable modes of operation) — to be recorded for the helicopters where the parameter is displayed electronically
44	Selected flight path (all pilot selectable modes of operation) — to be recorded for the helicopters where the parameter is displayed electronically
45	Selected decision height (all pilot selectable modes of operation) — to be recorded for the helicopters where the parameter is displayed electronically
46	EFIS display format (showing the display system status):
46a	Pilot
46b	First officer
47	Multi-function/engine/alerts display format (showing the display system status)
48	Event marker

No*	Parameter
49	Status of ground proximity warning system (GPWS)/terrain awareness warning system (TAWS)/ground collision avoidance system (GCAS):
49a	Selection of terrain display mode including pop-up display status — for helicopters type certified before 1 January 2023, to be recorded only if this does not require extensive modification
49b	Terrain alerts, both cautions and warnings, and advisories — for helicopters type certified before 1 January 2023, to be recorded only if this does not require extensive modification
49c	On/off switch position – for helicopters type certified before 1 January 2023, to be recorded only if this does not require extensive modification
50	Traffic alert and collision avoidance system (TCAS)/airborne collision avoidance system (ACAS):
50a	Combined control — for helicopters type certified before 1 January 2023, to be recorded only if this does not require extensive modification
50b	Vertical control — for helicopters type certified before 1 January 2023, to be recorded only if this does not require extensive modification
50c	Up advisory — for helicopters type certified before 1 January 2023, to be recorded only if this does not require extensive modification
50d	Down advisory — for helicopters type certified before 1 January 2023, to be recorded only if this does not require extensive modification
50e	Sensitivity level — for helicopters type certified before 1 January 2023, to be recorded only if this does not require extensive modification
51	Primary flight controls — pilot input forces:
51a	Collective pitch — for helicopters type certified before 1 January 2023, to be recorded only if this does not require extensive modification
51b	Longitudinal cyclic pitch — for helicopters type certified before 1 January 2023, to be recorded only if this does not require extensive modification
51c	Lateral cyclic pitch — for helicopters type certified before 1 January 2023, to be recorded only if this does not require extensive modification
51d	Tail rotor pedal — for helicopters type certified before 1 January 2023, to be recorded only if this does not require extensive modification
52	Computed centre of gravity — for helicopters type certified before 1 January 2023, to be recorded only if this does not require extensive modification
53	Helicopter computed weight — for helicopters type certified before 1 January 2023, to be recorded only if this does not require extensive modification

* The number in the left-hand column reflects the serial numbers depicted in EUROCAE Document 112A.

AMC2 CAT.IDE.H.190 Flight data recorder

ED Decision 2019/019/R

LIST OF PARAMETERS TO BE RECORDED FOR HELICOPTERS HAVING AN MCTOM OF MORE THAN 3 175 KG AND FIRST ISSUED WITH AN INDIVIDUAL COFA ON OR AFTER 1 AUGUST 1999 AND BEFORE 1 JANUARY 2016 AND HELICOPTERS HAVING AN MCTOM OF MORE THAN 7 000 KG OR AN MOPSC OF MORE THAN 9 AND FIRST ISSUED WITH AN INDIVIDUAL COFA ON OR AFTER 1 JANUARY 1989 AND BEFORE 1 AUGUST 1999

- (a) The FDR should, with reference to a timescale, record:
- (1) for helicopters with an MCTOM between 3 175 kg and 7 000 kg the parameters listed in Table 1 below;
 - (2) for helicopters with an MCTOM of more than 7 000 kg the parameters listed in Table 2 below;
 - (3) for helicopters equipped with electronic display systems, the additional parameters listed in Table 3 below; and

- (4) any dedicated parameters relating to novel or unique design or operational characteristics of the helicopter.
- (b) The FDR of helicopters with an MCTOM of more than 7 000 kg does not need to record parameter 19 of Table 2 below, if any of the following conditions are met:
- (1) the sensor is not readily available; or
 - (2) a change is required in the equipment that generates the data.
- (c) Individual parameters that can be derived by calculation from the other recorded parameters need not to be recorded, if agreed by the competent authority.
- (d) The parameters should meet, as far as practicable, the performance specifications (range, sampling intervals, accuracy limits and resolution in read-out) defined in [AMC3 CAT.IDE.H.190](#).
- (e) If recording capacity is available, as many of the additional parameters as possible specified in table II-A.2 of EUROCAE Document ED 112 dated March 2003 should be recorded.
- (f) For the purpose of this AMC, a sensor is considered ‘readily available’ when it is already available or can be easily incorporated.

Table 1

Helicopters with an MCTOM of 7 000 kg or less

No	Parameter
1	Time or relative time count
2	Pressure altitude
3	Indicated airspeed or calibrated airspeed
4	Heading
5	Normal acceleration
6	Pitch attitude
7	Roll attitude
8	Manual radio transmission keying
9	Power on each engine (free power turbine speed and engine torque)/cockpit power control position (if applicable)
10a	Main rotor speed
10b	Rotor brake (if installed)
11	Primary flight controls — pilot input and control output position (if applicable)
11a	Collective pitch
11b	Longitudinal cyclic pitch
11c	Lateral cyclic pitch
11d	Tail rotor pedal
11e	Controllable stabiliser
11f	Hydraulic selection
13	Outside air temperature
14	Autopilot engagement status
15	Stability augmentation system engagement
26	Warnings

Table 2

Helicopters with an MCTOM of more than 7 000 kg

No	Parameter
1	Time or relative time count
2	Pressure altitude
3	Indicated airspeed or calibrated airspeed
4	Heading
5	Normal acceleration
6	Pitch attitude
7	Roll attitude
8	Manual radio transmission keying
9	Power on each engine (free power turbine speed and engine torque)/cockpit power control position (if applicable)
10a	Main rotor speed
10b	Rotor brake (if installed)
11	Primary flight controls — pilot input and control output position (if applicable)
11a	Collective pitch
11b	Longitudinal cyclic pitch
11c	Lateral cyclic pitch
11d	Tail rotor pedal
11e	Controllable stabiliser
11f	Hydraulic selection
12	Hydraulics low pressure
13	Outside air temperature
14	AFCS mode and engagement status
15	Stability augmentation system engagement
16	Main gear box oil pressure
17	Main gear box oil temperature
18	Yaw rate or yaw acceleration
19	Indicated sling load force (if installed)
20	Longitudinal acceleration (body axis)
21	Lateral acceleration
22	Radio altitude
23	Vertical beam deviation (ILS glide path or MLS elevation)
24	Horizontal beam deviation (ILS localiser or MLS azimuth)
25	Marker beacon passage
26	Warnings
27	Reserved (navigation receiver frequency selection is recommended)
28	Reserved (DME distance is recommended)
29	Reserved (navigation data are recommended)
30	Landing gear or gear selector position

Table 3

Helicopters equipped with electronic display systems

No	Parameter
38	Selected barometric setting (each pilot station)
39	Selected altitude
40	Selected speed
41	Selected Mach
42	Selected vertical speed
43	Selected heading
44	Selected flight path
45	Selected decision height
46	EFIS display format
47	Multi-function/engine/alerts display format

AMC3 CAT.IDE.H.190 Flight data recorder

ED Decision 2014/015/R

PERFORMANCE SPECIFICATIONS FOR THE PARAMETERS TO BE RECORDED FOR HELICOPTERS HAVING AN MCTOM OF MORE THAN 3 175 KG AND FIRST ISSUED WITH AN INDIVIDUAL COFA ON OR AFTER 1 AUGUST 1999 AND BEFORE 1 JANUARY 2016 AND HELICOPTERS HAVING AN MCTOM OF MORE THAN 7 000 KG OR AN MOPSC OF MORE THAN 9 AND FIRST ISSUED WITH AN INDIVIDUAL COFA ON OR AFTER 1 JANUARY 1989 AND BEFORE 1 AUGUST 1999

Table 1

Helicopters with an MCTOM of 7 000 kg or less

No	Parameter	Range	Sampling interval in seconds	Accuracy Limits (sensor input compared to FDR read out)	Minimum Resolution in read out	Remarks
1	Time or relative time count					
1a or	Time	24 hours	4	± 0.125 % per hour	1 second	(a) UTC time preferred where available.
1b	Relative Time Count	0 to 4 095	4	± 0.125 % per hour		(b) Counter increments every 4 seconds of system operation.
2	Pressure altitude	-1 000 ft to 20 000 ft	1	±100 ft to ±700 ft Refer to table II.A-2 of EUROCAE Document ED-112	25 ft	
3	Indicated airspeed or calibrated airspeed	As the installed measuring system	1	± 5 % or ± 10 kt, whichever is greater	1 kt	
4	Heading	360 °	1	± 5°	1°	
5	Normal acceleration	- 3 g to + 6 g	0.125	± 0.2 g in addition to a maximum offset of ± 0.3 g	0.01 g	The resolution may be rounded from 0.01 g to 0.05 g, provided that one sample is recorded at full resolution at least every 4 seconds.
6	Pitch attitude	100 % of usable range	0.5	± 2 degrees	0.8 degree	
7	Roll attitude	± 60 ° or 100 % of usable range from installed system if greater	0.5	± 2 degrees	0.8 degree	.

No	Parameter	Range	Sampling interval in seconds	Accuracy Limits (sensor input compared to FDR read out)	Minimum Resolution in read out	Remarks
8	Manual radio transmission keying	Discrete(s)	1	-	-	Preferably each crew member but one discrete acceptable for all transmissions.
9	Power on each engine	Full range	Each engine each second	± 5 %	1 % of full range	Sufficient parameters, e.g. Power Turbine Speed and Engine Torque should be recorded to enable engine power to be determined. A margin for possible overspeed should be provided. Data may be obtained from cockpit indicators used for aircraft certification. Parameter 9c is required for helicopters with non-mechanically linked cockpit-engine controls
9a	Power turbine speed	Maximum range				
9b	Engine torque	Maximum range				
9c	Cockpit power control position	Full range or each discrete position	Each control each second	± 2 % or sufficient to determine any gated position	2 % of full range	
10	Rotor					
10a	Main rotor speed	Maximum range	1	± 5 %	1 % of full range	
10b	Rotor brake	Discrete	1	-		Where available
11	Primary flight controls - Pilot input and/or* control output position					* For helicopters that can demonstrate the capability of deriving either the control input or control movement (one from the other) for all modes of operation and flight regimes, the 'or' applies. For helicopters with non-mechanical control systems the 'and' applies. Where the input controls for each pilot can be operated independently, both inputs will need to be recorded.
11a	Collective pitch	Full range	0.5	± 3 %	1 % of full range	
11b	Longitudinal cyclic pitch		0.5			
11c	Lateral cyclic pitch		0.5			
11d	Tail rotor pedal		0.5			
11e	Controllable stabiliser		0.5			
11f	Hydraulic selection	Discretes	1	-	-	
12	Outside air temperature	Available range from installed system	2	± 2 °C	0.3°C	
13	Autopilot engagement status	Discrete(s)	1			Where practicable, discretes should show which primary modes are controlling the flight path of the helicopter

No	Parameter	Range	Sampling interval in seconds	Accuracy Limits (sensor input compared to FDR read out)	Minimum Resolution in read out	Remarks
14	Stability augmentation system engagement	Discrete(s)	1			
15	Warnings	Discrete(s)	1	-	-	A discrete should be recorded for the master warning, low hydraulic pressure (each system) gearbox low oil pressure and SAS fault status. Other 'red' warnings should be recorded where the warning condition cannot be determined from other parameters or from the cockpit voice recorder.

Table 2

Helicopters with an MCTOM of more than 7 000 kg

N°	Parameter	Range	Sampling interval in seconds	Accuracy Limits (sensor input compared to FDR read out)	Minimum Resolution in read out	Remarks
1	Time or relative time count					
1a or	Time	24 hours	4	± 0.125 % per hour	1 second	(a) UTC time preferred where available.
1b	Relative time count	0 to 4095	4	± 0.125 % per hour		(b) Counter increments every 4 seconds of system operation.
2	Pressure altitude	-1 000 ft to maximum certificated altitude of aircraft +5 000 ft	1	± 100 ft to ± 700 ft Refer to table II-A.3 EUROCAE Document ED-112	5 ft	Should be obtained from the air data computer when installed.
3	Indicated airspeed or calibrated airspeed	As the installed measuring system	1	± 3 %	1 kt	Should be obtained from the air data computer when installed.
4	Heading	360 degrees	1	± 2 degrees	0.5 degree	
5	Normal acceleration	-3 g to +6 g	0.125	1 % of range excluding a datum error of 5 %	0.004 g	The recording resolution may be rounded from 0.004 g to 0.01 g provided that one

N°	Parameter	Range	Sampling interval in seconds	Accuracy Limits (sensor input compared to FDR read out)	Minimum Resolution in read out	Remarks
						sample is recorded at full resolution at least every 4 seconds.
6	Pitch attitude	± 75 degrees	0.5	± 2 degrees	0.5 degree	
7	Roll attitude	± 180 degrees	0.5	± 2 degrees	0.5 degree	.
8	Manual radio transmission Keying and CVR/FDR synchronisation reference	Discrete(s)	1	-	-	Preferably each crew member but one discrete acceptable for all transmissions provided that the replay of a recording made by any required recorder can be synchronised in time with any other required recording to within 1 second.
9	Power on each engine	Full range	Each engine each second	± 2 %	0.2 % of full range	Sufficient parameters e.g. Power Turbine Speed and engine torque should be recorded to enable engine power to be determined. A margin for possible overspeed should be provided.
9a	Free power turbine speed (NF)	0-130 %				
9b	Engine torque	Full range				
9c	Cockpit power control position	Full range or each discrete position	Each control each second	± 2 % or sufficient to determine any gated position	2 % of full range	Parameter 9c is required for helicopters with non-mechanically linked cockpit-engine controls
10	Rotor					
10a	Main rotor speed	50 to 130 %	0.5	2 %	0.3 % of full range	.
10b	Rotor brake	Discrete	1			Where available
11	Primary flight controls - Pilot input and/or* control output position					* For helicopters that can demonstrate the capability of deriving either the control input or control movement (one from the other) for all modes of operation and flight regimes, the 'or' applies. For helicopters with non-mechanical control systems, the 'and' applies.
11a	Collective pitch	Full range	0.5	± 3 % unless higher accuracy is uniquely required	0.5 % of operating range	
11b	Longitudinal cyclic pitch		0.5			
11c	Lateral cyclic pitch		0.5			
11d	Tail rotor pedal		0.5			

N°	Parameter	Range	Sampling interval in seconds	Accuracy Limits (sensor input compared to FDR read out)	Minimum Resolution in read out	Remarks
11e	Controllable stabiliser		0.5			Where the input controls for each pilot can be operated independently, both inputs will need to be recorded.
11f	Hydraulic selection	Discrete(s)	1	-	-	
12	Hydraulics low pressure	Discrete(s)	1	-	-	Each essential system should be recorded.
13	Outside air temperature	-50° to +90°C or available sensor range	2	± 2°C	0.3°C	
14	AFCS mode and engagement status	A suitable combination of discretes	1	-	-	Discretes should show which systems are engaged and which primary modes are controlling the flight path of the helicopter.
15	Stability augmentation system engagement	Discrete	1	-	-	
16	Main gearbox oil pressure	As installed	1	As installed	6.895 kN/m ² (1 psi)	
17	Main gearbox oil temperature	As installed	2	As installed	1°C	
18	Yaw rate	± 400 degrees/second	0.25	± 1 %	2 degrees per second	An equivalent yaw acceleration is an acceptable alternative.
19	Indicated sling load force	0 to 200 % of maximum certified load	0.5	± 3 % of maximum certified load	0.5 % for maximum certified load	With reasonable practicability if sling load indicator is installed.
20	Longitudinal acceleration (body axis)	± 1 g	0.25	±1.5 % of range excluding a datum error of ±5 %	0.004 g	See comment to parameter 5.
21	Lateral acceleration	± 1 g	0.25	±1.5 % of range excluding a datum error of ±5 %	0.004 g	See comment to parameter 5.
22	Radio altitude	-20 ft to +2 500 ft	1	As installed. ± 2 ft or ± 3 % whichever is greater below 500 ft and ± 5 % above 500 ft recommended	1 ft below 500 ft, 1 ft + 0.5 % of full range above 500 ft	

N°	Parameter	Range	Sampling interval in seconds	Accuracy Limits (sensor input compared to FDR read out)	Minimum Resolution in read out	Remarks
23	Vertical beam deviation		1	As installed ± 3 % recommended	0.3 % of full range	Data from both the ILS and MLS systems need not to be recorded at the same time. The approach aid in use should be recorded.
23a	ILS glide path	± 0.22 DDM or available sensor range as installed				
23b	MLS elevation	+0.9 to +30 degrees				
24	Horizontal beam deviation		1	As installed. ± 3 % recommended	0.3 % of full range	See comment to parameter 23
24a	ILS localiser	± 0.22 DDM or available sensor range as installed				
24b	MLS azimuth	± 62 degrees				
25	Marker beacon passage	Discrete	1	-	-	One discrete is acceptable for all markers.
26	Warnings	Discretes	1	-	-	A discrete should be recorded for the master warning, gearbox low oil pressure and SAS failure. Other 'red' warnings should be recorded where the warning condition cannot be determined from other parameters or from the cockpit voice recorder.
27	Reserved					
28	Reserved					
29	Reserved					
30	Landing gear or gear selector position	Discrete(s)	4	-	-	Where installed.

Table 3

Helicopters equipped with electronic display systems

N°	Parameter	Range	Sampling interval in seconds	Accuracy Limits (sensor input compared to FDR read out)	Minimum Resolution in read out	Remarks
38	Selected barometric setting (each pilot station)	As installed	64	As installed	1 mb	Where practicable, a sampling interval of 4 seconds is recommended.
38a	Pilot					
38b	Co-pilot					
39	Selected altitude	As installed	1	As installed	100 ft	Where capacity is limited, a sampling interval of 64 seconds is permissible.
39a	Manual					
39b	Automatic					
40	Selected speed	As installed	1	As installed	1 kt	Where capacity is limited, a sampling interval of 64 seconds is permissible.
40a	Manual					
40b	Automatic					
41	Selected Mach	As installed	1	As installed	0.01	Where capacity is limited, a sampling interval of 64 seconds is permissible.
41a	Manual					
41b	Automatic					
42	Selected vertical speed	As installed	1	As installed	100 ft/min	Where capacity is limited, a sampling interval of 64 seconds is permissible.
42a	Manual					
42b	Automatic					
43	Selected heading	360 degrees	1	As installed	100 ft /min	Where capacity is limited, a sampling interval of 64 seconds is permissible.
44	Selected flight path		1	As installed		
44a	Course/DSTRK				1 degree	
44b	Path angle				0.1 degree	

N°	Parameter	Range	Sampling interval in seconds	Accuracy Limits (sensor input compared to FDR read out)	Minimum Resolution in read out	Remarks
45	Selected decision height	0-500 ft	64	As installed	1ft	
46	EFIS display format	Discrete(s)	4	-	-	Discretes should show the display system status e.g. normal, fail, composite, sector, plan, rose, nav aids, wxr, range, copy
46a	Pilot					
46b	Co-pilot					
47	Multi-function/engine/alerts display format	Discrete(s)	4	-	-	Discretes should show the display system status, e.g. normal, fail, and the identity of the display pages for the emergency procedures and checklists. Information in checklists and procedures need not be recorded.

The term ‘where practicable’ used in the remarks column of Table 3 means that account should be taken of the following:

- (a) if the sensor is already available or can be easily incorporated;
- (b) sufficient capacity is available in the flight recorder system;
- (c) for navigational data (nav frequency selection, DME distance, latitude, longitude, groundspeed and drift) the signals are available in digital form;
- (d) the extent of modification required;
- (e) the down-time period; and
- (f) equipment software development.

GM1 CAT.IDE.H.190 Flight data recorder

ED Decision 2014/015/R

GENERAL

For the purpose of [AMC2 CAT.IDE.H.190\(b\)](#), a sensor is considered 'readily available' when it is already available or can be easily incorporated.

CAT.IDE.H.191 Lightweight flight recorder

Regulation (EU) 2019/1387

- (a) Turbine-engined helicopters with an MCTOM of 2 250 kg or more shall be equipped with a flight recorder if all of the following conditions are met:
 - (1) they are not within the scope of point [CAT.IDE.H.190\(a\)](#);
 - (2) they are first issued with an individual CofA on or after 5 September 2022.
- (b) The flight recorder shall record, by means of flight data or images, information that is sufficient to determine the flight path and aircraft speed.
- (c) The flight recorder shall be capable of retaining the flight data and the images recorded during at least the preceding 5 hours.
- (d) The flight recorder shall automatically start to record prior to the helicopter being capable of moving under its own power and shall stop automatically after the helicopter is no longer capable of moving under its own power.
- (e) If the flight recorder records images or audio of the flight crew compartment, then a function shall be provided which can be operated by the commander and which modifies image and audio recordings made before the operation of that function, so that those recordings cannot be retrieved using normal replay or copying techniques.

AMC1 CAT.IDE.H.191 Lightweight flight recorder

ED Decision 2021/005/R

OPERATIONAL PERFORMANCE REQUIREMENTS

- (a) If the flight recorder records flight data, it should record at least the following parameters:
 - (1) relative time count,
 - (2) pitch attitude or pitch rate,
 - (3) roll attitude or roll rate,
 - (4) heading (magnetic or true) or yaw rate,
 - (5) latitude,
 - (6) longitude,
 - (7) positioning system: estimated error (if available),
 - (8) pressure altitude or altitude from a positioning system,
 - (9) time,
 - (10) ground speed,

- (11) positioning system: track (if available),
 - (12) normal acceleration,
 - (13) longitudinal acceleration, and
 - (14) lateral acceleration.
- (b) If the flight recorder records images, it should capture views of the main instrument displays at the pilot station, or at both pilot stations when the helicopter is certified for operation with a minimum crew of two pilots. The recorded image quality should allow reading the following indications during most of the flight:
- (1) magnetic or true heading,
 - (2) time (if presented on the front instrument panel),
 - (3) pressure altitude,
 - (4) indicated airspeed,
 - (5) vertical speed,
 - (6) slip,
 - (7) OAT,
 - (8) attitude (if displayed),
 - (9) stabilised heading (if displayed), and
 - (10) main rotor speed.
- (c) If the flight recorder records a combination of images and flight data, each flight parameter listed in (a) should be recorded as flight data or by means of images.
- (d) The flight parameters listed in (a), which are recorded as flight data, should meet the performance specifications (range, sampling intervals, accuracy limits and resolution in read-out) as defined in the relevant table of EUROCAE Document ED-112 'Minimum Operational Performance Specification for Crash Protected Airborne Recorder Systems', dated March 2003, or EUROCAE Document ED-155 'Minimum Operational Performance Specification for Lightweight Flight Recording Systems', dated July 2009, or any later equivalent standard accepted by EASA.
- (e) The operational performance requirements for the flight recorder should be those laid down in:
- (1) EUROCAE Document ED-155 or any later equivalent standard accepted by EASA for lightweight flight recorders; or
 - (2) EUROCAE Document ED-112 or any later equivalent standard accepted by EASA for crash-protected flight recorders.

GM1 CAT.IDE.H.191 Lightweight flight recorder

ED Decision 2021/005/R

ADDITIONAL USEFUL INFORMATION

Refer to [GM1 CAT.IDE.A.191](#).

GM2 CAT.IDE.H.191 Lightweight flight recorder

ED Decision 2021/005/R

INSTALLATION OF CAMERAS

Refer to [GM2 CAT.IDE.A.191](#).

GM3 CAT.IDE.H.191 Lightweight flight recorder

ED Decision 2021/005/R

RECORDING ACCURACY OF ATTITUDE RATE PARAMETERS

Refer to [GM3 CAT.IDE.A.191](#).

GM1 CAT.IDE.H.191(e) Lightweight flight recorder

ED Decision 2021/005/R

FUNCTION TO MODIFY IMAGE AND AUDIO RECORDINGS

Refer to [GM1 CAT.IDE.A.191\(e\)](#).

CAT.IDE.H.195 Data link recording

Regulation (EU) 2015/2338

- (a) Helicopters first issued with an individual CofA on or after 8 April 2014 that have the capability to operate data link communications and are required to be equipped with a CVR, shall record on a recorder, where applicable:
- (1) data link communication messages related to ATS communications to and from the helicopter, including messages applying to the following applications:
 - (i) data link initiation;
 - (ii) controller-pilot communication;
 - (iii) addressed surveillance;
 - (iv) flight information;
 - (v) as far as is practicable, given the architecture of the system, aircraft broadcast surveillance;
 - (vi) as far as is practicable, given the architecture of the system, aircraft operational control data;
 - (vii) as far as is practicable, given the architecture of the system, graphics;
 - (2) information that enables correlation to any associated records related to data link communications and stored separately from the helicopter; and
 - (3) information on the time and priority of data link communications messages, taking into account the system's architecture.
- (b) The recorder shall use a digital method of recording and storing data and information and a method of readily retrieving that data shall be available. The recording method shall allow the data to match the data recorded on the ground.
- (c) The recorder shall be capable of retaining data recorded for at least the same duration as set out for CVRs in [CAT.IDE.H.185](#).

- (d) If the recorder is not deployable, it shall have a device to assist in locating it under water. By 1 January 2020 at the latest, this device shall have a minimum underwater transmission time of 90 days. If the recorder is deployable, it shall have an automatic emergency locator transmitter.
- (e) The requirements applicable to the start and stop logic of the recorder are the same as the requirements applicable to the start and stop logic of the CVR contained in [CAT.IDE.H.185\(d\)](#) and (e).

AMC1 CAT.IDE.H.195 Data link recording

ED Decision 2014/015/R

GENERAL

- (a) The helicopter should be capable of recording the messages as specified in this AMC.
- (b) As a means of compliance with [CAT.IDE.H.195\(a\)](#), the recorder on which the data link messages are recorded may be:
 - (1) the CVR;
 - (2) the FDR;
 - (3) a combination recorder when [CAT.IDE.H.200](#) is applicable; or
 - (4) a dedicated flight recorder. In that case, the operational performance requirements for this recorder should be those laid down in EUROCAE Document ED-112 (Minimum Operational Performance Specification for Crash Protected Airborne Recorder Systems) dated March 2003, including amendments No 1 and No 2, or any later equivalent standard produced by EUROCAE.
- (c) As a means of compliance with [CAT.IDE.H.195\(a\)\(2\)](#), the operator should enable correlation by providing information that allows an accident investigator to understand what data were provided to the helicopter and, when the provider identification is contained in the message, by which provider.
- (d) The timing information associated with the data link communications messages required to be recorded by [CAT.IDE.H.195\(a\)\(3\)](#) should be capable of being determined from the airborne-based recordings. This timing information should include at least the following:
 - (1) the time each message was generated;
 - (2) the time any message was available to be displayed by the crew;
 - (3) the time each message was actually displayed or recalled from a queue; and
 - (4) the time of each status change.
- (e) The message priority should be recorded when it is defined by the protocol of the data link communication message being recorded.
- (f) The expression 'taking into account the system architecture', in [CAT.IDE.H.195\(a\)\(3\)](#) means that the recording of the specified information may be omitted if the existing source systems involved would require a major upgrade. The following should be considered:
 - (1) the extent of the modification required;
 - (2) the down-time period; and
 - (3) equipment software development.

- (g) The intention is that new designs of source systems should include this functionality and support the full recording of the required information.
- (h) Data link communications messages that support the applications in Table 1 below should be recorded.
- (i) Further details on the recording requirements can be found in the recording requirement matrix in Appendix D.2 of EUROCAE Document ED-93 (Minimum Aviation System Performance Specification for CNS/ATM Recorder Systems, dated November 1998).

Table 1

Applications

Item No	Application Type	Application Description	Required Recording Content
1	Data link initiation	This includes any application used to log on to, or initiate, a data link service. In future air navigation system (FANS)-1/A and air traffic navigation (ATN), these are ATS facilities notification (AFN) and context management (CM), respectively.	C
2	Controller/pilot communication	This includes any application used to exchange requests, clearances, instructions and reports between the flight crew and air traffic controllers. In FANS-1/A and ATN, this includes the controller pilot data link communications (CPDLC) application. CPDLC includes the exchange of oceanic clearances (OCLs) and departure clearances (DCLs).	C
3	Addressed surveillance	This includes any surveillance application in which the ground sets up contracts for delivery of surveillance data. In FANS-1/A and ATN, this includes the automatic dependent surveillance-contract (ADS-C) application.	C, F2
4	Flight information	This includes any application used for delivery of flight information data to specific aeroplanes. This includes for example, data link-automatic terminal information service (D-ATIS), data link-operational terminal information service (D-OTIS), digital weather information services (D-METAR or TWIP), data link flight information service (D-FIS) and Notice to Airmen (D-NOTAM) delivery.	C
5	Aircraft broadcast surveillance	This includes elementary and enhanced surveillance systems, as well as automatic dependent surveillance-broadcast (ADS-B) output data.	M*, F2
6	Airlines operations centre (AOC) data	This includes any application transmitting or receiving data used for AOC purposes (in accordance with the ICAO definition of AOC). Such systems may also process AAC messages, but there is no requirement to record AAC messages	M*
7	Graphics	This includes any application receiving graphical data to be used for operational purposes (i.e. excluding applications that are receiving such things as updates to manuals).	M* F1

GM1 CAT.IDE.H.195 Data link recording

ED Decision 2014/015/R

DEFINITIONS AND ACRONYMS

- (a) The letters and expressions in Table 1 of [AMC1 CAT.IDE.H.195](#) have the following meaning:

- C: Complete contents recorded
 - M: Information that enables correlation with any associated records stored separately from the helicopter.
 - *: Applications that are to be recorded only as far as is practicable, given the architecture of the system.
 - F1: Graphics applications may be considered as AOC data when they are part of a data link communications application service run on an individual basis by the operator itself in the framework of the operational control.
 - F2: Where parametric data sent by the helicopter, such as Mode S, is reported within the message, it should be recorded unless data from the same source is recorded on the FDR.
- (b) The definitions of the applications type in Table 1 of [AMC1 CAT.IDE.H.195](#) are described in Table 1 below.

Table 1

Descriptions of the applications type

Item No	Application Type	Messages	Comments
1	CM		CM is an ATN service
2	AFN		AFN is a FANS 1/A service
3	CPDLC		All implemented up and downlink messages to be recorded
4	ADS-C	ADS-C reports	All contract requests and reports recorded
		Position reports	Only used within FANS 1/A. Only used in oceanic and remote areas.
5	ADS-B	Surveillance data	Information that enables correlation with any associated records stored separately from the helicopter.
6	D-FIS		D-FIS is an ATN service. All implemented up and downlink messages to be recorded
7	TWIP	TWIP messages	Terminal weather information for pilots
8	D-ATIS	ATIS messages	Refer to EUROCAE Document ED-89A dated December 2003. Data Link Application System Document (DLASD) for the 'ATIS' Data Link Service
9	OCL	OCL messages	Refer to EUROCAE Document ED-106A dated March 2004. Data Link Application System Document (DLASD) for 'Oceanic Clearance' Data Link Service
10	DCL	DCL messages	Refer to EUROCAE Document ED-85A dated December 2003. Data Link Application System Document (DLASD) for 'Departure Clearance' Data Link Service
11	Graphics	Weather maps & other graphics	Graphics exchanged in the framework of procedures within the operational control, as specified in Part-ORO. Information that enables correlation with any associated records stored separately from the aeroplane.
12	AOC	Aeronautical operational control messages	Messages exchanged in the framework of procedures within the operational control, as specified in Part-ORO. Information that enables correlation with any associated records stored separately from the helicopter. Definition in EUROCAE Document ED-112, dated March 2003.

Item No	Application Type	Messages	Comments
13	Surveillance	Downlinked aircraft parameters (DAP)	As defined in ICAO Annex 10 Volume IV (Surveillance systems and ACAS).

AAC	aeronautical administrative communications
ADS-B	automatic dependent surveillance — broadcast
ADS-C	automatic dependent surveillance — contract
AFN	aircraft flight notification
AOC	aeronautical operational control
ATIS	automatic terminal information service
ATSC	air traffic service communication
CAP	controller access parameters
CPDLC	controller pilot data link communications
CM	configuration/context management
D-ATIS	data link ATIS
D-FIS	data link flight information service
DCL	departure clearance
FANS	Future Air Navigation System
FLIPCY	flight plan consistency
OCL	oceanic clearance
SAP	system access parameters
TWIP	terminal weather information for pilots

GM1 CAT.IDE.H.195(a) Data link recording

ED Decision 2014/015/R

APPLICABILITY OF THE DATA LINK RECORDING REQUIREMENT

- (a) If it is certain that the helicopter cannot use data link communication messages for ATS communications corresponding to any application designated by [CAT.IDE.H.195\(a\)\(1\)](#) then the data link recording requirement does not apply.
- (b) Examples where the helicopter cannot use data link communication messages for ATS communications include but are not limited to the cases where:
 - (1) the helicopter data link communication capability is disabled permanently and in a way that it cannot be enabled again during the flight;
 - (2) data link communications are not used to support air traffic service (ATS) in the area of operation of the helicopter; and
 - (3) the helicopter data link communication equipment cannot communicate with the equipment used by ATS in the area of operation of the helicopter.

CAT.IDE.H.200 Flight data and cockpit voice combination recorder

Regulation (EU) No 965/2012

Compliance with CVR and FDR requirements may be achieved by the carriage of one combination recorder.

AMC1 CAT.IDE.H.200 Flight data and cockpit voice combination recorder

ED Decision 2014/015/R

GENERAL

- (a) A flight data and cockpit voice combination recorder is a flight recorder that records:
- (1) all voice communications and the aural environment required by [CAT.IDE.H.185](#) regarding CVRs; and
 - (2) all parameters required by [CAT.IDE.H.190](#) regarding FDRs, with the same specifications required by those paragraphs.
- (b) In addition, a flight data and cockpit voice combination recorder may record data link communication messages and related information required by [CAT.IDE.H.195](#).

CAT.IDE.H.205 Seats, seat safety belts, restraint systems and child restraint devices

Regulation (EU) No 965/2012

- (a) Helicopters shall be equipped with:
- (1) a seat or berth for each person on board who is aged 24 months or more;
 - (2) a seat belt on each passenger seat and restraining belts for each berth;
 - (3) for helicopters first issued with an individual CofA on or after 1 August 1999, a safety belt with upper torso restraint system for use on each passenger seat for each passenger aged 24 months or more;
 - (4) a child restraint device (CRD) for each person on board younger than 24 months;
 - (5) a seat belt with upper torso restraint system incorporating a device that will automatically restrain the occupant's torso in the event of rapid deceleration on each flight crew seat;
 - (6) a seat belt with upper torso restraint system on each seat for the minimum required cabin crew.
- (b) A seat belt with upper torso restraint system shall:
- (1) have a single point release; and
 - (2) on flight crew seats and on the seats for the minimum required cabin crew include two shoulder straps and a seat belt that may be used independently.

AMC1 CAT.IDE.H.205 Seats, seat safety belts, restraint systems and child restraint devices

ED Decision 2019/019/R

CHILD RESTRAINT DEVICES (CRDs)

- (a) A CRD is considered to be acceptable if:
- (1) it is a 'supplementary loop belt' manufactured with the same techniques and the same materials of the approved safety belts; or

-
- (2) it complies with (b).
- (b) Provided the CRD can be installed properly on the respective helicopter seat, the following CRDs are considered acceptable:
- (1) CRDs approved for use in aircraft according to the European Technical Standard Order ETSO-C100c on Aviation Child Safety Device (ACSD);
 - (2) CRDs approved by EASA through a Type Certificate or Supplemental Type Certificate;
 - (3) Child seats approved for use in motor vehicles on the basis of the technical standard specified in point (i) below. The child seats must be also approved for use in aircraft on the basis of the technical standard specified in either point (ii) or point (iii):
 - (i) UN Standard ECE R44-04 (or 03), or ECE R129 bearing the respective 'ECE R' label; and
 - (ii) German 'Qualification Procedure for Child Restraint Systems for Use in Aircraft' (TÜV Doc.: TÜV/958-01/2001) bearing the label 'For Use in Aircraft'; or
 - (iii) Other technical standard acceptable to the competent authority. The child seat should hold a qualification sign that it can be used in aircraft.
 - (4) Child seats approved for use in motor vehicles and aircraft according to Canadian CMVSS 213/213.1 bearing the respective label;
 - (5) Child seats approved for use in motor vehicles and aircraft according to US FMVSS No 213 and bearing one or two labels displaying the following two sentences:
 - (i) 'THIS CHILD RESTRAINT SYSTEM CONFORMS TO ALL APPLICABLE FEDERAL MOTOR VEHICLE SAFETY STANDARDS'; and
 - (ii) in red letters 'THIS RESTRAINT IS CERTIFIED FOR USE IN MOTOR VEHICLES AND AIRCRAFT';
 - (6) Child seat approved for use in motor vehicles and aircraft according to Australia/New Zealand's technical standard AS/NZS 1754:2013 bearing the green part on the label displaying 'For Use in Aircraft'; and
 - (7) CRDs manufactured and tested according to other technical standards equivalent to those listed above. The device should be marked with an associated qualification sign, which shows the name of the qualification organisation and a specific identification number, related to the associated qualification project. The qualifying organisation should be a competent and independent organisation that is acceptable to the competent authority.
- (c) Location
- (1) Forward-facing child seats may be installed on both forward-and rearward-facing passenger seats, but only when fitted in the same direction as the passenger seat on which they are positioned. Rearward-facing child seats should only be installed on forward-facing passenger seats. A child seat should not be installed within the radius of action of an airbag unless it is obvious that the airbag is de-activated or it can be demonstrated that there is no negative impact from the airbag.
 - (2) An infant/child in a CRD should be located in the vicinity of a floor level exit.
 - (3) An infant/child in a CRD should not hinder evacuation for any passenger.

- (4) An infant/child in a CRD should neither be located in the row (where rows are existing) leading to an emergency exit nor located in a row immediately forward or aft of an emergency exit. A window passenger seat is the preferred location. An aisle passenger seat or a cross aisle passenger seat that forms part of the evacuation route to exits is not recommended. Other locations may be acceptable provided the access of neighbour passengers to the nearest aisle is not obstructed by the CRD.
 - (5) In general, only one CRD per row segment is recommended. More than one CRD per row segment is allowed if the infants/children are from the same family or travelling group provided the infants/children are accompanied by a responsible adult sitting next to them in the same row segment.
 - (6) A row segment is one or more seats side-by-side separated from the next row segment by an aisle.
- (d) Installation
- (1) CRDs tested and approved for use in aircraft should only be installed on a suitable passenger seat by the method shown in the manufacturer's instructions provided with each CRD and with the type of connecting device they are approved for the installation in aircraft. CRDs designed to be installed only by means of rigid bar lower anchorages (ISOFIX or equivalent) should only be used on passenger seats equipped with such connecting devices and should not be secured by passenger seat lap belt.
 - (2) All safety and installation instructions must be followed carefully by the responsible person accompanying the infant/child. Operators should prohibit the use of a CRD not installed on the passenger seat according to the manufacturer's instructions or not approved for use in aircraft.
 - (3) If a forward-facing child seat with a rigid backrest is to be fastened by a seat lap belt, the restraint device should be fastened when the backrest of the passenger seat on which it rests is in a reclined position. Thereafter, the backrest is to be positioned upright. This procedure ensures better tightening of the child seat on the aircraft seat if the aircraft seat is reclinable.
 - (4) The buckle of the adult safety belt must be easily accessible for both opening and closing, and must be in line with the seat belt halves (not canted) after tightening.
 - (5) Forward facing restraint devices with an integral harness must not be installed such that the adult safety belt is secured over the infant.
- (e) Operation
- (1) Each CRD should remain secured to a passenger seat during all phases of flight unless it is properly stowed when not in use.
 - (2) Where a child seat is adjustable in recline, it must be in an upright position for all occasions when passenger restraint devices are required.

AMC2 CAT.IDE.H.205 Seats, seat safety belts, restraint systems and child restraint devices

ED Decision 2014/015/R

UPPER TORSO RESTRAINT SYSTEM

An upper torso restraint system having two shoulder straps and additional straps is deemed to be compliant with the requirement for restraint systems with two shoulder straps.

SEAT BELT

A seat belt with a diagonal shoulder strap (three anchorage points) is deemed to be compliant with the requirement for a seat belt (two anchorage points).

AMC3 CAT.IDE.H.205 Seats, seat safety belts, restraint systems and child restraint devices

ED Decision 2014/015/R

SEATS FOR MINIMUM REQUIRED CABIN CREW

- (a) Seats for the minimum required cabin crew members should be located near required floor level emergency exits, except if the emergency evacuation of passengers would be enhanced by seating the cabin crew members elsewhere. In this case, other locations are acceptable. This criterion should also apply if the number of required cabin crew members exceeds the number of floor level emergency exits.
- (b) Seats for cabin crew member(s) should be forward or rearward facing within 15° of the longitudinal axis of the helicopter.

CAT.IDE.H.210 Fasten seat belt and no smoking signs

Regulation (EU) No 965/2012

Helicopters in which not all passenger seats are visible from the flight crew seat(s) shall be equipped with a means of indicating to all passengers and cabin crew when seat belts shall be fastened and when smoking is not allowed.

CAT.IDE.H.220 First-aid kits

Regulation (EU) No 965/2012

- (a) Helicopters shall be equipped with at least one first-aid kit.
- (b) First-aid kits shall be:
 - (1) readily accessible for use;
 - (2) kept up to date.

AMC1 CAT.IDE.H.220 First-aid kits

ED Decision 2021/005/R

CONTENT OF FIRST-AID KITS

- (a) First-aid kits should be equipped with appropriate and sufficient medications and instrumentation. However, these kits should be supplemented by the operator according to the

characteristics of the operation (scope of operation, flight duration, number and demographics of passengers, etc.).

(b) The following should be included in the first-aid kit:

(1) Equipment

- (i) bandages (assorted sizes, including a triangular bandage);
- (ii) burns dressings (unspecified);
- (iii) wound dressings (large and small);
- (iv) adhesive dressings (assorted sizes);
- (v) adhesive tape;
- (vi) adhesive wound closures;
- (vii) safety pins;
- (viii) safety scissors;
- (ix) antiseptic wound cleaner;
- (x) disposable resuscitation aid;
- (xi) disposable gloves;
- (xii) tweezers: splinter;
- (xiii) thermometers (non-mercury); and
- (xiv) surgical masks.

(2) Medications

- (i) simple analgesic (including paediatric form — if the type of operation does not include transport of children or infants, the paediatric form may not be included);
- (ii) antiemetic — non-injectable;
- (iii) nasal decongestant;
- (iv) gastrointestinal antacid, in the case of helicopters carrying more than 9 passengers;
- (v) anti-diarrhoeal medication in the case of helicopters carrying more than 9 passengers; and
- (vi) antihistamine (including paediatric form — if the type of operation does not include transport of children or infants, the paediatric form may not be included).

(3) Other content. The operator should make the instructions readily available. If an electronic format is available, then all instructions should be kept on the same device. If a paper format is used, then the instructions should be kept in the same kit with the applicable equipment and medication. The instructions should include, as a minimum, the following:

- (i) a list of contents in at least two languages (English and one other). This should include information on the effects and side effects of medications carried;
- (ii) first-aid handbook, current edition;

- (iii) Basic life support instructions cards (summarising and depicting the current algorithm for basic life support); and
 - (iv) medical incident report form.
- (4) Additional equipment. The following additional equipment should be carried on board each aircraft equipped with a first-aid kit, though not necessarily in the first-aid kit. The additional equipment should include, as a minimum:
- (i) automated external defibrillator (AED) on all aircraft required to carry at least one cabin crew;
 - (ii) bag-valve masks (masks in three sizes: one for adults, one for children, and one for infants). If the type of operation does not include transport of children or infants, those sizes of bag-valve masks may not be included;
 - (iii) suitable airway management device (e.g. supraglottic airway devices, oropharyngeal or nasopharyngeal airways);
 - (iv) eye irrigator; and
 - (v) biohazard disposal bags.
- (5) For HEMS operations, where the content of the first-aid kit is included in the medical equipment carried on board, the first-aid kit as described above is no longer required.

AMC2 CAT.IDE.H.220 First-aid kits

ED Decision 2014/015/R

MAINTENANCE OF FIRST-AID KITS

To be kept up to date, first-aid kits should be:

- (a) inspected periodically to confirm, to the extent possible, that contents are maintained in the condition necessary for their intended use;
- (b) replenished at regular intervals, in accordance with instructions contained on their labels, or as circumstances warrant; and
- (c) replenished after use-in-flight at the first opportunity where replacement items are available.

GM1 CAT.IDE.H.220 First-aid kit

ED Decision 2021/005/R

LOCATION AND USE

The location of the first-aid kit is normally indicated using internationally recognisable signs.

The first-aid kit 'should be readily accessible for use' in helicopter operations should be understood as the first-aid kit being either accessible in flight or immediately after landing.

In some operations, it is not practicable to use the first-aid kit during flight. Therefore, the first-aid kit can be carried in the cargo compartment, where it will be easily accessible for use as soon as the aircraft has landed, when the following conditions are met:

- (a) precautionary landing sites are available;
- (b) the lack of cabin space is such that movement or use of the first-aid kit is impaired; and
- (c) the installation of the first-aid kit in the cabin is not practicable.

GM2 CAT.IDE.H.220 First-aid kit

ED Decision 2021/005/R

STORAGE

As a best practise and wherever practicable, the emergency medical equipment listed under [AMC1 CAT.IDE.H.220](#) should be kept close together.

GM3 CAT.IDE.H.220 First-aid kit

ED Decision 2021/005/R

CONTENT OF FIRST-AID KITS

The operator may supplement first-aid kits according to the characteristics of the operation based on a risk assessment. The assessment does not require an approval by the competent authority.

GM4 CAT.IDE.H.220 First-aid kit

ED Decision 2021/005/R

LITHIUM BATTERIES

Risks related to the presence of lithium batteries should be assessed. All equipment powered by lithium batteries carried on an aeroplane should comply with the provisions of [AMC1 CAT.GEN.MPA.140\(f\)](#) including applicable technical standards such as (E)TSO-C142.

CAT.IDE.H.240 Supplemental oxygen – non-pressurised helicopters

Regulation (EU) No 965/2012

Non-pressurised helicopters operated at pressure altitudes above 10 000 ft shall be equipped with supplemental oxygen equipment capable of storing and dispensing the oxygen supplies in accordance with the following tables.

Table 1

Oxygen minimum requirements for complex non-pressurised helicopters

Supply for	Duration and cabin pressure altitude
1. Occupants of flight crew compartment seats on flight crew compartment duty and crew members assisting flight crew in their duties	The entire flying time at pressure altitudes above 10 000 ft.
2. Required cabin crew members	The entire flying time at pressure altitudes above 13 000 ft and for any period exceeding 30 minutes at pressure altitudes above 10 000 ft but not exceeding 13 000 ft.
3. Additional crew members and 100 % of passengers ⁽¹⁾	The entire flying time at pressure altitudes above 13 000 ft.
4. 10 % of passengers ⁽¹⁾	The entire flying time after 30 minutes at pressure altitudes above 10 000 ft but not exceeding 13 000 ft.
⁽¹⁾ Passenger numbers in Table 1 refer to passengers actually carried on board including persons younger than 24 months.	

Table 2

Oxygen minimum requirements for other-than-complex non-pressurised helicopters

Supply for	Duration and cabin pressure altitude
1. Occupants of flight crew compartment seats on flight crew compartment duty, crew members assisting flight crew in their duties, and required cabin crew members	The entire flying time at pressure altitudes above 13 000 ft and for any period exceeding 30 minutes at pressure altitudes above 10 000 ft but not exceeding 13 000 ft.
2. Additional crew members and 100 % of passengers ⁽¹⁾	The entire flying time at pressure altitudes above 13 000 ft.
3. 10 % of passengers ⁽¹⁾	The entire flying time after 30 minutes at pressure altitudes above 10 000 ft but not exceeding 13 000 ft.

⁽¹⁾ Passenger numbers in Table 2 refer to passengers actually carried on board including persons younger than 24 months.

AMC1 CAT.IDE.H.240 Supplemental oxygen – non-pressurised helicopters

ED Decision 2014/015/R

DETERMINATION OF OXYGEN

The amount of supplemental oxygen for sustenance for a particular operation should be determined on the basis of flight altitudes and flight duration, consistent with the operating procedures, including emergency, procedures, established for each operation and the routes to be flown as specified in the operations manual.

CAT.IDE.H.250 Hand fire extinguishers

Regulation (EU) No 965/2012

- (a) Helicopters shall be equipped with at least one hand fire extinguisher in the flight crew compartment.
- (b) At least one hand fire extinguisher shall be located in, or readily accessible for use in, each galley not located on the main passenger compartment.
- (c) At least one hand fire extinguisher shall be available for use in each cargo compartment that is accessible to crew members in flight.
- (d) The type and quantity of extinguishing agent for the required fire extinguishers shall be suitable for the type of fire likely to occur in the compartment where the extinguisher is intended to be used and to minimise the hazard of toxic gas concentration in compartments occupied by persons.
- (e) The helicopter shall be equipped with at least a number of hand fire extinguishers in accordance with Table 1, conveniently located to provide adequate availability for use in each passenger compartment.

Table 1

Number of hand fire extinguishers

MOPSC	Number of extinguishers
7-30	1
31-60	2
61-200	3

AMC1 CAT.IDE.H.250 Hand fire extinguishers

ED Decision 2014/015/R

NUMBER, LOCATION AND TYPE

- (a) The number and location of hand fire extinguishers should be such as to provide adequate availability for use, account being taken of the number and size of the passenger compartments, the need to minimise the hazard of toxic gas concentrations and the location of lavatories, galleys, etc. These considerations may result in a number of fire extinguishers greater than the minimum required.
- (b) There should be at least one hand fire extinguisher installed in the flight crew compartment and this should be suitable for fighting both flammable fluid and electrical equipment fires. Additional hand fire extinguishers may be required for the protection of other compartments accessible to the crew in flight. Dry chemical fire extinguishers should not be used in the flight crew compartment, or in any compartment not separated by a partition from the flight crew compartment, because of the adverse effect on vision during discharge and, if conductive, interference with electrical contacts by the chemical residues.
- (c) Where only one hand fire extinguisher is required in the passenger compartments, it should be located near the cabin crew member's station, where provided.
- (d) Where two or more hand fire extinguishers are required in the passenger compartments and their location is not otherwise dictated by consideration of (a), an extinguisher should be located near each end of the cabin with the remainder distributed throughout the cabin as evenly as is practicable.
- (e) Unless an extinguisher is clearly visible, its location should be indicated by a placard or sign. Appropriate symbols may also be used to supplement such a placard or sign.

CAT.IDE.H.260 Marking of break-in points

Regulation (EU) No 965/2012

If areas of the helicopter's fuselage suitable for break-in by rescue crews in an emergency are marked, such areas shall be marked as shown in Figure 1.

Figure 1

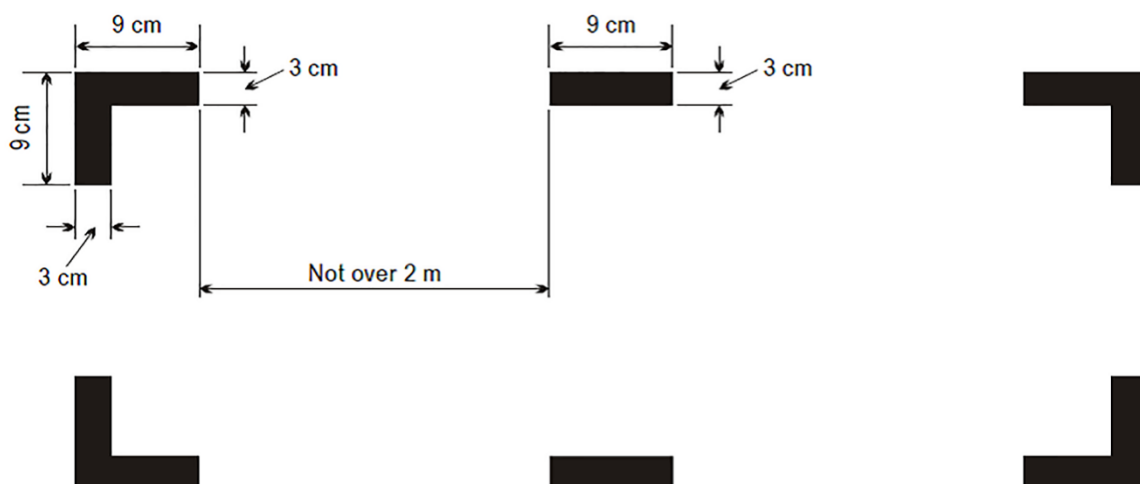

AMC1 CAT.IDE.H.260 Marking of break-in points

ED Decision 2014/015/R

MARKINGS — COLOUR AND CORNERS

- (a) The colour of the markings should be red or yellow and, if necessary, should be outlined in white to contrast with the background.
- (b) If the corner markings are more than 2 m apart, intermediate lines 9 cm x 3 cm should be inserted so that there is no more than 2 m between adjacent markings.

CAT.IDE.H.270 Megaphones

Regulation (EU) No 965/2012

Helicopters with an MOPSC of more than 19 shall be equipped with one portable battery-powered megaphone readily accessible for use by crew members during an emergency evacuation.

AMC1 CAT.IDE.H.270 Megaphones

ED Decision 2014/015/R

LOCATION OF MEGAPHONES

- (a) The megaphone should be readily accessible at the assigned seat of a cabin crew member or crew members other than flight crew.
- (b) This does not necessarily require megaphones to be positioned such that they can be physically reached by a crew member when strapped in a cabin crew member's seat.

CAT.IDE.H.275 Emergency lighting and marking

Regulation (EU) No 965/2012

- (a) Helicopters with an MOPSC of more than 19 shall be equipped with:
 - (1) an emergency lighting system having an independent power supply to provide a source of general cabin illumination to facilitate the evacuation of the helicopter; and
 - (2) emergency exit marking and locating signs visible in daylight or in the dark.
- (b) Helicopters shall be equipped with emergency exit markings visible in daylight or in the dark when operated:
 - (1) in performance class 1 or 2 on a flight over water at a distance from land corresponding to more than 10 minutes flying time at normal cruising speed;
 - (2) in performance class 3 on a flight over water at a distance corresponding to more than three minutes flying time at normal cruising speed.

CAT.IDE.H.280 Emergency locator transmitter (ELT)

Regulation (EU) No 965/2012

- (a) Helicopters shall be equipped with at least one automatic ELT.
- (b) An ELT of any type shall be capable of transmitting simultaneously on 121,5 MHz and 406 MHz.

AMC1 CAT.IDE.H.280 Emergency locator transmitter (ELT)

ED Decision 2014/015/R

BATTERIES

- (a) All batteries used in ELTs should be replaced (or recharged if the battery is rechargeable) when the equipment has been in use for more than 1 cumulative hour or in the following cases:
- (1) Batteries specifically designed for use in ELTs and having an airworthiness release certificate (EASA Form 1 or equivalent) should be replaced (or recharged if the battery is rechargeable) before the end of their useful life in accordance with the maintenance instructions applicable to the ELT.
 - (2) Standard batteries manufactured in accordance with an industry standard and not having an airworthiness release certificate (EASA Form 1 or equivalent), when used in ELTs should be replaced (or recharged if the battery is rechargeable) when 50 % of their useful life (or for rechargeable, 50 % of their useful life of charge), as established by the battery manufacturer, has expired.
 - (3) The battery useful life (or useful life of charge) criteria in (1) and (2) do not apply to batteries (such as water-activated batteries) that are essentially unaffected during probable storage intervals.
- (b) The new expiry date for a replaced (or recharged) battery should be legibly marked on the outside of the equipment.

AMC2 CAT.IDE.H.280 Emergency locator transmitter (ELT)

ED Decision 2021/008/R

TYPES OF ELTs AND GENERAL TECHNICAL SPECIFICATIONS

- (a) The ELT required by this provision should be one of the following:
- (1) Automatic Fixed (ELT(AF)). An automatically activated ELT that is permanently attached to an aircraft and is designed to aid search and rescue (SAR) teams in locating the crash site.
 - (2) Automatic Portable (ELT(AP)). An automatically activated ELT, which is rigidly attached to an aircraft before a crash, but is readily removable from the aircraft after a crash. It functions as an ELT during the crash sequence. If the ELT does not employ an integral antenna, the aircraft-mounted antenna may be disconnected and an auxiliary antenna (stored in the ELT case) attached to the ELT. The ELT can be tethered to a survivor or a life-raft. This type of ELT is intended to aid SAR teams in locating the crash site or survivor(s).
 - (3) Automatic deployable (ELT(AD)). An ELT that is rigidly attached to the aircraft before the crash and that is automatically deployed and activated by an impact, and, in some cases, also by water sensors. This type of ELT should float in water and is intended to aid SAR teams in locating the crash site. The ELT(AD) may be either a stand-alone beacon or an inseparable part of a deployable recorder.
- (b) To minimise the possibility of damage in the event of crash impact, the automatic ELT should be rigidly fixed to the aircraft structure, as far aft as is practicable, with its antenna and connections arranged so as to maximise the probability of the signal being transmitted after a crash.

- (c) Any ELT carried should operate in accordance with the relevant provisions of ICAO Annex 10, Volume III Communications Systems and should be registered with the national agency responsible for initiating search and rescue or other nominated agency.

GM1 CAT.IDE.H.280 Emergency locator transmitter (ELT)

ED Decision 2021/008/R

TERMINOLOGY

- (a) An 'automatic ELT' means an ELT(AF), ELT(AP), or ELT(AD). Other types of ELTs are not considered 'automatic ELTs'.
- (b) A 'water sensor' means a sensor that detects water immersion, including at low depth.

GM2 CAT.IDE.H.280 Emergency locator transmitter (ELT)

ED Decision 2021/008/R

ADDITIONAL GUIDANCE

- (a) It is advisable to install automatic ELTs that transmit encoded position data and that meet the operational performance requirements of EUROCAE Document ED-62B, or RTCA DO-204B, or any later equivalent standard.
- (b) Guidance material for the inspection of an ELT can be found in FAA Advisory Circular (AC) 91-44A 'Installation and Inspection Procedures for Emergency Locator Transmitters and Receivers', Change 1, dated February 2018.

CAT.IDE.H.290 Life-jackets

Regulation (EU) No 965/2012

- (a) Helicopters shall be equipped with a life-jacket for each person on board or equivalent flotation device for each person on board younger than 24 months, stowed in a position that is readily accessible from the seat or berth of the person for whose use it is provided, when operated in:
- (1) performance class 1 or 2 on a flight over water at a distance from land corresponding to more than 10 minutes flying time at normal cruising speed;
 - (2) performance class 3 on a flight over water beyond autorotational distance from land;
 - (3) performance class 2 or 3 when taking off or landing at an aerodrome or operating site where the take-off or approach path is over water.
- (b) Each life-jacket or equivalent individual flotation device shall be equipped with a means of electric illumination for the purpose of facilitating the location of persons.

AMC1 CAT.IDE.H.290 Life-jackets

ED Decision 2014/015/R

ACCESSIBILITY

The life-jacket should be accessible from the seat or berth of the person for whose use it is provided, with a safety belt or harness fastened.

AMC2 CAT.IDE.H.290(b) Life-jackets

ED Decision 2015/007/R

ELECTRIC ILLUMINATION

The means of electric illumination should be a survivor locator light as defined in the applicable ETSO issued by the Agency or equivalent.

GM1 CAT.IDE.H.290 Life-jackets

ED Decision 2014/015/R

SEAT CUSHIONS

Seat cushions are not considered to be flotation devices.

CAT.IDE.H.295 Crew survival suits

Regulation (EU) 2016/1199

Each crew member shall wear a survival suit when operating in performance class 3 on a flight over water beyond autorotational distance or safe forced landing distance from land, when the weather report or forecasts available to the commander indicate that the sea temperature will be less than plus 10 °C during the flight.

GM1 CAT.IDE.H.295 Crew survival suits

ED Decision 2014/015/R

ESTIMATING SURVIVAL TIME

(a) Introduction

- (1) A person accidentally immersed in cold seas (typically offshore Northern Europe) will have a better chance of survival if he/she is wearing an effective survival suit in addition to a life-jacket. By wearing the survival suit, he/she can slow down the rate which his/her body temperature falls and, consequently, protect himself/herself from the greater risk of drowning brought about by incapacitation due to hypothermia.
- (2) The complete survival suit system – suit, life-jacket and clothes worn under the suit – should be able to keep the wearer alive long enough for the rescue services to find and recover him/her. In practice the limit is about 3 hours. If a group of persons in the water cannot be rescued within this time they are likely to have become so scattered and separated that location will be extremely difficult, especially in the rough water typical of Northern European sea areas. If it is expected that in water protection could be required for periods greater than 3 hours, improvements should, rather, be sought in the search and rescue procedures than in the immersion suit protection.

(b) Survival times

- (1) The aim should be to ensure that a person in the water can survive long enough to be rescued, i.e. the survival time must be greater than the likely rescue time. The factors affecting both times are shown in Figure 1 below. The figure emphasises that survival time is influenced by many factors, physical and human. Some of the factors are relevant to survival in cold water and some are relevant to survival in water at any temperature.

Figure 1

The survival equation

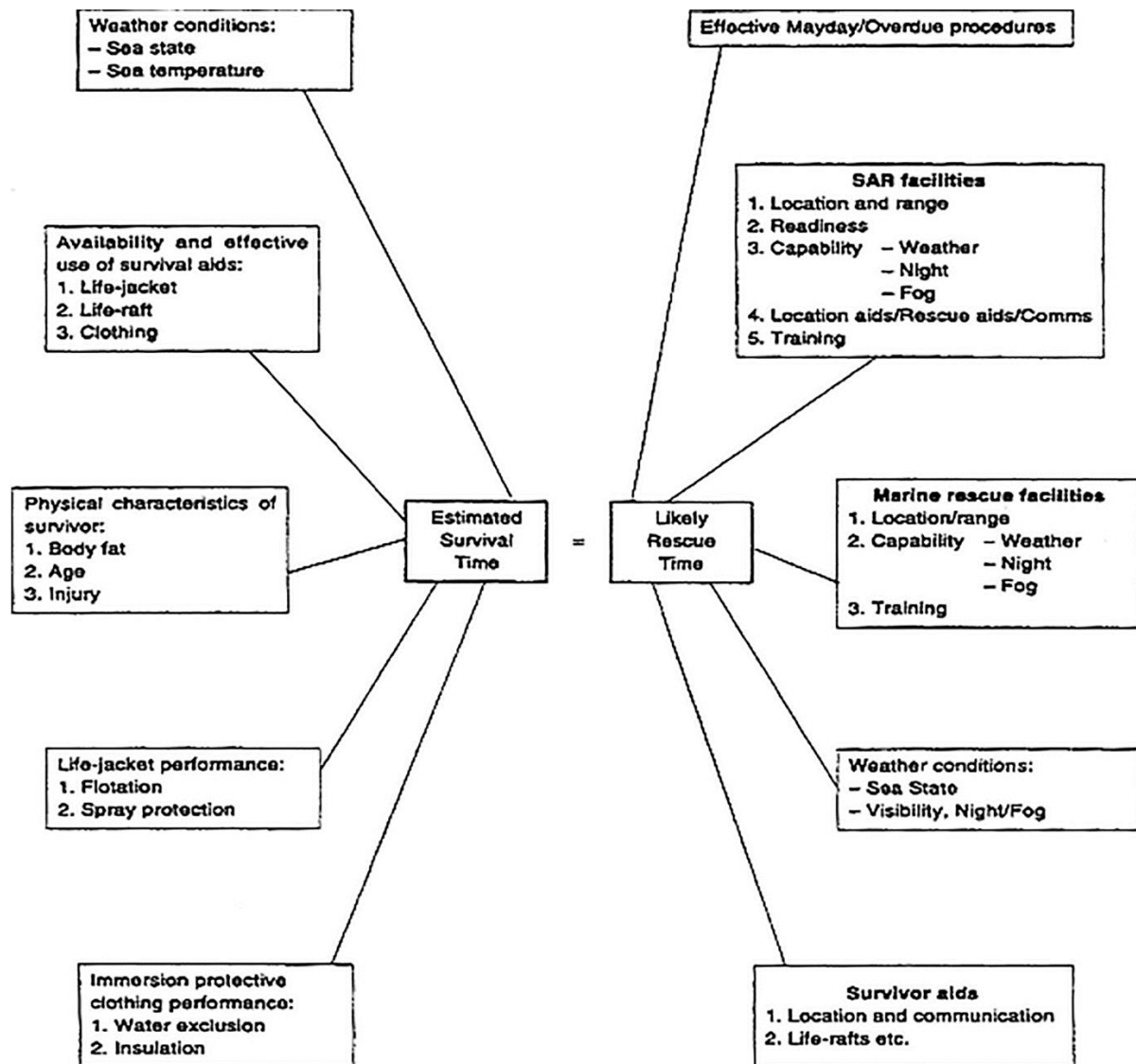

- (2) Broad estimates of likely survival times for the thin individual offshore are given in Table 1 below. As survival time is significantly affected by the prevailing weather conditions at the time of immersion, the Beaufort wind scale has been used as an indicator of these surface conditions.

Table 1

Timescale within which the most vulnerable individuals are likely to succumb to the prevailing conditions.

Clothing assembly	Beaufort wind force	Times within which the most vulnerable individuals are likely to drown	
		(water temp 5°c)	(water temp 13°c)
Working clothes (no immersion suit)	0 – 2	Within ¼ hour	Within 1 ¼ hours
	3 – 4	Within ½ hour	Within ½ hour
	5 and above	Significantly less than ½ hour	Significantly less than ½ hour
	0-2	May well exceed 3 hours	May well exceed 3 hours

Clothing assembly	Beaufort wind force	Times within which the most vulnerable individuals are likely to drown	
		(water temp 5°C)	(water temp 13°C)
Immersion suit worn over working clothes (with leakage inside suit)	3 – 4	Within 2 ¾ hours	May well exceed 3 hours
	5 and above	Significantly less than 2 ¾ hours. May well exceed 1 hour	May well exceed 3 hours

- (3) Consideration should also be given to escaping from the helicopter itself should it submerge or invert in the water. In this case, escape time is limited to the length of time the occupants can hold their breath. The breath holding time can be greatly reduced by the effect of cold shock. Cold shock is caused by the sudden drop in skin temperature on immersion, and is characterised by a gasp reflex and uncontrolled breathing. The urge to breathe rapidly becomes overwhelming and, if still submerged, the individual will inhale water resulting in drowning. Delaying the onset of cold shock by wearing an immersion suit will extend the available escape time from a submerged helicopter.
- (4) The effects of water leakage and hydrostatic compression on the insulation quality of clothing are well recognised. In a nominally dry system, the insulation is provided by still air trapped within the clothing fibres and between the layers of suit and clothes. It has been observed that many systems lose some of their insulative capacity either because the clothes under the 'waterproof' survival suit get wet to some extent or because of hydrostatic compression of the whole assembly. As a result of water leakage and compression, survival times will be shortened. The wearing of warm clothing under the suit is recommended.
- (5) Whatever type of survival suit and other clothing is provided, it should not be forgotten that significant heat loss can occur from the head.

CAT.IDE.H.300 Life-rafts, survival ELTs and survival equipment on extended overwater flights

Regulation (EU) No 965/2012

Helicopters operated:

- (a) in performance class 1 or 2 on a flight over water at a distance from land corresponding to more than 10 minutes flying time at normal cruising speed;
- (b) in performance class 3 on a flight over water at a distance corresponding to more than three minutes flying time at normal cruising speed, shall be equipped with:
 - (1) in the case of a helicopter carrying less than 12 persons, at least one life-raft with a rated capacity of not less than the maximum number of persons on board, stowed so as to facilitate its ready use in an emergency;
 - (2) in the case of a helicopter carrying more than 11 persons, at least two life-rafts, stowed so as to facilitate their ready use in an emergency, sufficient together to accommodate all persons capable of being carried on board and, if one is lost, the remaining life-raft(s) having, the overload capacity sufficient to accommodate all persons on the helicopter;
 - (3) at least one survival ELT (ELT(S)) for each required life-raft; and
 - (4) life-saving equipment, including means of sustaining life, as appropriate to the flight to be undertaken.

AMC1 CAT.IDE.H.300 Life-rafts, survival ELTs and survival equipment on extended overwater flights

ED Decision 2014/015/R

LIFE-RAFTS AND EQUIPMENT FOR MAKING DISTRESS SIGNALS – HELICOPTERS

- (a) Each required life-raft should conform to the following specifications:
- (1) be of an approved design and stowed so as to facilitate their ready use in an emergency;
 - (2) be radar conspicuous to standard airborne radar equipment;
 - (3) when carrying more than one life-raft on board, at least 50 % should be able to be deployed by the crew while seated at their normal station, where necessary by remote control; and
 - (4) life-rafts that are not deployable by remote control or by the crew should be of such weight as to permit handling by one person. 40 kg should be considered a maximum weight.
- (b) Each required life-raft should contain at least the following:
- (1) one approved survivor locator light;
 - (2) one approved visual signalling device;
 - (3) one canopy (for use as a sail, sunshade or rain catcher) or other mean to protect occupants from the elements;
 - (4) one radar reflector;
 - (5) one 20-m retaining line designed to hold the life-raft near the helicopter but to release it if the helicopter becomes totally submerged;
 - (6) one sea anchor;
 - (7) one survival kit, appropriately equipped for the route to be flown, which should contain at least the following:
 - (i) one life-raft repair kit;
 - (ii) one bailing bucket;
 - (iii) one signalling mirror;
 - (iv) one police whistle;
 - (v) one buoyant raft knife;
 - (vi) one supplementary means of inflation;
 - (vii) sea sickness tablets;
 - (viii) one first-aid kit;
 - (ix) one portable means of illumination;
 - (x) 500 ml of pure water and one sea water desalting kit; and
 - (xi) one comprehensive illustrated survival booklet in an appropriate language.

AMC1 CAT.IDE.H.300(b)(3) & CAT.IDE.H.305(b) Flight over water & Survival equipment

ED Decision 2021/008/R

SURVIVAL ELT

- (a) The survival ELT (ELT(S)) is an ELT removable from an aircraft, stowed so as to facilitate its ready use in an emergency, and manually activated by a survivor. An ELT(S) may be activated manually or automatically (e.g. by water activation). It should be designed to be tethered either to a life raft or a survivor.
- (b) An ELT(AP) may be used to replace one required ELT(S) provided that it meets the ELT(S) requirements. A water-activated ELT(S) is not an ELT(AP).

CAT.IDE.H.305 Survival equipment

Regulation (EU) No 965/2012

Helicopters operated over areas in which search and rescue would be especially difficult shall be equipped with:

- (a) signalling equipment to make distress signals;
- (b) at least one ELT(S); and
- (c) additional survival equipment for the route to be flown taking account of the number of persons on board.

AMC1 CAT.IDE.H.305 Survival equipment

ED Decision 2014/015/R

ADDITIONAL SURVIVAL EQUIPMENT

- (a) The following additional survival equipment should be carried when required:
 - (1) 500 ml of water for each 4, or fraction of 4, persons on board;
 - (2) one knife;
 - (3) first-aid equipment; and
 - (4) one set of air/ground codes.
- (b) In addition, when polar conditions are expected, the following should be carried:
 - (1) a means for melting snow;
 - (2) one snow shovel and 1 ice saw;
 - (3) sleeping bags for use by 1/3 of all persons on board and space blankets for the remainder or space blankets for all passengers on board; and
 - (4) one arctic/polar suit for each crew member.
- (c) If any item of equipment contained in the above list is already carried on board the helicopter in accordance with another requirement, there is no need for this to be duplicated.

AMC1 CAT.IDE.H.300(b)(3) & CAT.IDE.H.305(b) Flight over water & Survival equipment

ED Decision 2021/008/R

SURVIVAL ELT

- (a) The survival ELT (ELT(S)) is an ELT removable from an aircraft, stowed so as to facilitate its ready use in an emergency, and manually activated by a survivor. An ELT(S) may be activated manually or automatically (e.g. by water activation). It should be designed to be tethered either to a life raft or a survivor.
- (b) An ELT(AP) may be used to replace one required ELT(S) provided that it meets the ELT(S) requirements. A water-activated ELT(S) is not an ELT(AP).

GM1 CAT.IDE.H.305 Survival equipment

ED Decision 2014/015/R

SIGNALLING EQUIPMENT

The signalling equipment for making distress signals is described in ICAO Annex 2, Rules of the Air.

GM2 CAT.IDE.H.305 Survival equipment

ED Decision 2014/015/R

AREAS IN WHICH SEARCH AND RESCUE WOULD BE ESPECIALLY DIFFICULT

The expression 'areas in which search and rescue would be especially difficult' should be interpreted, in this context, as meaning:

- (a) areas so designated by the authority responsible for managing search and rescue; or
- (b) areas that are largely uninhabited and where:
 - (1) the authority referred to in (a) has not published any information to confirm whether search and rescue would be or would not be especially difficult; and
 - (2) the authority referred to in (a) does not, as a matter of policy, designate areas as being especially difficult for search and rescue.

CAT.IDE.H.315 Helicopters certified for operating on water – miscellaneous equipment

Regulation (EU) 2019/1384

Helicopters certified for operating on water shall be equipped with:

- (a) a sea anchor and other equipment necessary to facilitate mooring, anchoring or manoeuvring the helicopter on water, appropriate to its size, mass and handling characteristics; and
- (b) equipment for making the sound signals prescribed in the International Regulations for Preventing Collisions at Sea, where applicable.

GM1 CAT.IDE.H.315 Helicopters certificated for operating on water – Miscellaneous equipment

ED Decision 2014/015/R

INTERNATIONAL REGULATIONS FOR PREVENTING COLLISIONS AT SEA

International Regulations for Preventing Collisions at Sea are those that were published by the International Maritime Organisation (IMO) in 1972.

CAT.IDE.H.320 All helicopters on flights over water – ditching

Regulation (EU) 2019/1384

- (a) Helicopters shall be designed for landing on water or certified for ditching in accordance with the relevant certification specification when operated in performance class 1 or 2 on a flight over water in a hostile environment at a distance from land corresponding to more than 10 minutes flying time at normal cruise speed.
- (b) Helicopters shall be designed for landing on water or certified for ditching in accordance with the relevant certification specification or fitted with emergency flotation equipment when operated in:
 - (1) performance class 1 or 2 on a flight over water in a non-hostile environment at a distance from land corresponding to more than 10 minutes flying time at normal cruise speed;
 - (2) performance class 2, when taking off or landing over water, except in the case of helicopter emergency medical services (HEMS) operations, where for the purpose of minimising exposure, the landing or take-off at a HEMS operating site located in a congested environment is conducted over water;
 - (3) performance class 3 on a flight over water beyond safe forced landing distance from land.

GM1 CAT.IDE.H.320 Landing on water

ED Decision 2016/022/R

DESIGN FOR LANDING ON WATER

A helicopter is designed for landing on water if safety provisions at least equivalent to those for ditching (CS 27.801/CS 29.801) are met.

AMC1 CAT.IDE.H.320(b) All helicopters on flight over water – ditching

ED Decision 2016/022/R

GENERAL

The same considerations of [AMC1 SPA.HOFO.165\(d\)](#) should apply in respect of emergency flotation equipment.

CAT.IDE.H.325 Headset

Regulation (EU) No 965/2012

Whenever a radio communication and/or radio navigation system is required, helicopters shall be equipped with a headset with boom microphone or equivalent and a transmit button on the flight controls for each required pilot and/or crew member at his/her assigned station.

AMC1 CAT.IDE.H.325 Headset

ED Decision 2014/015/R

GENERAL

- (a) A headset consists of a communication device that includes two earphones to receive and a microphone to transmit audio signals to the helicopter's communication system. To comply with the minimum performance requirements, the earphones and microphone should match the communication system's characteristics and the cockpit environment. The headset should be adequately adjustable in order to fit the pilot's head. Headset boom microphones should be of the noise cancelling type.
- (b) If the intention is to utilise noise cancelling earphones, the operator should ensure that the earphones do not attenuate any aural warnings or sounds necessary for alerting the flight crew on matters related to the safe operation of the helicopter.

GM1 CAT.IDE.H.325 Headset

ED Decision 2014/015/R

GENERAL

The term 'headset' includes any aviation helmet incorporating headphones and microphone worn by a flight crew member.

CAT.IDE.H.330 Radio communication equipment

Regulation (EU) No 965/2012

- (a) Helicopters shall be equipped with the radio communication equipment required by the applicable airspace requirements.
- (b) The radio communication equipment shall provide for communication on the aeronautical emergency frequency 121,5 MHz.

CAT.IDE.H.335 Audio selector panel

Regulation (EU) No 965/2012

Helicopters operated under IFR shall be equipped with an audio selector panel operable from each required flight crew member station.

CAT.IDE.H.340 Radio equipment for operations under VFR over routes navigated by reference to visual landmarks

Regulation (EU) No 965/2012

Helicopters operated under VFR over routes that can be navigated by reference to visual landmarks shall be equipped with radio communication equipment necessary under normal radio propagation conditions to fulfil the following:

- (a) communicate with appropriate ground stations;
- (b) communicate with appropriate ATC stations from any point in controlled airspace within which flights are intended; and
- (c) receive meteorological information.

CAT.IDE.H.345 Communication, navigation and surveillance equipment for operations under IFR or under VFR over routes not navigated by reference to visual landmarks

Regulation (EU) 2019/1387

- (a) Helicopters operated under IFR or under VFR over routes that cannot be navigated by reference to visual landmarks shall be equipped with radio communication, navigation and surveillance equipment in accordance with the applicable airspace requirements.
- (b) Radio communication equipment shall include at least two independent radio communication systems necessary under normal operating conditions to communicate with an appropriate ground station from any point on the route, including diversions.
- (c) Helicopters shall have sufficient navigation equipment to ensure that, in the event of the failure of one item of equipment at any stage of the flight, the remaining equipment shall allow safe navigation in accordance with the flight plan.
- (d) Helicopters operated on flights in which it is intended to land in IMC shall be equipped with suitable equipment capable of providing guidance to a point from which a visual landing can be performed for each aerodrome at which it is intended to land in IMC and for any designated alternate aerodromes.
- (e) For PBN operations the aircraft shall meet the airworthiness certification requirements for the appropriate navigation specification.

AMC1 CAT.IDE.H.345 Communication and navigation equipment for operations under IFR or under VFR over routes not navigated by reference to visual landmarks

ED Decision 2014/015/R

TWO INDEPENDENT MEANS OF COMMUNICATION

Whenever two independent means of communication are required, each system should have an independent antenna installation, except where rigidly supported non-wire antennae or other antenna installations of equivalent reliability are used.

AMC2 CAT.IDE.H.345 Communication and navigation equipment for operations under IFR or under VFR over routes not navigated by reference to visual landmarks

ED Decision 2014/015/R

ACCEPTABLE NUMBER AND TYPE OF COMMUNICATION AND NAVIGATION EQUIPMENT

- (a) An acceptable number and type of communication and navigation equipment is:
 - (1) two VHF omnidirectional radio range (VOR) receiving systems on any route, or part thereof, where navigation is based only on VOR signals;
 - (2) two automatic direction finder (ADF) systems on any route, or part thereof, where navigation is based only on non-directional beacon (NDB) signals; and
 - (3) area navigation equipment when area navigation is required for the route being flown (e.g. equipment required by Part-SPA).

- (b) The helicopter may be operated without the navigation equipment specified in (a)(1) and (a)(2) provided it is equipped with alternative equipment. The reliability and the accuracy of alternative equipment should allow safe navigation for the intended route.
- (c) VHF communication equipment, instrument landing system (ILS) localiser and VOR receivers installed on helicopters to be operated under IFR should comply with the following FM immunity performance standards:
 - (1) ICAO Annex 10, Volume I – Radio Navigation Aids, and Volume III, Part II – Voice Communications Systems; and
 - (2) acceptable equipment standards contained in EUROCAE Minimum Operational Performance Specifications, documents ED-22B for VOR receivers, ED-23B for VHF communication receivers and ED-46B for LOC receivers and the corresponding Radio Technical Commission for Aeronautics (RTCA) documents DO-186, DO-195 and DO-196.

AMC3 CAT.IDE.H.345 Communication and navigation equipment for operations under IFR or under VFR over routes not navigated by reference to visual landmarks

ED Decision 2014/015/R

FAILURE OF A SINGLE UNIT

Required communication and navigation equipment should be installed such that the failure of any single unit required for either communication or navigation purposes, or both, will not result in the failure of another unit required for communications or navigation purposes.

GM1 CAT.IDE.H.345 Communication and navigation equipment for operations under IFR or under VFR over routes not navigated by reference to visual landmarks

ED Decision 2014/015/R

APPLICABLE AIRSPACE REQUIREMENTS

For helicopters being operated under European air traffic control, the applicable airspace requirements include the Single European Sky legislation.

GM2 CAT.IDE.H.345 Communication and navigation equipment for operations under IFR or under VFR over routes not navigated by reference to visual landmarks

ED Decision 2016/015/R

AIRCRAFT ELIGIBILITY FOR PBN SPECIFICATION NOT REQUIRING SPECIFIC APPROVAL

- (a) The performance of the aircraft is usually stated in the AFM.
- (b) Where such a reference cannot be found in the AFM, other information provided by the aircraft manufacturer as TC holder, the STC holder or the design organisation having a privilege to approve minor changes may be considered.
- (c) The following documents are considered acceptable sources of information:
 - (1) AFM, supplements thereto, and documents directly referenced in the AFM;

-
- (2) FCOM or similar document;
 - (3) Service Bulletin or Service Letter issued by the TC holder or STC holder;
 - (4) approved design data or data issued in support of a design change approval;
 - (5) any other formal document issued by the TC or STC holders stating compliance with PBN specifications, AMC, Advisory Circulars (AC) or similar documents issued by the State of Design; and
 - (6) written evidence obtained from the State of Design.
- (d) Equipment qualification data, in itself, is not sufficient to assess the PBN capabilities of the aircraft, since the latter depend on installation and integration.
- (e) As some PBN equipment and installations may have been certified prior to the publication of the PBN Manual and the adoption of its terminology for the navigation specifications, it is not always possible to find a clear statement of aircraft PBN capability in the AFM. However, aircraft eligibility for certain PBN specifications can rely on the aircraft performance certified for PBN procedures and routes prior to the publication of the PBN Manual.
- (f) Below, various references are listed which may be found in the AFM or other acceptable documents (see listing above) in order to consider the aircraft's eligibility for a specific PBN specification if the specific term is not used.
- (g) RNAV 5
- (1) If a statement of compliance with any of the following specifications or standards is found in the acceptable documentation as listed above, the aircraft is eligible for RNAV 5 operations.
 - (i) B-RNAV;
 - (ii) RNAV 1;
 - (iii) RNP APCH;
 - (iv) RNP 4;
 - (v) A-RNP;
 - (vi) AMC 20-4;
 - (vii) JAA TEMPORARY GUIDANCE MATERIAL, LEAFLET NO. 2 (TGL 2);
 - (viii) JAA AMJ 20X2;
 - (ix) FAA AC 20-130A for en route operations;
 - (x) FAA AC 20-138 for en route operations; and
 - (xi) FAA AC 90-96.
- (h) RNAV 1/RNAV 2
- (1) If a statement of compliance with any of the following specifications or standards is found in the acceptable documentation as listed above, the aircraft is eligible for RNAV 1/RNAV 2 operations.
 - (i) RNAV 1;
 - (ii) PRNAV;
 - (iii) US RNAV type A;

- (iv) FAA AC 20-138 for the appropriate navigation specification;
 - (v) FAA AC 90-100A;
 - (vi) JAA TEMPORARY GUIDANCE MATERIAL, LEAFLET NO. 10 Rev1 (TGL 10); and
 - (vii) FAA AC 90-100.
 - (2) However, if position determination is exclusively computed based on VOR-DME, the aircraft is not eligible for RNAV 1/RNAV 2 operations.
- (i) RNP 1/RNP 2 continental
- (1) If a statement of compliance with any of the following specifications or standards is found in the acceptable documentation as listed above, the aircraft is eligible for RNP 1/RNP 2 continental operations.
 - (i) A-RNP;
 - (ii) FAA AC 20-138 for the appropriate navigation specification; and
 - (iii) FAA AC 90-105.
 - (2) Alternatively, if a statement of compliance with any of the following specifications or standards is found in the acceptable documentation as listed above and position determination is primarily based on GNSS, the aircraft is eligible for RNP 1/RNP 2 continental operations. However, in these cases, loss of GNSS implies loss of RNP 1/RNP 2 capability.
 - (i) JAA TEMPORARY GUIDANCE MATERIAL, LEAFLET NO. 10 (TGL 10) (any revision); and
 - (ii) FAA AC 90-100.
- (j) RNP APCH — LNAV minima
- (1) If a statement of compliance with any of the following specifications or standards is found in the acceptable documentation as listed above, the aircraft is eligible for RNP APCH — LNAV operations.
 - (i) A-RNP;
 - (ii) AMC 20-27;
 - (iii) AMC 20-28;
 - (iv) FAA AC 20-138 for the appropriate navigation specification; and
 - (v) FAA AC 90-105 for the appropriate navigation specification.
 - (2) Alternatively, if a statement of compliance with RNP 0.3 GNSS approaches in accordance with any of the following specifications or standards is found in the acceptable documentation as listed above, the aircraft is eligible for RNP APCH — LNAV operations. Any limitation such as ‘within the US National Airspace’ may be ignored since RNP APCH procedures are assumed to meet the same ICAO criteria around the world.
 - (i) JAA TEMPORARY GUIDANCE MATERIAL, LEAFLET NO. 3 (TGL 3);
 - (ii) AMC 20-4;
 - (iii) FAA AC 20-130A; and
 - (iv) FAA AC 20-138.

-
- (k) RNP APCH — LNAV/VNAV minima
- (1) If a statement of compliance with any of the following specifications or standards is found in the acceptable documentation as listed above, the aircraft is eligible for RNP APCH — LNAV/VNAV operations.
 - (i) A-RNP;
 - (ii) AMC 20-27 with Baro VNAV;
 - (iii) AMC 20-28;
 - (iv) FAA AC 20-138; and
 - (v) FAA AC 90-105 for the appropriate navigation specification.
 - (2) Alternatively, if a statement of compliance with FAA AC 20-129 is found in the acceptable documentation as listed above, and the aircraft complies with the requirements and limitations of EASA SIB 2014-04¹, the aircraft is eligible for RNP APCH — LNAV/VNAV operations. Any limitation such as ‘within the US National Airspace’ may be ignored since RNP APCH procedures are assumed to meet the same ICAO criteria around the world.
- (l) RNP APCH — LPV minima
- (1) If a statement of compliance with any of the following specifications or standards is found in the acceptable documentation as listed above, the aircraft is eligible for RNP APCH — LPV operations.
 - (i) AMC 20-28;
 - (ii) FAA AC 20-138 for the appropriate navigation specification; and
 - (iii) FAA AC 90-107.
 - (2) For aircraft that have a TAWS Class A installed and do not provide Mode-5 protection on an LPV approach, the DH is limited to 250 ft.
- (m) RNAV 10
- (1) If a statement of compliance with any of the following specifications or standards is found in the acceptable documentation as listed above, the aircraft is eligible for RNAV 10 operations.
 - (i) RNP 10;
 - (ii) FAA AC 20-138 for the appropriate navigation specification;
 - (iii) AMC 20-12;
 - (iv) FAA Order 8400.12 (or later revision); and
 - (v) FAA AC 90-105.
- (n) RNP 4
- (1) If a statement of compliance with any of the following specifications or standards is found in the acceptable documentation as listed above, the aircraft is eligible for RNP 4 operations.
 - (i) FAA AC 20-138B or later, for the appropriate navigation specification;

¹ <http://ad.easa.europa.eu/ad/2014-04>

- (ii) FAA Order 8400.33; and
 - (iii) FAA AC 90-105 for the appropriate navigation specification.
- (o) RNP 2 oceanic
- (1) If a statement of compliance with FAA AC 90-105 for the appropriate navigation specification is found in the acceptable documentation as listed above, the aircraft is eligible for RNP 2 oceanic operations.
 - (2) If the aircraft has been assessed eligible for RNP 4, the aircraft is eligible for RNP 2 oceanic.
- (p) Special features
- (1) RF in terminal operations (used in RNP 1 and in the initial segment of the RNP APCH)
 - (i) If a statement of demonstrated capability to perform an RF leg, certified in accordance with any of the following specifications or standards, is found in the acceptable documentation as listed above, the aircraft is eligible for RF in terminal operations:
 - (A) AMC 20-26; and
 - (B) FAA AC 20-138B or later.
 - (ii) If there is a reference to RF and a reference to compliance with AC 90-105, then the aircraft is eligible for such operations.
- (q) Other considerations
- (1) In all cases, the limitations in the AFM need to be checked; in particular, the use of AP or FD which can be required to reduce the FTE primarily for RNP APCH, RNAV 1, and RNP 1.
 - (2) Any limitation such as 'within the US National Airspace' may be ignored since RNP APCH procedures are assumed to meet the same ICAO criteria around the world.

GM3 CAT.IDE.H.345 Communication and navigation equipment for operations under IFR or under VFR over routes not navigated by reference to visual landmarks

ED Decision 2016/015/R

GENERAL

- (a) The PBN specifications for which the aircraft complies with the relevant airworthiness criteria are set out in the AFM, together with any limitations to be observed.
- (b) Because functional and performance requirements are defined for each navigation specification, an aircraft approved for an RNP specification is not automatically approved for all RNAV specifications. Similarly, an aircraft approved for an RNP or RNAV specification having a stringent accuracy requirement (e.g. RNP 0.3 specification) is not automatically approved for a navigation specification having a less stringent accuracy requirement (e.g. RNP 4).

RNP 4

- (c) For RNP 4, at least two LRNSs, capable of navigating to RNP 4, and listed in the AFM, may be operational at the entry point of the RNP 4 airspace. If an item of equipment required for RNP 4 operations is unserviceable, then the flight crew may consider an alternate route or diversion

for repairs. For multi-sensor systems, the AFM may permit entry if one GNSS sensor is lost after departure, provided one GNSS and one inertial sensor remain available.

CAT.IDE.H.350 Transponder

Regulation (EU) No 965/2012

Helicopters shall be equipped with a pressure altitude reporting secondary surveillance radar (SSR) transponder and any other SSR transponder capability required for the route being flown.

AMC1 CAT.IDE.H.350 Transponder

ED Decision 2014/015/R

SSR TRANSPONDER

- (a) The secondary surveillance radar (SSR) transponders of aircraft being operated under European air traffic control should comply with any applicable Single European Sky legislation.
- (b) If the Single European Sky legislation is not applicable, the SSR transponders should operate in accordance with the relevant provisions of Volume IV of ICAO Annex 10.

CAT.IDE.H.355 Management of aeronautical databases

Regulation (EU) 2016/1199

- (a) Aeronautical databases used on certified aircraft system applications shall meet data quality requirements that are adequate for the intended use of the data.
- (b) The operator shall ensure the timely distribution and insertion of current and unaltered aeronautical databases to all aircraft that require them.
- (c) Notwithstanding any other occurrence reporting requirements as defined in Regulation (EU) No 376/2014, the operator shall report to the database provider instances of erroneous, inconsistent or missing data that might be reasonably expected to constitute a hazard to flight.

In such cases, the operator shall inform flight crew and other personnel concerned, and shall ensure that the affected data is not used.

AMC1 CAT.IDE.H.355 Management of aeronautical databases

ED Decision 2017/003/R

AERONAUTICAL DATABASES

When the operator of an aircraft uses an aeronautical database that supports an airborne navigation application as a primary means of navigation used to meet the airspace usage requirements, the database provider should be a Type 2 DAT provider certified in accordance with Regulation (EU) 2017/373 or equivalent.

GM1 CAT.IDE.H.355 Management of aeronautical databases

ED Decision 2017/003/R

AERONAUTICAL DATABASE APPLICATIONS

- (a) Applications using aeronautical databases for which Type 2 DAT providers should be certified in accordance with Regulation (EU) 2017/373 may be found in GM1 DAT.OR.100.

- (b) The certification of a Type 2 DAT provider in accordance with Regulation (EU) 2017/373 ensures data integrity and compatibility with the certified aircraft application/equipment.

GM2 CAT.IDE.H.355 Management of aeronautical databases

ED Decision 2017/003/R

TIMELY DISTRIBUTION

The operator should distribute current and unaltered aeronautical databases to all aircraft requiring them in accordance with the validity period of the databases or in accordance with a procedure established in the operations manual if no validity period is defined.

GM3 CAT.IDE.H.355 Management of aeronautical databases

ED Decision 2017/003/R

STANDARDS FOR AERONAUTICAL DATABASES AND DAT PROVIDERS

- (a) A 'Type 2 DAT provider' is an organisation as defined in Article 2(5)(b) of Regulation (EU) 2017/373.
- (b) Equivalent to a certified 'Type 2 DAT provider' is defined in any Aviation Safety Agreement between the European Union and a third country, including any Technical Implementation Procedures, or any Working Arrangements between EASA and the competent authority of a third country.

ANNEX V (PART-SPA)

SUBPART A: GENERAL REQUIREMENTS

SPA.GEN.100 Competent authority

Regulation (EU) 2019/1384

- (a) The competent authority for issuing a specific approval shall be:
- (1) for the commercial operator, the authority of the Member State in which the operator has its principal place of business;
 - (2) for the non-commercial operator, the authority of the State in which the operator has its principal place of business, is established or is residing.
- (b) Notwithstanding point (a)(2), for the non-commercial operator using aircraft registered in a third country, the applicable requirements under this Annex for the approval of the following operations shall not apply if those approvals are issued by a third-country State of Registry:
- (1) performance-based navigation (PBN);
 - (2) minimum operational performance specifications (MNPS);
 - (3) reduced vertical separation minima (RVSM) airspace;
 - (4) low visibility operations (LVO).

GM1 SPA.GEN.100(a) Competent authority

ED Decision 2019/019/R

DETERMINING THE PLACE WHERE AN OPERATOR IS RESIDING

For the purpose of Regulation (EU) No 965/2012, the concept of ‘place where the operator is residing’ is mainly addressed to a natural person.

The place where the operator resides is the place where the operator complies with his or her tax obligations.

Several criteria can be used to help determining a person’s place of residence. These include, for example:

- (a) the duration of a person’s presence on the territory of the countries concerned;
- (b) the person’s family status and ties;
- (c) the person’s housing situation and how permanent it is;
- (d) the place where the person pursues professional or non-profit activities;
- (e) the characteristics of the person’s professional activity; and
- (f) the Member State where the person resides for taxation purposes.

SPA.GEN.105 Application for a specific approval

Regulation (EU) No 71/2014

- (a) The operator applying for the initial issue of a specific approval shall provide to the competent authority the documentation required in the applicable Subpart, together with the following information:
 - (1) the name, address and mailing address of the applicant;
 - (2) a description of the intended operation.
- (b) The operator shall provide the following evidence to the competent authority:
 - (1) compliance with the requirements of the applicable Subpart;
 - (2) that the relevant elements defined in the mandatory part of the operational suitability data established in accordance with Regulation (EU) No 748/2012 are taken into account.
- (c) The operator shall retain records relating to (a) and (b) at least for the duration of the operation requiring a specific approval, or, if applicable, in accordance with Annex III (Part-ORO).

AMC1 SPA.GEN.105(a) Application for a specific approval

ED Decision 2013/020/R

DOCUMENTATION

- (a) Operating procedures should be documented in the operations manual.
- (b) If an operations manual is not required, operating procedures may be described in a manual specifying procedures (procedures manual). If the aircraft flight manual (AFM) or the pilot operating handbook (POH) contains such procedures, they should be considered as acceptable means to document the procedures.

SPA.GEN.110 Privileges of an operator holding a specific approval

Regulation (EU) No 800/2013

The scope of the activity that an operator is approved to conduct shall be documented and specified:

- (a) for operators holding an air operator certificate (AOC) in the operations specifications to the AOC;
- (b) for all other operators in the list of specific approvals.

SPA.GEN.115 Changes to a specific approval

Regulation (EU) No 965/2012

When the conditions of a specific approval are affected by changes, the operator shall provide the relevant documentation to the competent authority and obtain prior approval for the operation.

SPA.GEN.120 Continued validity of a specific approval

Regulation (EU) No 71/2014

Specific approvals shall be issued for an unlimited duration and shall remain valid subject to the operator remaining in compliance with the requirements associated with the specific approval and taking into account the relevant elements defined in the mandatory part of the operational suitability data established in accordance with Regulation (EU) No 748/2012.

SUBPART B: PERFORMANCE-BASED NAVIGATION (PBN) OPERATIONS

SPA.PBN.100 PBN operations

Regulation (EU) 2016/1199

- (a) An approval is required for each of the following PBN specifications:
 - (1) RNP AR APCH; and
 - (2) RNP 0.3 for helicopter operation.
- (b) An approval for RNP AR APCH operations shall allow operations on public instrument approach procedures which meet the applicable ICAO procedure design criteria.
- (c) A procedure-specific approval for RNP AR APCH or RNP 0.3 shall be required for private instrument approach procedures or any public instrument approach procedure that does not meet the applicable ICAO procedure design criteria, or where required by the Aeronautical Information Publication (AIP) or the competent authority.

GM1 SPA.PBN.100 PBN operations

ED Decision 2016/020/R

GENERAL

- (a) PBN operations are based on performance requirements, which are expressed in navigation specifications (RNAV specification and RNP specification) in terms of accuracy, integrity, continuity, availability and functionality needed for the proposed operation in the context of a particular airspace concept.

Table 1 provides a simplified overview of:

- (1) PBN specifications and their applicability for different phases of flight; and
 - (2) PBN specifications requiring a specific approval.
- (b) More detailed guidance material for the operational use of PBN applications can be found in ICAO Doc 9613 Performance-Based Navigation (PBN) Manual.
- (c) Guidance material for the design of RNP AR APCH procedures can be found in ICAO Doc 9905 RNP AR Procedure Design Manual.
- (d) Guidance material for the operational approval of PBN operations can be found in ICAO Doc 9997 Performance-Based Navigation (PBN) Operational Approval Manual.

Table 1: Overview of PBN specifications

	FLIGHT PHASE							
	En-route		Arrival	Approach				Departure
	Oceanic	Continental		Initial	Intermediate	Final	Missed	
RNAV 10	10							
RNAV 5		5	5					
RNAV 2		2	2					2
RNAV 1		1	1	1	1		1	1
RNP 4	4							
RNP 2	2	2						
RNP 1			1	1	1		1	1
A-RNP	2	2 or 1	1-0.3	1-0.3	1-0.3	0.3	1-0.3	1-0.3
RNP APCH (LNAV)				1	1	0.3	1	
RNP APCH (LNAV/VNAV)				1	1	0.3	1	
RNP APCH (LP)				1	1		1	
RNP APCH (LPV)				1	1		1	
RNP AR APCH				1-0.1	1-0.1	0.3-0.1	1-0.1	
RNP 0.3 (H)		0.3	0.3	0.3	0.3		0.3	0.3

Numbers specify the accuracy level

no specific approval required

specific approval required

SPA.PBN.105 PBN operational approval

Regulation (EU) 2016/1199

To obtain a PBN specific approval from the competent authority, the operator shall provide evidence that:

- (a) the relevant airworthiness approval, suitable for the intended PBN operation, is stated in the AFM or other document that has been approved by the certifying authority as part of an airworthiness assessment or is based on such approval;
- (b) a training programme for the flight crew members and relevant personnel involved in the flight preparation has been established;
- (c) a safety assessment has been carried out;
- (d) operating procedures have been established specifying:
 - (1) the equipment to be carried, including its operating limitations and appropriate entries in the minimum equipment list (MEL);
 - (2) flight crew composition, qualification and experience;
 - (3) normal, abnormal and contingency procedures; and
 - (4) electronic navigation data management;
- (e) a list of reportable events has been specified; and
- (f) a management RNP monitoring programme has been established for RNP AR APCH operations, if applicable.

AMC1 SPA.PBN.105(b) PBN operational approval

ED Decision 2016/020/R

FLIGHT CREW TRAINING AND QUALIFICATIONS — GENERAL PROVISIONS

- (a) The operator should ensure that flight crew members training programmes for RNP AR APCH include structured courses of ground and FSTD training.
 - (1) Flight crew members with no RNP AR APCH experience should complete the full training programme prescribed in (b), (c), and (d) below.
 - (2) Flight crew members with RNP AR APCH experience with another EU operator may undertake an:
 - (i) abbreviated ground training course if operating a different type or class from that on which the previous RNP AR experience was gained;
 - (ii) abbreviated ground and FSTD training course if operating the same type or class and variant of the same type or class on which the previous RNP. AR experience was gained.
 - (iii) the abbreviated course should include at least the provisions of (d)(1), (c)(1) and (c)(2)(x) as appropriate.
 - (iv) The operator may reduce the number of approaches/landings required by (c)(2)(xii) if the type/class or the variant of the type or class has the same or similar:
 - (A) level of technology (flight guidance system (FGS));

- (B) operating procedures for navigation performance monitoring; and
 - (C) handling characteristicsas the previously operated type or class.
- (3) Flight crew members with RNP AR APCH experience with the operator may undertake an abbreviated ground and FSTD training course:
 - (i) when changing aircraft type or class, the abbreviated course should include at least the provisions of (d)(1), (c)(1), (c)(2);
 - (ii) when changing to a different variant of aircraft within the same type or class rating that has the same or similar of all of the following:
 - (A) level of technology (flight guidance system (FGS));
 - (B) operating procedures for navigation performance monitoring; and
 - (C) handling characteristicsas the previously operated type or class.

A difference course or familiarisation appropriate to the change of variant should fulfil the abbreviated course provisions.
 - (iii) when changing to a different variant of aircraft within the same type or class rating that has significantly different at least one of the following:
 - (A) level of technology (FGS);
 - (B) operating procedures for navigation performance monitoring; and
 - (C) handling characteristics,the provisions of (c)(1) and (c)(2) should be fulfilled.
- (4) The operator should ensure when undertaking RNP AR APCH operations with different variant(s) of aircraft within the same type or class rating, that the differences and/or similarities of the aircraft concerned justify such operations, taking into account at least the following:
 - (i) the level of technology, including the:
 - (A) FGS and associated displays and controls;
 - (B) FMS and its integration or not with the FGS; and
 - (C) on-board performance monitoring and alerting (OBPMA) system;
 - (ii) operating procedures, including:
 - (A) navigation performance monitoring;
 - (B) approach interruption and missed approach including while in turn along an RF leg;
 - (C) abnormal procedures in case of loss of system redundancy affecting the guidance or the navigation; and
 - (D) abnormal and contingency procedures in case of total loss of RNP capability; and

- (iii) handling characteristics, including:
 - (A) manual approach with RF leg;
 - (B) manual landing from automatic guided approach; and
 - (C) manual missed approach procedure from automatic approach.
- (b) Ground training
 - (1) Ground training for RNP AR APCH should address the following subjects during the initial introduction of a flight crew member to RNP AR APCH systems and operations. For recurrent programmes, the curriculum need only review initial curriculum items and address new, revised, or emphasised items.
 - (2) General concepts of RNP AR APCH operation
 - (i) RNP AR APCH training should cover RNP AR APCH systems theory to the extent appropriate to ensure proper operational use. Flight crew members should understand basic concepts of RNP AR APCH systems, operation, classifications, and limitations.
 - (ii) The training should include general knowledge and operational application of RNP AR APCH instrument approach procedures. This training module should in particular address the following specific elements:
 - (A) the definitions of RNAV, RNP, RNP APCH, RNP AR APCH, RAIM, and containment areas;
 - (B) the differences between RNP AR APCH and RNP APCH;
 - (C) the types of RNP AR APCH procedures and familiarity with the charting of these procedures;
 - (D) the programming and display of RNP and aircraft specific displays, e.g. actual navigation performance;
 - (E) the methods to enable and disable the navigation updating modes related to RNP;
 - (F) the RNP values appropriate for different phases of flight and RNP AR APCH instrument procedures and how to select, if necessary;
 - (G) the use of GNSS RAIM (or equivalent) forecasts and the effects of RAIM 'holes' on RNP AR APCH procedures availability;
 - (H) when and how to terminate RNP navigation and transfer to conventional navigation due to loss of RNP and/or required equipment;
 - (I) the method to determine if the navigation database is current and contains required navigational data;
 - (J) the explanation of the different components that contribute to the total system error and their characteristics, e.g. drift characteristics when using IRU with no radio updating, QNH mistakes;
 - (K) the temperature compensation: Flight crew members operating avionics systems with compensation for altimetry errors introduced by deviations from ISA may disregard the temperature limits on RNP AR APCH procedures if flight crew training on use of the temperature compensation function is

- provided by the operator and the compensation function is utilised by the crew. However, the training should also recognise if the temperature compensation by the system is applicable to the VNAV guidance and is not a substitute for the flight crew compensating for the temperature effects on minimum altitudes or the DA/H;
- (L) the effect of wind on aircraft performance during RNP AR APCH operations and the need to positively remain within RNP containment area, including any operational wind limitation and aircraft configuration essential to safely complete an RNP AR APCH operation;
 - (M) the effect of groundspeed on compliance with RNP AR APCH procedures and bank angle restrictions that may impact on the ability to remain on the course centreline. For RNP procedures, aircraft are expected to maintain the standard speeds associated with the applicable category unless more stringent constraints are published;
 - (N) the relationship between RNP and the appropriate approach minima line on an approved published RNP AR APCH procedure and any operational limitations if the available RNP degrades or is not available prior to an approach (this should include flight crew operating procedures outside the FAF versus inside the FAF);
 - (O) understanding alerts that may occur from the loading and use of improper RNP values for a desired segment of an RNP AR APCH procedure;
 - (P) understanding the performance requirement to couple the autopilot/flight director to the navigation system's lateral guidance on RNP AR APCH procedures requiring an RNP of less than RNP 0.3;
 - (Q) the events that trigger a missed approach when using the aircraft's RNP capability to complete an RNP AR APCH procedure;
 - (R) any bank angle restrictions or limitations on RNP AR APCH procedures;
 - (S) ensuring flight crew members understand the performance issues associated with reversion to radio updating, know any limitations on the use of DME and VOR updating; and
 - (T) the familiarisation with the terrain and obstacles representations on navigation displays and approach charts.
- (3) ATC communication and coordination for use of RNP AR APCH
- (i) Ground training should instruct flight crew members on proper flight plan classifications and any ATC procedures applicable to RNP AR APCH operations.
 - (ii) Flight crew members should receive instruction on the need to advise ATC immediately when the performance of the aircraft's navigation system is no longer adequate to support continuation of an RNP AR APCH operation.
- (4) RNP AR APCH equipment components, controls, displays, and alerts
- (i) Theoretical training should include discussion of RNP terminology, symbology, operation, optional controls, and display features, including any items unique to an operator's implementation or systems. The training should address applicable failure alerts and limitations.

-
- (ii) Flight crew members should achieve a thorough understanding of the equipment used in RNP operations and any limitations on the use of the equipment during those operations.
 - (iii) Flight crew members should also know what navigation sensors form the basis for their RNP AR APCH compliance, and they should be able to assess the impact of failure of any avionics or a known loss of ground systems on the remainder of the flight plan.
- (5) AFM information and operating procedures
- (i) Based on the AFM or other aircraft eligibility evidence, the flight crew should address normal and abnormal operating procedures, responses to failure alerts, and any limitations, including related information on RNP modes of operation.
 - (ii) Training should also address contingency procedures for loss or degradation of the RNP AR APCH capability.
 - (iii) The manuals used by the flight should contain this information.
- (6) MEL operating provisions
- (i) Flight crew members should have a thorough understanding of the MEL entries supporting RNP AR APCH operations.
- (c) Initial FSTD training
- (1) In addition to ground training, flight crew members should receive appropriate practical skill training in an FSTD.
- (i) Training programmes should cover the proper execution of RNP AR APCH operations in compliance with the manufacturer's documentation.
 - (ii) The training should include:
 - (A) RNP AR APCH procedures and limitations;
 - (B) standardisation of the set-up of the cockpit's electronic displays during an RNP AR APCH operation;
 - (C) recognition of the aural advisories, alerts and other annunciations that can impact on compliance with an RNP AR APCH procedure; and
 - (D) the timely and correct responses to loss of RNP AR APCH capability in a variety of scenarios embracing the breadth of the RNP AR APCH procedures the operator plans to complete.
- (2) FSTD training should address the following specific elements:
- (i) procedures for verifying that each flight crew member's altimeter has the current setting before commencing the final approach of an RNP AR APCH operation, including any operational limitations associated with the source(s) for the altimeter setting and the latency of checking and setting the altimeters for landing;
 - (ii) use of aircraft RADAR, TAWS or other avionics systems to support the flight crew's track monitoring and weather and obstacle avoidance;
 - (iii) concise and complete flight crew briefings for all RNP AR APCH procedures and the important role crew resource management (CRM) plays in successfully completing an RNP AR APCH operation;

- (iv) the importance of aircraft configuration to ensure the aircraft maintains any mandated speeds during RNP AR APCH operations;
- (v) the potentially detrimental effect of reducing the flap setting, reducing the bank angle or increasing airspeeds may have on the ability to comply with an RNP AR APCH operation;
- (vi) flight crew members understand and are capable of programming and/or operating the FMC, autopilot, autothrottles, RADAR, GNSS, INS, EFIS (including the moving map), and TAWS in support of RNP AR APCH operations;
- (vii) handling of TOGA to LNAV transition as applicable, particularly while in turn;
- (viii) monitoring of flight technical error (FTE) and related go-around operation;
- (ix) handling of loss of GNSS signals during a procedure;
- (x) handling of engine failure during the approach operation;
- (xi) applying contingency procedures for a loss of RNP capability during a missed approach. Due to the lack of navigation guidance, the training should emphasise the flight crew contingency actions that achieve separation from terrain and obstacles. The operator should tailor these contingency procedures to their specific RNP AR APCH procedures; and
- (xii) as a minimum, each flight crew member should complete two RNP approach procedures for each duty position (pilot flying and pilot monitoring) that employ the unique RNP AR APCH characteristics of the operator's RNP AR APCH procedures (e.g. RF legs, missed approach). One procedure should culminate in a transition to landing and one procedure should culminate in execution of an RNP missed approach procedure.

FLIGHT CREW TRAINING AND QUALIFICATIONS — CONVERSION TRAINING

- (d) Flight crew members should complete the following RNP AR APCH training if converting to a new type or class or variant of aircraft in which RNP AR operations will be conducted. For abbreviated courses, the provisions prescribed in (a)(2), (a)(3) and (a)(4) should apply.
 - (1) Ground training

Taking into account the flight crew member's RNP AR APCH previous training and experience, flight crew members should undertake an abbreviated ground training that should include at least the provisions of (b)(2)(D) to (I), (b)(2)(N) to (R), (b)(2)(S), and (b)(3) to (6).
 - (2) FSTD training

The provisions prescribed in (a) should apply, taking into account the flight crew member's RNP AR APCH training and experience.

FLIGHT CREW TRAINING AND QUALIFICATIONS — RNP AR APCH PROCEDURES REQUIRING A PROCEDURE-SPECIFIC APPROVAL

- (e) Before starting an RNP AR APCH procedure for which a procedure-specific approval is required, flight crew members should undertake additional ground training and FSTD training, as appropriate.
 - (1) The operator should ensure that the additional training programmes for such procedures include as at least all of the following:

- (i) the provisions of (c)(1), (c)(2)(x) as appropriate and customised to the intended operation;
 - (ii) the crew training recommendations and mitigations stated in the procedure flight operational safety assessment (FOSA); and
 - (iii) specific training and operational provision published in the AIP, where applicable.
- (2) Flight crew members with prior experience of RNP AR APCH procedures for which a procedure-specific approval is required may receive credit for all or part of these provisions provided the current operator's RNP AR APCH procedures are similar and require no new pilot skills to be trained in an FSTD.
- (3) Training and checking may be combined and conducted by the same person with regard to (f)(2).
- (4) In case of a first RNP AR APCH application targeting directly RNP AR APCH procedures requiring procedure-specific approvals, a combined initial and additional training and checking, as appropriate, should be acceptable provided the training and checking includes all provisions prescribed by (a), (b), (c), (d) as appropriate, (e) and (f).

FLIGHT CREW TRAINING AND QUALIFICATIONS — CHECKING OF RNP AR APCH KNOWLEDGE

- (f) Initial checking of RNP AR APCH knowledge and procedures
- (1) The operator should check flight crew members' knowledge of RNP AR APCH procedures prior to employing RNP AR APCH operations. As a minimum, the check should include a thorough review of flight crew procedures and specific aircraft performance requirements for RNP AR APCH operations.
- (2) The initial check should include one of the following:
- (i) A check by an examiner using an FSTD.
 - (ii) A check by a TRE, CRE, SFE or a commander nominated by the operator during LPCs, OPCs or line flights that incorporate RNP AR APCH operations that employ the unique RNP AR APCH characteristics of the operator's RNP AR APCH procedures.
 - (iii) Line-oriented flight training (LOFT)/line-oriented evaluation (LOE). LOFT/LOE programmes using an FSTD that incorporates RNP AR APCH operations that employ the unique RNP AR APCH characteristics (i.e. RF legs, RNP missed approach) of the operator's RNP AR APCH procedures.
- (3) Specific elements that should be addressed are:
- (i) demonstration of the use of any RNP AR APCH limits/minimums that may impact various RNP AR APCH operations;
 - (ii) demonstration of the application of radio-updating procedures, such as enabling and disabling ground-based radio updating of the FMC (e.g. DME/DME and VOR/DME updating) and knowledge of when to use this feature;
 - (iii) demonstration of the ability to monitor the actual lateral and vertical flight paths relative to programmed flight path and complete the appropriate flight crew procedures when exceeding a lateral or vertical FTE limit;
 - (iv) demonstration of the ability to read and adapt to a RAIM (or equivalent) forecast, including forecasts predicting a lack of RAIM availability;

- (v) demonstration of the proper set-up of the FMC, the weather RADAR, TAWS, and moving map for the various RNP AR APCH operations and scenarios the operator plans to implement;
- (vi) demonstration of the use of flight crew briefings and checklists for RNP AR APCH operations with emphasis on CRM;
- (vii) demonstration of knowledge of and ability to perform an RNP AR APCH missed approach procedure in a variety of operational scenarios (i.e. loss of navigation or failure to acquire visual conditions);
- (viii) demonstration of speed control during segments requiring speed restrictions to ensure compliance with an RNP AR APCH procedure;
- (ix) demonstration of competent use of RNP AR APCH plates, briefing cards, and checklists;
- (x) demonstration of the ability to complete a stable RNP AR APCH operation: bank angle, speed control, and remaining on the procedure's centreline; and
- (xi) knowledge of the operational limit for deviation from the desired flight path and of how to accurately monitor the aircraft's position relative to vertical flight path.

FLIGHT CREW TRAINING AND QUALIFICATIONS — RECURRENT TRAINING

- (g) The operator should incorporate recurrent training that employs the unique RNP AR APCH characteristics of the operator's RNP AR APCH procedures as part of the overall training programme.
 - (1) A minimum of two RNP AR APCH should be flown by each flight crew member, one for each duty position (pilot flying and pilot monitoring), with one culminating in a landing and one culminating in a missed approach, and may be substituted for any required 3D approach operation.
 - (2) In case of several procedure-specific RNP AR APCH approvals, the recurrent training should focus on the most demanding RNP AR APCH procedures giving credit on the less demanding ones.

TRAINING FOR PERSONNEL INVOLVED IN THE FLIGHT PREPARATION

- (h) The operator should ensure that training for flight operation officers/dispatchers should include:
 - (1) the different types of RNP AR APCH procedures;
 - (2) the importance of specific navigation equipment and other equipment during RNP AR APCH operations and related RNP AR APCH requirements and operating procedures;
 - (3) the operator's RNP AR APCH approvals;
 - (4) MEL requirements;
 - (5) aircraft performance, and navigation signal availability, e.g. GNSS RAIM/predictive RNP capability tool, for destination and alternate aerodromes.

AMC1 SPA.PBN.105(c) PBN operational approval

ED Decision 2016/020/R

FLIGHT OPERATIONAL SAFETY ASSESSMENT (FOSA)

- (a) For each RNP AR APCH procedure, the operator should conduct a flight operational safety assessment (FOSA) proportionate to the complexity of the procedure.
- (b) The FOSA should be based on:
 - (1) restrictions and recommendations published in AIPs;
 - (2) the flyability check;
 - (3) an assessment of the operational environment;
 - (4) the demonstrated navigation performance of the aircraft; and
 - (5) the operational aircraft performance.
- (c) The operator may take credit from key elements from the safety assessment carried out by the ANSP or the aerodrome operator.

GM1 SPA.PBN.105(c) PBN operational approval

ED Decision 2016/020/R

FLIGHT OPERATIONAL SAFETY ASSESSMENT (FOSA)

- (a) Traditionally, operational safety has been defined by a target level of safety (TLS) and specified as a risk of collision of 10^{-7} per approach operation. For RNP AR APCH operations, conducting the FOSA methodology contributes to achieving the TLS. The FOSA is intended to provide a level of flight safety that is equivalent to the traditional TLS, but using methodology oriented to performance-based flight operations. Using the FOSA, the operational safety objective is met by considering more than the aircraft navigation system alone. The FOSA blends quantitative and qualitative analyses and assessments by considering navigation systems, aircraft performance, operating procedures, human factor aspects and the operational environment. During these assessments conducted under normal and failure conditions, hazards, risks and the associated mitigations are identified. The FOSA relies on the detailed criteria for the aircraft capabilities and instrument procedure design to address the majority of general technical, procedure and process factors. Additionally, technical and operational expertise and prior operator experience with RNP AR APCH operations are essential elements to be considered in the conduct and conclusion of the FOSA.
- (b) The following aspects need to be considered during FOSA, in order to identify hazards, risks and mitigations relevant to RNP AR APCH operations:
 - (1) Normal performance: lateral and vertical accuracy are addressed in the aircraft airworthiness standards, aircraft and systems operate normally in standard configurations and operating modes, and individual error components are monitored/truncated through system design or flight crew procedure.
 - (2) Performance under failure conditions: lateral and vertical accuracy are evaluated for aircraft failures as part of the aircraft certification. Additionally, other rare-normal and abnormal failures and conditions for ATC operations, flight crew procedures, infrastructure and operating environment are assessed. Where the failure or condition results are not acceptable for continued operation, mitigations are developed or limitations established for the aircraft, flight crew and/or operation.

-
- (3) Aircraft failures
- (i) System failure: Failure of a navigation system, flight guidance system, flight instrument system for the approach, or missed approach (e.g. loss of GNSS updating, receiver failure, autopilot disconnect, FMS failure, etc.). Depending on the aircraft, this may be addressed through aircraft design or operating procedure to cross-check guidance (e.g. dual equipage for lateral errors, use of terrain awareness and warning system).
 - (ii) Malfunction of air data system or altimetry: flight crew procedure cross-check between two independent systems may mitigate this risk.
- (4) Aircraft performance
- (i) Inadequate performance to conduct the approach operation: the aircraft capabilities and operating procedures ensure that the performance is adequate on each approach, as part of flight planning and in order to begin or continue the approach. Consideration should be given to aircraft configuration during approach and any configuration changes associated with a missed approach operation (e.g. engine failure, flap retraction, re-engagement of autopilot in LNAV mode).
 - (ii) Loss of engine: loss of an engine while on an RNP AR APCH operation is a rare occurrence due to high engine reliability and the short exposure time. The operator needs to take appropriate action to mitigate the effects of loss of engine, initiating a go-around and manually taking control of the aircraft if necessary.
- (5) Navigation services
- (i) Use of a navigation aid outside of designated coverage or in test mode: aircraft airworthiness standards and operating procedures have been developed to address this risk.
 - (ii) Navigation database errors: instrument approach procedures are validated through flight validation specific to the operator and aircraft, and the operator should have a process defined to maintain validated data through updates to the navigation database.
- (6) ATC operations
- (i) Procedure assigned to non-approved aircraft: flight crew are responsible for rejecting the clearance.
 - (ii) ATC provides 'direct to' clearance to or vectors aircraft onto approach such that performance cannot be achieved.
 - (iii) Inconsistent ATC phraseology between controller and flight crew.
- (7) Flight crew operations
- (i) Erroneous barometric altimeter setting: flight crew entry and cross-check procedures may mitigate this risk.
 - (ii) Incorrect procedure selection or loading: flight crew procedures should be available to verify that the loaded procedure matches the published procedure, line of minima and aircraft airworthiness qualification.
 - (iii) Incorrect flight control mode selected: training on importance of flight control mode, flight crew procedure to verify selection of correct flight control mode.

- (iv) Incorrect RNP entry: flight crew procedure to verify RNP loaded in system matches the published value.
 - (v) Missed approach: balked landing or rejected landing at or below DA/H.
 - (vi) Poor meteorological conditions: loss or significant reduction of visual reference that may result in a go-around.
- (8) Infrastructure
- (i) GNSS satellite failure: this condition is evaluated during aircraft qualification to ensure obstacle clearance can be maintained, considering the low likelihood of this failure occurring.
 - (ii) Loss of GNSS signals: relevant independent equipment, e.g. IRS/INS, is mandated for RNP AR APCH procedures with RF legs and approaches where the accuracy for the missed approach is less than 1 NM. For other approaches, operating procedures are used to approximate the published track and climb above obstacles.
 - (iii) Testing of ground navigation aids in the vicinity of the approach: aircraft and operating procedures should detect and mitigate this event.
- (9) Operating conditions
- (i) Tailwind conditions: excessive speed on RF legs may result in inability to maintain track. This is addressed through aircraft airworthiness standards on the limits of command guidance, inclusion of 5 degrees of bank manoeuvrability margin, consideration of speed effect and flight crew procedure to maintain speeds below the maximum authorised for the RNP AR APCH procedure.
 - (ii) Wind conditions and effect on FTE: nominal FTE is evaluated under a variety of wind conditions, and flight crew procedures to monitor and limit deviations to ensure safe operation.
 - (iii) Extreme temperature effects of barometric altitude (e.g. extreme cold temperatures, known local atmospheric or weather phenomena, high winds, severe turbulence, etc.): the effect of this error on the vertical path is mitigated through the procedure design and flight crew procedures, with an allowance for aircraft that compensate for this effect to conduct procedures regardless of the published temperature limit. The effect of this error on minimum segment altitudes and the DA/H are addressed in an equivalent manner to all other approach operations.

AMC1 SPA.PBN.105(d) PBN operational approval

ED Decision 2016/020/R

OPERATIONAL CONSIDERATIONS FOR RNP AR APCH

- (a) MEL
- (1) The operator's MEL should be developed/revised to address the equipment provisions for RNP AR APCH operations.
 - (2) An operational TAWS Class A should be available for all RNP AR APCH operations. The TAWS should use altitude values that are compensated for local pressure and temperature effects (e.g. corrected barometric and GNSS altitude), and include significant terrain and obstacle data.

- (b) Autopilot and flight director
 - (1) For RNP AR APCH operations with RNP values less than RNP 0.3 or with RF legs, the autopilot or flight director driven by the area navigation system should be used. Thus, the flight crew should check that the autopilot/flight director is installed and operational.
- (c) Preflight RNP assessment
 - (1) The operator should have a predictive performance capability, which can determine if the specified RNP will be available at the time and location of a desired RNP operation. This capability can be a ground service and need not be resident in the aircraft's avionics equipment. The operator should establish procedures requiring use of this capability as both a preflight preparation tool and as a flight-following tool in the event of reported failures.
 - (2) This predictive capability should account for known and predicted outages of GNSS satellites or other impacts on the navigation system's sensors. The prediction programme should not use a mask angle below 5 degrees, as operational experience indicates that satellite signals at low elevations are not reliable. The prediction should use the actual GNSS constellation with the RAIM (or equivalent) algorithm identical to or more conservative than that used in the actual equipment.
 - (3) The RNP assessment should consider the specific combination of the aircraft capability (sensors and integration), as well as their availability.
- (d) NAVAID exclusion
 - (1) The operator should establish procedures to exclude NAVAID facilities in accordance with NOTAMs (e.g. DMEs, VORs, localisers). Internal avionics reasonableness checks may not be adequate for RNP operations.
- (e) Navigation database currency
 - (1) During system initialisation, the flight crew should confirm that the navigation database is current. Navigation databases should be current for the duration of the flight. If the AIRAC cycle is due to change during flight, the flight crew should follow procedures established by the operator to ensure the accuracy of navigation data.
 - (2) The operator should not allow the flight crew to use an expired database.

AMC2 SPA.PBN.105(d) PBN operational approval

ED Decision 2016/020/R

FLIGHT CONSIDERATIONS

(a) Modification of flight plan

The flight crew should not be authorised to fly a published RNP AR APCH procedure unless it is retrievable by the procedure name from the aircraft navigation database and conforms to the charted procedure. The lateral path should not be modified; with the exception of accepting a clearance to go direct to a fix in the approach procedure that is before the FAF and that does not immediately precede an RF leg. The only other acceptable modification to the loaded procedure is to change altitude and/or airspeed waypoint constraints on the initial, intermediate, or missed approach segments flight plan fixes (e.g. to apply temperature corrections or comply with an ATC clearance/instruction).

(b) Mandatory equipment

The flight crew should have either a mandatory list of equipment for conducting RNP AR APCH operations or alternate methods to address in-flight equipment failures that would prohibit RNP AR APCH operations (e.g. crew warning systems, quick reference handbook).

(c) RNP management

Operating procedures should ensure that the navigation system uses the appropriate RNP values throughout the approach operation. If the navigation system does not extract and set the navigation accuracy from the on-board navigation database for each segment of the procedure, then operating procedures should ensure that the smallest navigation accuracy required to complete the approach or the missed approach is selected before initiating the approach operation (e.g. before the IAF). Different IAFs may have different navigation accuracy, which are annotated on the approach chart.

(d) Loss of RNP

The flight crew should ensure that no loss of RNP annunciation is received prior to commencing the RNP AR APCH operation. During the approach operation, if at any time a loss of RNP annunciation is received, the flight crew should abandon the RNP AR APCH operation unless the pilot has in sight the visual references required to continue the approach operation.

(e) Radio updating

Initiation of all RNP AR APCH procedures is based on GNSS updating. The flight crew should comply with the operator's procedures for inhibiting specific facilities.

(f) Approach procedure confirmation

The flight crew should confirm that the correct procedure has been selected. This process includes confirmation of the waypoint sequence, reasonableness of track angles and distances, and any other parameters that can be altered by the flight crew, such as altitude or speed constraints. A navigation system textual display or navigation map display should be used.

(g) Track deviation monitoring

(1) The flight crew should use a lateral deviation indicator, flight director and/or autopilot in lateral navigation mode on RNP AR APCH operations. The flight crew of an aircraft with a lateral deviation indicator should ensure that lateral deviation indicator scaling (full-scale deflection) is suitable for the navigation accuracy associated with the various segments of the RNP AR APCH procedure. The flight crew is expected to maintain procedure centrelines, as depicted by on-board lateral deviation indicators and/or flight guidance during the entire RNP AR APCH operations unless authorised to deviate by ATC or demanded under emergency conditions. For normal operations, cross-track error/deviation (the difference between the area-navigation-system-computed path and the aircraft position relative to the path) should be limited to the navigation accuracy (RNP) associated with the procedure segment.

(2) Vertical deviation should be monitored above and below the glide-path; the vertical deviation should be within ± 75 ft of the glide-path during the final approach segment.

(3) Flight crew should execute a missed approach operation if:

(i) the lateral deviation exceeds one time the RNP value; or

(ii) the deviation below the vertical path exceeds 75 ft or half-scale deflection where angular deviation is indicated, at any time; or

- (iii) the deviation above the vertical path exceeds 75 ft or half-scale deflection where angular deviation is indicated; at or below 1 000 ft above aerodrome level;
unless the pilot has in sight the visual references required to continue the approach operation.
- (4) Where a moving map, low-resolution vertical deviation indicator (VDI), or numeric display of deviations are to be used, flight crew training and procedures should ensure the effectiveness of these displays. Typically, this involves demonstration of the procedure with a number of trained flight crew members and inclusion of this monitoring procedure in the recurrent RNP AR APCH training programme.
- (5) For installations that use a CDI for lateral path tracking, the AFM should state which navigation accuracy and operations the aircraft supports and the operational effects on the CDI scale. The flight crew should know the CDI full-scale deflection value. The avionics may automatically set the CDI scale (dependent on phase of flight) or the flight crew may manually set the scale. If the flight crew manually selects the CDI scale, the operator should have procedures and training in place to assure the selected CDI scale is appropriate for the intended RNP operation. The deviation limit should be readily apparent given the scale (e.g. full-scale deflection).
- (h) System cross-check
 - (1) The flight crew should ensure the lateral and vertical guidance provided by the navigation system is consistent.
- (i) Procedures with RF legs
 - (1) When initiating a missed approach operation during or shortly after the RF leg, the flight crew should be aware of the importance of maintaining the published path as closely as possible. Operating procedures should be provided for aircraft that do not stay in LNAV when a missed approach is initiated to ensure the RNP AR APCH ground track is maintained.
 - (2) The flight crew should not exceed the maximum airspeed values shown in Table 1 throughout the RF leg. For example, a Category C A320 should slow to 160 KIAS at the FAF or may fly as fast as 185 KIAS if using Category D minima. A missed approach operation prior to DA/H may require compliance with speed limitation for that segment.

Table 1: Maximum airspeed by segment and category

Segment	Indicated airspeed (Knots)				
	Indicated airspeed by aircraft category				
	Cat A	Cat B	Cat C	Cat D	Cat E
Initial & intermediate (IAF to FAF)	150	180	240	250	250
Final (FAF to DA)	100	130	160	185	as specified
Missed approach (DA/H to MAHP)	110	150	240	265	as specified
Airspeed restriction*	as specified				

* Airspeed restrictions may be used to reduce turn radius regardless of aircraft category.

- (j) Temperature compensation
For aircraft with temperature compensation capabilities, the flight crew may disregard the temperature limits on RNP procedures if the operator provides pilot training on the use of the temperature compensation function. It should be noted that a temperature compensation by

the system is applicable to the VNAV guidance and is not a substitute for the flight crew compensating for temperature effects on minimum altitudes or DA/H. The flight crew should be familiar with the effects of the temperature compensation on intercepting the compensated path as described in EUROCAE ED-75C/RTCA DO-236C Appendix H.

(k) Altimeter setting

Due to the performance-based obstruction clearance inherent in RNP instrument procedures, the flight crew should verify that the most current aerodrome altimeter is set prior to the FAF. The operator should take precautions to switch altimeter settings at appropriate times or locations and request a current altimeter setting if the reported setting may not be recent, particularly at times when pressure is reported or expected to be rapidly decreasing. Execution of an RNP operation necessitates the current altimeter setting for the aerodrome of intended landing. Remote altimeter settings should not be allowed.

(l) Altimeter cross-check

- (1) The flight crew should complete an altimetry cross-check ensuring both pilots' altimeters agree within ± 100 ft prior to the FAF but no earlier than when the altimeters are set for the aerodrome of intended landing. If the altimetry cross-check fails, then the approach operation should not be continued.
- (2) This operational cross-check should not be necessary if the aircraft systems automatically compare the altitudes to within 75 ft.

(m) Missed approach operation

Where possible, the missed approach operation should necessitate RNP 1.0. The missed approach portion of these procedures should be similar to a missed approach of an RNP APCH procedure. Where necessary, navigation accuracy less than RNP 1.0 may be used in the missed approach segment.

- (1) In many aircraft, executing a missed approach activating take-off/go-around (TOGA) may cause a change in lateral navigation. In many aircraft, activating TOGA disengages the autopilot and flight director from LNAV guidance, and the flight director reverts to track-hold derived from the inertial system. LNAV guidance to the autopilot and flight director should be re-engaged as quickly as possible.
- (2) Flight crew procedures and training should address the impact on navigation capability and flight guidance if the pilot initiates a missed approach while the aircraft is in a turn. When initiating an early missed approach operation, the flight crew should follow the rest of the approach track and missed approach track unless a different clearance has been issued by ATC. The flight crew should also be aware that RF legs are designed based on the maximum true airspeed at normal altitudes, and initiating an early missed approach operation will reduce the manoeuvrability margin and potentially even make holding the turn impractical at missed approach speeds.

(n) Contingency procedures

(1) Failure while en route

The flight crew should be able to assess the impact of GNSS equipment failure on the anticipated RNP AR APCH operation and take appropriate action.

(2) Failure on approach

The operator's contingency procedures should address at least the following conditions:

- (i) failure of the area navigation system components, including those affecting lateral and vertical deviation performance (e.g. failures of a GPS sensor, the flight director or autopilot);
- (ii) loss of navigation signal-in-space (loss or degradation of external signal).

AMC3 SPA.PBN.105(d) PBN operational approval

ED Decision 2016/020/R

NAVIGATION DATABASE MANAGEMENT

- (a) The operator should validate every RNP AR APCH procedure before using the procedure in instrument meteorological conditions (IMC) to ensure compatibility with their aircraft and to ensure the resulting path matches the published procedure. As a minimum, the operator should:
 - (1) compare the navigation data for the procedure(s) to be loaded into the FMS with the published procedure.
 - (2) validate the loaded navigation data for the procedure, either in an FSTD or in the actual aircraft in VMC. The depicted procedure on the map display should be compared to the published procedure. The entire procedure should be flown to ensure the path is flyable, does not have any apparent lateral or vertical path disconnects and is consistent with the published procedure.
 - (3) Once the procedure is validated, a copy of the validated navigation data should be retained for comparison with subsequent data updates.
 - (4) For published procedures, where FOSA demonstrated that the procedure is not in a challenging operational environment, the flight or FSTD validation may be credited from already validated equivalent RNP AR APCH procedures.
- (b) If an aircraft system required for RNP AR APCH operations is modified, the operator should assess the need for a validation of the RNP AR APCH procedures with the navigation database and the modified system. This may be accomplished without any direct evaluation if the manufacturer verifies that the modification has no effect on the navigation database or path computation. If no such assurance from the manufacturer is available, the operator should conduct initial data validation with the modified system.
- (c) The operator should implement procedures that ensure timely distribution and insertion of current and unaltered electronic navigation data to all aircraft that require it.

AMC1 SPA.PBN.105(e) PBN operational approval

ED Decision 2016/020/R

REPORTABLE EVENTS

The operator should report events which are listed in [AMC2 ORO.GEN.160](#).

AMC1 SPA.PBN.105(f) PBN operational approval

ED Decision 2016/020/R

RNP MONITORING PROGRAMME

- (a) The operator approved to conduct RNP AR APCH operations, should have an RNP monitoring programme to ensure continued compliance with applicable rules and to identify any negative trends in performance.
- (b) During an interim approval period, which should be at least 90 days, the operator should at least submit the following information every 30 days to the competent authority.
 - (1) Total number of RNP AR APCH operations conducted;
 - (2) Number of approach operations by aircraft/system which were completed as planned without any navigation or guidance system anomalies;
 - (3) Reasons for unsatisfactory approaches, such as:
 - (i) UNABLE REQ NAV PERF, NAV ACCUR DOWNGRAD, or other RNP messages during approaches;
 - (ii) excessive lateral or vertical deviation;
 - (iii) TAWS warning;
 - (iv) autopilot system disconnect;
 - (v) navigation data errors; or
 - (vi) flight crew reports of any anomaly;
 - (4) Flight crew comments.
- (c) Thereafter, the operator should continue to collect and periodically review this data to identify potential safety concerns, and maintain summaries of this data.

SUBPART C: OPERATIONS WITH SPECIFIED MINIMUM NAVIGATION PERFORMANCE (MNPS)

SPA.MNPS.100 MNPS operations

Regulation (EU) No 965/2012

Aircraft shall only be operated in designated minimum navigation performance specifications (MNPS) airspace in accordance with regional supplementary procedures, where minimum navigation performance specifications are established, if the operator has been granted an approval by the competent authority to conduct such operations.

GM1 SPA.MNPS.100 MNPS operations

ED Decision 2012/019/R

DOCUMENTATION

MNPS and the procedures governing their application are published in the Regional Supplementary Procedures, ICAO Doc 7030, as well as in national AIPs.

SPA.MNPS.105 MNPS operational approval

Regulation (EU) No 965/2012

To obtain an MNPS operational approval from the competent authority, the operator shall provide evidence that:

- (a) the navigation equipment meets the required performance;
- (b) navigation displays, indicators and controls are visible and operable by either pilot seated at his/her duty station;
- (c) a training programme for the flight crew members involved in these operations has been established;
- (d) operating procedures have been established specifying:
 - (1) the equipment to be carried, including its operating limitations and appropriate entries in the MEL;
 - (2) flight crew composition and experience requirements;
 - (3) normal procedures;
 - (4) contingency procedures including those specified by the authority responsible for the airspace concerned;
 - (5) monitoring and incident reporting.

AMC1 SPA.MNPS.105 MNPS operational approval

ED Decision 2012/019/R

LONG RANGE NAVIGATION SYSTEM (LRNS)

- (a) For unrestricted operation in MNPS airspace an aircraft should be equipped with two independent LRNSs.

- (b) An LRNS may be one of the following:
 - (1) one inertial navigation system (INS);
 - (2) one global navigation satellite system (GNSS); or
 - (3) one navigation system using the inputs from one or more inertial reference system (IRS) or any other sensor system complying with the MNPS requirement.
- (c) In case of the GNSS is used as a stand-alone system for LRNS, an integrity check should be carried out.
- (d) For operation in MNPS airspace along notified special routes the aeroplane should be equipped with one LRNS.

SUBPART D: OPERATIONS IN AIRSPACE WITH REDUCED VERTICAL SEPARATION MINIMA (RVSM)

SPA.RVSM.100 RVSM operations

Regulation (EU) No 965/2012

Aircraft shall only be operated in designated airspace where a reduced vertical separation minimum of 300 m (1 000 ft) applies between flight level (FL) 290 and FL 410, inclusive, if the operator has been granted an approval by the competent authority to conduct such operations.

SPA.RVSM.105 RVSM operational approval

Regulation (EU) No 965/2012

To obtain an RVSM operational approval from the competent authority, the operator shall provide evidence that:

- (a) the RVSM airworthiness approval has been obtained;
- (b) procedures for monitoring and reporting height-keeping errors have been established;
- (c) a training programme for the flight crew members involved in these operations has been established;
- (d) operating procedures have been established specifying:
 - (1) the equipment to be carried, including its operating limitations and appropriate entries in the MEL;
 - (2) flight crew composition and experience requirements;
 - (3) flight planning;
 - (4) pre-flight procedures;
 - (5) procedures prior to RVSM airspace entry;
 - (6) in-flight procedures;
 - (7) post-flight procedures;
 - (8) incident reporting;
 - (9) specific regional operating procedures.

AMC1 SPA.RVSM.105 RVSM operational approval

ED Decision 2017/009/R

CONTENT OF OPERATOR RVSM APPLICATION

The following material should be made available to the competent authority, in sufficient time to permit evaluation, before the intended start of RVSM operations:

- (a) Airworthiness documents

Documentation that shows that the aircraft has RVSM airworthiness approval. This should include an aircraft flight manual (AFM) amendment or supplement.

- (b) Description of aircraft equipment
A description of the aircraft appropriate to operations in an RVSM environment.
- (c) Training programmes, operating practices and procedures
The operator should submit training syllabi for initial and recurrent training programmes together with other relevant material. The material should show that the operating practices, procedures and training items, related to RVSM operations in airspace that requires State operational approval, are incorporated.
- (d) Manuals and checklists
The appropriate manuals and checklists should be revised to include information/guidance on standard operating procedures. Manuals should contain a statement of the airspeeds, altitudes and weights considered in RVSM aircraft approval, including identification of any operating limitations or conditions established for that aircraft type. Manuals and checklists may need to be submitted for review by the competent authority as part of the application process.
- (e) Past performance
Relevant operating history, where available, should be included in the application. The applicant should show that any required changes have been made in training, operating or maintenance practices to improve poor height-keeping performance.
- (f) Minimum equipment list
Where applicable, a minimum equipment list (MEL), adapted from the master minimum equipment list (MMEL), should include items pertinent to operating in RVSM airspace.
- (g) Plan for participation in verification/monitoring programmes
The operator should establish a plan for participation in any applicable verification/monitoring programme acceptable to the competent authority. This plan should include, as a minimum, a check on a sample of the operator's fleet by an regional monitoring agency (RMA)'s independent height-monitoring system.
- (h) Continuing airworthiness
Aircraft maintenance programme and continuing airworthiness procedures in support of the RVSM operations.

AMC2 SPA.RVSM.105 RVSM operational approval

ED Decision 2017/009/R

OPERATING PROCEDURES

- (a) Flight planning
- (1) During flight planning the flight crew should pay particular attention to conditions that may affect operation in RVSM airspace. These include, but may not be limited to:
- (i) verifying that the airframe is approved for RVSM operations;
 - (ii) reported and forecast weather on the route of flight;
 - (iii) minimum equipment requirements pertaining to height-keeping and alerting systems; and
 - (iv) any airframe or operating restriction related to RVSM operations.

(b) Pre-flight procedures

- (1) The following actions should be accomplished during the pre-flight procedure:
 - (i) Review technical logs and forms to determine the condition of equipment required for flight in the RVSM airspace. Ensure that maintenance action has been taken to correct defects to required equipment.
 - (ii) During the external inspection of aircraft, particular attention should be paid to the condition of static sources and the condition of the fuselage skin near each static source and any other component that affects altimetry system accuracy. This check may be accomplished by a qualified and authorised person other than the pilot (e.g. a flight engineer or ground engineer).
 - (iii) Before take-off, the aircraft altimeters should be set to the QNH (atmospheric pressure at nautical height) of the airfield and should display a known altitude, within the limits specified in the aircraft operating manuals. The two primary altimeters should also agree within limits specified by the aircraft operating manual. An alternative procedure using QFE (atmospheric pressure at aerodrome elevation/runway threshold) may also be used. The maximum value of acceptable altimeter differences for these checks should not exceed 23 m (75 ft). Any required functioning checks of altitude indicating systems should be performed.
 - (iv) Before take-off, equipment required for flight in RVSM airspace should be operative and any indications of malfunction should be resolved.

(c) Prior to RVSM airspace entry

- (1) The following equipment should be operating normally at entry into RVSM airspace:
 - (i) two primary altitude measurement systems. A cross-check between the primary altimeters should be made. A minimum of two will need to agree within ± 60 m (± 200 ft). Failure to meet this condition will require that the altimetry system be reported as defective and air traffic control (ATC) notified;
 - (ii) one automatic altitude-control system;
 - (iii) one altitude-alerting device; and
 - (iv) operating transponder.
- (2) Should any of the required equipment fail prior to the aircraft entering RVSM airspace, the pilot should request a new clearance to avoid entering this airspace.

(d) In-flight procedures

- (1) The following practices should be incorporated into flight crew training and procedures:
 - (i) Flight crew should comply with any aircraft operating restrictions, if required for the specific aircraft type, e.g. limits on indicated Mach number, given in the RVSM airworthiness approval.
 - (ii) Emphasis should be placed on promptly setting the sub-scale on all primary and standby altimeters to 1013.2 hPa / 29.92 in Hg when passing the transition altitude, and rechecking for proper altimeter setting when reaching the initial cleared flight level.
 - (iii) In level cruise it is essential that the aircraft is flown at the cleared flight level. This requires that particular care is taken to ensure that ATC clearances are fully

understood and followed. The aircraft should not intentionally depart from cleared flight level without a positive clearance from ATC unless the crew are conducting contingency or emergency manoeuvres.

- (iv) When changing levels, the aircraft should not be allowed to overshoot or undershoot the cleared flight level by more than 45 m (150 ft). If installed, the level off should be accomplished using the altitude capture feature of the automatic altitude-control system.
- (v) An automatic altitude-control system should be operative and engaged during level cruise, except when circumstances such as the need to re-trim the aircraft or turbulence require disengagement. In any event, adherence to cruise altitude should be done by reference to one of the two primary altimeters. Following loss of the automatic height-keeping function, any consequential restrictions will need to be observed.
- (vi) Ensure that the altitude-alerting system is operative.
- (vii) At intervals of approximately 1 hour, cross-checks between the primary altimeters should be made. A minimum of two will need to agree within ± 60 m (± 200 ft). Failure to meet this condition will require that the altimetry system be reported as defective and ATC notified.

The usual scan of flight deck instruments should suffice for altimeter cross-checking on most flights.

- (viii) In normal operations, the altimetry system being used to control the aircraft should be selected for the input to the altitude reporting transponder transmitting information to ATC.
 - (ix) If the pilot is notified by ATC of a deviation from an assigned altitude exceeding ± 90 m (± 300 ft) then the pilot should take action to return to cleared flight level as quickly as possible.
- (2) Contingency procedures after entering RVSM airspace are as follows:
- (i) The pilot should notify ATC of contingencies (equipment failures, weather) that affect the ability to maintain the cleared flight level and coordinate a plan of action appropriate to the airspace concerned. The pilot should obtain the guidance on contingency procedures is contained in the relevant publications dealing with the airspace.
 - (ii) Examples of equipment failures that should be notified to ATC are:
 - (A) failure of all automatic altitude-control systems aboard the aircraft;
 - (B) loss of redundancy of altimetry systems;
 - (C) loss of thrust on an engine necessitating descent; or
 - (D) any other equipment failure affecting the ability to maintain cleared flight level.
 - (iii) The pilot should notify ATC when encountering greater than moderate turbulence.
 - (iv) If unable to notify ATC and obtain an ATC clearance prior to deviating from the cleared flight level, the pilot should follow any established contingency procedures for the region of operation and obtain ATC clearance as soon as possible.

-
- (e) Post-flight procedures
- (1) In making technical log entries against malfunctions in height-keeping systems, the pilot should provide sufficient detail to enable maintenance to effectively troubleshoot and repair the system. The pilot should detail the actual defect and the crew action taken to try to isolate and rectify the fault.
 - (2) The following information should be recorded when appropriate:
 - (i) primary and standby altimeter readings;
 - (ii) altitude selector setting;
 - (iii) subscale setting on altimeter;
 - (iv) autopilot used to control the aircraft and any differences when an alternative autopilot system was selected;
 - (v) differences in altimeter readings, if alternate static ports selected;
 - (vi) use of air data computer selector for fault diagnosis procedure; and
 - (vii) the transponder selected to provide altitude information to ATC and any difference noted when an alternative transponder was selected.
- (f) Crew training
- (1) The following items should also be included in flight crew training programmes:
 - (i) knowledge and understanding of standard ATC phraseology used in each area of operations;
 - (ii) importance of crew members cross-checking to ensure that ATC clearances are promptly and correctly complied with;
 - (iii) use and limitations in terms of accuracy of standby altimeters in contingencies. Where applicable, the pilot should review the application of static source error correction/position error correction through the use of correction cards; such correction data should be available on the flight deck;
 - (iv) problems of visual perception of other aircraft at 300 m (1 000 ft) planned separation during darkness, when encountering local phenomena such as northern lights, for opposite and same direction traffic, and during turns;
 - (v) characteristics of aircraft altitude capture systems that may lead to overshoots;
 - (vi) relationship between the aircraft's altimetry, automatic altitude control and transponder systems in normal and abnormal conditions; and
 - (vii) any airframe operating restrictions, if required for the specific aircraft group, related to RVSM airworthiness approval.

AMC3 SPA.RVSM.105 RVSM operational approval

ED Decision 2017/009/R

CONTINUING AIRWORTHINESS

(a) Maintenance programme

The aircraft maintenance programme should include the instructions for continuing airworthiness issued by the type certificate holder in relation to the RVSM operations certification in accordance with AMC1 ACNS.A.GEN.010.

(b) Continuing airworthiness procedures

The continuing airworthiness procedures should establish a process to:

- (1) assess any modification or design change which in any way affects the RVSM approval;
- (2) evaluate any repairs that may affect the integrity of the continuing RVSM approval, e.g. those affecting the alignment of pitot/static probes, repairs to dents, or deformation around static plates;
- (3) ensure the proper maintenance of airframe geometry for proper surface contours and the mitigation of altimetry system error, surface measurements or skin waviness as specified in the instructions for continued airworthiness (ICA), to ensure adherence to RVSM tolerances. These checks should be performed following repairs or alterations having an effect on airframe surface and airflow.

(c) Additional training may be necessary for continuing airworthiness and maintenance staff to support RVSM approval. Areas that may need to be highlighted for the initial and recurrent training of relevant personnel are:

- (1) Aircraft geometric inspection techniques;
 - (2) Test equipment calibration and use of that equipment; and
 - (3) Any special instructions or procedures introduced for RVSM approval.
- (d) Test equipment

The operator should ensure that maintenance organisations use test equipment adequate for maintenance of the RVSM systems. The adequacy of the test equipment should be established in accordance with the type certificate holder recommendations and taking into consideration the required test equipment accuracy and the test equipment calibration.

GM1 SPA.RVSM.105(d)(9) RVSM operational approval

ED Decision 2017/009/R

SPECIFIC REGIONAL PROCEDURES

- (a) The areas of applicability (by Flight Information Region) of RVSM airspace in identified ICAO regions is contained in the relevant sections of ICAO Document 7030/4. In addition, these sections contain operating and contingency procedures unique to the regional airspace concerned, specific flight planning requirements and the approval requirements for aircraft in the designated region.
- (b) Comprehensive guidance on operational matters for European RVSM airspace is contained in ICAO EUR Doc 009 entitled 'Guidance material on the implementation of a 300 m (1 000 ft)

vertical separation minimum in the European RVSM airspace' with further material included in the relevant State aeronautical publications.

SPA.RVSM.110 RVSM equipment requirements

Regulation (EU) No 965/2012

Aircraft used for operations in RVSM airspace shall be equipped with:

- (a) two independent altitude measurement systems;
- (b) an altitude alerting system;
- (c) an automatic altitude control system;
- (d) a secondary surveillance radar (SSR) transponder with altitude reporting system that can be connected to the altitude measurement system in use for altitude control.

AMC1 SPA.RVSM.110(a) RVSM equipment requirements

ED Decision 2012/019/R

TWO INDEPENDENT ALTITUDE MEASUREMENT SYSTEMS

Each system should be composed of the following components:

- (a) cross-coupled static source/system, with ice protection if located in areas subject to ice accretion;
- (b) equipment for measuring static pressure sensed by the static source, converting it to pressure altitude and displaying the pressure altitude to the flight crew;
- (c) equipment for providing a digitally encoded signal corresponding to the displayed pressure altitude, for automatic altitude reporting purposes;
- (d) static source error correction (SSEC), if needed to meet the performance criteria for RVSM flight envelopes; and
- (e) signals referenced to a flight crew selected altitude for automatic control and alerting. These signals will need to be derived from an altitude measurement system meeting the performance criteria for RVSM flight envelopes.

SPA.RVSM.115 RVSM height-keeping errors

Regulation (EU) No 965/2012

- (a) The operator shall report recorded or communicated occurrences of height-keeping errors caused by malfunction of aircraft equipment or of operational nature, equal to or greater than:
 - (1) a total vertical error (TVE) of ± 90 m (± 300 ft);
 - (2) an altimetry system error (ASE) of ± 75 m (± 245 ft); and
 - (3) an assigned altitude deviation (AAD) of ± 90 m (± 300 ft).
- (b) Reports of such occurrences shall be sent to the competent authority within 72 hours. Reports shall include an initial analysis of causal factors and measures taken to prevent repeat occurrences.

- (c) When height-keeping errors are recorded or received, the operator shall take immediate action to rectify the conditions that caused the errors and provide follow-up reports, if requested by the competent authority.

SUBPART E: LOW-VISIBILITY OPERATIONS (LVOs) AND OPERATIONS WITH OPERATIONAL CREDITS

SPA.LVO.100 Low-visibility operations and operations with operational credits

Regulation (EU) 2021/2237

The operator shall conduct the following operations only if they are approved by the competent authority:

- (a) take-off operations with visibility conditions of less than 400 m RVR;
- (b) instrument approach operations in low-visibility conditions; and
- (c) operations with operational credits, except for EFVS 200 operations, which shall not be subject to a specific approval.

GM1 SPA.LVO.100 Low-visibility operations and operations with operational credits

ED Decision 2022/012/R

DOCUMENTS CONTAINING INFORMATION RELATED TO LVOs and OPERATIONS WITH OPERATIONAL CREDITS

The following documents provide further information related to low-visibility operations (LVOs):

- (a) ICAO Annex 2 — Rules of the Air;
- (b) ICAO Annex 6 — Operation of Aircraft;
- (c) ICAO Annex 10 — Aeronautical Telecommunications (Volume I — Radio Navigation Aids);
- (d) ICAO Annex 14 — Aerodromes (Volume I — Aerodrome Design and Operations);
- (e) ICAO Doc 8168 — PANS - OPS — Procedures For Air Navigation Services — Aircraft Operations;
- (f) ICAO Doc 9365 — Manual of All-Weather Operations;
- (g) ICAO Doc 9476 — Manual of surface movement guidance and control systems (SMGCS);
- (h) ICAO Doc 9157 — Aerodrome Design Manual;
- (i) ICAO Doc 9328 — Manual of RVR Observing and Reporting Practices;
- (j) ICAO EUR Doc 013 — European Guidance Material on All Weather Operations at Aerodromes;
- (k) ECAC Doc 17, Issue 3; and
- (l) CS-AWO All-weather operations.

GM2 SPA.LVO.100 Low-visibility operations and operations with operational credits

ED Decision 2022/012/R

ILS AND GLS CLASSIFICATION

- (a) The ILS and GBAS classification systems are specified in ICAO Annex 10 and [GM2 SPA.LVO.110](#).

LOW-VISIBILITY CONDITIONS

- (b) Low visibility conditions means meteorological conditions with a runway visual range (RVR) less than 550 m.

AMC1 SPA.LVO.100(a) Low-visibility operations and operations with operational credits

ED Decision 2022/014/R

LOW-VISIBILITY TAKE-OFF (LVTO) OPERATIONS — AEROPLANES IN AN RVR OF LESS THAN 400 M

- (a) Required RVR
- (1) For multi-engined aeroplanes which, in the event of a critical engine failure at any point during take-off, can either stop or continue the take-off to a height of 1 500 ft above the aerodrome while clearing obstacles by the required margins, the criteria in Table 1 should apply:

Table 1

LVTO operations with aeroplanes — RVR versus facilities

Minimum RVR	Facilities
300 m (day)	Centre line markings; and Runway edge lights.
300 m (night)	Centre line markings; and Runway edge lights; and Runway end lights or centre line lights.
150 m	Centre line markings; and Runway end lights; and Runway edge lights; and Runway centre line lights.
125 m	Centre line markings; and Runway end lights; and Runway edge lights (spaced 60 m or less); and Runway centre line lights (spaced 15 m or less).

- (2) For multi-engined aeroplanes not complying with the conditions in (a)(1), there may be a need to land immediately and to see and avoid obstacles. Such aeroplanes may be operated to the take-off minima shown in Table 2 and the marking and lighting criteria shown in Table 1, provided that they are able to comply with the applicable obstacle clearance criteria, assuming engine failure at the height specified:

Table 2

LVTO operations with aeroplanes — assumed engine failure height versus RVR

Assumed engine failure height above the take-off runway (ft) versus RVR (m)	
Less than 50	Not less than 200
More than 50 but less than 100	Not less than 300

- (b) The reported RVR value representative of the initial part of the take-off run can be replaced by pilot assessment.
- (c) The minimum RVR value specified in Table 1 or 2 should be achieved for all reporting points representative of the parts of the runway from the point at which the aircraft commences the take-off until the calculated accelerate-stop distance from that point.

LVTO OPERATIONS — AEROPLANES IN AN RVR OF LESS THAN 125 M

- (d) For LVTO operations with an RVR of less than 125 m, the following additional elements should apply:
 - (1) The runway has centre line lights spaced at intervals of 15 m or less;
 - (2) If an ILS signal is used for lateral guidance, the ILS localiser signal meets the requirements for category III operations, unless otherwise stated in the AFM;
 - (3) If an ILS signal is to be used, low-visibility procedures (LVPs) include protection of the runway and, where an ILS localiser signal is used, it should include protection of the ILS-sensitive area unless otherwise stated in the AFM; and
 - (4) If a GLS signal is used for lateral guidance, the GLS performance type meets the requirements for category III operations (GAST D and to GBAS point to which guidance is required), unless otherwise stated in the AFM.
- (e) For LVTO operations with an RVR of less than 125 m, the reported RVR should be not less than the minimum specified in the AFM or, if no such minimum is specified, not less than 75 m.
- (f) The minimum required RVR should be achieved for all reporting points representative of the parts of the runway from the point at which the aircraft commences the take-off until the greater of the calculated take-off distance or accelerate-stop distance from that point.
- (g) The reported RVR value representative of the initial part of the take-off run can be replaced by pilot assessment.

AMC2 SPA.LVO.100(a) Low-visibility operations and operations with operational credits

ED Decision 2022/012/R

LVTO OPERATIONS — HELICOPTERS

The following should apply to LVTOs for helicopters with an RVR of less than 400 m:

- (a) For take-off from onshore aerodromes or operating sites with IFR departure procedures, the criteria in Table 3 should apply:

Table 3
LVTO operations with helicopters — RVR versus facilities onshore

RVR or VIS (m)*	Facilities
Not less than 250 m or the rejected take-off distance, whichever is the greater	No light and no markings (day only)
Not less than 800 m	No markings (night)
Not less than 200 m	Runway edge/FATO light and centre line marking
Not less than 150 m	Runway edge/FATO light, centre line marking and relevant RVR information

* On PinS departures to IDF, VIS should not be less than 800 m and ceiling should not be less than 250 ft.

- (b) For take-off from offshore helidecks where the take-off flight path is free of obstacles, the minimum RVR for take-off should not be less than:
- 500 m for single-pilot operations; or
 - 250 m for two-pilot operations.

GM1 SPA.LVO.100(a) Low-visibility operations and operations with operational credits

ED Decision 2022/012/R

CLASSIFICATION OF LVTO OPERATIONS

Take-off operations are classified as ‘normal take-off operations’ with an RVR at or above 550 m and ‘LVTO operations’ with an RVR below 550 m. Only LVTO operations in an RVR of less than 400 m require a specific approval.

GM2 SPA.LVO.100(a) Low-visibility operations and operations with operational credits

ED Decision 2022/012/R

VISUAL SEGMENT FOR TAKE-OFF

The value of 125 m RVR for take-off with 15 m centre line light spacing has been selected because flight deck geometry means that this will provide at least a 90-m visual segment for the large majority of aircraft types. In a 90-m visual segment the pilot is expected to be able to see six centre line light intervals (seven centre line lights) at 15 m spacing once lined up on the runway centre line.

AMC1 SPA.LVO.100(b) Low-visibility operations and operations with operational credits

ED Decision 2022/012/R

INSTRUMENT APPROACH OPERATIONS IN LOW-VISIBILITY CONDITIONS — CAT II OPERATIONS

For CAT II operations, the following should apply:

- (a) The DH should be determined by the use of a radio altimeter or other device capable of providing equivalent performance and be not lower than the highest of:

- (1) the minimum DH specified in the AFM, if stated;
 - (2) the applicable obstacle clearance height (OCH) for the category of aircraft;
 - (3) the DH to which the flight crew is qualified to operate; or
 - (4) 100 ft.
- (b) The lowest RVR minima to be used are specified in Table 4:

Table 4
CAT II operation minima: RVR (m) versus DH (ft)

Aircraft categories		Auto-coupled or HUD to below DH*	
		A, B, C	D
DH (ft)	100–120	300	300/350*
	121–140	400	400
	141–199	450	450

* An RVR of 300 m may be used for a Category D aeroplane conducting an autoland or using HUDLS to touchdown.

AMC2 SPA.LVO.100(b) Low-visibility operations and operations with operational credits

ED Decision 2022/012/R

INSTRUMENT APPROACH OPERATIONS IN LOW-VISIBILITY CONDITIONS — CAT III OPERATIONS

For CAT III operations, the following should apply:

- (a) For operations in which a DH is used, the DH should be determined by the use of a radio altimeter or other device capable of providing equivalent performance and be not lower than:
 - (1) the minimum DH specified in the AFM, if stated;
 - (2) the DH to which the flight crew is qualified to operate.
- (b) Operations with no DH should only be conducted if:
 - (1) operation with no DH is specified in the AFM;
 - (2) there is no published information indicating that the approach aid or aerodrome facilities cannot support operations with no DH; and
 - (3) the flight crew is qualified to operate with no DH.
- (c) The lowest RVR to be used should be determined in accordance with Table 5.

Table 5
CAT III operations minima: RVR (m) versus DH (ft)

DH (ft)	Roll-out control/guidance system	RVR (m)*
50-99	Not required	175
0-49 or no DH	Fail-passive	125
	Fail-operational	75

- * Note: For a fail-passive or HUD roll-out control system, a lower RVR value (no lower than 75 m) can be used if stated in the AFM provided that the equipment demonstrated such capability as part of the certification process. This is provided that the operator has implemented the appropriate operating procedures and training.

AMC3 SPA.LVO.100(b) Low-visibility operations and operations with operational credits

ED Decision 2022/014/R

INSTRUMENT APPROACH OPERATIONS IN LOW-VISIBILITY CONDITIONS — EFFECT ON LANDING MINIMA OF TEMPORARILY FAILED OR DOWNGRADED EQUIPMENT FOR APPROACH OPERATIONS WITH A DH BELOW 200 ft

- (a) Only those facilities mentioned in Table 6 should be acceptable to be used to determine the effect of temporarily failed or downgraded equipment on the required RVR for CAT II/III approach operations.
- (b) The following conditions should be applied to Table 6:
- (1) multiple failures of runway/FATO lights other than those indicated in Table 6 are not acceptable;
 - (2) failures of approach and runway/FATO lights are acceptable at the same time, and the most demanding consequence should be applied;
 - (3) for approach operations with a DH below 200 ft, a combination of deficiencies in runway/FATO lights and RVR assessment equipment are not permitted; and
 - (4) failures other than ILS, GLS and MLS affect RVR only and not DH.

Table 6
Failed or downgraded equipment — effect on landing minima
CAT II/III operations

Failed or downgraded equipment	Effect on landing minima			
	CAT III no DH	CAT III DH<50 ft	CAT III DH>=50 ft	CAT II
Navaid stand-by transmitter	Not allowed	RVR 200 m	No effect	
Outer marker (ILS)	No effect if the required height versus glide path can be checked using other means, e.g. DME fix			
Middle marker (ILS)	No effect			
DME	No effect if replaced by RNAV (GNSS) information or the outer marker			
RVR assessment systems	At least one RVR value to be available on the aerodrome	On runways equipped with two or more RVR assessment units, one may be inoperative		
Approach lights	No effect	Not allowed for operations with DH >50 ft		Not allowed
Approach lights except the last 210 m	No effect			Not allowed
Approach lights except the last 420 m	No effect			

Failed or downgraded equipment	Effect on landing minima			
	CAT III no DH	CAT III DH<50 ft	CAT III DH>=50 ft	CAT II
Standby power for approach lights	No effect			
Standby power for runway lights with 1-second switchover time	No effect	Not allowed	Day: RVR 550 m	Day: RVR 550 m
	No effect		Night: RVR 550 m	Night: RVR 550 m
Edge lights	No effect	Day: no effect	Day: no effect	Day: no effect
		Night: RVR 550 m	Night: RVR 550 m	Night: not allowed
Threshold lights	No effect	No effect	Day: no effect	Day: no effect
			Night: RVR 550 m	Night: not allowed
Runway end lights	No effect if centre line lights are serviceable			
Centre line lights	Day: RVR 200 m	Not allowed	Day: RVR 300 m	Day: RVR 350 m
	Night: not allowed		Night: RVR 400 m	Night: RVR 550 m (400 m with HUD or auto-land)
Centre line lights spacing increased to 30 m	RVR 150 m		No effect	
TDZ lights	No effect	Day: RVR 200 m	Day: RVR 300 m	
		Night: RVR 300 m	Night: RVR 550 m, 350 m with HUD or auto-land	
Taxiway light system	No effect			

Table 7

Failed or downgraded equipment — effect on landing minima

Operational credits

Failed or downgraded equipment	Effect on landing minima			
	SA CAT I	SA CAT II	EFVS-A	EFVS-L
Navaid stand-by transmitter	No effect			
Outer marker (ILS)	No effect if replaced by height check at 1 000 ft			
Middle marker (ILS)	No effect			
RVR assessment systems	On runways equipped with two or more RVR assessment units, one may be inoperative			
Approach lights	Not allowed	Not allowed	As per IAP	As per IAP
Approach lights except the last 210 m	Not allowed	No effect	As per IAP	As per IAP

Approach lights except the last 420 m	No effect	No effect	As per IAP	As per IAP
Standby power for approach lights	No effect			
Edge lights	Day: No effect	Day: no effect	As per IAP	As per IAP
	Night: not allowed	Night: RVR 550 m	As per IAP	As per IAP
Threshold lights	Day: No effect	Day: no effect	As per IAP	As per IAP
	Night: not allowed	Night: RVR 550 m	As per IAP	As per IAP
Runway end lights	No effect if centre line lights are serviceable		As per IAP	
Centre line lights	Day: RVR 400 m	Day: RVR 300 m	As per IAP	As per IAP
	Night: RVR 550 m	Night: RVR 400 m	As per IAP	As per IAP
Centre line lights spacing increased to 30 m	No effect	No effect	As per IAP	As per IAP
TDZ lights	Day: no effect	Day: RVR 300 m	As per IAP	
	Night: no effect	Night: RVR 350 m	As per IAP	
Taxiway light system	No effect			

GM1 SPA.LVO.100(b) Low-visibility operations and operations with operational credits

ED Decision 2022/012/R

INSTRUMENT APPROACH OPERATIONS IN LOW-VISIBILITY CONDITIONS — CLASSIFICATION OF STANDARD APPROACH OPERATIONS

The different types of approach and landing operations are classified according to the lowest DH (or MDH) and RVR applicable to the approach type. The classification of approach types does not depend on the technology used for the approach. The lowest minima specified do not take account of ‘operational credits’ that may allow for lower operating minima.

The classification does not subdivide CAT III operations into CAT IIIA, IIIB, and IIIC. The actual minima applicable to any operation depends on the aircraft equipment and the specific LVO approval held by the air operator.

The AFM for aircraft certified for CAT III operations will state the lowest usable DH, or no DH. Some AFMs may refer to the previous ICAO classifications as follows:

- CAT IIIA: a DH lower than 30 m (100 ft) or no DH and an RVR not less than 175 m;
- CAT IIIB: a DH lower than 15 m (50 ft) or no DH and an RVR less than 175 m but not less than 50 m; and
- CAT IIIC: no DH and no RVR limitations.

CAT IIIC has not been used in Europe and the minimum RVR in the EU regulations is 75 m.

Where an operational credit allows operation to lower-than-standard minima, this is not considered a separate approach classification.

GM2 SPA.LVO.100(b) Low-visibility operations and operations with operational credits

ED Decision 2022/012/R

INSTRUMENT APPROACH OPERATIONS IN LOW-VISIBILITY CONDITIONS — EQUIPMENT CERTIFICATION FOR LOW-VISIBILITY APPROACH OPERATIONS OTHER THAN EFVS

This GM describes the certification requirements of CS-AWO. Operators should always refer to CS-AWO for the actual requirements.

Aircraft suitable for low-visibility approach operations are certified according to the minimum usable DH which is stated in the AFM.

Certification specifications (CS-AWO) allow for systems to be certified for SA CAT I, CAT II or CAT III operations. Systems certified for CAT III operations may specify:

- a lowest usable DH of:
 - less than 100 ft but not less than 50 ft;
 - less than 50 ft; or
- no DH.

Legacy systems may be described as capable of 'CAT 3A' or 'CAT IIIA' operations. This implies a minimum DH of less than 100 ft but not less than 50 ft. Systems described as capable of 'CAT 3B' or 'CAT IIIB' may be certified for a DH of less than 50 ft or no DH.

Operations to a DH of less than 100 ft but not less than 50 ft will typically require a fail-passive automatic landing system or a HUDLS or equivalent system. Operations to a DH of less than 50 ft will require a fail-operational landing system, a fail-passive go-around system, automatic thrust control and either automatic ground roll control or ground roll guidance using a HUDLS. For no DH operations, a fail-passive or fail-operational ground roll control system is required.

The RVR required for SA CAT I, CAT II and SA CAT II approach operations is determined by the DH and the aircraft approach speed category. The RVR required for CAT III approach operations is determined by the DH and the capability of the ground-roll control system. Operations with fail-passive roll control systems require a greater RVR than operations with fail-operational ground control systems because the pilots would need to have sufficient visibility to maintain lateral control in the event of a system failure.

GM3 SPA.LVO.100(b) Low-visibility operations and operations with operational credits

ED Decision 2022/012/R

INSTRUMENT APPROACH OPERATIONS IN LOW-VISIBILITY CONDITIONS — ESTABLISHMENT OF MINIMUM RVR FOR APPROACH OPERATIONS WITH A DH BELOW 200 ft

(a) General

- (1) When establishing minimum RVR for CAT II and CAT III operations, operators should pay attention to the following information that originates in ECAC Doc 17 3rd Edition, Subpart A. It is retained as background information and, to some extent, for historical purposes although there may be some conflict with current practices.
- (2) Since the inception of precision approach and landing operations various methods have been devised for the calculation of aerodrome operating minima in terms of DH and RVR. It is a comparatively straightforward matter to establish the DH for an operation but establishing the minimum RVR to be associated with that DH so as to provide a high probability that the required visual reference will be available at that DH has been more of a problem.
- (3) The methods adopted by various States to resolve the DH/RVR relationship in respect of CAT II and CAT III operations have varied considerably. In one instance there has been a simple approach that entailed the application of empirical data based on actual operating experience in a particular environment. This has given satisfactory results for application within the environment for which it was developed. In another instance a more sophisticated method was employed which utilised a fairly complex computer programme to take account of a wide range of variables. However, in the latter case, it has been found that with the improvement in the performance of visual aids, and the increased use of automatic equipment in the many different types of new aircraft, most of the variables cancel each other out and a simple tabulation can be constructed that is applicable to a wide range of aircraft. The basic principles that are observed in establishing the values in such a table are that the scale of visual reference required by a pilot at and below DH depends on the task that he/she has to carry out, and that the degree to which his/her vision is obscured depends on the obscuring medium, the general rule in fog being that it becomes more dense with increase in height. Research using flight simulation training devices (FSTDs) coupled with flight trials has shown the following:
 - (i) most pilots require visual contact to be established about 3 seconds above DH though it has been observed that this reduces to about 1 second when a fail-operational automatic landing system is being used;
 - (ii) to establish lateral position and cross-track velocity most pilots need to see not less than a three light segment of the centre line of the approach lights, or runway centre line, or runway edge lights;
 - (iii) for roll guidance most pilots need to see a lateral element of the ground pattern, i.e. an approach light cross bar, the landing threshold, or a barrette of the touchdown zone light; and
 - (iv) to make an accurate adjustment to the flight path in the vertical plane, such as a flare, using purely visual cues, most pilots need to see a point on the ground which has a low or zero rate of apparent movement relative to the aircraft.

- (v) With regard to fog structure, data gathered in the United Kingdom over a 20 year period have shown that in deep stable fog there is a 90 % probability that the slant visual range from eye heights higher than 15 ft above the ground will be less than the horizontal visibility at ground level, i.e. RVR. There are at present no data available to show what the relationship is between the slant visual range and RVR in other low visibility conditions such as blowing snow, dust or heavy rain, but there is some evidence in pilot reports that the lack of contrast between visual aids and the background in such conditions can produce a relationship similar to that observed in fog.

(b) CAT II operations

The selection of the dimensions of the required visual segments that are used for CAT II operations is based on the following visual provisions:

- (1) a visual segment of not less than 90 m will need to be in view at and below DH for pilot to be able to monitor an automatic system;
- (2) a visual segment of not less than 120 m will need to be in view for a pilot to be able to maintain the roll attitude manually at and below DH; and
- (3) for a manual landing using only external visual cues, a visual segment of 225 m will be required at the height at which flare initiation starts in order to provide the pilot with sight of a point of low relative movement on the ground.

Before using a CAT II ILS for landing, the quality of the localiser between 50 ft and touchdown should be verified.

(c) CAT III fail-passive operations

- (1) CAT III operations utilising fail-passive automatic landing equipment were introduced in the late 1960s and it is desirable that the principles governing the establishment of the minimum RVR for such operations be dealt with in some detail.
- (2) During an automatic landing the pilot needs to monitor the performance of the aircraft system, not in order to detect a failure that is better done by the monitoring devices built into the system, but so as to know precisely the flight situation. In the final stages the pilot should establish visual contact and, by the time the pilot reaches DH, the pilot should have checked the aircraft position relative to the approach or runway centre line lights. For this the pilot will need sight of horizontal elements (for roll reference) and part of the touchdown area. The pilot should check for lateral position and cross-track velocity and, if not within the pre-stated lateral limits, the pilot should carry out a missed approach procedure. The pilot should also check longitudinal progress and sight of the landing threshold is useful for this purpose, as is sight of the touchdown zone TDZ lights.

Where a fail-operational automatic landing and roll-out system is used, it is not considered necessary for the pilot to check the lateral position and cross-track velocity, and thus it is not necessary for the visual reference requirements to include horizontal elements of the lighting system.

- (3) In the event of a failure of the automatic flight guidance system below DH, there are two possible courses of action; the first is a procedure that allows the pilot to complete the landing manually if there is adequate visual reference for him/her to do so, or to initiate a missed approach procedure if there is not; the second is to make a missed approach

procedure mandatory if there is a system disconnect regardless of the pilot's assessment of the visual reference available:

- (i) If the first option is selected then the overriding rule in the determination of a minimum RVR is for sufficient visual cues to be available at and below DH for the pilot to be able to carry out a manual landing. Data presented in ECAC Doc 17 showed that a minimum value of 300 m would give a high probability that the cues needed by the pilot to assess the aircraft in pitch and roll will be available and this should be the minimum RVR for this procedure.
 - (ii) The second option, to require a missed approach procedure to be carried out should the automatic flight-guidance system fail below DH, will permit a lower minimum RVR because the visual reference provision will be less if there is no need to provide for the possibility of a manual landing. However, this option is only acceptable if it can be shown that the probability of a system failure below DH is acceptably low. It should be recognised that the inclination of a pilot who experiences such a failure would be to continue the landing manually but the results of flight trials in actual conditions and of simulator experiments show that pilots do not always recognise that the visual cues are inadequate in such situations and present recorded data reveal that pilots' landing performance reduces progressively as the RVR is reduced below 300 m. It should further be recognised that there is some risk in carrying out a manual missed approach procedure from below 50 ft in very low visibility and it should therefore be accepted that if an RVR lower than 300 m is to be approved, the flight deck procedure should not normally allow the pilot to continue the landing manually in such conditions and the aircraft system should be sufficiently reliable for the missed approach procedure rate to be low.
- (4) These criteria may be relaxed in the case of an aircraft with a fail-passive automatic landing system that is supplemented by a head-up display that does not qualify as a fail-operational system but that gives guidance that will enable the pilot to complete a landing in the event of a failure of the automatic landing system. In this case it is not necessary to make a missed approach procedure mandatory in the event of a failure of the automatic landing system when the RVR is less than 300 m.
- (d) CAT III fail-operational operations - with a DH
- (1) For CAT III operations utilising a fail-operational landing system with a DH, a pilot should be able to see at least one centre line light.
 - (2) For CAT III operations utilising a fail-operational hybrid landing system with a DH, a pilot should have a visual reference containing a segment of at least three consecutive lights of the runway centre line lights.
- (e) CAT III fail operational operations - with no DH
- (1) For CAT III operations with no DH the pilot is not required to see the runway prior to touchdown. The permitted RVR is dependent on the level of aircraft equipment.
 - (2) A CAT III runway may be assumed to support operations with no DH unless specifically restricted as published in the AIP or NOTAM.

GM4 SPA.LVO.100(b) Low-visibility operations and operations with operational credits

ED Decision 2022/012/R

INSTRUMENT APPROACH OPERATIONS IN LOW-VISIBILITY CONDITIONS — EFFECT ON LANDING MINIMA OF TEMPORARILY FAILED OR DOWNGRADED EQUIPMENT FOR APPROACH OPERATIONS WITH A DH BELOW 200 ft

The instructions for the effect on landing minima of temporarily failed or downgraded equipment are intended for use both before flight and during flight. It is, however, not expected that the pilot-in-command/commander would consult such instructions after passing 1 000 ft above the aerodrome. If failures of ground aids are announced at such a late stage, the approach could be continued at the pilot-in-command/commander’s discretion. If failures are announced before such a late stage in the approach, their effect on the approach should be considered as described in Table 6, and the approach may have to be abandoned.

AMC1 SPA.LVO.100(c) Low-visibility operations and operations with operational credits

ED Decision 2022/012/R

OPERATIONS WITH OPERATIONAL CREDITS — SPECIAL AUTHORISATION CATEGORY I (SA CAT I)

For special authorisation category I (SA CAT I) operations, the following should apply:

- (a) The DH of an SA CAT I operation should not be lower than the highest of:
 - (1) the minimum DH specified in the AFM, if stated;
 - (2) the applicable OCH for the category of aeroplane;
 - (3) the DH to which the flight crew is qualified to operate; or
 - (4) 150 ft.
- (b) Where the DH for an SA CAT I operation is less than 200 ft, it should be determined by the use of a radio altimeter or other device capable of providing equivalent performance.
- (c) The following visual aids should be available:
 - (1) approach lights as specified in Table 8;
 - (2) precision approach (PA) runway markings;
 - (3) category I runway lights.
- (d) The lowest RVR should not be lower than the higher of:
 - (1) the minimum RVR specified in the AFM, if stated; or
 - (2) the RVR specified in Table 8.

Table 8

SA CAT I operation minima RVR (m) versus approach lighting system

Class of light facility		FALS	IALS	BALS	NALS
DH (ft)	150–160	400	500	600	700
	161–200	450	550	650	750
	201–210	450	550	650	750

	211–220	500	550	650	800
	221–230	500	600	700	900
	231–240	500	650	750	1 000
	241–249	550	700	800	1 100

Note: For class of approach lighting facility, see [GM2 CAT.OP.MPA.110](#).

AMC2 SPA.LVO.100(c) Low-visibility operations and operations with operational credits

ED Decision 2022/012/R

OPERATIONS WITH OPERATIONAL CREDITS — SPECIAL AUTHORISATION CATEGORY II (SA CAT II)

For special authorisation category II (SA CAT II) operations, the following should apply:

- (a) The DH should be determined by the use of a radio altimeter or other device capable of providing equivalent performance, if so determined by the aircraft certification process, and be not lower than the highest of:
 - (1) the minimum DH specified in the AFM, if stated;
 - (2) the applicable OCH for the category of aeroplane;
 - (3) the DH to which the flight crew is qualified to operate; or
 - (4) 100 ft.
- (b) The following visual aids should be available:
 - (1) approach lights as specified in Table 9;
 - (2) precision approach runway markings;
 - (3) category I runway lights.
- (c) The lowest RVR minima to be used are specified in Table 9:

Table 9

SA CAT II operation minima: RVR (m) versus DH (ft)

Class of light facility		FALS	IALS	BALS	NALS
DH (ft)	100–120	350	450	600	700
	121–140	400	500	600	700
	141–160	400	500	600	750
	161–199	400	550	650	750

AMC3 SPA.LVO.100(c) Low-visibility operations and operations with operational credits

ED Decision 2022/012/R

OPERATIONS WITH OPERATIONAL CREDITS — EFVS OPERATIONS TO A RUNWAY

When conducting EFVS operations to a runway:

- (a) the DA/H used should be the same as for operations without EFVS;
- (b) the lowest RVR minima to be used should be determined:
 - (1) in accordance with criteria specified in the AFM for the expected weather conditions; or
 - (2) if no such criteria are specified, by reducing the RVR determined for operation without the use of EFVS/ CVS in accordance with Table 10;
- (c) where the lowest RVR to be used, determined in accordance with (b), is less than 550 m, then this should be increased to 550 m unless LVPs are established at the aerodrome of intended landing;
- (d) where the EFVS is part of a CVS, it is only the EFVS element that should provide the operational credits. The other part of the CVS, the synthetic vision system (SVS), should not provide operational credits.

Table 10

Operations using EFVS/ CVS — RVR/CMV reduction

RVR/CMV (m) required without the use of EFVS	RVR/CMV (m) with the use of EFVS
550	350*
600	400*
650	450*
700	450*
750	500*
800	550
900	600
1 000	650
1 100	750
1 200	800
1 300	900
1 400	900
1 500	1 000
1 600	1 100
1 700	1 100
1 800	1 200
1 900	1 300
2 000	1 300
2 100	1 400
2 200	1 500
2 300	1 500
2 400	1 600

* Reported RVR should be available (no CMV conversion).

AMC4 SPA.LVO.100(c) Low-visibility operations and operations with operational credits

ED Decision 2022/012/R

OPERATIONS WITH OPERATIONAL CREDITS — HELICOPTER SPECIAL AUTHORISATION CATEGORY I (HELI SA CAT I) OPERATIONS

For HELI SA CAT I operations, the following should apply:

- (a) HELI SA CAT I operations should only be conducted to a runway with an approach lighting system. The following visual aids should be available:
 - (1) standard runway day markings, approach lights, runway edge lights, threshold lights, and runway end lights;
 - (2) for operations with an RVR below 450 m, runway centre line markings.
- (b) An ILS/MLS that supports a HELI SA CAT I operation should be an unrestricted facility.
- (c) The helicopter should be:
 - (1) equipped with a 3-axis autopilot capable of flying the approach to the minima;
 - (2) able to maintain V_y in IMC on a coupled Type B approach;
 - (3) equipped with a radio altimeter or other device capable of providing equivalent performance; and
 - (4) equipped with two independent navigation aids capable of Type B CAT I approaches and certified for CAT I.
- (d) The DH of a HELI SA CAT I operation should not be lower than the highest of:
 - (1) the minimum DH specified in the AFM, if stated;
 - (2) the minimum height to which the PA aid can be used without the specified visual reference;
 - (3) the applicable OCH for Category A aeroplanes or the OCH for Category H if available;
 - (4) the DH to which the flight crew is qualified to operate;
 - (5) 130 ft on a CAT II landing system;
 - (6) 150 ft on a CAT I ILS certified to Class I/C/1 or MLS certified to 100 ft/E/1; or
 - (7) 200 ft on other landing systems;
 - (8) 200 ft unless the autopilot is a 4-axis autopilot with automatic level-off capability.
- (e) The lowest RVR minima to be used are specified in Table 11.

Table 11
HELI SA CAT I operation minima

RVR versus approach lighting system				
DH (ft)	Class of light facility			
	FALS	IALS	BALS	NALS
201–250	450	650	750	1 000
181–200	300	450	650	900
151–180	300	350	550	750
130–150	300	300	400	600

(f) Operations

- (1) The minimum crew should be two pilots or one pilot and a technical crew member. The technical crew member should be seated in the front seat and be allocated no other task than assisting the pilot, from the initial approach fix (IAF) onwards.
- (2) On a CAT II landing system, the flight crew should use the radio altimeter or other equivalent device for the determination of the DH.
- (3) On a CAT I ILS, the flight crew should use the altimeter for the determination of the DH. The crew should cross-check the altitude with the radio altimeter or equivalent device, considering the local geography.
- (4) The AFCS and radio altimeter should be serviceable prior to commencing the approach.
- (5) The approach should be flown in coupled 4-axis mode down to minima or below.
- (6) The flight crew should promptly initiate a go-around if any of the following conditions are met below a 1 000-ft height:
 - (i) discrepancy in altitude/radio altitude information;
 - (ii) discrepancy in navigation information;
 - (iii) partial or total failure of an AFCS system or navigation system;
 - (iv) deviation of ¼ scale or more on the landing system navigation display.
- (7) The planning minima at the alternate where a HELI SA CAT I approach is envisaged should be as defined in Table 12.

Table 12

Planning minima at the alternate with HELI SA CAT I operations

Type of approach	Aerodrome ceiling	Weather minima RVR/VIS
Two or more usable Type B instrument approach operations***	DA/H* + 100 ft	RVR** + 300 m
One usable Type B instrument approach operation	DA/H + 150 ft	RVR + 450 m

* The higher of the usable DA/H or MDA/H.

** The higher of the usable RVR or VIS.

*** Compliance with [CAT.OP.MPA.192\(d\)](#) should be ensured.

- (8) Under commercial air transport, if no other alternate is selected and the weather forecast at destination is not based on Part-MET of [Regulation \(EU\) 2017/373](#), the planning minima at the alternate where a HELI SA CAT I approach is envisaged should be as defined in Table 13.

Table 13

Planning minima at the alternate with HELI SA CAT I operations with alternative weather source at destination

Type of approach	Aerodrome ceiling	Weather minima RVR/VIS
Two or more usable Type B instrument approach operations ***	DA/H * + 200 ft	RVR** + 600 m
One usable Type B instrument approach operation	DA/H + 300 ft	RVR + 900 m

- * The higher of the usable DA/H or MDA/H.
 - ** The higher of the usable RVR or VIS.
 - *** Compliance with [CAT.OP.MPA.192\(d\)](#) should be ensured.
- (g) Crew training and competency
- (1) Under CAT, NCC and SPO, the aerodrome used for HELI SA CAT I operations should be considered as a Category C aerodrome under [ORO.FC.105](#).
 - (2) A crew member should undergo training to determine the eligibility of a HELI SA CAT I approach as determined under points (a) to (c), and to determine the applicable minima under points (d) and (e).
 - (3) A crew member should have the relevant knowledge to implement the operating procedures described in point (f).
 - (4) A crew member that is involved in HELI SA CAT I operations should undergo initial and recurrent training to proficiency using a suitable FSTD, including one approach and landing and one go-around using the lowest minima defined in points (d) and (e).
 - (5) The recurrent training should have a validity of 6 calendar months. The validity period should be counted from the end of the month when the check was taken. When the training is undertaken within the last 3 months of the validity period, the new validity period should be counted from the previous expiry date.
 - (6) In addition to (5), a technical crew member that is involved in HELI SA CAT I operations should be trained to perform navigation and monitoring functions under IFR, as described under [AMC3 SPA.NVIS.130\(f\)](#). The training and checking should include all of the following on the given helicopter type:
 - (i) initial and recurrent general training;
 - (ii) initial and recurrent monitoring training;
 - (iii) initial and recurrent navigation training;
 - (iv) initial and recurrent aircraft/FSTD training focusing on crew cooperation with the pilot;
 - (v) line flying under supervision (LIFUS);
 - (vi) initial and recurrent operator proficiency checks, which should meet all of the following criteria:
 - (A) the technical crew member should complete an operator proficiency check to demonstrate competence in carrying out normal, abnormal and emergency procedures, covering the relevant aspects associated with the flight operational tasks described in the operations manual and not covered in the line check;
 - (B) the initial training course should include an operator proficiency check;
 - (C) the operator proficiency check should be valid for a given helicopter type. In order to consider an operator proficiency check to be valid for several helicopter types, the operator should demonstrate that the types are sufficiently similar from the technical crew member's perspective;

- (D) the validity period of the operator proficiency check should be 12 calendar months. The validity period should be counted from the end of the month when the check was performed. When the operator proficiency check is undertaken within the last 3 months of the validity period, the new validity period shall be counted from the original expiry date;
 - (E) the operator proficiency check should be conducted by a suitably qualified instructor nominated by the operator to conduct flight crew operator proficiency checks;
- (vii) initial and recurrent line checks, which should meet all of the following criteria:
- (A) the line check should be performed on the helicopter;
 - (B) the technical crew member should demonstrate competence in carrying out normal operations described in the operator's operations manual;
 - (C) the line check should take place after the completion of the LIFUS;
 - (D) the validity period of the line check should be 12 calendar months. The validity period should be counted from the end of the month when the check was performed. When the line check is undertaken within the last 3 months of the validity period, the new validity period should be counted from the original expiry date;
 - (E) the line check should be conducted by a suitably qualified commander nominated by the operator;
 - (F) any task-specific items may be checked by a suitably qualified technical crew member nominated by the operator and trained in CRM concepts and the assessment of non-technical skills.

GM1 SPA.LVO.100(c) Low-visibility operations and operations with operational credits

ED Decision 2022/012/R

THE CONCEPT OF OPERATIONS WITH OPERATIONAL CREDITS

For each specific class of standard take-off or approach operations, a standard combination of airborne equipment, aerodrome infrastructure and equipment, and procedures (system components) needs to be available to ensure the required performance of the total system. In real-life operations, one or more system components may exceed the required standard performance. The aim of the concept of operations with operational credits is to exploit such enhanced performance to provide operational flexibility beyond the limits of standard operations.

In certain circumstances it may be possible to achieve the required system performance without some standard items being available by using other enhanced equipment or procedures. In order to apply an operational credit, it is necessary that the equipment or procedures employed mitigate effectively the shortcomings in other system components. Another application of operational credits is to use the enhanced performance of certain system components to allow operations to lower than the standard minima. For approach operations, an operational credit can be applied to the instrument or the visual segment or both.

Where an operational credit allows operation to lower than standard minima, this is not considered a separate approach classification.

GM2 SPA.LVO.100(c) Low-visibility operations and operations with operational credits

ED Decision 2022/012/R

OPERATIONS WITH OPERATIONAL CREDITS — SPECIAL AUTHORISATION CATEGORY I (SA CAT I) OPERATIONS

SA CAT I is an operational credit that exploits a navigation solution with superior performance to that required for standard CAT I by extending the instrument segment of CAT I approach operations. This navigation solution may be an ILS installation with the necessary performance coupled to a suitably certified autoland system or a HUD or equivalent display system or SVGS. The extended instrument segment means that the DH can be reduced from the standard minimum of 200 down to 150 ft. The lower DH allows a corresponding reduction in the RVR required for the approach.

SA CAT I is not a separate approach classification; it is an operational credit applied to a CAT I operation.

GM3 SPA.LVO.100(c) Low-visibility operations and operations with operational credits

ED Decision 2022/012/R

OPERATIONS WITH OPERATIONAL CREDITS — SPECIAL AUTHORISATION CATEGORY II (SA CAT II) OPERATIONS

SA CAT II is an operational credit that applies to the visual segment of an approach conducted where aerodrome, runway and approach lighting systems do not meet the usual requirements for a CAT II precision lighting system. SA CAT II exploits the performance of a suitably certified HUDLS or autoland system. The DH will be the same as for standard CAT II, and the required RVR will depend on the class of light facility installed.

SA CAT II is not a separate approach classification; it is an operational credit applied to a CAT II operation usually in a CAT I runway.

GM4 SPA.LVO.100(c) Low-visibility operations and operations with operational credits

ED Decision 2022/012/R

OPERATIONS WITH OPERATIONAL CREDITS — EFVS OPERATIONS

- (a) EFVS operations, if approved, exploit the improved visibility provided by the EFVS to allow an operational credit applied to the visual segment of an instrument approach. An EFVS cannot be used to extend the instrument segment of an approach and thus the DH for operation with an EFVS is always the same as for the same approach conducted without an operational credit.
- (b) EFVS operations require specific approval from the competent authority in accordance with Part-SPA. However, other EFVS operations may be conducted by operators and without a specific approval if specifically covered in accordance with Part-CAT, Part-NCC or Part-SPO (e.g. 'EFVS 200').
- (c) Equipment for EFVS operations
 - (1) In order to conduct EFVS operations, a certified EFVS is used. An EFVS is an enhanced vision system (EVS) that also incorporates a flight guidance system and displays the image on a HUD or an equivalent display. The flight guidance system will incorporate aircraft flight information and flight symbology.

- (2) For operations for which a minimum flight crew of more than one pilot is required, the aircraft will also be equipped with a suitable display of EFVS sensory imagery for the pilot monitoring the progress of the approach.
 - (3) Legacy systems may be certified as 'EVS with an operational credit'. Such a system may be considered an EFVS used for approach (EFVS-A).
 - (4) Aircraft holding a type certificate issued by a third country may be certified for operations equivalent to EFVS operations. Specific approval for an operational credit for EFVS operations will be available only if the operator can demonstrate that the equipment meets all the requirements for certification in accordance with CS-AWO.
 - (5) For approaches for which natural visual reference is not required prior to touchdown, the EFVS (EFVS used for landing (EFVS-L)) will additionally display:
 - (i) flare prompt or flare guidance information; and
 - (ii) height AGL.
- (d) Suitable approach procedures
- (1) For types of approach operation, refer to [AMC1 SPA.LVO.110](#) 'Additional verification of the suitability of runways for EFVS operations'.

EFVS operations may be used for 3D approach operations. These may include operations based on non-precision approach (NPA) procedures, approach procedures with vertical guidance and PA procedures including approach operations requiring specific approvals, provided that the operator holds the necessary approvals.

An NPA procedure flown using vertical guidance from computer-generated navigation data from ground-based, space-based, self-contained navigation aids, or a combination of these may be considered a 3D instrument approach operation, so EFVSs may be used for NPA procedures provided that vertical guidance is available to the pilot.
 - (2) Offset approaches

The extent to which EFVSs can be used for offset approaches will depend on the FOV of the specific system. Where an EFVS has been demonstrated to be usable with a final approach track offset more than 3 degrees from the runway centre line, this will be stated in the AFM.

Instrument approach procedures (IAPs) may have the final approach course significantly offset from the centre line of the runway and still be considered 'straight-in approaches'. Many approach procedures with an offset final approach course are constructed so that the final approach course crosses the runway centre line extended well out from the runway. Depending on the construction of a particular procedure, the wind conditions and the available FOV of a specific EFVS installation, the required visual references may not come into view before the aircraft reaches the DH.
 - (3) Circling approaches

EFVSs incorporate a HUD or an equivalent system so that the EFVS image is visible in the pilot's forward external FOV. Circling operations require the pilot to maintain visual references which may not be directly ahead of the aircraft and may not be aligned with the current flight path. EFVSs cannot therefore be used in place of natural visual reference for circling approaches.

- (e) For aerodrome operating minima for EFVS operations, refer to [AMC3 SPA.LVO.100\(c\)](#).

The performance of EFVSs depends on the technology used and weather conditions encountered. The minimum RVR for an approach is based on the specific capabilities of the installed equipment in the expected weather conditions, so the RVR for a particular operation is determined according to criteria stipulated in the AFM.

Table 10 has been provided to allow calculation of an appropriate RVR for aircraft where the AFM does not contain criteria to determine the minimum usable RVR. This table has been developed after an operational evaluation of two different EVSs both using infrared sensors, along with data and support provided by the Federal Aviation Administration (FAA). Approaches were flown in a variety of conditions including fog, rain and snow showers, as well as at night to aerodromes located in mountainous terrain. Table 10 contains conservative figures to cater for the expected performance of infrared sensors in the variety of conditions that might be encountered.

- (f) The conditions for commencement and continuation of the approach are in accordance with [CAT.OP.MPA.305](#), [NCC.OP.230](#), [NCO.OP.210](#) and [SPO.OP.215](#) as applicable.

Pilots conducting EFVS operations may commence an approach and continue that approach below 1 000 ft above the aerodrome or into the final approach segment (FAS) if:

- (1) the reported RVR or converted meteorological visibility (CMV) is equal to or greater than the lowest RVR minima determined; and
- (2) all the conditions for conducting EFVS operations are met.

If any equipment required for EFVS operations is unserviceable or unavailable, then the conditions for conducting EFVS operations would not be satisfied, and the approach cannot be commenced. Operators may develop procedures for flight crew to follow in the event of unserviceability arising after the aircraft descends below 1 000 ft above the aerodrome or into the FAS. Such procedures should ensure that the approach is not continued unless the RVR is sufficient for the type of approach that can be conducted with equipment that remains available. In the event of failure of the equipment required for EFVS operations, a go-around would be executed unless the RVR reported prior to commencement of the approach was sufficient for the approach to be flown without the use of EFVS in lieu of natural vision.

- (g) EFVS image requirements at the DA/H are specified in [AMC7 SPA.LVO.105\(c\)](#).

The requirements for features to be identifiable on the EFVS image in order to continue approach below DH are more stringent than the visual reference requirements for the same approach flown without EFVS. This is necessary because the EFVS might not display the colour of lights used to identify specific portions of the runway and might not consistently display the runway markings. Any visual approach path indicator using colour-coded lights may be unusable.

- (h) Obstacle clearance in the visual segment

The 'visual segment' is the portion of the approach between the DH and the runway threshold. In the case of EFVS operations, this part of the approach may be flown using the EFVS image as the primary reference and there may be obstacles that are not always identifiable on an EFVS image. Approach procedures designed in accordance with PANS-OPS criteria is required to ensure that the visual segment is protected for obstacles by the visual segment surface (VSS) that extends from 60 m before the threshold to the location of the OCH. Procedures not designed in accordance with PANS-OPS may have not been assessed for terrain or obstacle

clearance below the OCH and may not provide a clear vertical path to the runway at the normally expected descent angle. SA CAT I and CAT II/III runways subject to EU aerodrome regulations are required to provide an OFZ, which offers protection from obstacles in the visual segment. Standard CAT I runways may also provide an OFZ and if not, the lack of an OFZ shall be indicated, according to ICAO Annex 4, normally on the approach chart.

- (i) Visual reference requirements at minimum height to continue approach without natural visual reference

For operations other than EFVS to touchdown, natural visual reference is required before landing. The objective of this requirement is to ensure that the pilot will have sufficient visual reference to land. The visual reference should be the same as the one required for the same approach flown without the use of EFVS. The specific height at which this is required will depend on the capability of the aircraft installation and will be specified in the AFM. For aircraft certified for EFVS operations but where no such height is specified in the AFM, natural visual reference is required by a height of 100 ft above the threshold elevation.

Specific EFVSs may have additional requirements that must be fulfilled at this height to allow the approach to continue, such as a requirement to check that the elements of the EFVS display remain correctly aligned and scaled to the external view. Any such requirements will be detailed in the AFM.

- (j) Use of EFVS to touchdown

In order for the use of EFVS to touchdown to be approved, the EFVS will provide flare prompt or flare guidance (EFVS-L). This mitigates the fact that a 2D image and a narrow FOV displayed by the EFVS may cause erroneous perceptions of depth or height. The EFVS will also display height above the runway by the use of a radio altimeter or other device capable of providing equivalent performance. Unless the operator has verified that the terrain ahead of the threshold and landing system assessment area (LSAA) slope is suitable for the use of a radio altimeter, such a system should not be relied upon to provide accurate information about the height of the aircraft above the runway threshold until the aircraft is over the runway surface.

- (k) Go-around

A go-around will be promptly executed if the required visual references are not maintained on the EFVS image at any time after the aircraft has descended below the DA/H or if the required visual references are not distinctly visible and identifiable using natural vision after the aircraft is below the minimum height to continue approach without natural visual reference (if applicable). It is considered more likely that an operation with EFVS could result in initiation of a go-around below the DA/H than the equivalent approach flown without EFVS. According to AMC1 SPA.LVO.105(f), operators involved in EFVS operations should keep records of the number of successful and unsuccessful approaches using EFVS in order to detect and act on any undesirable trends.

For category II and III PA procedures designed in accordance with PANS-OPS criteria, obstacle protection is provided for a go-around initiated below the DH (balked landing) by means of an obstacle free zone (OFZ). An OFZ may also be provided for category I PA procedures. Where an OFZ is not provided for a category I PA, this may be indicated on the approach chart. NPA procedures and approach procedures with vertical guidance provide obstacle clearance for the missed approach based on the assumption that the missed approach is executed at or above the DH. The DH should be located at or before the MAPt.

GM5 SPA.LVO.100(c) Low-visibility operations and operations with operational credits

ED Decision 2022/012/R

OPERATIONS WITH OPERATIONAL CREDITS — COMBINED VISION SYSTEMS

A combined vision system (CVS) consisting of an EFVS and an SVS can be approved for EFVS operations if it meets all the certification requirements for an EFVS.

GM6 SPA.LVO.100(c) Low-visibility operations and operations with operational credits

ED Decision 2022/012/R

OPERATIONS WITH OPERATIONAL CREDITS — HELICOPTER SPECIAL AUTHORISATION CATEGORY I (HELI SA CAT I) OPERATIONS

HELI SA CAT I is an operational credit that exploits a navigation solution with superior performance to that required for standard CAT I by extending the instrument segment of CAT I approach operations. This navigation solution may be an ILS installation with the necessary performance coupled to a suitably certified 3- or 4-axis autopilot capable of handling low speeds, together with the superior outside visibility of the helicopter on the visual segment, and the go-around performance of a helicopter. The better outside visibility and the lower speed allows a reduction in the RVR required for the approach, for a given DH. With a 4-axis autopilot and auto-level-off capability, the DH can also be reduced from the standard minimum of 200 ft down to 150 or 130 ft.

HELI SA CAT I is not a separate approach classification; it is an operational credit applied to a CAT I operation.

SPA.LVO.105 Specific approval criteria

Regulation (EU) 2021/2237

To obtain a specific approval as required by [SPA.LVO.100](#), the operator shall demonstrate that:

- (a) for low-visibility approach operations, LVTO operations in an RVR less than 125 m, and operations with operational credits, the aircraft has been certified for the intended operations;
- (b) the flight crew members are competent to conduct the intended operation and a training and checking programme for the flight crew members and relevant personnel involved in the flight preparation has been established, in accordance with [SPA.LVO.120](#);
- (c) operating procedures for the intended operations have been established;
- (d) any relevant changes to the minimum equipment list (MEL) have been made;
- (e) any relevant changes to the maintenance programme have been made;
- (f) procedures have been established to ensure the suitability of aerodromes, including instrument flight procedures, for the intended operations, in accordance with [SPA.LVO.110](#); and
- (g) for the intended operations, a safety assessment has been carried out, and performance indicators have been established to monitor the level of safety.

AMC1 SPA.LVO.105(a) Specific approval criteria

ED Decision 2022/012/R

AIRCRAFT CERTIFICATION FOR THE INTENDED OPERATIONS

- (a) Aircraft used for LVTO in an RVR of less than 125 m should be equipped with a system certified for the purpose.
- (b) Aircraft used for low-visibility approach operations should be equipped in accordance with the applicable airworthiness requirements and certified as follows:
 - (1) For CAT II operations, the aircraft should be certified for CAT II operations.
 - (2) For CAT III operations, the aircraft should be certified for CAT III operations.
 - (3) For SA CAT I, the aircraft should be certified for SA CAT I operations.
 - (4) For SA CAT II, the aircraft should be certified for CAT II operations and be equipped with HUDLS or fail-passive autoland or better.
 - (5) For EFVS operations, the aircraft should be equipped with a certified EFVS-A or EFVS-L.

GM1 SPA.LVO.105(a) Specific approval criteria

ED Decision 2022/012/R

AIRCRAFT CERTIFICATION — EQUIPMENT ELIGIBLE FOR LOW VISIBILITY TAKE-OFF IN AN RVR LESS THAN 125 M

Systems that are used to qualify for take-off in an RVR less than 125 m typically allow the pilot to use the external visual cues as well as instrumented guidance to track the runway centre line. The kind of systems in use today include paravisual display (PVD) and HUD. It is expected that EFVSs will be certified for take-off guidance in the future. Where the PVD or HUD uses an ILS localiser signal as reference, the ILS sensitive area must be protected by the LVPs at the aerodrome.

AMC1 SPA.LVO.105(c) Specific approval criteria

ED Decision 2022/012/R

OPERATING PROCEDURES FOR LVOs

Prior to commencing an LVO, the pilot-in-command/commander should be satisfied that:

- (a) the status of visual and non-visual facilities is as required;
- (b) if LVPs are required for such operations, LVPs are in effect; and
- (c) the flight crew members are appropriately qualified.

AMC2 SPA.LVO.105(c) Specific approval criteria

ED Decision 2022/012/R

OPERATING PROCEDURES — GENERAL

- (a) Operating procedures should be established for all types of LVOs and operations with operational credits for which an operator is seeking approval. The operating procedures should:
 - (1) be consistent with the AFM;
 - (2) be appropriate to the technology and equipment to be used;

- (3) specify the duties and responsibilities of each flight crew member in each relevant phase of flight;
 - (4) ensure that flight crew workload is managed to facilitate effective decision-making and monitoring of the aircraft; and
 - (5) minimise, as much as practical, the deviation from normal procedures used for routine operations (non-LVOs).
- (b) Operating procedures should include:
- (1) the required checks for the satisfactory functioning of the aircraft equipment, both before departure and in flight;
 - (2) the correct seating and eye position;
 - (3) determination of aerodrome operating minima;
 - (4) the increment to be added to minima for use by pilots-in-command/commanders who are new to the aircraft type, if applicable;
 - (5) the effect on aerodrome operating minima of temporarily failed or downgraded ground equipment;
 - (6) the effect on aerodrome operating minima of the failure or change of the status of any aircraft systems;
 - (7) when the LVPs at the aerodrome are required. LVPs are required:
 - (i) for low-visibility flight approach operations;
 - (ii) for LVTOs with RVR less than 400 m.

If an operator selects an aerodrome with equivalent procedures, where the term 'LVPs' is not used (e.g. regional procedures), the operator should verify that suitable procedures are established to ensure an equivalent level of safety to that achieved at approved aerodromes. This situation should be clearly noted in the operations manual or procedures manual, including guidance to the flight crew on how to determine that the suitable procedures are in effect at the time of an actual operation. Note: the AFM may state that some elements of LVPs are not required and therefore the equivalent level of safety may be established on that basis;
 - (8) a requirement for an 'approaching minima' call-out to prevent inadvertent descent below the DA/H;
 - (9) the requirement for height call-outs below 200 ft to be based on the use of a radio altimeter or other device capable of providing equivalent performance, if applicable;
 - (10) the required visual references;
 - (11) the action to be taken in the event of loss of the required visual references; and
 - (12) the maximum allowable flight path deviations and action to be taken in the event that such deviations occur.
- (c) Operators required to comply with the requirements of Annex III (Part-ORO) to this Regulation should include operating procedures in the operations manual as required by [ORO.MLR.100](#). The operators to which Part-ORO does not apply should include the operating procedures in a 'procedures manual'.

AMC3 SPA.LVO.105(c) Specific approval criteria

ED Decision 2022/012/R

OPERATING PROCEDURES — CAT II

For CAT II operations, the following should apply:

- (a) The flight crew should consist of at least two pilots.
- (b) The approach should be flown using a certified system as identified in the AFM.
- (c) If the approach is flown using autopilot, for a manual landing the autopilot should remain engaged until after the pilot has achieved visual reference.
- (d) All height call-outs below 200 ft above the runway threshold elevation should be determined by the use of a radio altimeter or other device capable of providing equivalent performance.
- (e) The DH should be determined by the use of a radio altimeter or other device capable of providing equivalent performance, if so determined by the aircraft certification process.
- (f) At DH, the following visual references should be distinctly visible and identifiable to the pilot:
 - (1) a segment of at least three consecutive lights, which are the centre line of the approach lights or TDZ lights or runway centre line lights or edge lights or a combination of these; and
 - (2) a visual reference that should include a lateral element of the ground pattern, such as an approach lighting crossbar, or the landing threshold, or a barrette of the TDZ lighting unless the operation is conducted using a HUD or an equivalent system to touchdown.

AMC4 SPA.LVO.105(c) Specific approval criteria

ED Decision 2022/012/R

OPERATING PROCEDURES — CAT III

For CAT III operations, the following should apply:

- (a) The flight crew should consist of at least two pilots.
- (b) The approach should be flown using a certified system as identified in the AFM.
- (c) All height call-outs below 200 ft above the runway threshold elevation should be determined by the use of a radio altimeter or other device capable of providing equivalent performance.
- (d) For operations in which a DH is used, the DH should be determined by the use of a radio altimeter or other device capable of providing equivalent performance, if so determined by the aircraft certification process.
- (e) At DH, the following visual references should be distinctly visible and identifiable to the pilot:
 - (1) for operations conducted either with fail-passive flight control systems or with the use of an approved HUD or equivalent display system: a segment of at least three consecutive lights, which are the centre line of the approach lights, or TDZ lights, or runway centre line lights, or runway edge lights, or a combination of these; and
 - (2) for operations conducted either with fail-operational flight control systems or with a fail-operational hybrid landing system using a DH: at least one centre line light to be attained and maintained by the pilot.

- (f) For operations with no DH, there is no specification for visual reference with the runway prior to touchdown.

AMC5 SPA.LVO.105(c) Specific approval criteria

ED Decision 2022/012/R

OPERATING PROCEDURES — SA CAT I

For SA CAT I operations, the following should apply:

- (a) The approach should be flown using a certified system as identified in the AFM.
- (b) All height call-outs below 200 ft above the runway threshold elevation should be determined by the use of a radio altimeter or other device capable of providing equivalent performance.
- (c) The DH should be determined by the use of a radio altimeter or other device capable of providing equivalent performance, if so determined by the aircraft certification process.
- (d) At DH the following visual references should be visible to the pilot:
 - (1) a segment of at least three consecutive lights, which are the centre line of the approach lights, or TDZ lights, or runway centre line lights, or runway edge lights, or a combination of these; and
 - (2) a visual reference that should include a lateral element of the ground pattern, such as an approach lighting crossbar, or the landing threshold, or a barrette of the TDZ lighting unless the operation is conducted utilising an approved HUD or an equivalent system usable down to 120 ft above the runway threshold.

AMC6 SPA.LVO.105(c) Specific approval criteria

ED Decision 2022/012/R

OPERATING PROCEDURES — SA CAT II

For SA CAT II operations, the following should apply:

- (a) The flight crew should consist of at least two pilots.
- (b) The approach should be flown using a certified HUDLS or autoland system as identified in the AFM.
- (c) All height call-outs below 200 ft above the runway threshold elevation should be determined by the use of a radio altimeter or other device capable of providing equivalent performance.
- (d) The DH should be determined by the use of a radio altimeter or other device capable of providing equivalent performance, if so determined by the aircraft certification process.
- (e) At DH the visual references should be distinctly visible and identifiable to the pilot:
 - (1) a segment of at least three consecutive lights, which are the centre line of the approach lights or TDZ lights, or runway centre line lights, or runway edge lights or a combination of these;
 - (2) a visual reference that should include a lateral element of the ground pattern, such as an approach lighting crossbar, or the landing threshold, or a barrette of the TDZ lighting.

AMC7 SPA.LVO.105(c) Specific approval criteria

ED Decision 2022/012/R

OPERATING PROCEDURES — EFVS OPERATIONS TO A RUNWAY

For EFVS operations to a runway, the following should apply:

- (a) The approach should be flown using a certified EFVS-A or EFVS-L as identified in the AFM.
- (b) The pilot flying should use the EFVS throughout the approach.
- (c) In multi-pilot operations, the pilot monitoring should monitor the EFVS-derived information.
- (d) The approach between the final approach fix (FAF) and the DA/H should be flown using vertical flight path guidance mode (e.g. flight director).
- (e) The approach may be continued below the DA/H provided that the pilot can identify on the EFVS image either:
 - (1) the approach light system; or
 - (2) both of the following:
 - (i) the runway threshold identified by the beginning of the runway landing surface, the threshold lights or the runway end identifier lights; and
 - (ii) the TDZ identified by the TDZ lights, the TDZ runway markings or the runway edge lights.
- (f) Unless the aircraft is equipped with a certified EFVS-L, a missed approach should be executed promptly if the required visual reference is not distinctly visible and identifiable to the pilot without reliance on the EFVS by the following height above the threshold:
 - (1) the height below which an approach should not be continued if natural visual reference is not acquired by the crew as stated in the AFM; or
 - (2) if the AFM does not specify such a height, 100 ft.

GM1 SPA.LVO.105(c) Specific approval criteria

ED Decision 2022/012/R

FLIGHT CREW ACTIONS IN CASE OF AUTOPILOT FAILURE AT OR BELOW DH IN FAIL-PASSIVE CAT III OPERATIONS

For operations to actual RVR values less than 300 m, a missed approach procedure is assumed in the event of an autopilot failure at or below DH. This means that a missed approach procedure is the normal action. However, the wording recognises that there may be circumstances where the safest action is to continue the landing. Such circumstances include the height at which the failure occurs, the actual visual references, and other malfunctions. This would typically apply to the late stages of the flare. In conclusion, it is not forbidden to continue the approach and complete the landing when the pilot-in-command/commander determines that this is the safest course of action. The operator's policy and the operational instructions should reflect this information.

AMC1 SPA.LVO.105(g) Specific approval criteria

ED Decision 2022/012/R

SAFETY ASSESSMENT — MONITORING, DATA COLLECTION AND PERFORMANCE INDICATORS

- (a) The operator should monitor LVOs and operations with operational credits in order to validate the effectiveness of the applicable aircraft flight guidance systems, training, flight crew procedures, and aircraft maintenance programme, and to identify hazards.
- (b) Data should be collected whenever an LVO or an operation with an operational credit is attempted regardless of whether the approach is abandoned, is unsatisfactory, or is concluded successfully. The data should include records of the following:
 - (1) occasions when it was not possible to commence an approach due to deficiencies or unserviceabilities of related airborne equipment;
 - (2) occasions when approaches were discontinued, including the reasons for discontinuing the approach and the height above the runway at which the approach was discontinued;
 - (3) occasions when system abnormalities required pilot intervention to ensure a continued approach or safe landing;
 - (4) landing performance, whether or not the aircraft landed satisfactorily within the desired touchdown area with acceptable lateral velocity or cross-track error. The approximate lateral and longitudinal position of the actual touchdown point in relation to the runway centre line and the runway threshold, respectively, should be recorded.
- (c) Data about LVOs should be collected by means of the operator's flight data monitoring programme supplemented by other means including reports submitted by flight crew. Operators that do not have a flight data monitoring programme should use reports submitted by flight crew as the primary means of gathering data.
- (d) Performance indicators should include the following:
 - (1) the rate of unsuccessful low-visibility approaches, i.e. the number of attempted approaches terminating in discontinued approaches, approaches where pilot intervention was required to ensure a continued approach or safe landing or where landing performance was unsatisfactory, compared to the number of low-visibility approaches attempted;
 - (2) measures of performance of the airborne equipment for low-visibility approaches or operations with operational credits;
 - (3) safety performance indicators related to other specific risks associated with LVOs.
- (e) The following information should be retained for at least 5 years:
 - (1) the total number of low-visibility approaches or operations with an operational approval attempted or completed, including practice approaches, by aircraft type; and
 - (2) reports of unsatisfactory approaches and/or landings, by runway and aircraft registration, in the following categories:
 - (i) airborne equipment faults;
 - (ii) ground facility difficulties;
 - (iii) missed approaches because of air traffic control (ATC) instructions; or
 - (iv) other reasons.

AMC2 SPA.LVO.105(g) Specific approval criteria

ED Decision 2022/012/R

SAFETY ASSESSMENT PRIOR TO OBTAINING AN APPROVAL

- (a) Prior to commencing LVOs or operations with operational credits, an operator should demonstrate to the competent authority that such operations will achieve an acceptable level of safety. This requires the operator to gather data from operations using the relevant systems and procedures and conduct safety assessments taking that data into account.
- (b) The operator applying for the approval of low-visibility approach operations should determine the minimum number of approaches required to gather sufficient data to demonstrate an acceptable level of safety and the time period over which such data should be gathered.
- (c) If an operator is applying for more than one LVO approval or an approval for operation with operational credits for a particular aircraft type, then data gathered from operations using the systems and procedures designed for one classification of operations or operation with operational credits may be used to support the application for another classification of operations or operation with operational credits provided the following elements are similar:
 - (1) type of technology, including:
 - (i) flight control/guidance system (FGS) and associated displays and controls;
 - (ii) flight management system (FMS) and level of integration with the FGS;
 - (iii) use of HUD or an equivalent display system; and
 - (iv) use of EFVS;
 - (2) operational procedures, including:
 - (i) alert height;
 - (ii) manual landing/automatic landing;
 - (iii) no DH operations;
 - (iv) use of HUD or an equivalent display system in hybrid operations; and
 - (v) use of EFVS to touchdown; and
 - (3) handling characteristics, including:
 - (i) manual landing from automatic or HUD or an equivalent display system guided approach;
 - (ii) manual missed approach procedure from automatic approach; and
 - (iii) automatic/manual roll-out.
- (d) An operator holding an approval for low-visibility approach operations or operations with operational credits may use data gathered from approaches conducted using one aircraft type to support an application for approval for a different aircraft type or variants provided the following elements are similar:
 - (1) type of technology, including the following:
 - (i) FGS and associated displays and controls;
 - (ii) FMS and level of integration with the FGS;

- (iii) use of HUD or an equivalent display system; and
- (iv) use of EFVS;
- (2) operational procedures, including:
 - (i) alert height;
 - (ii) manual landing/automatic landing;
 - (iii) no DH operations;
 - (iv) use of HUD or an equivalent display system in hybrid operations; and
 - (v) use of EFVS to touchdown; and
- (3) handling characteristics, including:
 - (i) manual landing from automatic or HUD or an equivalent display system guided approach;
 - (ii) manual missed approach procedure from automatic approach; and
 - (iii) automatic/manual roll-out.

GM1 SPA.LVO.105(g) Specific approval criteria

ED Decision 2022/012/R

SPECIFIC APPROVAL CRITERIA — SUCCESSFUL APPROACH AND LANDING

- (a) The purpose of this GM is to provide operators with supplemental information regarding the criteria for a successful approach and landing.
- (b) An approach may be considered to be successful if:
 - (1) from 500 ft to start of flare:
 - (i) speed is maintained within +/- 5 kt of the intended speed, disregarding rapid fluctuations due to turbulence;
 - (ii) no relevant system failure occurs;and
 - (2) from 300 ft to DH:
 - (i) no excess deviation occurs; and
 - (ii) no centralised warning gives a missed approach procedure command (if installed).
- (c) A landing may be considered to be successful if:
 - (1) no relevant system failure occurs;
 - (2) no flare failure occurs;
 - (3) no de-crab failure occurs (if installed);
 - (4) longitudinal touchdown is beyond a point on the runway 150 m after the threshold and before the end of the touchdown zone (TDZ) (750 m from the threshold);
 - (5) lateral touchdown with the outboard landing gear is not outside the TDZ edge;
 - (6) sink rate is not excessive;

- (7) bank angle does not exceed a bank angle limit; and
 - (8) no roll-out failure or deviation (if installed) occurs.
- (d) More details can be found in CS AWO.A.ALS.106, CS AWO.B.CATII.113 and AMC AWO.B.CATII.113.

GM2 SPA.LVO.105(g) Specific approval criteria

ED Decision 2022/012/R

SAFETY PERFORMANCE MONITORING

- (a) Data gathering for safety performance monitoring of LVOs and operations with operational credits will need to include sufficient information for the operator to identify hazards and assess the risks associated with LVOs and operations with operational credits.
- (b) The following data relating to LVOs and operations with operational credits may be gathered via flight crew reports, flight data monitoring or other means, as appropriate:
 - (1) date and time;
 - (2) aircraft details (type and registration);
 - (3) airport, approach procedure, final approach and take-off area (FATO) and/or runway used;
 - (4) the type of LVO or operation with operational credits attempted or completed;
 - (5) weather conditions including wind, reported RVR and natural phenomena that restrict visibility;
 - (6) the reason for a discontinued approach (if applicable);
 - (7) details of any pilot intervention to ensure a continued approach or safe landing;
 - (8) adequacy of speed control;
 - (9) trim at time of automatic flight control system disengagement (if applicable);
 - (10) compatibility of automatic flight control system, flight director and raw data;
 - (11) an indication of the position of the aircraft relative to the centre line when descending through to 100 ft;
 - (12) touchdown position relative to the TDZ;
 - (13) an assessment of the sink rate, lateral velocity and bank angle at touchdown;
 - (14) the nature of any problems encountered by the crew in relation to operating procedures or training; and
 - (15) any human factors issues that arose in relation to the operation.
- (c) Where data is gathered as part of the operator's flight data monitoring programme, procedures should be established to ensure that information that is only available directly from the flight crew or other sources (e.g. weather information) is captured.
- (d) In order to assess the risks associated with LVOs and operations with operational credits, operators may consider hazards with the potential to result in the following unacceptable safety outcomes:

-
- (1) loss of control in flight;
 - (2) runway overrun or excursion;
 - (3) controlled flight into terrain;
 - (4) runway incursion and ground collision; and
 - (5) airborne conflict.
- (e) Operators' safety control processes will ensure that LVOs and operations with operational credits:
- (1) meet the safety objectives and performance standards established in the operator's safety policy;
 - (2) achieve at least the same level of safety as operations other than LVOs and operations without operational credits; and
 - (3) have a continuously improving safety performance.
- (f) Two methods to determine the rate of unsuccessful low-visibility approaches are described below:
- (1) Fail/pass method (binary): the rate of unsuccessful low-visibility approaches determined in accordance with [GM1 SPA.LVO.105\(g\)](#) should not exceed 5 %. If the unsuccessful operations appear to occur on a given aircraft, aircraft series or runway, specific mitigation measures need to be established and a separate specific rate may need to be calculated and monitored. Note: the term 'aircraft series' is explained in [GM5 SPA.LVO.110](#). Operators may choose to apply a lower rate than 5 %.
 - (2) Continuous method: this method may be selected by operators with a flight data monitoring programme. This methodology is more refined and allows identifying undesirable trends earlier and possibly before they become severe. This method applies an event monitoring methodology in which the deviations from the nominal performance are categorised according to their severity (severity index). For each event (criterion), a level of deviation may be defined as follows:
 - (i) Low ('green': the deviation is small and within the limits of nominal behaviour. No action is required.)
 - (ii) Medium ('yellow'): the deviation is above the criteria for low ('green') and below the criteria for high ('red'). No corrective action should be required based on an isolated occurrence; however, a corrective action should be taken if the situation does not improve, or a negative trend is identified. The monitoring should then focus on the particular runway or aircraft series or combination of those.
 - (iii) High ('red'): the deviation is undesirably high. Investigation and corrective action should be undertaken even based on an isolated occurrence. The threshold for level high ('red') may be based on the criteria of [GM1 SPA.LVO.105\(g\)](#).

GM3 SPA.LVO.105(g) Specific approval criteria

ED Decision 2022/012/R

DATA GATHERING FOR SAFETY ASSESSMENT PRIOR TO OBTAINING AN APPROVAL

(a) General

The intention of the safety assessment is to validate the use and effectiveness of the applicable aircraft flight control and guidance systems, procedures, flight crew training and aircraft maintenance programme. The intention is not to repeat the statistical analysis required for certification of equipment, but rather to demonstrate that the various elements of the 'total system' for LVOs work together for a particular operator.

(b) Data gathering for safety assessment — LVTOs

(1) If the procedures used for LVTOs are not significantly different from those used for standard take-offs, it may be sufficient for operators to conduct only a small number of take-offs using the procedures established for LVTOs for the purpose of data gathering. The following could be considered as a minimum:

- (i) For LVTOs in an RVR of 125 m or more if procedures are similar to those used for standard take-offs: 1 take-off;
- (ii) For LVTOs in an RVR of less than 125 m or any other LVTOs using specific procedures: 10 take-offs.

(2) An operator holding an approval for LVTOs on one aircraft type and applying the approval for LVTOs on another type or variant may use data from LVTOs conducted on the first type if the following are similar:

- (i) level of technology, including flight deck displays, HUD or an equivalent guidance system;
- (ii) operational procedures; and
- (iii) handling characteristics.

(c) Data gathering for safety assessment — approach operations with a DH below 200 ft

The data required for the safety assessment needs to be gathered from approaches conducted in a representative sample of expected operating conditions. The operator needs to take seasonal variations in operating conditions such as prevalent weather, planned destinations and operating bases, and ensure that the approaches used for data gathering are conducted over a sufficient period of time to be representative of the planned operation.

In order to ensure that the data is representative of planned operations, approaches are conducted at a variety of airports and runways. If more than 30 % of the approaches are conducted to the same runway, the operator may increase the number of approaches required and take measures to ensure that the data is not distorted.

The number of approaches used for data gathering will depend on the performance indicators and analysis methods used by the operator. The operator will need to demonstrate that the operation for which approval is sought will achieve an acceptable level of safety. The following figures may be considered a minimum for an operator without previous experience of low-visibility approach operations:

- (1) for approval of operations with a DH of not less than 50 ft: 30 approaches;
- (2) for approval of operations with a DH of less than 50 ft: 100 approaches.

Approaches conducted for the purpose of gathering data in order to conduct a safety assessment prior to obtaining an LVO approval may be conducted in line operations or any other flight where the operator's procedures are used. Approaches may also be conducted in an FSTD if the operator is satisfied that this would be representative of the operation.

The data gathered from these approaches will only be representative if all required elements of the total system for LVOs are in place. These include not only operating procedures and airborne equipment, but also airport and ATC procedures and ground- or space-based navigation facilities. If the operator chooses to collect data from approaches conducted without all required elements in place, then the data analysis takes into account the effect of at least the following:

- (1) air traffic services (ATS) factors including situations where a flight conducting an instrument approach is vectored too close to the FAF for satisfactory lateral and vertical path capture, lack of protection of ILS sensitive areas or ATS requests to discontinue the approach;
 - (2) misleading navigation signals such as ILS localiser irregularities caused by taxiing aircraft or aircraft overflying the localiser array;
 - (3) other specific factors that could affect the success of LVOs that are reported by the flight crew.
- (d) Safety considerations for approaches used for data gathering
- If an operator chooses to collect data from approaches conducted without all required elements of the total system for LVOs in place, then the operator takes actions to ensure an acceptable level of safety.
- (e) Sharing of data: operators may use data from other operators or aircraft manufacturers to support the safety assessment required to demonstrate an acceptable level of safety. The operator applying for a specific approval would need to demonstrate that the data used was relevant to the proposed operation.
- (f) It is expected that operators will have more than 6 months or at least 1 000 hours of total operational experience on the aircraft model before they can have sufficient data to set up meaningful performance indicators and establish whether planned LVOs would achieve an acceptable level of safety.

SPA.LVO.110 Aerodrome-related requirements, including instrument flight procedures

Regulation (EU) 2021/2237

The operator shall ensure that only aerodromes, including instrument flight procedures, suitable for the intended operations are used for LVOs and operations with operational credits.

AMC1 SPA.LVO.110 Aerodrome-related requirements, including instrument flight procedures

ED Decision 2022/012/R

SUITABLE AERODROMES — ASSESSMENT — AEROPLANES

- (a) The assessment of the suitability of an aerodrome, including instrument flight procedures, for the intended operations comprises the availability of:

-
- (1) suitable navigation facilities and associated instrument flight approach procedures;
 - (2) suitable aerodrome operating procedures, including LVPs, and the compatibility with the intended aircraft operations; and
 - (3) suitable runway and runway environment characteristics and facilities.
- (b) The assessment of the suitability of an aerodrome, including instrument flight procedures, for the intended operations should be made by means of one or a combination of the following:
- (1) An assessment of previous operational data for the particular aerodrome, runway and instrument flight procedures. This entails the verification of the availability of previous operational data, such as records of approaches flown in the same aerodrome, with the same procedures and aircraft type.
 - (2) A desktop assessment of the:
 - (i) aerodrome data;
 - (ii) instrument flight procedures; and
 - (iii) the aircraft data and capabilities.

This desktop assessment compares aircraft data and capabilities and the aerodrome and instrument approach characteristics. If the aircraft data is compatible with the aerodrome and instrument approach procedure characteristics, the aerodrome and runway should be considered suitable for the intended LVO;

- (3) An operational assessment

This is meant to be used if the suitability of the aerodrome for the intended operations could not be positively assessed by means of the other methods. In that case, an operational assessment becomes necessary, and actual flights should be performed. The operational assessment should consider the level of complexity of the aerodrome characteristics.

ASSESSMENT OF PREVIOUS OPERATIONAL DATA

- (c) Previous operational data refers to data from:
- (1) the operator itself, or when not available;
 - (2) the following entities:
 - (i) the State of the aerodrome or the competent authority issuing the operator's LVO approval;
 - (ii) the type certificate holder of the aircraft; or
 - (iii) other operators.
- (d) Previous operational data should only be used if:
- (1) it concerns the same runway and there were no relevant changes to the runway and runway environment;
 - (2) it is derived in accordance with Table 14 below for the intended operation; and
 - (3) there is no safety concern for such operation.

- (e) Previous operational data may be credited to an aircraft if it is from:
- (1) the same aircraft make and model, unless the credit from the same aircraft make and model is restricted by any of the entities in point (c)(2); or
 - (2) another aircraft model, if stated in the AFM or additional data from the TC/STC holder.

Table 14

Intended operation	Operation from which previous operational data was derived – subject to the conditions specified in points (c), (d) and (e)	Remark
SA CAT I – automatic landing	CAT I/II/III – automatic landing SA CAT I – automatic landing SA CAT II – automatic landing LTS CAT I – automatic landing	Automatic landing in hybrid systems may also be used
SA CAT I – HUDLS	CAT II/III – HUDLS SA CAT I – HUDLS SA CAT II – HUDLS LTS CAT I – HUDLS	
SA CAT II – automatic landing	CAT II/III – automatic landing SA CAT II – automatic landing	Automatic landing in hybrid systems may also be used
SA CAT II – HUDLS	SA CAT II – HUDLS CAT II/III – HUDLS	
CAT II – HUD to below DH with manual landing	CAT II – HUD to below DH with manual landing CAT II or CAT III – automatic landing CAT II or CAT III HUDLS SA CAT II HUDLS	Data related to the LSAA should only be used in the case of HUDLS or automatic landing
CAT II – auto-coupled to below DH with manual landing	CAT II – auto-coupled to below DH with manual landing CAT II or CAT III – automatic landing SA CAT II automatic landing	
CAT II – automatic landing	CAT II – automatic landing SA CAT II – automatic landing CAT III automatic landing	Automatic landing in hybrid systems may also be used
CAT II – HUDLS	CAT II or CAT III – HUDLS SA CAT II – HUDLS	
CAT III – HUDLS	CAT III – HUDLS	
CAT III – automatic landing	CAT III – automatic landing	If the hybrid system uses automatic landing, then the data may be used as any CAT III system.
CAT III – hybrid system	CAT III – hybrid system based on same components	
EFVS operations requiring flare prompt or flare command, i.e. EFVS-L	EFVS operations requiring flare prompt or flare commands	

Note: Previous operational data should be based on the same kind of xLS (e.g. ILS to ILS, MLS to MLS or GLS to GLS). Data related to landing system performance derived from infrastructure systems with lower performance may be used on systems with higher performance (e.g. data derived from a

CAT II ILS may be used on a CAT III ILS). However, an ILS may qualify a GLS operation under the following conditions:

- The performance of the ILS installation on which the data is based can only be credited to the ILS point promulgate.
- An ILS facility performance category II installation can only be credited an operation using GAST C.
- An ILS facility performance category III installation can only be credited to an operation GAST C or GAST D.

DESKTOP ASSESSMENT — AERODROME DATA, INSTRUMENT FLIGHT PROCEDURE AND AIRCRAFT DATA AND CAPABILITIES

- (f) The desktop assessment should correspond to the nature and complexity of the operation intended to be carried out and should take into account the hazards and associated risks inherent in these operations.
- (g) The assessment should include the AFM or additional data from the TC/STC holder, instrument flight procedures and aerodrome data. For landing systems, the runway or airport conditions should include as a minimum:
 - (1) the approach path slope;
 - (2) the runway elevation;
 - (3) the type of xLS navigation means intended to be used;
 - (4) the average slope of the LSAA; and
 - (5) the ground profile under the approach path (pre-threshold terrain). The distance should be calculated from the published threshold. It should be 300 metres, unless otherwise stated by the AFM or additional data from the TC/STC holder, the State of the aerodrome or AIP data, or the competent authority issuing the operator's LVO approval.

Note: The above points assume a CAT II or CAT III runway. For other types of runways, the operator may need to consider other factors.

- (h) In addition to (g), additional elements may need to be included in the assessment if stated by:
 - (1) the AFM, or additional data from the TC/STC holder; or
 - (2) the State of the aerodrome or AIP data; or
 - (3) the competent authority issuing the operator's LVO approval.
- (i) For EFVS operations, the following applies:

If the system used to perform an EFVS operation contains a flare cue, each aircraft type/equipment/runway combination should be verified before authorising the use of EFVS-L, on any runway with irregular pre-threshold terrain (not within the certification assumption for pre-threshold terrain), if the LSAA presents significant slope change.

OPERATIONAL ASSESSMENT

- (j) When performing an operational assessment, the operator should verify each aircraft type and runway combination by successfully completing the determined number of approaches and landings according to the process in point (l) below and the conditions determined in Table 15.

Table 15

Type of approach	RVR/VIS
CAT III	CAT II conditions if the approach was previously successfully assessed in CAT II operations
CAT II & CAT III	CAT I conditions
EFVS-A	As per instrument approach no EFVS credits
SA CAT I & SA CAT II	CAT I conditions

- (k) The operational assessment should validate the use and effectiveness of the aircraft flight guidance systems, and operating procedures for the intended operation applicable to a specific instrument flight procedure and runway.
- (l) The process to determine the number of approaches and landings should be based on identified risks and agreed with the competent authority, and comprise the following steps:
 - (1) Identify the risks related to the landing system (based on the AFM or additional data from the TC/STC holder) which may include limitations in the conditions during the operational assessment (e.g. to perform the assessment under a non-commercial flight).
 - (2) Determine complexity of the runway based on:
 - (i) a set of criteria based on the certification assumptions identified in the AFM or additional data from the TC/STC holder;
 - (ii) availability and quality of runway data supporting the risk assessment;
 - (iii) other known factors identified.
 - (3) Scale the number of required approaches based on complexity.
- (m) The operational assessment may be performed in a commercial flight.
- (n) If the operator has different variants of the same type of aircraft, utilising the same landing systems, the operator should show that the variants have satisfactory operational performance, but there is no need to conduct a full operational assessment for each variant/runway combination.
- (o) The operator may replace partially or completely the approaches and landings to a particular runway, if approved by the competent authority, with:
 - (1) simulations made by the aircraft manufacturer or approved design organisations, if the terrain is properly modelled in the simulation;
 - (2) a verification using an FSTD, if the FSTD is suitable for the operational assessment.

ADDITIONAL VERIFICATION OF THE SUITABILITY OF RUNWAYS FOR EFVS OPERATIONS

- (p) The assessment of the suitability of the aerodrome should include whether the approach and runway lights installed (notably incandescent or LED lights) are adequate for the EFVS equipment used by the operator.
- (q) Additionally, the operator should assess obstacles for the following operations:
 - (1) NPA procedures;
 - (2) APV;
 - (3) category I PA procedures on runways where an OFZ is not provided; and

- (4) approach procedures not designed in accordance with PANS-OPS or equivalent criteria.
- (r) The assessment in point (q) should determine whether:
 - (1) obstacle protection can be ensured in the visual segment from DA/H to landing, without reliance on visual identification of obstacles or in the event of a bailed landing; and
 - (2) obstacle lights installed (notably incandescent or LED lights) are adequate for the EFVS equipment used by the operator.
- (s) If the assessment determines that:
 - (1) obstacle clearance cannot be ensured in the visual segment without reliance on visual identification of obstacles, the operator should not authorise EFVS operations to that runway or restrict the operation to the type and/or category of instrument approach operations where obstacle protection is ensured.

Note: Obstacles of a height of less than 50 ft above the threshold may be disregarded when assessing the VSS.
 - (2) obstacle protection is not assured in the event of a go-around initiated at any point prior to touchdown, the operator should not authorise the operation unless procedures to mitigate the risk of inadequate obstacle protection are developed and implemented.
- (t) If the AFM stipulates specific requirements for approach procedures, the operational assessment should include a determination of whether these requirements can be met.

AMC2 SPA.LVO.110 Aerodrome-related requirements, including instrument flight procedures

ED Decision 2022/012/R

SUITABLE INSTRUMENT FLIGHT APPROACH PROCEDURES

- (a) CAT II instrument approach operations should only be conducted using a CAT II IAP.
- (b) CAT III instrument approach operations should only be conducted using a CAT III IAP.
- (c) SA CAT I operations should only be conducted using a SA CAT I IAP or, if not available, a CAT I IAP that includes an OCH based on radio altimeter.
- (d) SA CAT II operations should only be conducted using a SA CAT II IAP or, if not available, a CAT II IAP.
- (e) EFVS operations should only be conducted using an IAP which is offset by a maximum of 3 degrees unless a different approach offset is stated in the AFM.

AMC3 SPA.LVO.110 Aerodrome-related requirements, including instrument flight procedures

ED Decision 2022/012/R

SUITABLE AERODROMES — RUNWAY AND RUNWAY ENVIRONMENT — NAVIGATION FACILITIES — APPROACH OPERATIONS OTHER THAN EFVS OPERATIONS

- (a) For CAT II instrument approach operations, a PA runway category II or category III should be used. The following visual aids should be available:
 - (1) category II approach lights;

-
- (2) standard runway markings;
 - (3) category II runway lights.
- (b) For CAT III instrument approach operations, a PA runway category III should be used. The following visual aids should be available:
- (1) category III approach lights;
 - (2) standard runway markings;
 - (3) category III runway lights.
- (c) For SA CAT I operations:
- (1) where an ILS or MLS or GLS is used, it should not be promulgated with any restrictions affecting its usability and should not be offset from the extended centre line;
 - (2) where an ILS or GLS is used, it should be at least the minimum ILS or GLS classification stated in the AFM and meet any of the required minimum performance parameters stated in the AFM;
 - (3) the glide path angle is 3.0°; a steeper glide path, not exceeding 3.5° and not exceeding the limits stated in the AFM, can be approved provided that an equivalent level of safety is achieved; and
 - (4) runway markings, category I approach lights as well as runway edge lights, runway threshold lights, and runway end lights should be available.
- (d) For SA CAT II operations:
- (1) where an ILS or MLS or GLS is used, it should not be promulgated with any restrictions affecting its usability and should not be offset from the extended centre line;
 - (2) where an ILS or GLS is used, the following applies:
 - (i) if the AFM provides such data, the minimum ILS or GLS classification stated in the AFM; or
 - (ii) when such data is not provided:
 - (A) where an GLS is used, it should be certified to at least GAST-C and to the GBAS point D;
 - (B) where an ILS is used, it should be certified to at least class II/D/2;
 - (3) the glide path angle is 3.0°; a steeper glide path, not exceeding 3.2°, can be approved provided that the operator demonstrates an equivalent level of safety; and
 - (4) the following visual aids should be available:
 - (i) standard runway markings, category I approach lights as well as runway edge lights, runway threshold lights and runway end lights; and
 - (ii) for operations with an RVR of less than 400 m, centre line lights.

AMC4 SPA.LVO.110 Aerodrome-related requirements, including instrument flight procedures

ED Decision 2022/012/R

COLLECT AND DEVELOP AIRPORT DATA NOT CONTAINED IN THE AIP — AEROPLANES

When the operator wishing to use an aerodrome where its relevant data for the purpose of LVO is not provided or some data is not provided, the operator should develop procedures to collect or develop the necessary data. The procedure should be specific to the State of the aerodrome or the area of operation and should be approved by competent authority.

GM1 SPA.LVO.110 Aerodrome-related requirements, including instrument flight procedures

ED Decision 2022/012/R

ASSESSMENT OF AERODROMES FOR THE INTENDED OPERATIONS — AEROPLANES

A diagram with a schematic of the assessment described in [AMC1 SPA.LVO.110 Aerodrome-related requirements, including instrument flight procedures](#) is provided below:

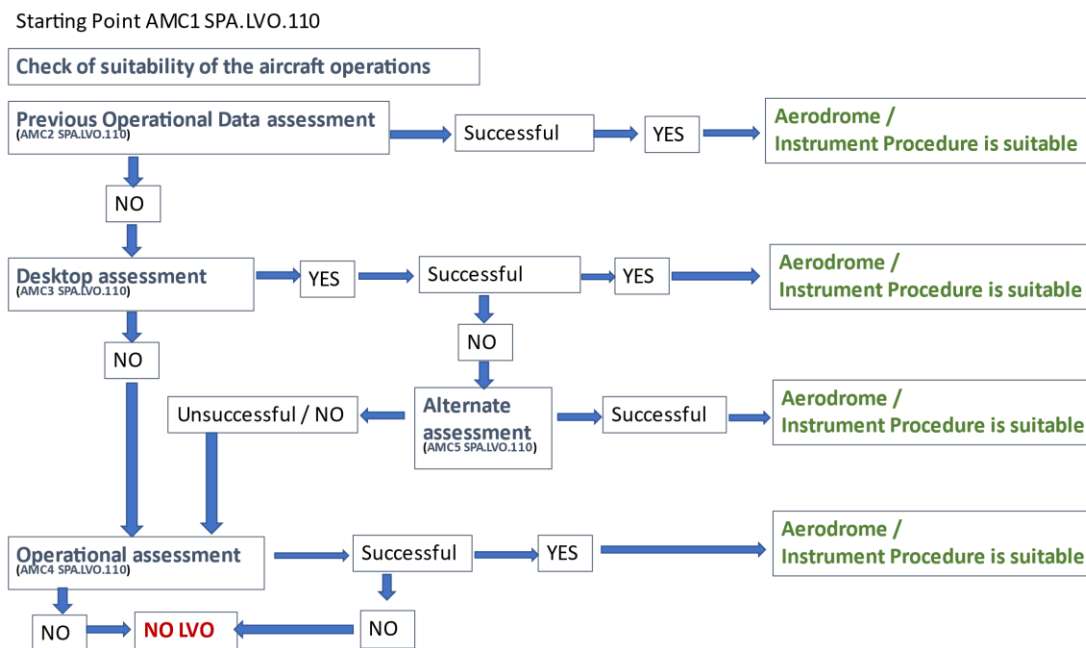

GM2 SPA.LVO.110 Aerodrome-related requirements, including instrument flight procedures

ED Decision 2022/012/R

SUITABLE AERODROMES — ASSESSMENT — AVAILABILITY OF SUITABLE NAVIGATION FACILITIES

As detailed in point (a) of [AMC1 SPA.LVO.110](#), the assessment of the suitability of an aerodrome, including instrument flight procedures, for the intended operations comprises the availability of suitable navigation facilities and associated instrument flight approach procedures.

When assessing the availability of suitable navigation facilities, the following information is relevant.

- (a) Classification for ILS: the ILS classification, e.g. 'III/E/4', II/T/3, 'I/C/2', etc., is defined in ICAO Annex 10 Volume 1 by using three characters:
- (1) I, II or III: this character indicates conformance to the facility performance category which is usually associated with the approach operational category.
 - (2) A, B, C, T, D or E: this character defines the ILS points to which the localiser/glide path has been verified to be conformal to the course structure of a localiser CATII/III or glide path CAT II/III (where glide path is always limited to T).
 - (3) 1, 2, 3 or 4: this number indicates the level of integrity and continuity of service. The integrity relates to the trust which can be placed in localiser or glide path not radiating false guidance signals. The continuity of service relates to the rarity of signal interruptions. The minimum levels of integrity and continuity of service are represented by a single descriptor 'level' which would typically be associated as follows:
 - (i) Level 1: the localiser's or glide path's integrity or continuity of service have not been demonstrated or they have been demonstrated but at least one of them does not meet the level 2 requirements.
 - (ii) Level 2 is the performance objective for ILS equipment used to support LVOs when ILS guidance for position information in the landing phase is supplemented by visual cues/references.
 - (iii) Level 3 is the performance objective for ILS equipment used to support operations which place a high degree of reliance on ILS guidance for positioning through touchdown.
 - (iv) Level 4 is the performance objective for ILS equipment used to support operations which place a high degree of reliance on ILS guidance throughout touchdown and roll-out.

Further information may be found in ICAO Annex 10 Volume 1.

- (b) GBAS facility classification (GFC)

The facility classification, e.g. i.e. 'C/G1/35/H', refers to the station serving all approaches to a given airport and is defined in ICAO Annex 10 Volume 1 using four elements:

- (1) Facility approach service type (FAST): (A-D) indicate the service types supported by the navigation facility, i.e. 'C' means FAST C, which denotes a facility meeting all the performance and functional requirements necessary to support GBAS approach service type (GAST) C. GAST C has been designed to meet requirements for CAT I as well as, with additional constraints, CAT II. GAST D has been designed to meet requirements for CAT III. A downgrade from GAST D to C is possible and announced in the avionics.
- (2) Ranging source types: these indicate what ranging sources are augmented by the ground subsystem. i.e. 'G1' means GPS ('G2': SBAS, 'G3': GLONASS, 'G4': reserved for Galileo, etc.).
- (3) Facility coverage: this defines the outer horizontal coverage of the GBAS positioning service expressed in nautical miles. '0' is for facilities that do not provide positioning service. The facility coverage for position service does not indicate the coverage for the GBAS approach service. The information on the coverage for the approach service is

contained in the 'Service volume radius from the GBAS reference point' to the nearest kilometre or nautical mile as described in point (d) below.

- (4) Polarisation: this indicates the polarisation of the VHF Data Broadcast (VDB) signal. E indicates elliptical polarisation (option), and H indicates horizontal polarisation (standard). Aircraft operators that use vertically polarised receiving antennas will have to take this information into account when managing flight operations, including flight planning and contingency procedures.

Further information may be found in ICAO Annex 10 Volume 1.

- (c) Approach facility designation (AFD) for GBAS

The approach facility designation, e.g. 'EDDF/G25A/20748/S/C' or 'ABCD/XABC/21278/150/CD', describing parameters for an individual approach procedure, is defined in ICAO Annex 10 using five elements:

- (1) GBAS identification: 4-character facility identifier, e.g. ABCD.
- (2) Approach identifier: 4-character approach identifier, e.g. XABC.
- (3) Channel number: 5-digit channel number (20 001–39 999) associated with the approach.
- (4) Approach service volume: this indicates the inner limit of the service volume either by a numerical value in feet corresponding to the minimum decision height (DH), e.g. '150', or by the GBAS points (i.e. A, B, C, T, D, E, or S). The GBAS points are equivalent to the ILS points, where 'S' is only specific to GBAS and denotes the stop end of the runway.
- (5) Supported service types: these designate the supported GBAS service types (A-D).

Further information may be found in ICAO Annex 10 Volume 1.

- (d) Service volume radius from the GBAS reference point

Maximum use distance (D_{max}): the maximum distance (slant range) from the GBAS reference point to the nearest kilometre or nautical mile within which pseudo-range corrections are applied by the aircraft system.

Note: This parameter does not indicate the distance within which VHF data broadcast field strength requirements for the approach service are met.

Further information may be found in ICAO Annex 10 Volume 1.

TYPE OF xLS NAVIGATION MEANS

- (e) In the context of [AMC1 SPA.LVO.110](#) point (g)(3), 'type of xLS navigation means' means the facilities external to the aircraft and the associated limitations (if any) which have been used as the basis for certification.

GM3 SPA.LVO.110 Aerodrome-related requirements, including instrument flight procedures

ED Decision 2022/014/R

SUITABLE AERODROMES — ASSESSMENT — SUITABLE RUNWAY AND RUNWAY ENVIRONMENT CHARACTERISTICS

- (a) As detailed in point (a) of [AMC1 SPA.LVO.110](#), the assessment of the suitability of an aerodrome, including instrument flight procedures, for the intended operations comprises the availability of suitable runway and runway environment characteristics.
- (b) For operations based on radio altimeter or other device measuring the height over the ground:
 - (1) the suitability of the indication of the DH should be based on data covering the actual DH location. This indication should be expected to be stable and continuous;
 - (2) The suitability of the indication of the alert height (where applicable) should be based on data covering the actual alert height location. This indication should be expected to be stable and continuous.
 - (3) The primary source of information to determine the suitability should be the precision approach terrain chart (PATC). If the information is not conclusive, the operator may collect and develop airport data not contained in the AIP. More information can be found in [GM10 SPA.LVO.110](#).
- (c) For runways intended to be used for CAT III, CAT II, SA CAT II and SA CAT I operations, the State of aerodrome should provide a PATC. More information is provided in [GM7 SPA.LVO.110](#).
- (d) There should be a radio altimeter operating area for runways intended to be used for EFVS-L, CAT III, CAT II, SA CAT II and SA CAT I operations. The ICAO aerodrome provisions detail that the radio altimeter operating area extends to at least 300 m from the runway threshold with a width of 60 metres on either side of the extended centre line of the runway. The width may be reduced to not less than ± 30 metres if such a reduction does not affect the safety of aircraft operations as assessed by the aerodrome operator in cooperation with affected stakeholders. Slope changes should be kept to a minimum.
- (e) Information on pre-threshold terrain and its effect on radio altimeters and automatic flight control systems (AFCS) is contained in the Manual of All-Weather Operations (ICAO Doc 9365, Section 5.2.).

SUITABLE AERODROMES — ASSESSMENT — PREVIOUS OPERATIONAL DATA — RUNWAY AND RUNWAY ENVIRONMENT

- (f) As detailed in point (d)(1) of [AMC1 SPA.LVO.110](#), previous operational data should only be used to assess the suitability of an aerodrome for the intended operations when it concerns the same runway and there were no relevant changes to the runway and runway environment.
- (g) Relevant changes to the runway and runway environment may include changes to:
 - (1) the pre-threshold terrain, including the radio altimeter operating area;
 - (2) runway dimensions;
 - (3) the average slope of the landing system assessment area (LSAA);
 - (4) visual aids including approach lights and runway lights;
 - (5) the obstacle free zone (OFZ);

- (6) the visual segment surface (VSS) — only relevant for operational credits in the visual segment (EFVS).

GM4 SPA.LVO.110 Aerodrome-related requirements, including instrument flight procedures

ED Decision 2022/014/R

SUITABLE AERODROMES — ASSESSMENT — PREVIOUS OPERATIONAL DATA PROVIDED BY THE STATE OF THE AERODROME

- (a) As detailed in point (b)(1) of [AMC1 SPA.LVO.110](#), the assessment of the suitability of an aerodrome, including instrument flight procedures, for the intended operations, may be made considering previous operational data for the particular aerodrome, runway and instrument flight procedures.
- (b) The following guidance is provided for the assessment of suitability of aerodromes for LVOs or operations with operational credits.
- (1) If a State provides data related to airports or runways in its territory that are suitable for CAT II or CAT III operations with a specific aircraft model or group of aircraft models, those airports or runways may be considered suitable for the purpose of [AMC2 SPA.LVO.110](#). Note: A CAT II or CAT III approved runway does not necessarily mean that the airport is suitable for the purpose of [AMC2 SPA.LVO.110](#) as the aerodrome's provisions may not ensure that the requirements for certain aircraft models are fulfilled.
 - (2) If a State provides data related to airports or runways in its territory that are found suitable for SA CAT I or SA CAT II, those airports or runways may be considered suitable for the purpose of [AMC2 SPA.LVO.110](#). Note: In some States the concept of SA CAT I and SA CAT II may be different from the EU concept. The operator should consider these differences.
 - (3) If a State provides data related to airports or runways in its territory that are approved for CAT II/III operations but are designated as restricted or non-standard or irregular, those designated runways should be considered not suitable. The remaining CAT II/III runways of that State may be considered regular.
 - (4) A competent authority may provide data related to airports or runways that can be considered suitable for defined LVOs. The suitability statement could be credited by operators under the oversight of that authority.

GM5 SPA.LVO.110 Aerodrome-related requirements, including instrument flight procedures

ED Decision 2022/012/R

SUITABLE AERODROMES — ASSESSMENT — PREVIOUS OPERATIONAL DATA — TERMINOLOGY: MAKE, MODEL, SERIES AND VARIANT

The following terms, in accordance with the ICAO Commercial Aviation Safety Team (CAST) taxonomy, are often used (e.g. [AMC1 SPA.LVO.110](#)):

- (a) Aircraft make: The aircraft make is the name assigned to the aircraft by the aircraft manufacturer when each aircraft was produced. In most cases, the aircraft make is the common name of the aircraft manufacturer; for example, Airbus, Boeing, Embraer, etc.

- (b) Aircraft model: An aircraft model is an aircraft manufacturer's designation for an aircraft grouping with a similar design or style of structure. In EASA type certificate data sheet (TCDS), this means the aircraft type certificate; for example, A330, B777.
- (c) Aircraft series: An aircraft series is an aircraft manufacturer's designation to identify differences within an aircraft model grouping. It provides a further specification to the aircraft type; for example, B777-232 where the series is the number 232. Some manufacturers define the so-called master series: An aircraft master series creates a grouping of similar aircraft series for analytical purposes and to identify aircraft series that share airworthiness properties. A master series contains aircraft series from within one aircraft model. For example, A320-100 and A320-200: the A320-100 master series only has one series (A320-111), while the A320-200 master series has many series (211, 212, 214, 215, 216, 231, 232, 233).
- (d) Aircraft variant: a variant defines different sets of limiting structural masses (e.g. MTOW, MLW, MZFW, etc.) within a series. For example, A320-232-007 or the A330-243 RR engine's variant 052. Variants are not covered in the ICAO Cast taxonomy; however, they may be specified in the EASA TCDS.
- (e) More information can be found in ICAO documentation under: <https://www.icao.int/publications/DOC8643/Pages/Search.aspx?msckid=a28160bbd09311ecbbe633ef5f1957a4> and <http://www.intlaviationstandards.org/>.

GM6 SPA.LVO.110 Aerodrome-related requirements, including instrument flight procedures

ED Decision 2022/012/R

SUITABLE AERODROMES — DESKTOP ASSESSMENT — DATA NOT PROVIDED IN THE AFM

- (a) When the AFM or additional data from the TC/STC holder does not provide the information needed in [AMC1 SPA.LVO.110](#) points (g)(1) to (5), the operator may contact the TC/STC holder to request such information. Otherwise the operator may seek to use previous operational data or perform operational demonstration in accordance with [AMC1 SPA.LVO.110](#).

SUITABLE AERODROMES — DESKTOP ASSESSMENT — USE OF PREVIOUS OPERATIONAL DATA

- (b) In-service consolidated experience from already successfully demonstrated and consistently used runways with the specific aircraft type and with the same intended operations (typically CAT II/III) could be used to support the desktop assessment. The assessment criteria, for pre-threshold terrain variation and LSAA slope, could then be defined by the prevailing complexity of the runway on which the operator already has in-service experience and where sufficient operational flight data is available to prove adequate performance of the automatic landing system.

GM7 SPA.LVO.110 Aerodrome-related requirements, including instrument flight procedures

ED Decision 2022/012/R

SUITABLE AERODROMES — DESKTOP ASSESSMENT — AERODROME DATA SOURCES

As detailed in point (b)(2) of [AMC1 SPA.LVO.110](#), the assessment of the suitability of an aerodrome, including instrument flight procedures, for the intended operations, may be made by a desktop assessment, that should consider aerodrome data.

This GM describes some aerodrome data sources that ICAO Member States provide in accordance with ICAO Annex 4.

(a) Type A and Type B aerodrome obstacle charts

Aerodrome obstacle charts come in two forms. Type A and B charts may be combined, and the chart is called aerodrome obstacle chart (ICAO Comprehensive). Where a terrain and obstacle chart is provided in electronic form, there is no need to provide Type A or B aerodrome obstacle charts.

(b) Type A aerodrome obstacle chart (ICAO Annex 4, Chapter 3)

Type A aerodrome obstacle charts are found at most aerodromes approved for LVOs. The function of the Type A chart is to enable an operator to comply with the performance operating limitations in Annex 6. The Type A chart does not have to be provided if there are no take-off obstacles, but a note informing about this is needed according to ICAO Annex 4. The elevation is given to the nearest half-metre or nearest foot. Linear dimensions are shown to the nearest half metre.

(c) Type B aerodrome obstacle chart (ICAO Annex 4, Chapter 4)

Type B aerodrome obstacle charts contain information about the elevation (at the centre line) of both runways plus the elevation at each significant change of the slope of the runway. The function of the Type B chart is:

- (1) the determination of minimum safe altitudes/heights including those for circling procedures;
- (2) the determination of procedures for use in the event of an emergency during take-off or landing;
- (3) the application of obstacle clearing and marking criteria; and
- (4) the provision of source material for aeronautical charts.

Elevations and linear dimensions are shown to the nearest half metre.

(d) Aerodrome terrain and obstacle Chart – ICAO (Electronic) (ICAO Annex 4, Chapter 5)

The function of this chart is to:

- (1) enable an operator to comply with the operating limitations of Annex 6, Part I, Chapter 5, and Part III, Section II, Chapter 3, by developing contingency procedures for use in the event of an emergency during a missed approach or take-off, and by performing aircraft operating limitations analysis; and
- (2) support the following air navigation applications:
 - (i) instrument procedure design (including circling procedure);
 - (ii) aerodrome obstacle restriction and removal; and
 - (iii) provision of source data for the production of other aeronautical charts.

Note that this chart may also contain the information required for the PATC.

According to ICAO Annex 4, from November 2015, this chart is made available for aerodromes regularly used by international aviation. The chart is made available in printed form on request.

(e) Aerodrome chart (ICAO Annex 4, Chapter 13)

According to ICAO Annex 4, an aerodrome chart is provided for aerodromes regularly used by international aviation. The function of this chart is to provide information to facilitate the ground movement of aircraft and in general also to provide essential operational information.

This chart contains information about the height of the threshold and, for PA runways, the highest point of the TDZ. This information may also be included in the text part of the AIP, Chapter AD2 (normally paragraph 2.12 – Runway Physical Characteristics). The elevation is provided to the nearest half metre.

(f) Precision approach terrain chart (PATC) (Annex 4, Chapter 6)

According to ICAO Annex 4, a PATC is made available for all PA runways Categories II and III at aerodromes used by international civil aviation, except where the requisite information is provided in the aerodrome terrain and obstacle chart — ICAO (Electronic). The chart includes:

- (i) a plan showing contours at 1 m (3 ft) intervals in the area 60 m on either side of the extended centre line of the runway, to the same distance as the profile, the contours to be related to the runway threshold;
- (ii) an indication where the terrain or any object thereon, within the plan defined in (i), differs by ± 3 m in height from the centre line profile and is likely to affect a radio altimeter;
- (iii) a profile of the terrain to a distance of 900 m from the threshold along the extended centre line of the runway. Where the terrain at a distance greater than 900 m from the runway threshold is mountainous or otherwise significant to users of the chart, the profile of the terrain should be shown to a distance not exceeding 2 000 m from the runway threshold.

(g) Summary

- (1) For the determination of runway slopes, the aerodrome obstacle chart, preferably the combined version, appears to provide the best information. The PATC appears to be the best source to determine the elevations and slopes in the approach area.
- (2) If the information provided by different parts of the AIP is inconsistent, this may indicate an error in the data and should be reported to the State of aerodrome or AIP issuing authority, unless the inconsistency is insignificant. It should however be noted that there may be different requirements for accuracy and resolution between different AIP charts or sections, which might cause values to differ slightly.
- (3) It may be difficult to conclusively state which chart is best for determining the runway slope in each case, but the primary source of information is the AIP, and therein the aerodrome obstacle chart and the PATC. As the aerodrome terrain and obstacle chart — ICAO (Electronic) becomes more available, it will probably take over as the primary source of information about both runways and pre-threshold terrain.

GM8 SPA.LVO.110 Aerodrome-related requirements, including instrument flight procedures

ED Decision 2022/014/R

SUITABLE AERODROMES — OPERATIONAL ASSESSMENT — PROCESS TO DETERMINE THE NUMBER OF APPROACHES AND LANDINGS — AEROPLANES

- (a) When performing an operational assessment to determine the suitability of an aerodrome for the intended operations, the operator should have a process to determine the number of approaches and landings, in accordance with point (l) of [AMC1 SPA.LVO.110](#). The following guidance provides examples of criteria that can be used to evaluate level complexity of the runway versus a landing system for the purpose of the determination of the number of approaches and landings. Depending on the landing system used, some criteria might not be relevant, or others might need to be considered.

(1) Pre-threshold terrain profile

The typical length of pre-runway threshold is calculated from the published threshold (displaced threshold if present) to 300 m on the extended centre line unless otherwise specified by the AFM or additional data from the TC/STC holder, the State of the aerodrome or AIP data, or the competent authority issuing the operator's LVO approval. The complexity of the pre-threshold terrain profiles is described as follows:

(i) Simple

- (A) approximately ± 1 m variation from runway threshold elevation in the typical length; or
- (B) previous experience in more constraining pre-threshold terrain in the same aircraft type or variant.

(ii) Moderate

- (A) presence of ARAS; or
- (B) approximately ± 1 m variation from runway threshold elevation within the last 60 m prior to runway threshold; and
- (C) prior to 60 m and up to typical length:
 - moderate rising slope (less than 7 % rising); or
 - moderate 'sea wall' (less than 3 m).

(iii) Complex

- (A) approximately ± 2 m variation from runway threshold elevation within the last 60 m prior to runway threshold; and
- (B) prior to 60 m and up to typical length:
 - significant rising slope (up to 15 % rising); or
 - significant 'see wall' (up to 6 m); or
 - significant change of slope (rising then descending or descending then rising close to the limit values).

(iv) Very complex

Outside any of the limits defined above for complex pre-threshold terrain profiles.

Note: The term ‘sea wall’ refers to sudden changes of terrain elevation that typically occur when runway thresholds are located near the sea. Sea level may change due to tides. Other cases of sudden terrain elevation may occur in other cases, a slope of 100 % may be considered as comparable to ‘sea wall’ (e.g. Boston USA).

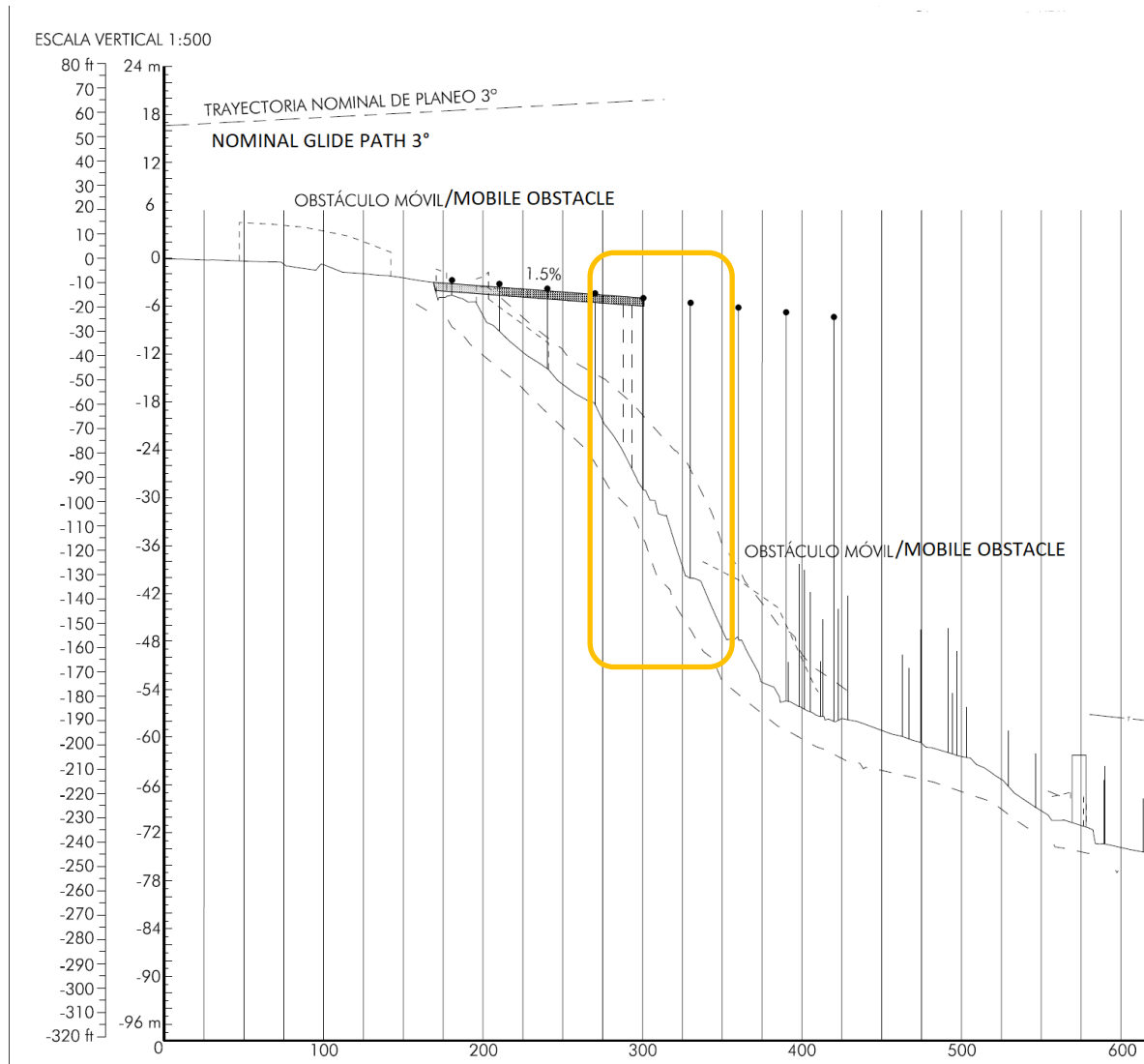

Figure 0: Typical example of ‘very complex’ with greater than 6 m ‘sea wall’ at 300 m (Asturias, LEAS 29 dated 2007) that after suitability assessment and due to the presence of ARAS, may be changed to ‘moderate’.

Example: A pre-threshold terrain with the following features would be considered as ‘moderate’.

- (1) Less than 1 m variation of pre-threshold terrain elevation from runway threshold elevation, in the area from runway threshold up to 100 m prior to runway threshold
- (2) Less than 3 m variation of pre-threshold terrain elevation from runway threshold elevation, in the area from 100 m prior to runway threshold up to 300 m prior to runway threshold
- (2) Landing system assessment area (LSAA) slope

Note: 600 metres after the threshold is the standard length; however depending on the landing system, other lengths might be relevant.

Although not recommended by ICAO Annex 14 Volume 1, slope variation in the LSAA can exist (refer to point 3.1.15 to point 3.1.18) and represent a factor of risk to be considered. For the purpose of determining the relevant parameters characterising slope and slope variation, the following definitions may be used (Figure 1):

- Mean LSAA slope: Slope computed from runway threshold elevation up to runway elevation at 600 metres after the threshold.
- Deviation from mean LSAA slope: greatest elevation difference between any runway elevation inside LSAA and mean LSAA slope.

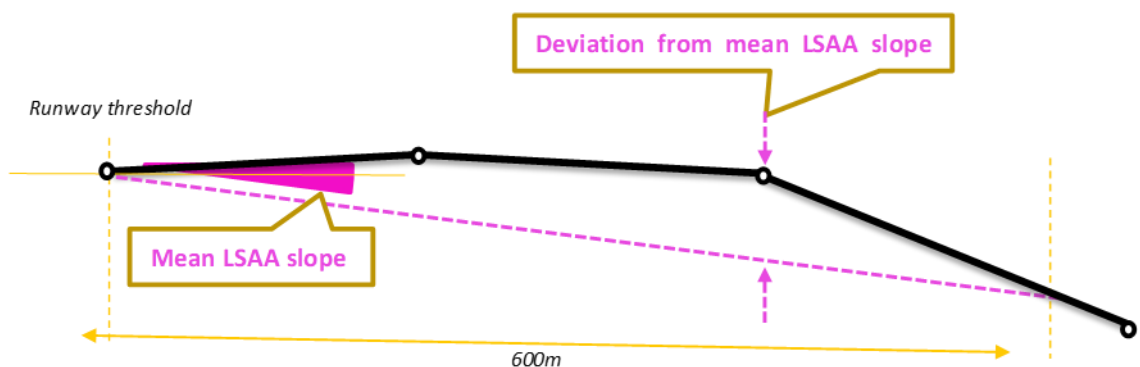

Figure 1: Mean LSAA slope & Deviation from mean LSAA slope

Note: Published runway profiles usually contain the position and elevation of each significant runway longitudinal slope change. Elevation at other location can be interpolated assuming straight slope between each published elevation. The highest/lowest elevation of the LSAA might not be the one where the deviation from mean LSAA slope is the greatest.

- (i) Simple
 - (A) Approximately $\pm 0.4\%$ mean LSAA slope and less than 1 m (3 ft) variation around mean LSAA slope; or
 - (B) previous experience in more constraining touch down condition in the same aircraft type or variant.
- (ii) Moderate

Approximately $\pm 0.8\%$ mean LSAA slope and less than 2 m (6 ft) variation around mean LSAA slope.
- (iii) Complex

Approximately $\pm 1.0\%$ mean LSAA slope and less than 4 m (12 ft) variation around mean LSAA slope.
- (iv) Very complex

Outside any of the limits defined above.

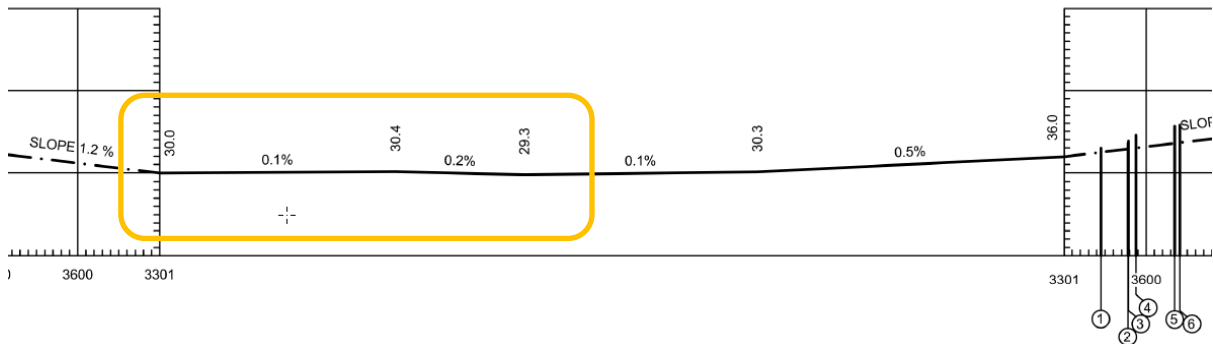

Figure 2: Typical example of 'simple' LSAA Slope (ESSA 01L dated 2018)

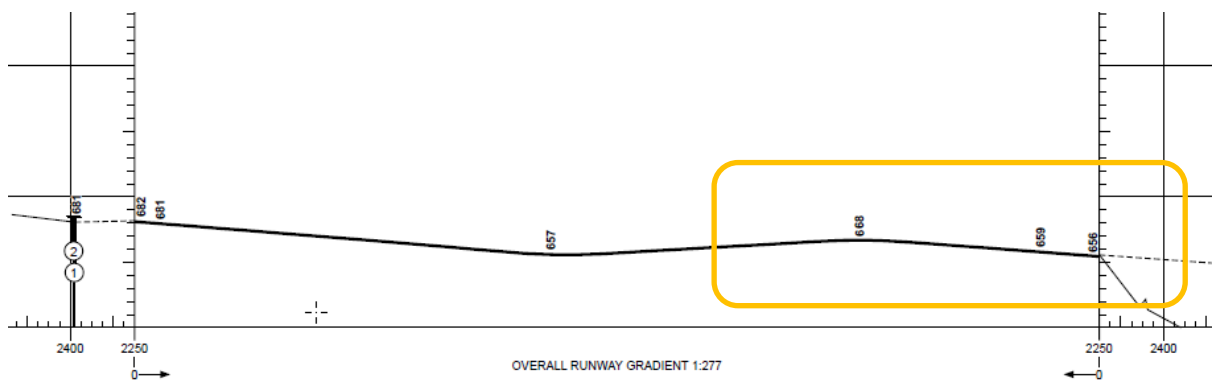

Figure 3: Typical example of 'moderate' LSAA slope due to variation around mean LSAA slope greater than 1 m but lower than 2 m (EGNM 32 dated 2018)

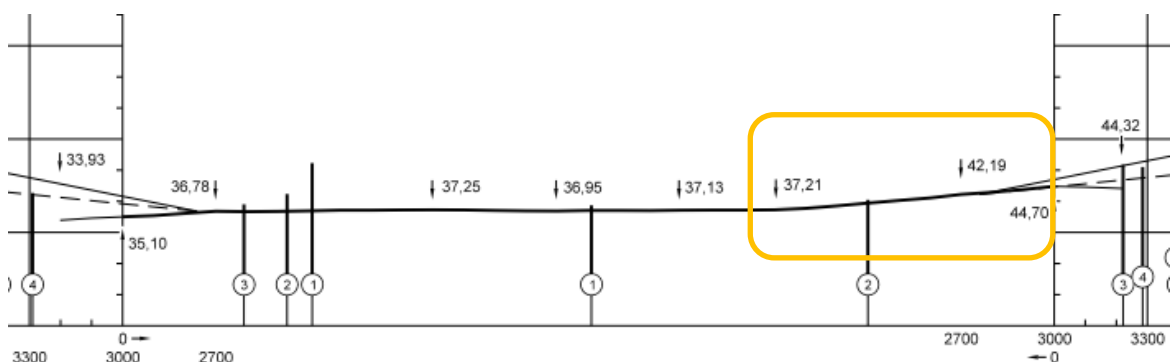

Figure 4: Typical example of 'complex' mean LSAA slope greater than 0.8 % but lower than 1 % (EDD 23L dated 2009)

- (b) Operational assessment programme: the following guidance provides examples of typical flight programmes than can be used to demonstrate suitability of a landing system using the operational assessment method, considering the overall level of runway irregularities.

Note: For CAT II operations with no use of autoland nor guidance for the flare manoeuvre, the programmes could be alleviated.

The flight programmes are expected to depend on the level of runway irregularities. Table 1 provides examples of criteria that can be used to determine the level of runway irregularities.

Table 1

Level of runway irregularities to scale the flight programme

Pre-threshold LSAA slope	Simple	Moderate	Complex	Very complex
Simple	Simple	Moderate	Complex	Very complex
Moderate	Moderate	Moderate	Complex	Very complex
Complex	Complex	Complex	Complex	Very complex
Very complex	Very complex	Very complex	Very complex	Very complex

(1) Simple runway

For simple runways, unless other factors can be identified as a source of concern, no in-flight approach and landing may be required.

(2) Moderate runway

For moderate runways, a minimum of one successful approach/landing using the procedures, equipment and operationally relevant heights (DH/AH) for the intended operations is performed in the meteorological conditions described in [AMC1 SPA.LVO.110](#) Table 14. More approaches could be required if any issue is identified during this approach/landing.

(3) Complex runway

For complex runways, an initial minimum of three approaches/landings using the procedures, equipment and operationally relevant heights (DH/AH) for the intended operations is performed in the meteorological conditions described in [AMC1 SPA.LVO.110](#) Table 14, with at least one of the landings close to the maximum landing weight for the intended operation and the other two with other different conditions; for example, with a mid-weight in one and low weight in another or with different or wind conditions or aircraft configuration flap full/flap 3, or a combination of them. The flights for the assessment are conducted by pilots designated by the operator with defined minimum experience and qualifications, with procedures defined for the purpose. More approaches could be required if any issue is identified during these approaches/landings.

(4) Very complex runway

For very complex runways, an initial minimum of four to six approaches/landings using the procedures, equipment and operationally relevant heights (DH/AH) for the intended operations is performed in the meteorological conditions described in [AMC1 SPA.LVO.110](#) Table 14 in typical aircraft weight conditions in flights with no commercial passengers.

If no anomaly is observed after the first four to six approaches/landings, extend the condition progressively close to the maximum landing weight for the intended operation with at least 15 successful approaches or landings and report any anomalies with the

meteorological conditions described in [AMC1 SPA.LVO.110](#) Table 14 and with different conditions, for example with different range of weight conditions (high, mid, low) or with different wind conditions or aircraft configuration flap full/flap 3, or a combination of them. The flights for the assessment should be conducted by pilots designated by the operator with defined minimum experience and qualifications, with procedures defined for the purpose.

(c) Operational assessment successful criteria

(1) Data to be recorded

To assess adequate performance of the landing system, some form of quantitative data should be recorded and reviewed with the competent authority as verification of performance. Acceptable methods of data collection include but are not limited to:

- (i) Record of wind conditions and touch down point (can be observation).
- (ii) Record of pertinent landing system parameters (typically from a digital flight data recorder, quick-access recorder or equivalent) with sufficient sampling rate (typically higher than 1 sample per second) for the part of the flight paths of interest (typically from 300 ft height above touch down through de-rotation after touch down) including typically:
 - barometric altitude;
 - radio altitude;
 - glide path error;
 - vertical speed;
 - elevator command;
 - pitch attitude;
 - throttle position/thrust commanded;
 - airspeed;
 - mode transition or engagement.
- (iii) Photo or video recording of pertinent instrument or instrument and outside view allowing post-flight replay and review of the above parameters.

(2) Data review and analysis to assess acceptable performance

The final approach, flare and touch down profile should be reviewed with the competent authority to ensure suitability of at least each of the following:

- (i) suitability of the resulting flight path;
- (ii) acceptability of any flight path deviation from the nominal path (e.g. glide path deviation, deviation from nominal flare profile);
- (iii) proper mode switching;
- (iv) suitable touch down point;
- (v) suitable sink rate at touch down;
- (vi) proper flare initiation altitude;

- (vii) suitability flare quality (e.g. no evidence of early or late flare, no over-flare or under flare, no undue 'pitch down' tendency at flare initiation or during flare, no flare oscillation, no abrupt flare, no inappropriate pitch response during flare, no unacceptable floating tendency, or other unacceptable characteristic that a pilot could interpret as a failure or inappropriate response of the landing system);
- (viii) no unusual flight control displacement (e.g. elevator control input spikes or oscillation);
- (ix) appropriate throttle/thrust retard (e.g. no early or late retard, no failure to retard, no undue reversal of retard, no undue pitch/thrust coupling);
- (x) appropriate speed decay in flare (e.g. no unusually low speed risking high pitch attitude and tail strike, no excessive float, appropriate speed decay even if well above V_{ref} at flare initiation due to planned wind or gust compensation);
- (xi) proper mode initiation or mode transition relating to altitude or radio altitude inputs (e.g. crosswind alignment).

GM9 SPA.LVO.110 Aerodrome-related requirements, including instrument flight procedures

ED Decision 2022/012/R

SUITABLE AERODROMES — OPERATIONAL ASSESSMENT — VERIFICATION USING AN FSTD

- (a) When performing an operational assessment to determine the suitability of an aerodrome for the intended operations, the operator may replace partially or completely the approaches and landings by a verification using an FSTD, if the FSTD is suitable for the operational assessment, in accordance with point (o) of [AMC1 SPA.LVO.110](#).

Using an FSTD to support an operational assessment can be useful when, for example, terrain criteria would qualify as 'complex' or 'very complex' (level of runway irregularities according to [GM8 SPA.LVO.110](#)).

FSTDs are usually designed with the objective of replicating the aspects relevant to the scope of flight training associated with the type and level of the FSTD qualification. FSTDs are usually not designed to be used in the context of an operational assessment of the aerodrome for the intended operations, and there may be limits to what an FSTD may be used for. It should be ensured that the capabilities of the FSTD can support the objectives of the operational assessment.

When using an FSTD, any relevant differences between the real aircraft and the FSTD should be taken into consideration. A full flight simulator (FFS) Level D certified for zero flight time training is generally the most suitable for such use.

TO APPLY A VERIFICATION USING AN FSTD, A SUITABLE FSTD SHOULD BE USED

- (b) An FSTD should only be used if it is from:
 - (1) the same aircraft make and model, unless the same aircraft make and model is restricted by any of the entities in point (c)(2) [AMC1 SPA.LVO.110](#); or
 - (2) another aircraft model, if stated in the AFM or additional data from the TC/STC holder.

The following factors should be considered:

(1) Aircraft systems

The FSTD replicates the aircraft system in regard to the configuration and behaviour of the approach system or landing system. It covers all systems that are relevant and includes — as a minimum — the guidance and control systems, the relevant displays and the automatic call-outs.

The FSTD may be composed of actual aircraft components or simulated components either by the aircraft manufacturer or by another supplier (e.g. the FSTD manufacturer). If a version or standard of a system or component differs from the aircraft, the operator verifies with the TC/STC holder whether the differences have an impact on the performance or behaviour of the approach system or landing system.

(2) Pre-threshold and runway terrain

The aircraft operator ensures that all relevant pre-threshold and runway profile data is fed into the FSTD and is presentative of the real world. This could mean that additional features may need to be implemented in the terrain database of the FSTD, as the certification specifications for FSTDs require a realistic topography only for a very limited number of aerodromes.

If the pre-threshold terrain includes an artificial radio altimeter surface (ARAS), the ARAS may be verified in the FSTD, if it can be shown for this ARAS that the actual echoes of the radio altimeters can be adequately reproduced in the FSTD. This may be done by using flight data.

(3) Navigation facilities and associated instrument flight approach procedures

All relevant navigation facilities for the instrument flight approach procedures need to be adequately represented in the FSTD. It has to be taken into account that the FSTD representation of the signal in space is usually not realistic in the sense of the signal propagation and is limited to being a straight line in space, which is adequate for training purposes. Some FSTDs support, as a simulation feature for a failure case, a parallel displacement of target approach path; however, dynamic displacements (bends) or VHF noise in the signal are usually not simulated.

If the operation depends on a navigation aid, the use of the FSTD should be limited to the published service volume of the real-world navigation aid. The use of the FSTD outside this space is usually not meaningful as the signal performance and quality of the real-world navigation aid is not known.

(4) Runway environment characteristics and facilities

Whenever the flight operation relies on visual references in both natural or enhanced vision to control or monitor the flight path or to identify relevant obstacles, all relevant environment characteristics and facilities need to be suitably represented. In the case of an EFVS, the visual advantage of the system needs to be representative of the EFVS presentation in the aircraft. This could mean that additional features may need to be implemented in the visual database of the FSTD, as the certification specifications for FSTD require a realistic scenery only for a very limited number of aerodromes.

(5) Scope of FSTD verification

The minimum scope of the FSTD verification may be based on the level of runway irregularities as per [GM8 SPA.LVO.110](#) (scaled approach).

GM10 SPA.LVO.110 Aerodrome-related requirements, including instrument flight procedures

ED Decision 2022/012/R

SUITABLE AERODROMES — ASSESSMENT — COLLECT AND DEVELOP AIRPORT DATA NOT CONTAINED IN THE AIP — AEROPLANES

An AIP should be the primary means to collect the necessary data to perform the assessment of aerodromes for the intended operation. However, sometimes the relevant data may not be available. In that case, [AMC4 SPA.LVO.110](#) establishes that the operator should develop procedures to collect or develop the necessary data.

In this context, the operator may use surveys and/or collected data from aeroplane sensors or data recorders. This method could be typically used to determine the pre-threshold terrain profile and partially the LSAA if not published by a State authority.

These options should be part of the LVO approval and could include, among others:

- (a) data from appropriate sensors (e.g. radio altimeter, GNSS position, LOC/GS deviations);
- (b) data collected from appropriate sensors stored in recorders;
- (c) FDM data, if appropriate.

Sensors and data accuracy, including recorded sampling rate, should be considered in the usage of the collected data.

When defined in the approval, the respective data might be used for other airplane types.

GM11 SPA.LVO.110 Aerodrome-related requirements, including instrument flight procedures

ED Decision 2022/012/R

SUITABLE AERODROMES — SUITABLE INSTRUMENT APPROACH PROCEDURES (IAPs) — SA CAT I AND SA CAT II

ICAO design criteria for IAPs are contained in PANS-OPS (Doc 8168), Volume II.

The design criteria for SA CAT I are the same as those used for standard CAT I approaches, except that the procedures used for SA CAT I should have an OCH based on radio altimeter height loss, since the use of a radio altimeter or other device capable of providing equivalent performance to determine the DH is prescribed.

PANS-OPS Volume II contains the following statement about OCH based on the use of a radio altimeter: 'If the radio altimeter OCA/H is promulgated, operational checks shall have confirmed the repeatability of radio altimeter information.' To assist in assessing the suitability of the approach area for the use of a radio altimeter, aerodromes may produce a precision approach terrain chart (PATC). Such a chart is a standard requirement for CAT II/III runways. The criteria for the PATC are contained in ICAO Annex 4, which explains the function as follows: 'The chart shall provide detailed terrain profile information within a defined portion of the final approach so as to enable aircraft operating agencies

to assess the effect of the terrain on DH determination by the use of radio altimeters.’ A DH of 150 ft is located approximately 600 m before the threshold on a 3° glide path.

For SA CAT I operations, the instrument approach chart should contain an OCH based on the use of a radio altimeter or other device capable of providing equivalent performance, and the information in Part C of the operations manual must contain a DH based on the use of a radio altimeter. This procedure may be titled ‘SA CAT I’ or ‘CAT I’.

For SA CAT II, the situation is similar. The design criteria are identical to those for CAT II approaches in PANS-OPS, the only exception being the lack of some lighting systems. The OCH and DH are based on the use of a radio altimeter or other device capable of providing equivalent performance.

Since some of the lighting systems are missing, it is unlikely that a State will publish the instrument approach chart as CAT II or OTS CAT II but preferably as SA CAT II, even though the design criteria are the same. If a State, however, promulgates such an instrument approach as CAT II, it can be used for SA CAT II operations.

SA CAT II operations can be conducted on regular CAT II runways and following CAT II procedures.

GM12 SPA.LVO.110 Aerodrome-related requirements, including instrument flight procedures

ED Decision 2022/012/R

SUITABLE AERODROMES — VERIFICATION OF THE SUITABILITY OF RUNWAYS FOR EFVS OPERATIONS

- (a) EFVS operations allow operation below the DA/H without ‘natural’ visual reference. Obstacles may not be obvious to the crew using the EFVS and thus the approach descent slope used has to ensure that obstacle protection will be provided in the visual segment.
- (b) When operating below the DA/H, pilots rely on the EFVS and, for EFVS-A operations, the pilot flying will need to acquire ‘natural’ visual reference at some point prior to touchdown (typically 100 ft above the threshold elevation). EFVS operations may present a higher probability of initiating a go-around below the DA/H than non-EFVS operations, depending on the equipment used.
- (c) The purpose of the assessment of the suitability of aerodromes of Instrument Approach Procedures (IAPs) is to confirm that clearance from terrain and obstacles will be available at every stage of the approach including the visual segment and, in the event of a go-around initiated below the DH, the missed approach segment. The assessment of the visual segment should be done with reference to the visual segment surface (VSS).
- (d) If a runway and an approach has been promulgated as suitable for EFVS operations, it may be assumed that the required obstacle clearance for the instrument segment and obstacle protection for the visual segment is assured and that the lighting systems are suitable. For EFVS-L operations, the pre-threshold terrain and LSAA need to be evaluated with regard to the function of flare cues or flare commands. Additionally, for runways not promulgated as suitable for EFVS operations, the operator may include the switch-over time for electrical power supply for the approach or runway lights in the safety assessment.
- (e) US TERPS and ICAO Doc 9905 ‘Required Navigation Performance Authorisation Required (RNP AR) Procedure Design Manual’ describe procedure design criteria that may be considered equivalent to PANS-OPS.

- (f) Procedures not designed in accordance with PANS-OPS may have not been assessed for obstacle protection below the OCH and may not provide a clear vertical path to the runway at the normal descent angle. IAPs do not ensure obstacle clearance if a go-around is initiated below the DA/H. If an obstacle free zone (OFZ) is established, obstacle protection is provided for the go-around manoeuvre.
- (g) For approach procedures where obstacle protection is not assured for a balked landing, operational procedures available to the operator could include one or more of the following actions:
 - (1) continue to the end of the runway and follow a published departure procedure for the landing runway (standard instrument departure or omnidirectional departure) in the event of a go-around below the DA/H;
 - (2) require that a go-around should be executed promptly if the required visual reference is not distinctly visible and identifiable to the pilot without reliance on the EFVS by a height above the threshold that will ensure that obstacle protection. This height might be greater than 100 ft or the height below which an approach should not be continued if the flight crew does not acquire natural visual reference as stated in the AFM;
 - (3) develop an alternative lateral profile to be followed in the event of a go-around below the DA/H; and
 - (4) impose an aircraft mass restriction for EFVS operations so that the aircraft can achieve a sufficient missed approach climb performance to clear any obstacles in the missed approach segment if a go-around is initiated at any point prior to touchdown.
- (h) The terrain/obstacle clearance required in the missed approach phase for EFVS operations should be no less than for the same approach flown without EFVS.
- (i) Certain EFVSs may have additional requirements for the suitability of the runways to be used. These could include verification of the accuracy of charting information for the runway threshold or the type of approach lighting installed (incandescent or LED). The assessment of the suitability of aerodromes should include the verification that all such requirements can be satisfied before EFVS operations are authorised for a particular runway.

SPA.LVO.120 Flight crew competence

Regulation (EU) 2021/2237

- (a) The operator shall ensure that the flight crew is competent to conduct the intended operations.
- (b) The operator shall ensure that each flight crew member successfully completes training and checking for all types of LVOs and operations with operational credits for which an approval has been granted. Such training and checking shall:
 - (1) include initial and recurrent training and checking;
 - (2) include normal, abnormal and emergency procedures;
 - (3) be tailored to the type of technologies used in the intended operations; and
 - (4) take into account the human factor risks associated with the intended operations.
- (c) The operator shall keep records of the training and qualifications of the flight crew members.
- (d) The training and checking shall be conducted by appropriately qualified personnel. In the case of flight and flight simulation training and checking, the personnel providing the training and

conducting the checks shall be qualified in accordance with Annex I (Part-FCL) to [Regulation \(EU\) No 1178/2011](#).

AMC1 SPA.LVO.120(a) Flight crew competence

ED Decision 2022/012/R

COMPETENCE OF THE FLIGHT CREW FOR THE INTENDED OPERATIONS — EXPERIENCE IN TYPE OR CLASS, OR AS PILOT-IN-COMMAND/COMMANDER

To ensure that the flight crew is competent to conduct the intended operations, the operator should assess the risks associated with the conduct of low-visibility approach operations by pilots new to the aircraft type or class and take the necessary mitigations. Where such mitigations include an increment to the visibility or RVR for LVOs, this should be stated in the operations manual.

AMC2 SPA.LVO.120(a) Flight crew competence

ED Decision 2022/012/R

COMPETENCE OF THE FLIGHT CREW FOR THE INTENDED OPERATIONS — RECENT EXPERIENCE FOR EFVS OPERATIONS

To be considered competent to conduct EFVS operations:

- (a) Pilots should complete a minimum of two approaches on each type of aircraft operated using the operator's procedures for EFVS operations during the validity period of each operator proficiency check or periodic demonstration of competence unless credits related to recent experience when operating more than one type are defined in the operational suitability data established in accordance with [Regulation \(EU\) No 748/2012](#). When the operator is approved for both EFVS-L and EFVS-A, a minimum of one approach in each EFVS operation should be completed.
- (b) If a flight crew member is authorised to operate as pilot flying and pilot monitoring during EFVS operations, the flight crew member should complete the required number of approaches in each operating capacity.

AMC3 SPA.LVO.120(a) Flight crew competence

ED Decision 2022/012/R

COMPETENCE OF THE FLIGHT CREW FOR THE INTENDED OPERATIONS — RECENT EXPERIENCE FOR SA CAT I, CAT II, SA CAT II AND CAT III APPROACH OPERATIONS

To be considered competent:

- (a) Pilots authorised to conduct low-visibility approach operations or operations with operational credits should complete at least two approaches using the operator's procedures for low-visibility approach operations or operations with operational credits, during the validity period of each operator proficiency check or periodic demonstration of competence, unless credits related to recent experience when operating more than one type are defined in the operational suitability data established in accordance with [Regulation \(EU\) No 748/2012](#).
- (b) If the operator is approved for more than one piece of aircraft equipment used (e.g. autoland, HUD, auto-coupled approach with manual landing, SVGS, etc.), pilots should complete at least one additional approach in the lowest approved RVR (either to go-around or landing) for each piece of aircraft equipment used during the validity period of each operator proficiency check or periodic demonstration of competence (e.g. two approaches CAT II with autoland and one

CAT II with auto-coupled to below DH with manual landing, two CAT II autoland and one CAT II HUD to below DH with manual landing or vice versa) unless credits related to recent experience when operating more than one type are defined in the operational suitability data established in accordance with [Regulation \(EU\) No 748/2012](#).

- (c) Pilots authorised to conduct low-visibility approach operations or operations with operational credits using HUDLS or equivalent display systems to touchdown should complete two approaches (e.g. an operator approved for CAT II/III HUDLS will do two CAT III HUDLS; other examples would be two CAT III autoland and two CAT III HUDLS to touchdown, two SA CAT II autoland and two SA CAT II HUDLS, or when combining several LVOs and equipment, two CAT III autoland and one CAT II auto-coupled to below DH with manual landing and two CAT III HUDLS to touchdown) using the operator's procedures for low-visibility approach operations or operations with operational credits using HUDLS, during the validity period of each operator proficiency check or periodic demonstration of competence unless credits related to recent experience when operating more than one type are defined in the operational suitability data established in accordance with [Regulation \(EU\) No 748/2012](#).
- (d) If a flight crew member is authorised to operate as pilot flying and pilot monitoring, the flight crew member should complete the required number of approaches in each operating capacity.

GM1 SPA.LVO.120(a) Flight crew competence

ED Decision 2022/012/R

COMPETENCE OF THE FLIGHT CREW FOR THE INTENDED OPERATIONS — EXPERIENCE IN TYPE OR CLASS, OR AS PILOT-IN-COMMAND/COMMANDER

As general guidance, the operator may use the following reference to assess the experience in type or class or as pilot-in-command/commander referred to in [AMC1 SPA.LVO.120\(a\)](#):

- (a) Before commencing CAT II operations, the following guidance applies to pilots-in-command/commanders or pilots to whom conduct of the flight may be delegated, who are new to the aircraft type:
- (1) 50 hours or 20 sectors on the type, including LIFUS; and
 - (2) 100 m should be added to the applicable CAT II RVR minima when the operation requires a CAT II manual landing to touchdown until:
 - (i) a total of 100 hours or 40 sectors, including LIFUS, has been achieved on the type; or
 - (ii) a total of 50 hours or 20 sectors, including LIFUS, has been achieved on the type where the flight crew member has been previously qualified for CAT II manual landing operations with an EU operator;
 - (3) 100 m may be added to the applicable CAT II RVR minima when the operation requires the use of CAT II HUDLS to touchdown until:
 - (i) a total of 40 sectors, including LIFUS, has been achieved on the type; or
 - (ii) a total of 20 sectors, including LIFUS, has been achieved on the type where the flight crew member has been previously qualified for CAT II HUDLS to touchdown with an EU operator.

The sector provision in point (a)(1) may always be applicable; the hours on type or class may not fulfil the provisions.

- (b) Before commencing CAT III operations, the following additional provisions may apply to pilots-in-command/commanders or pilots to whom conduct of the flight may be delegated, who are new to the aircraft type:
- (1) 50 hours or 20 sectors on the type, including LIFUS; and
 - (2) 100 m may be added to the applicable CAT II or CAT III RVR minima unless they have been previously qualified for CAT II or III operations with an EU operator, until a total of 100 hours or 40 sectors, including LIFUS, has been achieved on the type.

AMC1 SPA.LVO.120(b) Flight crew competence

ED Decision 2022/012/R

INITIAL TRAINING FOR LVTO IN AN RVR LESS THAN 400 M

The operator should ensure that the flight crew members have completed the following training and checking prior to being authorised to conduct take-offs in an RVR below 400 m unless credits related to training and checking for previous experience in LVTOs on similar aircraft types are defined in the operational suitability data established in accordance with [Regulation \(EU\) No 748/2012](#):

- (a) A ground training course including at least the following:
- (1) characteristics of fog;
 - (2) effects of precipitation, ice accretion, low-level wind shear and turbulence;
 - (3) the effect of specific aircraft/system malfunctions;
 - (4) the use and limitations of RVR assessment systems;
 - (5) procedures to be followed and precautions to be taken with regard to surface movement during operations when the RVR is 400 m or less and any additional procedures required for take-off in conditions below 150 m;
 - (6) qualification requirements for pilots to obtain and retain approval to conduct LVOs; and
 - (7) the importance of correct seating and eye position.
- (b) A course of FSTD/flight training covering system failures and engine failures resulting in continued as well as rejected take-offs. Such training should include at least:
- (1) normal take-off in minimum approved RVR conditions;
 - (2) take-off in minimum approved RVR conditions with an engine failure:
 - (i) for aeroplanes, between V_1 and V_2 (take-off safety speed) or as soon as safety considerations permit;
 - (ii) for helicopters, at or after the take-off decision point (TDP); and
 - (3) take-off in minimum approved RVR conditions with an engine failure:
 - (i) for aeroplanes, before V_1 resulting in a rejected take-off; and
 - (ii) for helicopters, before the TDP.
- (c) The operator approved for LVTOs with an RVR below 150 m should ensure that the training specified in (b) is carried out in an FSTD. This training should include the use of any special procedures and equipment.

- (d) The operator should ensure that a flight crew member has completed a check before conducting LVTOs in RVRs of less than 150 m. The check should require the execution of:
- (1) at least one LVTO in the minimum approved visibility;
 - (2) at least one rejected take-off at minimum approved RVR in an aircraft or FSTD.

For pilots with previous experience with an EU operator of LVTOs in RVRs of less than 150 m, the check may be replaced by successful completion of the FSTD and/or flight training specified in (a), (b) and (c).

AMC2 SPA.LVO.120(b) Flight crew competence

ED Decision 2022/012/R

INITIAL TRAINING AND CHECKING FOR SA CAT I, CAT II, SA CAT II AND CAT III APPROACH OPERATIONS

Operators should ensure that flight crew members complete the following training and checking before being authorised to conduct SA CAT I, CAT II, SA CAT II and CAT III approach operations unless credits related to training and checking for previous experience on similar aircraft types are defined in the operational suitability data established in accordance with [Regulation \(EU\) No 748/2012](#):

- (a) For flight crew members who do not have previous experience of low-visibility approach operations requiring an approval under this Subpart with an EU operator:
- (1) A course of ground training including at least the following:
 - (i) characteristics and limitations of different types of approach aids;
 - (ii) characteristics of the visual aids;
 - (iii) characteristics of fog;
 - (iv) operational capabilities and limitations of airborne systems to include symbology used on HUD/HUDLS or equivalent display systems, if appropriate;
 - (v) effects of precipitation, ice accretion, low level wind shear and turbulence;
 - (vi) the effect of specific aircraft/system malfunctions;
 - (vii) the use and limitations of RVR assessment systems;
 - (viii) principles of obstacle clearance requirements;
 - (ix) the recognition of failure of ground equipment or in satellite approaches, the loss of signal in space and the action to be taken in the event of such failures;
 - (x) procedures to be followed and precautions to be taken with regard to surface movement during operations when the RVR is 400 m or less and any additional procedures required for take-off in conditions below 150 m;
 - (xi) the significance of DHs based upon radio altimeters and the effect of terrain profile in the approach area on radio altimeter readings and on automatic approach/landing systems. This applies also to other devices capable of providing equivalent information;
 - (xii) the effect of the pre-threshold terrain and LSAA on airborne landing systems;
 - (xiii) the significance of alert height, if applicable, and action in the event of any failure above and below the alert height;

- (xiv) qualification requirements for pilots to obtain and retain approval to conduct LVOs;
 - (xv) the importance of correct seating and eye position; and
 - (xvi) the significance of LVPs or equivalent procedures.
- (2) A course of FSTD training and/or flight training in two phases as follows:
- (i) Phase one (LVOs with aircraft and all equipment serviceable) — objectives
 - (A) understand the operation of equipment required for LVOs;
 - (B) understand the operating limitations resulting from airworthiness certification;
 - (C) practise the monitoring of automatic flight control systems and status annunciators;
 - (D) practise the use of HUD/HUDLS or equivalent display systems, where appropriate;
 - (E) understand the significance of alert height, if applicable;
 - (F) become familiar with the maximum lateral and vertical deviation permitted for different types of approach operation;
 - (G) become familiar with the visual references required at DH;
 - (H) master the manual aircraft handling relevant to low-visibility approach operations;
 - (I) practise coordination with other crew members; and
 - (J) become proficient at procedures for low-visibility approach operations with serviceable equipment.
 - (ii) Phase one of the training should include the following exercises:
 - (A) the required checks for satisfactory functioning of equipment, both on the ground and in flight;
 - (B) the use of HUD/HUDLS or equivalent display systems during all phases of flight, if applicable;
 - (C) approach using the appropriate flight guidance, autopilots, and control systems installed on the aircraft to the appropriate DH and transition to visual flight and landing;
 - (D) approach with all engines operating using the appropriate flight guidance, autopilots and control systems installed on the aircraft, including HUD/HUDLS or equivalent display systems, down to the appropriate DH followed by a missed approach, all without external visual reference;
 - (E) where appropriate, approaches using autopilot to provide automatic flare, hover, landing and roll-out; and
 - (F) where appropriate, approaches using approved HUD/HUDLS or equivalent display system to touchdown.

- (iii) Phase two (low-visibility approach operations with aircraft and equipment failures and degradations) — objectives
 - (A) understand the effect of known aircraft unserviceability including use of the MEL;
 - (B) understand the effect of failed or downgraded equipment on aerodrome operating minima;
 - (C) understand the actions required in response to failures and changes in the status of automatic flight control/guidance systems including HUD/HUDLS or equivalent display systems;
 - (D) understand the actions required in response to failures above and below alert height, if applicable;
 - (E) practise abnormal operations and incapacitation procedures; and
 - (F) become proficient at dealing with failures and abnormal situations during low-visibility approach operations.
- (iv) Phase two of the training should include the following exercises:
 - (A) approaches with engine failures at various stages of the approach;
 - (B) approaches with critical equipment failures, such as electrical systems, auto-flight systems, ground or airborne approach aids and status monitors;
 - (C) approaches where failures of auto-flight or flight guidance systems, including HUDLS or equivalent display systems, require either:
 - (a) reversion to manual control for landing or go-around; or
 - (b) reversion to manual control or a downgraded automatic mode control for go-around from the DH or below, including those which may result in contact with the runway.

This should include aircraft handling if, during a CAT III fail-passive approach, a fault causes autopilot to disconnect at or below the DH when the last reported RVR is 300 m or less;
 - (D) failures of systems that will result in excessive lateral or vertical deviation both above and below the DH in the minimum visual conditions for the operation;
 - (E) incapacitation procedures appropriate to low-visibility approach operations; and
 - (F) failures and procedures applicable to the specific aircraft type.
- (v) FSTD training should include:
 - (A) for approaches flown using HUDLS or equivalent display systems, a minimum of eight approaches;
 - (B) otherwise, a minimum of six approaches.
- (vi) For aircraft for which no FSTDs representing the specific aircraft are available, operators should ensure that the flight training phase specific to the visual scenarios of low-visibility approach operations is conducted in a specifically

- approved FSTD. Such training should include a minimum of four approaches. Thereafter, type-specific training should be conducted in the aircraft.
- (3) A check requiring the completion of at least the following exercises in an aircraft or FSTD:
- (i) Low-visibility approaches in simulated instrument flight conditions down to the applicable DH, using the flight guidance system. Standard procedures of crew coordination (task sharing, call-out procedures, mutual surveillance, information exchange and support) should be observed. For CAT III operations, the operator should use an FSTD approved for this purpose;
 - (ii) Go-around after approaches as indicated in (2) at any point between 500 ft above ground level (AGL) and on reaching the DH; and
 - (iii) Landing(s) with visual reference established at the DH following an instrument approach. Depending on the specific flight guidance system, an automatic landing should be performed.
- (4) For operators for which LIFUS is required by Part-ORO, practice in approaches during LIFUS, as follows:
- (i) For low-visibility approach operations using a manual landing:
 - (A) if a HUDLS or equivalent display system is used to touchdown, four landings, or if the training required by (a)(2) was conducted in an FSTD qualified for zero flight-time training (ZFTT), two landings;
 - (B) otherwise, three landings, or if the training required by (a)(2) was conducted in an FSTD qualified for ZFTT, one landing;
 - (ii) For low-visibility operations using autoland:
 - (A) if the training required by (a)(2) was conducted in an FSTD qualified for ZFTT, one landing, or none if the flight crew member successfully completed a type rating based on ZFTT;
 - (B) otherwise, two landings.
- (b) For flight crew members who have previous experience of low-visibility approach operations requiring an approval under this Subpart with an EU operator, when changing to an aircraft for which a new class or type rating is required, within the same operator:
- (1) A course of ground training as specified in (a)(1), taking into account the flight crew member's existing knowledge of low-visibility approach operations.
 - (2) A course of FSTD and/or flight training, as specified in (a)(2) above. If the flight crew member's previous experience of low-visibility approach operations is on a type where the following were the same or similar:
 - (i) the technology used in the flight guidance and flight control system;
 - (ii) operating procedures;
 - (iii) handling characteristics; and
 - (iv) the use of HUD/HUDLS or equivalent display systems,then the flight crew member may complete an abbreviated course of FSTD and/or flight training.

- (3) An abbreviated course should meet the objectives described in (a)(2), need not include the number of approaches required by (a)(2)(v), but should include at least the following number of landings:
- (i) if a HUDLS or an equivalent display system is utilised to touchdown, then four approaches including a landing at the lowest approved RVR and a go-around; or
 - (ii) otherwise, two approaches including a landing at the lowest approved RVR and a go-around.
- (c) For flight crew members who have previous experience of low-visibility approach operations requiring an approval under this Subpart with an EU operator, when joining another operator:
- (1) A course of ground training as specified in (a)(1), taking into account the flight crew member's existing knowledge of low-visibility approach operations.
 - (2) A course of FSTD and/or flight training as specified in (a)(2) above. If the flight crew member's previous experience of low-visibility approach operations is on the same aircraft type and variant, or on a different type or variant where the following were the same or similar:
 - (i) the technology used in the flight guidance and flight control system;
 - (ii) operating procedures;
 - (iii) handling characteristics; and
 - (iv) the use of HUD/HUDLS or equivalent display systems,then the flight crew member may complete an abbreviated course of FSTD and/or flight training. Such an abbreviated course should meet the objectives described in (a)(2), need not include the number of approaches required by (a)(2)(v), but should include at least the following number of landings:
 - (A) if a HUDLS or an equivalent display system is utilised to touchdown, then four approaches including a landing at the lowest approved RVR and a go-around; or
 - (B) otherwise, two approaches including a landing at the lowest approved RVR and a go-around.
 - (3) Practice in approaches during LIFUS as required by (a)(3) above unless the flight crew member's previous experience of low-visibility approach operations is on the same aircraft type and variant.

AMC3 SPA.LVO.120(b) Flight crew competence

ED Decision 2022/012/R

INITIAL TRAINING AND CHECKING FOR EFVS OPERATIONS

Operators should ensure that flight crew members complete the following training and checking before being authorised to conduct EFVS operations unless credits related to training and checking for previous experience on similar aircraft types are defined in the operational suitability data established in accordance with [Regulation \(EU\) No 748/2012](#):

- (a) For flight crew members who do not have previous experience of EFVS operations requiring an approval under this Subpart with an EU operator:
 - (1) A course of ground training including at least the following:

-
- (i) characteristics and limitations of HUDs/HUDLSs or equivalent display systems including information presentation and symbology;
 - (ii) EFVS sensor performance, sensor limitations, scene interpretation, visual anomalies and other visual effects;
 - (iii) EFVS display, control, modes, features, symbology, annunciations and associated systems and components;
 - (iv) the interpretation of EFVS imagery;
 - (v) the interpretation of approach and runway lighting systems and display characteristics when using EFVS;
 - (vi) weather associated with low-visibility conditions and its effect on EFVS performance;
 - (vii) pre-flight planning and selection of suitable aerodromes and approach procedures;
 - (viii) principles of obstacle clearance requirements;
 - (ix) the use and limitations of RVR assessment systems;
 - (x) normal, abnormal and emergency procedures for EFVS operations;
 - (xi) the effect of specific aircraft/system malfunctions;
 - (xii) procedures to be followed and precautions to be taken with regard to surface movement during operations when the RVR is 400 m or less;
 - (xiii) for EFVS-L, the effect of the pre-threshold terrain and LSAA on airborne landing systems;
 - (xiv) human factors aspects of EFVS operations;
 - (xv) qualification requirements for pilots to obtain and retain approval for EFVS operations; and
 - (xvi) the significance of LVPs or equivalent procedures when operating below RVR 550 m.
- (2) A course of FSTD training and/or flight training in two phases as follows:
- (i) Phase one (EFVS operations with aircraft and all equipment serviceable) — objectives:
 - (A) understand the operation of equipment required for EFVS operations;
 - (B) understand operating limitations of the installed EFVS;
 - (C) practise the use of HUD/HUDLS or equivalent display systems;
 - (D) practise the set-up and adjustment of EFVS equipment in different conditions (e.g. day and night);
 - (E) practise the monitoring of automatic flight control systems, EFVS information and status annunciators;
 - (F) practise the interpretation of EFVS imagery;
 - (G) become familiar with the features needed on the EFVS image to continue approach below the DH;

- (H) practise the identification of visual references using natural vision while using EFVS equipment;
 - (I) master the manual aircraft handling relevant to EFVS operations including, where appropriate, the use of the flare cue and guidance for landing;
 - (J) practise coordination with other crew members; and
 - (K) become proficient at procedures for EFVS operations.
- (ii) Phase one of the training should include the following exercises:
- (A) the required checks for satisfactory functioning of equipment, both on the ground and in flight;
 - (B) the use of HUD/HUDLS or equivalent display systems during all phases of flight;
 - (C) approach using the EFVSs installed on the aircraft to the appropriate DH and transition to visual flight and landing;
 - (D) approach with all engines operating using the EFVS, down to the appropriate DH followed by a missed approach, all without external visual reference;
 - (E) where appropriate, approaches using approved EFVS to touchdown.
- (iii) Phase two (EFVS operations with aircraft and equipment failures and degradations) – objectives:
- (A) understand the effect of known aircraft unserviceabilities including use of the MEL;
 - (B) understand the effect of failed or downgraded equipment on aerodrome operating minima;
 - (C) understand the actions required in response to failures and changes in the status of the EFVS including HUD/HUDLS or equivalent display systems;
 - (D) understand the actions required in response to failures above and below the DH;
 - (E) practise abnormal operations and incapacitation procedures; and
 - (F) become proficient at dealing with failures and abnormal situations during EFVS operations.
- (iv) Phase two of the training should include the following exercises:
- (A) approaches with engine failures at various stages of the approach;
 - (B) approaches with failures of the EFVS at various stages of the approach, including failures between the DH and the height below which an approach should not be continued if natural visual reference is not acquired, requiring either:
 - (a) reversion to head-down displays to control missed approach; or
 - (b) reversion to flight with no, or downgraded, guidance to control missed approaches from the DH or below, including those which may result in a touchdown on the runway;

- (C) incapacitation procedures appropriate to EFVS operations; and
 - (D) failures and procedures applicable to the specific EFVS installation and aircraft type.
 - (v) FSTD training should include a minimum of eight approaches.
 - (vi) If a flight crew member is to be authorised to operate as pilot flying and pilot monitoring during EFVS operations, then the flight crew member should complete the required FSTD training for each operating capacity.
- (3) For operators for which LIFUS is required by Part-ORO, practice in approaches during LIFUS, as follows:
- (i) if EFVS is used to touchdown, four landings; or
 - (ii) otherwise, three landings.
- (b) For flight crew members who have previous experience of EFVS operations requiring an approval under this Subpart with an EU operator, when changing to an aircraft for which a new class or type rating is required, with the same operator:
- (1) A course of ground training as specified in (a)(1), taking into account the flight crew member's existing knowledge of low-visibility approach operations.
 - (2) The course of FSTD and/or flight training required by (a)(2) above. If the flight crew member's previous experience of low-visibility approach operations is on a type where the following were the same or similar:
 - (i) the technology used in the EFVS sensor, flight guidance and flight control system;
 - (ii) operating procedures; and
 - (iii) handling characteristics,then the flight crew member may complete an abbreviated course of FSTD and/or flight training. Such an abbreviated course should meet the objectives described in (a)(2), need not include the number of approaches required by (a)(2)(v), but should include at least the following number of landings:
 - (i) for EFVS to touchdown, four approaches including a landing at the lowest approved RVR and a go-around, or
 - (ii) otherwise, two approaches including a landing at the lowest approved RVR and a go-around.
- (c) For flight crew members who have previous experience of EFVS operations requiring an approval under this Subpart with an EU operator, when joining another operator:
- (1) A course of ground training as specified in (a)(1), taking into account the flight crew member's existing knowledge of low-visibility approach operations.
 - (2) The course of FSTD and/or flight training required by (a)(2) above. If the flight crew member's previous experience of EFVS operations is on the same aircraft type and variant with the same EFVS or on a different type or different EFVS where the following were the same or similar:
 - (i) the technology used in the EFVS sensor, flight guidance and flight control system;
 - (ii) operating procedures; and

- (iii) handling characteristics,
then the flight crew member may complete an abbreviated course of FSTD and/or flight training.
- (3) Such an abbreviated course should meet the objectives described in (a)(2), need not include the number of approaches required by (a)(2)(v), but should include at least the following number of landings:
 - (i) for EFVS to touchdown, four approaches including a landing at the lowest approved RVR and a go-around, or
 - (ii) otherwise, two approaches including a landing at the lowest approved RVR and a go-around.
- (4) Practice in approaches during LIFUS as required by (a)(3) above unless the flight crew member's previous experience of low-visibility approach operations is on the same aircraft type and variant.

AMC4 SPA.LVO.120(b) Flight crew competence

ED Decision 2022/014/R

RECURRENT CHECKING FOR LVTO, SA CAT I, CAT II, SA CAT II AND CAT III APPROACH OPERATIONS

- (a) The operator should ensure that the pilots' competence to perform LVOs for which they are authorised is checked by completing at least the following exercises:
 - (1) One or more low-visibility rejected take-off at minimum approved RVR at least once over the period between two operator proficiency checks or once at every periodic demonstration of competence or, for an ATQP operator, at each required operator proficiency check or alternatively at each required LOE.
 - (2) Pilots authorised for LVTO operations in an RVR of less than 150 m should additionally conduct at least one LVTO in the minimum approved visibility at each required operator proficiency check or periodic demonstration of competence.
 - (3) One or more low-visibility approaches in simulated instrument flight conditions down to a point between 500 ft AGL and the threshold (e.g. applicable DH), followed by go-around, at each required operator proficiency check or periodic demonstration of competence; and
 - (4) One or more low-visibility approach and landings with visual reference established at the DH at each required operator proficiency check or periodic demonstration of competence.
- (b) Pilots authorised to conduct CAT III operations on aircraft with a fail-passive autoland system, or HUDLS or equivalent, should complete a missed approach at least once over the period of three consecutive operator proficiency checks or demonstrations of competence as the result of an equipment failure at or below the DH when the last reported RVR was less than 300 m. For ATQP operators, pilots authorised to conduct CAT III operations on aircraft with a fail-passive autoland system, or HUDLS or equivalent, should complete a missed approach at least once every two OPCs or LOE (a period of about 2 years).
- (c) CAT III approach operations should be conducted in an FSTD. Other exercises may be conducted in an FSTD or aircraft.

AMC5 SPA.LVO.120(b) Flight crew competence

ED Decision 2022/012/R

DIFFERENCES TRAINING FOR LVTO, SA CAT I, CAT II, SA CAT II AND CAT III APPROACH OPERATIONS

- (a) The operator should ensure that the flight crew members are provided with differences training or familiarisation whenever they are required to conduct low-visibility approach operations or operations with operational credits requiring an approval under this Subpart for which they are not already authorised, or whenever there is a change to any of the following:
- (1) the technology used in the flight guidance and flight control system;
 - (2) the operating procedures including:
 - (i) fail-passive/fail-operational;
 - (ii) alert height;
 - (iii) manual landing or automatic landing;
 - (iv) operations with DH or no DH operations;
 - (3) the handling characteristics;
 - (4) the use of HUD/HUDLS or equivalent display systems;
 - (5) the use of EFVS.
- (b) The differences training should:
- (1) meet the objectives of the appropriate initial training course;
 - (2) take into account the flight crew members' previous experience; and
 - (3) take into account the operational suitability data established in accordance with [Regulation \(EU\) No 748/2012](#).

AMC6 SPA.LVO.120(b) Flight crew competence

ED Decision 2022/012/R

RECURRENT CHECKING FOR EFVS OPERATIONS

- (a) The operator should ensure that the pilots' competence to perform EFVS operations is checked at each required demonstration of competence or operator proficiency check by performing at least two approaches of which one should be flown without natural vision, to the height below which an approach should not be continued if natural visual reference is not acquired.
- (b) If a flight crew member is authorised to operate as pilot flying and pilot monitoring during EFVS operations, then the flight crew member should complete the required number of approaches in each operating capacity.

AMC7 SPA.LVO.120(b) Flight crew competence

ED Decision 2022/012/R

DIFFERENCES TRAINING FOR EFVS OPERATIONS

- (a) The operator should ensure that the flight crew members authorised to conduct EFVS operations are provided with differences training or familiarisation whenever there is a change to any of the following:

- (1) the technology used in the EFVS sensor, flight guidance and flight control system;
 - (2) the operating procedures;
 - (3) the handling characteristics.
- (b) The differences training should:
- (1) meet the objectives of the appropriate initial training course;
 - (2) take into account the flight crew members' previous experience; and
 - (3) take into account the operational suitability data established in accordance with [Regulation \(EU\) No 748/2012](#).

GM1 SPA.LVO.120(b) Flight crew competence

ED Decision 2022/012/R

FLIGHT CREW TRAINING

- (a) The number of approaches referred to in [AMC2](#), [AMC3](#), [AMC4](#) and [AMC6](#) to [SPA.LVO.120\(b\)](#) represents the minimum number of approaches that the flight crew members should conduct during initial and recurrent training and checking. More approaches or other training exercises may be required in order to ensure that flight crew members achieve the required proficiency.
- (b) Where flight crew members are to be authorised to conduct more than one kind of LVOs including operations with operational credits for which the technology and operating procedures are similar, there is no requirement to increase the number of approaches in initial training if the training programme ensures that the flight crew members are competent for all operations for which they will be authorised. Where flight crew members are to be authorised to conduct more than one kind of LVOs including operations with operational credits using different technology or operating procedures, then the required minimum number of approaches should be completed for each different technology or operating procedure.
- (c) Where flight crew members are authorised to conduct more than one kind of LVOs including operations with operational credits for which the technology and operating procedures are similar, then there is no requirement to increase the number of approaches flown during recurrent checking. However, where flight crew members are authorised to conduct more than one kind of LVOs including operations with operational credits using different technology or operating procedures, then the required number of approaches should be completed for each different technology or operating procedure.
- (d) Flight crew members are required to complete initial and recurrent FSTD training for each operating capacity for which they will be authorised (e.g. as pilot flying and/or pilot monitoring). A pilot who will be authorised to operate in either capacity will need to complete the minimum number of approaches in each capacity.
- (e) Approaches conducted in a suitably qualified FSTD and/or during a proficiency check or demonstration of competence may be counted towards the recent experience requirements. If a flight crew member has not complied with the recent experience requirements of [AMC2 SPA.LVO.120\(a\)](#) or [AMC3 SPA.LVO.120\(a\)](#), the required approaches may be conducted during recurrent training, an operator proficiency check or a periodic check of competence either in an aircraft or on an FSTD.
- (f) Table 1 presents a summary of initial training requirements for LVOs and operations with operational credits.

(g) Table 2 presents a summary of recent experience and recurrent training/checking requirements for LVOs and operations with operational credits.

Table 1

Summary of initial training requirements for LVOs and operations with operational credits

Approval	Airborne equipment	Previous experience	Reference	Practical (FSTD) training ⁴	LIFUS (if required) ⁴
CAT II	Auto coupled to below DH with manual landing	none	AMC2 SPA.LVO.120(b) point (a)(2)(v)	As required but not less than 6 approaches	3 landings or 1 landing ¹
		Previously qualified with the same operator, similar operations ³	AMC2 SPA.LVO.120(b) point (b)(2)(ii)	2 approaches	none
		Previously qualified with a different EU operator, same type and variant	AMC2 SPA.LVO.120(b) point (c)(2)	2 approaches	none
		Previously qualified with a different EU operator, similar operations ³	AMC2 SPA.LVO.120(b) point (c)(2)	2 approaches	3 landings or 1 landing ¹
SA CAT I CAT II SA CAT II CAT III	Autoland	none	AMC2 SPA.LVO.120(b) point (a)(4)(ii)	As required but not less than 6 approaches	2 landings or 1 landing ¹ or no landings ²
		Previously qualified with the same operator, similar operations ³	AMC2 SPA.LVO.120(b) point (b)(3)(ii)	2 approaches	None
		Previously qualified with a different EU operator, same type and variant	AMC2 SPA.LVO.120(b) point (c)(2)	2 approaches	none
		Previously qualified with a different EU operator, similar operations ³	AMC2 SPA.LVO.120(b) point (c)(2)	2 approaches	2 landings or 1 landing ¹ or no landings ²
CAT II SA CAT II CAT III	HUDLS/ manual landing	none	AMC2 SPA.LVO.120(b) point (a)(2)(v)	As required but not less than 8 approaches	4 landings or 2 landings ¹
		Previously qualified with the same operator, similar operations ³	AMC2 SPA.LVO.120(b) point (b)(3)(i)	4 approaches	None
		Previously qualified with a different EU operator, same type and variant	AMC2 SPA.LVO.120(b) point (c)(2)	4 approaches	none
		Previously qualified with a different EU operator, similar operations ³	AMC2 SPA.LVO.120(b) point (c)(2)	4 approaches	4 landings or 2 landings ¹
SA CAT I CAT II SA CAT II CAT III	HUDLS/ automatic landing	none	AMC2 SPA.LVO.120(b) point (a)(4)	As required but not less than 8 approaches	2 landings or 1 landing ¹ or no landings ²

		Previously qualified with the same operator, similar operations ³	AMC2 SPA.LVO.120(b) point (b)(3)	4 approaches	None
		Previously qualified with a different EU operator, same type and variant	AMC2 SPA.LVO.120(b) point (c)(2)	4 approaches	None
		Previously qualified with a different EU operator, similar operations ³	AMC2 SPA.LVO.120(b) point (c)(2)	4 approaches	2 landings or 1 landing ¹ or no landings ²
EFVS-A	EFVS with HUD/ HUDLS	none	AMC3 SPA.LVO.120(b) point (a)(2)	As required but not less than 8 approaches	3 landings
		Previously qualified with the same operator, similar operations ³	AMC3 SPA.LVO.120(b) point (b)(3)	2 approaches	None
		Previously qualified with a different EU operator, same type and variant	AMC3 SPA.LVO.120(b) point (c)(2)	2 approaches	none
		Previously qualified with a different EU operator, similar operations ³	AMC3 SPA.LVO.120(b) point (c)(2)	2 approaches	3 landings
EFVS-L	EFVS with HUD/ HUDLS	none	AMC3 SPA.LVO.120(b) point (a)(2)	As required but not less than 8 approaches	4 landings
		Previously qualified with the same operator, similar operations ³	AMC3 SPA.LVO.120(b) point (b)(3)	4 approaches	None
		Previously qualified with a different EU operator, same type and variant	AMC3 SPA.LVO.120(b) point (c)(2)	4 approaches	none
		Previously qualified with a different EU operator, similar operations ³	AMC3 SPA.LVO.120(b) point (c)(2)	4 approaches	4 landings

Notes:

- 1: Fewer landings during LIFUS are required if a level 'D' FSTD is used for conversion training.
- 2: No landings are required if a candidate has completed the zero flight-time (ZFT) type rating.
- 3: 'Similar operations' implies that the level of technology, operating procedures, handling characteristics and HUD/ HUDLS or equivalent display systems are the same or similar.
- 4: 'operational suitability data established in accordance with [Regulation \(EU\) No 748/2012](#) may define credits'

Table 2

Summary of recent experience and recurrent training/checking requirements for LVOs and operations with operational credits

LVO/operational credit	Airborne equipment	Recent experience ^{1,2}	Reference	Recurrent training/checking	Reference
LVTO	-	-	-	1 rejected take-off and 1 LVTO at minimum RVR ¹	AMC4 SPA.LVO.120(b) point (a)(1), (a)(2)
CAT II	Auto coupled below DH with manual landing	2 or more approaches ⁴	AMC3 SPA.LVO.120(a) points (a) and (b)	1 approach to land; 1 approach to go-around	AMC4 SPA.LVO.120(b) point (a)(2), (a)(3)
SA CAT I CAT II SA CAT II CAT III	Autoland				
CAT II/III SA CAT I SA CAT II	HUDLS/ manual landing	2 or 4 approaches	AMC3 SPA.LVO.120(a) point (c)	2 approaches including a landing	AMC4 SPA.LVO.120(b) point (b)
CAT II/III SA CAT I SA CAT II	HUDLS/ automatic landing				
Approach using EFVS	(HUD/ HUDLS)	2 approaches ⁴	AMC2 SPA.LVO.120(a)	2 approaches ³	AMC6 SPA.LVO.120(b)

Notes:

- 1: LVTO only required if the minimum approved RVR is less than 150 m.
- 2: If a flight crew member is authorised to operate as pilot flying and pilot monitoring, then the flight crew member should complete the required number of approaches in each operating capacity.
- 3: One approach to be flown without natural vision, to the height below which an approach should not be continued if natural visual reference is not acquired.
- 4: ‘operational suitability data established in accordance with [Regulation \(EU\) No 748/2012](#) may define credits’

GM2 SPA.LVO.120(b) Flight crew competence

ED Decision 2022/012/R

RECURRENT TRAINING AND CHECKING FOR EFVS OPERATIONS

In order to provide the opportunity to practise decision-making in the event of system failures and failure to acquire natural visual reference, the recurrent training and checking for EFVS operations is recommended to periodically include different combinations of equipment failures, go-around due to loss of visual reference and landings.

GM3 SPA.LVO.120(b) Flight crew competence

ED Decision 2022/012/R

INITIAL TRAINING AND CHECKING FOR SA CAT I, CAT II, SA CAT II AND CAT III APPROACH OPERATIONS

The ground training referred to in points (a)(1)(i) and (iv) of [AMC2 SPA.LVO.120\(b\)](#) may include:

- (a) airborne and ground equipment:
 - (1) technical requirements;
 - (2) operational requirements;
 - (3) operational reliability;
 - (4) fail-operational;
 - (5) fail-passive;
 - (6) equipment reliability;
 - (7) operating procedures;
 - (8) preparatory measures;
 - (9) operational downgrading; and
 - (10) communications; and
- (b) procedures and limitations:
 - (1) operating procedures; and
 - (2) crew coordination.

SPA.LVO.125 Operating procedures

Regulation (EU) No 965/2012

- (a) The operator shall establish procedures and instructions to be used for LVOs. These procedures and instructions shall be included in the operations manual or procedures manual and contain the duties of flight crew members during taxiing, take-off, approach, flare, landing, rollout and missed approach operations, as appropriate.
- (b) Prior to commencing an LVO, the pilot-in-command/commander shall be satisfied that:
 - (1) the status of the visual and non-visual facilities is sufficient;
 - (2) appropriate LVPs are in force according to information received from air traffic services (ATS);
 - (3) flight crew members are properly qualified.

SPA.LVO.130 Minimum equipment

Regulation (EU) No 965/2012

- (a) The operator shall include the minimum equipment that has to be serviceable at the commencement of an LVO in accordance with the aircraft flight manual (AFM) or other approved document in the operations manual or procedures manual, as applicable.
- (b) The pilot-in-command/commander shall be satisfied that the status of the aircraft and of the relevant airborne systems is appropriate for the specific operation to be conducted.

SUBPART F: EXTENDED RANGE OPERATIONS WITH TWO- ENGINED AEROPLANES (ETOPS)

SPA.ETOPS.100 ETOPS

Regulation (EU) No 965/2012

In commercial air transport operations, two-engined aeroplanes shall only be operated beyond the threshold distance determined in accordance with [CAT.OP.MPA.140](#) if the operator has been granted an ETOPS operational approval by the competent authority.

SPA.ETOPS.105 ETOPS operational approval

Regulation (EU) No 965/2012

To obtain an ETOPS operational approval from the competent authority, the operator shall provide evidence that:

- (a) the aeroplane/engine combination holds an ETOPS type design and reliability approval for the intended operation;
- (b) a training programme for the flight crew members and all other operations personnel involved in these operations has been established and the flight crew members and all other operations personnel involved are suitably qualified to conduct the intended operation;
- (c) the operator's organisation and experience are appropriate to support the intended operation;
- (d) operating procedures have been established.

GM1 SPA.ETOPS.105 ETOPS operational approval

ED Decision 2012/019/R

AMC 20-6

AMC 20-6 provides further criteria for the operational approval of ETOPS.

SPA.ETOPS.110 ETOPS en-route alternate aerodrome

Regulation (EU) No 965/2012

- (a) An ETOPS en-route alternate aerodrome shall be considered adequate, if, at the expected time of use, the aerodrome is available and equipped with necessary ancillary services such as air traffic services (ATS), sufficient lighting, communications, weather reporting, navigation aids and emergency services and has at least one instrument approach procedure available.
- (b) Prior to conducting an ETOPS flight, the operator shall ensure that an ETOPS en-route alternate aerodrome is available, within either the operator's approved diversion time, or a diversion time based on the MEL generated serviceability status of the aeroplane, whichever is shorter.
- (c) The operator shall specify any required ETOPS en-route alternate aerodrome(s) in the operational flight plan and ATS flight plan.

SPA.ETOPS.115 ETOPS en-route alternate aerodrome planning minima

Regulation (EU) No 965/2012

- (a) The operator shall only select an aerodrome as an ETOPS en-route alternate aerodrome when the appropriate weather reports or forecasts, or any combination thereof, indicate that, between the anticipated time of landing until one hour after the latest possible time of landing, conditions will exist at or above the planning minima calculated by adding the additional limits of Table 1.
- (b) The operator shall include in the operations manual the method for determining the operating minima at the planned ETOPS en-route alternate aerodrome.

Table 1

Planning minima for the ETOPS en-route alternate aerodrome

Type of approach	Planning minima
Precision approach	DA/H + 200 ft RVR/VIS + 800 m ⁽¹⁾
Non-precision approach or Circling approach	MDA/H + 400 ft ⁽¹⁾ RVR/VIS + 1500 m
⁽¹⁾ VIS: visibility; MDA/H: minimum descent altitude/height.	

SUBPART G: TRANSPORT OF DANGEROUS GOODS

SPA.DG.100 Transport of dangerous goods

Regulation (EU) No 379/2014

Except as provided for in Annex IV (Part-CAT), Annex VI (Part-NCC), Annex VII (Part-NCO) and Annex VIII (Part-SPO), the operator shall only transport dangerous goods by air if the operator has been approved by the competent authority.

SPA.DG.105 Approval to transport dangerous goods

Regulation (EU) No 965/2012

To obtain the approval to transport dangerous goods, the operator shall in accordance with the technical instructions:

- (a) establish and maintain a training programme for all personnel involved and demonstrate to the competent authority that adequate training has been given to all personnel;
- (b) establish operating procedures to ensure the safe handling of dangerous goods at all stages of air transport, containing information and instructions on:
 - (1) the operator's policy to transport dangerous goods;
 - (2) the requirements for acceptance, handling, loading, stowage and segregation of dangerous goods;
 - (3) actions to take in the event of an aircraft accident or incident when dangerous goods are being carried;
 - (4) the response to emergency situations involving dangerous goods;
 - (5) the removal of any possible contamination;
 - (6) the duties of all personnel involved, especially with relevance to ground handling and aircraft handling;
 - (7) inspection for damage, leakage or contamination;
 - (8) dangerous goods accident and incident reporting.

AMC1 SPA.DG.105(a) Approval to transport dangerous goods

ED Decision 2017/009/R

TRAINING PROGRAMME

- (a) The operator should indicate for the approval of the training programme how the training will be carried out. For formal training courses, the course objectives, the training programme syllabus/curricula and examples of the written examination to be undertaken should be included.
- (b) Instructors should have knowledge of training techniques as well as in the field of transport of dangerous goods by air so that the subject is covered fully and questions can be adequately answered.
- (c) Training intended to give general information and guidance may be by any means including handouts, leaflets, circulars, slide presentations, videos, computer-based training, etc., and may take place on-the-job or off-the-job. The person being trained should receive an overall

awareness of the subject. This training should include a written, oral or computer-based examination covering all areas of the training programme, showing that a required minimum level of knowledge has been acquired.

- (d) Training intended to give an in-depth and detailed appreciation of the whole subject or particular aspects of it should be by formal training courses, which should include a written examination, the successful passing of which will result in the issue of the proof of qualification. The course may be by means of tuition, as a self-study programme, or a mixture of both. The person being trained should gain sufficient knowledge so as to be able to apply the detailed rules of the Technical Instructions.
- (e) Training in emergency procedures should include as a minimum:
 - (1) for personnel other than crew members:
 - (i) dealing with damaged or leaking packages; and
 - (ii) other actions in the event of ground emergencies arising from dangerous goods;
 - (2) for flight crew members:
 - (i) actions in the event of emergencies in flight occurring in the passenger compartment or in the cargo compartments; and
 - (ii) the notification to ATS should an in-flight emergency occur;
 - (3) for crew members other than flight crew members:
 - (i) dealing with incidents arising from dangerous goods carried by passengers; or
 - (ii) dealing with damaged or leaking packages in flight.
- (f) Training should be conducted at intervals of no longer than 2 years. If the recurrent training is undertaken within the last 3 calendar months of the validity period, the new validity period should be counted from the original expiry date.

AMC1 SPA.DG.105(b) Approval to transport dangerous goods

ED Decision 2012/019/R

PROVISION OF INFORMATION IN THE EVENT OF AN IN-FLIGHT EMERGENCY

If an in-flight emergency occurs the pilot-in-command/commander should, as soon as the situation permits, inform the appropriate ATS unit of any dangerous goods carried as cargo on board the aircraft, as specified in the Technical Instructions.

GM1 SPA.DG.105(b)(6) Approval to transport dangerous goods

ED Decision 2012/019/R

PERSONNEL

Personnel include all persons involved in the transport of dangerous goods, whether they are employees of the operator or not.

SPA.DG.110 Dangerous goods information and documentation

Regulation (EU) 2019/1384

The operator shall, in accordance with the technical instructions:

- (a) provide written information to the pilot-in-command/commander:

- (1) about dangerous goods to be carried on the aircraft;
 - (2) for use in responding to in-flight emergencies;
- (b) use an acceptance checklist;
 - (c) ensure that dangerous goods are accompanied by the required dangerous goods transport document(s), as completed by the person offering dangerous goods for air transport, except when the information applicable to the dangerous goods is provided in electronic form;
 - (d) ensure that where a dangerous goods transport document is provided in written form, a copy of the document is retained on the ground where it will be possible to obtain access to it within a reasonable period until the goods have reached their final destination;
 - (e) ensure that a copy of the information to the pilot-in-command or the commander is retained on the ground and that that copy, or the information contained in it, is readily accessible to the flight operations officer, flight dispatcher, or the designated ground personnel responsible for their part of the flight operations, until after the completion of the flight to which the information refers;
 - (f) retain the acceptance checklist, transport document and information to the pilot-in-command/commander for at least three months after completion of the flight;
 - (g) retain the training records of all personnel for at least three years.

AMC1 SPA.DG.110(a) Dangerous goods information and documentation

ED Decision 2012/019/R

INFORMATION TO THE PILOT-IN-COMMAND/COMMANDER

If the volume of information provided to the pilot-in-command/commander by the operator is such that it would be impracticable to transmit it in the event of an in-flight emergency, an additional summary of the information should also be provided, containing at least the quantities and class or division of the dangerous goods in each cargo compartment.

AMC1 SPA.DG.110(b) Dangerous goods information and documentation

ED Decision 2012/019/R

ACCEPTANCE OF DANGEROUS GOODS

- (a) The operator should not accept dangerous goods unless:
 - (1) the package, overpack or freight container has been inspected in accordance with the acceptance procedures in the Technical Instructions;
 - (2) they are accompanied by two copies of a dangerous goods transport document or the information applicable to the consignment is provided in electronic form, except when otherwise specified in the Technical Instructions; and
 - (3) the English language is used for:
 - (i) package marking and labelling; and
 - (ii) the dangerous goods transport document, in addition to any other language provision.

- (b) The operator or his/her handling agent should use an acceptance checklist which allows for:
- (1) all relevant details to be checked; and
 - (2) the recording of the results of the acceptance check by manual, mechanical or computerised means.

SUBPART H: HELICOPTER OPERATIONS WITH NIGHT VISION IMAGING SYSTEMS

SPA.NVIS.100 Night vision imaging system (NVIS) operations

Regulation (EU) No 965/2012

- (a) Helicopters shall only be operated under VFR at night with the aid of NVIS if the operator has been approved by the competent authority.
- (b) To obtain such approval by the competent authority, the operator shall:
 - (1) operate in commercial air transport (CAT) and hold a CAT AOC in accordance with Annex III (Part-ORO);
 - (2) demonstrate to the competent authority:
 - (i) compliance with the applicable requirements contained in this Subpart;
 - (ii) the successful integration of all elements of the NVIS.

SPA.NVIS.110 Equipment requirements for NVIS operations

Regulation (EU) 2019/1384

- (a) Before conducting NVIS operations each helicopter and all associated NVIS equipment shall have been issued with the relevant airworthiness approval in accordance with Regulation (EU) No 748/2012.
- (b) *Radio altimeter.* The helicopter shall be equipped with a radio altimeter capable of emitting an audio warning below a pre-set height and an audio and visual warning at a height selectable by the pilot, instantly discernible during all phases of NVIS flight.
- (c) *Aircraft NVIS compatible lighting.* To mitigate the reduced peripheral vision cues and the need to enhance situational awareness, the following shall be provided:
 - (1) NVIS-compatible instrument panel flood-lighting, if installed, that can illuminate all essential flight instruments;
 - (2) NVIS-compatible utility lights;
 - (3) portable NVIS compatible flashlight; and
 - (4) a means for removing or extinguishing internal NVIS non-compatible lights.
- (d) *Additional NVIS equipment.* The following additional NVIS equipment shall be provided:
 - (1) a back-up or secondary power source for the night vision goggles (NVG);
 - (2) a helmet with the appropriate NVG attachment.
- (e) All required NVGs on an NVIS flight shall be of the same type, generation and model.
- (f) Continuing airworthiness
 - (1) Procedures for continuing airworthiness shall contain the information necessary for carrying out ongoing maintenance and inspections on NVIS equipment installed in the helicopter and shall cover, as a minimum:
 - (i) helicopter windscreens and transparencies;

- (ii) NVIS lighting;
 - (iii) NVGs; and
 - (iv) any additional equipment that supports NVIS operations.
- (2) Any subsequent modification or maintenance to the aircraft shall be in compliance with the NVIS airworthiness approval.

AMC1 SPA.NVIS.110(b) Equipment requirements for NVIS operations

ED Decision 2012/019/R

RADIO ALTIMETER

- (a) The radio altimeter should:
- (1) be of an analogue type display presentation that requires minimal interpretation for both an instantaneous impression of absolute height and rate of change of height;
 - (2) be positioned to be instantly visible and discernable from each cockpit crew station;
 - (3) have an integral audio and visual low height warning that operates at a height selectable by the pilot; and
 - (4) provide unambiguous warning to the crew of radio altimeter failure.
- (b) The visual warning should provide:
- (1) clear visual warning at each cockpit crew station of height below the pilot-selectable height; and
 - (2) adequate attention-getting-capability for typical NVIS operations.
- (c) The audio warning should:
- (1) be unambiguous and readily cancellable;
 - (2) not extinguish any visual low height warnings when cancelled; and
 - (3) operate at the same pilot-selectable height as the visual warning.

GM1 SPA.NVIS.110(b) Equipment requirements for NVIS operations

ED Decision 2012/019/R

RADIO ALTIMETER

An analogue type display presentation may be, for example, a representation of a dial, ribbon or bar, but not a display that provides numbers only. An analogue type display may be embedded into an electronic flight instrumentation system (EFIS).

GM1 SPA.NVIS.110(f) Equipment requirements for NVIS operations

ED Decision 2012/019/R

MODIFICATION OR MAINTENANCE TO THE HELICOPTER

It is important that the operator reviews and considers all modifications or maintenance to the helicopter with regard to the NVIS airworthiness approval. Special emphasis needs to be paid to modification and maintenance of equipment such as light emitting or reflecting devices,

transparencies and avionics equipment, as the function of this equipment may interfere with the NVGs.

SPA.NVIS.120 NVIS operating minima

Regulation (EU) 2021/2237

- (a) Operations shall not be conducted below the weather minima for the type of night operations being conducted.
- (b) The operator shall establish the minimum transition height from where a change to/from aided flight may be continued.

AMC1 SPA.NVIS.120 NVIS operating minima

ED Decision 2022/012/R

NVIS OPERATIONS UNDER IFR

- (a) Any limitation in the rotorcraft flight manual should be complied with.
- (b) Night-vision goggles may be used in a flipped-down position during a flight under IFR:
 - (1) under VMC;
 - (2) under IMC:
 - (i) in preparation of the visual segment of an instrument approach or a visual approach;
 - (ii) during the visual segment of an instrument approach or departure;
 - (iii) during a visual approach;
 - (iv) in preparation of a transition to VFR.
- (c) The pilot-in-command/commander should not proceed on a visual segment of an IFR flight unless the visual cues required for the visual segment are visible using unaided vision.
- (d) The pilot-in-command/commander should not proceed VFR unless the VFR weather minima are assessed without using unaided vision.

GM1 SPA.NVIS.120 NVIS operating minima

ED Decision 2022/012/R

NVIS OPERATIONS UNDER IFR

The use of night-vision goggles in a flipped-down position does not prevent the use of unaided vision, by looking out below the goggles or to the sides.

SPA.NVIS.130 Crew requirements for NVIS operations

Regulation (EU) No 965/2012

- (a) *Selection.* The operator shall establish criteria for the selection of crew members for the NVIS task.
- (b) *Experience.* The minimum experience for the commander shall not be less than 20 hours VFR at night as pilot-in-command/commander of a helicopter before commencing training.

- (c) *Operational training.* All pilots shall have completed the operational training in accordance with the NVIS procedures contained in the operations manual.
- (d) *Recency.* All pilots and NVIS technical crew members conducting NVIS operations shall have completed three NVIS flights in the last 90 days. Recency may be re-established on a training flight in the helicopter or an approved full flight simulator (FFS), which shall include the elements of (f)(1).
- (e) *Crew composition.* The minimum crew shall be the greater of that specified:
 - (1) in the aircraft flight manual (AFM);
 - (2) for the underlying activity; or
 - (3) in the operational approval for the NVIS operations.
- (f) *Crew training and checking*
 - (1) Training and checking shall be conducted in accordance with a detailed syllabus approved by the competent authority and included in the operations manual.
 - (2) Crew members
 - (i) Crew training programmes shall: improve knowledge of the NVIS working environment and equipment; improve crew coordination; and include measures to minimise the risks associated with entry into low visibility conditions and NVIS normal and emergency procedures.
 - (ii) The measures referred to in (f)(2)(i) shall be assessed during:
 - (A) night proficiency checks; and
 - (B) line checks.

GM1 SPA.NVIS.130(e) Crew requirements for NVIS operations

ED Decision 2012/019/R

UNDERLYING ACTIVITY

Examples of an underlying activity are:

- (a) commercial air transport (CAT);
- (b) helicopter emergency medical service (HEMS); and
- (c) helicopter hoist operation (HHO).

GM2 SPA.NVIS.130(e) Crew requirements for NVIS operations

ED Decision 2019/019/R

OPERATIONAL APPROVAL

- (a) When determining the composition of the minimum crew, the competent authority should take account of the type of operation that is to be conducted. The minimum crew should be part of the operational approval.
- (b) If the operational use of NVIS is limited to the en-route phase of a CAT flight, a single-pilot operation may be approved.

- (c) Where operations to/from a HEMS operating site are to be conducted, a crew of at least one pilot and one NVIS technical crew member would be necessary (this may be the suitably qualified HEMS technical crew member).
- (d) A similar assessment may be made for night HHO, when operating to unprepared sites.

AMC1 SPA.NVIS.130(f)(1) Crew requirements for NVIS operations

ED Decision 2012/019/R

TRAINING AND CHECKING SYLLABUS

- (a) The flight crew training syllabus should include the following items:
 - (1) NVIS working principles, eye physiology, vision at night, limitations and techniques to overcome these limitations;
 - (2) preparation and testing of NVIS equipment;
 - (3) preparation of the helicopter for NVIS operations;
 - (4) normal and emergency procedures including all NVIS failure modes;
 - (5) maintenance of unaided night flying;
 - (6) crew coordination concept specific to NVIS operations;
 - (7) practice of the transition to and from NVG procedures;
 - (8) awareness of specific dangers relating to the operating environment; and
 - (9) risk analysis, mitigation and management.
- (b) The flight crew checking syllabus should include:
 - (1) night proficiency checks, including emergency procedures to be used on NVIS operations; and
 - (2) line checks with special emphasis on the following:
 - (i) local area meteorology;
 - (ii) NVIS flight planning;
 - (iii) NVIS in-flight procedures;
 - (iv) transitions to and from night vision goggles (NVG);
 - (v) normal NVIS procedures; and
 - (vi) crew coordination specific to NVIS operations.
- (c) Whenever the crew is required to also consist of an NVIS technical crew member, he/she should be trained and checked in the following items:
 - (1) NVIS working principles, eye physiology, vision at night, limitations, and techniques to overcome these limitations;
 - (2) duties in the NVIS role, with and without NVGs;
 - (3) the NVIS installation;
 - (4) operation and use of the NVIS equipment;
 - (5) preparing the helicopter and specialist equipment for NVIS operations;

- (6) normal and emergency procedures;
- (7) crew coordination concepts specific to NVIS operations;
- (8) awareness of specific dangers relating to the operating environment; and
- (9) risk analysis, mitigation and management.

AMC1 SPA.NVIS.130(f) Crew requirements for NVIS operations

ED Decision 2022/012/R

CHECKING OF NVIS CREW MEMBERS

- (a) The operator proficiency check and line check required in [SPA.NVIS.130\(f\)](#) should have a validity of 12 calendar months. The validity period should be counted from the end of the month when the training was taken. When the check is undertaken within the last 3 months of the validity period, the new validity period should be counted from the previous expiry date.
- (b) These checks may be combined with those checks required for the underlying activity.

AMC2 SPA.NVIS.130(f) Crew requirements for NVIS operations

ED Decision 2022/012/R

CREW TRAINING AND CHECKING — NVIS OPERATIONS UNDER IFR

- (a) The minimum crew should be two pilots, or one pilot and one NVIS technical crew member.
- (b) The crew training and experience should ensure:
 - (1) efficient scanning of the instruments with the night-vision goggles (NVGs) flipped up or down as defined in the standard operating procedures (SOPs);
 - (2) proficiency during the transition phase;
 - (3) proficient use of the NVGs on the visual segments of the flight during which they are expected to be used;
 - (4) the continuity of a crew concept.
- (c) A crew member that is involved in NVIS operations under IFR should undergo initial and recurrent training using a suitable FSTD as part of the normal crew complement. The training should cover at least the following items under a variety of weather conditions and cultural lighting:
 - (1) transition from instrument to visual flight during the final approach;
 - (2) transition from visual to instrument flight on departure.
- (d) In addition to (b) and (c), a technical crew member that is involved in NVIS operations under IFR should be trained to perform navigation and monitoring functions under IFR, as described under [AMC3 SPA.NVIS.130\(f\)](#). The training should include all of the following on the given helicopter type:
 - (1) initial and recurrent general training;
 - (2) initial and recurrent monitoring training;
 - (3) initial and recurrent navigation training;
 - (4) initial and recurrent aircraft/FSTD training focusing on crew cooperation with the pilot;

- (5) LIFUS.
- (e) An FSTD suitable for the NVIS training described in (c) should meet all of the following criteria:
 - (1) be a helicopter FSTD;
 - (2) have a NVIS-compatible cockpit;
 - (3) have a night visual system that can be representative of different moon phases and allows external visual cues to be adjusted to the point where they are no longer visible without NVGs and remain visible with NVGs, when simulating night conditions;
 - (4) The night visual system should be able to support atmospheric conditions such as:
 - (i) more than one cloud layer or one cloud layer with a geographically variable cloud base;
 - (ii) variable visibility; and
 - (iii) snow, light rain and heavy rain with and without NVGs;
 - (5) be of a helicopter type on which the crew member is current unless the crew member receives additional training for the use of the FSTD.
- (f) The person conducting the training defined in (c) above should be a NVIS instructor and should hold an instrument rating in accordance with [Regulation \(EU\) No 1178/2011](#).
- (g) The training should have a validity of 12 calendar months. The validity period should be counted from the end of the month when the training was taken. When the training is undertaken within the last 3 months of the validity period, the new validity period should be counted from the previous expiry date.
- (h) The flight crew operator proficiency check should include one transition from instrument to visual flight during the final approach, using NVIS. This manoeuvre may be combined with a 2D or 3D approach to minima.
- (i) NVIS operations under IFR on more than one type or variant with different levels of automation
 - (1) The crew member should be provided with differences training or familiarisation.
 - (2) The flight crew member should perform the manoeuvre defined in (h) each time on a different type or variant.

AMC3 SPA.NVIS.130(f) Crew requirements for NVIS operations

ED Decision 2022/012/R

CREW TRAINING AND CHECKING — TECHNICAL CREW MEMBER TRAINING FOR OPERATIONS UNDER IFR — INITIAL AND RECURRENT GENERAL TRAINING AND CHECKING

- (a) The technical crew member initial and recurrent training and checking syllabus should include the following items:
 - (1) duties in the technical crew member role;
 - (2) map reading, including:
 - (i) ability to keep track with helicopter position on map;
 - (ii) ability to detect conflicting terrain/obstacles on a given route, and at a given altitude;
 - (iii) use of moving maps, as required;

- (3) basic understanding of the helicopter type in terms of location and design of normal and emergency systems and equipment, including all helicopter lights and operation of doors, and including knowledge of helicopter systems and understanding of the terminology used in checklists;
- (4) the dangers of rotor-running helicopters;
- (5) outside lookout during the flight;
- (6) crew coordination with in-flight call-outs, with emphasis on crew coordination regarding the tasks of the technical crew member, including checklist initiation, interruptions and termination;
- (7) warnings, and use of normal, abnormal and emergency checklists assisting the pilot as required;
- (8) the use of the helicopter intercommunications system;
- (9) basic helicopter performance principles, including the definitions of Category A certification, performance class 1 and performance class 2;
- (10) operational control and supervision;
- (11) meteorology;
- (12) applicable parts of SERA, including instrument flight rules (IFR), as relevant to the tasks of the technical crew member;
- (13) mission planning;
- (14) early identification of pilot incapacitation;
- (15) debriefing; and
- (16) PBN, as necessary.

INITIAL AND RECURRENT NAVIGATION TRAINING AND CHECKING

- (b) The initial and recurrent navigation training and checking syllabus should include the following items:
 - (1) aeronautical map reading (additional training to (a)(4) above), navigation principles;
 - (2) navigation aid principles and use;
 - (3) crew coordination with in-flight call-outs, with emphasis on navigation issues;
 - (4) applicable parts of SERA; and
 - (5) airspace, restricted areas, and noise-abatement procedures.

INITIAL AND RECURRENT MONITORING TRAINING AND CHECKING

- (c) The initial and recurrent monitoring training and checking syllabus should include the following items:
 - (1) basic understanding of the helicopter type, including knowledge of any limitations to the parameters the crew member is tasked to monitor, and knowledge of the basic principles of flight;
 - (2) instrument reading;
 - (3) inside monitoring during the flight;

- (i) aircraft state/cockpit cross-check;
- (ii) automation philosophy and autopilot status monitoring, as relevant;
- (iii) FMS, as relevant;
- (4) crew coordination with in-flight call-outs, with emphasis on call-outs and actions resulting from the monitoring process; and
- (5) flight path monitoring.

INITIAL AIRCRAFT/FSTD TRAINING

- (d) The technical crew member training syllabus should include aircraft/FSTD training focusing on crew cooperation with the pilot.
 - (1) The initial training should include at least 4 hours instruction dedicated to crew cooperation unless:
 - (i) the technical crew member has undergone this training under another operator; or
 - (ii) the technical crew member has performed at least 50 missions in assisting the pilot from the front seat as a technical crew member.
 - (2) The training described in (1) should be organised with a crew composition of one pilot and one technical crew member.
 - (3) The training described in (1) should be supervised by a pilot with a minimum experience of 500 hours in either multi-pilot operations or single-pilot operations with a technical crew member assisting from the front seat, or a combination of these.
 - (4) The training may be combined with the LIFUS.

LINE FLYING UNDER SUPERVISION (LIFUS)

- (e) LIFUS
 - (1) LIFUS should take place during the operator's conversion course.
 - (2) Line flights under supervision provide the opportunity for a technical crew member to practise the procedures and techniques he or she should be familiar with, regarding ground and flight operations, including any elements that are specific to a particular helicopter type. Upon completion of the LIFUS, the technical crew member should be able to safely conduct the flight operational duties assigned to him or her according to the procedures laid down in the operator's operations manual.
 - (3) LIFUS should be conducted by a suitably qualified technical crew member or commander nominated by the operator.
 - (4) LIFUS should include a minimum of five sectors under IFR.

RECURRENT AIRCRAFT/FSTD TRAINING

- (f) Recurrent helicopter/FSTD training
 - (1) The recurrent training should focus on crew cooperation and contain a minimum of 2 hours of flight.
 - (2) The training described in (1) should take place in the same conditions as the initial training in (d) above.

GM1 SPA.NVIS.130(f) Crew requirements for NVIS operations

ED Decision 2022/012/R

TRAINING GUIDELINES AND CONSIDERATIONS

(a) Purpose

The purpose of this GM is to recommend the minimum training guidelines and any associated considerations necessary for the safe operation of a helicopter while operating with night vision imaging systems (NVISs).

To provide an appropriate level of safety, training procedures should accommodate the capabilities and limitations of the NVIS and associated systems as well as the restraints of the operational environment.

(b) Assumptions

The following assumptions were used in the creation of this material:

- (1) Most civilian operators may not have the benefit of formal NVIS training, similar to that offered by the military. Therefore, the stated considerations are predicated on that individual who has no prior knowledge of NVIS or how to use them in flight. The degree to which other applicants who have had previous formal training should be exempted from this training will be dependent on their prior NVIS experience.
- (2) While NVIS are principally an aid to flying under VFR at night, the two-dimensional nature of the NVG image necessitates frequent reference to the flight instruments for spatial and situational awareness information. The reduction of peripheral vision and increased reliance on focal vision exacerbates this requirement to monitor flight instruments. Therefore, any basic NVIS training syllabus should include some instruction on basic instrument flight.

(c) Two-tiered approach: basic and advance training

To be effective, the NVIS training philosophy would be based on a two-tiered approach: basic and advanced NVIS training. The basic NVIS training would serve as the baseline standard for all individuals seeking an NVIS endorsement. The content of this initial training would not be dependent on any operational requirements. The training required for any individual pilot should take into account the previous NVIS flight experience. The advanced training would build on the basic training by focusing on developing specialised skills required to operate a helicopter during NVIS operations in a particular operational environment. Furthermore, while there is a need to stipulate minimum flight hour requirements for an NVIS endorsement, the training should also be event-based. This necessitates that operators be exposed to all of the relevant aspects, or events, of NVIS flight in addition to acquiring a minimum number of flight hours. NVIS training should include flight in a variety of actual ambient light and weather conditions.

(d) Training requirements

(1) Flight crew ground training

The ground training necessary to initially qualify a pilot to act as the pilot of a helicopter using NVGs should include at least the following subjects:

- (i) applicable aviation regulations that relate to NVIS limitations and flight operations;
- (ii) aero-medical factors relating to the use of NVGs to include how to protect night vision, how the eyes adapt to operate at night, self-imposed stresses that affect

night vision, effects of lighting (internal and external) on night vision, cues utilized to estimate distance and depth perception at night, and visual illusions;

- (iii) NVG performance and scene interpretation;
- (iv) normal, abnormal, and emergency operations of NVGs; and
- (v) NVIS operations flight planning to include night terrain interpretation and factors affecting terrain interpretation.

The ground training should be the same for flight crew and crew members other than flight crew. An example of a ground training syllabus is presented in Table 1 of [GM2 SPA.NVIS.130\(f\)](#).

(2) Flight crew flight training

The flight training necessary to initially qualify a pilot to act as the pilot of a helicopter using NVGs may be performed in a helicopter or FSTD approved for the purpose, and should include at least the following subjects:

- (i) preparation and use of internal and external helicopter lighting systems for NVIS operations;
- (ii) pre-flight preparation of NVGs for NVIS operations;
- (iii) proper piloting techniques (during normal, abnormal, and emergency helicopter operations) when using NVGs during the take-off, climb, en-route, descent, and landing phases of flight that includes unaided flight and aided flight; and
- (iv) normal, abnormal, and emergency operations of the NVIS during flight.

Crew members other than flight crew should be involved in relevant parts of the flight training. An example of a flight training syllabus is presented in Table 1 of [GM3 SPA.NVIS.130\(f\)](#).

(3) Training crew members other than flight crew

Crew members other than flight crew (including the technical crew member) should be trained to operate around helicopters employing NVIS. These individuals should complete all phases of NVIS ground training that is given to flight crew. Due to the importance of crew coordination, it is imperative that all crew members are familiar with all aspects of NVIS flight. Furthermore, these crew members may have task qualifications specific to their position in the helicopter or areas of responsibility. To this end, they should demonstrate competency in those areas, both on the ground and in flight.

(4) Ground personnel training

Non-flying personnel who support NVIS operations should also receive adequate training in their areas of expertise. The purpose is to ensure, for example, that correct light discipline is used when helicopters are landing in a remote area.

(5) Instructor qualifications

An NVIS flight instructor should at least have the following licences and qualifications:

- (i) at least flight instructor (FI(H)) or type rating instructor (TRI(H)) with the applicable type rating on which NVIS training will be given; and
- (ii) logged at least 100 NVIS flights or 30 hours' flight time under NVIS as pilot-in-command/commander.

(6) NVIS equipment minimum requirements (training)

While minimum equipment lists and standard NVIS equipment requirements may be stipulated elsewhere, the following procedures and minimum equipment requirements should also be considered:

(i) NVIS: the following is recommended for minimum NVIS equipment and procedural requirements:

- (A) back-up power supply;
- (B) NVIS adjustment kit or eye lane;
- (C) use of helmet with the appropriate NVG attachment; and
- (D) both the instructor and student should wear the same NVG type, generation and model.

(ii) Helicopter NVIS compatible lighting, flight instruments and equipment: given the limited peripheral vision cues and the need to enhance situational awareness, the following is recommended for minimum compatible lighting requirements:

- (A) NVIS compatible instrument panel flood lighting that can illuminate all essential flight instruments;
- (B) NVIS compatible hand-held utility lights;
- (C) portable NVIS compatible flashlight;
- (D) a means for removing or extinguishing internal NVIS non-compatible lights;
- (E) NVIS pre-flight briefing/checklist (an example of an NVIS pre-flight briefing/checklist is in Table 1 of [GM4 SPA.NVIS.130\(f\)](#));
- (F) training references:

a number of training references are available, some of which are listed below:

- DO 295 US CONOPS civil operator training guidelines for integrated NVIS equipment
- United States Marine Corp MAWTS-1 Night Vision Device (NVD) Manual;
- U.S. Army Night Flight (TC 1-204);
- U.S. Army NVIS Operations, Exportable Training Package;
- U.S. Army TM 11-5855-263-10;
- Air Force TO 12S10-2AVS6-1;
- Navy NAVAIR 16-35AVS-7; and
- U.S. Border Patrol, Helicopter NVIS Ground and Flight Training Syllabus.

There may also be further documents available from European civil or military sources.

GM2 SPA.NVIS.130(f) Crew requirements for NVIS operations

ED Decision 2022/012/R

INSTRUCTION – GROUND TRAINING AREAS OF INSTRUCTION

A detailed example of possible subjects to be instructed in an NVIS ground instruction is included below. (The exact details may not always be applicable, e.g. due to goggle configuration differences.)

Table 1

Ground training areas of instruction

Item	Subject Area	Subject Details	Recommended Time
1	General anatomy and characteristics of the eye	Anatomy: <ul style="list-style-type: none"> — Overall structure of the eye — Cones — Rods Visual deficiencies: <ul style="list-style-type: none"> — myopia — hyperopia — astigmatism — presbyopia Effects of light on night vision & NV protection physiology: <ul style="list-style-type: none"> — Light levels <ul style="list-style-type: none"> — illumination — luminance — reflectance — contrast — Types of vision: <ul style="list-style-type: none"> — photopic — mesopic — scotopic — Day versus night vision — Dark adaptation process: <ul style="list-style-type: none"> — dark adaptation — pre-adaptive state — Purkinje shift — Ocular chromatic aberration — Photochromatic interval 	1 hour
2	Night vision human factors	<ul style="list-style-type: none"> — Night blind spot (as compared to day blind spot) — Field of view and peripheral vision — Distance estimation and depth perception: <ul style="list-style-type: none"> — monocular cues — motion parallax — geometric perspective — size constancy — overlapping contours or interposition of objects — Aerial perspective: <ul style="list-style-type: none"> — variations in colour or shade — loss of detail or texture — position of light source — direction of shadows — Binocular cues — Night vision techniques: 	1 hour

Item	Subject Area	Subject Details	Recommended Time
		<ul style="list-style-type: none"> — off-centre vision — scanning — shapes and silhouettes 	
		<ul style="list-style-type: none"> — Vestibular illusions — Somatogyral illusions: <ul style="list-style-type: none"> — leans — graveyard spin — coriolis illusion — Somatogavic illusions: <ul style="list-style-type: none"> — oculographic illusions — elevator illusion — oculoagravic illusions — Proprioceptive illusions — Dealing with spatial disorientation — Visual illusions: <ul style="list-style-type: none"> — auto kinetic illusion — confusion with ground lights — relative motion — reversible perspective illusion — false vertical and horizontal cues — altered planes of reference — height /depth perception illusion — flicker vertigo — fascination (fixation) — structural illusions — size-distance illusion — Helicopter design limitations: <ul style="list-style-type: none"> — windscreen condition — helicopter instrument design — helicopter structural obstruction — interior lights — exterior lights — Self-imposed stresses: <ul style="list-style-type: none"> — drugs — exhaustion — alcohol — tobacco — hypoglycaemia — injuries — physical fitness — Stress & fatigue: <ul style="list-style-type: none"> — acute vs. chronic — prevention — Hypoxia issues and night vision — Weather/environmental conditions: <ul style="list-style-type: none"> — snow (white-out) — dust (brown-out) — haze — fog — rain — light level — Astronomical lights (moon, star, northern lights) — Effects of cloud cover 	

Item	Subject Area	Subject Details	Recommended Time
3	NVIS general characteristics	<ul style="list-style-type: none"> — Definitions and types of NVIS: <ul style="list-style-type: none"> — light spectrum — types of NVIS — Thermal-imaging devices — Image-intensifier devices — Image-intensifier operational theory — Types of image intensifier systems: <ul style="list-style-type: none"> — generation 1 — generation 2 — generation 3 — generation 4 — type I / II — class A & B minus blue filter — NVIS equipment <ul style="list-style-type: none"> — shipping and storage case — carrying case — binocular assembly — lens caps — lens paper — operators manual — power pack (dual battery) — batteries — Characteristics of NVIS: <ul style="list-style-type: none"> — light amplification — light intensification — frequency sensitivity — visual range acuity — unaided peripheral vision — weight — flip-up device — break-away feature — neck cord — maintenance issues — human factor issues — Description and functions of NVIS components: <ul style="list-style-type: none"> — helmet visor cover and extension strap — helmet NVIS mount and attachment points — different mount options for various helmets — lock release button — vertical adjustment knob — low battery indicator — binocular assembly — monocular tubes — fore and aft adjustment knob — eye span knob — tilt adjustment lever — objective focus rings — eyepiece focus rings — battery pack 	1 hour
4	NVIS care & cleaning	<ul style="list-style-type: none"> — Handling procedures — NVIS operating instructions: 	1 hour

Item	Subject Area	Subject Details	Recommended Time
		<ul style="list-style-type: none"> — pre-mounting inspection — mounting procedures — focusing procedures — faults — Post-flight procedures; — Deficiencies: type and recognition of faults: <ul style="list-style-type: none"> — acceptable faults — black spots — chicken wire — fixed pattern noise (honeycomb effect) — output brightness variation — bright spots — image disparity — image distortion — emission points — unacceptable faults: <ul style="list-style-type: none"> — shading — edge glow — flashing, flickering or intermittent operation — Cleaning procedures — Care of batteries — Hazardous material considerations; 	
5	Pre- & post-flight procedures	<ul style="list-style-type: none"> — Inspect NVIS — Carrying case condition — Nitrogen purge due date — Collimation test due date — Screens diagram(s) of any faults — NVIS kit: complete — NVIS binocular assembly condition — Battery pack and quick disconnect condition — Batteries life expended so far — Mount battery pack onto helmet: <ul style="list-style-type: none"> — verify no LED showing (good battery) — fail battery by opening cap and LED illuminates (both compartments) — Mount NVIS onto helmet — Adjust and focus NVIS — Eye-span to known inter-pupillary distance — Eye piece focus ring to zero — Adjustments: <ul style="list-style-type: none"> — vertical — fore and aft — tilt — eye-span (fine-tuning) — Focus (one eye at a time at 20 ft, then at 30 ft from an eye chart) <ul style="list-style-type: none"> — objective focus ring — eye piece focus ring — verify both images are harmonised — read eye-chart 20/40 line from 20 ft — NVIS mission planning — NVIS light level planning 	1 hour

Item	Subject Area	Subject Details	Recommended Time
		— NVIS risk assessment	
6	NVIS terrain interpretation and environmental factors	<ul style="list-style-type: none"> — Night terrain interpretation — Light sources: <ul style="list-style-type: none"> — natural — lunar — solar — starlight — northern lights — artificial — cultural — infra-red — Meteorological conditions: <ul style="list-style-type: none"> — clouds/fog — indications of restriction to visibility: <ul style="list-style-type: none"> — loss of celestial lights — loss of ground lights — reduced ambient light levels — reduced visual acuity — increase in video noise — increase in halo effect — Cues for visual recognition: <ul style="list-style-type: none"> — object size — object shape — contrast — ambient light — colour — texture — background — reflectivity — Factors affecting terrain interpretation: <ul style="list-style-type: none"> — ambient light — flight altitudes — terrain type — Seasons — Night navigation cues: <ul style="list-style-type: none"> — terrain relief — vegetation — hydrographical features — cultural features 	1 hour
7	NVIS training & equipment requirements	<p>Cover the relevant regulations and guidelines that pertain to night and NVIS flight to include as a minimum:</p> <ul style="list-style-type: none"> — Crew experience requirements; — Crew training requirements; — Airspace requirements; — Night / NVIS MEL; — NVIS / night weather limits; — NVIS equipment minimum standard requirements. 	1 hour
8	NVIS emergency procedures	<p>Cover relevant emergency procedures:</p> <ul style="list-style-type: none"> — Inadvertent IMC procedures — NVIS goggle failure — Helicopter emergencies: 	1 hour

Item	Subject Area	Subject Details	Recommended Time
		<ul style="list-style-type: none"> — with goggles — transition from goggles 	
9	NVIS flight techniques	Respective flight techniques for each phase of flight for the type and class of helicopter used for NVIS training	1 hour
10	Basic instrument techniques	Present and confirm understanding of basic instrument flight techniques: <ul style="list-style-type: none"> — Instrument scan — Role of instruments in NVIS flight — Unusual attitude recovery procedures 	1 hour
11	Blind cockpit drills	Perform blind cockpit drills: <ul style="list-style-type: none"> — Switches — Circuit breakers — Exit mechanisms — External / internal lighting — Avionics 	1 hour

GM3 SPA.NVIS.130(f) Crew requirements for NVIS operations

ED Decision 2022/012/R

FLIGHT TRAINING – AREAS OF INSTRUCTION

A detailed example of possible subjects to be instructed in a NVIS flight instruction is included below.

Table 1

Flight training areas of instruction

Item	Subject Area	Subject Details	Recommended Time
1	Ground operations	<ul style="list-style-type: none"> — NVIS equipment assembly — Pre-flight inspection of NVISs — Helicopter pre-flight — NVIS flight planning: <ul style="list-style-type: none"> — light level planning — meteorology — obstacles and known hazards — risk analysis matrix — CRM concerns — NVIS emergency procedures review — Start-up/shut down — Goggling and degoggling 	1 hour
2	General handling	<ul style="list-style-type: none"> — Level turns, climbs, and descents — For helicopters, confined areas and sloped landings — Operation specific flight tasks — Transition from aided to unaided flight — Demonstration of NVIS related ambient and cultural effects 	1 hour
3	Take-offs & landings	<ul style="list-style-type: none"> — At both improved illuminated areas such as airports/airfields and unimproved unlit areas such as open fields — Traffic pattern — Low speed manoeuvres for helicopters 	1 hour

4	Navigation	—	Navigation over variety of terrain and under different cultural lighting conditions	1 hour
5	Emergency procedures	—	Goggle failure — Helicopter emergencies — Inadvertent IMC — Unusual attitude recovery	1 hour

GM4 SPA.NVIS.130(f) Crew requirements for NVIS operations

ED Decision 2022/012/R

NVIS PRE-FLIGHT BRIEFING/CHECKLIST

A detailed example of a pre-flight briefing/checklist is included below.

Table 1

NVIS pre-flight briefing/checklist

Item	Subject
1	Weather: — METAR/forecast — Cloud cover/dew point spread/precipitation
2	OPS items: — NOTAMs — IFR publications backup/maps — Goggles adjusted using test set (RTCA Document DO-275 [NVIS MOPS], Appendices G & H give suggested NVG pre-flight and adjustment procedures and a ground test checklist)
3	Ambient light: — Moon rise/set/phase/position/elevation — % illumination and millilux (MLX) for duration of flight — Recommended minimum MLX: 1.5
4	Mission: — Mission outline — Terrain appreciation — Detailed manoeuvres — Flight timings — Start/airborne/debrief — Airspace coordination for NVIS — Obstacles/minimum safe altitude — NVIS goggle up/degoggle location/procedure — Instrument IFR checks
5	Crew: — Crew day/experience — Crew position — Equipment: NVIS, case, video, flashlights — Lookout duties: left hand seat (LHS) – from 90° left to 45° right, RHS – from 90° right to 45° left; — Calling of hazards/movements landing light — Transfer of control terminology — Below 100 ft AGL – pilot monitoring (PM) ready to assume control
6	Helicopter: — Helicopter configuration — Fuel and CG
7	Emergencies:

- NVIS failure: cruise and low level flight
- Inadvertent IMC/IFR recovery
- Helicopter emergency: critical & non-critical

GM5 SPA.NVIS.130(f) Crew requirements for NVIS operations

ED Decision 2022/012/R

CREW TRAINING AND CHECKING — SUITABLE FSTD — NVIS OPERATIONS UNDER IFR

The FSTD may be a generic FSTD and may have no motion system.

SPA.NVIS.140 Information and documentation

Regulation (EU) No 965/2012

The operator shall ensure that, as part of its risk analysis and management process, risks associated with the NVIS environment are minimised by specifying in the operations manual: selection, composition and training of crews; levels of equipment and dispatch criteria; and operating procedures and minima, such that normal and likely abnormal operations are described and adequately mitigated.

AMC1 SPA.NVIS.140 Information and documentation

ED Decision 2012/019/R

OPERATIONS MANUAL

The operations manual should include:

- (a) equipment to be carried and its limitations;
- (b) the minimum equipment list (MEL) entry covering the equipment specified;
- (c) risk analysis, mitigation and management;
- (d) pre- and post-flight procedures and documentation;
- (e) selection and composition of crew;
- (f) crew coordination procedures, including:
 - (1) flight briefing;
 - (2) procedures when one crew member is wearing NVG and/or procedures when two or more crew members are wearing NVGs;
 - (3) procedures for the transition to and from NVIS flight;
 - (4) use of the radio altimeter on an NVIS flight; and
 - (5) inadvertent instrument meteorological conditions (IMC) and helicopter recovery procedures, including unusual attitude recovery procedures;
- (g) the NVIS training syllabus;
- (h) in-flight procedures for assessing visibility, to ensure that operations are not conducted below the minima stipulated for non-assisted night VFR operations;
- (i) weather minima, taking the underlying activity into account; and
- (j) the minimum transition heights to/from an NVIS flight.

GM1 SPA.NVIS.140 Information and documentation

ED Decision 2022/012/R

CONCEPT OF OPERATIONS

Night Vision Imaging System for Civil Operators

Foreword

This document, initially incorporated in JAA TGL-34, prepared by a Sub-Group of EUROCAE Working Group 57 “Night Vision Imaging System (NVIS) Standardisation” is an abbreviated and modified version of the RTCA Report DO-268 “Concept Of Operations – Night Vision Imaging Systems For Civil Operators” which was prepared in the USA by RTCA Special Committee 196 (SC-196) and approved by the RTCA Technical Management Committee in March 2001.

The EUROCAE Working Group 57 (WG-57) Terms of Reference included a task to prepare a Concept of Operations (CONOPS) document describing the use of NVIS in Europe. To complete this task, a Sub-Group of WG-57 reviewed the RTCA SC-196 CONOPS (DO-268) to assess its applicability for use in Europe. Whilst the RTCA document was considered generally applicable, some of its content, such as crew eligibility and qualifications and the detail of the training requirements, was considered to be material more appropriately addressed in Europe by at that time other Joint Aviation Requirements (JAR) documents such as JAR-OPS and JAR-FCL. Consequently, WG-57 condensed the RTCA CONOPS document by removing this material which is either already addressed by other JAR documents or will be covered by the Agency’s documents in the future.

In addition, many of the technical standards already covered in the Minimum Operational Performance Standards (MOPS) for Integrated Night Vision Imaging System Equipment (DO-275) have been deleted in this European CONOPS.

Executive summary

The hours of darkness add to a pilot’s workload by decreasing those visual cues commonly used during daylight operations. The decreased ability of a pilot to see and avoid obstructions at night has been a subject of discussion since aviators first attempted to operate at night. Technology advancements in the late 1960s and early 1970s provided military aviators some limited ability to see at night and therein changed the scope of military night operations. Continuing technological improvements have advanced the capability and reliability of night vision imaging systems to the point that they are receiving increasing scrutiny are generally accepted by the public and are viewed by many as a tool for night flight.

Simply stated, night vision imaging systems are an aid to night VFR flight. Currently, such systems consist of a set of night vision goggles and normally a complementary array of cockpit lighting modifications. The specifications of these two sub-system elements are interdependent and, as technology advances, the characteristics associated with each element are expected to evolve. The complete description and performance standards of the night vision goggles and cockpit lighting modifications appropriate to civil aviation are contained in the Minimum Operational Performance Standards for Integrated Night Vision Imaging System Equipment.

An increasing interest on the part of civil operators to conduct night operations has brought a corresponding increased level of interest in employing night vision imaging systems. However, the night vision imaging systems do have performance limitations. Therefore, it is incumbent on the operator to employ proper training methods and operating procedures to minimise these limitations to ensure safe operations. In turn, operators employing night vision imaging systems must have the guidance and support of their regulatory agency in order to safely train and operate with these systems.

The role of the regulatory agencies in this matter is to develop the technical standard orders for the hardware as well as the advisory material and inspector handbook materials for the operations and training aspect. In addition, those agencies charged with providing flight weather information should modify their products to include the night vision imaging systems flight data elements not currently provided.

An FAA study (DOT/FAA/RD-94/21, 1994) best summarised the need for night vision imaging systems by stating, ‘When properly used, NVGs can increase safety, enhance situational awareness, and reduce pilot workload and stress that are typically associated with night operations.’

Concept of operations — NVIS operations under IFR

The NVIS can be useful to assess the environment when not in a cloud layer if procedures are established for its use. It may also be useful for decision-making before cancelling IFR and during the transition from instrument flight to visual flight under IFR.

During departure, the NVIS provides extra safety if used correctly. This is especially true for a departure where the instruction is to proceed VFR from the FATO to the initial departure fix (IDF) because VFR departures provide no obstacle protection. It could also be useful for other instrument departures.

During the transition to visual flight, the NVIS provides additional safety because the visibility may be very different with or without the NVIS, and it may help to assess the situation.

The scanning of instruments and of external cues will be modified. Multi-crew operations with SOPs and the relevant training should be in place.

Operator SOPs may define that when one of the crew members uses the NVGs in a flipped-down position, the other should have the NVGs flipped up and should monitor the flight instruments and navigation instruments used for the flight. In this case, the continuity of the crew concept will rely on efficient crew communication.

In other situations and operations, the operator SOPs may also define that both crew members have NVGs in the flipped-down position, using the capability to look below the NVGs to monitor both the instruments and the VMC situation.

2. TERMINOLOGY

2.1 Night vision goggles

An NVG is a binocular appliance that amplifies ambient light and is worn by a pilot. The NVG enhances the wearer’s ability to maintain visual surface reference at night.

2.1.1 Type

Type refers to the design of the NVG with regards to the manner in which the image is relayed to the pilot. A Type 1 NVG is one in which the image is viewed directly in-line with the image intensification process. A Type 1 NVG is also referred to as “direct view” goggle. A Type 2 NVG is one in which the image intensifier is not in-line with the image viewed by the pilot. In this design, the image may be reflected several times before being projected onto a combiner in front of the pilot’s eyes. A Type 2 NVG is also referred to as an “indirect view” goggle.

2.1.2 Class

Class is a terminology used to describe the filter present on the NVG objective lens. The filter restricts the transmission of light below a determined frequency. This allows the cockpit lighting to be designed and installed in a manner that does not adversely affect NVG performance.

2.1.2.1 Class A

Class A or “minus blue” NVGs incorporate a filter, which generally imposes a 625 nanometer cutoff. Thus, the use of colours in the cockpit (e.g., colour displays, colour warning lights, etc.) may be limited. The blue green region of the light spectrum is allowed through the filter.

2.1.2.2 Class B

Class B NVGs incorporate a filter that generally imposes a 665 nanometer cutoff. Thus, the cockpit lighting design may incorporate more colours since the filter eliminates some yellows and oranges from entering the intensification process.

2.1.2.3 Modified class B

Modified Class B NVGs incorporate a variation of a Class B filter but also incorporate a notch filter in the green spectrum that allows a small percentage of light into the image intensification process. Therefore, a Modified Class B NVG allows pilots to view fixed head-up display (HUD) symbology through the NVG without the HUD energy adversely affecting NVG performance.

2.1.3 Generation

Generation refers to the technological design of an image intensifier. Systems incorporating these light-amplifying image intensifiers were first used during WWII and were operationally fielded by the US military during the Vietnam era. These systems were large, heavy and poorly performing devices that were unsuitable for aviation use, and were termed Generation I (Gen I). Gen II devices represented a significant technological advancement and provided a system that could be head-mounted for use in ground vehicles. Gen III devices represented another significant technological advancement in image intensification, and provided a system that was designed for aviation use. Although not yet fielded, there are prototype NVGs that include technological advances that may necessitate a Gen IV designation if placed into production. Because of the variations in interpretations as to generation, NVGs will not be referred to by the generation designation.

2.1.4 OMNIBUS

The term OMNIBUS refers to a US Army contract vehicle that has been used over the years to procure NVGs. Each successive OMNIBUS contract included NVGs that demonstrated improved performance. There have been five contracts since the mid 1980s, the most current being OMNIBUS V. There may be several variations of NVGs within a single OMNIBUS purchase, and some NVGs from previous OMNIBUS contracts have been upgraded in performance to match the performance of goggles from later contracts. Because of these variations, NVGs will not be referred to by the OMNIBUS designation.

2.1.5 Resolution and visual acuity

Resolution refers to the capability of the NVG to present an image that makes clear and distinguishable the separate components of a scene or object.

Visual acuity is the relative ability of the human eye to resolve detail and interpret an image.

2.2 Aviation night vision imaging system (NVIS)

The Night Vision Imaging System is the integration of all elements required to successfully and safely operate an aircraft with night vision goggles. The system includes at a minimum NVGs, NVIS lighting, other aircraft components, training, and continuing airworthiness.

2.2.1 Look under (under view)

Look under is the ability of pilots to look under or around the NVG to view inside and outside the aircraft.

2.3 NVIS lighting

An aircraft lighting system that has been modified or designed for use with NVGs and which does not degrade the performance of the NVG beyond acceptable standards, is designated as NVIS lighting. This can apply to both interior and exterior lighting.

2.3.1 Design considerations

As the choice of NVG filter drives the cockpit lighting design, it is important to know which goggle will be used in which cockpit. Since the filter in a Class A NVG allows wavelengths above 625 nanometers into the intensification process, it should not be used in a cockpit designed for Class B or Modified Class B NVGs. However, since the filter in a Class B and Modified Class B NVGs is more restrictive than that in a Class ANVG, the Class B or Modified Class B NVG can be used with either Class A or Class B cockpit lighting designs.

2.3.2 Compatible

Compatibility, with respect to an NVIS system, includes a number of different factors: compatibility of internal and external lighting with the NVG, compatibility of the NVG with the crew station design (e.g., proximity of the canopy or windows, proximity of overhead panels, operability of controls, etc.), compatibility of crew equipment with the NVG and compatibility with respect to colour discrimination and identification (e.g., caution and warning lights still maintain amber and red colours). The purpose of this paragraph is to discuss compatibility with respect to aircraft lighting. An NVIS lighting system, internal and external, is considered compatible if it adheres to the following requirements:

1. the internal and external lighting does not adversely affect the operation of the NVG during any phase of the NVIS operation;
2. the internal lighting provides adequate illumination of aircraft cockpit instruments, displays and controls for unaided operations and for “look-under” viewing during aided operations; and
3. The external lighting aids in the detection and separation by other aircraft.

NVIS lighting compatibility can be achieved in a variety of ways that can include, but is not limited to, modification of light sources, light filters or by virtue of location. Once aircraft lighting is modified for using NVGs, it is important to keep in mind that changes in the crew station (e.g., addition of new display) must be assessed relative to the effect on NVIS compatibility.

2.4. NVIS operation

A night flight wherein the pilot maintains visual surface reference using NVGs in an aircraft that is NVIS approved

2.4.1 Aided

Aided flight is flight with NVGs in an operational position.

2.4.2 Unaided

Unaided flight is a flight without NVGs or a flight with NVGs in a non-operational position.

3. SYSTEM DESCRIPTION

3.1 NVIS capabilities

NVIS generally provides the pilot an image of the outside scene that is enhanced compared to that provided by the unaided, dark-adapted eye. However, NVIS may not provide the user an image equal to that observed during daylight. Since the user has an enhanced visual capability, situational awareness is generally improved.

3.1.1 Critical elements

The following critical elements are the underlying assumptions in the system description for NVIS:

1. aircraft internal lighting has been modified or initially designed to be compatible;
2. environmental conditions are adequate for the use of NVIS (e.g. enough illumination is present, weather conditions are favourable, etc.);
3. the NVIS has been properly maintained in accordance with the minimum operational performance standards;
4. a proper pre-flight has been performed on the NVIS confirming operation in accordance with the continued airworthiness standards and training guidelines; and
5. the pilot(s) has been properly trained and meets recency of experience requirements.

Even when insuring that these conditions are met, there still are many variables that can adversely affect the safe and effective use of NVIS (e.g., flying towards a low angle moon, flying in a shadowed area, flying near extensive cultural lighting, flying over low contrast terrain, etc.). It is important to understand these assumptions and limitations when discussing the capabilities provided by the use of NVIS.

3.1.2 Situation awareness

Situation awareness, being defined as the degree of perceptual accuracy achieved in the comprehension of all factors affecting an aircraft and crew at a given time, is improved at night when using NVG during NVIS operations. This is achieved by providing the pilot with more visual cues than is normally available under most conditions when operating an aircraft unaided at night. However, it is but one source of the factors necessary for maintaining an acceptable level of situational awareness.

3.1.2.1 Environment detection and identification

An advantage of using NVIS is the enhanced ability to detect, identify, and avoid terrain and/or obstacles that present a hazard to night operations. Correspondingly, NVIS aid in night navigation by allowing the aircrew to view waypoints and features.

Being able to visually locate and then (in some cases) identify objects or areas critical to operational success will also enhance operational effectiveness. Finally, use of NVIS may allow pilots to detect other aircraft more easily.

3.1.3 Emergency situations

NVIS generally improve situational awareness, facilitating the pilot's workload during emergencies. Should an emergency arise that requires an immediate landing, NVIS may provide the pilot with a means of locating a suitable landing area and conducting a landing. The pilot must determine if the use of NVIS during emergencies is appropriate. In certain instances, it

may be more advantageous for the pilot to remove the NVG during the performance of an emergency procedure.

3.2.1 NVG design characteristics

There are limitations inherent in the current NVG design.

3.2.1.1 Visual acuity

The pilot's visual acuity with NVGs is less than normal daytime visual acuity.

3.2.1.2 Field of view

Unaided field of view (FOV) covers an elliptical area that is approximately 120° lateral by 80° vertical, whereas the field of view of current Type I NVG systems is nominally 40° and is circular. Both the reduced field of view of the image and the resultant decrease in peripheral vision can increase the pilot's susceptibility to misperceptions and illusions. Proper scanning techniques must be employed to reduce the susceptibility to misperception and illusions.

3.2.1.3 Field of regard

The NVG has a limited FOV but, because it is head-mounted, that FOV can be scanned when viewing the outside scene. The total area that the FOV can be scanned is called the field of regard (FOR). The FOR will vary depending on several factors: physiological limit of head movement, NVG design (e.g., protrusion of the binocular assembly, etc.) and cockpit design issues (e.g., proximity of canopy or window, seat location, canopy bow, etc.).

3.2.1.4 NVG weight & centre of gravity

The increased weight and forward CG projection of head supported devices may have detrimental effects on pilot performance due to neck muscle strain and fatigue. There also maybe an increased risk of neck injury in crashes.

3.2.1.5 Monochromatic image

The NVG image currently appears in shades of green. Since there is only one colour, the image is said to be "monochromatic". This colour was chosen mostly because the human eye can see more detail at lower brightness levels when viewing shades of green. Colour differences between components in a scene helps one discriminate between objects and aids in object recognition, depth perception and distance estimation. The lack of colour variation in the NVG image will degrade these capabilities to varying degrees.

3.2.1.6 Ambient or artificial light

The NVG requires some degree of light (energy) in order to function. Low light levels, non-compatible aircraft lighting and poor windshield/window light transmissibility, diminish the performance capability of the NVG. It is the pilot's responsibility to determine when to transition from aided to unaided due to unacceptable NVG performance.

3.2.1.7 LED lights

Some red obstacle lights and other artificial lights that are clearly visible to the naked eye are not visible to NVGs. These obstacle lights may employ LED instead of traditional incandescent sources. The use of LED lights is becoming more common for almost all lighting applications because of their extensive lifetime and low energy consumption.

Aviation red light ranges from about 610 to 700 nanometres (nm), and NVGs approved for civil aviation (having a Class B Minus Blue Filter) are only sensitive to energy ranging from 665 to about 930 nm. LED and other artificial lights may have a relatively narrow emission band (around 630 nm \pm 20 nm) and that band is below the range in which NVGs are sensitive and LEDs do not emit infrared energy like incandescent lights for obstacle red lights.

In general terms, NVG users should be aware that obstacle lighting systems and other artificial lights that fall outside the combined visible and near-infrared spectrum of NVGs (approximately 665 to 930 nm) will not be visible to their goggles. Other obstacle lights may use a wavelength very close to the approximate cut-off wavelength of 665 nm and will remain visible to the goggles, but they will be dimmed and will be better seen with the naked eye.

Full awareness of obstacle lights can only be achieved with an unaided scan.

3.2.2 Physiological and other conditions

3.2.2.1 Cockpit resource management

Due to the inherent limitations of NVIS operations, there is a requirement to place emphasis on NVIS related cockpit resource management (CRM). This applies to both single and multi-pilot cockpit environments. Consequently, NVIS flight requires effective CRM between the pilot(s), controlling agencies and other supporting personnel. An appropriate venue for addressing this issue is the pre-flight NVIS mission brief.

3.2.2.2 Fatigue

Physiological limitations that are prevalent during the hours of darkness along with the limitations associated with NVGs, may have a significant impact on NVIS operations. Some of these limitations are the effects of fatigue (both acute and chronic), stress, eyestrain, working outside the pilot's normal circadian rhythm envelope, increased helmet weight, aggressive scanning techniques associated with NVIS, and various human factors engineering concerns that may have a direct influence on how the pilot works in the aircraft while wearing NVGs. These limitations may be mitigated through proper training and recognition, experience, adaptation, rest, risk management, and proper crew rest/duty cycles.

3.2.2.3 Over-confidence

Compared to other types of flight operations, there may be an increased tendency by the pilot to over-estimate the capabilities of the NVIS.

3.2.2.4 Spatial orientation

There are two types of vision used in maintaining spatial orientation: central (focal) vision and peripheral (ambient) vision. Focal vision requires conscious processing and is slow, whereas peripheral information is processed subconsciously at a very fast rate. During daytime, spatial orientation is maintained by inputs from both focal vision and peripheral vision, with peripheral vision providing the great majority of the information. When using NVGs, peripheral vision can be significantly degraded if not completely absent. In this case, the pilot must rely on focal vision to interpret the NVG image as well as the information from flight instruments in order to maintain spatial orientation and situation awareness. Even though maintaining spatial orientation requires more effort when using NVGs than during daytime, it is much improved over night unaided operations where the only information is obtained through flight instruments. However, anything that

degrades the NVG image to a point where the horizon is not visualised and/or ground reference is lost or significantly degraded will necessitate a reversion to flight on instruments until adequate external visual references can be established. Making this transition quickly and effectively is vital in order to avoid spatial disorientation. Additionally, added focal task loading during the operation (e.g., communications, looking at displays, processing navigational information, etc.) will compete with the focal requirement for interpreting the NVG image and flight instruments. Spatial disorientation can result when the task loading increases to a point where the outside scene and/or the flight instruments are not properly scanned. This potential can be mitigated to some extent through effective training and experience.

3.2.2.5 Depth perception & distance estimation

When flying, it is important for pilots to be able to accurately employ depth perception and distance estimation techniques. To accomplish this, pilots use both binocular and monocular vision. Binocular vision requires the use of both eyes working together, and, practically speaking, is useful only out to approximately 100 ft.

Binocular vision is particularly useful when flying close to the ground and/or near objects (e.g. landing a helicopter in a small landing zone). Monocular vision can be accomplished with either eye alone, and is the type of vision used for depth perception and distance estimation when viewing beyond approximately 100 ft. Monocular vision is the predominant type of vision used when flying fixed wing aircraft, and also when flying helicopters and using cues beyond 100 ft. When viewing an NVG image, the two eyes can no longer provide accurate binocular information, even though the NVG used when flying is a binocular system. This has to do with the way the eyes function physiologically (e.g. accommodation, stereopsis, etc.) and the design of the NVG (i.e. a binocular system with a fixed channel for each eye). Therefore, binocular depth perception and distance estimation tasking when viewing terrain or objects with an NVG within 100 ft is significantly degraded. Since monocular vision does not require both eyes working together, the adverse impact on depth perception and distance estimation is much less, and is mostly dependent on the quality of the NVG image. If the image is very good and there are objects in the scene to use for monocular cueing (especially objects with which the pilot is familiar), then distance estimation and depth perception tasking will remain accurate. However, if the image is degraded (e.g., low illumination, airborne obscurants, etc.) and/or there are few or unfamiliar objects in the scene, depth perception and distance estimation will be degraded to some extent. In summary, pilots using NVG will maintain the ability to accurately perceive depth and estimate distances, but it will depend on the distances used and the quality of the NVG image.

Pilots maintain some ability to perceive depth and distance when using NVGs by employing monocular cues. However, these capabilities may be degraded to varying degrees.

3.2.2.6 Instrument lighting brightness considerations

When viewing the NVG image, the brightness of the image will affect the amount of time it takes to adapt to the brightness level of the instrument lighting, thereby affecting the time it takes to interpret information provided by the instruments. The higher the quality (figure of merit (FOM), resolution, filters, contrast, etc.) of the 'tubes', the less critical this effect becomes.

For example, if the instrument lighting is fairly bright, the time it takes to interpret information provided by the instruments may be instantaneous. However, if the

brightness of the lighting is set to a very low level, it may take several seconds to interpret the information, thus increasing the heads-down time and increasing the risk of spatial disorientation. It is important to ensure that instrument lighting is kept at a brightness level that makes it easy to rapidly interpret the information. This will likely be brighter than the one that is used during unaided operations. If the NVGs are used in the transition phase from IFR to VFR, the brightness level of the instrument lighting should be set in advance.

3.2.2.7 Dark adaptation time from NVG to unaided operations

When viewing an NVG image, both rods and cones are being stimulated (i.e., mesopic vision), but the brightness of the image is reducing the effectiveness of rod cells. If the outside scene is bright enough (e.g., urban area, bright landing pad, etc.), both rods and cones will continue to be stimulated. In this case there will be no improvement in acuity over time and the best acuity is essentially instantaneous. In some cases (e.g., rural area with scattered cultural lights), the outside scene will not be bright enough to stimulate the cones and some amount of time will be required for the rods to fully adapt. In this case it may take the rods one to two minutes to fully adapt for the best acuity to be realised. If the outside scene is very dark (e.g., no cultural lights and no moon), it may take up to five minutes to fully adapt to the outside scene after removing the NVGs. The preceding are general guidelines and the time required to fully adapt to the outside scene once removing the NVG depends on many variables: the length of time the NVG has been used, whether or not the pilot was dark adapted prior to flight, the brightness of the outside scene, the brightness of cockpit lighting, and variability in visual function among the population. It is important to understand the concept and to note the time requirements for the given operation.

3.2.2.8 Complacency

Pilots must understand the importance of avoiding complacency during NVG flights. Similar to other specialised flight operations, complacency may lead to an acceptance of situations that would normally not be permitted. Attention span and vigilance are reduced, important elements in a task series are overlooked, and scanning patterns, which are essential for situational awareness, break down (usually due to fixation on a single instrument, object or task). Critical but routine tasks are often skipped.

3.2.2.9 Experience

High levels of NVIS proficiency, along with a well-balanced NVIS experience base, will help to offset many of the visual performance degradations associated with night operations. NVIS experience is a result of proper training coupled with numerous NVIS operations. An experienced NVIS pilot is acutely aware of the NVIS operational envelope and its correlation to various operational effects, visual illusions and performance limitations. This experience base is gained (and maintained) over time through a continual, holistic NVIS training programme that exposes the pilot to NVIS operations conducted under various moon angles, percentage of available illumination, contrast levels, visibility levels, and varying degrees of cloud coverage. A pilot should be exposed to as many of these variations as practicable during the initial NVIS qualification programme. Continued exposure during the NVIS recurrent training will help strengthen and solidify this experience base.

4. OPERATIONS

Operations procedures should accommodate the capabilities and limitations of the systems described in Section 3 of this GM as well as the restraints of the operational environment.

All NVG operations should fulfil all applicable requirements in accordance with Regulation (EC) No 216/2008.

4.1 Pilot eligibility

About 54% of the civil pilot population wears some sort of ophthalmic device to correct vision necessary to safely operate an aircraft. The use of inappropriate ophthalmic devices with NVGs may result in vision performance decrement, fatigue, and other human factor problems, which could result in increased risk for aviation accidents and incidents.

4.2 Operating environment considerations

4.2.1 Weather and atmospheric obscurants

Any atmospheric condition, which absorbs, scatters, or refracts illumination, either before or after it strikes terrain, may reduce the usable energy available to the NVG.

4.2.1.1 Weather

During NVIS operations, pilots can see areas of moisture that are dense (e.g., clouds, thick fog, etc.) but may not see areas that are less dense (e.g., thin fog, light rain showers, etc.). The inability to see some areas of moisture may lead to hazardous flight conditions during NVIS operations and will be discussed separately in the next section.

The different types of moisture will have varying effects and it is important to understand these effects and how they apply to NVIS operations. For example:

1. It is important to know when and where fog may form in the flying area. Typically, coastal, low-lying river, and mountainous areas are most susceptible.
2. Light rain or mist may not be observed with NVIS but will affect contrast, distance estimation, and depth perception. Heavy rain is more easily perceived due to large droplet size and energy attenuation.
3. Snow occurs in a wide range of particle sizes, shapes, and densities. As with clouds, rain, and fog, the denser the airborne snow, the greater the effect on NVG performance. On the ground, snow has mixed effect depending on terrain type and the illumination level. In mountainous terrain, snow may add contrast, especially if trees and rocks protrude through the snow. In flatter terrain, snow may cover high contrast areas, reducing them to areas of low contrast. On low illumination nights, snow may reflect the available energy better than the terrain it covers and thus increase the level of illumination.

All atmospheric conditions reduce the illumination level to some degree and recognition of this reduction with NVGs can be difficult. Thus, a good weather briefing, familiarity with the local weather patterns and understanding the effects on NVG performance are important for a successful NVIS flight.

4.2.1.2 Deteriorating weather

It is important to remain cognizant of changes in the weather when using NVGs. It is possible to “see through” areas of light moisture when using NVGs, thus increasing the risk of inadvertently entering IMC. Some ways to help reduce this possibility include the following:

1. Be attentive to changes in the NVG image. Halos may become larger and more diffuse due to diffraction of light in moisture. Scintillation in the image may increase due to a lowering of the illumination level caused by the increased atmospheric moisture. Loss of scene detail may be secondary to the lowering illumination caused by the changing moisture conditions.
2. Obtain a thorough weather brief with emphasis on NVG effects prior to flight.
3. Be familiar with weather patterns in the flying area.
4. Occasionally scan the outside scene. The unaided eye may detect weather conditions that are not detectable to the NVG.

Despite the many methods of inadvertent instrument meteorological conditions (IMC) prevention, one should have established IMC recovery procedures and be familiar with them.

4.2.1.3 Airborne obscurants

In addition to weather, there may be other obscurants in the atmosphere that could block energy from reaching the NVG, such as haze, dust, sand, or smoke. As with moisture, the size and concentration of the particles will determine the degree of impact. Examples of these effects include the following:

1. high winds during the day can place a lot of dust in the air that will still be present at night when the wind may have reduced in intensity;
2. forest fires produce heavy volumes of smoke that may cover areas well away from the fire itself;
3. the effects of rotor wash may be more pronounced when using NVGs depending on the material (e.g. sand, snow, dust, etc.); and
4. pollution in and around major cultural areas may have an adverse effect on NVG performance.

4.2.1.4 Winter operations

Using NVGs during winter conditions provide unique issues and challenges to pilots.

4.2.1.4.1 Snow

Due to the reflective nature of snow, it presents pilots with significant visual challenges both en-route and in the terminal area. During the en-route phase of a flight the snow may cause distractions to the flying pilot if any aircraft external lights (e.g., anti-collision beacons/strobes, position lights, landing lights, etc.) are not compatible with NVGs. In the terminal area, whiteout landings can create the greatest hazard to unaided night operations. With NVGs the hazard is not lessened, and can be more disorienting due to lights reflecting from the snow that is swirling around the aircraft during the landing phase. Any emergency vehicle lighting or other airport lighting in the terminal area may exaggerate the effects.

4.2.1.4.2 Ice fog

Ice fog presents the pilot with hazards normally associated with IMC in addition to problems associated with snow operations. The highly reflective nature of ice fog will further aggravate any lighting problems. Ice fog conditions can be generated by aircraft operations under extremely cold temperatures and the right environmental conditions.

4.2.1.4.3 Icing

Airframe ice is difficult to detect while looking through NVGs. The pilot will need to develop a proper crosscheck to ensure airframe icing does not exceed operating limits for that aircraft. Pilots should already be aware of icing indicator points on their aircraft. These areas require consistent oversight to properly determine environmental conditions.

4.2.1.4.4 Low ambient temperatures

Depending on the cockpit heating system, fogging of the NVGs can be a problem and this will significantly reduce the goggle effectiveness. Another issue with cockpit temperatures is the reduced battery duration. Operations in a cold environment may require additional battery resources.

4.2.2 Illumination

NVGs require illumination, either natural or artificial, to produce an image. Although current NVG technology has significantly improved low light level performance, some illumination, whether natural or artificial, is still required to provide the best possible image.

4.2.2.1 Natural illumination

The main sources of natural illumination include the moon and stars. Other sources can include sky glow, the aurora borealis, and ionisation processes that take place in the upper atmosphere.

4.2.2.1.1 Moon phase

The moon provides the greatest source of natural illumination during night time. Moon phase and elevation determines how much moonlight will be available, while moonrise and moonset times determine when it will be available. Lunar illumination is reported in terms of percent illumination, 100% illumination being full moon. It should be noted that this is different from the moon phase (e.g., 25% illumination does not mean the same thing as a quarter moon). Currently, percent lunar illumination can only be obtained from sources on the Internet, military weather facilities and some publications (e.g. Farmers Almanac).

4.2.2.1.2 Lunar azimuth and elevation

The moon can have a detrimental effect on night operations depending on its relationship to the flight path. When the moon is on the same azimuth as the flight path, and low enough to be within or near the NVG field of view, the effect on NVG performance will be similar to that caused by the sun on the unaided eye during daytime. The brightness of the moon drives the NVG gain down, thus reducing image detail. This can also occur with the moon at relatively high elevations. For example, it is possible to bring the moon near the NVG field of view when climbing to cross a ridgeline or other obstacle, even when the moon is at a relatively high elevation. It is important to consider lunar azimuth and elevation during pre-flight planning. Shadowing, another effect of lunar azimuth and elevation, will be discussed separately.

4.2.2.1.3 Shadowing

Moonlight creates shadows during night time just as sunlight creates shadows during daytime. However, night time shadows contain very little energy for the NVG to use in forming an image. Consequently, image quality within a shadow will

be degraded relative to that obtained outside the shadowed area. Shadows can be beneficial or can be a disadvantage to operations depending on the situation.

4.2.2.1.3.1 Benefits of shadows

Shadows alert aircrew to subtle terrain features that may not otherwise be noted due to the reduced resolution in the NVG image. This may be particularly important in areas where there is little contrast differentiation; such as flat featureless deserts, where large dry washes and high sand dunes may go unnoticed if there is no contrast to note their presence. The contrast provided by shadows helps make the NVG scene appear more natural.

4.2.2.1.3.2 Disadvantages due to shadows

When within a shadow, terrain detail can be significantly degraded, and objects can be regarding flight in or around shadowed areas is the pilot's response to loss of terrain detail. During flight under good illumination conditions, a pilot expects to see a certain level of detail. If flight into a shadow occurs while the pilot is preoccupied with other matters (e.g., communication, radar, etc.), it is possible that the loss in terrain detail may not have been immediately noted. Once looking outside again, the pilot may think the reduced detail is due to an increase in flight altitude and thus begin a descent - even though already at a low altitude. Consideration should be given during mission planning to such factors as lunar azimuth and elevation, terrain type (e.g., mountainous, flat, etc.), and the location of items significant to operation success (e.g., ridgelines, pylons, targets, waypoints, etc.). Consideration of these factors will help predict the location of shadows and the potential adverse effects.

4.2.2.1.4 Sky glow

Sky glow is an effect caused by solar light and continues until the sun is approximately 18 degrees below the horizon. When viewing in the direction of sky glow there may be enough energy present to adversely affect the NVG image (i.e., reduce image quality). For the middle latitudes the effect on NVG performance may last up to an hour after official sunset. For more northern and southern latitudes the effect may last for extended periods of times (e.g., days to weeks) during seasons when the sun does not travel far below the horizon. This is an important point to remember if planning NVG operations in those areas. Unlike sky glow after sunset, the sky glow associated with sunrise does not have an obvious effect on NVG performance until fairly close to official sunrise. The difference has to do with the length of time the atmosphere is exposed to the sun's irradiation, which causes ionisation processes that release near-IR energy. It is important to know the difference in these effects for planning purposes.

4.2.2.2 Artificial illumination

Since NVGs are sensitive to any source of energy in the visible and near-infrared spectrums, there are also many types of artificial illumination sources (e.g. flares, IR searchlights, cultural lighting, etc.). As with any illumination source, these can have both positive and detrimental effects on NVG utilisation. For example, viewing a scene indirectly illuminated by a searchlight can enable the pilot to more clearly view the scene; conversely, viewing the same scene with the searchlight near or within the NVG field of view will reduce the available visual cues. It is important to be familiar with the effects of

cultural lighting in the flying area in order to be able to avoid the associated problems and to be able to use the advantages provided. Also, it is important to know how to properly use artificial light sources (e.g. aircraft IR spotlight). It should be noted that artificial light sources may not always be available or dependable, and this should be taken into consideration during flight planning.

When using NVGs in an area with high-intensity cultural lighting, the lights beyond this area may not be visible. The visibility assessed with the NVGs might be judged to be worse than the unaided visibility.

4.2.3 Terrain contrast

Contrast is one of the more important influences on the ability to correctly interpret the NVG image, particularly in areas where there are few cultural features. Any terrain that contains varying albedos (e.g., forests, cultivated fields, etc.) will likely increase the level of contrast in a NVG image, thus enhancing detail. The more detail in the image, the more visual information aircrews have for manoeuvring and navigating. Low contrast terrain (e.g., flat featureless desert, snow-covered fields, water, etc.) contains few albedo variations, thus the NVG image will contain fewer levels of contrast and less detail.

4.3 Aircraft considerations

4.3.1 Lighting

Factors such as aircraft internal and external lighting have the potential to adversely impact NVG gain and thus image quality. How well the windshield, canopy, or window panels transmit near infrared energy can also affect the image. Cleanliness of the windshield directly impacts this issue.

4.3.2 Cockpit ergonomics

While wearing NVGs, the pilot may have limited range of head movement in the aircraft. For example, switches on the overhead console may be difficult to read while wearing NVGs. Instruments, controls, and switches that are ordinarily accessible, may now be more difficult to access due to the extended mass (fore/aft) associated with NVGs.

In addition, scanning may require a more concentrated effort due to limited field of view. Lateral viewing motion can be hindered by cockpit obstructions (i.e. door post or seat back design).

4.3.3 Windshield reflectivity

Consideration within the cockpit and cabin should be given to the reflectivity of materials and equipment upon the windshield. Light that is reflected may interfere with a clear and unobstructed view. Items such as flight suits, helmets, and charts, if of a light colour such as white, yellow, and orange, can produce significant reflections. Colours that impart the least reflection are black, purple, and blue. This phenomenon is not limited to windshields but may include side windows, chin bubbles, canopies, etc.

4.4 Generic operating considerations

This section lists operating topics and procedures, which should be considered when employing NVIS. The list and associated comments are not to be considered all inclusive. NVIS operations vary in scope widely and this section is not intended to instruct a prospective operator on how to implement an NVIS programme.

4.4.1 Normal procedures

4.4.1.1 Scanning

When using NVGs there are three different scan patterns to consider and each is used for different reasons: instrument scan, aided scan outside, and unaided scan outside. Normally, all three are integrated and there is a continuous transition from one to the other depending on the mission, environmental conditions, immediate tasking, flight altitude and many other variables. For example, scanning with the NVG will allow early detection of external lights. However, the bloom caused by the lights will mask the aircraft until fairly close or until the lighting scheme is changed. Once close to the aircraft (e.g., approximately one-half mile for smaller aircraft), visual acquisition can possibly be made unaided or with the NVG. Whether to use the NVG or unaided vision depends on many variables (e.g., external lighting configuration, distance to aircraft, size of aircraft, environmental conditions, etc.). The points to be made are that a proper scan depends on the situation and variables present, and that scanning outside is critical when close to another aircraft. Additionally, for a multi-crew environment, coordination of scan responsibilities is vital.

4.4.1.1.1 Instrument crosscheck scan

In order to effect a proper and effective instrument scan, it is important to predict when it will be important. A start can be made during pre-flight planning when critical phases of flight can be identified and prepared for. For example, it may be possible when flying over water or featureless terrain to employ a good instrument crosscheck. However, the most important task is to make the appropriate decision during flight as conditions and events change. In this case, experience, training and constant attention to the situation are vital contributors to the pilot's assessment of the situation.

4.4.1.1.2 NVG scan

To counteract the limited field of view, pilots should continually scan throughout the field of regard. This allows aircrew to build a mental image of the surrounding environment. How quickly the outside scene is scanned to update the mental image is determined by many variables. For example, when flying over flat terrain where the highest obstacle is below the flight path, the scan may be fairly slow. However, if flying low altitude in mountainous terrain, the scan will be more aggressive and rapid due to the presence of more information and the increased risk. How much of the field of regard to scan is also determined by many variables. For example, if a pilot is anticipating a turn, more attention may be placed in the area around the turn point, or in the direction of the new heading. In this situation, the scan will be limited briefly to only a portion of the field of regard.

As with the instrument scan, it is very important to plan ahead. It may, for example, be possible to determine when the scan may be interrupted due to other tasks, when it may be possible to become fixated on a specific task, or when it is important to maximise the outside scan. An important lesson to learn regarding the NVG scan is when not to rely on visual information. It is easy to overestimate how well one can see with NVGs, especially on high illumination nights, and it is vital to maintain a constant awareness regarding their limitations. This should be pointed out often during training and, as a reminder, should be included as a briefing item for NVG flights.

4.4.1.1.3 Unaided scan

Under certain conditions, this scan can be as important as the others can. For example, it may be possible to detect distance and/or closure to another aircraft more easily using unaided vision, especially if the halo caused by the external lights masks aircraft details on the NVG image. Additionally, there are other times when unaided information can be used in lieu of or can augment NVG and instrument information.

When using the NVGs in the transition from IFR to VFR, the unaided scan is essential to assess the unaided visibility conditions. Focusing on the first light seen when looking out is an automatic response, but it is vital to continue the scan in order to assess the surrounding weather conditions.

Some examples where unaided scan can enhance safety is where LED-lit obstacles can be encountered (e.g. during low-altitude flying and when performing a reconnaissance of landing areas) or when unmanned aircraft systems (UASs) fly at night with LED navigation lights.

Air operators should incorporate procedures into their manuals and/or SOPs that require periodic unaided scanning when operating at low altitudes, when looking for potential landing areas, and when performing a reconnaissance of a landing area. This may be accomplished by looking under the NVGs, or by briefly placing the NVGs in the stowed (flipped-up) position. Manuals/SOPs should include procedures and call-outs for LED-lit obstacles.

Air operators and pilots are encouraged to report encounters with obstacles equipped with LED lighting systems not visible by NVGs, with pertinent information, to their competent authority.

4.4.1.1.4 Scan patterns

Environmental factors will influence scan by limiting what may be seen in specific directions or by degrading the overall image. If the image is degraded, aircrew may scan more aggressively in a subconscious attempt to obtain more information, or to avoid the chance of missing information that suddenly appears and/or disappears. The operation itself may influence the scan pattern. For example, looking for another aircraft, landing zone, or airport may require focusing the scan in a particular direction. In some cases, the operation may require aircrew in a multi place aircraft to assign particular pilots responsibility for scanning specific sectors.

The restrictions to scan and the variables affecting the scan pattern are not specific to night operations or the use of NVGs, but, due to the NVG's limited field of view, the degree of impact is magnified.

4.4.1.2 Pre-flight planning

4.4.1.2.1 Illumination criteria

The pilot should provide a means for forecasting the illumination levels in the operational area. The pilot should make the effort to request at least the following information in addition to that normally requested for night VFR: cloud cover and visibility during all phases of flight, sunset, civil and nautical twilight, moon phase, moonrise and moonset, and moon and/or lux illumination levels, and unlit tower NOTAMS.

4.4.1.2.2 NVIS operations

An inspection of the power pack, visor, mount, power cable and the binocular assembly should be performed in accordance with the operations manual.

To ensure maximum performance of the NVGs, proper alignment and focus must be accomplished following the equipment inspection. Improper alignment and focus may degrade NVIS performance.

4.4.1.2.3 Aircraft pre-flight

A normal pre-flight inspection should be conducted prior to an NVIS flight with emphasis on proper operation of the NVIS lighting. The aircraft windshield must also be clean and free of major defects, which might degrade NVIS performance.

4.4.1.2.4 Equipment

The basic equipment required for NVIS operations should be those instruments and equipment specified within the current applicable regulations for VFR night operations. Additional equipment required for NVIS operations, e.g. NVIS lighting system and a radio altimeter must be installed and operational. All NVIS equipment, including any subsequent modifications, shall be approved.

4.4.1.2.5 Risk assessment

A risk assessment is suggested prior to any NVIS operation. The risk assessment should include as a minimum:

1. illumination level
2. weather
3. pilot recency of experience
4. pilot experience with NVG operations
5. pilot vision
6. pilot rest condition and health
7. windshield/window condition
8. NVG tube performance
9. NVG battery condition
10. types of operations allowed
11. external lighting environment.

4.4.1.3 Flight operations

4.4.1.3.1 Elevated terrain

Safety may be enhanced by NVGs during operations near elevated terrain at night. The obscuration of elevated terrain is more easily detected with NVGs thereby allowing the pilot to make alternate flight path decisions.

4.4.1.3.2 Over-water

Flying over large bodies of water with NVGs is difficult because of the lack of contrast in terrain features. Reflections of the moon or starlight may cause

disorientation with the natural horizon. The radio altimeter must be used as a reference to maintain altitude.

4.4.1.4 Remote area considerations

A remote area is a site that does not qualify as an aerodrome as defined by the applicable regulations. Remote area landing sites do not have the same features as an aerodrome, so extra care must be given to locating any obstacles that may be in the approach/departure path.

A reconnaissance must be made prior to descending at an unlighted remote site. Some features or objects may be easy to detect and interpret with the unaided eye. Other objects will be invisible to the unaided eye, yet easily detected and evaluated with NVGs.

4.4.1.5 Reconnaissance

The reconnaissance phase should involve the coordinated use of NVGs and white lights. The aircraft's external white lights such as landing lights, searchlights, and floodlights, should be used during this phase of flight. The pilot should select and evaluate approach and departure paths to the site considering wind speed and direction, and obstacles or signs of obstacles.

4.4.1.6 Sources of high illumination

Sources of direct high illumination may have the potential to reduce the effectiveness of the NVGs. In addition, certain colour lights, such as red, will appear brighter, closer and may display large halos.

4.4.2 Emergency procedures

No modification for NVG operations is necessary to the aircraft emergency procedures as approved in the operations manual or approved checklist. Special training may be required to accomplish the appropriate procedures.

4.4.3 Inadvertent IMC

Some ways to help reduce the potential for inadvertent flight into IMC conditions are:

1. obtaining a thorough weather brief (including pilot reports);
2. being familiar with weather patterns in the local flying area; and
3. by looking beneath the NVG at the outside scene.

However, even with thorough planning a risk still exists. To help mitigate this risk it is important to know how to recognise subtle changes to the NVG image that occur during entry into IMC conditions. Some of these include the onset of scintillation, loss of scene detail, and changes in the appearance of halos.

5. TRAINING

To provide an appropriate level of safety, training procedures must accommodate the capabilities and limitations of the systems described in Section 3 of this GM as well as the restraints of the operational environment.

To be effective, the NVIS training philosophy would be based on a two-tiered approach: basic and advanced NVIS training. The basic NVIS training would serve as the baseline standard for all individuals seeking an NVIS endorsement. The content of this initial training would not be dependent on any operational requirements. The advanced training would build on the basic training by focusing on developing specialised skills required to operate an aircraft during NVIS operations in a particular

operational environment. Furthermore, while there is a need to stipulate minimum flight hour requirements for an NVIS endorsement, the training must also be event based. This necessitates that pilots be exposed to all of the relevant aspects, or events, of NVIS flight in addition to acquiring a minimum number of flight hours.

6. CONTINUING AIRWORTHINESS

The reliability of the NVIS and safety of operations are dependent on the pilots adhering to the instructions for continuing airworthiness. Personnel who conduct the maintenance and inspection on the NVIS must be qualified and possess the appropriate tools and facilities to perform the maintenance.

Acronyms used in this GM

AC	Advisory Circular
AGL	above ground level
ATC	air traffic control
CONOPs	concept of operations
CG	centre of gravity
CRM	cockpit resource management
DOD	Department of Defence
DOT	Department of Transportation
EFIS	electronic flight instrumentation systems
EMS	emergency medical service
FAA	Federal Aviation Administration
FLIR	forward looking infrared radar
FOR	field of regard
FOV	field of view
GEN	generation
HUD	head-up display
IFR	instrument flight rules
IMC	instrument meteorological conditions
IR	infrared
JAA	Joint Aviation Authorities
MOPS	Minimum Operational Performance Standard
NAS	national airspace system
NOTAMS	Notices to Airmen
NVD	night vision device
NVED	night vision enhancement device
NVG	night vision goggles

NVIS	night vision imaging system
SC	special committee
TFR	temporary flight restrictions
VA	visual acuity
VFR	visual flight rules
VMC	visual meteorological conditions

Glossary of terms used in this GM

1. 'Absorptance': the ratio of the radiant energy absorbed by a body to that incident upon it.
2. 'Albedo': the ratio of the amount of light reflected from a surface to the amount of incident light.
3. 'Automatic brightness control (ABC)': one of the automatic gain control circuits found in second and third generation NVG devices. It attempts to provide consistent image output brightness by automatic control of the micro channel plate voltage.
4. 'Automatic gain control (AGC)': comprised of the automatic brightness control and bright source protection circuits. Is designed to maintain image brightness and protect the user and the image tube from excessive light levels. This is accomplished by controlling the gain of the intensifier tube.
5. 'Blackbody': an ideal body of surface that completely absorbs all radiant energy falling upon with no reflection.
6. 'Blooming': common term used to denote the "washing out" of all or part of the NVG image due to de-gaining of the image intensifier tube when a bright light source is in or near the NVG field of view.
7. 'Bright source protection (BSP)': protective feature associated with second and third generation NVGs that protects the intensifier tube and the user by controlling the voltage at the photo cathode.
8. 'Brownout': condition created by blowing sand, dust, etc., which can cause the pilots to lose sight of the ground. This is most commonly associated with landings in the desert or in dusty LZs.
9. 'Civil nautical twilight': the time when the true altitude of the centre of the sun is six degrees below the horizon. Illuminance level is approximately 3.40 lux and is above the usable level for NVG operations.
10. 'Diopter': a measure of the refractive (light bending) power of a lens.
11. 'Electro-optics (EO)': the term used to describe the interaction between optics and electronics, leading to transformation of electrical energy into light or vice versa.
12. 'Electroluminescent (EL)': referring to light emission that occurs from application of an alternating current to a layer of phosphor.
13. 'Foot-candle': a measure of illuminance; specifically, the illuminance of a surface upon which one lumen is falling per square foot.
14. 'Foot-Lambert': a measure of luminance; specifically the luminance of a surface that is receiving an illuminance of one foot-candle.

15. 'Gain': when referring to an image intensification tube, the ratio of the brightness of the output in units of foot-lambert, compared to the illumination of the input in foot-candles. A typical value for a GEN III tube is 25,000 to 30,000 FI/fc. A "tube gain" of 30,000 FI/fc provides an approximate "system gain" of 3,000. This means that the intensified NVG image is 3,000 times brighter to the aided eye than that of the unaided eye.
16. 'Illuminance': also referred to as illumination. The amount, ratio or density of light that strikes a surface at any given point.
17. 'Image intensifier': an electro-optic device used to detect and intensify optical images in the visible and near infrared region of the electromagnetic spectrum for the purpose of providing visible images. The component that actually performs the intensification process in a NVG. This component is composed of the photo cathode, MCP, screen optic, and power supply. It does not include the objective and eyepiece lenses.
18. 'Incandescent': refers to a source that emits light based on thermal excitation, i.e., heating by an electrical current, resulting in a very broad spectrum of energy that is dependent primarily on the temperature of the filament.
19. 'Infrared': that portion of the electromagnetic spectrum in which wavelengths range from 0.7 microns to 1 mm. This segment is further divided into near infrared (0.7-3.0 microns), mid infrared (3.0-6.0 microns), far infrared (6.0-15 microns), and extreme infrared (15 microns-1 mm). A NVG is sensitive to near infrared wavelengths approaching 0.9 microns.
20. 'Irradiance': the radiant flux density incident on a surface. For the purpose of this document the terms irradiance and illuminance shall be interchangeable.
21. 'Lumen': a measurement of luminous flux equal to the light emitted in a unit solid angle by a uniform point source of one candle intensity.
22. 'Luminance': the luminous intensity (reflected light) of a surface in a given direction per unit of projected area. This is the energy used by NVGs.
23. 'Lux': a unit measurement of illumination. The illuminance produced on a surface that is one-meter square, from a uniform point source of one candle intensity, or one lumen per square meter.
24. 'Microchannel plate': a wafer containing between 3 and 6 million specially treated microscopic glass tubes designed to multiply electrons passing from the photo cathode to the phosphor screen in second and third generation intensifier tubes.
25. 'Micron': a unit of measure commonly used to express wavelength in the infrared region; equal to one millionth of a meter.
26. 'Nanometer (nm)': a unit of measure commonly used to express wavelength in the visible and near infrared region; equal to one billionth of a meter.
27. 'Night vision device (NVD)': an electro-optical device used to provide a visible image using the electromagnetic energy available at night.
28. 'Photon': a quantum (basic unit) of radiant energy (light).
29. 'Photopic vision': vision produced as a result of the response of the cones in the retina as the eye achieves a light adapted state (commonly referred to as day vision).
30. 'Radiance': the flux density of radiant energy reflected from a surface. For the purposes of this manual the terms radiance and luminance shall be interchangeable.
31. 'Reflectivity': the fraction of energy reflected from a surface.

32. 'Scotopic vision': that vision produced as a result of the response of the rods in the retina as the eye achieves a dark-adapted state (commonly referred to as night vision).
33. 'Situational awareness (SA)': degree of perceptual accuracy achieved in the comprehension of all factors affecting an aircraft and crew at a given time.
34. 'Starlight': the illuminance provided by the available (observable) stars in a subject hemisphere. The stars provide approximately 0.00022 lux ground illuminance on a clear night. This illuminance is equivalent to about one-quarter of the actual light from the night sky with no moon.
35. 'Stereopsis': visual system binocular cues that are used for distance estimation and depth perception. Three dimensional visual perception of objects. The use of NVGs seriously degrades this aspect of near-depth perception.
36. 'Transmittance': the fraction of radiant energy that is transmitted through a layer of absorbing material placed in its path.
37. 'Ultraviolet': that portion of the electromagnetic spectrum in which wavelengths range between 0.1 and 0.4 microns.
38. 'Wavelength': the distance in the line of advance of a wave from any one point to the next point of corresponding phase; is used to express electromagnetic energy including IR and visible light.
39. 'Whiteout': a condition similar to brownout but caused by blowing snow.

References

1. Air Force Manual 11-217 Volume 2, Chapter 3, *Night Vision Devices*, August 6, 1998.
2. Department of Army, Training Circular 1-204, *Night Flight: Techniques and Procedures*, 1988.
3. DOT/FAA, Report no DOT/FAA/RD-94/21– Night Vision Goggles in Emergency Medical Services (EMS) Helicopters, March 1994.
4. FAA, Guide for Aviation Medical Examiners, November 1996.
5. FAA, Notice for Proposed Rulemaking Statement- Night Vision Goggles, Draft, September 7, 1999.
6. FAA Handbook 8083-21, *Rotorcraft Flying Handbook*, 2000.
7. FAA Operation Specification, Rocky Mountain Helicopters Night Vision Goggle Operations, February 4, 1999.
8. FAA Supplemental Type Certificate Number SR09208RC, Rocky Mountain Holdings, BO-105, January 19, 1999.
9. FAA, *Aeronautical Information Manual (AIM)*, February 24, 2000.
10. ITT Industries, Operator's Manual-Image Intensifier Set, Night Vision AV4949UL, June 21, 1999.
11. RTCA, Inc. – *Basic Document Style Guide*, July 1999.
12. JAA, JAR-OPS *Night Vision Goggle Operations*, Draft, 1999.
13. Mobility Air Forces, Concept of Operations-Aircrew Night Vision Goggles, September 8, 1998.
14. Perfetto, Nicholas J., Embry-Riddle Aeronautical University, The Feasibility of Metropolitan Police Department Helicopter Pilots Using Night Vision Goggles, May 2000.

15. Simpson, Carol Dr., William, Doug., Gardner, Donald., Haworth, Loran., Analysis of Response to Survey of Issues in the Application of Night Vision Goggles to Civil Rotorcraft Flight Operations, Draft, July 12, 1999.
16. United States Marine Corps, Marine Aviation Weapons and Tactics Squadron One, *Helicopter Night Vision Device Manual*, Summer 1995.

SUBPART I: HELICOPTER HOIST OPERATIONS

SPA.HHO.100 Helicopter hoist operations (HHO)

Regulation (EU) No 965/2012

- (a) Helicopters shall only be operated for the purpose of CAT hoist operations if the operator has been approved by the competent authority.
- (b) To obtain such approval by the competent authority, the operator shall:
 - (1) operate in CAT and hold a CAT AOC in accordance with Annex III (Part-ORO);
 - (2) demonstrate to the competent authority compliance with the requirements contained in this Subpart.

SPA.HHO.110 Equipment requirements for HHO

Regulation (EU) 2019/1384

- (a) The installation of all helicopter hoist equipment other than a simple PCDS, including any radio equipment to comply with point [SPA.HHO.115](#), and any subsequent modifications, shall have an airworthiness approval appropriate to the intended function. Ancillary equipment shall be designed and tested to the appropriate standard as required by the competent authority.
- (b) Maintenance instructions for HHO equipment and systems shall be established by the operator in liaison with the manufacturer and included in the operator's helicopter maintenance programme as provided for by Regulation (EU) No 1321/2014.

AMC1 SPA.HHO.110(a) Equipment requirements for HHO

ED Decision 2012/019/R

AIRWORTHINESS APPROVAL FOR HUMAN EXTERNAL CARGO

- (a) Hoist installations that have been certificated according to any of the following standards should be considered to satisfy the airworthiness criteria for human external cargo (HEC) operations:
 - (1) CS 27.865 or CS 29.865;
 - (2) JAR 27 Amendment 2 (27.865) or JAR 29 Amendment 2 (29.865) or later;
 - (3) FAR 27 Amendment 36 (27.865) or later - including compliance with CS 27.865(c)(6); or
 - (4) FAR 29 Amendment 43 (29.865) or later.
- (b) Hoist installations that have been certified prior to the issuance of the airworthiness criteria for HEC as defined in (a) may be considered as eligible for HHO provided that following a risk assessment either:
 - (1) the service history of the hoist installation is found satisfactory to the competent authority; or
 - (2) for hoist installations with an unsatisfactory service history, additional substantiation to allow acceptance by the competent authority should be provided by the hoist installation certificate holder (type certificate (TC) or supplemental type certificate (STC)) on the basis of the following requirements:

- (i) The hoist installation should withstand a force equal to a limit static load factor of 3.5, or some lower load factor, not less than 2.5, demonstrated to be the maximum load factor expected during hoist operations, multiplied by the maximum authorised external load.
- (ii) The reliability of the primary and back-up quick release systems at helicopter level should be established and failure mode and effect analysis at equipment level should be available. The assessment of the design of the primary and back-up quick release systems should consider any failure that could be induced by a failure mode of any other electrical or mechanical rotorcraft system.
- (iii) The operations or flight manual contains one-engine-inoperative (OEI) hover performance data and procedures for the weights, altitudes, and temperatures throughout the flight envelope for which hoist operations are accepted.
- (iv) Information concerning the inspection intervals and retirement life of the hoist cable should be provided in the instructions for continued airworthiness.
- (v) Any airworthiness issue reported from incidents or accidents and not addressed by (i), (ii), (iii) and (iv) should be addressed.

SPA.HHO.115 HHO communication

Regulation (EU) No 965/2012

Two-way radio communication shall be established with the organisation for which the HHO is being provided and, where possible, a means of communicating with ground personnel at the HHO site for:

- (a) day and night offshore operations;
- (b) night onshore operations, except for HHO at a helicopter emergency medical services (HEMS) operating site.

SPA.HHO.125 Performance requirements for HHO

Regulation (EU) No 965/2012

Except for HHO at a HEMS operating site, HHO shall be capable of sustaining a critical engine failure with the remaining engine(s) at the appropriate power setting without hazard to the suspended person(s)/cargo, third parties or property.

SPA.HHO.130 Crew requirements for HHO

Regulation (EU) No 965/2012

- (a) *Selection.* The operator shall establish criteria for the selection of flight crew members for the HHO task, taking previous experience into account.
- (b) *Experience.* The minimum experience level for the commander conducting HHO flights shall not be less than:
 - (1) Offshore:
 - (i) 1000 hours as pilot-in-command/commander of helicopters, or 1000 hours as co-pilot in HHO of which 200 hours is as pilot-in-command under supervision; and
 - (ii) 50 hoist cycles conducted offshore, of which 20 cycles shall be at night if night operations are being conducted, where a hoist cycle means one down-and-up cycle of the hoist hook.

- (2) Onshore:
- (i) 500 hours as pilot-in-command/commander of helicopters, or 500 hours as co-pilot in HHO of which 100 hours is as pilot-in-command under supervision;
 - (ii) 200 hours operating experience in helicopters gained in an operational environment similar to the intended operation; and
 - (iii) 50 hoist cycles, of which 20 cycles shall be at night if night operations are being conducted.
- (c) *Operational training and experience.* Successful completion of training in accordance with the HHO procedures contained in the operations manual and relevant experience in the role and environment under which HHO are conducted.
- (d) *Recency.* All pilots and HHO crew members conducting HHO shall have completed in the last 90 days:
- (1) when operating by day: any combination of three day or night hoist cycles, each of which shall include a transition to and from the hover;
 - (2) when operating by night: three night hoist cycles, each of which shall include a transition to and from the hover.
- (e) *Crew composition.* The minimum crew for day or night operations shall be as stated in the operations manual. The minimum crew will be dependent on the type of helicopter, the weather conditions, the type of task, and, in addition for offshore operations, the HHO site environment, the sea state and the movement of the vessel. In no case shall the minimum crew be less than one pilot and one HHO crew member.
- (f) Training and checking
- (1) Training and checking shall be conducted in accordance with a detailed syllabus approved by the competent authority and included in the operations manual.
 - (2) Crew members:
 - (i) Crew training programmes shall: improve knowledge of the HHO working environment and equipment; improve crew coordination; and include measures to minimise the risks associated with HHO normal and emergency procedures and static discharge.
 - (ii) The measures referred to in (f)(2)(i) shall be assessed during visual meteorological conditions (VMC) day proficiency checks, or VMC night proficiency checks when night HHO are undertaken by the operator.

AMC1 SPA.HHO.130(b)(2)(ii) Crew requirements for HHO

ED Decision 2012/019/R

RELEVANT EXPERIENCE

The experience considered should take into account the geographical characteristics (sea, mountain, big cities with heavy traffic, etc.).

AMC1 SPA.HHO.130(e) Crew requirements for HHO

ED Decision 2012/019/R

CRITERIA FOR TWO PILOT HHO

A crew of two pilots should be used when:

- (a) the weather conditions are below VFR minima at the offshore vessel or structure;
- (b) there are adverse weather conditions at the HHO site (i.e. turbulence, vessel movement, visibility); and
- (c) the type of helicopter requires a second pilot to be carried because of:
 - (1) cockpit visibility;
 - (2) handling characteristics; or
 - (3) lack of automatic flight control systems.

AMC1 SPA.HHO.130(f)(1) Crew requirements for HHO

ED Decision 2012/019/R

TRAINING AND CHECKING SYLLABUS

- (a) The flight crew training syllabus should include the following items:
 - (1) fitting and use of the hoist;
 - (2) preparing the helicopter and hoist equipment for HHO;
 - (3) normal and emergency hoist procedures by day and, when required, by night;
 - (4) crew coordination concepts specific to HHO;
 - (5) practice of HHO procedures; and
 - (6) the dangers of static electricity discharge.
- (b) The flight crew checking syllabus should include:
 - (1) proficiency checks, which should include procedures likely to be used at HHO sites with special emphasis on:
 - (i) local area meteorology;
 - (ii) HHO flight planning;
 - (iii) HHO departures;
 - (iv) a transition to and from the hover at the HHO site;
 - (v) normal and simulated emergency HHO procedures; and
 - (vi) crew coordination.
- (c) HHO technical crew members should be trained and checked in the following items:
 - (1) duties in the HHO role;
 - (2) fitting and use of the hoist;
 - (3) operation of hoist equipment;
 - (4) preparing the helicopter and specialist equipment for HHO;

- (5) normal and emergency procedures;
- (6) crew coordination concepts specific to HHO;
- (7) operation of inter-communication and radio equipment;
- (8) knowledge of emergency hoist equipment;
- (9) techniques for handling HHO passengers;
- (10) effect of the movement of personnel on the centre of gravity and mass during HHO;
- (11) effect of the movement of personnel on performance during normal and emergency flight conditions;
- (12) techniques for guiding pilots over HHO sites;
- (13) awareness of specific dangers relating to the operating environment; and
- (14) the dangers of static electricity discharge.

SPA.HHO.135 HHO passenger briefing

Regulation (EU) No 965/2012

Prior to any HHO flight, or series of flights, HHO passengers shall have been briefed and made aware of the dangers of static electricity discharge and other HHO considerations.

SPA.HHO.140 Information and documentation

Regulation (EU) No 965/2012

- (a) The operator shall ensure that, as part of its risk analysis and management process, risks associated with the HHO environment are minimised by specifying in the operations manual: selection, composition and training of crews; levels of equipment and dispatch criteria; and operating procedures and minima, such that normal and likely abnormal operations are described and adequately mitigated.
- (b) Relevant extracts from the operations manual shall be available to the organisation for which the HHO is being provided.

AMC1 SPA.HHO.140 Information and documentation

ED Decision 2012/019/R

OPERATIONS MANUAL

The operations manual should include:

- (a) performance criteria;
- (b) if applicable, the conditions under which offshore HHO transfer may be conducted including the relevant limitations on vessel movement and wind speed;
- (c) the weather limitations for HHO;
- (d) the criteria for determining the minimum size of the HHO site, appropriate to the task;
- (e) the procedures for determining minimum crew; and
- (f) the method by which crew members record hoist cycles.

SUBPART J: HELICOPTER EMERGENCY MEDICAL SERVICE OPERATIONS

SPA.HEMS.100 Helicopter emergency medical service (HEMS) operations

Regulation (EU) No 965/2012

- (a) Helicopters shall only be operated for the purpose of HEMS operations if the operator has been approved by the competent authority.
- (b) To obtain such approval by the competent authority, the operator shall:
 - (1) operate in CAT and hold a CAT AOC in accordance with Annex III (Part-ORO);
 - (2) demonstrate to the competent authority compliance with the requirements contained in this Subpart.

GM1 SPA.HEMS.100(a) Helicopter emergency medical service (HEMS) operations

ED Decision 2012/019/R

THE HEMS PHILOSOPHY

(a) Introduction

This GM outlines the HEMS philosophy. Starting with a description of acceptable risk and introducing a taxonomy used in other industries, it describes how risk has been addressed in this Subpart to provide a system of safety to the appropriate standard. It discusses the difference between HEMS and air ambulance - in regulatory terms. It also discusses the application of operations to public interest sites in the HEMS context.

(b) Acceptable risk

The broad aim of any aviation legislation is to permit the widest spectrum of operations with the minimum risk. In fact it may be worth considering who/what is at risk and who/what is being protected. In this view three groups are being protected:

- (1) third parties (including property) - highest protection;
- (2) passengers (including patients); and
- (3) crew members (including technical crew members) – lowest.

It is for the Legislator to facilitate a method for the assessment of risk - or as it is more commonly known, safety management (refer to Part-ORO).

(c) Risk management

Safety management textbooks¹ describe four different approaches to the management of risk. All but the first have been used in the production of this section and, if it is considered that the engine failure accountability of performance class 1 equates to zero risk, then all four are used (this of course is not strictly true as there are a number of helicopter parts - such as the tail rotor which, due to a lack of redundancy, cannot satisfy the criteria):

¹ Reason, J., 1997. Managing the Risks of Organizational Accidents. Ashgate, Farnham.

- (1) Applying the taxonomy to HEMS gives:
 - (i) zero risk; no risk of accident with a harmful consequence – performance class 1 (within the qualification stated above) - the HEMS operating base;
 - (ii) de minimis; minimised to an acceptable safety target - for example the exposure time concept where the target is less than 5×10^{-8} (in the case of elevated final approach and take-off areas (elevated FATOs) at hospitals in a congested hostile environment the risk is contained to the deck edge strike case - and so in effect minimised to an exposure of seconds);
 - (iii) comparative risk; comparison to other exposure - the carriage of a patient with a spinal injury in an ambulance that is subject to ground effect compared to the risk of a HEMS flight (consequential and comparative risk);
 - (iv) as low as reasonably practicable; where additional controls are not economically or reasonably practicable - operations at the HEMS operating site (the accident site).

- (2) HEMS operations are conducted in accordance with the requirements contained in Annex IV (Part-CAT) and Annex III (Part-ORO), except for the variations contained in SPA.HEMS, for which a specific approval is required. In simple terms there are three areas in HEMS operations where risk, beyond that allowed in Part-CAT and Part-ORO, are identified and related risks accepted:

- (i) in the en-route phase, where alleviation is given from height and visibility rules;
- (ii) at the accident site, where alleviation is given from the performance and size requirement; and
- (iii) at an elevated hospital site in a congested hostile environment, where alleviation is given from the deck edge strike - providing elements of the [CAT.POL.H.305](#) are satisfied.

In mitigation against these additional and considered risks, experience levels are set, specialist training is required (such as instrument training to compensate for the increased risk of inadvertent entry into cloud) and operation with two crew (two pilots, or one pilot and a HEMS technical crew member) is mandated. (HEMS crews and medical passengers are also expected to operate in accordance with good crew resource management (CRM) principles.)

- (d) Air ambulance

In regulatory terms, air ambulance is considered to be a normal transport task where the risk is no higher than for operations to the full OPS.CAT and Part-ORO compliance. This is not intended to contradict/complement medical terminology but is simply a statement of policy; none of the risk elements of HEMS should be extant and therefore none of the additional requirements of HEMS need be applied.

To provide a road ambulance analogy:

- (1) if called to an emergency: an ambulance would proceed at great speed, sounding its siren and proceeding against traffic lights - thus matching the risk of operation to the risk of a potential death (= HEMS operations);
- (2) for a transfer of a patient (or equipment) where life and death (or consequential injury of ground transport) is not an issue: the journey would be conducted without sirens and

within normal rules of motoring - once again matching the risk to the task (= air ambulance operations).

The underlying principle is that the aviation risk should be proportionate to the task.

It is for the medical professional to decide between HEMS or air ambulance - not the pilot. For that reason, medical staff who undertake to task medical sorties should be fully aware of the additional risks that are (potentially) present under HEMS operations (and the pre-requisite for the operator to hold a HEMS approval). (For example in some countries, hospitals have principal and alternative sites. The patient may be landed at the safer alternative site (usually in the grounds of the hospital) thus eliminating risk - against the small inconvenience of a short ambulance transfer from the site to the hospital.)

Once the decision between HEMS or air ambulance has been taken by the medical professional, the commander makes an operational judgement over the conduct of the flight.

Simplistically, the above type of air ambulance operations could be conducted by any operator holding an Air Operator Certificate (AOC) (HEMS operators hold an AOC) - and usually are when the carriage of medical supplies (equipment, blood, organs, drugs etc.) is undertaken and when urgency is not an issue.

(e) Operating under a HEMS approval

There are only two possibilities: transportation as passengers or cargo under the full auspices of OPS.CAT and Part-ORO (this does not permit any of the alleviations of SPA.HEMS - landing and take-off performance should be in compliance with the performance Subparts of Part-CAT), or operations under a HEMS approval as contained in this Subpart.

(f) HEMS operational sites

The HEMS philosophy attributes the appropriate levels of risk for each operational site; this is derived from practical considerations and in consideration of the probability of use. The risk is expected to be inversely proportional to the amount of use of the site. The types of site are as follows:

- (1) HEMS operating base: from which all operations will start and finish. There is a high probability of a large number of take-offs and landings at this HEMS operating base and for that reason no alleviation from operating procedures or performance rules are contained in this Subpart.
- (2) HEMS operating site: because this is the primary pick-up site related to an incident or accident, its use can never be pre-planned and therefore attracts alleviations from operating procedures and performance rules, when appropriate.
- (3) The hospital site: is usually at ground level in hospital grounds or, if elevated, on a hospital building. It may have been established during a period when performance criteria were not a consideration. The amount of use of such sites depends on their location and their facilities; normally, it will be greater than that of the HEMS operating site but less than for a HEMS operating base. Such sites attract some alleviation under this Subpart.

(g) Problems with hospital sites

During implementation of the original HEMS rules contained in JAR-OPS 3, it was established that a number of States had encountered problems with the impact of performance rules where helicopters were operated for HEMS. Although States accept that progress should be made towards operations where risks associated with a critical engine failure are eliminated, or

limited by the exposure time concept, a number of landing sites exist that do not (or never can) allow operations to performance class 1 or 2 requirements.

These sites are generally found in a congested hostile environment:

- (1) in the grounds of hospitals; or
- (2) on hospital buildings.

The problem of hospital sites is mainly historical and, whilst the authority could insist that such sites are not used – or used at such a low weight that critical engine failure performance is assured – it would seriously curtail a number of existing operations.

Even though the rule for the use of such sites in hospital grounds for HEMS operations attracts alleviation, it is only partial and will still impact upon present operations.

Because such operations are performed in the public interest, it was felt that the authority should be able to exercise its discretion so as to allow continued use of such sites provided that it is satisfied that an adequate level of safety can be maintained - notwithstanding that the site does not allow operations to performance class 1 or 2 standards. However, it is in the interest of continuing improvements in safety that the alleviation of such operations be constrained to existing sites, and for a limited period.

It is felt that the use of public interest sites should be controlled. This will require that a State directory of sites be kept and approval given only when the operator has an entry in the route manual section of the operations manual.

The directory (and the entry in the operations manual) should contain for each approved site:

- (i) the dimensions;
- (ii) any non-conformance with ICAO Annex 14;
- (iii) the main risks; and
- (iv) the contingency plan should an incident occur.

Each entry should also contain a diagram (or annotated photograph) showing the main aspects of the site.

(h) Summary

In summary, the following points are considered to be pertinent to the HEMS philosophy and HEMS regulations:

- (1) absolute levels of safety are conditioned by society;
- (2) potential risk must only be to a level proportionate to the task;
- (3) protection is afforded at levels appropriate to the occupants;
- (4) this Subpart addresses a number of risk areas and mitigation is built in;
- (5) only HEMS operations are dealt with by this Subpart;
- (6) there are three main categories of HEMS sites and each is addressed appropriately; and
- (7) State alleviation from the requirement at a hospital site is available but such alleviations should be strictly controlled by a system of registration.

SPA.HEMS.110 Equipment requirements for HEMS operations

Regulation (EU) No 965/2012

The installation of all helicopter dedicated medical equipment and any subsequent modifications and, where appropriate, its operation shall be approved in accordance with Regulation (EU) No 748/2012.

SPA.HEMS.115 Communication

Regulation (EU) No 965/2012

In addition to that required by CAT.IDE.H, helicopters conducting HEMS flights shall have communication equipment capable of conducting two-way communication with the organisation for which the HEMS is being conducted and, where possible, to communicate with ground emergency service personnel.

SPA.HEMS.120 HEMS operating minima

Regulation (EU) No 965/2012

- (a) HEMS flights operated in performance class 1 and 2 shall comply with the weather minima in Table 1 for dispatch and en-route phase of the HEMS flight. In the event that during the en-route phase the weather conditions fall below the cloud base or visibility minima shown, helicopters certified for flights only under VMC shall abandon the flight or return to base. Helicopters equipped and certified for instrument meteorological conditions (IMC) operations may abandon the flight, return to base or convert in all respects to a flight conducted under instrument flight rules (IFR), provided the flight crew are suitably qualified.

Table 1

HEMS operating minima			
2 PILOTS		1 PILOT	
DAY			
Ceiling	Visibility	Ceiling	Visibility
500 ft and above	As defined by the applicable airspace VFR minima	500 ft and above	As defined by the applicable airspace VFR minima
499 - 400 ft	1000 m ^(*)	499 – 400 ft	2 000 m
2 PILOTS		1 PILOT	
399 - 300 ft	2 000 m	399 – 300 ft	3 000 m
NIGHT			
Cloud base	Visibility	Cloud base	Visibility
1 200 ft ^(**)	2 500 m	1 200 ft ^(**)	3 000 m

(*) During the en-route phase visibility may be reduced to 800 m for short periods when in sight of land if the helicopter is manoeuvred at a speed that will give adequate opportunity to observe any obstacles in time to avoid a collision.

(**) During the en-route phase, cloud base may be reduced to 1 000 ft for short periods.

- (b) The weather minima for the dispatch and en-route phase of a HEMS flight operated in performance class 3 shall be a cloud ceiling of 600 ft and a visibility of 1500 m. Visibility may be reduced to 800 m for short periods when in sight of land if the helicopter is manoeuvred at a speed that will give adequate opportunity to observe any obstacle and avoid a collision.

GM1 SPA.HERMS.120 HERMS operating minima

ED Decision 2012/019/R

REDUCED VISIBILITY

- (a) In the rule the ability to reduce the visibility for short periods has been included. This will allow the commander to assess the risk of flying temporarily into reduced visibility against the need to provide emergency medical service, taking into account the advisory speeds included in Table 1. Since every situation is different it was not felt appropriate to define the short period in terms of absolute figures. It is for the commander to assess the aviation risk to third parties, the crew and the aircraft such that it is proportionate to the task, using the principles of [GM1 SPA.HERMS.100\(a\)](#).
- (b) When flight with a visibility of less than 5 km is permitted, the forward visibility should not be less than the distance travelled by the helicopter in 30 seconds so as to allow adequate opportunity to see and avoid obstacles (see table below).

Table 1
Operating minima – reduced visibility

Visibility (m)	Advisory speed (kt)
800	50
1 500	100
2 000	120

SPA.HERMS.125 Performance requirements for HERMS operations

Regulation (EU) No 965/2012

- (a) Performance class 3 operations shall not be conducted over a hostile environment.
- (b) Take-off and landing
 - (1) Helicopters conducting operations to/from a final approach and take-off area (FATO) at a hospital that is located in a congested hostile environment and that is used as a HERMS operating base shall be operated in accordance with performance class 1.
 - (2) Helicopters conducting operations to/from a FATO at a hospital that is located in a congested hostile environment and that is not a HERMS operating base shall be operated in accordance with performance class 1, except when the operator holds an approval in accordance with [CAT.POL.H.225](#).
 - (3) Helicopters conducting operations to/from a HERMS operating site located in a hostile environment shall be operated in accordance with performance class 2 and be exempt from the approval required by [CAT.POL.H.305\(a\)](#), provided compliance is shown with [CAT.POL.H.305\(b\)\(2\) and \(b\)\(3\)](#).
 - (4) The HERMS operating site shall be big enough to provide adequate clearance from all obstructions. For night operations, the site shall be illuminated to enable the site and any obstructions to be identified.

GM1 SPA.HEMS.125(b)(3) Performance requirements for HEMS operations

ED Decision 2012/019/R

PERFORMANCE CLASS 2 OPERATIONS AT A HEMS OPERATING SITE

As the risk profile at a HEMS operating site is already well known, operations without an assured safe forced landing capability do not need a separate approval and the requirements does not call for the additional risk assessment that is specified in [CAT.POL.H.305\(b\)\(1\)](#).

AMC1 SPA.HEMS.125(b)(4) Performance requirements for HEMS operations

ED Decision 2012/019/R

HEMS OPERATING SITE DIMENSIONS

- (a) When selecting a HEMS operating site it should have a minimum dimension of at least 2 x D (the largest dimensions of the helicopter when the rotors are turning). For night operations, unsurveyed HEMS operating sites should have dimensions of at least 4 x D in length and 2 x D in width.
- (b) For night operations, the illumination may be either from the ground or from the helicopter.

SPA.HEMS.130 Crew requirements

Regulation (EU) No 965/2012

- (a) *Selection.* The operator shall establish criteria for the selection of flight crew members for the HEMS task, taking previous experience into account.
- (b) *Experience.* The minimum experience level for the commander conducting HEMS flights shall not be less than:
 - (1) either:
 - (i) 1 000 hours as pilot-in-command/commander of aircraft of which 500 hours are as pilot-in-command/commander on helicopters; or
 - (ii) 1 000 hours as co-pilot in HEMS operations of which 500 hours are as pilot-in-command under supervision and 100 hours pilot-in-command/commander of helicopters;
 - (2) 500 hours' operating experience in helicopters, gained in an operational environment similar to the intended operation; and
 - (3) for pilots engaged in night operations, 20 hours of VMC at night as pilot-in-command/commander.
- (c) *Operational training.* Successful completion of operational training in accordance with the HEMS procedures contained in the operations manual.
- (d) *Recency.* All pilots conducting HEMS operations shall have completed a minimum of 30 minutes' flight by sole reference to instruments in a helicopter or in an FSTD within the last six months.
- (e) Crew composition
 - (1) *Day flight.* The minimum crew by day shall be one pilot and one HEMS technical crew member.

-
- (i) This may be reduced to one pilot only when:
 - (A) at a HEMS operating site the commander is required to fetch additional medical supplies. In such case the HEMS technical crew member may be left to give assistance to ill or injured persons while the commander undertakes this flight;
 - (B) after arriving at the HEMS operating site, the installation of the stretcher precludes the HEMS technical crew member from occupying the front seat; or
 - (C) the medical passenger requires the assistance of the HEMS technical crew member in flight.
 - (ii) In the cases described in (i), the operational minima shall be as defined by the applicable airspace requirements; the HEMS operating minima contained in Table 1 of [SPA.HEMS.120](#) shall not be used.
 - (iii) Only in the case described in (i)(A) may the commander land at a HEMS operating site without the technical crew member assisting from the front seat.
- (2) *Night flight*. The minimum crew by night shall be:
- (i) two pilots; or
 - (ii) one pilot and one HEMS technical crew member in specific geographical areas defined by the operator in the operations manual taking into account the following:
 - (A) adequate ground reference;
 - (B) flight following system for the duration of the HEMS mission;
 - (C) reliability of weather reporting facilities;
 - (D) HEMS minimum equipment list;
 - (E) continuity of a crew concept;
 - (F) minimum crew qualification, initial and recurrent training;
 - (G) operating procedures, including crew coordination;
 - (H) weather minima; and
 - (I) additional considerations due to specific local conditions.
- (f) Crew training and checking
- (1) Training and checking shall be conducted in accordance with a detailed syllabus approved by the competent authority and included in the operations manual.
 - (2) Crew members
 - (i) Crew training programmes shall: improve knowledge of the HEMS working environment and equipment; improve crew coordination; and include measures to minimise the risks associated with en-route transit in low visibility conditions, selection of HEMS operating sites and approach and departure profiles.
 - (ii) The measures referred to in (f)(2)(i) shall be assessed during:
 - (A) VMC day proficiency checks, or VMC night proficiency checks when night HEMS operations are undertaken by the operator; and

- (B) line checks.

AMC1 SPA.HEMS.130(b)(2) Crew requirements

ED Decision 2012/019/R

EXPERIENCE

The minimum experience level for a commander conducting HEMS flights should take into account the geographical characteristics of the operation (sea, mountain, big cities with heavy traffic, etc.).

AMC1 SPA.HEMS.130(d) Crew requirements

ED Decision 2012/019/R

REGENCY

This recency may be obtained in a visual flight rules (VFR) helicopter using vision limiting devices such as goggles or screens, or in an FSTD.

AMC1 SPA.HEMS.130(e) Crew requirements

ED Decision 2012/019/R

HEMS TECHNICAL CREW MEMBER

- (a) When the crew is composed of one pilot and one HEMS technical crew member, the latter should be seated in the front seat (co-pilot seat) during the flight, so as to be able to carry out his/her primary task of assisting the commander in:
- (1) collision avoidance;
 - (2) the selection of the landing site; and
 - (3) the detection of obstacles during approach and take-off phases.
- (b) The commander may delegate other aviation tasks to the HEMS technical crew member, as necessary:
- (1) assistance in navigation;
 - (2) assistance in radio communication/radio navigation means selection;
 - (3) reading of checklists; and
 - (4) monitoring of parameters.
- (c) The commander may also delegate to the HEMS technical crew member tasks on the ground:
- (1) assistance in preparing the helicopter and dedicated medical specialist equipment for subsequent HEMS departure; or
 - (2) assistance in the application of safety measures during ground operations with rotors turning (including: crowd control, embarking and disembarking of passengers, refuelling etc.).
- (d) There may be exceptional circumstances when it is not possible for the HEMS technical crew member to carry out his/her primary task as defined under (a).

This is to be regarded as exceptional and is only to be conducted at the discretion of the commander, taking into account the dimensions and environment of the HEMS operating site.)

- (e) When two pilots are carried, there is no requirement for a HEMS technical crew member, provided that the pilot monitoring performs the aviation tasks of a technical crew member.

GM1 SPA.HEMS.130(e)(2)(ii) Crew requirements

ED Decision 2012/019/R

SPECIFIC GEOGRAPHICAL AREAS

In defining those specific geographical areas, the operator should take account of the cultural lighting and topography. In those areas where the cultural lighting and topography make it unlikely that the visual cues would degrade sufficiently to make flying of the aircraft problematical, the HEMS technical crew member is assumed to be able to sufficiently assist the pilot, since under such circumstances instrument and control monitoring would not be required. In those cases where instrument and control monitoring would be required the operations should be conducted with two pilots.

AMC1 SPA.HEMS.130(e)(2)(ii)(B) Crew requirements

ED Decision 2012/019/R

FLIGHT FOLLOWING SYSTEM

A flight following system is a system providing contact with the helicopter throughout its operational area.

AMC1 SPA.HEMS.130(f)(1) Crew requirements

ED Decision 2012/019/R

TRAINING AND CHECKING SYLLABUS

- (a) The flight crew training syllabus should include the following items:
- (1) meteorological training concentrating on the understanding and interpretation of available weather information;
 - (2) preparing the helicopter and specialist medical equipment for subsequent HEMS departure;
 - (3) practice of HEMS departures;
 - (4) the assessment from the air of the suitability of HEMS operating sites; and
 - (5) the medical effects air transport may have on the patient.
- (b) The flight crew checking syllabus should include:
- (1) proficiency checks, which should include landing and take-off profiles likely to be used at HEMS operating sites; and
 - (2) line checks, with special emphasis on the following:
 - (i) local area meteorology;
 - (ii) HEMS flight planning;
 - (iii) HEMS departures;
 - (iv) the selection from the air of HEMS operating sites;
 - (v) low level flight in poor weather; and

- (vi) familiarity with established HEMS operating sites in the operator's local area register.
- (c) HEMS technical crew members should be trained and checked in the following items:
- (1) duties in the HEMS role;
 - (2) map reading, navigation aid principles and use;
 - (3) operation of radio equipment;
 - (4) use of on-board medical equipment;
 - (5) preparing the helicopter and specialist medical equipment for subsequent HEMS departure;
 - (6) instrument reading, warnings, use of normal and emergency checklists in assistance of the pilot as required;
 - (7) basic understanding of the helicopter type in terms of location and design of normal and emergency systems and equipment;
 - (8) crew coordination;
 - (9) practice of response to HEMS call out;
 - (10) conducting refuelling and rotors running refuelling;
 - (11) HEMS operating site selection and use;
 - (12) techniques for handling patients, the medical consequences of air transport and some knowledge of hospital casualty reception;
 - (13) marshalling signals;
 - (14) underslung load operations as appropriate;
 - (15) winch operations as appropriate;
 - (16) the dangers to self and others of rotor running helicopters including loading of patients; and
 - (17) the use of the helicopter inter-communications system.

AMC1 SPA.HEMS.130(f)(2)(ii)(B) Crew requirements

ED Decision 2012/019/R

LINE CHECKS

Where due to the size, the configuration, or the performance of the helicopter, the line check cannot be conducted on an operational flight, it may be conducted on a specially arranged representative flight. This flight may be immediately adjacent to, but not simultaneous with, one of the biannual proficiency checks.

SPA.HEMS.135 HEMS medical passenger and other personnel briefing

Regulation (EU) No 965/2012

- (a) *Medical passenger.* Prior to any HEMS flight, or series of flights, medical passengers shall have been briefed to ensure that they are familiar with the HEMS working environment and

equipment, can operate on-board medical and emergency equipment and can take part in normal and emergency entry and exit procedures.

- (b) *Ground emergency service personnel.* The operator shall take all reasonable measures to ensure that ground emergency service personnel are familiar with the HEMS working environment and equipment and the risks associated with ground operations at a HEMS operating site.
- (c) *Medical patient.* Notwithstanding [CAT.OP.MPA.170](#), a briefing shall only be conducted if the medical condition makes this practicable.

AMC1 SPA.HEMS.135(a) HEMS medical passenger and other personnel briefing

ED Decision 2015/022/R

HEMS MEDICAL PASSENGER BRIEFING

The briefing should ensure that the medical passenger understands his/her role in the operation, which includes:

- (a) familiarisation with the helicopter type(s) operated;
- (b) entry and exit under normal and emergency conditions both for self and patients;
- (c) use of the relevant on-board specialist medical equipment;
- (d) the need for the commander's approval prior to use of specialised equipment;
- (e) method of supervision of other medical staff;
- (f) the use of helicopter inter-communication systems;
- (g) location and use of on board fire extinguishers; and
- (h) the operator's crew coordination concept including relevant elements of crew resource management.

AMC1.1 SPA.HEMS.135(a) HEMS medical passenger and other personnel briefing

ED Decision 2012/019/R

HEMS MEDICAL PASSENGER BRIEFING

Another means of complying with the rule as compared to that contained in [AMC1 SPA.HEMS.135\(a\)](#) is to make use of a training programme as mentioned in [AMC1.1 CAT.OP.MPA.170](#).

AMC1 SPA.HEMS.135(b) HEMS medical passenger and other personnel briefing

ED Decision 2012/019/R

GROUND EMERGENCY SERVICE PERSONNEL

- (a) The task of training large numbers of emergency service personnel is formidable. Wherever possible, helicopter operators should afford every assistance to those persons responsible for training emergency service personnel in HEMS support. This can be achieved by various means, such as, but not limited to, the production of flyers, publication of relevant information on the operator's web site and provision of extracts from the operations manual.

- (b) The elements that should be covered include:
- (1) two-way radio communication procedures with helicopters;
 - (2) the selection of suitable HEMS operating sites for HEMS flights;
 - (3) the physical danger areas of helicopters;
 - (4) crowd control in respect of helicopter operations; and
 - (5) the evacuation of helicopter occupants following an on-site helicopter accident.

SPA.HEMS.140 Information and documentation

Regulation (EU) No 965/2012

- (a) The operator shall ensure that, as part of its risk analysis and management process, risks associated with the HEMS environment are minimised by specifying in the operations manual: selection, composition and training of crews; levels of equipment and dispatch criteria; and operating procedures and minima, such that normal and likely abnormal operations are described and adequately mitigated.
- (b) Relevant extracts from the operations manual shall be made available to the organisation for which the HEMS is being provided.

AMC1 SPA.HEMS.140 Information and documentation

ED Decision 2012/019/R

OPERATIONS MANUAL

The operations manual should include:

- (a) the use of portable equipment on board;
- (b) guidance on take-off and landing procedures at previously unsurveyed HEMS operating sites;
- (c) the final reserve fuel, in accordance with [SPA.HEMS.150](#);
- (d) operating minima;
- (e) recommended routes for regular flights to surveyed sites, including the minimum flight altitude;
- (f) guidance for the selection of the HEMS operating site in case of a flight to an unsurveyed site;
- (g) the safety altitude for the area overflown; and
- (h) procedures to be followed in case of inadvertent entry into cloud.

SPA.HEMS.145 HEMS operating base facilities

Regulation (EU) No 965/2012

- (a) If crew members are required to be on standby with a reaction time of less than 45 minutes, dedicated suitable accommodation shall be provided close to each operating base.
- (b) At each operating base the pilots shall be provided with facilities for obtaining current and forecast weather information and shall be provided with satisfactory communications with the appropriate air traffic services (ATS) unit. Adequate facilities shall be available for the planning of all tasks.

SPA.HERMS.150 Fuel/energy supply – alleviation

Regulation (EU) 2021/1296

As an alternative to points [CAT.OP.MPA.191\(b\), \(c\), and \(d\)](#), when the helicopter emergency medical services (HERMS) mission is conducted under visual flight rules (VFR) within a local and defined geographical area, the fuel/energy policy shall ensure that on completion of the mission, the final reserve fuel/energy is sufficient for:

- (a) 30-minute flying time at best-range speed; or
- (b) 20-minute flying time at best-range speed by day, when operating within an area providing continuous and suitable operating sites.

SPA.HERMS.155 Refuelling with passengers on board

Regulation (EU) 2021/1296

A refuelling procedure with either rotors stopped or rotors turning shall be provided in accordance with point [CAT.OP.MPA.200](#) 'Special refuelling or defuelling of the aircraft.'

SUBPART K: HELICOPTER OFFSHORE OPERATIONS

SPA.HOFO.100 Helicopter offshore operations (HOFO)

Regulation (EU) 2016/1199

The requirements of this Subpart apply to:

- (a) a commercial air transport operator holding a valid AOC in accordance with Part-ORO;
- (b) a specialised operations operator having declared its activity in accordance with Part-ORO; or
- (c) a non-commercial operator having declared its activity in accordance with Part-ORO.

SPA.HOFO.105 Approval for helicopter offshore operations

Regulation (EU) 2016/1199

- (a) Prior to engaging in operations under this Subpart, a specific approval by the competent authority shall have been issued to the operator.
- (b) To obtain such approval, the operator shall submit an application to the competent authority as specified in [SPA.GEN.105](#), and shall demonstrate compliance with the requirements of this Subpart.
- (c) The operator shall, prior to performing operations from a Member State other than the Member State that issued the approval under (a), inform the competent authorities in both Member States of the intended operation.

GM1 SPA.HOFO.105(c) Approval for offshore operations

ED Decision 2016/022/R

The requirement to inform both Member States (MSs) allows the MSs to mutually decide on how best to exercise their obligations in accordance with [ARO.GEN.300\(d\) and \(e\)](#) when operations are intended to be performed in a MS other than the MS issuing the approval for offshore operations.

SPA.HOFO.110 Operating procedures

Regulation (EU) 2016/1199

- (a) The operator shall, as part of its safety management process, mitigate and minimise risks and hazards specific to helicopter offshore operations. The operator shall specify in the operations manual the:
 - (1) selection, composition and training of crews;
 - (2) duties and responsibilities of crew members and other involved personnel;
 - (3) required equipment and dispatch criteria; and
 - (4) operating procedures and minima, such that normal and likely abnormal operations are described and adequately mitigated.
- (b) The operator shall ensure that:
 - (1) an operational flight plan is prepared prior to each flight;
 - (2) the passenger safety briefing also includes any specific information on offshore related items and is provided prior to boarding the helicopter;

- (3) each member of the flight crew wears an approved survival suit:
 - (i) when the weather report or forecasts available to the pilot-in-command/commander indicate that the sea temperature will be less than plus 10°C during the flight; or
 - (ii) when the estimated rescue time exceeds the calculated survival time; or
 - (iii) when the flight is planned to be conducted at night in a hostile environment;
- (4) where established, the offshore route structure provided by the appropriate ATS is followed;
- (5) pilots make optimum use of the automatic flight control systems (AFCS) throughout the flight;
- (6) specific offshore approach profiles are established, including stable approach parameters and the corrective action to be taken if an approach becomes unstable;
- (7) for multi-pilot operations, procedures are in place for a member of the flight crew to monitor the flight instruments during an offshore flight, especially during approach or departure, to ensure that a safe flight path is maintained;
- (8) the flight crew takes immediate and appropriate action when a height alert is activated;
- (9) procedures are in place to require the emergency flotation systems to be armed, when safe to do so, for all overwater arrivals and departures; and
- (10) operations are conducted in accordance with any restriction on the routes or the areas of operation specified by the competent authority or the appropriate authority responsible for the airspace.

AMC1 SPA.HOFO.110(a) Operating procedures

ED Decision 2016/022/R

RISK ASSESSMENT

The operator's risk assessment should include, but not be limited to, the following hazards:

- (a) collision with offshore installations, vessels and floating structures;
- (b) collision with wind turbines;
- (c) collision with skysails;
- (d) collision during low-level instrument meteorological conditions (IMC) operations;
- (e) collision with obstacles adjacent to helidecks;
- (f) collision with surface/water;
- (g) IMC or night offshore approaches;
- (h) loss of control during operations to small or moving offshore locations;
- (i) operations to unattended helidecks; and
- (j) weather and/or sea conditions that could either cause an accident or exacerbate its consequences.

AMC1 SPA.HOFO.110(a)(4) Operating procedures

ED Decision 2022/005/R

REFUELLING PROCEDURE

If refuelling with the rotors turning is conducted, a procedure should be established and used in accordance with point [CAT.OP.MPA.200](#).

AMC1 SPA.HOFO.110(b)(1) Operating procedures

ED Decision 2016/022/R

OPERATIONAL FLIGHT PLAN

The operational flight plan should contain at least the items listed in [AMC1 CAT.OP.MPA.175\(a\)](#) Flight preparation.

AMC1 SPA.HOFO.110(b)(2) Operating procedures

ED Decision 2016/022/R

PASSENGER BRIEFING

The following aspects applicable to the helicopter used should be presented and demonstrated to the passengers by audio-visual electronic means (video, DVD or similar), or the passengers should be informed about them by a crew member prior to boarding the aircraft:

- (a) the use of the life jackets and where they are stowed if not in use;
- (b) the proper use of survival suits, including briefing on the need to have suits fully zipped with, if applicable, hoods and gloves on, during take-off and landing or when otherwise advised by the pilot-in-command/commander;
- (c) the proper use of emergency breathing equipment;
- (d) the location and operation of the emergency exits;
- (e) life raft deployment and boarding;
- (f) deployment of all survival equipment; and
- (g) boarding and disembarkation instructions.

When operating in a non-hostile environment, the operator may omit items related to equipment that is not required.

AMC1.1 SPA.HOFO.110(b)(2) Operating procedures

ED Decision 2016/022/R

PASSENGER BRIEFING

This AMC is applicable to passengers who require more knowledge of the operational concept, such as sea pilots and support personnel for offshore wind turbines.

The operator may replace the passenger briefing as set out in [AMC1 SPA.HOFO.110\(b\)\(2\)](#) with a passenger training and checking programme provided that:

- the operator ensures that the passenger is appropriately trained and qualified on the helicopter types on which they are to be carried;

- the operator defines the training and checking programme for each helicopter type, covering all safety and emergency procedures for a given helicopter type, and including practical training;
- the passenger has received the above training within the last 12 calendar months; and
- the passenger has flown on the helicopter type within the last 90 days.

AMC1 SPA.HOFO.110(b)(5) Operating procedures

ED Decision 2016/022/R

AUTOMATIC FLIGHT CONTROL SYSTEM (AFCS)

To ensure competence in manual handling of the helicopter, the operator should provide instructions to the flight crew in the operations manual (OM) under which circumstances the helicopter may be operated in lower modes of automation. Particular emphasis should be given to flight in instrument meteorological conditions (IMC) and instrument approaches.

GM1 SPA.HOFO.110(b)(9) Operating Procedures

ED Decision 2016/022/R

Emergency flotation systems (EFSs) cannot always be armed safely before the approach when a speed limitation needs to be complied with. In such case, the EFS should be armed as soon as safe to do so.

SPA.HOFO.115 Use of offshore locations

Regulation (EU) 2016/1199

The operator shall only use offshore locations that are suitable in relation to size and mass of the type of helicopter and to the operations concerned.

AMC1 SPA.HOFO.115 Use of offshore locations

ED Decision 2016/022/R

GENERAL

- (a) The operations manual (OM) relating to the specific usage of offshore helicopter landing areas (Part C for CAT operators) should contain, or make reference to, a directory of helidecks (helideck directory (HD)) intended to be used by the operator. The directory should provide details of helideck limitations and a pictorial representation of each offshore location and its helicopter landing area, recording all necessary information of a permanent nature and using a standardised template. The HD entries should show, and be amended as necessary, the most recent status of each helideck concerning non-compliance with applicable national standards, limitations, warnings, cautions or other comments of operational importance. An example of a typical template is shown in Figure 1 of [GM1 SPA.HOFO.115](#) below.
- (b) In order to ensure that the safety of flights is not compromised, the operator should obtain relevant information and details in order to compile the HD, as well as the pictorial representation from the owner/operator of the offshore helicopter landing area.
- (c) If more than one name for the offshore location exists, the common name painted on the surface of the landing area should be listed, but other names should also be included in the HD (e.g. radio call sign, if different). After renaming an offshore location, the old name should also be included in the HD for the following 6 months.

- (d) Any limitations associated with an offshore location should be included in the HD. With complex installation arrangements, including combinations of installations/vessels (e.g. combined operations), a separate listing in the HD, accompanied by diagrams/pictures, where necessary, may be required.
- (e) Each offshore helicopter landing area should be inspected and assessed based on limitations, warnings, instructions and restrictions, in order to determine its acceptability with respect to the following as a minimum:
- (1) The physical characteristics of the landing area, including size, load-bearing capability and the appropriate 'D' and 't' values.

Note 1: 'D' is the overall length of the helicopter from the most forward position of the main rotor tip to the most rearward position of the tail rotor tip plane path, or rearmost extension of the fuselage in the case of 'Fenestron' or 'NOTAR' tails.

Note 2: 't' is the maximum allowable mass in tonnes.
 - (2) The preservation of obstacle-protected surfaces (an essential safeguard for all flights). These surfaces are:
 - (i) the minimum 210° obstacle-free surface (OFS) above helideck level;
 - (ii) the 150° limited-obstacle surface (LOS) above helideck level; and
 - (iii) the minimum 180° falling '5:1' gradient with respect to significant obstacles below helideck level.

If these sectors/surfaces are infringed, even on a temporary basis, and/or if an adjacent installation or vessel infringes the obstacle-protected surfaces related to the landing area, an assessment should be made to determine whether it is necessary to impose operating limitations and/or restrictions to mitigate any non-compliance with the criteria.
 - (3) Marking and lighting:
 - (i) for operations at night, adequate illumination of the perimeter of the landing area, using perimeter lighting that meets national requirements;
 - (ii) for operations at night, adequate illumination of the location of the touchdown marking by use of a lit touchdown/positioning marking and lit helideck identification marking that meet national requirements;
 - (iii) status lights (for night and day operations, indicating the status of the helicopter landing area, e.g. a red flashing light indicates 'landing area unsafe: do not land') meeting national requirements;
 - (iv) dominant-obstacle paint schemes and lighting;
 - (v) condition of helideck markings; and
 - (vi) adequacy of general installation and structure lighting.

Any limitations with respect to non-compliance of lighting arrangements may require the HD to be annotated 'daylight only operations'.
 - (4) Deck surface:
 - (i) assessment of surface friction;
 - (ii) adequacy and condition of helideck net (where provided);
 - (iii) 'fit for purpose' drainage system;

- (iv) deck edge safety netting or shelving;
 - (v) a system of tie-down points that is adequate for the range of helicopters in use; and
 - (vi) procedures to ensure that the surface is kept clean of all contaminants, e.g. bird guano, sea spray, snow and ice.
- (5) Environment:
- (i) foreign-object damage;
 - (ii) an assessment of physical turbulence generators, e.g. structure-induced turbulence due to clad derrick;
 - (iii) bird control measures;
 - (iv) air flow degradation due to gas turbine exhaust emissions (turbulence and thermal effects), flares (thermal effects) or cold gas vents (unburned flammable gas); and
 - (v) adjacent offshore installations may need to be included in the environmental assessment.
- To assess for potential adverse environmental effects, as described in (ii), (iv) and (v) above, an offshore location should be subject to appropriate studies, e.g. wind tunnel testing and/or computational fluid dynamics (CFD) analysis.
- (6) Rescue and firefighting:
- (i) systems for delivery of firefighting media to the landing area, e.g. deck integrated firefighting system (DIFFS);
 - (ii) delivery of primary media types, assumed critical area, application rate and duration;
 - (iii) deliveries of complementary agent(s) and media types, capacity and discharge;
 - (iv) personal protective equipment (PPE); and
 - (v) rescue equipment and crash box/cabinet.
- (7) Communication and navigation (Com/Nav):
- (i) aeronautical radio(s);
 - (ii) radio-telephone (R/T) call sign to match the offshore location name with the side identification that should be simple and unique; and
 - (iii) radio log.
- (8) Fuelling facilities:
- in accordance with the relevant national guidance and legislation.
- (9) Additional operational and handling equipment:
- (i) windsock;
 - (ii) meteorological information, including wind, pressure, air temperature, and dew point temperature, and equipment recording and displaying mean wind (10-min wind) and gusts;
 - (iii) helideck motion recording and reporting system, where applicable;

- (iv) passenger briefing system;
 - (v) chocks;
 - (vi) tie-down strops/ropes;
 - (vii) weighing scales;
 - (viii) a suitable power source for starting helicopters (e.g. ground power unit (GPU)), where applicable; and
 - (ix) equipment for clearing the landing area of snow, ice and other contaminants.
- (10) Personnel:
- trained helicopter-landing-area staff (e.g. helicopter landing officer/helicopter deck assistant and firefighters, etc.); persons required to assess local weather conditions or communicate with the helicopter by radio-telephony should be appropriately qualified.
- (f) The HD entry for each offshore location should be completed and kept up to date, using the template and reflecting the information and details described in (e) above. The template should contain at least the following ([GM1 SPA.HOFO.115](#) below is provided as an example):
- (1) details:
- (i) name of offshore location;
 - (ii) R/T call sign;
 - (iii) helicopter landing area identification marking;
 - (iv) side panel identification marking;
 - (v) landing area elevation;
 - (vi) maximum installation/vessel height;
 - (vii) helideck size and/or 'D' value;
 - (viii) type of offshore location:
 - (A) fixed, permanently manned installation;
 - (B) fixed, normally unattended installation;
 - (C) vessel type (e.g. diving support vessel, tanker, etc.);
 - (D) semi-submersible, mobile, offshore drilling unit;
 - (E) jack-up, mobile, offshore drilling unit;
 - (F) floating production, storage and offloading (FPSO);
 - (ix) name of owner/operator;
 - (x) geographical position, where appropriate;
 - (xi) Com/Nav frequencies and identification;
 - (xii) general drawing of the offshore location that shows the helicopter landing area with annotations indicating location of derrick, masts, cranes, flare stack, turbine and gas exhausts, side identification panels, windsock, etc.;

- (xiii) plan view drawing, and chart orientation from the general drawing to show the above; the plan view should also show the 210-degree sector orientation in degrees true;
 - (xiv) type of fuelling:
 - (A) pressure and gravity;
 - (B) pressure only;
 - (C) gravity only; and
 - (D) none;
 - (xv) type and nature of firefighting equipment;
 - (xvi) availability of GPU;
 - (xvii) deck heading;
 - (xviii) 't' value ;
 - (xix) status light system (Yes/No); and
 - (xx) revision publication date or number; and
- (2) one or more diagrams/photographs, and any other suitable guidance to assist pilots.
- (g) For offshore locations for which there is incomplete information, 'restricted' usage based on the information available may be considered by the operator, subject to risk assessment prior to the first helicopter visit. During subsequent operations, and before any restriction on usage is lifted, information should be gathered and the following should apply:
- (1) pictorial (static) representation:
 - (i) template blanks ([GM1 SPA.HOFO.115](#) is provided as an example) should be available to be filled in during flight preparation on the basis of the information given by the offshore location owner/operator and of flight crew observations;
 - (ii) where possible, suitably annotated photographs may be used until the HD entry and template have been completed;
 - (iii) until the HD entry and template have been completed, conservative operational restrictions (e.g. performance, routing, etc.) may be applied;
 - (iv) any previous inspection reports should be obtained and reviewed by the operator; and
 - (v) an inspection of the offshore helicopter landing area should be carried out to verify the content of the completed HD entry and template; once found suitable, the landing area may be considered authorised for use by the operator; and
 - (2) with reference to the above, the HD entry should contain at least the following:
 - (i) HD revision date or number;
 - (ii) generic list of helideck motion limitations;
 - (iii) name of offshore location;
 - (iv) helideck size and/or 'D' value and 't' value; and
 - (v) limitations, warnings, instructions and restrictions.

GM1 SPA.HOFO.115 Use of offshore locations

ED Decision 2016/022/R

Figure 1 – Example of a helicopter landing area template

Operator		10-1	Revision date	
Installation/vessel name		Position	(N/S XXX)	(E/W XXX)
Deck height (XXX ft)	Installation height (XXX ft)	Highest obstacle within 5 nm	Deck heading	Deck ident
AIMS/ICAO code	Radio	Radio	Deck category (1/2/3)	Side ident
Deck size (m)	T value (XXX kg)	Cleared for (above D or t values) (Helicopter type xxx)	Installation type (Fixed/semi/etc.)	Operator
Fuel (Press/gravity/no)	Ground power (AC/DC/no)	Inspection date	Inspected by	Next due
				
Wind direction (All) (000–050)		Wind speed (All) (> 30)		Limitations (Performance requirements) (Table 2 etc.)
5:1 non-compliant obstacles				
Additional information				

Figure 2 — Example of a helicopter landing area template



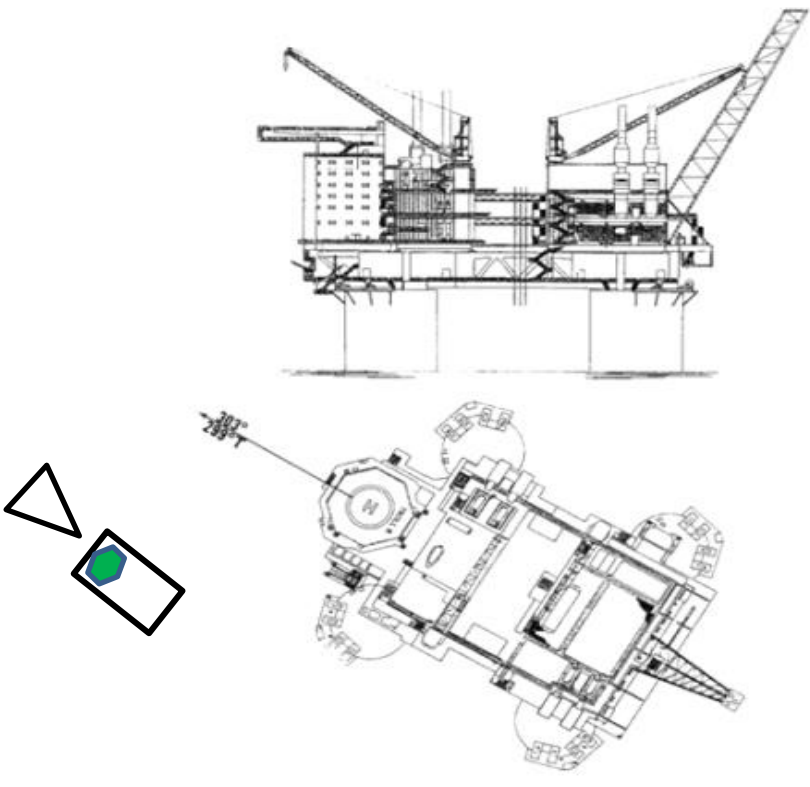
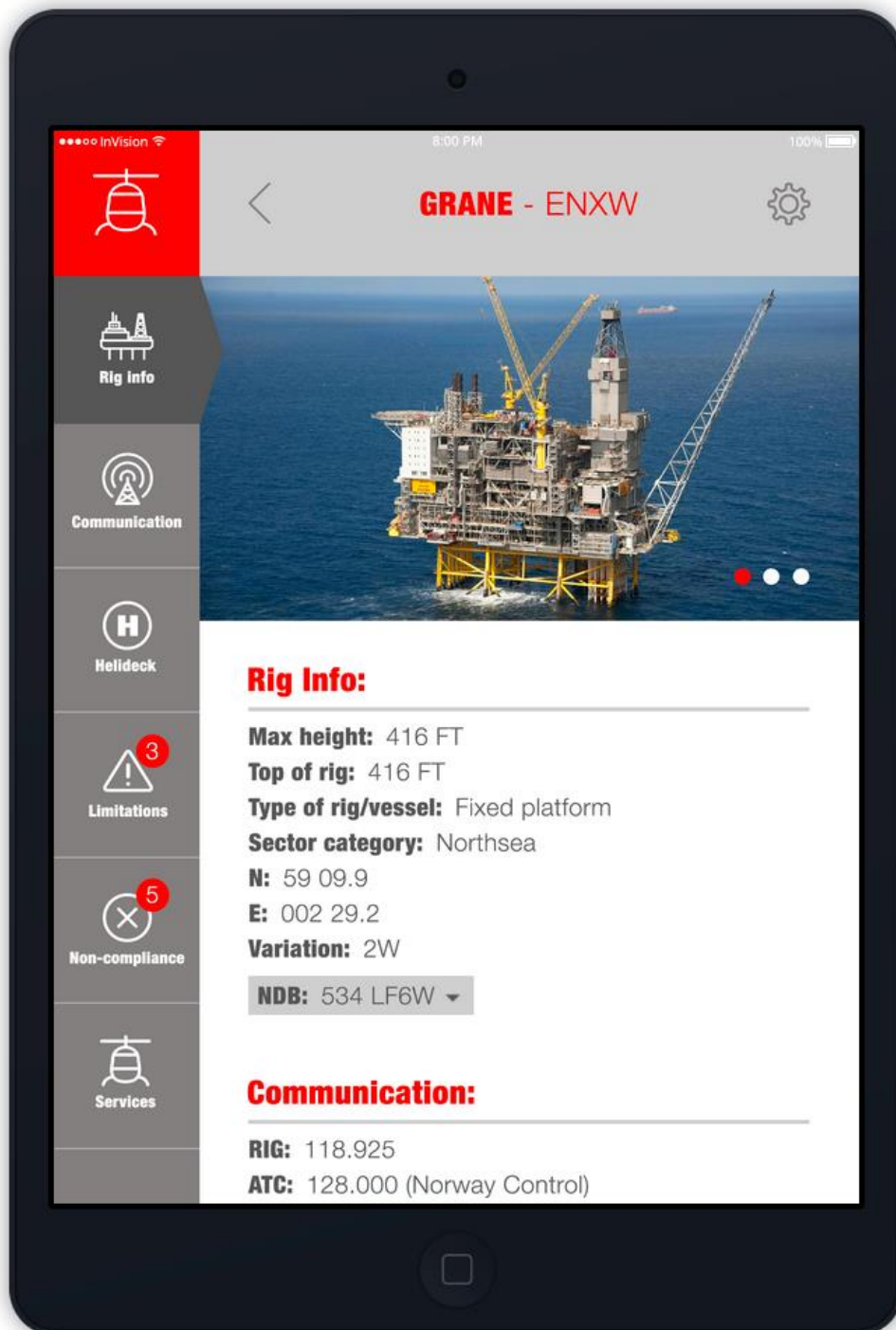
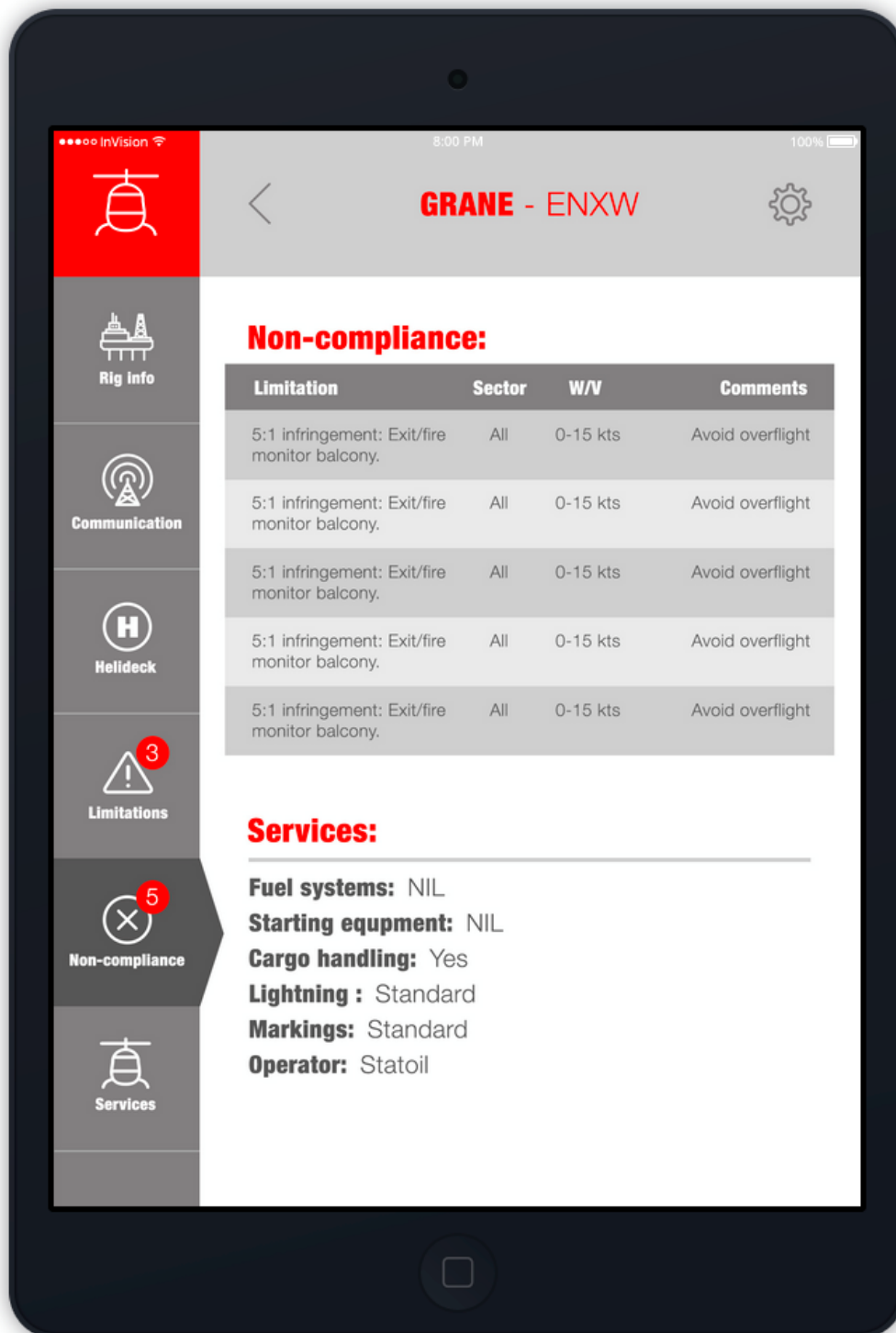

GM2 SPA.HOFO.115 Use of offshore locations

ED Decision 2016/022/R

Operators should use available standards and regulations provided for operations to offshore locations such as those contained in United Kingdom Civil Aviation Authority (UK CAA) CAP 437

'Standards for Offshore Helicopter Landing Areas', Norwegian Civil Aviation Regulation BSL D 5-1 or similar national documentation, or ICAO Annex 14, Vol II 'Heliports'.

SPA.HOFO.120 Selection of aerodromes and operating sites

Regulation (EU) 2021/2237

- (a) Onshore destination alternate aerodrome. Notwithstanding points [CAT.OP.MPA.192](#), [NCC.OP.152](#) and [SPO.OP.151](#), the pilot-in command/commander does not need to specify a destination alternate aerodrome in the operational flight plan when conducting flights from an offshore location to a land destination aerodrome provided that sufficient operational contingency is in place to ensure a safe return from offshore.
- (b) Offshore destination alternate helideck. The operator may select an offshore destination alternate helideck when all of the following criteria are met:
- (1) An offshore destination alternate helideck shall be used only after the point of no return (PNR) and when an onshore destination alternative aerodrome is not geographically available. Prior to the PNR, an onshore destination alternate aerodrome shall be used.
 - (2) One engine inoperative (OEI) landing capability shall be attainable at the offshore destination alternate helideck.
 - (3) To the extent possible, helideck availability shall be guaranteed prior to PNR. The dimensions, configuration and obstacle clearance of individual helidecks or other sites shall be suitable for its use as an alternate helideck by each helicopter type intended to be used.
 - (4) Weather minima shall be established taking into account the accuracy and reliability of meteorological information.
 - (5) The MEL shall contain specific provisions for this type of operation.
 - (6) An offshore destination alternate helideck shall only be selected if the operator has established a procedure in the operations manual.

AMC1 SPA.HOFO.120 Selection of aerodromes and operating sites

ED Decision 2022/012/R

DESTINATION AERODROME — SUFFICIENT OPERATIONAL CONTINGENCY

- (a) Any alleviation from the requirement to select an alternate aerodrome under instrument flight rules (IFR) routing from offshore to a land destination should be based on an individual safety risk assessment with sufficient operational contingency to ensure a safe return from offshore.

REVISED AERODROME OPERATING MINIMA

- (b) Unless the destination is a coastal aerodrome, the operator should ensure that all the following criteria are met:
- (1) the destination aerodrome has a published instrument approach;
 - (2) the flight time is less than 3 hours; and
 - (3) the published weather forecast valid from 1 hour prior, and 1 hour subsequent to the expected landing time specifies that:

- (i) the ceiling is at least 700 ft above the minima associated with the instrument approach, or 1 000 ft above the destination aerodrome, whichever is the higher; and
- (ii) visibility is at least 2 500 m.

COASTAL AERODROME

- (c) A coastal aerodrome is an aerodrome used for offshore operations within 5 nm of the coastline.
- (d) If the coastal aerodrome has a published instrument approach, the operator should use the aerodrome operating minima defined in (b)(3).
- (e) The operator may use the following operating minima by day only, as an alternative to (b)(3):
 - (1) the cloud base is at least 400 ft above the minima associated with the instrument approach; and
 - (2) visibility is at least 4 km.
- (f) If descent over the sea is intended to meet VFR criteria, the operator should ensure that the coastal aerodrome is geographically sited so that the helicopter is able, within the rules of the air and within the landing forecast, to proceed inbound from the coast and carry out an approach and landing in full compliance with VFR for the associated airspace category(ies) and any notified route.
- (g) If the operator makes use of the provisions in (e) or (f), the following should be taken into account as part of the risk assessment:
 - 1) where the destination coastal aerodrome is not directly on the coast, the required usable fuel for the flight should be sufficient to return to the coast at any time after crossing the coastline, descend safely, carry out an approach under VFR and land, with the VFR fuel reserves intact;
 - (2) the descent to establish visual contact with the surface should take place over the sea away from the coastline and in an area clear of surface obstructions, or as part of the instrument approach;
 - (3) routings and procedures for coastal aerodromes nominated as such should be included in the operations manual (Part C for CAT operators);
 - (4) the MEL should reflect the requirement for airborne radar and radio altimeter for this type of operation; and
 - (5) operational limitations for each coastal aerodrome should be specified in the operations manual.

AMC2 SPA.HOFO.120 Selection of aerodromes and operating sites

ED Decision 2016/022/R

OFFSHORE DESTINATION ALTERNATE AERODROME

'Aerodrome' is referred to as 'helideck' in this AMC.

- (a) Offshore destination alternate helideck landing environment

The landing environment at an offshore location proposed for use as an offshore destination alternate helideck should be pre-surveyed, together with the physical characteristics, such as the effect of wind direction and strength, as well as of turbulence established. This information, which should be available to the pilot-in-command/commander both at the planning stage and

in-flight, should be published in an appropriate form in the operations manual (OM) (including the orientation of the helideck) so that the suitability of the alternate helideck can be assessed. This helideck should meet the criteria for size and obstacle clearance appropriate to the performance requirements of the type of helicopter concerned.

(b) Performance considerations

The use of an offshore destination alternate helideck should be restricted to helicopters that can achieve one engine inoperative (OEI) in ground effect (IGE) hover at an appropriate power rating above the helideck at the offshore location. Where the surface of the helideck or prevailing conditions (especially wind velocity) precludes an OEI IGE, OEI out-of-ground effect (OGE) hover performance at an appropriate power rating should be used to compute the landing mass. The landing mass should be calculated based on graphs provided in the operations manual (OM) (Part B for CAT operators). When this landing mass is computed, due account should be taken of helicopter configuration, environmental conditions and the operation of systems that have an adverse effect on performance. The planned landing mass of the helicopter, including crew, passengers, baggage, cargo plus 30-min final reserve fuel (FRF), should not exceed the OEI landing mass of the helicopter at the time of approach to the offshore destination alternate.

(c) Weather considerations

(1) Meteorological observations

When the use of an offshore destination alternate helideck is planned, the meteorological observations, both at the offshore destination and the alternate helideck, should be made by an observer acceptable to the authority responsible for the provision of meteorological services. Automatic meteorological-observation stations may be used.

(2) Weather minima

When the use of an offshore destination alternate helideck is planned, the operator should neither select an offshore location as destination nor as alternate helideck unless the weather forecasts for the two offshore locations indicate that during a period commencing 1 h before and ending 1 h after the expected time of arrival at the destination and the alternate helideck, the weather conditions will be at or above the planning minima shown in the following table:

Table 1 — Planning minima

Planning minima		
	Day	Night
Cloud base	600 ft	800 ft
Visibility	4 km	5 km

(3) Conditions of fog

To use an offshore destination alternate helideck, it should be ensured that fog is not forecast or present within 60 nm of the destination helideck and alternate helideck during the period commencing 1 h before and ending 1 h after the expected time of arrival at the offshore destination or alternate helideck.

(d) Actions at point of no return

Before passing the point of no return, which should not be more than 30 min from the destination, the following actions should have been completed:

- (1) confirmation that navigation to the offshore destination and offshore destination alternate helideck can be assured;
- (2) radio contact with the offshore destination and offshore destination alternate helideck (or master station) has been established;
- (3) the landing forecast at the offshore destination and offshore destination alternate helideck have been obtained and confirmed to be at or above the required minima;
- (4) the requirements for OEI landing (see (b) above) have been checked in the light of the latest reported weather conditions to ensure that they can be met; and
- (5) to the extent possible, having regard to information on the current and forecast use of the offshore alternate helideck and on prevailing conditions, the availability of the helideck on the offshore location intended as destination alternate helideck should be guaranteed by the duty holder (the rig operator in the case of fixed installations, and the owner in the case of mobile ones) until the landing at the destination, or the offshore destination alternate helideck, has been achieved or until offshore shuttling has been completed.

SPA.HOFO.125 Offshore standard approach procedures (OSAPs)

Regulation (EU) 2021/2237

- (a) An operator shall establish procedures to ensure that offshore standard approach procedures (OSAPs) are followed only if:
 - (1) the helicopter is capable of providing navigation and real-time obstacle environment information for obstacle clearance; and
 - (2) either:
 - (i) the minimum descent height (MDH) is determined from a radio altimeter or a device that provides equivalent performance; or
 - (ii) the minimum descent altitude (MDA) is applied and it includes an adequate margin.
- (b) If the operator follows OSAPs to rigs or vessels in transit, the flight shall be conducted in multi-pilot operations.
- (c) The decision range shall provide adequate obstacle clearance in the missed approach from any destination for which an OSAP is planned.
- (d) The approach shall only be continued beyond decision range or below the minimum descent altitude/height (MDA/H) when visual reference to the destination has been established.
- (e) For single-pilot operations, appropriate increments shall be added to the MDA/H and decision range.
- (f) When an OSAP is followed to a non-moving offshore location (i.e. fixed installation or moored vessel) and a reliable GNSS position for the location is available in the navigation system, the GNSS/area navigation system shall be used to enhance the safety of the OSAP.
- (g) The operator shall include OSAPs in its initial and recurrent training and checking programmes.

AMC1 SPA.HOFO.125 Offshore standard approach procedures (OSAPs)

ED Decision 2022/012/R

AIRBORNE RADAR APPROACH (ARA)

- (a) Before commencing the final approach, the pilot-in-command/commander should ensure that a clear path exists on the radar screen for the final and missed approach segments. If lateral clearance from any obstacle will be less than 1 nm, the pilot-in-command/commander should:
 - (1) approach to a nearby target structure and thereafter proceed visually to the destination structure; or
 - (2) make the approach from another direction leading to a circling manoeuvre.
- (b) The cloud ceiling should be sufficiently clear above the helideck to permit a safe landing.
- (c) Minimum descent height (MDH) should not be less than 50 ft above the elevation of the helideck:
 - (1) the MDH for an airborne radar approach should not be lower than:
 - (i) 200 ft by day; or
 - (ii) 300 ft by night; and
 - (2) the MDH for an approach leading to a circling manoeuvre should not be lower than:
 - (i) 300 ft by day; or
 - (ii) 500 ft by night.
- (d) Minimum descent altitude (MDA) may only be used if the radio altimeter is unserviceable. The MDA should be a minimum of the MDH + 200 ft, and be based on a calibrated barometer at the destination or on the lowest forecast barometric pressure adjusted to sea level (QNH) for the region.
- (e) The decision range should not be less than 0.75 nm.
- (f) The MDA/MDH for a single-pilot ARA should be 100 ft higher than that calculated in accordance with (c) and (d) above. The decision range should not be less than 1 nm.
- (g) For approaches to non-moving offshore locations, the maximum range discrepancy between the global navigation satellite system (GNSS) and the weather radar display should not be greater than 0.3 nm at any point between the final approach fix (FAF) at 4 nm from the offshore location and the offset initiation point (OIP) at 1.5 nm from the offshore location.
- (h) For approaches to non-moving offshore locations, the maximum bearing discrepancy between the GNSS and the weather radar display should not be greater than 10° at the FAF at 4 nm from the offshore location.

AMC2 SPA.HOFO.125 Offshore standard approach procedures (OSAPs)

ED Decision 2022/012/R

OSAP — ORIGINAL EQUIPMENT MANUFACTURER (OEM) — CERTIFIED APPROACH SYSTEM

Where an OSAP is conducted to a non-moving offshore location (i.e. fixed installation or moored vessel), and an original equipment manufacturer (OEM)-certified approach system is available, the use

of automation to reach a reliable GNSS position for that location should be used to enhance the safety of the OSAP.

The OSAP should meet the following requirements:

- (a) The OEM-certified approach system should be approved in accordance with the applicable airworthiness requirements for operations at night and in IMC.
- (b) The aircraft should be equipped with a radar altimeter and a suitable airborne radar.
- (c) The GNSS position of the installation should be retrieved from the area navigation system database or by manual entry if the aircraft flight management system will allow for that.
- (d) The approach system vertical path should be a Baro VNAV or a GNSS SBAS vertical source type. The radar height should be cross-checked (either automatically or by the crew) to avoid erroneous QNH selection.
- (e) The descent angle should be of a maximum of 4°. Up to 6° could be acceptable only if the GS is reduced to 60 kt.
- (f) The minimum descent height (MDH) should not be less than 50 ft above the elevation of the helideck:
 - (1) the MDH for an approach should not be lower than:
 - (i) 200 ft by day; or
 - (ii) 300 ft by night; and
 - (2) the MDH for an approach leading to a circling manoeuvre should not be lower than:
 - (i) 300 ft by day; or
 - (ii) 500 ft by night.
- (g) The minimum descent altitude (MDA) may only be used if the radio altimeter is unserviceable. The MDA should be a minimum of the MDH + 200 ft and should be based on a calibrated barometer at destination or on the lowest forecast barometric pressure adjusted to sea level (QNH) for the region.
- (h) The MDA/H for a single-pilot ARA should be 100 ft higher than that calculated in accordance with (f) and (g) above. The decision range should not be less than 1 NM.
- (i) The approach system lateral path guidance should be capable of at least performance monitoring and alerting function of RNP 0.3 NM up to the missed approach point (MAPt, then RNP 1.0 NM to missed approach holding point.)
- (j) The horizontal flight path should be defined in accordance with the RNP capability of the approach system (e.g. offset no lower than the RNP capability).
- (k) The maximum acceptable offset angle between the final inbound course and the installation should be 30°.
- (l) Before commencing the final approach, the pilot-in-command/commander should ensure that a clear path exists on the radar screen for the final and missed approach segments. If lateral clearance from any obstacle is less than the navigation performance, the pilot-in-command/commander should:
 - (1) approach to a nearby target structure and thereafter proceed visually to the destination structure; or
 - (2) make the approach from another direction leading to a circling manoeuvre.

- (m) The minimum decision range (MDR) should not be less than 0.75 NM. The maximum acceptable GS at the MAPt for a 0.75-NM MDR should be 80 kt.
- (n) The segment from the MAPt to destination should not be flown in tailwind conditions. The approach course should be selectable accordingly.
- (o) The aircraft should have the capability to compare the airborne radar picture and GNSS range and bearing data to cross-check the position of the offshore location.

GM1 SPA.HOFO.125 Offshore standard approach procedures (OSAPs)

ED Decision 2022/012/R

AIRBORNE RADAR APPROACH (ARA)

- (a) General
 - (1) The helicopter ARA procedure may have as many as five separate segments: the arrival, initial, intermediate, final approach, and missed approach segment. In addition, the specifications of the circling manoeuvre to a landing under visual conditions should be considered. The individual approach segments can begin and end at designated fixes. However, the segments of an ARA may often begin at specified points where no fixes are available.
 - (2) The fixes, or points, are named to coincide with the beginning of the associated segment. For example, the intermediate segment begins at the intermediate fix (IF) and ends at the final approach fix (FAF). Where no fix is available or appropriate, the segments begin and end at specified points; for example, at the intermediate point (IP) and final approach point (FAP). The order in which the segments are discussed in this GM is the order in which the pilot would fly them in a complete procedure: that is, from the arrival through the initial and intermediate to the final approach and, if necessary, to the missed approach.
 - (3) Only those segments that are required by local conditions applying at the time of the approach need to be included in a procedure. In constructing the procedure, the final approach track, which should be orientated so as to be substantially into the wind, should be identified first as it is the least flexible and most critical of all the segments. When the origin and the orientation of the final approach have been determined, the other necessary segments should be integrated with it to produce an orderly manoeuvring pattern that does not generate an unacceptably high workload for the flight crew.
 - (4) Where an ARA is conducted to a non-moving offshore location (i.e. fixed installation or moored vessel), and a reliable global navigation satellite system (GNSS) position for the location is available, the GNSS/area navigation system should be used to enhance the safety of the ARA. This is achieved by using the GNSS/area navigation system to navigate the helicopter onto, and maintain, the final approach track, and by using the GNSS range and bearing information to cross-check the position of the offshore location on the weather radar display.
 - (5) Examples of ARA procedures, as well as vertical profile and missed approach procedures, are contained in Figures 1 and 2 below.

(b) Obstacle environment

- (1) Each segment of the ARA is located in an overwater area that has a flat surface at sea level. However, due to the passage of large vessels which are not required to notify their presence, the exact obstacle environment cannot be determined. As the largest vessels and structures are known to reach elevations exceeding 500 ft above mean sea level (AMSL), the uncontrolled offshore obstacle environment applying to the arrival, initial and intermediate approach segments can reasonably be assumed to be capable of reaching to at least 500 ft AMSL. Nevertheless, in the case of the final approach and missed approach segments, specific areas are involved within which no radar returns are allowed. In these areas, the height of wave crests, and the possibility that small obstacles may be present that are not visible on radar, results in an uncontrolled surface environment that extends to an elevation of 50 ft AMSL.
- (2) Information about movable obstacles should be requested from the arrival destination or adjacent installations.
- (3) Under normal circumstances, the relationship between the approach procedure and the obstacle environment is governed by the concept that vertical separation is very easy to apply during the arrival, initial and intermediate segments, while horizontal separation, which is much more difficult to guarantee in an uncontrolled environment, is applied only in the final and missed approach segments.

(c) Arrival segment

The arrival segment commences at the last en-route navigation fix, where the aircraft leaves the helicopter route, and it ends either at the initial approach fix (IAF) or, if no course reversal or similar manoeuvre is required, it ends at the IF. Standard en-route obstacle clearance criteria should be applied to the arrival segment.

(d) Initial approach segment

The initial approach segment is only required if the intermediate approach track cannot be joined directly. Most approaches will be flown direct to a point close to the IF, and then on to the final approach track, using GNSS/area navigation guidance. The segment commences at the IAF, and on completion of the manoeuvre, it ends at the IP. The minimum obstacle clearance (MOC) assigned to the initial approach segment is 1 000 ft.

(e) Intermediate approach segment

The intermediate approach segment commences at the IP, or in the case of straight-in approaches, where there is no initial approach segment, it commences at the IF. The segment ends at the FAP and should not be less than 2 nm in length. The purpose of the intermediate segment is to align the helicopter with the final approach track and prepare it for the final approach. During the intermediate segment, the helicopter should be lined up with the final approach track, the speed should be stabilised, the destination should be identified on the radar, and the final approach and missed approach areas should be identified and verified to be clear of radar returns. The MOC assigned to the intermediate segment is 500 ft.

(f) Final approach segment

- (1) The final approach segment commences at the FAP and ends at the missed approach point (MAPt). The final approach area, which should be identified on radar, takes the form of a corridor between the FAP and the radar return of the destination. This corridor should not be less than 2 nm wide so that the projected track of the helicopter does not pass closer than 1 nm to the obstacles lying outside the area.

- (2) On passing the FAP, the helicopter will descend below the intermediate approach altitude and follow a descent gradient which should not be steeper than 6.5 %. At this stage, vertical separation from the offshore obstacle environment will be lost. However, within the final approach area, the MDA/MDH will provide separation from the surface environment. Descent from 1 000 ft AMSL to 200 ft AMSL at a constant 6.5 % gradient will involve a horizontal distance of 2 nm. In order to follow the guideline that the procedure should not generate an unacceptably high workload for the flight crew, the required actions of levelling off at MDH, changing heading at the offset initiation point (OIP), and turning away at the MAPt, should not be planned to occur at the same time from the destination.
 - (3) During the final approach, compensation for drift should be applied, and the heading which, if maintained, would take the helicopter directly to the destination should be identified. It follows that at an OIP located at a range of 1.5 nm, a heading change of 10° is likely to result in a track offset of 15° at 1 nm, and the extended centre line of the new track can be expected to have a mean position approximately 300–400 m to one side of the destination structure. The safety margin built into the 0.75-nm decision range (DR) is dependent upon the rate of closure with the destination. Although the airspeed should be in the range of 60–90 KIAS during the final approach, the ground speed, after due allowance for wind velocity, should not be greater than 70 kt.
- (g) Missed approach segment
- (1) The missed approach segment commences at the MAPt and ends when the helicopter reaches the minimum en route altitude. The missed approach manoeuvre is a ‘turning missed approach’ which should be of not less than 30° and should not, normally, be greater than 45°. A turn away of more than 45° does not reduce the collision risk factor any further nor does it permit a closer DR. However, turns of more than 45° may increase the risk of pilot disorientation, and by inhibiting the rate of climb (especially in the case of an OEI missed approach procedure), may keep the helicopter at an extremely low level for longer than it is desirable.
 - (2) The missed approach area to be used should be identified and verified as a clear area on the radar screen during the intermediate approach segment. The base of the missed approach area is a sloping surface at 2.5 % gradient starting from MDH at the MAPt. The concept is that a helicopter executing a turning missed approach will be protected by the horizontal boundaries of the missed approach area until vertical separation of more than 130 ft is achieved between the base of the area and the offshore obstacle environment of 500 ft AMSL that prevails outside the area.
 - (3) A missed approach area, taking the form of a 45° sector orientated left or right of the final approach track, originating from a point 5 nm short of the destination, and terminating on an arc 3 nm beyond the destination, should normally satisfy the specifications of a 30° turning missed approach.
- (h) Required visual reference
- The visual reference required is that the destination should be in view in order to be able to carry out a safe landing.
- (i) Radar equipment
- During the ARA procedure, colour mapping radar equipment with a 120° sector scan and a 2.5-nm range scale selected may result in dynamic errors of the following order:

- (1) bearing/tracking error of $\pm 4.5^\circ$ with 95 % accuracy;
- (2) mean ranging error of 250 m; or
- (3) random ranging error of ± 250 m with 95 % accuracy.

Figure 1 — Horizontal profile

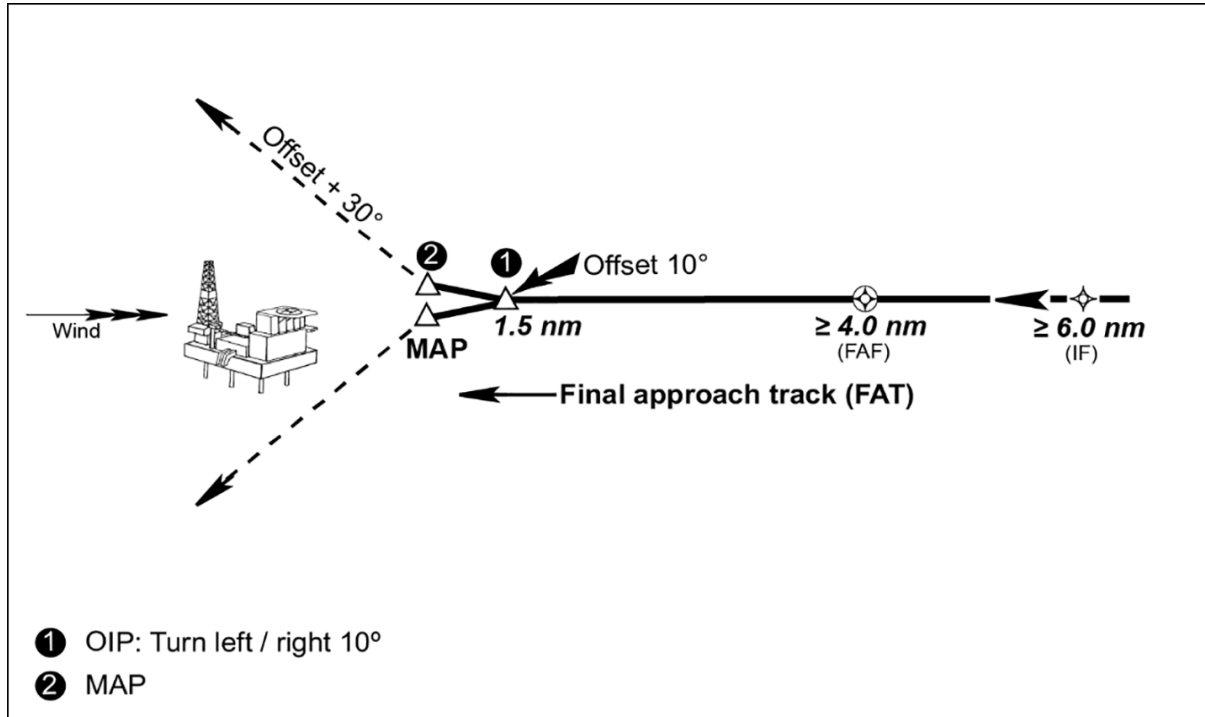
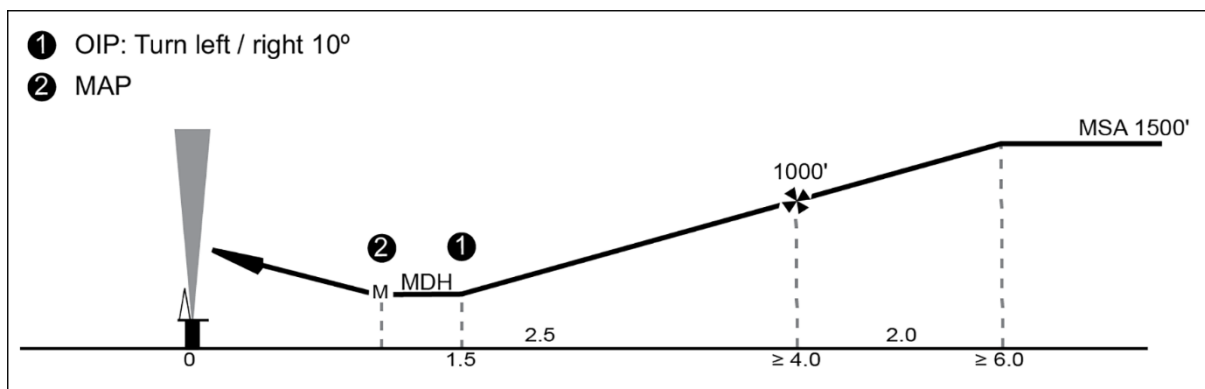

Figure 2 — Vertical profile



GM2 SPA.HOFO.125 Offshore standard approach procedures (OSAPs)

ED Decision 2022/012/R

GLOBAL NAVIGATION SATELLITE SYSTEM (GNSS)/AREA NAVIGATION SYSTEM — AIRBORNE RADAR APPROACH (ARA)

Where an ARA is conducted to a non-moving offshore location (i.e. fixed installation or moored vessel), and the GNSS/area navigation system is used to enhance the safety of the ARA, the following procedure or equivalent should be applied:

- (a) selection from the area navigation system database or manual entry of the offshore location;
- (b) manual entry of the final approach fix (FAF) or intermediate fix (IF), as a range of and bearing from the offshore location;
- (c) the full-scale deviation of the GNSS/area navigation system display should be in accordance with the expected navigation performance, and be no greater than 1 NM;
- (d) comparison of weather radar and GNSS range and bearing data to cross-check the position of the offshore location;
- (e) use of GNSS guidance to guide the aircraft onto the final approach track during the initial or intermediate approach segments;
- (f) use of GNSS guidance from the FAF towards the offset initiation point (OIP) during the final approach segment to establish the helicopter on the correct approach track and, hence, heading;
- (g) transition from GNSS guidance to navigation based on headings once the track is stabilised and before reaching OIP;
- (h) use of GNSS range of and bearing to the offshore location during the intermediate and final approach segments to cross-check weather radar information (for correct 'painting' of the destination and, hence, of other obstacles);
- (i) use of GNSS range of the offshore location to enhance confidence in the weather radar determination of arrival at the OIP and MAPt; and
- (j) use of GNSS range of and bearing to the destination to monitor separation from the offshore location.

AMC1 SPA.HOFO.125(g) Offshore standard approach procedures (OSAPs)

ED Decision 2022/012/R

TRAINING AND CHECKING FOR OSAPs

- (a) Initial training and checking for OSAPs should be conducted either as part of the operator's conversion course or as a separate equipment and procedure training, and should include all of the following:
 - (1) ground training, including knowledge of:
 - (i) the structure of the OSAP;
 - (ii) the airborne radar specifications, limitations, modes, and usage;
 - (iii) the area navigation system, as necessary for the envisaged OSAP;

- (2) aircraft/FSTD training, including all of the following:
 - (i) OSAPs to various offshore sites with and without obstacles or obstructions;
 - (ii) OSAPs in different wind conditions, followed by landings and go-arounds;
 - (iii) OSAPs in the pilot-monitoring, pilot-flying and single-pilot functions, by day and by night, as relevant to the kind of operations;
 - (3) LIFUS;
 - (4) line check.
- (b) The recurrent training and checking programme should include at least one OSAP per year in the pilot-monitoring, pilot-flying and single-pilot functions as relevant to the kind of operations. OSAPs should be part of the annual aircraft/FSTD training, the line check or the operator's proficiency check. Checking is not necessary if training to proficiency is employed.

SPA.HOFO.130 Meteorological conditions

Regulation (EU) 2016/1199

Notwithstanding [CAT.OP.MPA.247](#), [NCC.OP.180](#) and [SPO.OP.170](#), when flying between offshore locations located in class G airspace where the overwater sector is less than 10 NM, VFR flights may be conducted when the limits are at, or better than, the following:

Minima for flying between offshore locations located in class G airspace				
	Day		Night	
	Height*	Visibility	Height*	Visibility
Single pilot	300 feet	3 km	500 feet	5 km
Two pilots	300 feet	2 km**	500 feet	5 km***

* The cloud base shall allow flight at the specified height to be below and clear of cloud.

** Helicopters may be operated in flight visibility down to 800 m, provided the destination or an intermediate structure is continuously visible.

*** Helicopters may be operated in flight visibility down to 1 500 m, provided the destination or an intermediate structure is continuously visible.

SPA.HOFO.135 Wind limitations for operations to offshore locations

Regulation (EU) 2016/1199

Operation to an offshore location shall only be performed when the wind speed at the helideck is reported to be not more than 60 knots including gusts.

SPA.HOFO.140 Performance requirements at offshore locations

Regulation (EU) 2016/1199

Helicopters taking off from and landing at offshore locations shall be operated in accordance with the performance requirements of the appropriate Annex according to their type of operation.

AMC1 SPA.HOFO.140 Performance requirements – take-off and landing at offshore locations

ED Decision 2016/022/R

FACTORS

To ensure that the necessary factors are taken into account, operators not conducting CAT operations should use take-off and landing procedures that are appropriate to the circumstances and have been developed in accordance with [ORO.MLR.100](#) in order to minimise the risks of collision with obstacles at the individual offshore location under the prevailing conditions.

SPA.HOFO.145 Flight data monitoring (FDM) system

Regulation (EU) 2016/1199

- (a) When conducting CAT operations with a helicopter equipped with a flight data recorder, the operator shall establish and maintain a FDM system, as part of its integrated management system, by 1 January 2019.
- (b) The FDM system shall be non-punitive and contain adequate safeguards to protect the source(s) of the data.

AMC1 SPA.HOFO.145 Flight data monitoring (FDM) programme

ED Decision 2021/005/R

FDM PROGRAMME

Refer to [AMC1 ORO.AOC.130](#).

GM1 SPA.HOFO.145 Flight data monitoring (FDM) programme

ED Decision 2016/022/R

DEFINITION OF AN FDM PROGRAMME

Refer to [GM1 ORO.AOC.130](#), except for the examples that are specific to aeroplane operation.

GM2 SPA.HOFO.145 Flight data monitoring (FDM) programme

ED Decision 2021/008/R

ADDITIONAL GUIDANCE AND INDUSTRY GOOD PRACTICE

- (a) Additional guidance material for the establishment of an FDM programme can be found in:
 - (1) International Civil Aviation Organization (ICAO) Doc 10000 — Manual on Flight Data Analysis Programmes (FDAP); and
 - (2) United Kingdom Civil Aviation Authority (UK CAA) CAP 739 — Flight Data Monitoring.
- (b) Examples of industry good practice for the establishment of FDM can be found in:
 - (1) HeliOffshore— Helicopter Flight Data Monitoring (HFDM) Recommended Practice for Oil and Gas Passenger Transport Operations, Version 1.0, September 2020 (HO-HFDM-RP-v1.0);
 - (2) European Operators Flight Data Monitoring forum (EOFDM) — Preparing a memorandum of understanding for an FDM programme;

- (3) EOFDM — Best practice document: Key performance indicators for a Flight Data Monitoring programme; and
 - (4) EOFDM — ‘Breaking the silos’, Fully integrating Flight Data Monitoring into the Safety Management System.
- (c) Table 1 provides examples of FDM event definitions that may be further developed using operator- and helicopter-specific limits. This table is considered illustrative and non-exhaustive. Appendix 5 to HO-HFDM-RP-v1.0 contains other examples of FDM event definitions. More important than the number of FDM event definitions that are programmed in the FDM software is that those definitions cover, as much as practicable, the operational risks that have been identified by the operator.

Table 1 — Examples of FDM event definitions

Event title/description	Parameters required	Comments
Ground		
Outside air temperature (OAT) high — Operating limits	OAT	To identify when the helicopter is operated at the limits of OAT.
Sloping-ground high-pitch attitude	Pitch attitude, ground switch (similar)	To identify when the helicopter is operated at the slope limits.
Sloping-ground high-roll attitude	Roll attitude, ground switch (similar)	To identify when the helicopter is operated at the slope limits.
Rotor brake on at an excessive number of rotations (main rotor speed) (NR)	Rotor brake discreet, NR	To identify when the rotor brake is applied at too high NR.
Ground taxiing speed — max	Ground speed (GS), ground switch (similar)	To identify when the helicopter is ground taxied at high speed (wheeled helicopters only).
Air taxiing speed — max	GS, ground switch (similar), radio altitude (Rad Alt)	To identify when the helicopter is air taxied at high speed.
Excessive power during ground taxiing	Total torque (Tq), ground switch (similar), GS	To identify when excessive power is used during ground taxiing.
Pedal — max left-hand (LH) and right-hand (RH) taxiing	Pedal position, ground switch (similar), GS or NR	To identify when the helicopter flight controls (pedals) are used to excess on the ground. GS or NR to exclude control test prior to rotor start.
Excessive yaw rate on ground during taxiing	Yaw rate, ground switch (similar), or Rad Alt	To identify when the helicopter yaws at a high rate when on the ground.
Yaw rate in hover or on ground	Yaw rate, GS, ground switch (similar)	To identify when the helicopter yaws at a high rate when in a hover.
High lateral acceleration (rapid cornering)	Lateral acceleration, ground switch (similar)	To identify high levels of lateral acceleration, when ground taxiing, that indicate high cornering speed.

Event title/description	Parameters required	Comments
High longitudinal acceleration (rapid braking)	Longitudinal acceleration, ground switch (similar)	To identify high levels of longitudinal acceleration, when ground taxiing, that indicate excessive braking.
Cyclic-movement limits during taxiing (pitch or roll)	Cyclic stick position, ground switch (similar), Rad Alt, NR or GS	To identify excessive movement of the rotor disc when running on ground. GS or NR to exclude control test prior to rotor start.
Excessive longitudinal and lateral cyclic rate of movement on ground	Longitudinal cyclic pitch rate, lateral cyclic pitch rate, NR	To detect an excessive rate of movement of cyclic control when on the ground with rotors running.
Lateral cyclic movement — closest to LH and RH rollover	Lateral cyclic position, pedal position, roll attitude, elapsed time, ground switch (similar)	To detect the risk of a helicopter rollover due to an incorrect combination of tail rotor pedal position and lateral cyclic control position when on ground.
Excessive cyclic control with insufficient collective pitch on ground	Collective pitch, longitudinal cyclic pitch, lateral cyclic pitch	To detect an incorrect taxiing technique likely to cause rotor head damage.
Inadvertent lift-off	Ground switch (similar), autopilot discreet	To detect inadvertent lifting into hover.
Flight — Take-off and landing		
Day or night landing or take-off	Latitude and Longitude (Lat & Long), local time or UTC	To provide day/night relevance to detected events.
Specific location of landing or take-off	Lat & Long, ground switch (similar), Rad Alt, total Tq	To give contextual information concerning departures and destinations.
Gear extension and retraction — airspeed limit	Indicated airspeed (IAS), gear position	To identify when undercarriage airspeed limitations are breached.
Gear extension & retraction — height limit	Gear position, Rad Alt	To identify when undercarriage altitude limitations are breached.
Heavy landing	Normal/vertical acceleration, ground switch (similar)	To identify when hard/heavy landings take place.
Cabin heater on (take-off and landing)	Cabin heater discreet, ground switch (similar)	To identify use of engine bleed air during periods of high power demand.
High GS prior to touchdown (TD)	GS, Rad Alt, ground switch (similar), elapsed time, latitude, longitude	To assist in the identification of ‘quick stop’ approaches.
Flight — Speed		
High airspeed — with power	IAS, Tq 1, Tq 2, pressure altitude (Palt), OAT	To identify excessive airspeed in flight.
High airspeed — low altitude	IAS, Rad Alt	To identify excessive airspeed in low-level flight.
Low airspeed at altitude	IAS, Rad Alt	To identify a ‘hover out of ground’ effect.
Airspeed on departure (< 300 ft)	IAS, ground switch (similar), Rad Alt	To identify shallow departure.
High airspeed — power off	IAS, Tq 1, Tq 2 or one engine inoperative (OEI) discreet, Palt, OAT	To identify limitation exceedance of power-off airspeed.
Downwind flight within 60 sec of take-off	IAS, GS, elapsed time	To detect early downwind turn after take-off.
Downwind flight within 60 sec of landing	IAS, GS, elapsed time	To detect late turn to final shortly before landing.

Event title/description	Parameters required	Comments
Flight — Height		
Altitude — max	Palt	To detect flight outside of the published flight envelope.
Climb rate — max	Vertical speed (V/S), or Palt, or Rad Alt, Elapsed time	Identification of excessive rates of climb (RoC) can be determined from an indication/rate of change of Palt or Rad Alt.
High rate of descent	V/S	To identify excessive rates of descent (RoD).
High rate of descent (speed or height limit)	V/S, IAS or Rad Alt or elevation	To identify RoD at low level or low speed.
Settling with power (vortex ring)	V/S, IAS, GS, Tq	To detect high-power settling with low speed and with excessive rate of descent.
Minimum altitude in autorotation	NR, total Tq, Rad Alt	To detect late recovery from autorotation.
Low cruising (inertial systems)	GS, V/S, elevation, Lat & Long	To detect an extended low-level flight. Ground speed is less accurate with more false alarms. Lat & Long used for geographical boundaries.
Low cruising (integrated systems)	Rad Alt, elapsed time, Lat & Long, ground switch (similar)	To detect an extended low-level flight.
Flight — Attitude and controls		
Excessive pitch (height related — turnover (T/O), cruising or landing)	Pitch attitude, Rad Alt elevation, Lat & Long	To identify inappropriate use of excessive pitch attitude during flight. Height limits may be used (i.e. on take-off and landing or < 500 ft) — Lat & Long required for specific-location-related limits. Elevation less accurate than Rad Alt. Elevation can be used to identify the landing phase in a specific location.
Excessive pitch (speed related — T/O, cruising or landing)	Pitch attitude, IAS, GS, Lat & Long	To identify inappropriate use of excessive pitch attitude during flight. Speed limits may be used (i.e. on take-off and landing or in cruising) — Lat & Long required for specific-location-related limits. GS less accurate than IAS.
Excessive pitch rate	Pitch rate, Rad Alt, IAS, ground switch (similar), Lat & Long	To identify inappropriate use of excessive rate of pitch change during flight. Height limits may be used (i.e. on take-off and landing). IAS only for IAS limit, ground switch (similar) and Lat & Long required for specific-location-related limits.
Excessive roll/bank attitude (speed or height related)	Roll attitude, Rad Alt, IAS/GS	To identify excessive use of roll attitude. Rad Alt may be used for height limits, IAS/GS may be used for speed limits.
Excessive roll rate	Roll rate, Rad Alt, Lat & Long, Ground switch (similar)	Rad Alt may be used for height limits, Lat & Long and ground switch (similar) required for specific-location-related and air/ground limits.
Excessive yaw rate	Yaw rate	To detect excessive yaw rates in flight.

Event title/description	Parameters required	Comments
Excessive lateral cyclic control	Lateral cyclic position, ground switch (similar)	To detect movement of the lateral cyclic control to extreme left or right positions. Ground switch (similar) required for pre or post T/O.
Excessive longitudinal cyclic control	Longitudinal cyclic position, ground switch (similar)	To detect movement of the longitudinal cyclic control to extreme forward or aft positions. Ground switch (similar) required for pre or post T/O.
Excessive collective pitch control	Collective position, ground switch (similar)	To detect exceedances of the aircraft flight manual (AFM) collective pitch limit. Ground switch (similar) required for pre or post T/O.
Excessive tail rotor control	Pedal position, ground switch (similar)	To detect movement of the tail rotor pedals to extreme left and right positions. Ground switch (similar) required for pre or post T/O.
Manoeuvre G loading or turbulence	Lat & Long, normal accelerations, ground switch (similar) or Rad Alt	To identify excessive G loading of the rotor disc, both positive and negative. Ground switch (similar) required to determine air/ground. Rad Alt required if height limit required.
Pilot workload/turbulence	Collective and/or cyclic and/or tail rotor pedal position and change rate (Lat & Long)	To detect high workload and/or turbulence encountered during take-off and landing phases. Lat & Long required for specific landing sites. A specific and complicated algorithm for this event is required. See United Kingdom Civil Aviation Authority (UK CAA) Paper 2002/02.
Cross controlling	Roll rate, yaw rate, pitch rate, GS, accelerations	To detect an 'out of balance' flight. Airspeed could be used instead of GS.
Quick stop	GS (min and max), V/S, pitch	To identify inappropriate flight characteristics. Airspeed could be used instead of GS.
Flight — General		
OEI — Air	OEI discreet, ground switch (similar)	To detect OEI conditions in flight.
Single engine flight	No 1 engine Tq, No 2 engine Tq	To detect single-engine flight.
Torque split	No 1 engine Tq, No 2 engine Tq	To identify engine-related issues.
Pilot event	Pilot event discreet	To identify when flight crews have depressed the pilot event button.
Traffic collision avoidance system (TCAS) traffic advisory (TA)	TCAS TA discreet	To identify TCAS alerts.
Training computer active	Training computer mode active or discreet	To identify when helicopter have been on training flights.
High/low rotor speed — power on	NR, Tq (ground switch (similar), IAS, GS)	To identify mishandling of NR. Ground switch (similar), IAS or ground speed required to determine whether helicopter is airborne.

Event title/description	Parameters required	Comments
High/low rotor speed — power off	NR, Tq (ground switch (similar), IAS, GS)	To identify mishandling of NR. Ground switch (similar), IAS or ground speed to determine whether helicopter is airborne.
Fuel content low	Fuel contents	To identify low-fuel alerts.
Helicopter terrain awareness and warning system (HTAWS) alert	HTAWS alerts discreet	To identify when HTAWS alerts have been activated.
Automatic voice alert device (AVAD) alert	AVAD discreet	To identify when AVAD alerts have been activated.
Bleed air system use during take-off (e.g. heating)	Bleed air system discreet, ground switch (similar), IAS	To identify use of engine bleed air during periods of high power demand.
Rotors' running duration	NR, elapsed time	To identify rotors' running time for billing purposes.
Flight — Approach		
Stable approach heading change	Magnetic heading, Rad Alt, ground switch (similar), gear position, elapsed time	To identify unstable approaches.
Stable approach pitch attitude	Pitch attitude, Rad Alt, ground switch (similar), gear position	To identify unstable approaches.
Stable approach rod GS	Altitude rate, Rad Alt, ground switch (similar), gear position	To identify unstable approaches.
Stable approach track change	Track, Rad Alt, ground switch (similar), gear position	To identify unstable approaches.
Stable approach angle of bank	Roll attitude, Rad Alt, ground switch (similar), gear position	To identify unstable approaches.
Stable approach — rod at specified height	Altitude rate, Rad Alt, ground switch (similar), gear position	To identify unstable approaches.
Stable approach — IAS at specified height	IAS, Rad Alt, ground switch (similar), gear position	To identify unstable approaches.
Glideslope deviation above or below	Glideslope deviation	To identify inaccurately flown instrument landing system (ILS) approaches.
Localiser deviation left and right	Localiser deviation	To identify inaccurately flown ILS approaches.
Low turn to final	Elevation, GS, V/S, heading change	Airspeed could be used instead of GS.
Premature turn to final	Elevation, GS, V/S, heading change	Airspeed could be used instead of GS.
Stable approach — climb	IAS (min & max), V/S (min & max), elevation	To identify unstable approaches.
Stable approach — descent	IAS (min & max), V/S, elevation	To identify unstable approaches.
Stable approach — bank	IAS (min & max), V/S, elevation, roll	To identify unstable approaches.
Stable approach — late turn	Heading change, elevation, GS	To identify unstable approaches.
Go-around	Gear select (Rad Alt)	To identify missed approaches. Rad Alt for height limit.
Rate of descent on approach	Altitude rate, Rad Alt, Lat & Long, ground switch (similar)	To identify high rates of descent when at low level on approach. Rad Alt if below specified height, Lat & Long for specified location required.

Event title/description	Parameters required	Comments
Flight — Autopilot		
Condition of autopilot in flight	Autopilot discreet	To detect flight without autopilot engaged; per channel for multichannel autopilots.
Autopilot engaged within 10 sec after take-off	Autopilot engaged discreet, elapsed time, ground switch (similar), total Tq, Rad Alt	To identify inadvertent lift-off without autopilot engaged.
Autopilot engaged on ground (postflight or preflight)	Autopilot engaged discreet, elapsed time, ground switch (similar), total Tq, Rad Alt	To identify inappropriate use of autopilot when on ground. Elapsed time required to allow for permissible short periods.
Excessive pitch attitude with autopilot engaged on ground (offshore)	Pitch attitude, autopilot discreet, ground switch (similar), Lat & Long	To identify potential for low NR when helicopter pitches on floating helideck.
Airspeed hold engaged — airspeed (departure or non-departure)	Autopilot modes discreet, IAS, (ground switch (similar), total Tq, Rad Alt)	To detect early engagement of autopilot higher modes. Ground switch (similar), total Tq and Rad Alt to determine if the flight profile is 'departure'.
Airspeed hold engaged — altitude (departure or non-departure)	Autopilot modes discreet, Rad Alt, (IAS, ground switch (similar), total Tq)	To detect early engagement of autopilot higher modes. IAS, ground switch (similar), total Tq to determine if the flight profile is 'departure'.
Alt mode engaged — altitude (departure or non-departure)	Autopilot modes discreet, Rad Alt, (ground switch (similar), total Tq, IAS)	To detect early engagement of autopilot higher modes. Ground switch (similar), total Tq and Rad Alt to determine if the flight profile is 'departure'.
Alt mode engaged — airspeed (departure or non-departure)	Autopilot modes discreet, IAS, (ground switch (similar), total Tq, Rad Alt)	To detect early engagement of autopilot higher modes. IAS, ground switch (similar), total Tq to determine if the flight profile is 'departure'.
Heading mode engaged — speed	Autopilot modes discreet, IAS	To detect engagement of autopilot higher modes below minimum speed limitations. Ground switch (similar), total Tq and Rad Alt to determine if the flight profile is 'departure'.
V/S mode active — below specified speed	Autopilot modes discreet, IAS	To detect engagement of autopilot higher modes below minimum speed limitations.
VS mode engaged — altitude (departure or non-departure)	Autopilot modes discreet, IAS, (WOW, total Tq, Rad Alt)	To detect early engagement of autopilot higher modes. Ground switch (similar), total Tq and Rad Alt to determine if the flight profile is 'departure'.
Flight director (FD) engaged — speed	FD discreet, IAS	To detect engagement of autopilot higher modes below minimum speed limitations.
FD-coupled approach or take off — airspeed	FD discreet, IAS, ground switch (similar)	To detect engagement of autopilot higher modes below minimum speed limitations.
Go-around mode engaged — airspeed	Autopilot modes discreet, IAS, ground switch (similar), total Tq, Rad Alt	To detect engagement of autopilot higher modes below minimum speed limitations.
Flight without autopilot channels engaged	Autopilot channels	To detect flight without autopilot engaged; per channel for multichannel autopilots.

SPA.HOFO.150 Aircraft tracking system

Regulation (EU) 2016/1199

An operator shall establish and maintain a monitored aircraft tracking system for offshore operations in a hostile environment from the time the helicopter departs until it arrives at its final destination.

AMC1 SPA.HOFO.150 Aircraft tracking system

ED Decision 2016/022/R

GENERAL

Flights should be tracked and monitored from take-off to landing. This function may be achieved by the air traffic services (ATS) when the planned route and the planned diversion routes are fully included in airspace blocks where:

- (a) ATS surveillance service is normally provided and supported by ATC surveillance systems locating the aircraft at time intervals with adequate duration; and
- (b) the operator has given to competent air navigation services (ANS) providers the necessary contact information.

In all other cases, the operator should establish a detailed procedure describing how the aircraft tracking system is to be monitored, and what actions and when are to be taken if a deviation or anomaly has been detected.

GM1 SPA.HOFO.150 Aircraft tracking system

ED Decision 2016/022/R

OPERATIONAL PROCEDURE

The procedure should take into account the following aspects:

- (a) the outcome of the risk assessment made when the update frequency of the information was defined;
- (b) the local environment of the intended operations; and
- (c) the relationship with the operator's emergency response plan.

Aircraft tracking data should be recorded on the ground and retained for at least 48 h. Following an accident or a serious incident subject to investigation, the data should be retained for at least 30 days, and the operator should be capable of providing a copy of this data without delay.

SPA.HOFO.155 Vibration health monitoring (VHM) system

Regulation (EU) 2016/1199

- (a) The following helicopters conducting CAT offshore operations in a hostile environment shall be fitted with a VHM system capable of monitoring the status of critical rotor and rotor drive systems by 1 January 2019:
 - (1) complex motor-powered helicopters first issued with an individual Certificate of Airworthiness (CofA) after 31 December 2016;
 - (2) all helicopters with a maximum operational passenger seating configuration (MOPSC) of more than 9 and first issued with an individual CofA before 1 January 2017;
 - (3) all helicopters first issued with an individual CofA after 31 December 2018.

- (b) The operator shall have a system to:
- (1) collect the data including system generated alerts;
 - (2) analyse and determine component serviceability; and
 - (3) respond to detected incipient failures.

AMC1 SPA.HOFO.155 Vibration health monitoring (VHM) system

ED Decision 2016/022/R

GENERAL

Any VHM system should meet all of the following criteria:

(a) VHM system capability

The VHM system should measure vibration characteristics of rotating critical components during flight, using suitable vibration sensors, techniques, and recording equipment. The frequency and flight phases of data measurement should be established together with the type certificate holder (TCH) during the initial entry into service. In order to appropriately manage the generated data and focus upon significant issues, an alerting system should be established; this is normally automatic. Accordingly, alert generation processes should be developed to reliably advise maintenance personnel of the need to intervene and help determine what type of intervention is required.

(b) Approval of VHM installation

The VHM system, which typically comprises vibration sensors and associated wiring, data acquisition and processing hardware, the means of downloading data from the helicopter, the ground-based system and all associated instructions for operation of the system, should be certified in accordance with CS-29 or equivalent, established by the Agency.

Note: for applications that may also provide maintenance credit (see Federal Aviation Administration (FAA) Advisory Circular (AC) 29-2C Miscellaneous Guidance (MG) 15), the level of system integrity required may be higher.

(c) Operational procedures

The operator should establish procedures to address all necessary VHM subjects.

(d) Training

The operator should determine which staff will require VHM training, determine appropriate syllabi, and incorporate them into the operator's initial and recurrent training programmes.

GM1 SPA.HOFO.155 Vibration health monitoring (VHM) system

ED Decision 2016/022/R

GENERAL

Operators should utilise available international guidance material provided for the specification and design of VHM systems.

Further guidance can be found in:

- (a) CS 29.1465 Vibration health monitoring and associated AMC;

- (b) Federal Aviation Administration (FAA) Advisory Circular (AC) 29-2C Miscellaneous Guidance (MG) 15 — Airworthiness Approval of Rotorcraft Health Usage Monitoring Systems (HUMSs); and
- (c) United Kingdom Civil Aviation Authority (UK CAA) CAP 753 — Helicopter Vibration Health Monitoring.

SPA.HOFO.160 Equipment requirements

Regulation (EU) 2016/1199

- (a) The operator shall comply with the following equipment requirements:
 - (1) Public Address (PA) system in helicopters used for CAT and non-commercial operations with complex motor-powered helicopters (NCC):
 - (i) Helicopters with a maximum operational passenger seat configuration (MOPSC) of more than 9 shall be equipped with a PA system.
 - (ii) Helicopters with an MOPSC of 9 or less need not be equipped with a PA system if the operator can demonstrate that the pilot's voice is understandable at all passengers' seats in flight.
 - (2) *Radio altimeter*

Helicopters shall be equipped with a radio altimeter that is capable of emitting an audio warning below a pre-set height and a visual warning at a height selectable by the pilot.
- (b) *Emergency exits*

All emergency exits, including crew emergency exits, and any door, window or other opening that is suitable for emergency egress, and the means for opening them shall be clearly marked for the guidance of occupants using them in daylight or in the dark. Such markings shall be designed to remain visible if the helicopter is capsized or the cabin is submerged.
- (c) *Helicopter terrain awareness warning system (HTAWS)*

Helicopters used in CAT operations with a maximum certificated take-off mass of more than 3 175 kg or a MOPSC of more than 9 and first issued with an individual CofA after 31 December 2018 shall be equipped with an HTAWS that meets the requirements for class A equipment as specified in an acceptable standard.

GM1 SPA.HOFO.160(a)(1) Additional equipment requirements

ED Decision 2016/022/R

PUBLIC ADDRESS (PA) SYSTEM

When demonstrating the performance of the PA system or that the pilot's voice is understandable at all passengers' seats during flight, the operator should ensure compatibility with the passengers' use of ear defenders/ear plugs (hearing protection). The operator should only provide hearing protection that is compatible with the intelligibility of the PA system or pilot's voice, as appropriate.

GM1 SPA.HOFO.160(a)(2) Additional equipment requirements

ED Decision 2016/022/R

RADIO ALTIMETER

For additional information, please refer to [AMC1 CAT.IDE.H.145](#) Radio altimeters and [AMC2 CAT.IDE.H.145](#) Radio altimeters, as well as to [GM1 CAT.IDE.H.145](#) Radio altimeters.

SPA.HOFO.165 Additional procedures and equipment for operations in a hostile environment

Regulation (EU) 2016/1199

(a) *Life jackets*

Approved life jackets shall be worn at all times by all persons on board unless integrated survival suits that meet the combined requirement of the survival suit and life jacket are worn.

(b) *Survival suits*

All passengers on board shall wear an approved survival suit:

- (1) when the weather report or forecasts available to the commander/pilot-in-command indicate that the sea temperature will be less than plus 10 °C during the flight; or
- (2) when the estimated rescue time exceeds the calculated survival time; or
- (3) when the flight is planned to be conducted at night.

(c) *Emergency breathing system*

All persons on board shall carry and be instructed in the use of emergency breathing systems.

(d) *Life rafts*

- (1) All life rafts carried shall be installed so as to be usable in the sea conditions in which the helicopter's ditching, flotation, and trim characteristics were evaluated for certification.
- (2) All life rafts carried shall be installed so as to facilitate their ready use in an emergency.
- (3) The number of life rafts installed:
 - (i) in the case of a helicopter carrying less than 12 persons, at least one life raft with a rated capacity of not less than the maximum number of persons on board; or
 - (ii) in the case of a helicopter carrying more than 11 persons, at least two life rafts, sufficient together to accommodate all persons capable of being carried on board and, if one is lost, the remaining life raft(s) having the overload capacity sufficient to accommodate all persons on the helicopter.
- (4) Each life raft shall contain at least one survival emergency locator transmitter (ELT(S)); and
- (5) Each life raft shall contain life-saving equipment, including means of sustaining life, as appropriate to the flight to be undertaken.

(e) *Emergency cabin lighting*

The helicopter shall be equipped with an emergency lighting system with an independent power supply to provide a source of general cabin illumination to facilitate the evacuation of the helicopter.

(f) *Automatically deployable emergency locator transmitter (ELT(AD))*

The helicopter shall be equipped with an ELT(AD) that is capable of transmitting simultaneously on 121,5 MHz and 406 MHz.

(g) *Securing of non-jettisonable doors*

Non-jettisonable doors that are designated as ditching emergency exits shall have a means of securing them in the open position so that they do not interfere with the occupants' egress in all sea conditions up to the maximum sea conditions required to be evaluated for ditching and flotation.

(h) *Emergency exits and escape hatches*

All emergency exits, including crew emergency exits, and any door, window or other opening suitable to be used for the purpose of underwater escape shall be equipped so as to be operable in an emergency.

(i) Notwithstanding (a), (b) and (c) above the operator may, based on a risk assessment, allow passengers, medically incapacitated at an offshore location, to partly wear or not wear life jackets, survival suits or emergency breathing systems on return flights or flights between offshore locations.

AMC1 SPA.HOFO.165(c) Additional procedures and equipment for operations in hostile environment

ED Decision 2016/022/R

EMERGENCY BREATHING SYSTEM (EBS)

The EBS of [SPA.HOFO.165\(c\)](#) should be an EBS system capable of rapid underwater deployment.

AMC1 SPA.HOFO.165(d) Additional procedures and equipment for operations in hostile environment

ED Decision 2016/022/R

INSTALLATION OF THE LIFE RAFT

- (a) Projections on the exterior surface of the helicopter that are located in a zone delineated by boundaries that are 1.22 m (4 ft) above and 0.61 m (2 ft) below the established static waterline could cause damage to a deployed life raft. Examples of projections that need to be considered are aerials, overboard vents, unprotected split-pin tails, guttering, and any projection sharper than a three-dimensional right-angled corner.
- (b) While the boundaries specified in (a) above are intended as a guide, the total area that should be considered should also take into account the likely behaviour of the life raft after deployment in all sea states up to the maximum in which the helicopter is capable of remaining upright.
- (c) Wherever a modification or alteration is made to a helicopter within the boundaries specified, the need to prevent the modification or alteration from causing damage to a deployed life raft should be taken into account in the design.
- (d) Particular care should also be taken during routine maintenance to ensure that additional hazards are not introduced by, for example, leaving inspection panels with sharp corners proud of the surrounding fuselage surface, or by allowing door sills to deteriorate to a point where their sharp edges may become a hazard.

AMC1 SPA.HOFO.165(h) Additional procedures and equipment for operations in a hostile environment

ED Decision 2016/022/R

EMERGENCY EXITS AND ESCAPE HATCHES

In order for all passengers to escape from the helicopter within an expected underwater survival time of 60 sec in the event of capsizing, the following provisions should be made:

- (a) there should be an easily accessible emergency exit or suitable opening for each passenger;
- (b) an opening in the passenger compartment should be considered suitable as an underwater escape facility if the following criteria are met:
 - (1) the means of opening should be rapid and obvious;
 - (2) passenger safety briefing material should include instructions on the use of such escape facilities;
 - (3) for the egress of passengers with shoulder width of 559 mm (22 in.) or smaller, a rectangular opening should be no smaller than 356 mm (14 in.) wide, with a diagonal between corner radii no smaller than 559 mm (22 in.), when operated in accordance with the instructions;
 - (4) non-rectangular or partially obstructed openings (e.g. by a seat back) should be capable of admitting an ellipse of 559 mm x 356 mm (22 in. x 14 in.); and
 - (5) for the egress of passengers with shoulder width greater than 559 mm (22 in.), openings should be no smaller than 480 mm x 660 mm (19 in. x 26 in.) or be capable of admitting an ellipse of 480 mm x 660 mm (19 in. x 26 in.);
- (c) suitable openings and emergency exits should be used for the underwater escape of no more than two passengers, unless large enough to permit the simultaneous egress of two passengers side by side:
 - (1) if the exit size provides an unobstructed area that encompasses two ellipses of size 480 mm x 660 mm (19 in. x 26 in.) side by side, then it may be used for four passengers; and
 - (2) if the exit size provides an unobstructed area that encompasses two ellipses of size 356 mm x 559 mm (14 in. x 22 in.) side by side, then it may be used for four passengers with shoulder width no greater than 559 mm (22 in.) each; and
- (d) passengers with shoulder width greater than 559 mm (22 in.) should be identified and allocated to seats with easy access to an emergency exit or opening that is suitable for them.

GM1 SPA.HOFO.165(h) Additional procedures and equipment for operations in a hostile environment

ED Decision 2016/022/R

SEAT ALLOCATION

The identification and seating of the larger passengers might be achieved through the use of patterned and/or colour-coded armbands and matching seat headrests.

AMC1 SPA.HOFO.165(i) Additional procedures and equipment for operations in a hostile environment

ED Decision 2016/022/R

MEDICALLY INCAPACITATED PASSENGER

- (a) A 'Medically incapacitated passenger' means a person who is unable to wear the required survival equipment, including life jackets, survival suits and emergency breathing systems (EBSs), as determined by a medical professional. The medical professional's determination should be made available to the pilot-in-command/commander prior to arrival at the offshore installation.
- (b) The operator should establish procedures for the cases where the pilot-in-command/commander may accept a medically incapacitated passenger not wearing or partially wearing survival equipment. To ensure proportionate mitigation of the risks associated with an evacuation, the procedures should be based on, but not be limited to, the severity of the incapacitation, sea and air temperature, sea state, and number of passengers on board.

In addition, the operator should establish the following procedures:

- (1) under which circumstances one or more dedicated persons are required to assist a medically incapacitated passenger during a possible emergency evacuation, and the skills and qualifications required;
- (2) seat allocation for the medically incapacitated passenger and possible assistants in the helicopter types used to ensure optimum use of the emergency exits; and
- (3) evacuation procedures related to whether or not the dedicated persons as described in (1) above are present.

SPA.HOFO.170 Crew requirements

Regulation (EU) 2016/1199

- (a) The operator shall establish:
- (1) criteria for the selection of flight crew members, taking into account the flight crew members' previous experience;
 - (2) a minimum experience level for a commander/pilot-in-command intending to conduct offshore operations; and
 - (3) a flight crew training and checking programme that each flight crew member shall complete successfully. Such programme shall be adapted to the offshore environment and include normal, abnormal and emergency procedures, crew resource management, water entry and sea survival training.

(b) *Recency requirements*

A pilot shall only operate a helicopter carrying passengers:

- (1) at an offshore location, as commander or pilot-in-command, or co-pilot, when he or she has carried out in the preceding 90 days at least 3 take-offs, departures, approaches and landings at an offshore location in a helicopter of the same type or a full flight simulator (FFS) representing that type; or
- (2) by night at an offshore location, as commander or pilot-in-command, or co-pilot, when he/she has carried out in the preceding 90 days at least 3 take-offs, departures,

approaches and landings at night at an offshore location in a helicopter of the same type or an FFS representing that type.

The 3 take-offs and landings shall be performed in either multi-pilot or single-pilot operations, depending on the operation to be performed.

- (c) Specific requirements for CAT:
- (1) The 90-day period presented in points (b)(1) and (2) above may be extended to 120 days as long as the pilot undertakes line flying under the supervision of a type rating instructor or examiner.
 - (2) If the pilot does not comply with the requirements in (1), he/she shall complete a training flight in the helicopter or an FFS of the helicopter type to be used, which shall include at least the requirements described in (b)(1) and (2) before he or she can exercise his or her privileges.

AMC1 SPA.HOFO.170(a) Crew requirements

ED Decision 2016/022/R

FLIGHT CREW TRAINING AND CHECKING

- (a) Flight crew training programmes should:
- (1) improve knowledge of the offshore operations environment with particular consideration of visual illusions during approach, introduced by lighting, motion and weather factors;
 - (2) improve crew cooperation specifically for offshore operations;
 - (3) provide flight crew members with the necessary skills to appropriately manage the risks associated with normal, abnormal and emergency procedures during flights by day and night;
 - (4) if night operations are conducted, give particular consideration to approach, go-around, landing, and take-off phases;
 - (5) include instructions on the optimum use of the helicopter's automatic flight control system (AFCS);
 - (6) for multi-pilot operation, emphasise the importance of multi-crew procedures, as well as the role of the pilot monitoring during all phases of the flight; and
 - (7) include standard operating procedures.
- (b) Emergency and safety equipment training should focus on the equipment fitted/carried. Water entry and sea survival training, including operation of all associated safety equipment, should be an element of the recurrent training, as described in [AMC1 ORO.FC.230\(a\)\(2\)\(iii\)\(F\)](#).
- (c) The training elements referred to above should be assessed during: operator proficiency checks, line checks, or, as applicable, emergency and safety equipment checks.
- (d) Training and checking should make full use of full flight simulators (FFSs) for normal, abnormal, and emergency procedures related to all aspects of helicopter offshore operations (HOFO).

SUBPART L: SINGLE-ENGINED TURBINE AEROPLANE OPERATIONS AT NIGHT OR IN INSTRUMENT METEOROLOGICAL CONDITIONS (SET-IMC)

SPA.SET-IMC.100 SET-IMC operations

Regulation (EU) 2017/363

In commercial air transport (CAT) operations, single-engined turbine aeroplanes shall only be operated at night or in IMC if the operator has been granted a SET-IMC approval by the competent authority.

SPA.SET-IMC.105 SET-IMC operations approval

Regulation (EU) 2019/1387

To obtain a SET-IMC approval by the competent authority, the operator shall provide evidence that all the following conditions have been complied with:

- (a) an acceptable level of turbine engine reliability is achieved in service by the world fleet for the particular airframe-engine combination;
- (b) specific maintenance instructions and procedures to ensure the intended levels of continued airworthiness and reliability of the aeroplane and its propulsion system have been established and included in the operator's aircraft maintenance programme in accordance with Regulation (EU) No 1321/2014, including all of the following:
 - (1) an engine trend monitoring programme, except for aeroplanes first issued with an individual certificate of airworthiness after 31 December 2004 that have an automatic trend monitoring system;
 - (2) a propulsion and associated systems' reliability programme;
- (c) flight crew composition and a training/checking programme for the flight crew members involved in these operations have been established;
- (d) operating procedures have been established specifying all the following:
 - (1) the equipment to be carried, including its operating limitations and appropriate entries in the MEL;
 - (2) the flight planning;
 - (3) the normal procedures;
 - (4) the contingency procedures, including procedures following a propulsion system failure, as well as forced landing procedures in all weather conditions;
 - (5) the monitoring and incident reporting.
- (e) a safety risk assessment has been performed, including the determination of an acceptable risk period if an operator intends to make use of it.

AMC1 SPA.SET-IMC.105 SET-IMC operations approval

ED Decision 2017/004/R

ANNUAL REPORT

After obtaining the initial approval, the operator should make available to its competent authority on an annual basis a report related to its SET-IMC operations containing at least the following information:

- (a) the number of flights operated;
- (b) the number of hours flown; and
- (c) the number of occurrences sorted by type.

AMC1 SPA.SET-IMC.105(a) SET-IMC operations approval

ED Decision 2017/004/R

TURBINE ENGINE RELIABILITY

- (a) The operator should obtain the power plant reliability data from the type certificate (TC) holder and/or supplemental type certificate (STC) holder.
- (b) The data for the engine-airframe combination should have demonstrated, or be likely to demonstrate, a power loss rate of less than 10 per million flight hours. Power loss in this context is defined as any loss of power, including in-flight shutdown, the cause of which may be traced to faulty engine or engine component design or installation, including design or installation of the fuel ancillary or engine control systems.
- (c) The in-service experience with the intended engine-airframe combination should be at least 100 000 h, demonstrating the required level of reliability. If this experience has not been accumulated, then, based on analysis or test, in-service experience with a similar or related type of airframe and turbine engine might be considered by the TC/STC holder to develop an equivalent safety argument in order to demonstrate that the reliability criteria are achievable.

AMC1 SPA.SET-IMC.105(b) SET-IMC operations approval

ED Decision 2017/004/R

MAINTENANCE PROGRAMME

The following maintenance aspects should be addressed by the operator:

- (a) Engine monitoring programme

The operator's maintenance programme should include an oil-consumption-monitoring programme that should be based on engine manufacturer's recommendations, if available, and track oil consumption trends. The monitoring should be continuous and take account of the oil added. An engine oil analysis programme may also be required if recommended by the engine manufacturer. The possibility to perform frequent (recorded) power checks on a calendar basis should be considered.

The engine monitoring programme should also provide for engine condition monitoring describing the parameters to be monitored, the method of data collection and a corrective action process, and should be based on the engine manufacturer's instructions. This monitoring

will be used to detect propulsion system deterioration at an early stage allowing corrective action to be taken before safe operation is affected.

(b) Propulsion and associated systems' reliability programme

A propulsion and associated systems' reliability programme should be established or the existing reliability programme supplemented for the particular engine-airframe combination. This programme should be designed to early identify and prevent problems, which otherwise would affect the ability of the aeroplane to safely perform its intended flight.

Where the fleet of SET-IMC aeroplanes is part of a larger fleet of the same engine-airframe combination, data from the operator's total fleet should be acceptable.

For engines, the programme should incorporate reporting procedures for all significant events. This information should be readily available (with the supporting data) for use by the operator, type certificate (TC) holders, and the competent authority to help establish that the reliability level set out in [AMC1 SPA.SET-IMC.105\(a\)](#) is achieved. Any adverse trend would require an immediate evaluation to be conducted by the operator in consultation with its competent authority. The evaluation may result in taking corrective measures or imposing operational restrictions.

The engine reliability programme should include, as a minimum, the engine hours flown in the period, the power loss rate for all causes, and the engine removal rate, both rates on an annual basis, as well as reports with the operational context focusing on critical events. These reports should be communicated to the TC holder and the competent authority.

The actual period selected should reflect the global utilisation and the relevance of the experience included (e.g. early data may not be relevant due to subsequent mandatory modifications that affected the power loss rate). After the introduction of a new engine variant and whilst global utilisation is relatively low, the total available experience may have to be used to try to achieve a statistically meaningful average.

AMC1 SPA.SET-IMC.105(c) SET-IMC operations approval

ED Decision 2017/004/R

TRAINING PROGRAMME

The operator's flight crew training and checking, established in accordance with ORO.FC, should incorporate the following elements:

(a) Conversion training

Conversion training should be conducted in accordance with a syllabus devised for SET-IMC operations and include at least the following:

- (1) normal procedures:
 - (i) anti-icing and de-icing systems operation;
 - (ii) navigation system procedures;
 - (iii) radar positioning and vectoring, when available;
 - (iv) use of radio altimeter; and
 - (v) use of fuel control, displays interpretation;

-
- (2) abnormal procedures:
- (i) anti-icing and de-icing systems failures;
 - (ii) navigation system failures;
 - (iii) pressurisation system failures;
 - (iv) electrical system failures; and
 - (v) engine-out descent in simulated IMC; and
- (3) emergency procedures:
- (i) engine failure shortly after take-off;
 - (ii) fuel system failures (e.g. fuel starvation);
 - (iii) engine failure other than the above: recognition of failure, symptoms, type of failure, measures to be taken, and consequences;
 - (iv) depressurisation; and
 - (v) engine restart procedures:
 - (A) choice of an aerodrome or landing site; and
 - (B) use of an area navigation system;
 - (vi) air traffic controller (ATCO) communications;
 - (vii) use of radar positioning and vectoring (when available);
 - (viii) use of radio altimeter; and
 - (ix) practice of the forced landing procedure until touchdown in simulated IMC, with zero thrust set, and operating with simulated emergency electrical power.

(b) Conversion checking

The following items should be checked following completion of the SET-IMC operations conversion training as part of the operator's proficiency check (OPC):

- (1) conduct of the forced landing procedure until touchdown in simulated IMC, with zero thrust set, and operating with simulated emergency electrical power;
- (2) engine restart procedures;
- (3) depressurisation following engine failure; and
- (4) engine-out descent in simulated IMC.

(c) Use of simulator (conversion training and checking)

Where a suitable full flight simulator (FFS) or a suitable flight simulation training device (FSTD) is available, it should be used to carry out training on the items under (a) and checking of the items under (b) above for SET-IMC operations conversion training and checking.

(d) Recurrent training

Recurrent training for SET-IMC operations should be included in the recurrent training required by Subpart FC (FLIGHT CREW) of Annex III (Part-ORO) to Regulation (EU) No 965/2012 for pilots carrying out SET-IMC operations. This training should include all items under (a) above.

(e) Recurrent checking

The following items should be included into the list of required items to be checked following completion of SET-IMC operations recurrent training as part of the OPC:

- (1) conduct of the forced landing procedure until touchdown in simulated IMC, with zero thrust set, and operating with simulated emergency electrical power;
- (2) engine restart procedures;
- (3) depressurisation following engine failure; and
- (4) emergency descent in simulated IMC.

(f) Use of simulator (recurrent training and checking)

Following conversion training and checking, the next recurrent training session and the next OPCs including SET-IMC operations items should be conducted in a suitable FFS or FSTD, where available.

AMC2 SPA.SET-IMC.105(c) SET-IMC operations approval

ED Decision 2017/004/R

CREW COMPOSITION

- (a) Unless the pilot-in-command has a minimum experience of 100 flight hours under instrument flight rules (IFR) with the relevant type or class of aeroplane including line flying under supervision (LIFUS), the minimum crew should be composed of two pilots.
- (b) A lesser number of flight hours under IFR on the relevant type or class of aeroplane may be acceptable to the competent authority when the flight crew member has significant previous IFR experience.

AMC1 SPA.SET-IMC.105(d)(2) SET-IMC operations approval

ED Decision 2017/004/R

FLIGHT PLANNING

- (a) The operator should establish flight planning procedures to ensure that the routes and cruising altitudes are selected so as to have a landing site within gliding range.
- (b) Notwithstanding (a) above, whenever a landing site is not within gliding range, one or more risk periods may be used for the following operations:
 - (1) over water;
 - (2) over hostile environment; or
 - (3) over congested areas.

Except for the take-off and landing phase, the operator should ensure that when a risk period is planned, there is a possibility to glide to a non-congested area.

The total duration of the risk period per flight should not exceed 15 min unless the operator has established, based on a risk assessment carried out for the route concerned, that the cumulative risk of fatal accident due to an engine failure for this flight remains at an acceptable level (see [GM2 SPA.SET-IMC.105\(d\)\(2\)](#)).

- (c) The operator should establish criteria for the assessment of each new route. These criteria should address the following:
- (1) the selection of aerodromes along the route;
 - (2) the identification and assessment, at least on an annual basis, of the continued suitability of landing sites (obstacles, dimensions of the landing area, type of the surface, slope, etc.) along the route when no aerodrome is available; the assessment may be performed using publicly available information or by conducting on-site surveys;
 - (3) assessment of en route specific weather conditions that could affect the capability of the aeroplane to reach the selected forced landing area following loss of power (icing conditions including gliding descent through clouds in freezing conditions, headwinds, etc.);
 - (4) consideration of landing sites' prevailing weather conditions to the extent that such information is available from local or other sources; expected weather conditions at landing sites for which no weather information is available should be assessed and evaluated taking into account a combination of the following information:
 - (i) local observations;
 - (ii) regional weather information (e.g. significant weather charts); and
 - (iii) terminal area forecast (TAF)/meteorological aerodrome report (METAR) of the nearest aerodromes; and
 - (5) protection of the aeroplane occupants after landing in case of adverse weather.
- (d) At the flight planning phase, any selected landing site should have been assessed by the operator as acceptable for carrying out a safe forced landing with a reasonable expectation of no injuries to persons in the aeroplane or on the ground. All information reasonably practical to acquire should be used by the operator to establish the characteristics of landing sites.
- (e) Landing sites suitable for a diversion or forced landing should be programmed into the navigation system so that track and distance to the landing sites are immediately and continuously available. None of these preprogrammed positions should be altered in-flight.

AMC2 SPA.SET-IMC.105(d)(2) SET-IMC operations approval

ED Decision 2017/004/R

ROUTE AND INSTRUMENT PROCEDURE SELECTION

The following should be considered by the operator, as appropriate, depending on the use of a risk period:

(a) Departure

The operator should ensure, to the extent possible, that the instrument departure procedures to be followed are those guaranteeing that the flight path allows, in the event of power loss, the aeroplane to land on a landing site.

(b) Arrival

The operator should ensure, to the extent possible, that the arrival procedures to be followed are those guaranteeing that the flight path allows, in the event of power loss, the aeroplane to land on a landing site.

(c) En route

The operator should ensure that any planned or diversionary route should be selected and be flown at an altitude such that, in the event of power loss, the pilot is able to make a safe landing on a landing site.

AMC3 SPA.SET-IMC.105(d)(2) SET-IMC operations approval

ED Decision 2017/004/R

LANDING SITE

A landing site is an aerodrome or an area where a safe forced landing can be performed by day or by night, taking into account the expected weather conditions at the time of the foreseen landing.

- (a) The landing site should allow the aeroplane to completely stop within the available area, taking into account the slope and the type of the surface.
- (b) The slope of the landing site should be assessed by the operator in order to determine its acceptability and possible landing directions.
- (c) Both ends of the landing area, or only the zone in front of the landing area for one-way landing areas, should be clear of any obstacle which may be a hazard during the landing phase.

GM1 SPA.SET-IMC.105(d)(2) SET-IMC operations approval

ED Decision 2017/004/R

LANDING SITE

- (a) When selecting landing sites along a route to be operated, it is recommended to prioritise the different types of landing sites as follows:
 - (1) aerodromes with available runway lighting;
 - (2) aerodromes without available runway lighting;
 - (3) non-populated fields with short grass/vegetation or sandy areas.
- (b) When assessing the suitability of a landing site which is not an aerodrome, it is recommended to consider the following landing site criteria:
 - (1) size and shape of the landing area:
 - (i) landing sites with a circular shape providing multiple approach paths depending on the wind; and
 - (ii) for other cases, landing sites with a minimum width of 45 m; and
 - (2) type of surface:

the surface of the landing area should allow a safe forced landing to be conducted.

GM2 SPA.SET-IMC.105(d)(2) SET-IMC operations approval

ED Decision 2017/004/R

SAFETY RISK ASSESSMENT FOR A SPECIFIC ROUTE

(a) Introduction

The risk assessment methodology should aim at estimating for a specific route the likelihood of having fatalities due to emergency landing caused by engine failure. Based on the outcome of this risk assessment, the operator may extend the duration of the risk period beyond the maximum allowed duration if no landing site is available within gliding range.

(b) The safety target

The overall concept of SET-IMC operations is based on an engine reliability rate for all causes of 10 per million flight hours, which permits in compliance with SET-IMC requirements an overall fatal accident rate for all causes of 4 per million flight hours.

Based on accident databases, it is considered that the engine failure event does not contribute by more than 33 % to the overall fatal accident rate. Therefore, the purpose of the risk assessment is to ensure that the probability of a fatal accident for a specific flight following engine failure remains below the target fatal accident rate of 1.3×10^{-6} .

(c) Methodology

The methodology aims at estimating the likelihood of failing to achieve a safe forced landing in case of engine failure, a safe forced landing being defined as a landing on an area for which it is reasonably expected that no serious injury or fatalities will occur due to the landing even though the aeroplane may suffer extensive damage.

This methodology consists of creating a risk profile for a specific route, including departure, en route and arrival airfield and runway, by splitting the proposed flight into appropriate segments (based on the flight phase or the landing site selected), and by estimating the risk for each segment should the engine fail in one of these segments. This risk profile is considered to be an estimation of the probability of an unsuccessful forced landing if the engine fails during one of the identified segments.

When assessing the risk for each segment, the height of the aeroplane at which the engine failure occurs, the position relative to the departure or destination airfield or to an emergency landing site en route, and the likely ambient conditions (ceiling, visibility, wind and light) should be taken into account, as well as the standard procedures of the operator (e.g. U-turn procedures after take-off, use of synthetic vision, descent path angle for standard descent from cruising altitude, etc.).

The duration of each segment determines the exposure time to the estimated risk. The risk is estimated based on the following calculation:

Segment risk factor = segment exposure time (in s)/3 600 × probability of unsuccessful forced landing in this segment × assumed engine failure rate per flight hour (FH).

By summing up the risks for all individual segments, the cumulative risk for the flight due to engine failure is calculated and converted to risk on a 'per flight hour' basis.

This total risk must remain below the target fatal accident rate of 1.3×10^{-6} as under (b) above.

(d) Example of a risk assessment

An example of such a risk assessment is provided below. In any case, this risk assessment is an example designed for a specific flight with specific departure and arrival aerodrome characteristics. It is an example of how to implement this methodology, and all the estimated probabilities used in the table below may not directly apply to any other flight.

The meaning of the different parameters used is further detailed below:

AD/Other: 'AD' is ticked whenever only aerodromes are selected as landing sites in the segment concerned. 'Other' is ticked if the selected landing sites in the segment concerned are not aerodromes. When a risk period is used by the operator, none of the two boxes (neither 'AD' nor 'Other') are ticked.

Segment exposure time: this parameter represents the duration of each segment in seconds (s).

Estimated probability of an unsuccessful forced landing if engine fails in the segment: probability of performing in the segment a safe forced landing following engine power loss.

Segment risk factor: risk of an unsuccessful forced landing (because of power loss) per segment (see formula above).

Segments of flight	Assumed height or height band above ground level (AGL) in ft	LANDING SITE		Segment exposure time (in s)	Cumulative flight time from start of take-off to end of segment (in s)	Assumed engine failure rate per FH			Comment on estimation of unsuccessful outcome
		AD	Other			Estimated probability of unsuccessful forced landing if engine fails in this segment	Segment risk factor	Cumulative risk per flight	
Take-off (T-O) ground roll	0 ft	X		20	20	0.01 %	5.56×10^{-12}	5.56×10^{-12}	T-O aborted before being airborne. Runway long enough to stop the aircraft.
Climb-out	0-50 ft	X		8	28	0.10 %	2.22×10^{-11}	2.78×10^{-11}	Aircraft aborts T-O and lands ahead within runway length available.
	50-200 ft	X		10	38	1.00 %	2.78×10^{-10}	3.06×10^{-10}	
	200-1 100 ft	X	X	36	74	100.00 %	1.00×10^{-7}	1.00×10^{-7}	Aircraft has to land ahead outside airfield with little height for manoeuvring
	1 100-2 000 ft	X		36	110	50.00 %	5.00×10^{-8}	1.50×10^{-7}	U-turn and landing at opposite q-code for magnetic heading of a runway (QFU) possible.
	2 000-4 000 ft	X		80	190	25.00 %	5.56×10^{-8}	2.06×10^{-7}	
Climbing to en route height	4 000-10 000ft	X	X	240	430	5.00 %	3.33×10^{-8}	2.39×10^{-7}	Aircraft able to operate a glide-in approach.
Cruising: emergency area available	≤ 10 000 ft	X		5 400	5 830	5.00 %	7.50×10^{-7}	9.89×10^{-7}	En route cruising time with available landing sites along the route within gliding range.
Cruising: emergency area NOT available	≤ 10 000 ft	X	X	300	6 130	100.00 %	8.33×10^{-7}	1.82×10^{-6}	En route cruising time without available landing sites within gliding range.
Descent to initial approach fix for instrument flight rules (IFR) approach	10 000-4 000 ft on a 4° slope (1 200 ft/min)	X		300	6 430	5.00 %	4.17×10^{-8}	1.86×10^{-6}	Descent with available landing sites within gliding range, and destination not reachable.

Segments of flight	Assumed height or height band above ground level (AGL) in ft	LANDING SITE		Segment exposure time (in s)	Cumulative flight time from start of take-off to end of segment (in s)	Assumed engine failure rate per FH			1,00x10 ⁻⁵	Comment on estimation of unsuccessful outcome
		AD	Other			Estimated probability of unsuccessful forced landing if engine fails in this segment	Segment risk factor	Cumulative risk per flight		
Aircraft has to descend below the glide approach capability to set up for a normal powered landing from 1 000 ft on a 3° approach path	4 000-1 000 ft on the approach		X	150	6 580	50.00 %	2.08 x 10 ⁻⁷	2.07 x 10 ⁻⁶		Aircraft descends below the height needed to maintain a glide approach for reaching the airfield. Therefore, it may land short of airfield if engine fails.
Aircraft descends on a 3° approach path	1 000 -50 ft on approach at 120 kt (600 ft/min)	X	X	95	6 675	100.00 %	2.64 x 10 ⁻⁷	2.34 x 10 ⁻⁶		Aircraft assumes 3° glideslope, regained to ensure normal landing. Therefore, it may undershoot the landing field if engine fails at this late stage.
Landing	50 ft above threshold until touchdown	X		10	6 685	5.00 %	1.39 x 10 ⁻⁹	2.34 x 10 ⁻⁶		Aircraft over runway. Engine is to be idled anyway, but failure, while airborne, may surprise pilot and result in hard landing.
Landing ground run	Touchdown to stop	X		15	6 700	0.01 %	4.17 x 10 ⁻¹²	2.34 x 10 ⁻⁶		Aircraft on ground. Risk negligible, if engine stops on the example runway (very long) providing that all services are retained.
								1.26 x 10⁻⁶		Risk per flight

The following likelihood scale may be used to determine the estimated probability of an unsuccessful forced landing:

Probability in %	Description
0	Impossible
0-1	Negligible likelihood/remote possibility
1-10	Possible but not likely
10-35	Moderately likely
35-65	Possible
65-90	Likely
90-99	Almost certain
99-100	Certain

AMC1 SPA.SET-IMC.105(d)(4) SET-IMC operations approval

ED Decision 2017/004/R

CONTINGENCY PROCEDURES

When a risk period is used during the take-off or landing phase, the contingency procedures should include appropriate information for the crew on the path to be followed after an engine failure in order to minimise to the greatest extent possible the risk to people on the ground.

SPA.SET-IMC.110 Equipment requirements for SET-IMC operations

Regulation (EU) 2021/1296

Aeroplanes used for SET-IMC operations shall be equipped with all the following equipment:

- (a) two separate electrical generating systems, each one capable of supplying adequate power to all essential flight instruments, navigation systems and aeroplane systems required for continued flight to the destination or alternate aerodrome;
- (b) two attitude indicators, powered from independent sources;
- (c) for passenger operations, a shoulder harness or a safety belt with a diagonal shoulder strap for each passenger seat;
- (d) airborne weather-detecting equipment;
- (e) in a pressurised aeroplane, sufficient supplemental oxygen for all occupants to allow descent, following engine failure at the maximum certificated cruising altitude, at the best range gliding speed and in the best gliding configuration, assuming the maximum cabin leak rate, until sustained cabin altitudes below 13 000 ft are reached;
- (f) an area navigation system capable of being programmed with the positions of landing sites and providing lateral guidance to the flight crew to reach those sites;
- (g) a radio altimeter;
- (h) a landing light, capable of illuminating the touchdown point on the power-off glide path from 200 ft away;
- (i) an emergency electrical supply system of sufficient capacity and endurance capable of providing power, following the failure of all generated power, to additional loads necessary for all of the following:
 - (1) the essential flight and area navigation instruments during descent from maximum operating altitude after engine failure;
 - (2) the means to provide for one attempt to restart the engine;
 - (3) if appropriate, the extension of landing gear and flaps;
 - (4) the use of the radio altimeter throughout the landing approach;
 - (5) the landing light;
 - (6) one pitot heater;
 - (7) if installed, the electrical means to give sufficient protection against impairment of the pilot's vision for landing;

- (j) an ignition system that activates automatically, or is capable of being operated manually, for take-off, landing, and during flight, in visible moisture;
- (k) a means of continuously monitoring the power train lubrication system to detect the presence of debris associated with the imminent failure of a drivetrain component, including a flight crew compartment caution indication;
- (l) an emergency engine power control device that permits continuing operation of the engine at a sufficient power range to safely complete the flight in the event of any reasonably probable failure of the fuel/energy control unit.

AMC1 SPA.SET-IMC.110(b) Equipment requirements for SET-IMC operations

ED Decision 2017/004/R

ATTITUDE INDICATORS

A backup or standby attitude indicator built in the glass cockpit installations is an acceptable means of compliance for the second attitude indicator.

AMC1 SPA.SET-IMC.110(d) Equipment requirements for SET-IMC operations

ED Decision 2017/004/R

AIRBORNE WEATHER-DETECTING EQUIPMENT

The airborne weather-detecting equipment should be an airborne weather radar, as defined in the applicable Certification Specification — European Technical Standard Order (CS-ETSO) issued by the Agency, or equivalent.

AMC1 SPA.SET-IMC.110(f) Equipment requirements for SET-IMC operations

ED Decision 2017/004/R

AREA NAVIGATION SYSTEM

The area navigation system should be based on a global navigation satellite system (GNSS) stand-alone receiver or multi-sensor system, including at least one GNSS sensor, to enable at least required navigation performance approach (RNP APCH) operations without vertical guidance.

GM1 SPA.SET-IMC.110(f) Equipment requirements for SET-IMC operations

ED Decision 2017/004/R

AREA NAVIGATION SYSTEM

Acceptable standards for the area navigation system are ETSO-145/146c, ETSO-C129a, ETSO-C196a or ETSO-C115 issued by the Agency, or equivalent.

GM1 SPA.SET-IMC.110(h) Equipment requirements for SET-IMC operations

ED Decision 2017/004/R

LANDING LIGHTS

In order to demonstrate the compliance of its aeroplane's landing lights with the 200-ft illumination capability requirement, and in the absence of relevant data available in the aircraft flight manual (AFM), the operator should liaise with the type certificate (TC) holder or supplemental type certificate (STC) holder, as applicable, to obtain a statement of compliance.

GM1 SPA.SET-IMC.110(i)(7) Equipment requirements for SET-IMC operations

ED Decision 2017/004/R

ELEMENTS AFFECTING PILOT'S VISION FOR LANDING

Examples of elements affecting pilot's vision for landing are rain, ice and window fogging.

AMC1 SPA.SET-IMC.110(l) Equipment requirements for SET-IMC operations

ED Decision 2017/004/R

EMERGENCY ENGINE POWER CONTROL DEVICE

The means that allows continuing operation of the engine within a sufficient power range for the flight to be safely completed in the event of any reasonably probable failure/malfunction of the fuel control unit should enable the fuel flow modulation.

SUBPART M: ELECTRONIC FLIGHT BAGS (EFB)

SPA.EFB.100 Use of electronic flight bags (EFBs) – operational approval

Regulation (EU) 2018/1975

- (a) A commercial air transport operator shall only use a type B EFB application if the operator has been granted an approval by the competent authority for such use.
- (b) In order to obtain an operational approval from the competent authority for the use of a type B EFB application, the operator shall provide evidence that:
- (1) a risk assessment related to the use of the EFB device that hosts the application and to the EFB application and its associated function(s) has been conducted, identifying the associated risks and ensuring that they are appropriately managed and mitigated;
 - (2) the human-machine interfaces of the EFB device and the EFB application have been assessed against human factors principles;
 - (3) it has established an EFB administration system and that procedures and training requirements for the administration and use of the EFB device and the EFB application have been established and implemented; these shall include procedures for:
 - (i) operating the EFB;
 - (ii) the management of changes to the EFB;
 - (iii) the management of EFB data;
 - (iv) EFB maintenance; and
 - (v) EFB security;
 - (4) the EFB host platform is suitable for the intended use of the EFB application.

This demonstration shall be specific to the EFB application and the EFB host platform on which the application is installed.

AMC1 SPA.EFB.100(b) Use of electronic flight bags (EFBs) – operational approval

ED Decision 2019/008/R

SUITABILITY OF THE HARDWARE

- (a) Placement of the display

The placement of the display should be consistent with the intended use of the EFB and should not create unacceptable workload for the pilot or require undue 'head-down' movements during critical phases of flight. Displays used for EFB chart applications should be located so as to be visible from the pilot's station with the minimum practicable deviation from their lines of vision when looking forward along the flight path.

- (b) Display characteristics

Consideration should be given to the long-term degradation of a display as a result of abrasion and ageing. AMC 25-11 (paragraph 3.16a) may be used as guidance to assess luminance and legibility aspects.

Information displayed on the EFB should be legible to the typical user at the intended viewing distance(s) and under the full range of lighting conditions expected in a flight crew compartment, including direct sunlight.

Users should be able to adjust the screen brightness of an EFB independently of the brightness of other displays in the flight crew compartment. In addition, when incorporating an automatic brightness adjustment, it should operate independently for each EFB in the flight crew compartment. Brightness adjustment using software means may be acceptable provided that this operation does not adversely affect the flight crew workload.

Buttons and labels should have adequate illumination for night use. 'Buttons and labels' refers to hardware controls located on the display itself.

All controls should be properly labelled for their intended functions, except if no confusion is possible.

The 90-degree viewing angle on either side of each flight crew member's line of sight may be unacceptable for certain EFB applications if aspects of the display quality are degraded at large viewing angles (e.g. the display colours wash out or the displayed colour contrast is not discernible at the installation viewing angle).

(c) Power source

The design of a portable EFB system should consider the source of electrical power, the independence of the power sources for multiple EFBs, and the potential need for an independent battery source. A non-exhaustive list of factors to be considered includes:

- (1) the possibility to adopt operational procedures to ensure an adequate level of safety (for example, a minimum preflight level of charge);
- (2) the possible redundancy of portable EFBs to reduce the risk of exhausted batteries;
- (3) the availability of backup battery packs to ensure that there is an alternative source of power.

Battery-powered EFBs that have aircraft power available for recharging the internal EFB batteries are considered to have a suitable backup power source.

For EFBs that have an internal battery power source, and that are used as an alternative for paper documentation that is required by [CAT.GEN.MPA.180](#), the operator should either have at least one EFB connected to an aircraft power bus, or have established and documented mitigation means and procedures to ensure that sufficient power with acceptable margins will be available during the whole flight.

(d) Environmental testing

Environmental testing, in particular testing for rapid decompression, should be performed on EFBs that host applications that are required to be used during flight following a rapid decompression, and/or on EFBs with an environmental operational range that is potentially insufficient with respect to the foreseeable flight crew compartment operating conditions.

The information from the rapid-decompression test of an EFB is used to establish the procedural requirements for the use of that EFB device in a pressurised aircraft. Rapid-decompression testing should follow the EUROCAE ED-14D/RTCA DO-160D (or later revisions) guidelines for rapid-decompression testing up to the maximum operating altitude of the aircraft at which the EFB is to be used.

- (1) Pressurised aircraft: if a portable EFB has successfully completed rapid-decompression testing, then no mitigating procedures for depressurisation events need to be developed. If a portable EFB has failed the rapid-decompression testing while turned ON, but successfully completed it when turned OFF, then procedures should ensure that at least one EFB on board the aircraft either remains OFF during the applicable flight phases, or is configured so that no damage will be incurred should rapid decompression occur in flight at altitudes higher than 10 000 ft above mean sea level (AMSL).

If an EFB system has not undergone a rapid-decompression test or it has failed the test, then alternate procedures or a paper backup should be available for the related type B EFB applications.

- (2) Non-pressurised aircraft: rapid-decompression testing is not required for an EFB used in a non pressurised aircraft. It should be demonstrated that the EFB can operate reliably up to the maximum operating altitude of the aircraft. If the EFB cannot be operated at the maximum operating altitude of the aircraft, procedures should be established to preclude operation of the EFB above the maximum demonstrated EFB operating altitude while still maintaining the availability of any required aeronautical information displayed on the EFB.

The results of testing performed on a specific EFB model configuration (as identified by the EFB hardware manufacturer) may be applicable to EFBs of the same model used in other aircraft installations, in which case these generic environmental tests may not need to be duplicated. The operator should collect and retain:

- (1) evidence of these tests that have already been accomplished; or
- (2) suitable alternative procedures to deal with the total loss of the EFB system.

Rapid decompression tests do not need to be repeated if the EFB model identification and the battery type do not change.

The testing of operational EFBs should be avoided if possible to preclude the infliction of unknown damage to the devices during testing.

Operators should account for the possible loss or erroneous functioning of the EFB in abnormal environmental conditions.

The safe stowage and the use of the EFB under any foreseeable environmental conditions in the flight crew compartment, including turbulence, should be evaluated.

AMC2 SPA.EFB.100(b) Use of electronic flight bags (EFBs) – Operational approval

ED Decision 2019/008/R

CHANGES

Modifications to an EFB system may have to be introduced either by the EFB system supplier, the EFB applications developer, or by the operator itself.

Those modifications that:

- (a) do not result in a hardware change that would require a re-evaluation of the HMI and human factors aspects in accordance with [AMC1 SPA.EFB.100\(b\)\(2\)](#);
- (b) do not bring any change to the calculation algorithms of a type B EFB application;

- (c) do not bring any change to the HMI of a type B EFB application that requires a change to the flight crew training programme or operational procedures;
- (d) introduce a new type A EFB application or modify an existing one (provided its software classification remains type A);
- (e) do not introduce any additional functionality to an existing type B EFB application; or
- (f) update an existing database necessary to use an existing type B EFB application,

may be introduced by the operator without the need to be approved by its competent authority.

These changes should, nevertheless, be controlled and properly tested prior to use during flights.

The modifications in the following non-exhaustive list are considered to meet these criteria:

- (a) operating system updates;
- (b) chart or airport database updates;
- (c) updates to introduce fixes (i.e. patches); and
- (d) installation and modification of a type A EFB application.

For all other types of modification, the operator should apply the change management procedure approved by the competent authority in accordance with [ARO.GEN.310\(c\)](#). This includes the extension of the use of an EFB system, for which the operator already holds an approval, to another aircraft type of the operator's fleet.

In the specific case of a complete change of the hardware hosting the EFB application, the operator should demonstrate to its competent authority that the new hardware is suitable for the intended use of the EFB application as per [AMC1.SPA.EFB.100\(b\)](#).

AMC3.SPA.EFB.100(b) Use of electronic flight bags (EFBs)

ED Decision 2019/008/R

OPERATIONAL EVALUATION TEST

- (a) The operator should perform an operational evaluation test which should enable verification that the relevant requirements of SPA.EFB have been satisfied before a final decision is made on the operational use of the EFB.

An operational evaluation test should be performed by operators seeking an operational approval for the use of a type B EFB application. This does not apply to changes to a type B EFB application whose use has already been approved by the operator's competent authority.

The operator should notify its competent authority of its intention to perform an operational evaluation test by providing a plan, which should contain at least the following information:

- (1) the starting date of the operational evaluation test;
- (2) the duration of the operational evaluation test;
- (3) the aircraft involved;
- (4) the EFB hardware and type(s) of software including version details;
- (5) the EFB policy and procedure manual;
- (6) their EFB risk assessment; and

- (7) for type B EFB applications that replace the paper documentation without initial retention of a paper backup, and type B EFB applications that do not replace the paper documentation:
- (i) a simulator line-oriented flight training (LOFT) session programme to verify the use of the EFB under operational conditions including normal, abnormal, and emergency conditions; and
 - (ii) a proposed schedule to allow the competent authority to observe the EFB application use in actual flight operations.

The operational evaluation test should consist of an in-service proving period with a standard duration of 6 months. A reduced duration may be considered after taking into account the following criteria:

- (1) the operator's previous experience with EFBs;
- (2) a high number of flights operated monthly;
- (3) the intended use of the EFB system; and
- (4) the mitigation means defined by the operator.

An operator wishing to reduce the duration of the operational evaluation test to less than 6 months should provide its competent authority with the appropriate justification in its operational evaluation plan.

The competent authority may ask for an operational evaluation test lasting more than 6 months if the number of flights operated in this period is not considered sufficient to evaluate the EFB system.

The general purpose of the in-service proving period for type B EFB applications that replaces the paper documentation is for the operator to demonstrate that an EFB system provides at least the levels of accessibility, usability and reliability of the paper documentation.

For all type B EFB applications, the proving period should show that:

- (1) the flight crew members are able to operate the EFB applications;
- (2) the operator's administration procedures are in place and function correctly;
- (3) the operator is capable of providing timely updates to the applications on the EFB, where a database is involved;
- (4) the introduction of the EFB does not adversely affect the operator's operating procedures, and that alternative procedures provide an acceptable equivalent if the EFB system is not available;
- (5) for a system including uncertified elements (hardware or software), that the system operates correctly and reliably; and
- (6) the assumptions used for the risk assessment are not disproved for the type of operations intended (with or without a paper backup).

In the case of charts or in-flight weather (IFW) applications displaying the own-ship position in flight, the in-service proving should allow to confirm the absence of frequent losses of position and to assess the resulting workload for the flight crew.

The operator may remove the paper backup once it has shown that the EFB system is sufficiently robust.

(b) Final operational report

The operator should produce and retain a final operational report, that summarises all the activities performed and the means of compliance that were used, supporting the operational use of the EFB system.

AMC4 SPA.EFB.100(b) Use of electronic flight bags (EFBs)

ED Decision 2019/008/R

EFB APPLICATIONS WITH ETSO AUTHORISATIONS

EFB software applications may be approved by EASA e.g. by means of an ETSO authorisation. Such approved EFB applications are considered to be compliant with the requirements of [SPA.EFB.100\(b\)](#) that are included in the scope of the approval, provided that the EFB software is installed and used in conformity with its installation and operational instructions and limitations.

GM1 SPA.EFB.100(b) Use of electronic flight bags (EFBs) – Operational approval

ED Decision 2019/008/R

FINAL OPERATIONAL REPORT

An example of typical items for the final operational report is provided below:

- (a) System description and classification of the EFB system:
- (1) a general description of the EFB system and of the hardware and software applications.
- (b) Software applications:
- (1) a list of the type A EFB applications installed;
 - (2) a list of the type B EFB applications installed; and
 - (3) a list of the miscellaneous software applications installed.

(c) Hardware:

For portable EFBs used without installed resources, relevant information about or reference to:

- (1) the EMI compliance demonstration;
- (2) the lithium battery compliance demonstration;
- (3) the depressurisation compliance demonstration; and
- (4) details of the power source.

For portable EFBs served by installed resources:

- (1) details of the airworthiness approval for the mounting device;
- (2) a description of the placement of the EFB display;
- (3) details of the use of installed resources;
- (4) information on the EMI compliance demonstration;
- (5) information on the lithium battery compliance demonstration;
- (6) information on the depressurisation compliance demonstration;
- (7) details of the power source;

-
- (8) details of any data connectivity.
- For installed EFBs:
- (1) details of the airworthiness approval for installed equipment.
- (d) Certification documentation:
- (1) EFB limitations contained within the AFM;
- (2) guidelines for EFB application developers; and
- (3) guidelines for EFB system suppliers.
- (e) Specific considerations for performance applications:
- (1) details of performance data validation performed.
- (f) Operational assessment:
- (1) details of the EFB risk assessment performed;
- (2) details of the human–machine interface (HMI) assessment performed for type B EFB applications;
- (3) details of flight crew operating procedures:
- (i) for using EFB systems with other flight crew compartment systems;
- (ii) ensuring flight crew awareness of EFB software/database revisions;
- (iii) to mitigate and/or control increased workload; and
- (iv) describing flight crew responsibilities for performance and weight and balance calculations;
- (4) details of proposed compliance monitoring oversight of the EFB system;
- (5) details of EFB system security measures;
- (6) details of EFB administration procedures, including provision of the EFB policy and procedures manual and EFB administrator qualifications;
- (7) details of the procedure for electronic signatures;
- (8) details of the system for routine EFB system maintenance;
- (9) details of EFB training including flight crew training:
- (i) initial training;
- (ii) differences training; and
- (iii) recurrent training;
- (10) Report of the operational evaluation test:
- (i) proposals for the initial retention of a paper backup;
- (ii) proposals for the commencement of operations without any paper backup;
- (11) EFB platform/hardware description;
- (12) a description of each software application to be included in the assessment;
- (13) a human factors assessment for the complete EFB system, human–machine interface (HMI), and all the software applications that covers:

- (i) the flight crew workload in both single-pilot and multi-pilot aircraft;
- (ii) the size, resolution, and legibility of symbols and text;
- (iii) for navigation chart displays: access to desired charts, access to information within a chart, grouping of information, general layout, orientation (e.g. track-up, north-up), depiction of scale information.

GM2 SPA.EFB.100(b) Use of electronic flight bags (EFBs) – Operational approval

ED Decision 2019/008/R

EVALUATION BY EASA

The operator may use the results of an EFB application evaluation performed by EASA to support its application to its competent authority for an operational approval.

AMC1 SPA.EFB.100(b)(1) Use of electronic flight bags (EFBs) – Operational approval

ED Decision 2019/008/R

RISK ASSESSMENT

(a) General

Prior to the use of any EFB system, the operator should perform a risk assessment for all type B EFB applications and for the related EFB hardware, as part of its hazard identification and risk management process.

If an operator makes use of a risk assessment established by the software developer, the operator should ensure that its specific operational environment is taken into account.

The risk assessment should:

- (1) evaluate the risks associated with the use of an EFB;
- (2) identify potential losses of function or malfunction (with detected and undetected erroneous outputs) and the associated failure scenarios;
- (3) analyse the operational consequences of these failure scenarios;
- (4) establish mitigating measures; and
- (5) ensure that the EFB system (hardware and software) achieves at least the same level of accessibility, usability, and reliability as the means of presentation it replaces.

In considering the accessibility, usability, and reliability of the EFB system, the operator should ensure that the failure of the complete EFB system, as well as of individual applications, including corruption or loss of data, and erroneously displayed information, has been assessed and that the risks have been mitigated to an acceptable level.

This risk assessment should be defined before the beginning of the trial period and should be amended accordingly, if necessary, at the end of this trial period. The results of the trial should establish the configuration and use of the system. Once the operator has been granted the operational approval for the use of the related EFB applications, it should ensure that the related risk assessment is maintained and kept up to date.

When the EFB system is intended to be introduced alongside a paper-based system, only the failures that would not be mitigated by the use of the paper-based system need to be addressed. In all other cases, and especially when an accelerated introduction with a reduced trial period or a paperless use of a new EFB system is intended, a complete risk assessment should be performed.

(b) Assessing and mitigating the risks

Some parameters of EFB applications may depend on entries that are made by flight crew/dispatchers, whereas others may be default parameters from within the system that are subject to an administration process (e.g. the runway line-up allowance in an aircraft performance application). In the first case, mitigation means would mainly concern training and flight crew procedure aspects, whereas in the second case, mitigation means would more likely focus on the EFB administration and data management aspects.

The analysis should be specific to the operator concerned and should address at least the following points:

- (1) The minimisation of undetected erroneous outputs from applications and assessment of the worst credible scenario;
- (2) Erroneous outputs from the software application, including:
 - (i) a description of the corruption scenarios that were analysed; and
 - (ii) a description of the mitigation means;
- (3) Upstream processes including:
 - (i) the reliability of root data used in applications (e.g. qualified input data, such as databases produced under ED-76/DO-200A, 'Standards for Processing Aeronautical Data');
 - (ii) the software application validation and verification checks according to relevant industry standards, if applicable; and
 - (iii) the independence between application software components, e.g. robust partitioning between EFB applications and other airworthiness certified software applications;
- (4) A description of the mitigation means to be used following the detected failure of an application, or of a detected erroneous output;
- (5) The need for access to an alternate power supply in order to ensure the availability of software applications, especially if they are used as a source of required information.

As part of the mitigation means, the operator should consider establishing reliable alternative means to provide the information available on the EFB system.

The mitigation means could be, for example, one of, or a combination of, the following:

- (1) the system design (including hardware and software);
- (2) a backup EFB device, possibly supplied from a different power source;
- (3) EFB applications being hosted on more than one platform;
- (4) a paper backup (e.g. quick reference handbook (QRH)); and
- (5) procedural means.

EFB system design features such as those assuring data integrity and the accuracy of performance calculations (e.g. a 'reasonableness' or 'range' check) may be integrated in the risk assessment to be performed by the operator.

AMC1 SPA.EFB.100(b)(2) Use of electronic flight bags (EFBs) – Operational approval

ED Decision 2019/008/R

HUMAN–MACHINE INTERFACE ASSESSMENT AND HUMAN FACTORS CONSIDERATIONS

- (a) The operator should perform an assessment of the human–machine interface (HMI), the installation, and aspects governing crew resource management (CRM) when using the EFB system.

The HMI assessment is key to identifying acceptable mitigation means, e.g.:

- (1) to establish procedures for reducing the risk of making errors; and
- (2) to control and mitigate the additional workload related to EFB use.

- (b) The assessment should be performed by the operator for each kind of device and application installed on the EFB. The operator should assess the integration of the EFB into the flight deck environment, considering both physical integration (e.g. anthropometrics, physical interference, etc.) and cognitive ergonomics (the compatibility of look and feel, workflows, alerting philosophy, etc.).

- (1) Human–machine interface

The EFB system should provide a consistent and intuitive user interface within and across the various hosted applications and with flight deck avionics applications. This should include but is not limited to data entry methods, colour-coding philosophies, and symbology.

- (2) Input devices

When choosing and designing input devices such as keyboards or cursor-control devices, applicants should consider the type of entry to be made and also flight crew compartment environmental factors, such as turbulence, that could affect the usability of that input device. Typically, the performance parameters of cursor-control devices should be tailored for the function of the intended application as well as for the flight crew compartment environment.

- (3) Consistency

- (i) Consistency between EFBs and applications:

Particular attention should be paid to the consistency of all interfaces, in particular when one provider develops the software application and another organisation integrates it into the EFB.

- (ii) Consistency with flight deck applications:

Whenever possible, EFB user interfaces should be consistent with the other flight deck avionics applications with regard to design philosophy, look and feel, interaction logic, and workflows.

(4) Messages and the use of colours

For any EFB system, EFB messages and reminders should be readily and easily detectable and intelligible by the flight crew under all foreseeable operating conditions.

The use of red and amber colours should be limited and carefully considered. EFB messages, both visual and aural, should be, as far as practicable, inhibited during critical phases of the flight.

Flashing text or symbols should be avoided in any EFB application. Messages should be prioritised according to their significance for the flight crew and the message prioritisation scheme should be documented in the operator's EFB policy and procedure manual.

Additionally, during critical phases of the flight, information necessary to the pilot should be continuously presented without uncommanded overlays, pop-ups, or pre-emptive messages, except for those indicating the failure or degradation of the current EFB application. However, if there is a regulatory or technical standard order (TSO) requirement that is in conflict with the recommendation above, that requirement should take precedence.

(5) System error messages

If an application is fully or partially disabled or is not visible or accessible to the user, it may be desirable to have an indication of its status available to the user upon request. Certain non-essential applications such as those for email connectivity and administrative reports may require an error message when the user actually attempts to access the function, rather than an immediate status annunciation when a failure occurs. EFB status and fault messages should be documented in the operator's EFB policy and procedure manual.

(6) Data entry screening and error messages

If any user-entered data is not of the correct format or type needed by the application, the EFB should not accept the data. An error message should be provided that communicates which entry is suspect and specifies what type of data is expected. The EFB system should incorporate input error checking that detects input errors at the earliest possible point during entry, rather than on completion of a possibly lengthy invalid entry.

(7) Error and failure modes

(i) Flight crew errors:

The system should be designed to minimise the occurrence and effects of flight crew errors and to maximise the identification and resolution of errors. For example, terms for specific types of data or the format in which latitude/longitude is entered should be the same across systems.

(ii) Identifying failure modes:

The EFB system should alert the flight crew of EFB system failures.

(8) Responsiveness of applications

The EFB system should provide feedback to the user when a user input is performed. If the system is busy with internal tasks that preclude the immediate processing of a user input (e.g. performing calculations, self-tests, or refreshing data), the EFB should display

a 'system busy' indicator (e.g. a clock icon) to inform the user that the system is occupied and cannot process inputs immediately.

The timeliness of the EFB system response to a user input should be consistent with an application's intended function. The feedback and system response times should be predictable in order to avoid flight crew distractions and/or uncertainty.

(9) Off-screen text and content

If the document segment is not visible in its entirety in the available display area, such as during 'zoom' or 'pan' operations, the existence of off-screen content should be clearly indicated in a consistent way. For some intended functions, it may be unacceptable if certain portions of documents are not visible. Also, some applications may not require an off-screen content indicator when the presence of off screen content is readily obvious. This should be evaluated based on the application and its intended operational function. If there is a cursor, it should be visible on the screen at all times while in use.

(10) Active regions

Active regions are regions to which special user commands apply. The active region can be text, a graphic image, a window, frame, or some other document object. These regions should be clearly indicated.

(11) Managing multiple open applications and documents

If the electronic document application supports multiple open documents, or the system allows multiple open applications, an indication of which application and/or document is active should be continuously provided. The active document is the one that is currently displayed and responds to user actions. The user should be able to select which of the open applications or documents is currently active. In addition, the user should be able to find which flight crew compartment applications are running and easily switch to any of these applications. When the user returns to an application that was running in the background, it should appear in the same state as when the user left that application, with the exception of differences stemming from the progress or completion of processing performed in the background.

(12) Flight crew workload

The positioning of the EFB and the procedures associated with its use should not result in undue flight crew workload. Complex, multi-step-data-entry tasks should be avoided during take-off, landing, and other critical phases of the flight. An evaluation of the EFB intended functions should include a qualitative assessment of the incremental flight crew workload, as well as the flight crew system interfaces and their safety implications.

AMC1 SPA.EFB.100(b)(3) Use of electronic flight bags (EFBs) – Operational approval

ED Decision 2019/008/R

EFB ADMINISTRATOR

The operator should appoint an EFB administrator responsible for the administration of the EFB system within the operator's organisation. The EFB administrator is the primary link between the operator and the EFB system and software suppliers.

The EFB administrator function may be contracted to an external organisation in accordance with [ORO.GEN.205](#).

Complex EFB systems may require more than one individual with appropriate authority within the operator's management structure to perform the administration process, but one person should be designated as the EFB administrator responsible for the complete system.

The EFB administrator is the person in overall charge of the EFB system, and should be responsible for ensuring that any hardware conforms to the required specification, and that no unauthorised software is installed. They should also be responsible for ensuring that only the current versions of the application software and data packages are installed on the EFB system.

The EFB administrator should be responsible:

- (a) For all the EFB applications installed, and for providing support to the EFB users regarding these applications;
- (b) For checking potential security issues associated with the applications installed;
- (c) For hardware and software configuration management of the EFBs, and, in particular, for ensuring that no unauthorised software is installed.

The EFB administrator should ensure that miscellaneous software applications do not adversely impact on the operation of the EFB and should include miscellaneous software applications in the scope of the configuration management of the EFB.

This does not preclude EFB devices from being allocated to specific flight crew members.

In those cases where it is demonstrated that miscellaneous software applications run in a way that is fully segregated and partitioned from the EFB or avionics applications (e.g. on a separate operating system on a distinct 'personal' hard drive partition that is selected when the EFB boots up), the administration of these miscellaneous software applications can be exercised by the flight crew members instead of by the EFB administrator.

- (d) For ensuring that only valid versions of the application software and current data packages are installed on the EFB system; and
- (e) For ensuring the integrity of the data packages used by the applications installed.

The operator should make arrangements to ensure the continuity of the management of the EFB system in the absence of the EFB administrator.

Each person involved in EFB administration should receive appropriate training for their role and should have a good knowledge of the proposed system hardware, operating system and relevant software applications, and also of the appropriate regulatory requirements related to the use of EFBs. The content of this training should be determined with the aid of the EFB system supplier or application supplier.

The operator should ensure that the persons involved in EFB administration keep their knowledge about the EFB system and its security up to date.

AMC2 SPA.EFB.100(b)(3) Use of electronic flight bags (EFBs) — Operational approval

ED Decision 2019/008/R

EFB POLICY AND PROCEDURES MANUAL

The operator should establish procedures, documented in an EFB policy and procedures manual, to ensure that no unauthorised changes take place. The EFB policy and procedures manual may be fully or partially integrated in the operations manual.

The EFB policy and procedures manual should also address means to ensure that the content and databases of the EFB are valid and up to date, in order to ensure the integrity of the EFB data. This may include establishing revision-control procedures so that flight crew members and others can ensure that the contents of the system are current and complete. These revision control procedures may be similar to the revision control procedures used for paper or other storage means.

The EFB policy and procedures manual should also clearly identify those parts of the EFB system that can be accessed and modified by the operator's EFB administration process and those parts that are only accessible by the EFB system supplier.

For data that is subject to a revision cycle control process, it should be readily evident to the user which revision cycle has been incorporated in the information obtained from the system. Procedures should specify what action to take if the applications or databases loaded on the EFB are outdated. This manual should at least include the following:

- (a) All EFB-related procedures, including:
 - (1) operating procedures;
 - (2) security procedures;
 - (3) maintenance procedures;
 - (4) software control procedures;
- (b) Management of changes to content/databases;
- (c) Notifications to crews of updates;
- (d) If any applications use information that is specific to the aircraft type or tail number, guidance on how to ensure that the correct information is installed on each aircraft;
- (e) Procedures to avoid corruption/errors when implementing changes to the EFB system; and
- (f) In cases involving multiple EFBs in the flight crew compartment, procedures to ensure that they all have the same content/databases installed.

The EFB administrator should be responsible for the procedures and systems documented in the EFB policy and procedures manual that maintain EFB security and integrity. This includes system security, content security, access security, and protection against malicious software.

AMC3 SPA.EFB.100(b)(3) Use of electronic flight bags (EFBs) – Operational approval

ED Decision 2019/008/R

PROCEDURES

- (a) General

If an EFB system generates information similar to that generated by existing certified systems, procedures should clearly identify which information source will be the primary, which source will be used for backup information, and under which conditions the backup source should be used. Procedures should define the actions to be taken by the flight crew when information provided by an EFB system is not consistent with that from other flight crew compartment sources, or when one EFB system shows different information than the other.

In the case of EFB applications providing information which might be affected by Notice(s) to Airmen NOTAMS (e.g. Airport moving map display (AMMD), performance calculation, etc.), the

procedure for the use of these applications should include the handling of the relevant NOTAMS before their use.

(b) Flight crew awareness of EFB software/database revisions

The operator should have a procedure in place to verify that the configuration of the EFB, including software application versions and, where applicable, database versions, are up to date. Flight crew members should have the ability to easily verify the validity of database versions used on the EFB. Nevertheless, flight crew members should not be required to confirm the revision dates for other databases that do not adversely affect flight operations, such as maintenance log forms or a list of airport codes. An example of a date-sensitive revision is that applied to an aeronautical chart database. Procedures should specify what actions should be taken if the software applications or databases loaded on the EFB system are outdated.

(c) Procedures to mitigate and/or control workload

Procedures should be designed to mitigate and/or control additional workload created by using an EFB system. The operator should implement procedures to ensure that, while the aircraft is in flight or moving on the ground, flight crew members do not become preoccupied with the EFB system at the same time. Workload should be shared between flight crew members to ensure ease of use and continued monitoring of other flight crew functions and aircraft equipment. These procedures should be strictly applied in flight and the operator should specify any times when the flight crew may not use a specific EFB application.

(d) Dispatch

The operator should establish dispatch criteria for EFB systems. The operator should ensure that the availability of the EFB system is confirmed by preflight checks. Instructions to the flight crew should clearly define the actions to be taken in the event of any EFB system deficiency.

Mitigation should be in the form of maintenance and/or operational procedures for items such as:

- (1) replacement of batteries at defined intervals as required;
- (2) ensuring there is a fully charged backup battery on board;
- (3) the flight crew checking the battery charging level before departure; and
- (4) the flight crew switching off the EFB in a timely manner when the aircraft power source is lost.

In the event of a partial or complete failure of the EFB, specific dispatch procedures should be followed. These procedures should be included either in the minimum equipment list (MEL) or in the operations manual, and should ensure an acceptable level of safety.

Particular attention should be paid to establishing specific dispatch procedures allowing to obtain operational data (e.g. performance data) in case of a failure of an EFB hosting an application that normally provides such calculated data.

When the integrity of data input and output is verified by cross-checking and gross-error checks, the same checking principle should be applied to alternative dispatch procedures to ensure equivalent protection.

(e) Maintenance

Procedures should be established for the routine maintenance of the EFB system and detailing how unserviceability and failures are to be dealt with to ensure that the integrity of the EFB system is preserved. Maintenance procedures should also include the secure handling of

updated information and how this information is validated and then promulgated in a timely manner and in a complete format to all users.

As part of the EFB system's maintenance, the operator should ensure that the EFB system batteries are periodically checked and replaced as required.

Should faults or failures of the system arise, it is essential that such failures are brought to the immediate attention of the flight crew and that the system is isolated until rectification action is taken. In addition to backup procedures to deal with system failures, a reporting system should be in place so that the necessary corrective action, either to a particular EFB system or to the whole system, is taken in order to prevent the use of erroneous information by flight crew members.

(f) Security

The EFB system (including any means used for updating it) should be secure from unauthorised intervention (e.g. by malicious software). The operator should ensure that adequate security procedures are in place to protect the system at the software level and to manage the hardware (e.g. the identification of the person to whom the hardware is released, protected storage when the hardware is not in use) throughout the operational lifetime of the EFB system. These procedures should guarantee that, prior to each flight, the EFB operational software works as specified and the EFB operational data is complete and accurate. Moreover, a system should be in place to ensure that the EFB does not accept a data load that contains corrupted contents. Adequate measures should be in place for the compilation and secure distribution of data to the aircraft.

Procedures should be transparent and easy to understand to follow and to oversee that:

- (1) if an EFB is based on consumer electronics (e.g. a laptop) which can be easily removed, manipulated, or replaced by a similar component, that special consideration is given to the physical security of the hardware;
- (2) portable EFB platforms are subject to allocation tracking to specific aircraft or persons;
- (3) where a system has input ports, and especially if widely known protocols are used through these ports, or internet connections are offered, that special consideration is given to the risks associated with these ports;
- (4) where physical media are used to update the EFB system, and especially if widely known types of physical media are used, that the operator uses technologies and/or procedures to assure that unauthorised content cannot enter the EFB system through these media.

The required level of EFB security depends on the criticality of the functions used (e.g. an EFB that only holds a list of fuel prices may require less security than an EFB used for performance calculations).

Beyond the level of security required to assure that the EFB can properly perform its intended functions, the level of security that is ultimately required depends on the capabilities of the EFB.

(g) Electronic signatures

Part-CAT and Part-M may require a signature when issuing or accepting a document (e.g. load sheet, technical logbook, notification to captain (NOTOC)). In order to be accepted as being equivalent to a handwritten signature, electronic signatures used in EFB applications need, as a minimum, to fulfil the same objectives and to assure the same degree of security as the handwritten or any other form of signature that they are intended to replace. [AMC1](#)

[CAT.POL.MAB.105\(c\)](#) provides the means to comply with the required handwritten signature or its equivalent for mass and balance documentation.

On a general basis, in the case of required signatures, an operator should have in place procedures for electronic signatures that guarantee:

- (1) their uniqueness: a signature should identify a specific individual and should be difficult to duplicate;
- (2) their significance: an individual using an electronic signature should take deliberate and recognisable action to affix their signature;
- (3) their scope: the scope of the information being affirmed with an electronic signature should be clear to the signatory and to the subsequent readers of the record, record entry, or document;
- (4) their security: the security of an individual's handwritten signature is maintained by ensuring that it is difficult for another individual to duplicate or alter it;
- (5) their non-repudiation: an electronic signature should prevent a signatory from denying that they affixed a signature to a specific record, record entry, or document; the more difficult it is to duplicate a signature, the likelier it is that the signature was created by the signatory; and
- (6) their traceability: an electronic signature should provide positive traceability to the individual who signed a record, record entry, or any other document.

An electronic signature should retain those qualities of a handwritten signature that guarantee its uniqueness. Systems using either a PIN or a password with limited validity (timewise) may be appropriate in providing positive traceability to the individual who affixed it. Advanced electronic signatures, qualified certificates and secured signature-creation devices needed to create them in the context of Regulation (EU) No 910/2014¹ are typically not required for EFB operations.

AMC4 SPA.EFB.100(b)(3) Use of electronic flight bags (EFBs) – Operational approval

ED Decision 2019/008/R

FLIGHT CREW TRAINING

- (a) Flight crew members should be given specific training on the use of the EFB system before it is operationally used.

Training should at least include the following:

- (1) an overview of the system architecture;
- (2) preflight checks of the system;
- (3) limitations of the system;
- (4) specific training on the use of each application and the conditions under which the EFB may and may not be used;

¹ Regulation (EU) No 910/2014 of the European Parliament and of the Council of 23 July 2014 on electronic identification and trust services for electronic transactions in the internal market and repealing Directive 1999/93/EC (OJ L 257, 28.8.2014, p. 73).

- (5) restrictions on the use of the system, including cases where the entire system, or some parts of it, are not available;
- (6) procedures for normal operations, including cross-checking of data entry and computed information;
- (7) procedures to handle abnormal situations, such as a late runway change or a diversion to an alternate aerodrome;
- (8) procedures to handle emergency situations;
- (9) phases of the flight when the EFB system may and may not be used;
- (10) human factors considerations, including crew resource management (CRM), on the use of the EFB; and
- (11) additional training for new applications or changes to the hardware configuration.

As far as practicable, it is recommended that the training simulator environments should include the EFBs in order to offer a higher level of representativeness.

Consideration should also be given to the role that the EFB system plays in operator proficiency checks as part of recurrent training and checking, and to the suitability of the training devices used during training and checking.

EFB training should be included in the relevant training programme established and approved in accordance with ORO.FC.

(b) EFB training and checking

(1) Assumptions regarding flight crew members' previous experience

Training for the use of the EFB should be for the purpose of operating the EFB itself and the applications hosted on it, and should not be intended to provide basic competence in areas such as aircraft performance, etc. Initial EFB training, therefore, should assume basic competence in the functions addressed by the software applications installed.

Training should be adapted to the flight crew's experience and knowledge.

(2) Programmes crediting previous EFB experience

Training programmes for the EFB may give credit for trainees' previous EFB experience. For example, previous experience of an aircraft performance application hosted on a portable EFB and using similar software may be credited towards training on an installed EFB with a performance application.

(3) Initial EFB training

Training required for the granting of an aircraft type rating may not recognise variants within the type nor the installation of particular equipment. Any training for the granting of a type qualification need not, therefore, recognise the installation or the use of an EFB unless it is installed equipment across all variants of the type. However, where training for the issuing of the type rating is combined with the operator's conversion course, the training syllabus should recognise the installation of the EFB where the operator's standard operating procedures (SOPs) are dependent on its use.

Initial EFB training may consist of both ground-based and flight training, depending on the nature and complexity of the EFB system. An operator or approved training organisation (ATO) may use many methods for ground-based EFB training including written handouts or flight crew operating manual (FCOM) material, classroom

instruction, pictures, videotapes, ground training devices, computer-based instruction, flight simulation training devices (FSTDs), and static aircraft training. Ground-based training for a sophisticated EFB lends itself particularly to computer-based training (CBT). Flight EFB training should be performed by a suitably qualified person during line flying under supervision (LIFUS) or during differences or conversion training.

The following areas of emphasis should be considered when defining the initial EFB training programme:

- (i) The use of the EFB hardware and the need for proper adjustment of lighting, etc., when the system is used in flight;
 - (ii) The intended use of each software application together with any limitations or prohibitions on its use;
 - (iii) Proper cross-checking of data inputs and outputs if an aircraft performance application is installed,;
 - (iv) Proper verification of the applicability of the information being used if a terminal chart application is installed;
 - (v) The need to avoid fixation on the map display if a moving map display is installed;;
 - (vi) Handling of conflicting information;
 - (vii) Failures of component(s) of the EFB; and
 - (viii) Actions to be taken following the failure of component(s) of the EFB, including cases of battery smoke or fire.
- (4) Initial EFB checking
- (i) Initial ground EFB checking
The check performed following the ground-based element of initial EFB training may be accomplished by the use of a questionnaire (oral or written) or as an automated component of the EFB CBT, depending on the nature of the training performed.
 - (ii) Skill test and proficiency check
Where the operator's SOPs are dependent on the use of the EFB on the particular aircraft type or variant, proficiency in the use of the EFB should be assessed in the appropriate areas (e.g. item 1.1, item 1.5, etc., of Appendix 9 to Annex I (Part-FCL) to Commission Regulation (EU) No 1178/2011).
 - (iii) Operator proficiency check
Where an operator's SOPs are dependent on the use of an EFB, proficiency in its use should be assessed during the operator proficiency check (OPC). Where the OPC is performed on an FSTD not equipped with the operator's EFB, proficiency should be assessed by another acceptable means.
 - (iv) Line check
Where an operator's SOPs are dependent on the use of an EFB, proficiency in its use should be assessed during a line check.

- (v) Areas of emphasis during EFB checking:
 - (A) Proficiency in the use of each EFB application installed;
 - (B) Proper selection and use of EFB displays;
 - (C) Where an aircraft performance application is installed, proper cross-checking of data inputs and outputs;
 - (D) Where a chart application is installed, proper checking of the validity of the information and the use of the chart clip function;
 - (E) Where a moving map display is installed, maintenance of a proper outside visual scan without prolonged fixation on the EFB, especially during taxiing; and
 - (F) Actions to be taken following the failure of component(s) of the EFB, including cases of battery smoke or fire.

(c) Differences or familiarisation training

When the introduction of the use of an EFB requires differences or familiarisation training to be carried out, the elements of initial EFB training should be used, as described above.

(d) Recurrent EFB training and checking

(1) Recurrent EFB training

Recurrent training is normally not required for the use of an EFB, provided the functions are used regularly in line operations. Operators should, however, include normal EFB operations as a component of the annual ground and refresher training.

In the case of mixed-fleet operations, or where the EFB is not installed across the fleet, additional recurrent training should be provided.

(2) Recurrent EFB checking

Recurrent EFB checking should be integrated in those elements of the licence proficiency check, the operator proficiency check and the line check applicable to the use of an EFB.

(e) Suitability of training devices

Where the operator's SOPs are dependent on the use of an EFB, the EFB should be present during the operator's training and checking. Where present, the EFB should be configured and operable in all respects as per the relevant aircraft. This should apply to:

- (1) the operator's conversion course;
- (2) differences or familiarisation training; and
- (3) recurrent training and checking.

Where the EFB system is based on a portable device used without any installed resources, it is recommended that the device should be present, operable, and used during all phases of the flight during which it would be used under the operator's SOPs.

For all other types of EFB systems, it is recommended that the device should be installed and operable in the training device (e.g. an FFS) and used during all phases of the flight during which it would be used under the operator's SOPs. However, an operator may define an alternative means of compliance when the operator's EFB system is neither installed nor operable in the training device.

Note: It is not necessary for the EFB to be available for those parts of the training and checking that are not related to the operator or to the operator's SOPs.

AMC5 SPA.EFB.100(b)(3) Use of electronic flight bags (EFBs) – Operational approval

ED Decision 2019/008/R

PERFORMANCE AND MASS AND BALANCE APPLICATIONS

(a) General

Performance and mass and balance applications should be based on existing published data found in the AFM or performance manual, and should account for the applicable CAT.POL performance requirements. The applications may use algorithms or data spreadsheets to determine results. They may have the capability to interpolate within the information contained in the published data for the particular aircraft but they should not extrapolate beyond it.

To protect against intentional and unintentional modifications, the integrity of the database files related to performance and to mass and balance (the performance database, airport database, etc.) should be checked by the program before performing any calculations. This check can be run once at the start-up of the application.

Each software version should be identified by a unique version number. The compatibility between specific modules of a performance or mass and balance software application and the specific software revisions installed on a specific host (e.g. model of computer) should be ensured. The performance and mass and balance applications should record each computation performed (inputs and outputs) and the operator should have procedures in place to retain this information for at least 3 months.

The operator should ensure that aircraft performance or mass and balance data provided by the application is correct compared with the data derived from the AFM (e.g. for take-off and landing performance data) or from other reference data sources (e.g. mass and balance manuals or databases, in-flight performance manuals or databases) under a representative cross-check of conditions (e.g. for take-off and landing performance applications: take-off and landing performance data on dry, wet, and contaminated runways, with different wind conditions and aerodrome pressure altitudes, etc.).

The operator should establish procedures to define any new roles that the flight crew and, if applicable, the flight dispatcher, may have in creating, reviewing, and using performance calculations supported by EFB systems. In particular, the procedures should address cases where discrepancies are identified by the flight crew.

(b) Testing

The demonstration of the compliance of a performance or mass and balance application should include evidence of the software testing activities performed with the software version candidate for operational use.

The testing can be performed by either the operator or a third party, as long as the testing process is documented and the responsibilities are identified.

The testing activities should include human-machine interface (HMI) testing, reliability testing, and accuracy testing.

HMI testing should demonstrate that the application is not prone to error and that calculation errors can be detected by the flight crew with the proposed procedures. The testing should

demonstrate that the applicable HMI guidelines are followed and that the HMI is implemented as specified by the application developer and in paragraph (f).

Reliability testing should show that the application in its operating environment (operating system (OS) and hardware included) is stable and deterministic, i.e. identical answers are generated each time the process is entered with identical parameters.

Accuracy testing should demonstrate that the aircraft performance or mass and balance computations provided by the application are correct in comparison with data derived from the AFM or other reference data sources, under a representative cross section of conditions (e.g. for take-off and landing performance applications: runway state and slope, different wind conditions and pressure altitudes, various aircraft configurations including failures with a performance impact, etc.).

The demonstration should include a sufficient number of comparison results from representative calculations throughout the entire operating envelope of the aircraft, considering corner points, routine and break points.

Any difference compared to the reference data that is judged significant should be examined and explained. When differences are due to more conservative calculations or reduced margins that were purposely built into the approved data, this approach should be clearly mentioned. Compliance with the applicable certification and operational rules needs to be demonstrated in any case.

The testing method should be described. The testing may be automated when all the required data is available in an appropriate electronic format, but in addition to performing thorough monitoring of the correct functioning and design of the testing tools and procedures, operators are strongly suggested to perform additional manual verification. It could be based on a few scenarios for each chart or table of the reference data, including both operationally representative scenarios and 'corner-case' scenarios.

The testing of a software revision should, in addition, include non-regression testing and testing of any fix or change.

Furthermore, an operator should perform tests related to its customisation of the applications and to any element pertinent to its operation that was not covered at an earlier stage (e.g. airport database verification).

(c) Procedures

Specific care is needed regarding the flight crew procedures concerning take-off and landing performance or mass and balance applications. The flight crew procedures should ensure that:

- (1) calculations are performed independently by each flight crew member before data outputs are accepted for use;
- (2) a formal cross-check is made before data outputs are accepted for use; such cross-checks should utilise the independent calculations described above, together with the output of the same data from other sources on the aircraft;
- (3) a gross-error check is performed before data outputs are accepted for use; such gross-error checks may use either a 'rule of thumb' or the output of the same data from other sources on the aircraft; and
- (4) in the event of a loss of functionality of an EFB through either the loss of a single application, or the failure of the device hosting the application, an equivalent level of

safety can be maintained; consistency with the EFB risk assessment assumptions should be confirmed.

(d) Training

The training should emphasise the importance of executing all take-off and landing performance or mass and balance calculations in accordance with the SOPs to assure fully independent calculations.

Furthermore, due to optimisations included at various levels in performance applications, flight crew members may be confronted with new procedures and different aircraft behaviour (e.g. the use of multiple flap settings for take-off). The training should be designed and provided accordingly.

Where an application allows the computing of both dispatch results (from regulatory or factored calculations) and other results, the training should highlight the specificities of those results. Depending on the representativeness of the calculations, flight crew members should be trained on any operational margins that might be required.

The training should also address the identification and the review of default values, if any, and assumptions about the aircraft status or environmental conditions made by the application.

(e) Specific considerations for mass and balance applications

In addition to the figures, a diagram displaying the mass and its associated centre-of-gravity (CG) position should be provided.

(f) Human-factors-specific considerations

Input and output data (i.e. results) shall be clearly separated from each other. All the information necessary for a given calculation task should be presented together or be easily accessible.

All input and output data should include correct and unambiguous terms (names), units of measurement (e.g. kg or lb), and, when applicable, an index system and a CG-position declaration (e.g. Arm/%MAC). The units should match the ones from the other flight-crew-compartment sources for the same kind of data.

Airspeeds should be provided in a form that is directly useable in the flight crew compartment, unless the unit clearly indicates otherwise (e.g. Knots Calibrated Air Speed (KCAS)). Any difference between the type of airspeed provided by the EFB application and the type provided by the aircraft flight manual (AFM) or flight crew operating manual (FCOM) performance charts should be mentioned in the flight crew guides and training material.

If the landing performance application allows the computation of both dispatch (regulatory, factored) and other results (e.g. in-flight or unfactored), flight crew members should be made aware of the computation mode used.

(1) Inputs:

The application should allow users to clearly distinguish user entries from default values or entries imported from other aircraft systems.

Performance applications should enable the flight crew to check whether a certain obstacle is included in the performance calculations and/or to include new or revised obstacle information in the performance calculations.

(2) Outputs:

All critical assumptions for performance calculations (e.g. the use of thrust reversers, full or reduced thrust/power rating) should be clearly displayed. The assumptions made about any calculation should be at least as clear to the flight crew members as similar information would be on a tabular chart.

All output data should be available in numbers.

The application should indicate when a set of entries results in an unachievable operation (for instance, a negative stopping margin) with a specific message or colour scheme. This should be done in accordance with the relevant provisions on messages and the use of colours.

In order to allow a smooth workflow and to prevent data entry errors, the layout of the calculation outputs should be such that it is consistent with the data entry interface of the aircraft applications in which the calculation outputs are used (e.g. flight management systems).

(3) Modifications:

The user should be able to easily modify performance calculations, especially when making last minute changes.

The results of calculations and any outdated input fields should be deleted whenever:

- (i) modifications are entered;
- (ii) the EFB is shut down or the performance application is closed; or
- (iii) the EFB or the performance application has been in a standby or 'background' mode for too long, i.e. such that it is likely that when it is used again, the inputs or outputs will be outdated.

AMC6 SPA.EFB.100(b)(3) Use of electronic flight bags (EFBs) – Operational approval

ED Decision 2019/008/R

AIRPORT MOVING MAP DISPLAY (AMMD) APPLICATION WITH OWN-SHIP POSITION

(a) General

An AMMD application should not be used as the primary means of navigation for taxiing and should be only used in conjunction with other materials and procedures identified within the operating concept (see paragraph e)).

When an AMMD is in use, the primary means of navigation for taxiing remains the use of normal procedures and direct visual observation out of the flight-crew-compartment window.

Thus, as recognised in ETSO-C165a, an AMMD application with a display of own-ship position is considered to have a minor safety effect for malfunctions that cause the incorrect depiction of aircraft position (own-ship), and the failure condition for the loss of function is classified as 'no safety effect'.

(b) Minimum requirements

AMMD software that complies with European Technical Standard Order ETSO-C165a is considered to be acceptable.

In addition, the system should provide the means to display the revision number of the software installed.

To achieve the total system accuracy requirements of ETSO-C165a, an airworthiness-approved sensor using the global positioning system (GPS) in combination with a medium-accuracy database compliant with EUROCAE ED-99C/RTCA DO-272C, 'User Requirements for Aerodrome Mapping Information,' (or later revisions) is considered one acceptable means.

Alternatively, the use of non-certified commercial off-the-shelf (COTS) position sources may be acceptable in accordance with [AMC7 SPA.EFB.100\(b\)\(3\)](#).

(c) Data provided by the AMMD software application developer

The operator should ensure that the AMMD software application developer provides the appropriate data including:

- (1) installation instructions or the equivalent as per ETSO-C165a Section 2.2 that address:
 - (i) the identification of each specific EFB system computing platform (including the hardware platform and the operating system version) with which this AMMD software application and database was demonstrated to be compatible;
 - (ii) the installation procedures and limitations for each applicable platform (e.g. required memory resources, configuration of Global Navigation Satellite System (GNSS) antenna position);
 - (iii) the interface description data including the requirements for external sensors providing data inputs; and
 - (iv) means to verify that the AMMD has been installed correctly and is functioning properly.
- (2) any AMMD limitations, and known installation, operational, functional, or performance issues of the AMMD.

(d) AMMD software installation in the EFB

The operator should review the documents and the data provided by the AMMD developer, and ensure that the installation requirements of the AMMD software in the specific EFB platform and aircraft are addressed. Operators are required to perform any verification activities proposed by the AMMD software application developer, as well as identify and perform any additional integration activities that need to be completed; and

(e) Operational procedures

Changes to operational procedures of the aircraft (e.g. flight crew procedures) should be documented in the operations manual or user's guide as appropriate. In particular, the documentation should highlight that the AMMD is only designed to assist flight crew members in orienting themselves on the airport surface so as to improve the flight crew members' positional awareness during taxiing, and that it is not to be used as the basis for ground manoeuvring.

(f) Training requirements

The operator may use flight crew procedures to mitigate some hazards. These should include limitations on the use of the AMMD function or application. As the AMMD could be a compelling display and the procedural restrictions are a key component of the mitigation, training should be provided in support of an AMMD.

All mitigation means that rely on flight crew procedures should be included in the flight crew training. Details of the AMMD training should be included in the operator's overall EFB training.

AMC7 SPA.EFB.100(b)(3) Use of electronic flight bags (EFBs) – Operational approval

ED Decision 2019/008/R

USE OF COMMERCIAL OFF-THE-SHELF (COTS) POSITION SOURCE

COTS position sources may be used for AMMD EFB applications and for EFB applications displaying the own-ship position in-flight when the following considerations are complied with:

(a) Characterisation of the receiver:

The position should originate from an airworthiness approved GNSS receiver, or from a COTS GNSS receiver fully characterised in terms of technical specifications and featuring an adequate number of channels (12 or more).

The EFB application should, in addition to position and velocity data, receive a sufficient number of parameters related to the fix quality and integrity to allow compliance with the accuracy requirements (e.g. the number of satellites and constellation geometry parameters such as dilution of position (DOP), 2D/3D fix).

(b) Installation aspects:

If the COTS position sources are stand-alone PEDs, they should be treated as C-PEDs and their installation and use should follow the requirements of [CAT.GEN.MPA.140](#).

If an external COTS position source transmits wirelessly, cyber security aspects have to be considered.

Non-certified securing systems should be assessed according to paragraph (h) of [AMC1 CAT.GEN.MPA.141\(a\)](#).

(c) Practical evaluation:

As variables can be introduced by the placement of the antennas in the aircraft and the characteristics of the aircraft itself (e.g. heated and/or shielded windshield effects), the tests have to take place on the type of aircraft in which the EFB will be operated, with the antenna positioned at the location to be used in service.

(1) COTS used as a position source for AMMD

The test installation should record the data provided by the COTS position source to the AMMD application.

The analysis should use the recorded parameters to demonstrate that the AMMD requirements are satisfactorily complied with in terms of the total system accuracy (taking into account database errors, latency effects, display errors, and uncompensated antenna offsets) within 50 metres (95 %). The availability should be sufficient to prevent distraction or increased workload due to frequent loss of position.

When demonstrating compliance with the following requirements of DO-257A, the behaviour of the AMMD system should be evaluated in practice:

- (i) indication of degraded position accuracy within 1 second (Section 2.2.4 (22)); and

- (ii) indication of a loss of positioning data within 5 seconds (Section 2.2.4 (23)); conditions to consider are both a loss of the GNSS satellite view (e.g. antenna failure) and a loss of communication between the receiver and the EFB.
- (2) COTS position source used for applications displaying own-ship position in flight:
- Flight trials should demonstrate that the COTS GNSS availability is sufficient to prevent distraction or increased workload due to frequent loss of position.

AMC8 SPA.EFB.100(b)(3) Use of electronic flight bags (EFBs) – Operational approval

ED Decision 2019/008/R

CHART APPLICATIONS

The navigation charts that are depicted should contain the information necessary, in an appropriate form, to perform the operation safely. Consideration should be given to the size, resolution and position of the display to ensure legibility whilst retaining the ability to review all the information required to maintain adequate situational awareness.

In the case of chart application displaying own-ship position in-flight, [AMC10 SPA.EFB.100\(b\)\(3\)](#) is applicable.

AMC9 SPA.EFB.100(b)(3) Use of electronic flight bags (EFBs) – Operational approval

ED Decision 2019/008/R

IN-FLIGHT WEATHER APPLICATIONS

(a) General

An in-flight weather (IFW) application is an EFB function or application enabling the flight crew to access meteorological information. It is designed to increase situational awareness and to support the flight crew when making strategic decisions.

An IFW function or application may be used to access both information required to be on board (e.g. World Area Forecast Centre (WAFC) data) and supplemental weather information.

The use of IFW applications should be non-safety-critical and not necessary for the performance of the flight. In order for it to be non-safety-critical, IFW data should not be used to support tactical decisions and/or as a substitute for certified aircraft systems (e.g. weather radar).

Any current information from the meteorological documentation required to be carried on board or from aircraft primary systems should always prevail over the information from an IFW application.

The displayed meteorological information may be forecasted and/or observed, and may be updated on the ground and/or in flight. It should be based on data from certified meteorological service providers or other reliable sources evaluated by the operator.

The meteorological information provided to the flight crew should be, as far as possible, consistent with the information available to users of ground-based aviation meteorological information (e.g. operations control centre (OCC) staff, flight dispatchers, etc.) in order to establish common situational awareness and to facilitate collaborative decision-making.

(b) Display

Meteorological information should be presented to the flight crew in a format that is appropriate to the content of the information; coloured graphical depiction is encouraged whenever practicable.

The IFW display should enable the flight crew to:

- (1) distinguish between observed and forecasted weather data;
- (2) identify the currency or age and validity time of the weather data;
- (3) access the interpretation of the weather data (e.g. the legend);
- (4) obtain positive and clear indications of any missing information or data and determine areas of uncertainty when making decisions to avoid hazardous weather; and
- (5) be aware of the status of the data link that enables the necessary IFW data exchanges.

Meteorological information in IFW applications may be displayed, for example, as an overlay over navigation charts, over geographical maps, or it may be a stand-alone weather depiction (e.g. radar plots, satellite images, etc.).

If meteorological information is overlaid on navigation charts, special consideration should be given to HMI issues in order to avoid adverse effects on the basic chart functions.

In case of display of own-ship position in flight, [AMC10 SPA.EFB.100\(b\)\(3\)](#) is applicable.

The meteorological information may require reformatting to accommodate for example the display size or the depiction technology. However, any reformatting of the meteorological information should preserve both the geo-location and intensity of the meteorological conditions regardless of projection, scaling, or any other types of processing.

(c) Training and procedures

The operator should establish procedures for the use of an IFW application.

The operator should provide adequate training to the flight crew members before using an IFW application. This training should address:

- (1) limitations of the use of an IFW application:
 - (i) acceptable use (strategic planning only);
 - (ii) information required to be on board; and
 - (iii) latency of observed weather information and the hazards associated with utilisation of old information;
- (2) information on the display of weather data:
 - (i) type of displayed information (forecasted, observed);
 - (ii) symbology (symbols, colours); and
 - (iii) interpretation of meteorological information;
- (3) identification of failures and malfunctions (e.g. incomplete uplinks, data-link failures, missing info);
- (4) human factors issues:
 - (i) avoiding fixation; and

- (ii) managing workload.

AMC10 SPA.EFB.100(b)(3) Use of electronic flight bags (EFBs) – Operational approval

ED Decision 2019/019/R

APPLICATIONS DISPLAYING OWN-SHIP POSITION IN FLIGHT

(a) Limitations

The display of own-ship position in flight as an overlay to other EFB applications should not be used as a primary source of information to fly or navigate the aircraft.

Except on VFR flights over routes navigated by reference to visual landmark, the display of the own-ship symbol is allowed only in aircraft having a certified navigation display (moving map).

In the specific case of IFW applications, the display of own-ship on such applications is restricted to aircraft equipped with a weather radar.

(b) Position source and accuracy

The display of own-ship position may be based on a certified GNSS or GNSS-based (e.g. GPS/IRS) position from certified aircraft equipment or on a portable COTS position source in accordance with [AMC7 SPA.EFB.100\(b\)\(3\)](#).

The own-ship symbol should be removed and the flight crew notified if:

- (1) the position source indicates a degraded accuracy. The threshold to consider that the accuracy is degraded should be commensurate with the navigation performance required for the current phase of flight and should not exceed 200 m when the own-ship is displayed above a terminal chart (i.e. SID, STAR, or instrument approach) or a depiction of a terminal procedure;
- (2) the position data is reported as invalid by the GNSS receiver; or
- (3) the position data is not received for 5 seconds.

(c) Charting data considerations

If the map involves raster images that have been stitched together into a larger single map, it should be demonstrated that the stitching process does not introduce distortion or map errors that would not correlate properly with a GNSS-based own-ship symbol.

(d) Human machine interface (HMI)

(1) Interface

The flight crew should be able to unambiguously differentiate the EFB function from avionics functions available in the cockpit, and in particular with the navigation display.

A sufficiently legible text label 'AIRCRAFT POSITION NOT TO BE USED FOR NAVIGATION' or equivalent should be continuously displayed by the application if the own-ship position depiction is visible in the current display area over a terminal chart (i.e. SID, STAR, or instrument approach) or a depiction of a terminal procedure.

(2) Display of own-ship symbol

The own-ship symbol should be different from the ones used by certified aircraft systems intended for primary navigation.

If directional data is available, the own-ship symbol may indicate directionality. If direction is not available, the own-ship symbol should not imply directionality.

The colour coding should not be inconsistent with the manufacturer philosophy.

(3) Data displayed

The current map orientation should be clearly, continuously and unambiguously indicated (e.g., Track-up vs North-up).

If the software supports more than one directional orientation for the own-ship symbol (e.g., Track-up vs North-up), the current own-ship symbol orientation should be indicated.

The chart display in track-up mode should not create usability or readability issues. In particular, chart data should not be rotated in a manner that affects readability.

The application zoom levels should be appropriate for the function and content being displayed and in the context of providing supplemental position awareness.

The pilot should be able to obtain information about the operational status of the own-ship function (e.g. active, deactivated, degraded).

During IFR, day-VFR without visual references or night VFR flight, the following parameters' values should not be displayed:

- (i) Track/heading;
- (ii) Estimated time of arrival (ETA);
- (iii) Altitude;
- (iv) Geographical coordinates of the current location of the aircraft; and
- (v) Aircraft speed.

(4) Controls

If a panning and/or range selection function is available, the EFB application should provide a clear and simple method to return to an own-ship-oriented display.

A means to disable the display of the own-ship position should be provided to the flight crew.

(e) Training and procedures

The procedures and training should emphasise the fact that the display of own-ship position on charts or IFW EFB applications should not be used as a primary source of information to fly or navigate the aircraft or as a primary source of weather information.

(1) Procedures:

The following considerations should be addressed in the procedures for the use of charts or IFW EFB application displaying the own-ship position in flight by the flight crew:

- (i) Intended use of the display of own-ship position in flight on charts or IFW EFB applications;
- (ii) Inclusion of the EFB into the regular scan of flight deck systems indications. In particular, systematic cross-check with avionics before being used, whatever the position source; and

- (iii) Actions to be taken in case of identification of a discrepancy between the EFB and avionics.
- (2) Training:

Crew members should be trained on the procedures for the use of the application, including the regular cross-check with avionics and the action in case of discrepancy.

GM1 SPA.EFB.100(b)(3) Use of electronic flight bags (EFBs) – Operational approval

ED Decision 2019/008/R

EFB POLICY AND PROCEDURES MANUAL

The items that follow are the typical contents of an EFB policy and procedures manual that can be part of the operations manual. The proposed outline is very extensive. It may be adapted to the specific EFB system and to the size and complexity of the operations in which the operator is involved.

- (a) Revision history;
- (b) List of effective pages or paragraphs;
- (c) Table of contents;
- (d) Introduction:
 - (1) Glossary of terms and acronyms;
 - (2) EFB general philosophy, environment, and dataflow;
 - (3) EFB system architecture;
 - (4) Limitations of the EFB system;
 - (5) Hardware description;
 - (6) Operating system description;
 - (7) Detailed presentation of the EFB applications;
 - (8) EFB application customisation;
 - (9) Data management:
 - (i) data administration;
 - (ii) organisation and workflows;
 - (iii) data loading;
 - (iv) data revision mechanisms;
 - (v) approval workflow;
 - (vi) data publishing and dispatch;
 - (vii) customisation;
 - (viii) how to manage operator-specific documents;
 - (ix) airport data management;
 - (x) aircraft fleet definition;

- (10) Data authoring:
 - (i) navigation and customisation;
- (e) Hardware and operating system control and configuration:
 - (1) Purpose and scope;
 - (2) Description of the following processes:
 - (i) hardware configuration and part number control;
 - (ii) operating system configuration and control;
 - (iii) accessibility control;
 - (iv) hardware maintenance;
 - (v) operating system updating;
 - (3) Responsibilities and accountability;
 - (4) Records and filing;
 - (5) Documentary references;
- (f) Software application control and configuration:
 - (1) Purpose and scope;
 - (2) Description of the following processes:
 - (i) version control;
 - (ii) software configuration management;
 - (iii) application updating process;
 - (3) Responsibilities and accountability;
 - (4) Records and filing;
 - (5) Documentary references;
- (g) Flight crew:
 - (1) Training;
 - (2) Operating procedures (normal, abnormal, and emergency);
- (h) Maintenance considerations;
 - (i) EFB security policy:
 - (1) Security solutions and procedures.

GM2 SPA.EFB.100(b)(3) Use of electronic flight bags (EFBs) – Operational approval

ED Decision 2019/008/R

FLIGHT CREW TRAINING

The following might be a typical training syllabus, provided that it does not contradict the operational suitability data established in accordance with Regulation (EU) No 748/2012.

-
- (a) Ground-based training:
- (1) System architecture overview;
 - (2) Display unit features and use;
 - (3) Limitations of the system;
 - (4) Restrictions on the use of the system:
 - (i) phases of the flight;
 - (ii) alternate procedures (e.g. MEL);
 - (5) Applications as installed;
 - (6) Use of each application;
 - (7) Restrictions on the use of each application:
 - (i) phases of the flight;
 - (ii) alternate procedures (e.g. MEL);
 - (8) Data input;
 - (9) Cross-checking of data inputs and outputs;
 - (10) Use of data outputs;
 - (11) Alternate procedures (e.g. MEL);
- (b) Flight training:
- (1) Practical use of the display unit;
 - (2) Display unit controls;
 - (3) Data input devices;
 - (4) Selection of applications;
 - (5) Practical use of applications;
 - (6) Human factors considerations, including CRM;
 - (7) Situational awareness;
 - (8) Avoidance of fixation;
 - (9) Cross-checking of data inputs and outputs;
 - (10) Practical integration of EFB procedures into SOPs;
 - (11) Actions following the failure of component(s) of the EFB, including cases of battery smoke or fire; and
 - (12) Management of conflicting information.

GM3 SPA.EFB.100(b)(3) Use of electronic flight bags (EFBs) – Operational approval

ED Decision 2019/008/R

SECURITY

Examples of typical safety and security defences are contained in the following non-exhaustive list:

- (a) Individual system firewalls;
- (b) The clustering of systems with similar safety standards into domains;
- (c) Data encryption and authentication;
- (d) Virus scans;
- (e) Keeping the OS up to date;
- (f) Initiating air–ground connections only when required and always from the aircraft;
- (g) ‘Whitelists’ for allowed internet domains;
- (h) Virtual private networks (VPNs);
- (i) Granting of access rights on a need-to-have basis;
- (j) Troubleshooting procedures that consider security threats as potential root causes of EFB misbehaviour, and provide for responses to be developed to prevent future successful attacks when relevant;
- (k) Virtualisation; and
- (l) Forensic tools and procedures.

GM4 SPA.EFB.100(b)(3) Use of electronic flight bags (EFBs) – Operational approval

ED Decision 2019/008/R

IN-FLIGHT WEATHER (IFW) APPLICATIONS

‘Reliable sources’ of data used by IFW applications are the organisations evaluated by the operator as being able to provide an appropriate level of data assurance in terms of accuracy and integrity. It is recommended that the following aspects be considered during that evaluation:

- (a) The organisation should have a quality assurance system in place that covers the data source selection, acquisition/import, processing, validity period check, and the distribution phase;
- (b) Any meteorological product provided by the organisation that is within the scope of the meteorological information included in the flight documentation as defined in MET.TR.215(e) (Annex V (Definitions of terms used in Annexes II to XIII) to Commission Implementing Regulation (EU) 2016/1377¹) should originate only from authoritative sources or certified providers and should not be transformed or altered, except for the purpose of packaging the data in the correct format. The organisation’s process should provide assurance that the integrity of those products is preserved in the data for use by the IFW application.

¹ Commission Implementing Regulation (EU) 2016/1377 of 4 August 2016 laying down common requirements for service providers and the oversight in air traffic management/air navigation services and other air traffic management network functions, repealing Regulation (EC) No 482/2008, Implementing Regulations (EU) No 1034/2011 and (EU) No 1035/2011 and amending Regulation (EU) No 677/2011 (OJ L 226, 19.8.2016, p. 1).

GM5 SPA.EFB.100(b)(3) Use of electronic flight bags (EFBs) – Operational approval

ED Decision 2019/008/R

USE OF COMMERCIAL OFF-THE-SHELF (COTS) POSITION SOURCE – PRACTICAL EVALUATION

The tests should consist of a statistically relevant sample of taxiing. It is recommended to include taxiing at airports that are representative of the more complex airports typically accessed by the operator. Taxiing segment samples should include data that is derived from runways and taxiways, and should include numerous turns, in particular of 90 degrees or more, and segments in straight lines at the maximum speed at which the own-ship symbol is displayed. Taxiing segment samples should include parts in areas of high buildings such as terminals. The analysis should include at least 25 inbound and/or outbound taxiing segments between the parking location and the runway.

During the tests, any unusual events (such as observing the own-ship symbol in a location on the map that is notably offset compared to the actual position, the own-ship symbol changing to non-directional when the aircraft is moving, and times when the own-ship symbol disappears from the map display) should be noted. For the test, the pilot should be instructed to diligently taxi on the centre line.

GM6 SPA.EFB.100(b)(3) Use of electronic flight bags (EFBs) – Operational approval

ED Decision 2019/008/R

APPLICATIONS DISPLAYING OWN-SHIP POSITION IN FLIGHT

The depiction of a circle around the EFB own-ship symbol may be used to differentiate it from the avionics one.

SUBPART N: HELICOPTER POINT-IN-SPACE APPROACHES AND DEPARTURES WITH REDUCED VFR MINIMA (PINS-VFR)

SPA.PINS-VFR.100 Helicopter point-in-space (PinS) approaches and departures with reduced VFR minima

Regulation (EU) 2021/2237

- (a) The operator shall only use reduced VFR operating minima if the operator has been granted an approval by the competent authority.
- (b) Reduced VFR operating minima shall apply only to a helicopter flight that includes a segment flown under IFR, and only in one of the following cases:
 - (1) the segment of the flight flown under VFR takes place immediately after a helicopter PinS approach with the intention of landing at a nearby heliport or operating site;
 - (2) the segment of the flight flown under VFR takes place immediately after a helicopter PinS approach with the intention of conducting hoist operations at a nearby HEC or HHO site;
 - (3) the segment of the flight flown under VFR is a departure with the intention of transitioning to IFR at a nearby initial departure fix.
- (c) The operator shall define operating procedures that are applicable when flying with reduced VFR operating minima.
- (d) The operator shall ensure that the flight crew members are experienced and trained to operate with reduced VFR operating minima.

AMC1 SPA.PINS-VFR.100 Helicopter point-in-space (PinS) approaches and departures with reduced VFR minima

ED Decision 2022/012/R

GENERAL

- (a) The operating minima prescribed in the Annex (Rules of the air) to [Regulation \(EU\) No 923/2012](#) should apply under VFR, unless one of the following applies:
 - (1) The VFR segment of the flight follows a PinS approach and the distance from the missed approach point (MAPt) to the destination is less than 5 km.
 - (2) The VFR segment of the flight is a departure with the intention of transitioning to IFR at the IDF and the distance from the take-off to the initial departure fix (IDF) is less than 5 km.
 - (3) The VFR segment of the flight follows the planned cancellation of the IFR flight plan at or above the MAPt or decision point of an instrument approach, the destination is different from the aerodrome attached to the instrument approach, the distance from the planned point of cancellation of IFR to the destination is less than 5 km, and the operator charts the obstacle environment on the VFR segment of the flight.
- (b) By day, if either (a)(1) or (a)(2) applies, the operating minima in Tables 1 and 2 should apply and visual references to the ground should be maintained.

- (c) By night, if either (a)(1) or (a)(2) applies, the operating minima in Tables 3 and 4 should apply and visual references to the ground should be maintained.
- (d) If (a)(3) applies, Table 1 applies by day, Table 3 applies by night, and visual references to the ground should be maintained. The MDH in the table should be understood as the DH/MDH of the IAP, whichever is higher.

Table 1

VFR operating minima BY DAY when instructed to 'proceed VFR' following an instrument approach		
x is the distance between the MAPt and the heliport or operating site		
X	Visibility	Ceiling
x < 1 000 m	1 000 m	MDH or 300 ft*
1 000 m ≤ x ≤ 3 000 m	x or 1 500 m, whichever is lower	MDH or 400 ft*
3 000 m < x ≤ 5 000 m	1 500 m	MDH or 600 ft*

Note: In Class B/C/D airspace, a special VFR clearance is needed and may require higher minima in accordance with local airspace restrictions.

* Whichever is higher.

Table 2

VFR operating minima BY DAY when instructed to 'proceed VFR' prior to an IFR departure		
x is the distance between the heliport or operating site and the IDF		
X	Visibility	Ceiling
x < 1 000 m	1 000 m	MDH or 300 ft*
1 000 m ≤ x ≤ 3 000 m	x or 1 500 m, whichever is lower	MDH or 400 ft*
3 000 m < x ≤ 5 000 m	1 500 m	MDH or 600 ft*

Note: In Class B/C/D airspace, a special VFR clearance is needed and may require higher minima in accordance with local airspace restrictions.

* Whichever is higher.

Table 3

VFR operating minima by NIGHT when instructed to 'proceed VFR' following an instrument approach		
x is the distance between the MAPt and the heliport or operating site		
X	Visibility	Ceiling
x < 1 000 m	2 000 m	MDH or 600 ft*
1 000 m ≤ x ≤ 3 000 m	x + 1 000 m	MDH + 200 ft or 600 ft*
3 000 m < x ≤ 5 000 m	5 000 m	MDH + 200 ft or 600 ft*

* Whichever is higher.

Table 4

VFR operating minima BY NIGHT when instructed to 'proceed VFR' prior to an IFR departure		
<i>x is the distance between the heliport or operating site and the IDF</i>		
X	Visibility	Ceiling
$x < 1\,000\text{ m}$	2 000 m	MCA or 600 ft*
$1\,000\text{ m} \leq x \leq 3\,000\text{ m}$	$x + 1\,000\text{ m}$	MCA + 200 ft or 600 ft*
$3\,000\text{ m} < x \leq 5\,000\text{ m}$	5 000 m	MCA + 200 ft or 600 ft*

* Whichever is higher.

- (d) The operator should define SOPs that describe the VFR segment of the departure and approach, including the transition from IFR to VFR and the transition from VFR to IFR.
- (e) The operator should provide a thorough description of the following elements; the description may be provided by means of a chart and should be included in the operations manual or other document:
 - (1) the environment in the vicinity of the VFR segment of the flight;
 - (2) the visual cues that are useful for the purpose of VFR navigation and that should be available on departure or for the continuation of the flight at the MAPt;
 - (3) the relevant obstacles.
- (f) The operator should ensure that the elements in (e) are updated on a regular basis.
- (g) The operator should encourage occurrence reporting and have a safety analysis capability.
- (h) The pilot-in-command/commander should have at least 1 000 hours of flying experience on helicopters, and 100 hours of instrument time on helicopters.
- (i) The pilot-in-command/commander should undergo initial and yearly recurrent FSTD training or checking, covering the following items:
 - (1) 3D approach operation to minima;
 - (2) go-around on instruments;
 - (3) 2D approach operation to minima;
 - (4) at least one of the 3D or 2D approach operations should be a PinS approach followed by a transition to VFR and a VFR landing;
 - (5) in the case of multi-engined helicopters, a simulated failure of one engine should be included in either the 3D or 2D approach operation to minima;
 - (6) where appropriate to the helicopter type, approach with flight control system/flight director system malfunctions, flight instrument and navigation equipment failures;
 - (7) recovery from unusual attitudes by instrument;
 - (8) loss of VMC during the VFR segment of flight;
 - (9) VFR departure followed by a manoeuvre back to the take-off location;
 - (10) VFR departure to the IDF followed by an IFR departure.

- (j) The training and checking elements of an approved training programme may be credited towards compliance with point (i) and need not be duplicated.
- (k) The training under (i) should take place on a suitable FSTD, corresponding to the helicopter type on which the operations take place.

ANNEX VI (PART-NCC)

SUBPART A: GENERAL REQUIREMENTS

NCC.GEN.100 Competent authority

Regulation (EU) 2019/1384

The competent authority shall be the authority designated by the Member State in which the operator has its principal place of business, is established or is residing.

GM1 NCC.GEN.100 Competent authority

ED Decision 2019/019/R

DETERMINING THE PLACE WHERE AN OPERATOR IS RESIDING

For the purpose of Regulation (EU) No 965/2012, the concept of 'place where the operator is residing' is mainly addressed to a natural person.

The place where the operator resides is the place where the operator complies with his or her tax obligations.

Several criteria can be used to help determining a person's place of residence. These include, for example:

- (a) the duration of a person's presence on the territory of the countries concerned;
- (b) the person's family status and ties;
- (c) the person's housing situation and how permanent it is;
- (d) the place where the person pursues professional or non-profit activities;
- (e) the characteristics of the person's professional activity; and
- (f) the Member State where the person resides for taxation purposes.

NCC.GEN.101 Additional requirements for flight training organisations

Regulation (EU) 2019/1387

Approved training organisations that are required to comply with this Annex shall also comply with:

- (a) [ORO.GEN.310](#), as applicable; and
- (b) [ORO.MLR.105](#).

NCC.GEN.105 Crew responsibilities

Regulation (EU) 2018/1042

- (a) The crew member shall be responsible for the proper execution of his/her duties that are:
 - (1) related to the safety of the aircraft and its occupants; and
 - (2) specified in the instructions and procedures in the operations manual.

- (b) During critical phases of flight or whenever deemed necessary by the pilot-in-command in the interest of safety, the crew member shall be seated at his/her assigned station and shall not perform any activities other than those required for the safe operation of the aircraft.
- (c) During flight, the flight crew member shall keep his/her safety belt fastened while at his/her station.
- (d) During flight, at least one qualified flight crew member shall remain at the controls of the aircraft at all times.
- (e) The crew member shall not undertake duties on an aircraft:
 - (1) if he/she knows or suspects that he/she is suffering from fatigue as referred to in 7.f of Annex IV to Regulation (EC) No 216/2008 or feels otherwise unfit, to the extent that the flight may be endangered; or
 - (2) when under the influence of psychoactive substances or for other reasons as referred to in 7.g of Annex IV to Regulation (EC) No 216/2008.
- (f) The crew member who undertakes duties for more than one operator shall:
 - (1) maintain his/her individual records regarding flight and duty times and rest periods as referred to in Annex III (Part-ORO), Subpart FTL to Regulation (EU) No 965/2012; and
 - (2) provide each operator with the data needed to schedule activities in accordance with the applicable FTL requirements.
- (g) The crew member shall report to the pilot-in-command:
 - (1) any fault, failure, malfunction or defect, which he/she believes may affect the airworthiness or safe operation of the aircraft, including emergency systems; and
 - (2) any incident that was endangering, or could endanger, the safety of the operation.

GM1 NCC.GEN.105(e)(2) Crew responsibilities

ED Decision 2013/021/R

GENERAL

In accordance with 7.g. of Annex IV to Regulation (EC) No 216/2008¹ (essential requirements for air operations), a crew member must not perform duties on board an aircraft when under the influence of psychoactive substances or alcohol or when unfit due to injury, fatigue, medication, sickness or other similar causes. This should be understood as including the following:

- (a) effects of deep water diving and blood donation, and allowing for a certain time period between these activities and returning to flying; and
- (b) without prejudice to more restrictive national regulations, the consumption of alcohol while on duty or less than 8 hours prior to the commencement of duties, and commencing a flight duty period with a blood alcohol level in excess of 0.2 per thousand.

¹ Regulation (EC) No 216/2008 of the European Parliament and of the Council of 20 February 2008 on common rules in the field of civil aviation and establishing a European Aviation Safety Agency, and repealing Council Directive 91/670/EEC, Regulation (EC) No 1592/2002 and Directive 2004/36/EC (OJ L 79, 19.3.2008, p. 1). Regulation as last amended by Regulation (EC) No 1108/2009 of the European Parliament and of the Council of 21 October 2009 (OJ L 309, 24.11.2009, p. 51).

AMC1 NCC.GEN.105(g) Crew responsibilities

ED Decision 2013/021/R

OCCURRENCE REPORTING

Whenever a crew member makes use of the applicable reporting systems, a copy of the report should be communicated to the pilot-in-command.

NCC.GEN.106 Pilot-in-command responsibilities and authority

Regulation (EU) 2016/1199

- (a) The pilot-in-command shall be responsible for:
- (1) the safety of the aircraft and of all crew members, passengers and cargo on board during aircraft operations as referred to in 1.c of Annex IV to Regulation (EC) No 216/2008;
 - (2) the initiation, continuation, termination or diversion of a flight in the interest of safety;
 - (3) ensuring that all instructions, operational procedures and checklists are complied with in accordance with the operations manual and as referred to in 1.b of Annex IV to Regulation (EC) No 216/2008;
 - (4) only commencing a flight if he/she is satisfied that all operational limitations referred to in 2.a.3 of Annex IV to Regulation (EC) No 216/2008 are complied with, as follows:
 - (i) the aircraft is airworthy;
 - (ii) the aircraft is duly registered;
 - (iii) instruments and equipment required for the execution of that flight are installed in the aircraft and are operative, unless operation with inoperative equipment is permitted by the minimum equipment list (MEL) or equivalent document, as required in [NCC.IDE.A.105](#) or [NCC.IDE.H.105](#);
 - (iv) the mass of the aircraft and centre of gravity location are such that the flight can be conducted within the limits prescribed in the airworthiness documentation;
 - (v) all cabin baggage, hold luggage and cargo are properly loaded and secured;
 - (vi) the aircraft operating limitations as specified in the aircraft flight manual (AFM) will not be exceeded at any time during the flight;
 - (vii) each flight crew member holds a valid licence in accordance with Regulation (EU) No 1178/2011;
 - (viii) flight crew members are properly rated and meet competency and recency requirements; and
 - (ix) any navigational database required for performance-based navigation is suitable and current;
 - (5) not commencing a flight if any flight crew member is incapacitated from performing duties by any cause such as injury, sickness, fatigue or the effects of any psychoactive substance;
 - (6) not continuing a flight beyond the nearest weather-permissible aerodrome or operating site, when the capacity of any flight crew member to perform duties is significantly reduced from causes such as fatigue, sickness or lack of oxygen;

- (7) deciding on acceptance of the aircraft with unserviceabilities in accordance with the configuration deviation list (CDL) or minimum equipment list (MEL), as applicable;
- (8) recording utilisation data and all known or suspected defects in the aircraft at the termination of the flight, or series of flights, in the aircraft technical log or journey log for the aircraft; and
- (9) ensuring that:
 - (i) flight recorders are not disabled or switched off during flight;
 - (ii) in the event of an occurrence other than an accident or a serious incident that shall be reported according to [ORO.GEN.160\(a\)](#), flight recorders' recordings are not intentionally erased; and
 - (iii) in the event of an accident or a serious incident, or if preservation of recordings of flight recorders is directed by the investigating authority:
 - (A) flight recorders' recordings are not intentionally erased;
 - (B) flight recorders are deactivated immediately after the flight is completed; and
 - (C) precautionary measures to preserve the recordings of flight recorders are taken before leaving the flight crew compartment.
- (b) The pilot-in-command shall have the authority to refuse carriage of or disembark any person, baggage or cargo that may represent a potential hazard to the safety of the aircraft or its occupants.
- (c) The pilot-in-command shall, as soon as possible, report to the appropriate air traffic services (ATS) unit any hazardous weather or flight conditions encountered that are likely to affect the safety of other aircraft.
- (d) Notwithstanding the provision of (a)(6), in a multi-crew operation the pilot-in-command may continue a flight beyond the nearest weather-permissible aerodrome when adequate mitigating procedures are in place.
- (e) The pilot-in-command shall, in an emergency situation that requires immediate decision and action, take any action he/she considers necessary under the circumstances in accordance with 7.d of Annex IV to Regulation (EC) No 216/2008. In such cases he/she may deviate from rules, operational procedures and methods in the interest of safety.
- (f) The pilot-in-command shall submit a report of an act of unlawful interference without delay to the competent authority and shall inform the designated local authority.
- (g) The pilot-in-command shall notify the nearest appropriate authority by the quickest available means of any accident involving the aircraft that results in serious injury or death of any person or substantial damage to the aircraft or property.

AMC1 NCC.GEN.106 Pilot-in-command responsibilities and authority

ED Decision 2016/017/R

FLIGHT PREPARATION FOR PBN OPERATIONS

- (a) The flight crew should ensure that RNAV 1, RNAV 2, RNP 1 RNP 2, and RNP APCH routes or procedures to be used for the intended flight, including for any alternate aerodromes, are selectable from the navigation database and are not prohibited by NOTAM.

- (b) The flight crew should take account of any NOTAMs or operator briefing material that could adversely affect the aircraft system operation along its flight plan including any alternate aerodromes.
- (c) When PBN relies on GNSS systems for which RAIM is required for integrity, its availability should be verified during the preflight planning. In the event of a predicted continuous loss of fault detection of more than five minutes, the flight planning should be revised to reflect the lack of full PBN capability for that period.
- (d) For RNP 4 operations with only GNSS sensors, a fault detection and exclusion (FDE) check should be performed. The maximum allowable time for which FDE capability is projected to be unavailable on any one event is 25 minutes. If predictions indicate that the maximum allowable FDE outage will be exceeded, the operation should be rescheduled to a time when FDE is available.
- (e) For RNAV 10 operations, the flight crew should take account of the RNAV 10 time limit declared for the inertial system, if applicable, considering also the effect of weather conditions that could affect flight duration in RNAV 10 airspace. Where an extension to the time limit is permitted, the flight crew will need to ensure that en route radio facilities are serviceable before departure, and to apply radio updates in accordance with any AFM limitation.

AMC2 NCC.GEN.106 Pilot-in-command responsibilities and authority

ED Decision 2013/021/R

DATABASE SUITABILITY

- (a) The flight crew should check that any navigational database required for PBN operations includes the routes and procedures required for the flight.

DATABASE CURRENCY

- (b) The database validity (current AIRAC cycle) should be checked before the flight.
- (c) Navigation databases should be current for the duration of the flight. If the AIRAC cycle is due to change during flight, the flight crew should follow procedures established by the operator to ensure the accuracy of navigation data, including the suitability of navigation facilities used to define the routes and procedures for the flight.
- (d) An expired database may only be used if the following conditions are satisfied:
 - (1) the operator has confirmed that the parts of the database which are intended to be used during the flight and any contingencies that are reasonable to expect are not changed in the current version;
 - (2) any NOTAMs associated with the navigational data are taken into account;
 - (3) maps and charts corresponding to those parts of the flight are current and have not been amended since the last cycle;
 - (4) any MEL limitations are observed; and
 - (5) the database has expired by no more than 28 days.

GM1 NCC.GEN.106 Pilot-in-command responsibilities and authority

ED Decision 2013/021/R

GENERAL

In accordance with 1.c. of Annex IV to Regulation (EC) No 216/2008 (Essential Requirements for air operations), the pilot-in-command is responsible for the operation and safety of the aircraft and for the safety of all crew members, passengers and cargo on board. This would normally be from the time that he/she assumes responsibility for the aircraft and passengers prior to a flight until the passengers are deplaned and escorted out of the operational area of the aerodrome or operating site and he/she relinquishes responsibility for the aircraft at the end of a flight or series of flights. The pilot-in-command's responsibilities and authority should be understood as including at least the following:

- (a) the safety of all crew members, passengers and cargo on board, as soon as he/she arrives on board, until he/she leaves the aircraft at the end of the flight; and
- (b) the operation and safety of the aircraft:
 - (1) for aeroplanes, from the moment it is first ready to move for the purpose of taxiing prior to take-off, until the moment it comes to rest at the end of the flight and the engine(s) used as primary propulsion unit(s) is/are shut down; or
 - (2) for helicopters, from the moment the engine(s) are started until the helicopter comes to rest at the end of the flight with the engine(s) shut down and the rotor blades stopped.

GM1 NCC.GEN.106(a)(9) Pilot-in-command responsibilities and authority

ED Decision 2015/030/R

IDENTIFICATION OF THE SEVERITY OF AN OCCURRENCE BY THE PILOT-IN-COMMAND

The definitions of an accident and a serious incident as well as examples thereof can be found in Regulation (EU) No 996/2010 of the European Parliament and of the Council.

GM1 NCC.GEN.106(b) Pilot-in-command responsibilities and authority

ED Decision 2013/021/R

AUTHORITY TO REFUSE CARRIAGE OR DISEMBARK

This may include:

- (a) passengers who have special needs that cannot be provided on the aircraft; or
- (b) persons that appear to be under the influence of alcohol or drugs.

AMC1 NCC.GEN.106(c) Pilot-in-command responsibilities and authority

ED Decision 2013/021/R

REPORTING OF HAZARDOUS FLIGHT CONDITIONS

- (a) These reports should include any detail which may be pertinent to the safety of other aircraft.
- (b) Such reports should be made whenever any of the following conditions are encountered or observed:

- (1) severe turbulence;
 - (2) severe icing;
 - (3) severe mountain wave;
 - (4) thunderstorms, with or without hail, that are obscured, embedded, widespread or in squall lines;
 - (5) heavy dust storm or heavy sandstorm;
 - (6) volcanic ash cloud; and
 - (7) unusual and/or increasing volcanic activity or a volcanic eruption.
- (c) When other meteorological conditions not listed above, e.g. wind shear, are encountered that, in the opinion of the pilot-in-command, may affect the safety or the efficiency of other aircraft operations, the pilot-in-command should advise the appropriate air traffic services (ATS) unit as soon as practicable.

AMC1 NCC.GEN.106(d) Pilot-in-command responsibilities and authority

ED Decision 2015/003/R

MITIGATING MEASURES — FATIGUE

The use of additional crew members and/or controlled rest during flight as described in [GM1 NCC.GEN.106\(d\)](#) may be considered as appropriate fatigue mitigating measures.

GM1 NCC.GEN.106(d) Pilot-in-command responsibilities and authority

ED Decision 2013/021/R

MITIGATING MEASURES — FATIGUE — CONTROLLED REST IN THE FLIGHT CREW COMPARTMENT

- (a) This Guidance Material (GM) addresses controlled rest taken by the minimum certified flight crew. It is not related to planned in-flight rest by members of an augmented crew.
- (b) Although flight crew members should stay alert at all times during flight, unexpected fatigue can occur as a result of sleep disturbance and circadian disruption. To cater for this unexpected fatigue, and to regain a high level of alertness, a controlled rest procedure in the flight crew compartment, organised by the pilot-in-command, may be used, if workload permits. 'Controlled rest' means a period of time 'off task' that may include actual sleep. The use of controlled rest has been shown to significantly increase the levels of alertness during the later phases of flight, particularly after the top of descent, and is considered to be good use of crew resource management (CRM) principles. Controlled rest should be used in conjunction with other on board fatigue management countermeasures such as physical exercise, bright flight crew compartment illumination at appropriate times, balanced eating and drinking and intellectual activity.
- (c) Controlled rest taken in this way should not be considered to be part of a rest period for the purposes of calculating flight time limitations, nor used to justify any duty period extension. Controlled rest may be used to manage both sudden unexpected fatigue and fatigue that is expected to become more severe during higher workload periods later in the flight. Controlled rest is not related to fatigue management, which is planned before flight.

- (d) Controlled rest periods should be agreed according to individual needs and the accepted principles of CRM; where the involvement of the cabin crew is required, consideration should be given to their workload.
- (e) When applying controlled rest procedures, the pilot-in-command should ensure that:
- (1) the other flight crew member(s) is(are) adequately briefed to carry out the duties of the resting flight crew member;
 - (2) one flight crew member is fully able to exercise control of the aircraft at all times; and
 - (3) any system intervention that would normally require a cross-check according to multi-crew principles is avoided until the resting flight crew member resumes his/her duties.
- (f) Controlled rest procedures should satisfy the following criteria:
- (1) only one flight crew member at a time should take rest at his/her station; the harness should be used and the seat positioned to minimise unintentional interference with the controls;
 - (2) the rest period should be no longer than 45 minutes (in order to limit any actual sleep to approximately 30 minutes) so as to limit deep sleep and associated long recovery time (sleep inertia);
 - (3) after this 45-minute period, there should be a recovery period of 20 minutes during which sole control of the aircraft should not be entrusted to the flight crew member taking controlled rest;
 - (4) in the case of two-crew operations, means should be established to ensure that the non-resting flight crew member remains alert. This may include:
 - (i) appropriate alarm systems;
 - (ii) on board systems to monitor flight crew activity; and
 - (iii) where cabin crew are on board the aircraft, frequent cabin crew checks. In this case, the pilot-in-command should inform the cabin crew member of the intention of the flight crew member to take controlled rest, and of the time of the end of that rest; frequent contact should be established between the non-resting flight crew member and the cabin crew by communication means, and the cabin crew should check that the resting flight crew member is alert at the end of the period;
 - (5) there should be a minimum of 20 minutes between two sequential controlled rest periods in order to overcome the effects of sleep inertia and allow for adequate briefing;
 - (6) if necessary, a flight crew member may take more than one rest period, if time permits, on longer sectors, subject to the restrictions above; and
 - (7) controlled rest periods should terminate at least 30 minutes before the top of descent.

AMC1 NCC.GEN.106(e) Pilot-in-command responsibilities and authority

ED Decision 2013/021/R

VIOLATION REPORTING

If required by the State in which the incident occurs, the pilot-in-command should submit a report on any such violation to the appropriate authority of such State; in that event, the pilot-in-command

should also submit a copy of it to the competent authority. Such reports should be submitted as soon as possible and normally within 10 days.

NCC.GEN.110 Compliance with laws, regulations and procedures

Regulation (EU) No 800/2013

- (a) The pilot-in-command shall comply with the laws, regulations and procedures of those States where operations are conducted.
- (b) The pilot-in-command shall be familiar with the laws, regulations and procedures, pertinent to the performance of his/her duties, prescribed for the areas to be traversed, the aerodromes or operating sites to be used and the related air navigation facilities as referred to in 1.a of Annex IV to Regulation (EC) No 216/2008.

NCC.GEN.115 Common language

Regulation (EU) No 800/2013

The operator shall ensure that all crew members can communicate with each other in a common language.

NCC.GEN.119 Taxiing of aircraft

Regulation (EU) 2015/140

The operator shall establish procedures for taxiing to ensure safe operation and to enhance runway safety.

AMC1 NCC.GEN.119 Taxiing of aircraft

ED Decision 2015/003/R

PROCEDURES FOR TAXIING

Procedures for taxiing should include at least the following:

- (a) application of the sterile flight crew compartment procedures;
- (b) use of standard radio-telephony (RTF) phraseology;
- (c) use of lights;
- (d) measures to enhance the situational awareness of the minimum required flight crew members. The following list of typical items should be adapted by the operator to take into account its operational environment:
 - (1) each flight crew member should have the necessary aerodrome layout charts available;
 - (2) the pilot taxiing the aircraft should announce in advance his/her intentions to the pilot monitoring;
 - (3) all taxi clearances should be heard, and should be understood by each flight crew member;
 - (4) all taxi clearances should be cross-checked against the aerodrome chart and aerodrome surface markings, signs, and lights;
 - (5) an aircraft taxiing on the manoeuvring area should stop and hold at all lighted stop bars, and may proceed further when an explicit clearance to enter or cross the runway has

- been issued by the aerodrome control tower, and when the stop bar lights are switched off;
- (6) if the pilot taxiing the aircraft is unsure of his/her position, he/she should stop the aircraft and contact air traffic control;
 - (7) the pilot monitoring should monitor the taxi progress and adherence to the clearances, and should assist the pilot taxiing;
 - (8) any action which may disturb the flight crew from the taxi activity should be avoided or done with the parking brake set (e.g. announcements by public address);
- (e) subparagraphs (d)(2) and (d)(7) are not applicable to single-pilot operations.

NCC.GEN.120 Taxiing of aeroplanes

Regulation (EU) No 800/2013

The operator shall ensure that an aeroplane is only taxied on the movement area of an aerodrome if the person at the controls:

- (a) is an appropriately qualified pilot; or
- (b) has been designated by the operator and:
 - (1) is trained to taxi the aeroplane;
 - (2) is trained to use the radio telephone, if radio communications are required;
 - (3) has received instruction in respect of aerodrome layout, routes, signs, marking, lights, air traffic control (ATC) signals and instructions, phraseology and procedures; and
 - (4) is able to conform to the operational standards required for safe aeroplane movement at the aerodrome.

GM1 NCC.GEN.120 Taxiing of aeroplanes

ED Decision 2015/003/R

SAFETY-CRITICAL ACTIVITY

- (a) Taxiing should be treated as a safety-critical activity due to the risks related to the movement of the aeroplane and the potential for a catastrophic event on the ground.
- (b) Taxiing is a high-workload phase of flight that requires the full attention of the flight crew.

GM1 NCC.GEN.120(b)(4) Taxiing of aeroplanes

ED Decision 2013/021/R

SKILLS AND KNOWLEDGE

The person designated by the operator to taxi an aeroplane should possess the following skills and knowledge:

- (a) Positioning of the aeroplane to ensure safety when starting engine;
- (b) Getting ATIS reports and taxi clearance, where applicable;
- (c) Interpretation of airfield markings/lights/signals/indicators;
- (d) Interpretation of marshalling signals, where applicable;
- (e) Identification of suitable parking area;

- (f) Maintaining lookout and right-of-way rules and complying with ATC or marshalling instructions when applicable;
- (g) Avoidance of adverse effect of propeller slipstream or jet wash on other aeroplanes, aerodrome facilities and personnel;
- (h) Inspection of taxi path when surface conditions are obscured;
- (i) Communication with others when controlling an aeroplane on the ground;
- (j) Interpretation of operational instructions;
- (k) Reporting of any problem that may occur while taxiing an aeroplane; and
- (l) Adapting the taxi speed in accordance with prevailing aerodrome, traffic, surface and weather conditions.

NCC.GEN.125 Rotor engagement – helicopters

Regulation (EU) No 800/2013

A helicopter rotor shall only be turned under power for the purpose of flight with a qualified pilot at the controls.

GM1 NCC.GEN.125 Rotor engagement

ED Decision 2013/021/R

INTENT OF THE RULE

- (a) The following two situations where it is allowed to turn the rotor under power should be distinguished:
 - (1) for the purpose of flight, as described in the Implementing Rule;
 - (2) for maintenance purposes.
- (b) Rotor engagement for the purpose of flight: it should be noted that the pilot should not leave the control when the rotors are turning. For example, the pilot is not allowed to get out of the aircraft in order to welcome passengers and adjust their seat belts with the rotors turning.
- (c) Rotor engagement for the purpose of maintenance: the Implementing Rule, however, should not prevent ground runs being conducted by qualified personnel other than pilots for maintenance purposes.

The following conditions should be applied:

- (1) The operator should ensure that the qualification of personnel, other than pilots, who are authorised to conduct maintenance runs, is described in the appropriate manual.
- (2) Ground runs should not include taxiing the helicopter.
- (3) There should be no passengers on board.
- (4) Maintenance runs should not include collective increase or autopilot engagement (risk of ground resonance).

NCC.GEN.130 Portable electronic devices

Regulation (EU) No 800/2013

The operator shall not permit any person to use a portable electronic device (PED) on board an aircraft that could adversely affect the performance of the aircraft's systems and equipment.

AMC1 NCC.GEN.130 Portable electronic devices

ED Decision 2019/008/R

TECHNICAL PREREQUISITES FOR THE USE OF PEDS

(a) Scope

This AMC describes the technical prerequisites under which any kind of portable electronic device (PED) may be used on board the aircraft without adversely affecting the performance of the aircraft's systems and equipment.

(b) Prerequisites concerning the aircraft configuration

- (1) Before an operator may permit the use of any kind of PED on-board, it should ensure that PEDs have no impact on the safe operation of the aircraft. The operator should demonstrate that PEDs do not interfere with on-board electronic systems and equipment, especially with the aircraft's navigation and communication systems.
- (2) The assessment of PED tolerance may be tailored to the different aircraft zones for which the use of PEDs is considered, i.e. may address separately:
 - (i) the passenger compartment;
 - (ii) the flight crew compartment; and
 - (iii) areas not accessible during the flight.

(c) Scenarios for permitting the use of PEDs

- (1) Possible scenarios, under which the operator may permit the use of PEDs, should be as documented in Table 1. The scenarios in Table 1 are listed in a descending order with the least permitting scenario at the bottom.
- (2) Restrictions arising from the corresponding aircraft certification, as documented in the aircraft flight manual (AFM) or equivalent document(s), should stay in force. They may be linked to different aircraft zones, or to particular transmitting technologies covered.
- (3) For Scenarios Nos. 3 to 8 in Table 1 the use of C-PEDs and cargo tracking devices may be further expanded, when the EMI assessment has demonstrated that there is no impact on safety as follows:
 - (i) for C-PEDs by using the method described in (d)(2); and
 - (ii) for cargo tracking devices by using the method described in (d)(3).

Table 1 – Scenarios for permitting the use of PEDs by the operator

No.	Technical condition	Non-intentional transmitters	T-PEDs
1	The aircraft is certified as T-PED tolerant, i.e. it has been demonstrated during the aircraft certification process that front door and back door coupling have no impact on the safe operation of the aircraft	All phases of flight	All phases of flight

No.	Technical condition	Non-intentional transmitters	T-PEDs
2	A complete electromagnetic interference (EMI) assessment for all technologies, using the method described in (d)(1), has been performed and has demonstrated the T-PED tolerance	All phases of flight	All phases of flight
3	The aircraft is certified for the use of T-PEDs using particular technologies (e.g. WLAN or mobile phone)	All phases of flight	All phases of flight, restricted to those particular technologies
4	The EMI assessment, using the method described in (d)(1), has demonstrated that: (a) the front door coupling has no impact on safety; and (b) the back door coupling has no impact on safety when using particular technologies (e.g. WLAN or mobile phone)	All phases of flight	All phases of flight, restricted to those particular technologies
5	The EMI assessment, using the method described in (d)(1)(i), has demonstrated that the front door coupling has no impact on safety caused by non-intentional transmitters	All phases of flight	Not permitted
6	The EMI assessment, using the method described in (d)(1)(ii), has demonstrated that the back door coupling has no impact on safety when using particular technologies (e.g. WLAN or mobile phone)	All phases of flight - except low visibility approach operation	All phases of flight - except low visibility approach operation, restricted to those particular technologies
7	An EMI assessment has not been performed	All phases of flight - except low visibility approach operation	Not permitted
8	Notwithstanding Scenarios Nos. 3 to 7	(a) before taxi-out; (b) during taxi-in after the end of landing roll; and (c) the pilot-in-command may permit the use during prolonged departure delays, provided that sufficient time is available to check the passenger compartment before the flight proceeds	

(d) Demonstration of electromagnetic compatibility

(1) EMI assessment at aircraft level

The means to demonstrate that the radio frequency (RF) emissions (intentional or non-intentional) are tolerated by aircraft systems should be as follows:

(i) To address front door coupling susceptibility for any kind of PEDs:

- (A) EUROCAE, 'Guidance for the use of Portable Electronic Devices (PEDs) on Board Aircraft', ED-130A / RTCA DO-363 'Guidance for the Development of Portable Electronic Devices (PED) Tolerance for Civil Aircraft', Section 5; or
- (B) EUROCAE, 'Aircraft Design and Certification for Portable Electronic Device (PED) Tolerance', ED-239 / RTCA DO-307A, Section 4.

The use of RTCA, 'Guidance on Allowing Transmitting Portable, Electronic Devices (T-PEDs) on Aircraft', DO-294C (or later revisions), Appendix 5C; or

RTCA, 'Aircraft Design and Certification for Portable Electronic Device (PED) Tolerance', DO-307 (including Change 1 or later revisions), Section 4, may be acceptable.

- (ii) To address back door coupling susceptibility for T-PEDs:
 - (A) EUROCAE, 'Guidance for the use of portable electronic devices (PEDs) on board aircraft', ED-130A/RTCA DO-363, Section 6; or
 - (B) EUROCAE, 'Aircraft Design and Certification for Portable Electronic Device (PED) Tolerance', ED-239 / RTCA DO-307A, Section 3.

The use of EUROCAE, 'Guidance for the use of Portable Electronic Devices (PEDs) on Board Aircraft', ED-130, Annex 6; or RTCA DO-294C (or later revisions), Appendix 6D; or RTCA DO-307 (including Change 1 or later revisions), Section 3, may be acceptable.

(2) Alternative EMI assessment of C-PEDs

- (i) For front door coupling:
 - (A) C-PEDs should comply with the levels as defined by:
 - (a) EUROCAE/RTCA, 'Environmental conditions and test procedures for airborne equipment', ED-14D/DO-160D (or later revisions), Section 21, Category M, for operation in the passenger compartment and the flight crew compartment; and
 - (b) EUROCAE ED-14D/RTCA DO-160D (or later revisions), Section 21, Category H, for operation in areas not accessible during the flight.
 - (B) If the C-PEDs are electronic flight bags used in the flight crew compartment and if the DO-160 testing described in (A) identifies inadequate margins for interference or has not been performed, it is necessary to test the C-PED in each aircraft model in which it will be operated. The C-PED should be tested in operation on the aircraft to show that no interference occurs with the aircraft equipment. This testing should be performed in a real aircraft, and credit may be given to other similarly equipped aircraft (meaning in particular that they have the same avionics equipment) of the same make and model as the one tested.
- (ii) To address back-door coupling susceptibility for C-PEDs with transmitting capabilities, the EMI assessment described in (1)(ii) should be performed.

(3) Alternative EMI assessment of cargo tracking devices

In case a transmitting function is automatically deactivated in a cargo tracking device (being a T-PED), the unit should be qualified for safe operation on board the aircraft. One of the following methods should be considered acceptable as evidence for safe operation:

- (i) A type-specific safety assessment, including failure mode and effects analysis, has been performed at aircraft level. The main purpose of the assessment should be to determine the worst hazards and to demonstrate an adequate design assurance level of the relevant hardware and software components of the cargo tracking device.
- (ii) The high intensity radiated field (HIRF) certification of the aircraft has been performed, i.e. the aircraft type has been certified after 1987 and meets the

appropriate special condition. In such a case, the operator should observe the following:

- (A) The tracking device:
 - (a) features an automated and prolonged radio suspension in flight using multiple modes of redundancy; and
 - (b) has been verified in the aircraft environment to ensure deactivation of the transmitting function in flight.
- (B) The transmissions of the tracking device are limited per design to short periods of time (less than 1 second per 1 000 seconds) and cannot be continuous.
- (C) The tracking devices should comply with the levels as defined by EUROCAE ED-14E/RTCA DO-160E (or later revisions), Section 21, Category H.
- (D) In order to provide assurance on the tracking device design and production, the following documents are retained as part of the evaluation package:
 - (a) operational description, technical specifications, product label and images of the tracking device and any peripheral attachments;
 - (b) failure mode and effects analysis report of the tracking device and any peripheral attachments;
 - (c) declaration of stringent design and production controls in place during the tracking device manufacturing;
 - (d) declaration of conformity and technical documentation showing compliance to the European Norms (EN), regulating the transmitter characteristic of the tracking device or its transmission module; and
 - (e) an EMI assessment report documenting the emission levels.
- (iii) The tracking device interference levels during transmission are below those considered acceptable for the specific aircraft environment.

(e) Operational conditions of C-PEDS and cargo tracking devices

The operator should ensure that C-PEDs and cargo tracking devices are maintained in good and safe condition, having in mind that:

- (1) damage may modify their emissions characteristics; and
- (2) damage to the battery may create a fire hazard.

(f) Batteries in C-PEDs and cargo tracking devices

Lithium-type batteries in C-PEDs and cargo tracking devices should meet:

- (1) United Nations (UN) Transportation Regulations, 'Recommendations on the transport of dangerous goods - manual of tests and criteria', UN ST/SG/AC.10/11; and
- (2) one of the following standards:
 - (i) Underwriters Laboratory, 'Lithium batteries', UL 1642;
 - (ii) Underwriters Laboratory, 'Household and commercial batteries', UL 2054;
 - (iii) Underwriters Laboratory, 'Information technology equipment – safety', UL 60950-1;

- (iv) International Electrotechnical Commission (IEC), 'Secondary cells and batteries containing alkaline or other non-acid electrolytes - safety requirements for portable sealed secondary cells, and for batteries made from them, for use in portable applications', IEC 62133;
- (v) RTCA, 'Minimum operational performance standards for rechargeable lithium battery systems', DO-311. RTCA DO-311 may be used to address concerns regarding overcharging, over-discharging, and the flammability of cell components. The standard is intended to test permanently installed equipment; however, these tests are applicable and sufficient to test electronic flight bags rechargeable lithium-type batteries; or
- (vi) European Technical Standard Order (ETSO), 'Non-rechargeable lithium cells and batteries', ETSO C142a.

AMC2 NCC.GEN.130 Portable electronic devices

ED Decision 2014/030/R

PROCEDURES FOR THE USE OF PEDS

(a) Scope

This AMC describes the procedures under which any kind of portable electronic device (PED) may be used on board the aircraft without adversely affecting the performance of the aircraft's systems and equipment. This AMC addresses the operation of PEDs in the different aircraft zones — passenger compartment, flight compartment, and areas inaccessible during the flight.

(b) Prerequisites

Before permitting the use of any kind of PEDs the operator should ensure compliance with (c) of [AMC1 NCC.GEN.130](#).

(c) Hazard identification and risk assessment

The operator should identify the safety hazards and manage the associated risks following the management system implemented in accordance with [ORO.GEN.200](#). The risk assessment should include hazards associated with:

- (1) PEDs in different aircraft zones;
- (2) PED use during various phases of flight;
- (3) PED use during turbulence;
- (4) improperly stowed PEDs;
- (5) impeded or slowed evacuations;
- (6) passenger non-compliance, e.g. not deactivating transmitting functions, not switching off PEDs or not stowing PEDs properly;
- (7) disruptive passengers; and
- (8) battery fire.

(d) Use of PEDs in the passenger compartment

(1) Procedures and training

If an operator permits passengers to use PEDs on board its aircraft, procedures should be in place to control their use. These procedures should include provisions for passenger

briefing, passenger handling and for the stowage of PEDs. The operator should ensure that all crew members and ground personnel are trained to enforce possible restrictions concerning the use of PEDs, in line with these procedures.

(2) Provisions for use

- (i) The use of PEDs in the passenger compartment may be granted under the responsibility of the operator, i.e. the operator decides which PED may be used during which phases of the flight.
- (ii) Notwithstanding (b), medical equipment necessary to support physiological functions may be used at all times and does not need to be switched-off.

(3) Stowage, passenger information and passenger briefing of PEDs

- (i) In accordance with [NCC.OP.135](#) the operator should establish procedures concerning the stowage of PEDs. The operator should:
 - (A) identify the phases of flight in which PEDs are to be stowed; and
 - (B) determine suitable stowage locations, taking into account the PEDs' size and weight.
- (ii) The operator should provide general information on the use of PEDs to the passengers before the flight. This information should specify at least:
 - (A) which PEDs can be used during which phases of the flight;
 - (B) when and where PEDs are to be stowed; and
 - (C) that the instructions of the crew are to be followed at all times.
- (iii) The use of PEDs should be part of the passenger briefings. The operator should remind passengers to pay attention and to avoid distraction during such briefings.

(4) In-seat electrical power supplies

Where in-seat electrical power supplies are available for passenger use, the following should apply:

- (i) information giving safety instructions should be provided to the passengers;
- (ii) PEDs should be disconnected from any in-seat electrical power supply during taxiing, take-off, approach, landing, and during abnormal or emergency conditions; and
- (iii) flight crew and cabin crew should be aware of the proper means to switch-off in-seat power supplies used for PEDs.

(5) Operator's safety measures during boarding and any phase of flight

- (i) Appropriate coordination between flight crew and cabin crew should be established to deal with interference or other safety problems associated with PEDs.
- (ii) Suspect equipment should be switched off.
- (iii) Particular attention should be given to passenger misuse of equipment.
- (iv) Thermal runaways of batteries, in particular lithium batteries, and potential resulting fire, should be handled properly.

- (v) The pilot-in-command may, for any reason and during any phase of flight, require deactivation and stowage of PEDs.
 - (vi) When the operator restricts the use of PEDs, consideration should be given to handle special requests to operate a T-PED during any phase of the flight for specific reasons (e.g. for security measures).
- (6) Reporting
- Occurrences of suspected or confirmed interference should be reported to the competent authority. Where possible, to assist follow-up and technical investigation, reports should describe the suspected device, identify the brand name and model number, its location in the aircraft at the time of the occurrence, interference symptoms, the device user's contact details and the results of actions taken by the crew.
- (e) Use of PEDs in the flight crew compartment
- In the flight crew compartment the operator may permit the use of PEDs, e.g. to assist the flight crew in their duties, when procedures are in place to ensure the following:
- (1) The conditions for the use of PEDs in-flight are specified in the operations manual.
 - (2) The PEDs do not pose a loose item risk or other hazard.
 - (3) These provisions should not preclude use of a T-PED (specifically a mobile phone) by the flight crew to deal with an emergency. However, reliance should not be predicated on a T-PED for this purpose.
- (f) PEDs not accessible during the flight
- PEDs should be switched off, when not accessible for deactivation during flight. This should apply especially to PEDs contained in baggage or transported as part of the cargo. The operator may permit deviation for PEDs for which safe operation has been demonstrated in accordance with [AMC1 NCC.GEN.130](#). Other precautions, such as transporting in shielded metal boxes, may also be used to mitigate associated risks.

GM1 NCC.GEN.130 Portable electronic devices

ED Decision 2014/030/R

DEFINITIONS

- (a) Definition and categories of PEDs
- PEDs are any kind of electronic device, typically but not limited to consumer electronics, brought on board the aircraft by crew members, passengers, or as part of the cargo and that are not included in the approved aircraft configuration. All equipment that is able to consume electrical energy falls under this definition. The electrical energy can be provided from internal sources as batteries (chargeable or non-rechargeable) or the devices may also be connected to specific aircraft power sources.
- PEDs include the following two categories:
- (1) Non-intentional transmitters can non-intentionally radiate RF transmissions, sometimes referred to as spurious emissions. This category includes, but is not limited to, calculators, cameras, radio receivers, audio and video players, electronic games and toys; when these devices are not equipped with a transmitting function.
 - (2) Intentional transmitters radiate RF transmissions on specific frequencies as part of their intended function. In addition, they may radiate non-intentional transmissions like any

PED. The term 'transmitting PED' (T-PED) is used to identify the transmitting capability of the PED. Intentional transmitters are transmitting devices such as RF-based remote control equipment, which may include some toys, two-way radios (sometimes referred to as private mobile radio), mobile phones of any type, satellite phones, computers with mobile phone data connection, wireless local area network (WLAN) or Bluetooth capability. After deactivation of the transmitting capability, e.g. by activating the so-called 'flight mode' or 'flight safety mode', the T-PED remains a PED having non-intentional emissions.

(b) Controlled PEDs (C-PEDs)

A controlled PED (C-PED) is a PED subject to administrative control by the operator using it. This will include, inter alia, tracking the allocation of the devices to specific aircraft or persons and ensuring that no unauthorised changes are made to the hardware, software or databases. C-PEDs can be assigned to the category of non-intentional transmitters or T-PEDs.

(c) Cargo tracking device

A cargo tracking device is a PED attached to or included in airfreight (e.g. in or on containers, pallets, parcels or baggage). Cargo tracking devices can be assigned to the category of non-intentional transmitters or T-PEDs. If the device is a T-PED, it complies with the European Norms (EN) for transmissions.

(d) Definition of the switched-off status

Many PEDs are not completely disconnected from the internal power source when switched off. The switching function may leave some remaining functionality, e.g. data storage, timer, clock, etc. These devices can be considered switched off when in the deactivated status. The same applies for devices having no transmitting capability and are operated by coin cells without further deactivation capability, e.g. wrist watches.

(e) Electromagnetic interference (EMI)

The two classes of EMI to be addressed can be described as follows:

- (1) Front door coupling is the possible disturbance to an aircraft system as received by the antenna of the system and mainly in the frequency band used by the system. Any PED internal oscillation has the potential to radiate low level signals in the aviation frequency bands. Through this disturbance especially the instrument landing system (ILS) and the VHF omni range (VOR) navigation system may indicate erroneous information.
- (2) Back door coupling is the possible disturbance of aircraft systems by electromagnetic fields generated by transmitters at a level which could exceed on short distance (i.e. within the aircraft) the electromagnetic field level used for the aircraft system certification. This disturbance may then lead to system malfunction.

GM2 NCC.GEN.130 Portable electronic devices

ED Decision 2015/003/R

CREW REST COMPARTMENT, NAVIGATION, TEST ENTITIES AND FIRE CAUSED BY PEDS

- (a) When the aircraft is equipped with a crew rest compartment, it is considered being part of the passenger compartment.
- (b) Front door coupling may influence the VOR navigation system. Therefore, the flight crew monitors other navigation sensors to detect potential disturbances by PEDs, especially during low visibility departure operation based on VOR guidance.

- (c) Specific equipment, knowledge and experience are required, when the industry standards for evaluating technical prerequisites for the use of PEDs are applied. In order to ensure conformity with the industry standards, the operator is encouraged to cooperate with an appropriately qualified and experienced entity, as necessary. For this entity an aviation background is not required, but is considered to be beneficial.
- (d) Guidance to follow in case of fire caused by PEDs is provided by the International Civil Aviation Organisation, 'Emergency response guidance for aircraft incidents involving dangerous goods', ICAO Doc 9481-AN/928.

GM3 NCC.GEN.130 Portable electronic devices

ED Decision 2014/030/R

CARGO TRACKING DEVICES EVALUATION

- (a) Safety assessment

Further guidance on performing a safety assessment can be found in:

- (1) EASA, 'Certification specifications and acceptable means of compliance for large aeroplanes', CS-25, Book 2, AMC-Subpart F, AMC 25.1309;
- (2) EUROCAE/SAE, 'Guidelines for development of civil aircraft and systems', ED-79/ARP 4754 (or later revisions); and
- (3) SAE, 'Guidelines and methods for conducting the safety assessment process on civil airborne systems and equipment', ARP 4761 (or later revisions).

- (b) HIRF certification

The type certificate data sheet (TCDS), available on the EASA website for each aircraft model having EASA certification, lists whether the HIRF certification has been performed through a special condition. The operator may contact the type certification holder to gain the necessary information.

- (c) Failure mode and effects analysis

Further guidance on performing a failure mode and effects analysis can be found in:

- (1) SAE ARP 4761 (or later revisions); and
- (2) U.S. Department of Defense, 'Procedures for performing a failure mode, effects and criticality analysis', Military Standard MIL-STD-1629A (or later revisions).

NCC.GEN.131 Use of electronic flight bags (EFBs)

Regulation (EU) 2018/1975

- (a) Where an EFB is used on board an aircraft, the operator shall ensure that it does not adversely affect the performance of the aircraft systems or equipment, or the ability of the flight crew member to operate the aircraft.
- (b) Prior to using a type B EFB application, the operator shall:
 - (1) conduct a risk assessment related to the use of the EFB device that hosts the application and to the EFB application concerned and its associated function(s), identifying the associated risks and ensuring that they are appropriately managed and mitigated; the risk assessment shall address the risks associated with the human-machine interface of the EFB device and the EFB application concerned; and

- (2) establish an EFB administration system, including procedures and training requirements for the administration and use of the device and the EFB application

AMC1 NCC.GEN.131(a) Use of electronic flight bags (EFBs)

ED Decision 2019/008/R

HARDWARE

In addition to [AMC1 CAT.GEN.MPA.141\(a\)](#), the following should be considered:

(a) Display characteristics

Consideration should be given to the long-term degradation of a display, as a result of abrasion and ageing. AMC 25-11 (paragraph 3.16a) may be used as guidance to assess luminance and legibility aspects.

Information displayed on the EFB should be legible to the typical user at the intended viewing distance(s) and under the full range of lighting conditions expected in a flight crew compartment, including direct sunlight.

Users should be able to adjust the brightness of an EFB screen independently of the brightness of other displays in the flight crew compartment. In addition, when incorporating an automatic brightness adjustment, it should operate independently for each EFB in the flight crew compartment. Brightness adjustment using software means may be acceptable provided that this operation does not adversely affect the flight crew workload.

Buttons and labels should have adequate illumination for night use. 'Buttons and labels' refers to hardware controls located on the display itself.

All controls should be properly labelled for their intended function, except if no confusion is possible.

The 90-degree viewing angle on either side of each flight crew member's line of sight may be unacceptable for certain EFB applications if aspects of the display quality are degraded at large viewing angles (e.g. the display colours wash out or the displayed colour contrast is not discernible at the installation viewing angle).

(b) Power source

The design of a portable EFB system should consider the source of electrical power, the independence of the power sources for multiple EFBs, and the potential need for an independent battery source. A non-exhaustive list of factors to be considered includes:

- (1) the possibility to adopt operational procedures to ensure an adequate level of safety (for example, ensure a minimum level of charge before departure);
- (2) the possible redundancy of portable EFBs to reduce the risk of exhausted batteries;
- (3) the availability of backup battery packs to ensure an alternative source of power.

Battery-powered EFBs that have aircraft power available for recharging the internal EFB batteries are considered to have a suitable backup power source.

For EFBs that have an internal battery power source, and that are used as an alternative for paper documentation that is required by [NCC.GEN.140](#), the operator should either have at least one EFB connected to an aircraft power bus or have established mitigation means and procedures to ensure that sufficient power with acceptable margins will be available during the whole flight.

(c) Environmental testing

Environmental testing, in particular testing for rapid decompression, should be performed when the EFB hosts applications that are required to be used during flight following a rapid decompression and/or when the EFB environmental operational range is potentially insufficient with respect to the foreseeable flight crew compartment operating conditions.

The information from the rapid-decompression test of an EFB is used to establish the procedural requirements for the use of that EFB device in a pressurised aircraft. Rapid-decompression testing should follow the EUROCAE ED-14D/RTCA DO-160D (or later revisions) guidelines for rapid-decompression testing up to the maximum operating altitude of the aircraft at which the EFB is to be used.

- (1) Pressurised aircraft: when a portable EFB has successfully completed rapid-decompression testing, then no mitigating procedures for depressurisation events need to be developed. When a portable EFB has failed the rapid-decompression testing while turned ON, but successfully completed it when turned OFF, then procedures should ensure that at least one EFB on board the aircraft remains OFF during the applicable flight phases or that it is configured so that no damage will be incurred should rapid decompression occur in flight at an altitude higher than 10 000 ft above mean sea level (AMSL).

If an EFB system has not been tested or it has failed the rapid-decompression test, then alternate procedures or paper backup should be available.

- (2) Non-pressurised aircraft: rapid-decompression testing is not required for an EFB used in a non pressurised aircraft. The EFB should be demonstrated to reliably operate up to the maximum operating altitude of the aircraft. If the EFB cannot be operated at the maximum operating altitude of the aircraft, procedures should be established to preclude operation of the EFB above the maximum demonstrated EFB operating altitude while still maintaining the availability of any required aeronautical information displayed on the EFB.

The results of testing performed on a specific EFB model configuration (as identified by the EFB hardware manufacturer) may be applied to other aircraft installations and these generic environmental tests may not need to be duplicated. The operator should collect and retain:

- (1) evidence of these tests that have already been accomplished; or
- (2) suitable alternative procedures to deal with the total loss of the EFB system.

Rapid decompression tests do not need to be repeated when the EFB model identification and the battery type do not change.

The testing of operational EFBs should be avoided if possible to preclude the infliction of unknown damage to the unit during testing.

Operators should account for the possible loss or erroneous functioning of the EFB in abnormal environmental conditions.

The safe stowage and the use of the EFB under any foreseeable environmental conditions in the flight crew compartment, including turbulence, should be evaluated.

AMC1 NCC.GEN.131(b) Use of electronic flight bags (EFBs)

ED Decision 2019/008/R

SOFTWARE

The same considerations as those in [AMC1 CAT.GEN.MPA.141\(b\)](#), [AMC2 CAT.GEN.MPA.141\(b\)](#) and [AMC3 CAT.GEN.MPA.141\(b\)](#) should apply in respect of EFB software.

AMC1 NCC.GEN.131(b)(1) Use of electronic flight bags (EFBs)

ED Decision 2019/008/R

RISK ASSESSMENT**(a) General**

Prior to the use of any EFB system, the operator should perform a risk assessment for all type B EFB applications and for the related hardware as part of its hazard identification and risk management process.

The operator may make use of a risk assessment established by the software developer. However, the operator should ensure that its specific operational environment is taken into account.

The risk assessment should:

- (1) evaluate the risks associated with the use of an EFB;
- (2) identify potential losses of function or malfunction (with detected and undetected erroneous outputs) and the associated failure scenarios;
- (3) analyse the operational consequences of these failure scenarios;
- (4) establish mitigating measures; and
- (5) ensure that the EFB system (hardware and software) achieves at least the same level of accessibility, usability, and reliability as the means of presentation it replaces.

In considering the accessibility, usability, and reliability of the EFB system, the operator should ensure that the failure of the complete EFB system as well as of individual applications, including corruption or loss of data, and erroneously displayed information, has been assessed and that the risks have been mitigated to an acceptable level.

The operator should ensure that the risk assessments for type B EFB applications are maintained and kept up to date.

When the EFB system is intended to be introduced alongside a paper-based system, only the failures that would not be mitigated by the use of the paper-based system need to be addressed. In all other cases, a complete risk assessment should be performed.

(b) Assessing and mitigating the risks

Some parameters of EFB applications may depend on entries that are made by flight crew/dispatchers, whereas others may be default parameters from within the system that are subject to an administration process (e.g. the runway line-up allowance in an aircraft performance application). In the first case, mitigation means would mainly concern training and flight crew procedure aspects, whereas in the second case, mitigation means would more likely focus on the EFB administration and data management aspects.

The analysis should be specific to the operator concerned and should address at least the following points:

- (1) The minimisation of undetected erroneous outputs from applications and assessment of the worst credible scenario;
- (2) Erroneous outputs from the software application including:
 - (i) a description of the corruption scenarios that were analysed; and
 - (ii) a description of the mitigation means;
- (3) Upstream processes including:
 - (i) the reliability of root data used in applications (e.g. qualified input data, such as databases produced under ED-76/DO-200A, 'Standards for Processing Aeronautical Data');
 - (ii) the software application validation and verification checks according to appropriate industry standards, if applicable; and
 - (iii) the independence between application software components, e.g. robust partitioning between EFB applications and other airworthiness certified software applications;
- (4) A description of the mitigation means to be used following the detected failure of an application, or of a detected erroneous output;
- (5) The need for access to an alternate power supply in order to ensure the availability of software applications, especially if they are used as a source of required information.

As part of the mitigation means, the operator should consider establishing a reliable alternative means to provide the information available on the EFB system.

The mitigation means could be, for example, one of, or a combination of, the following:

- (1) the system design (including hardware and software);
- (2) a backup EFB device, possibly supplied from a different power source;
- (3) EFB applications being hosted on more than one platform;
- (4) a paper backup (e.g. quick reference handbook (QRH)); and
- (5) procedural means.

Depending on the outcome of their risk assessment, the operator may also consider performing an operational evaluation test before allowing unrestricted use of its EFB devices and applications.

EFB system design features such as those assuring data integrity and the accuracy of performance calculations (e.g. 'reasonableness' or 'range' checks) may be integrated in the risk assessment performed by the operator.

(c) Changes

The operator should update its EFB risk assessment based on the planned changes to its EFB system.

However, modifications to the operator's EFB system which:

- (1) do not bring any change to the calculation algorithms and/or to the interface of a type B EFB application;
- (2) introduce a new type A EFB application or modify an existing one (provided its software classification remains type A);

- (3) do not introduce any additional functionality to an existing type B EFB application;
- (4) update an existing database necessary to use an existing type B EFB application; or
- (5) do not require a change to the flight crew training or operational procedures, may be introduced by the operator without having to update its risk assessment.

These changes should, nevertheless, be controlled and properly tested prior to use in flight.

The modifications in the following non-exhaustive list are considered to meet these criteria:

- (1) operating system updates;
- (2) chart or airport database updates;
- (3) updates to introduce fixes (patches); and
- (4) installation and modification of a type A EFB application.

AMC1 NCC.GEN.131(b)(2) Use of electronic flight bags (EFBs)

ED Decision 2019/008/R

EFB ADMINISTRATION

The operator should ensure:

- (a) that adequate support is provided to the EFB users for all the applications installed;
- (b) that potential security issues associated with the application installed have been checked;
- (c) that the hardware and software configuration is appropriately managed and that no unauthorised software is installed.

The operator should ensure that miscellaneous software applications do not adversely impact on the operation of the EFB, and should include miscellaneous software applications in the scope of the EFB configuration management;

- (d) that only a valid version of the application software and current data packages are installed on the EFB system; and
- (e) the integrity of the data packages used by the applications installed.

AMC2 NCC.GEN.131(b)(2) Use of electronic flight bags (EFBs)

ED Decision 2019/008/R

PROCEDURES

The procedures for the administration or the use of the EFB device and the type B EFB application may be fully or partly integrated in the operations manual.

- (a) General

If an EFB system generates information similar to that generated by existing certified systems, procedures should clearly identify which information source will be the primary, which source will be used for backup information, and under which conditions the backup source should be used. Procedures should define the actions to be taken by the flight crew members when information provided by an EFB system is not consistent with that from other flight crew compartment sources, or when one EFB system shows different information than the other.

In the case of EFB applications providing information which might be affected by Notice(s) to Airmen NOTAMS (e.g. Airport moving map display (AMMD), performance calculation,...), the

procedure for the use of these applications should include the handling of the relevant NOTAMS before their use.

(b) Flight crew awareness of EFB software/database revisions

The operator should have a process in place to verify that the configuration of the EFB, including software application versions and, where applicable, database versions, are up to date. Flight crew members should have the ability to easily verify the validity of database versions used on the EFB. Nevertheless, flight crew members should not be required to confirm the revision dates for other databases that do not adversely affect flight operations, such as maintenance log forms or a list of airport codes. An example of a date-sensitive revision is that applied to an aeronautical chart database. Procedures should specify what actions should be taken if the software applications or databases loaded on the EFB system are outdated.

(c) Workload mitigation and/or control

The operator should ensure that additional workload created by using an EFB system is adequately mitigated and/or controlled. The operator should ensure that, while the aircraft is in flight or moving on the ground, flight crew members do not become preoccupied with the EFB system at the same time. Workload should be shared between flight crew members to ensure ease of use and continued monitoring of other flight crew functions and aircraft equipment. This should be strictly applied in flight and the operator should specify any times when the flight crew members may not use the specific EFB application.

(d) Dispatch

The operator should establish dispatch criteria for the EFB system. The operator should ensure that the availability of the EFB system is confirmed by preflight checks. Instructions to flight crew should clearly define the actions to be taken in the event of any EFB system deficiency.

Mitigation may be in the form of maintenance and/or operational procedures for items such as:

- (1) replacement of batteries at defined intervals as required;
- (2) ensuring that there is a fully charged backup battery on board;
- (3) the flight crew checking the battery charging level before departure; and
- (4) the flight crew switching off the EFB in a timely manner when the aircraft power source is lost.

In the event of a partial or complete failure of the EFB, specific dispatch procedures should be followed. These procedures should be included either in the minimum equipment list (MEL) or in the operations manual and should ensure an acceptable level of safety.

Particular attention should be paid to establishing specific dispatch procedures allowing to obtain operational data (e.g. performance data) in the event of a failure of an EFB hosting application that provides such calculated data.

When the integrity of data input and output is verified by cross-checking and gross-error checks, the same checking principle should be applied to alternative dispatch procedures to ensure equivalent protection.

(e) Maintenance

Procedures should be established for the routine maintenance of the EFB system and detailing how unserviceability and failures are to be dealt with to ensure that the integrity of the EFB system is preserved. Maintenance procedures should also include the secure handling of

updated information and how this information is validated and then promulgated in a timely manner and in a complete format to all users.

As part of the EFB system's maintenance, the operator should ensure that the EFB system batteries are periodically checked and replaced as required.

Should a fault or failure of the system arise, it is essential that such failures are brought to the immediate attention of the flight crew and that the system is isolated until rectification action is taken. In addition to backup procedures, to deal with system failures, a reporting system should be in place so that the necessary action, either to a particular EFB system or to the whole system, is taken in order to prevent the use of erroneous information by flight crew members.

(f) Security

The EFB system (including any means used for updating it) should be secure from unauthorised intervention (e.g. by malicious software). The operator should ensure that the system is adequately protected at the software level and that the hardware is appropriately managed (e.g. the identification of the person to whom the hardware is released, protected storage when the hardware is not in use) throughout the operational lifetime of the EFB system. The operator should ensure that prior to each flight the EFB operational software works as specified and the EFB operational data is complete and accurate. Moreover, a system should be in place to ensure that the EFB does not accept a data load that contains corrupted contents. Adequate measures should be in place for the compilation and secure distribution of data to the aircraft.

Procedures should be transparent, and easy to understand, to follow and to oversee:

- (1) If an EFB is based on consumer electronics (e.g. a laptop) which can be easily removed, manipulated, or replaced by a similar component, then special consideration should be given to the physical security of the hardware;
- (2) Portable EFB platforms should be subject to allocation tracking to specific aircraft or persons;
- (3) Where a system has input ports, and especially if widely known protocols are used through these ports or internet connections are offered, then special consideration should be given to the risks associated with these ports;
- (4) Where physical media are used to update the EFB system, and especially if widely known types of physical media are used, then the operator should use technologies and/or procedures to assure that unauthorised content cannot enter the EFB system through these media.

The required level of EFB security depends on the criticality of the functions used (e.g. an EFB which only holds a list of fuel prices may require less security than an EFB used for performance calculations).

Beyond the level of security required to assure that the EFB can properly perform its intended functions, the level of security ultimately required depends on the capabilities of the EFB.

(g) Electronic signatures

Some applicable requirements may require a signature when issuing or accepting a document (e.g. load sheet, technical logbook, notification to captain (NOTOC)). In order to be accepted as being equivalent to a handwritten signature, electronic signatures used in EFB applications need, as a minimum, to fulfil the same objectives and should assure the same degree of security as the handwritten or any other form of signature that they are intended to replace. [AMC1](#)

[NCC.POL.110\(c\)](#) provides means to comply with the required handwritten signature or its equivalent for mass and balance documentation.

On a general basis, in the case of required signatures, an operator should have in place procedures for electronic signatures that guarantee:

- (1) their uniqueness: a signature should identify a specific individual and be difficult to duplicate;
- (2) their significance: an individual using an electronic signature should take deliberate and recognisable action to affix their signature;
- (3) their scope: the scope of the information being affirmed with an electronic signature should be clear to the signatory and to the subsequent readers of the record, record entry, or document;
- (4) their security: the security of an individual's handwritten signature is maintained by ensuring that it is difficult for another individual to duplicate or alter it;
- (5) their non-repudiation: an electronic signature should prevent a signatory from denying that they affixed a signature to a specific record, record entry, or document; the more difficult it is to duplicate a signature, the more likely it is that the signature was created by the signatory; and
- (6) their traceability: an electronic signature should provide positive traceability to the individual who signed a record, record entry, or any other document.

An electronic signature should retain those qualities of a handwritten signature that guarantee its uniqueness. Systems using either a PIN or a password with limited validity (timewise) may be appropriate in providing positive traceability to the individual who affixed it. Advanced electronic signatures, qualified certificates and secured signature-creation devices needed to create them in the context of Regulation (EU) No 910/2014 are typically not required for EFB operations.

AMC3 NCC.GEN.131(b)(2) Use of electronic flight bags (EFBs)

ED Decision 2019/008/R

FLIGHT CREW TRAINING

Flight crew members should be given specific training on the use of the EFB system before it is operationally used.

Training should at least include the following:

- (a) an overview of the system architecture;
- (b) preflight checks of the system;
- (c) limitations of the system;
- (d) specific training on the use of each application and the conditions under which the EFB may and may not be used;
- (e) restrictions on the use of the system, including cases where the entire system or some parts of it are not available;
- (f) procedures for normal operations, including cross-checking of data entry and computed information;

- (g) procedures to handle abnormal situations, such as a late runway change or a diversion to an alternate aerodrome;
- (h) procedures to handle emergency situations;
- (i) phases of the flight when the EFB system may and may not be used;
- (j) human factors considerations, including crew resource management (CRM), on the use of the EFB;
- (k) additional training for new applications or changes to the hardware configuration;
- (l) actions following the failure of component(s) of the EFB, including cases of battery smoke or fire; and
- (m) management of conflicting information.

AMC4 NCC.GEN.131(b)(2) Use of electronic flight bags (EFBs)

ED Decision 2019/008/R

PERFORMANCE AND MASS AND BALANCE APPLICATIONS

(a) General

Performance and mass and balance applications should be based on existing published data found in the AFM or performance manual, and should account for the applicable CAT.POL performance requirements. The applications may use algorithms or data spreadsheets to determine results. They may have the capability to interpolate within the information contained in the published data for the particular aircraft but should not extrapolate beyond it.

To protect against intentional and unintentional modifications, the integrity of the database files related to performance and mass and balance (the performance database, airport database, etc.) should be checked by the program before performing any calculations. This check can be run once at the start-up of the application.

Each software version should be identified by a unique version number. The performance and mass and balance applications should record each computation performed (inputs and outputs) and the operator should ensure that this information is retained for at least 3 months.

The operator should ensure that aircraft performance or mass and balance data provided by the application is correct compared with the data derived from the AFM (e.g. for take-off and landing performance data) or from other reference data sources (e.g. mass and balance manuals or databases, in-flight performance manuals or databases) under a representative cross-check of conditions (e.g. for take-off and landing performance applications: take-off and landing performance data on dry, wet and contaminated runways, with different wind conditions and aerodrome pressure altitudes, etc.).

The operator should define any new roles that the flight crew and, if applicable, the flight dispatcher, may have in creating, reviewing, and using performance calculations supported by EFB systems.

(b) Testing

The verification of the compliance of a performance or mass and balance application should include software testing activities performed with the software version candidate for operational use.

The testing can be performed either by the operator or a third party, as long as the testing process is documented and the responsibilities identified.

The testing activities should include reliability testing and accuracy testing.

Reliability testing should show that the application in its operating environment (operating system (OS) and hardware included) is stable and deterministic, i.e. identical answers are generated each time the process is entered with identical parameters.

Accuracy testing should demonstrate that the aircraft performance or mass and balance computations provided by the application are correct in comparison with data derived from the AFM or other reference data sources, under a representative cross section of conditions (e.g. for take-off and landing performance applications: runway state and slope, different wind conditions and pressure altitudes, various aircraft configurations including failures with a performance impact, etc.).

The verification should include a sufficient number of comparison results from representative calculations throughout the entire operating envelope of the aircraft, considering corner points, routine and break points.

Any difference compared to the reference data that is judged significant should be examined. When differences are due to more conservative calculations or reduced margins that were purposely built into the approved data, this approach should be clearly specified. Compliance with the applicable certification and operational rules needs to be assessed in any case.

The testing method should be described. The testing may be automated when all the required data is available in an appropriate electronic format, but in addition to performing thorough monitoring of the correct functioning and design of the testing tools and procedures, operators are strongly suggested to perform additional manual verification. It could be based on a few scenarios for each chart or table of the reference data, including both operationally representative scenarios and 'corner-case' scenarios.

The testing of a software revision should, in addition, include non-regression testing and testing of any fix or change.

Furthermore, an operator should perform testing related to its customisation of the applications and to any element pertinent to its operation that was not covered at an earlier stage (e.g. airport database verification).

(c) Procedures

Specific care is needed regarding flight crew procedures concerning take-off and landing performance or mass and balance applications. Flight crew procedures should ensure that:

- (1) calculations are performed independently by each flight crew member before data outputs are accepted for use;
- (2) a formal cross-check is made before data outputs are accepted for use; such cross-checks should utilise the independent calculations described above, together with the output of the same data from other sources on the aircraft;
- (3) a gross-error check is performed before data outputs are accepted for use; such gross-error checks may use either a 'rule of thumb' or the output of the same data from other sources on the aircraft; and
- (4) in the event of a loss of functionality of an EFB through either the loss of a single application, or the failure of the device hosting the application, an equivalent level of safety can be maintained; consistency with the EFB risk assessment assumptions should be confirmed.

(d) Training

The training should emphasise the importance of executing all take-off and landing performance or mass and balance calculations in accordance with the SOPs to assure fully independent calculations.

Furthermore, due to the optimisation at different levels brought by performance applications, the flight crew members may be confronted with new procedures and different aircraft behaviour (e.g. the use of multiple flap settings for take-off). The training should be designed and provided accordingly.

Where an application allows the computing of both dispatch results (from regulatory and factored calculations) and other results, the training should highlight the specificities of those results. Depending on the representativeness of the calculation, the flight crew should be trained on any operational margin that might be required.

The training should also address the identification and the review of default values, if any, and assumptions about the aircraft status or environmental conditions made by the application.

(e) Specific considerations for mass and balance applications

In addition to the figures, a diagram displaying the mass and its associated centre of gravity (CG) should be provided.

(f) Human-factors-specific considerations

Input and output data (i.e. results) shall be clearly separated from each other. All the information necessary for a given calculation task should be presented together or be easily accessible.

All input and output data should include correct and unambiguous terms (names), units of measurement (e.g. kg or lb), and when applicable, an index system and a CG-position declaration (e.g. Arm/%MAC). The units should match the ones from the other flight-crew-compartment sources for the same kinds of data.

Airspeeds should be provided in a way that is directly useable in the flight crew compartment unless the unit clearly indicates otherwise (e.g. Knots Calibrated Air Speed (KCAS)). Any difference between the type of airspeed provided by the EFB application and the type provided by the AFM or flight crew operating manual (FCOM) performance charts should be mentioned in the flight crew guides and training material.

If the landing performance application allows the computation of both dispatch (regulatory, factored) and other results (e.g. in-flight or unfactored), the flight crew members should be made aware of the computation mode used.

(1) Inputs

The application should allow users to clearly distinguish user entries from default values or entries imported from other aircraft systems.

Performance applications should allow the flight crew to check whether a certain obstacle is included in the performance calculations and/or to include new or revised obstacle information in the performance calculations.

(2) Outputs

All critical assumptions for performance calculations (e.g. the use of thrust reversers, full or reduced thrust/power rating) should be clearly displayed. The assumptions made

about any calculation should be at least as clear to the flight crew members as similar information would be on a tabular chart.

All output data should be available in numbers.

The application should indicate when a set of entries results in an unachievable operation (for instance, a negative stopping margin) with a specific message or colour scheme. This should be done in accordance with the relevant provisions on messages and the use of colours.

In order to allow a smooth workflow and to prevent data entry errors, the layout of the calculation outputs should be such that it is consistent with the data entry interface of the aircraft applications in which the calculation outputs are used (e.g. flight management systems).

(3) Modifications

The user should be able to easily modify performance calculations, especially when making last-minute changes.

Calculation results and any outdated input fields should be deleted when:

- (i) modifications are entered;
- (ii) the EFB is shut down or the performance application is closed; and
- (iii) the EFB or the performance application have been in a standby or 'background' mode too long, i.e. such that it is likely that when it is used again, the inputs or outputs will be outdated.

AMC5 NCC.GEN.131(b)(2) Use of electronic flight bags (EFBs)

ED Decision 2019/008/R

AIRPORT MOVING MAP DISPLAY (AMMD) APPLICATION WITH OWN-SHIP POSITION

(a) General

An AMMD application should not be used as the primary means of navigation for taxiing and should be only used in conjunction with other materials and procedures identified within the operating concept (see paragraph (e)).

When an AMMD is in use, the primary means of navigation for taxiing remains the use of normal procedures and direct visual observation out of the flight-crew-compartment window.

Thus, as recognised in ETSO-C165a, an AMMD application with a display of own-ship position is considered to have a minor safety effect for malfunctions that cause the incorrect depiction of aircraft position (own-ship), and the failure condition for the loss of function is classified as 'no safety effect'.

(b) Minimum requirements

AMMD software that complies with European Technical Standard Order ETSO-C165a is considered to be acceptable.

In addition, the system should provide the means to display the revision number of the software installed.

To achieve the total system accuracy requirements of ETSO-C165a, an airworthiness-approved sensor using the global positioning system (GPS) in combination with a medium-accuracy

database compliant with EUROCAE ED-99C/RTCA DO-272C, 'User Requirements for Aerodrome Mapping Information,' (or later revisions) is considered one acceptable means.

Alternatively, the use of non-certified commercial off-the-shelf (COTS) position sources may be acceptable in accordance with [AMC6 NCC.GEN.131\(b\)\(2\)](#).

(c) Data provided by the AMMD software application developer

The operator should ensure that the AMMD software application developer provides the appropriate data including:

(1) installation instructions or equivalent as per ETSO-C165a Section 2.2 addressing:

- (i) the identification of each specific EFB system computing platform (including the hardware platform and the operating system version) with which this AMMD software application and database was demonstrated to be compatible;
- (ii) the installation procedures and limitations for each applicable platform (e.g. required memory resources, configuration of Global Navigation Satellite System (GNSS) antenna position);
- (iii) the interface description data including the requirements for external sensors providing data inputs; and
- (iv) means to verify that the AMMD has been installed correctly and is functioning properly.

(2) Any AMMD limitations, and known installation, operational, functional, or performance issues of the AMMD.

(d) AMMD software installation in the EFB

The operator should review the documents and the data provided by the AMMD developer, and ensure that the installation requirements of the AMMD software in the specific EFB platform and aircraft are addressed. Operators are required to:

perform any verification activities proposed by the AMMD software application developer, as well as identify and perform any additional integration activities that need to be completed;

(e) Operational procedures

Changes to operational procedures of the aircraft (e.g. flight crew procedures) should be documented in the operations manual or user's guide as appropriate. In particular, the documentation should highlight that the AMMD is only designed to assist flight crew members in orienting themselves on the airport surface so as to improve the flight crew members' positional awareness during taxiing and that it is not to be used as the basis for ground manoeuvring.

(f) Training requirements

The operator may use flight crew procedures to mitigate some hazards. These should include limitations on the use of the AMMD function or application. As the AMMD could be a compelling display and the procedural restrictions are a key component of the mitigation, training should be provided in support of an AMMD implementation.

All mitigation means that rely on flight crew procedures should be included in the flight crew training. Details of the AMMD training should be included in the operator's overall EFB training.

AMC6 NCC.GEN.131(b)(2) Use of electronic flight bags (EFBs)

ED Decision 2019/008/R

USE OF COMMERCIAL OFF-THE-SHELF (COTS) POSITION SOURCE

COTS position sources may be used for AMMD EFB applications and for EFB applications displaying the own-ship position in-flight when the following considerations are complied with:

(a) Characterisation of the receiver:

The position should originate from an airworthiness approved GNSS receiver, or from a COTS GNSS receiver fully characterised in terms of technical specifications and featuring an adequate number of channels (12 or more).

The EFB application should, in addition to position and velocity data, receive a sufficient number of parameters related to the fix quality and integrity to allow compliance with the accuracy requirements (e.g. the number of satellites and constellation geometry parameters such as dilution of position (DOP), 2D/3D fix).

(b) Installation aspects:

COTS position sources are C-PEDs and their installation and use should follow the requirements of [NCC.GEN.130](#).

If the external COTS position source transmits wirelessly, cybersecurity aspects have to be considered.

(c) Practical evaluation:

As variables can be introduced by the placement of the antennas in the aircraft and the characteristics of the aircraft itself (e.g. heated and/or shielded windshield effects), the tests have to take place on the type of aircraft in which the EFB will be operated, with the antenna positioned at the location to be used in service.

(1) COTS used as a position source for AMMD

The test installation should record the data provided by the COTS position source to the AMMD application.

The analysis should use the recorded parameters to demonstrate that the AMMD requirements are satisfactorily complied with in terms of the total system accuracy (taking into account database errors, latency effects, display errors, and uncompensated antenna offsets) within 50 metres (95 %). The availability should be sufficient to prevent distraction or increased workload due to frequent loss of position.

When demonstrating compliance with the following requirements of DO-257A, the behaviour of the AMMD system should be evaluated in practice:

- (i) indication of degraded position accuracy within 1 second (Section 2.2.4 (22)); and
- (ii) indication of a loss of positioning data within 5 seconds (Section 2.2.4 (23)); conditions to consider are both a loss of the GNSS satellite view (e.g. antenna failure) and a loss of communication between the receiver and the EFB.

(2) COTS position source used for applications displaying own-ship position in-flight:

Flight trials should demonstrate that the COTS GNSS availability is sufficient to prevent distraction or increased workload due to frequent loss of position.

AMC7 NCC.GEN.131(b)(2) Use of electronic flight bags (EFBs)

ED Decision 2019/008/R

CHART APPLICATIONS

The navigation charts that are depicted should contain the information necessary, in an appropriate form, to perform the operation safely. Consideration should be given to the size, resolution and position of the display to ensure legibility whilst retaining the ability to review all the information required to maintain adequate situational awareness. The identification of risks associated with the human-machine interface, as part of the operator's risk assessment, is key to identifying acceptable mitigation means, e.g.:

- (a) to establish procedures for reducing the risk of making errors;
- (b) to control and mitigate the additional workload related to EFB use;
- (c) to ensure the consistency of colour-coding and symbology philosophies between EFB applications and their compatibility with other flight crew compartment applications; and
- (d) to consider aspects of crew resource management (CRM) when using an EFB system.

In the case of chart application displaying own-ship position in flight, [AMC9 NCC.GEN.131\(b\)\(2\)](#) is applicable.

AMC8 NCC.GEN.131(b)(2) Use of electronic flight bags (EFBs)

ED Decision 2019/008/R

IN-FLIGHT WEATHER APPLICATIONS

- (a) General

An in-flight weather (IFW) application is an EFB function or application enabling the flight crew to access meteorological information. It is designed to increase situational awareness and to support the flight crew when making strategic decisions.

An IFW function or application may be used to access both information required to be on board (e.g. World Area Forecast Centre (WAFC) data) and supplemental weather information.

The use of IFW applications should be non-safety-critical and not necessary for the performance of the flight. In order for it to be non-safety-critical, IFW data should not be used to support tactical decisions and/or as a substitute for certified aircraft systems (e.g. weather radar).

Any current information from the meteorological data required to be carried on board or from aircraft primary systems should always prevail over the information from an IFW application.

The displayed meteorological information may be forecasted and/or observed, and may be updated on the ground and/or in flight. It should be based on data from certified meteorological services providers or other reliable sources evaluated by the operator.

The meteorological information provided to the flight crew should be as far as possible consistent with the information available to users of ground-based aviation meteorological information (e.g. operations control centre (OCC) staff, flight dispatchers, etc.) in order to establish common situational awareness and to facilitate collaborative decision-making.

- (b) Display

Meteorological information should be presented to the flight crew in a format that is appropriate to the content of the information; coloured graphical depiction is encouraged whenever practicable.

The IFW display should enable the flight crew to:

- (1) distinguish between observed and forecasted weather data;
- (2) identify the currency or age and validity time of the weather data;
- (3) access the interpretation of the weather data (e.g. the legend);
- (4) obtain positive and clear indications of any missing information or data and determine areas of uncertainty when making decisions to avoid hazardous weather; and
- (5) be aware of the data-link means status enabling necessary IFW data exchanges.

Meteorological information in IFW applications may be displayed, for example, as an overlay over navigation charts, over geographical maps, or it may be a stand-alone weather depiction (e.g. radar plots, satellite images, etc.).

If meteorological information is overlaid on navigation charts, special consideration should be given to HMI issues in order to avoid adverse effects on the basic chart functions.

In case of display of own-ship position in flight, [AMC9 NCC.GEN.131\(b\)\(2\)](#) is applicable.

The meteorological information may require reformatting to accommodate, for example, the display size or the depiction technology. However, any reformatting of the meteorological information should preserve both the geo-location and intensity of the meteorological conditions regardless of projection, scaling, or any other types of processing.

(c) Training and procedures

The operator should establish procedures for the use of an IFW application.

The operator should provide adequate training to the flight crew members before using an IFW application. This training should address:

- (1) limitations of the use of an IFW application:
 - (i) acceptable use (strategic planning only);
 - (ii) information required to be on board; and
 - (iii) latency of observed weather information and the hazards associated with utilisation of old information;
- (2) information on the display of weather data:
 - (i) type of displayed information (forecasted, observed);
 - (ii) symbology (symbols, colours); and
 - (iii) interpretation of meteorological information;
- (3) identification of failures and malfunctions (e.g. incomplete uplinks, data-link failures, missing info);
- (4) human factors issues:
 - (i) avoiding fixation; and
 - (ii) managing workload.

AMC9 NCC.GEN.131(b)(2) Use of electronic flight bags (EFBs)

ED Decision 2019/008/R

APPLICATIONS DISPLAYING OWN-SHIP POSITION IN-FLIGHT**(a) Limitations**

The display of own-ship position in flight as an overlay to other EFB applications should not be used as a primary source of information to fly or navigate the aircraft.

Except on VFR flights over routes navigated by reference to visual landmark, the display of the own-ship symbol is allowed only in aircraft having a certified navigation display (moving map).

In the specific case of IFW applications, the display of own-ship on such applications is restricted to aircraft equipped with a weather radar.

(b) Position source and accuracy

The display of own-ship position may be based on a certified GNSS or GNSS-based (e.g. GPS/IRS) position from certified aircraft equipment or on a portable COTS position source in accordance with [AMC6 NCC.GEN.131\(b\)\(2\)](#).

The own-ship symbol should be removed and the flight crew notified if:

- (1) the estimated accuracy exceeds 50 meters;
- (2) the position data is reported as invalid by the GNSS receiver; or
- (3) the position data is not received for 5 seconds.

(c) Charting data considerations

If the map involves raster images that have been stitched together into a larger single map, it should be demonstrated that the stitching process does not introduce distortion or map errors that would not correlate properly with a GNSS-based own-ship symbol.

(d) Human machine interface (HMI)**(1) Interface**

The flight crew should be able to unambiguously differentiate the EFB function from avionics functions available in the cockpit, and in particular with the navigation display.

A sufficiently legible text label "AIRCRAFT POSITION NOT TO BE USED FOR NAVIGATION" or equivalent should be continuously displayed by the application if the own-ship position depiction is visible in the current display area over a terminal chart (i.e. SID, STAR, or instrument approach) or a depiction of a terminal procedure.

(2) Display of own-ship symbol

The own-ship symbol should be different from the ones used by certified aircraft systems intended for primary navigation.

If directional data is available, the own-ship symbol may indicate directionality. If direction is not available, the own-ship symbol should not imply directionality.

The colour coding should not be inconsistent with the manufacturer philosophy.

(3) Data displayed

The current map orientation should be clearly, continuously and unambiguously indicated (e.g., Track-up vs North-up).

If the software supports more than one directional orientation for the own-ship symbol (e.g., Track-up vs North-up), the current own-ship symbol orientation should be indicated.

The chart display in track-up mode should not create usability or readability issues. In particular, chart data should not be rotated in a manner that affects readability.

The application zoom levels should be appropriate for the function and content being displayed and in the context of providing supplemental position awareness.

The pilot should be able to obtain information about the operational status of the own-ship function (e.g. active, deactivated, degraded).

During IFR, day-VFR without visual references or night VFR flight, the following parameters' values should not be displayed:

- (i) Track/heading;
- (ii) Estimated time of arrival (ETA);
- (iii) Altitude;
- (iv) Geographical coordinates of the current location of the aircraft; and
- (v) Aircraft speed.

(4) Controls

If a panning and/or range selection function is available, the EFB application should provide a clear and simple method to return to an own-ship oriented display.

A means to disable the display of the own-ship position should be provided to the flight crew.

(e) Training and procedures

The procedures and training should emphasise the fact that the display of own-ship position on charts or IFW EFB applications should not be used as a primary source of information to fly or navigate the aircraft or as a primary source of weather information.

(1) Procedures:

The following considerations should be addressed in the procedures for the use of charts or IFW EFB application displaying the own-ship position in-flight by the flight crew:

- (i) Intended use of the display of own-ship position in-flight on charts or IFW EFB applications;
- (ii) Inclusion of the EFB into the regular scan of flight deck systems indications. In particular, systematic cross-check with avionics before being used, whatever the position source; and
- (iii) Actions to be taken in case of the identification of a discrepancy between the EFB and avionics.

(2) Training:

Crew members should be trained on the procedures for the use of the application, including the regular cross-check with avionics and the action in case of discrepancy.

GM1 NCC.GEN.131(b)(2) Use of electronic flight bags (EFBs)

ED Decision 2019/008/R

IN-FLIGHT WEATHER APPLICATIONS

'Reliable sources' of data used by in-flight weather (IFW) applications are the organisations evaluated by the operator as being able to provide an appropriate level of data assurance in terms of accuracy and integrity. It is recommended that the following aspects be considered during that evaluation:

- (a) The organisation should have a quality assurance system in place that covers the data source selection, acquisition/import, processing, validity period check, and the distribution phase;
- (b) Any meteorological product provided by the organisation that is within the scope of meteorological information included in the flight documentation as defined in MET.TR.215(e) (Annex V (Definitions of terms used in Annexes II to XIII) to Commission Implementing Regulation (EU) 2016/1377) should originate only from authoritative sources or certified providers and should not be transformed or altered, except for the purpose of packaging the data in the correct format. The organisation's process should provide assurance that the integrity of those products is preserved in the data for use by the IFW application.

GM2 NCC.GEN.131(b)(2) Use of electronic flight bags (EFBs)

ED Decision 2019/008/R

USE OF COMMERCIAL OFF-THE-SHELF (COTS) POSITION SOURCE – PRACTICAL EVALUATION

The tests should consist of a statistically relevant sample of taxiing. It is recommended to include taxiing at airports that are representative of the more complex airports typically accessed by the operator. Taxiing segment samples should include data that is derived from runways and taxiways, and should include numerous turns, in particular of 90 degrees or more, and segments in straight lines at the maximum speed at which the own-ship symbol is displayed. Taxiing segment samples should include parts in areas of high buildings such as terminals. The analysis should include at least 25 inbound and/or outbound taxiing segments between the parking location and the runway.

During the tests, any unusual events (such as observing the own-ship symbol in a location on the map that is notably offset compared to the actual position, the own-ship symbol changing to non-directional when the aircraft is moving, and times when the own-ship symbol disappears from the map display) should be noted. For the test, the pilot should be instructed to diligently taxi on the centre line.

GM3 NCC.GEN.131(b)(2) Use of electronic flight bags (EFBs)

ED Decision 2019/008/R

APPLICATIONS DISPLAYING OWN-SHIP POSITION IN FLIGHT

The depiction of a circle around the EFB own-ship symbol may be used to differentiate it from the avionics one.

NCC.GEN.135 Information on emergency and survival equipment carried

Regulation (EU) No 800/2013

The operator shall at all times have available for immediate communication to rescue coordination centres (RCCs) lists containing information on the emergency and survival equipment carried on board.

AMC1 NCC.GEN.135 Information on emergency and survival equipment carried

ED Decision 2013/021/R

CONTENT OF INFORMATION

The information, compiled in a list, should include, as applicable:

- (a) the number, colour and type of life-rafts and pyrotechnics;
- (b) details of emergency medical supplies and water supplies; and
- (c) the type and frequencies of the emergency portable radio equipment.

NCC.GEN.140 Documents, manuals and information to be carried

Regulation (EU) No 800/2013

- (a) The following documents, manuals and information shall be carried on each flight as originals or copies unless otherwise specified:
 - (1) the AFM, or equivalent document(s);
 - (2) the original certificate of registration;
 - (3) the original certificate of airworthiness (CofA);
 - (4) the noise certificate;
 - (5) the declaration as specified in Annex III (Part-ORO), ORO.DEC.100, to Regulation (EU) No 965/2012;
 - (6) the list of specific approvals, if applicable;
 - (7) the aircraft radio licence, if applicable;
 - (8) the third party liability insurance certificate(s);
 - (9) the journey log, or equivalent, for the aircraft;
 - (10) details of the filed ATS flight plan, if applicable;
 - (11) current and suitable aeronautical charts for the route of the proposed flight and all routes along which it is reasonable to expect that the flight may be diverted;
 - (12) procedures and visual signals information for use by intercepting and intercepted aircraft;
 - (13) information concerning search and rescue services for the area of the intended flight;
 - (14) the current parts of the operations manual that are relevant to the duties of the crew members, which shall be easily accessible to the crew members;
 - (15) the MEL or CDL;
 - (16) appropriate notices to airmen (NOTAMs) and aeronautical information service (AIS) briefing documentation;
 - (17) appropriate meteorological information;
 - (18) cargo and/or passenger manifests, if applicable; and
 - (19) any other documentation that may be pertinent to the flight or is required by the States concerned with the flight.

- (b) In case of loss or theft of documents specified in (a)(2) to (a)(8), the operation may continue until the flight reaches its destination or a place where replacement documents can be provided.

AMC1 NCC.GEN.140 Documents, manuals and information to be carried

ED Decision 2013/021/R

GENERAL

The documents, manuals and information may be available in a form other than on printed paper. An electronic storage medium is acceptable if accessibility, usability and reliability can be assured.

GM1 NCC.GEN.140(a)(1) Documents, manuals and information to be carried

ED Decision 2013/021/R

AFM OR EQUIVALENT DOCUMENT

'Aircraft flight manual (AFM), or equivalent document' means the flight manual for the aircraft or other documents containing information required for the operation of the aircraft within the terms of its certificate of airworthiness, unless these data are available in the parts of the operations manual carried on board.

AMC1 NCC.GEN.140(a)(3) Documents, manuals and information to be carried

ED Decision 2017/010/R

CERTIFICATE OF AIRWORTHINESS

The certificate of airworthiness should be a normal certificate of airworthiness or a restricted certificate of airworthiness issued in accordance with the applicable airworthiness requirements.

GM1 NCC.GEN.140(a)(9) Documents, manuals and information to be carried

ED Decision 2013/021/R

JOURNEY LOG OR EQUIVALENT

'Journey log or equivalent' means in this context that the required information may be recorded in documentation other than a log book, such as the operational flight plan or the aircraft technical log.

AMC1 NCC.GEN.140(a)(11) Documents, manuals and information to be carried

ED Decision 2013/021/R

CURRENT AND SUITABLE AERONAUTICAL CHARTS

- (a) The aeronautical charts carried should contain data appropriate to the applicable air traffic regulations, rules of the air, flight altitudes, area/route and nature of the operation. Due consideration should be given to carriage of textual and graphic representations of:

- (1) aeronautical data including, as appropriate for the nature of the operation:
 - (i) airspace structure;
 - (ii) significant points, navigation aids (navaids) and air traffic services (ATS) routes;
 - (iii) navigation and communication frequencies;
 - (iv) prohibited, restricted and danger areas; and
 - (v) sites of other relevant activities that may hazard the flight; and
 - (2) topographical data, including terrain and obstacle data.
- (b) A combination of different charts and textual data may be used to provide adequate and current data.
 - (c) The aeronautical data should be appropriate for the current aeronautical information regulation and control (AIRAC) cycle.
 - (d) The topographical data should be reasonably recent, having regard to the nature of the planned operation.

AMC1 NCC.GEN.140(a)(12) Documents, manuals and information to be carried

ED Decision 2013/021/R

PROCEDURES AND VISUAL SIGNALS FOR USE BY INTERCEPTING AND INTERCEPTED AIRCRAFT

The procedures and the visual signals information for use by intercepting and intercepted aircraft should reflect those contained in the International Civil Aviation Organisation's (ICAO) Annex 2. This may be part of the operations manual.

GM1 NCC.GEN.140(a)(13) Documents, manuals and information to be carried

ED Decision 2013/021/R

SEARCH AND RESCUE INFORMATION

This information is usually found in the State's aeronautical information publication.

AMC1 NCC.GEN.140(a)(17) Documents, manuals and information to be carried

ED Decision 2022/005/R

APPROPRIATE METEOROLOGICAL INFORMATION

The appropriate meteorological information should be relevant to the planned operation, as specified in point (a) of point MET.TR.215 of Annex V (Part MET) to [Regulation \(EU\) 2017/373](#), and comprise the following:

- (a) the meteorological information that is specified in point (e) of point MET.TR.215 of Part-MET; and
- (b) supplemental meteorological information:
 - (1) information other than that specified in point (a), which should be based on data from certified meteorological service providers; or

- (2) information from other reliable sources of meteorological information that should be evaluated by the operator.

GM1 NCC.GEN.140(a)(17) Documents, manuals, and information to be carried

ED Decision 2022/005/R

DATA FROM CERTIFIED METEOROLOGICAL SERVICE PROVIDERS

In the context of point (b)(1) of [AMC1 NCC.GEN.140\(a\)\(17\)](#), the operator may consider that any meteorological information that is provided by the organisation within the scope of the meteorological information included in the flight documentation defined in point (e) of MET.TR.215 of Part-MET should originate only from authoritative sources or certified providers, and should not be transformed or tampered, except for the purpose of presenting the data in the correct format. The organisation's process should provide assurance that the integrity of such service is preserved in the data to be used by both flight crews and operators, regardless of their form.

GM2 NCC.GEN.140(a)(17) Documents, manuals, and information to be carried

ED Decision 2022/005/R

INFORMATION FROM OTHER RELIABLE SOURCES OF METEOROLOGICAL INFORMATION

In the context of point (b)(2) of [AMC1 NCC.GEN.140\(a\)\(17\)](#), reliable sources of meteorological information are organisations that are able to provide an appropriate level of data assurance in terms of accuracy and integrity. The operator may consider in the evaluation that the organisation has a quality assurance system in place that covers source selection, acquisition/import, processing, validity period check, and distribution phase of data.

GM3 NCC.GEN.140(a)(17) Documents, manuals, and information to be carried

ED Decision 2022/005/R

SUPPLEMENTAL METEOROLOGICAL INFORMATION AND SUPPLEMENTARY INFORMATION

Supplemental meteorological information: when operating under specific provisions and without the meteorological information from a certified service provider, the operator should use 'supplemental meteorological information', such as digital imagery. Related information can be found in point (e)(4) of [AMC1 CAT.OP.MPA.192](#).

Supplementary information: it is included in point (a) of [AMC1 CAT.GEN.MPA.180\(a\)\(18\)](#) and refers to meteorological information to be reported in specific cases such as freezing precipitation, blowing snow, thunderstorm, etc.

GM1 NCC.GEN.140(a)(19) Documents, manuals and information to be carried

ED Decision 2013/021/R

DOCUMENTS THAT MAY BE PERTINENT TO THE FLIGHT

Any other documents that may be pertinent to the flight or required by the States concerned with the flight may include, for example, forms to comply with reporting requirements.

STATES CONCERNED WITH THE FLIGHT

The States concerned are those of origin, transit, overflight and destination of the flight.

NCC.GEN.145 Handling of flight recorder recordings: Preservation, production, protection and use

Regulation (EU) 2019/1387

- (a) Following an accident, a serious incident or an occurrence identified by the investigating authority, the operator of an aircraft shall preserve the original recorded data of the flight recorders for a period of 60 days or until otherwise directed by the investigating authority.
- (b) The operator shall conduct operational checks and evaluations of recordings to ensure the continued serviceability of the flight recorders which are required to be carried.
- (c) The operator shall ensure that the recordings of flight parameters and data link communication messages required to be recorded on flight recorders are preserved. However, for the purpose of testing and maintaining those flight recorders, up to 1 hour of the oldest recorded data at the time of testing may be erased.
- (d) The operator shall keep and maintain up to date documentation that presents the necessary information to convert raw flight data into flight parameters expressed in engineering units.
- (e) The operator shall make available any flight recorder recordings that have been preserved, if so determined by the competent authority.
- (f) Without prejudice to Regulations (EU) No 996/2010 and (EU) 2016/679:
 - (1) Except for ensuring flight recorder serviceability, audio recordings from a flight recorder shall not be disclosed or used unless all of the following conditions are fulfilled:
 - (i) a procedure related to the handling of such audio recordings and of their transcript is in place;
 - (ii) all crew members and maintenance personnel concerned have given their prior consent;
 - (iii) such audio recordings are used only for maintaining or improving safety.
 - (1a) When flight recorder audio recordings are inspected for ensuring flight recorder serviceability, the operator shall protect the privacy of those audio recordings and make sure that they are not disclosed or used for purposes other than ensuring flight recorder serviceability.
 - (2) Flight parameters or data link messages recorded by a flight recorder shall not be used for purposes other than for the investigation of an accident or an incident which is subject to mandatory reporting, unless such recordings meet any of the following conditions:
 - (i) are used by the operator for airworthiness or maintenance purposes only;
 - (ii) are de-identified;
 - (iii) are disclosed under secure procedures.
 - (3) Except for ensuring flight recorder serviceability, images of the flight crew compartment that are recorded by a flight recorder shall not be disclosed or used unless all the following conditions are fulfilled:
 - (i) a procedure related to the handling of such image recordings is in place;

- (ii) all crew members and maintenance personnel concerned have given their prior consent;
 - (iii) such image recordings are used only for maintaining or improving safety.
- (3a) When images of the flight crew compartment that are recorded by a flight recorder are inspected for ensuring the serviceability of the flight recorder, then:
- (i) those images shall not be disclosed or used for purposes other than for ensuring flight recorder serviceability;
 - (ii) if body parts of crew members are likely to be visible on the images, the operator shall ensure the privacy of those images.

AMC1 NCC.GEN.145(a) Handling of flight recorder recordings: preservation, production, protection and use

ED Decision 2015/030/R

PRESERVATION OF RECORDED DATA FOR INVESTIGATION

- (a) The operator should establish procedures to ensure that flight recorder recordings are preserved for the investigating authority.
- (b) These procedures should include:
 - (1) instructions for flight crew members to deactivate the flight recorders immediately after completion of the flight and inform relevant personnel that the recording of the flight recorders should be preserved. These instructions should be readily available on board; and
 - (2) instructions to prevent inadvertent reactivation, test, repair or reinstallation of the flight recorders by operator personnel or during maintenance or ground handling activities performed by third parties.

GM1 NCC.GEN.145(a) Handling of flight recorder recordings: preservation, production, protection and use

ED Decision 2015/030/R

REMOVAL OF RECORDERS IN CASE OF AN INVESTIGATION

The need for removal of the recorders from the aircraft is determined by the investigating authority with due regard to the seriousness of an occurrence and the circumstances, including the impact on the operation.

AMC1 NCC.GEN.145(b) Handling of flight recorder recordings: preservation, production, protection and use

ED Decision 2021/005/R

INSPECTIONS AND CHECKS OF RECORDINGS

- (a) The operator should perform an inspection of the FDR recording and the CVR recording every year unless one or more of the following applies:
 - (1) If the flight recorder records on magnetic wire or uses frequency modulation technology, the time interval between two inspections of the recording should not exceed 3 months.

- (2) If the flight recorder is solid-state and the flight recorder system is fitted with continuous monitoring for proper operation, the time interval between two inspections of the recording may be up to 2 years.
 - (3) In the case of an aircraft equipped with two solid-state flight data and cockpit voice combination recorders, where
 - (i) the flight recorder systems are fitted with continuous monitoring for proper operation, and
 - (ii) the flight recorders share the same flight data acquisition, a comprehensive inspection of the recording needs only to be performed for one flight recorder position. The inspection of the recordings should be performed alternately so that each flight recorder position is inspected at time intervals not exceeding 4 years.
 - (4) Where all the following conditions are met, the inspection of FDR recording is not needed:
 - (i) the aircraft flight data is collected in the frame of a flight data monitoring (FDM) programme;
 - (ii) the data acquisition of mandatory flight parameters is the same for the FDR and for the recorder used for the FDM programme;
 - (iii) an inspection similar to the inspection of the FDR recording and covering all mandatory flight parameters is conducted on the FDM data at time intervals not exceeding 2 years; and
 - (iv) the FDR is solid-state and the FDR system is fitted with continuous monitoring for proper operation.
- (b) The operator should perform every 5 years an inspection of the data link recording.
 - (c) The operator should perform, at time intervals not exceeding 2 years, an inspection of the recording of flight recorders other than an FDR, which are installed on an aircraft in order to ensure compliance with [CAT.IDE.A.191](#) or [CAT.IDE.H.191](#);
 - (d) When installed, the aural or visual means for preflight checking of the flight recorders for proper operation should be used on each day when the aircraft is operated. When no such means is available for a flight recorder, the operator should perform an operational check of this flight recorder at intervals not exceeding 150 flight hours or 7 calendar days of operation, whichever is considered more suitable by the operator.
 - (e) The operator should check every 5 years, or in accordance with the recommendations of the sensor manufacturer, that the parameters dedicated to the FDR and not monitored by other means are being recorded within the calibration tolerances and that there is no discrepancy in the engineering conversion routines for these parameters.

GM1 NCC.GEN.145(b) Handling of flight recorder recordings: preservation, production, protection and use

ED Decision 2021/005/R

INSPECTION OF THE FLIGHT RECORDERS' RECORDINGS FOR ENSURING SERVICEABILITY

- (a) The inspection of the recorded flight parameters usually consists of the following:
 - (1) Making a copy of the complete recording file.

- (2) Converting the recording to parameters expressed in engineering units in accordance with the documentation required to be held.
 - (3) Examining a whole flight in engineering units to evaluate the validity of all mandatory parameters – this could reveal defects or noise in the measuring and processing chains and indicate necessary maintenance actions. The following should be considered:
 - (i) when applicable, each parameter should be expressed in engineering units and checked for different values of its operational range – for this purpose, some parameters may need to be inspected at different flight phases; and
 - (ii) (only applicable to an FDR) if the parameter is delivered by a digital data bus and the same data are utilised for the operation of the aircraft, then a reasonableness check may be sufficient; otherwise a correlation check may need to be performed:
 - (A) a reasonableness check is understood in this context as a subjective, qualitative evaluation, requiring technical judgement, of the recordings from a complete flight; and
 - (B) a correlation check is understood in this context as the process of comparing data recorded by the flight data recorder against the corresponding data derived from flight instruments, indicators or the expected values obtained during specified portion(s) of a flight profile or during ground checks that are conducted for that purpose.
 - (4) Retaining the most recent copy of the complete recording file and the corresponding recording inspection report that includes references to the documentation required to be held.
- (b) When performing the inspection of an audio recording from a flight recorder, precautions need to be taken to comply with [NCC.GEN.145\(f\)\(1a\)](#). The inspection of the audio recording usually consists of:
- (1) checking that the flight recorder operates correctly for the nominal duration of the recording;
 - (2) examining samples of in-flight audio recording from the flight recorder for evidence that the signal is acceptable on each channel and in all phases of flight; and
 - (3) preparing and retaining an inspection report.
- (c) The inspection of the DLR recording usually consists of:
- (1) Checking the consistency of the data link recording with other recordings for example, during a designated flight, the flight crew speaks out a few data link messages sent and received. After the flight, the data link recording and the CVR recording are compared for consistency.
 - (2) Retaining the most recent copy of the complete recording and the corresponding inspection report.
- (d) When inspecting images recorded by a flight recorder, precautions need to be taken to comply with [NCC.GEN.145\(f\)\(3a\)](#). The inspection of such images usually consists of the following:
- (1) checking that the flight recorder operates correctly for the nominal duration of the recording;

- (2) examining samples of images recorded in different flight phases for evidence that the images of each camera are of acceptable quality; and
- (3) preparing and retaining an inspection report.

GM2 NCC.GEN.145(b) Handling of flight recorder recordings: preservation, production, protection and use

ED Decision 2016/012/R

MONITORING AND CHECKING THE PROPER OPERATION OF FLIGHT RECORDERS – EXPLANATION OF TERMS

For the understanding of the terms used in [AMC1 NCC.GEN.145\(b\)](#):

- (a) ‘operational check of the flight recorder’ means a check of the flight recorder for proper operation. It is not a check of the quality of the recording and, therefore, it is not equivalent to an inspection of the recording. This check can be carried out by the flight crew or through a maintenance task.
- (b) ‘aural or visual means for preflight checking the flight recorders for proper operation’ means an aural or visual means for the flight crew to check before the flight the results of an automatically or manually initiated test of the flight recorders for proper operation. Such a means provides for an operational check that can be performed by the flight crew.
- (c) ‘flight recorder system’ means the flight recorder, its dedicated sensors and transducers, as well as its dedicated acquisition and processing equipment.
- (d) ‘continuous monitoring for proper operation’ means for a flight recorder system, a combination of system monitors and/or built-in test functions which operates continuously in order to detect the following:
 - (1) loss of electrical power to the flight recorder system;
 - (2) failure of the equipment performing acquisition and processing;
 - (3) failure of the recording medium and/or drive mechanism; and
 - (4) failure of the recorder to store the data in the recording medium as shown by checks of the recorded data including, as reasonably practicable for the storage medium concerned, correct correspondence with the input data.

However, detections by the continuous monitoring for proper operation do not need to be automatically reported to the flight crew compartment.

GM3 NCC.GEN.145(b) Handling of flight recorder recordings: preservation, production, protection and use

ED Decision 2021/005/R

CVR AUDIO QUALITY

Additional guidance material for performing the CVR recording inspection may be found in the document of the French Bureau d’Enquêtes et d’Analyses, titled ‘Guidance on CVR recording inspection’ and dated October 2018 or later.

AMC1 NCC.GEN.145(f)(1) Handling of flight recorder recordings: preservation, production, protection and use

ED Decision 2021/005/R

USE OF AUDIO RECORDINGS FOR MAINTAINING OR IMPROVING SAFETY

- (a) The procedure related to the handling of audio recordings from flight recorders and of their transcripts should be documented and signed by all parties (aircraft operator, crew members, maintenance personnel if applicable). This procedure should take into account Regulation (EU) 2016/679¹ and, as a minimum, define:
- (1) the method to obtain the consent of all crew members and maintenance personnel concerned;
 - (2) an access and security policy that restricts access to audio recordings from flight recorders and their transcripts to specifically authorised persons identified by their position;
 - (3) a retention policy and accountability, including the measures to be taken to ensure the security of audio recordings from flight recorders and their transcripts and their protection from misuse. The retention policy should specify the period of time after which such audio recordings and identified transcripts are destroyed;
 - (4) a description of the uses made of audio recordings from flight recorders and their transcripts;
 - (5) the participation of flight crew member representatives in the assessment of audio recordings from flight recorders and their transcripts;
 - (6) the conditions under which advisory briefing or remedial training should take place; this should always be carried out in a constructive and non-punitive manner; and
 - (7) the conditions under which actions other than advisory briefing or remedial training may be taken for reasons of gross negligence or significant continuing safety concern.
- (b) Each time an audio recording file from a flight recorder is read out under the conditions defined by [NCC.GEN.145\(f\)\(1\)](#):
- (1) parts of the audio recording file that contain information with a privacy content should be deleted to the extent possible, and it should not be permitted that the detail of information with a privacy content is transcribed; and
 - (2) the operator should retain, and when requested, provide to the competent authority:
 - (i) information on the use made (or the intended use) of the audio recording file; and
 - (ii) evidence that the persons concerned consented to the use made (or the intended use) of the audio recording file.
- (c) The person who fulfils the role of a safety manager should also be responsible for the protection and use of audio recordings from flight recorders and their transcripts, as well as for the

¹ Regulation (EU) 2016/679 of the European Parliament and of the Council of 27 April 2016 on the protection of natural persons with regard to the processing of personal data and on the free movement of such data, and repealing Directive 95/46/EC (General Data Protection Regulation) (OJ L 119, 4.5.2016, p. 1).

assessment of issues and their transmission to the manager(s) responsible for the process concerned.

- (d) In case a third party is involved in the use of audio recordings from flight recorders, contractual agreements with this third party should cover the aspects enumerated in (a) and (b).

AMC1 NCC.GEN.145(f)(1a) Handling of flight recorder recordings: preservation, production, protection and use

ED Decision 2021/005/R

INSPECTION OF AUDIO RECORDINGS FOR ENSURING SERVICEABILITY

- (a) When an inspection of the audio recordings from a flight recorder is performed for ensuring audio quality and intelligibility of recorded communications:
- (1) the privacy of the audio recordings should be ensured (e.g. by locating the replay equipment in a separated area and/or using headsets);
 - (2) access to the replay equipment should be restricted to specifically authorised persons identified by their position;
 - (3) provision should be made for the secure storage of the recording medium, the audio recording files and copies thereof;
 - (4) the audio recording files and copies thereof should be destroyed not earlier than 2 months and not later than 1 year after completion of the inspection of the audio recordings, except that audio samples with no privacy content may be retained for enhancing this inspection (e.g. for comparing audio quality);
 - (5) only the accountable manager of the operator and, when identified to comply with [ORO.GEN.200](#), the person fulfilling the role of safety manager should be entitled to request a copy of the audio recording files.
- (b) The conditions enumerated in (a) should also be complied with if the inspection of the audio recordings is subcontracted to a third party. The contractual agreements with the third party should explicitly cover these aspects.

AMC1 NCC.GEN.145(f)(3) Handling of flight recorder recordings: preservation, production, protection and use

ED Decision 2021/005/R

USE OF IMAGES FROM THE FLIGHT CREW COMPARTMENT FOR MAINTAINING OR IMPROVING SAFETY

- (a) The procedure related to the handling of images of the flight crew compartment that are recorded by a flight recorder should be documented and signed by all parties involved (aircraft operator, crew member representatives nominated either by the union or the crew themselves, maintenance personnel representatives if applicable). This procedure should take into account Regulation (EU) 2016/679 and, as a minimum, define the following aspects:
- (1) the method to obtain the consent of all crew members and maintenance personnel concerned;
 - (2) an access and security policy that restricts access to the image recordings to specifically authorised persons identified by their position;

- (3) a retention policy and accountability, including the measures to ensure the security of the image recordings and their protection from misuse;
 - (4) a description of the uses made of the image recordings;
 - (5) the participation of flight crew member representatives in the assessment of the image recordings;
 - (6) the conditions under which advisory briefing or remedial training should take place; this should always be carried out in a constructive and non-punitive manner; and
 - (7) the conditions under which actions other than advisory briefing or remedial training may be taken for reasons of gross negligence or significant continuing safety concern.
- (b) Each time a recording file from a flight recorder and containing images of the flight crew compartment is read out for purposes other than ensuring the serviceability of that flight recorder:
- (1) images that contain information with a privacy content should be deleted to the extent possible, and it should not be permitted that the detail of information with a privacy content is transcribed;
 - (2) the operator should retain, and when requested, provide the competent authority with:
 - (i) information on the use made (or the intended use) of the recording file; and
 - (ii) evidence that the crew members concerned consented to the use made (or the intended use) of the flight crew compartment images.
- (c) The person fulfilling the role of safety manager should be responsible for the protection and use of images of the flight crew compartment that are recorded by a flight recorder, as well as for the assessment of issues and their transmission to the manager(s) responsible for the process concerned.
- (d) In case a third party is involved in the use of images of the flight crew compartment that are recorded by a flight recorder, contractual agreements with this third party should cover the aspects enumerated in (a) and (b).

AMC1 NCC.GEN.145(f)(3a) Handling of flight recorder recordings: preservation, production, protection and use

ED Decision 2021/005/R

INSPECTION OF IMAGES OF THE FLIGHT CREW COMPARTMENT FOR ENSURING SERVICEABILITY

- (a) When images of the flight crew compartment recorded by a flight recorder are inspected for ensuring the serviceability of the flight recorder, and any body part of a crew member is likely to be visible on these images, then:
- (1) the privacy of the image recordings should be ensured (e.g. by locating the replay equipment in a separated area);
 - (2) access to the replay equipment should be restricted to specifically authorised persons identified by their position;
 - (3) provisions should be made for the secure storage of the recording medium, the image recording files and copies thereof;
 - (4) the image recording files and copies thereof should be destroyed not earlier than 2 months and not later than 1 year after completion of the inspection of the image

recordings. Images that do not contain any body part of a person may be retained for enhancing this inspection (e.g. for comparing image quality); and

- (5) only the accountable manager of the operator and, when identified to comply with [ORO.GEN.200](#), the safety manager should be entitled to request a copy of the image recording files.
- (b) The conditions enumerated in (a) should also be complied with if the inspection of the image recording is subcontracted to a third party. The contractual agreements with the third party should explicitly cover these aspects.

GM1 NCC.GEN.145(f) Handling of flight recorder recordings: preservation, production, protection and use

ED Decision 2021/005/R

FLIGHT CREW COMPARTMENT

If there are no compartments to physically segregate the flight crew from the passengers during the flight, the 'flight crew compartment' in point (f) of [NCC.GEN.145](#) should be understood as the area including:

- (a) the flight crew seats;
- (b) aircraft and engine controls;
- (c) aircraft instruments;
- (d) windshield and windows used by the flight crew to get an external view while seated at their duty station; and
- (e) circuit breakers accessible by the flight crew while seated at their duty station.

NCC.GEN.150 Transport of dangerous goods

Regulation (EU) No 800/2013

- (a) The transport of dangerous goods by air shall be conducted in accordance with Annex 18 to the Chicago Convention as last amended and amplified by the *Technical Instructions for the Safe Transport of Dangerous Goods by Air* (ICAO Doc 9284-AN/905), including its supplements and any other addenda or corrigenda.
- (b) Dangerous goods shall only be transported by the operator approved in accordance with Annex V (Part-SPA), Subpart G, to Regulation (EU) No 965/2012 except when:
 - (1) they are not subject to the Technical Instructions in accordance with Part 1 of those Instructions; or
 - (2) they are carried by passengers or crew members, or are in baggage, in accordance with Part 8 of the Technical Instructions.
- (c) The operator shall establish procedures to ensure that all reasonable measures are taken to prevent dangerous goods from being carried on board inadvertently.
- (d) The operator shall provide personnel with the necessary information enabling them to carry out their responsibilities, as required by the Technical Instructions.
- (e) The operator shall, in accordance with the Technical Instructions, report without delay to the competent authority and the appropriate authority of the State of occurrence in the event of any dangerous goods accidents or incidents.

- (f) The operator shall ensure that passengers are provided with information about dangerous goods in accordance with the Technical Instructions.
- (g) The operator shall ensure that notices giving information about the transport of dangerous goods are provided at acceptance points for cargo as required by the Technical Instructions.

AMC1 NCC.GEN.150(e) Transport of dangerous goods

ED Decision 2013/021/R

DANGEROUS GOODS ACCIDENT AND INCIDENT REPORTING

- (a) Any type of dangerous goods accident or incident, or the finding of:
 - (1) undeclared or misdeclared dangerous goods in cargo;
 - (2) forbidden dangerous goods in mail; or
 - (3) forbidden dangerous goods in passenger or crew baggage, or on the person of a passenger or a crew membershould be reported. For this purpose, the Technical Instructions consider that reporting of undeclared and misdeclared dangerous goods found in cargo also applies to items of operators' stores that are classified as dangerous goods.
- (b) The first report should be dispatched within 72 hours of the event. It may be sent by any means, including e-mail, telephone or fax. This report should include the details that are known at that time, under the headings identified in (c). If necessary, a subsequent report should be made as soon as possible giving all the details that were not known at the time the first report was sent. If a report has been made verbally, written confirmation should be sent as soon as possible.
- (c) The first and any subsequent report should be as precise as possible and contain the following data, where relevant:
 - (1) date of the incident or accident or the finding of undeclared or misdeclared dangerous goods;
 - (2) location and date of flight;
 - (3) description of the goods and the reference number of the air waybill, pouch, baggage tag, ticket, etc.;
 - (4) proper shipping name (including the technical name, if appropriate) and United Nations (UN)/identification (ID) number, when known;
 - (5) class or division and any subsidiary risk;
 - (6) type of packaging, and the packaging specification marking on it;
 - (7) quantity;
 - (8) name and address of the passenger, etc.;
 - (9) any other relevant details;
 - (10) suspected cause of the incident or accident;
 - (11) action taken;
 - (12) any other reporting action taken; and
 - (13) name, title, address and telephone number of the person making the report.

- (d) Copies of relevant documents and any photographs taken should be attached to the report.
- (e) A dangerous goods accident or incident may also constitute an aircraft accident, serious incident or incident. The criteria for reporting both types of occurrence should be met.
- (f) The following dangerous goods reporting form should be used, but other forms, including electronic transfer of data, may be used provided that at least the minimum information of this AMC is supplied:

DANGEROUS GOODS OCCURRENCE REPORT			DGOR No:
1. Operator:	2. Date of Occurrence:	3. Local time of occurrence:	
4. Flight date:			
5. Departure aerodrome:		6. Destination aerodrome:	
7. Aircraft type:		8. Aircraft registration:	
9. Location of occurrence:		10. Origin of the goods:	
11. Description of the occurrence, including details of injury, damage, etc. (if necessary continue on the reverse of this form)			
12. Proper shipping name (including the technical name):			13. UN/ID No (when known):
14. Class/Division (when known):	15. Subsidiary risk(s):	16. Packing group:	17. Category (Class 7 only):
18. Type of packaging:	19. Packaging specification marking:	20. No of packages:	21. Quantity (or transport index, if applicable):
22. Name and address of passenger, etc.:			
23. Other relevant information (including suspected cause, any action taken):			
24. Name and title of person making report:		25. Telephone No:	
26. Company:		27. Reporters ref:	
28. Address:		29. Signature:	
		30. Date:	

Description of the occurrence (continuation)

Notes for completion of the form:

1. A dangerous goods accident is as defined in [Annex I](#). For this purpose serious injury is as defined in Regulation (EU) No 996/2010 of the European Parliament and of the Council¹.
2. The initial report should be dispatched unless exceptional circumstances prevent this. This occurrence report form, duly completed, should be sent as soon as possible, even if all the information is not available.
3. Copies of all relevant documents and any photographs should be attached to this report.
4. Any further information, or any information not included in the initial report, should be sent as soon as possible to the authorities identified in [NCC.GEN.150\(e\)](#).
5. Providing it is safe to do so, all dangerous goods, packagings, documents, etc. relating to the occurrence should be retained until after the initial report has been sent to the authorities identified in [NCC.GEN.150\(e\)](#), and they have indicated whether or not these should continue to be retained.

GM1 NCC.GEN.150 Transport of dangerous goods

ED Decision 2013/021/R

GENERAL

- (a) The requirement to transport dangerous goods by air in accordance with the Technical Instructions is irrespective of whether:
- (1) the flight is wholly or partly within or wholly outside the territory of a State; or

¹ OJ L 295, 12.11.2010, p. 35.

- (2) an approval to carry dangerous goods in accordance with Annex V (Part-SPA), Subpart G is held.
- (b) The Technical Instructions provide that in certain circumstances dangerous goods, which are normally forbidden on an aircraft, may be carried. These circumstances include cases of extreme urgency or when other forms of transport are inappropriate or when full compliance with the prescribed requirements is contrary to the public interest. In these circumstances all the States concerned may grant exemptions from the provisions of the Technical Instructions provided that an overall level of safety that is at least equivalent to that provided by the Technical Instructions is achieved. Although exemptions are most likely to be granted for the carriage of dangerous goods that are not permitted in normal circumstances, they may also be granted in other circumstances, such as when the packaging to be used is not provided for by the appropriate packing method or the quantity in the packaging is greater than that permitted. The Technical Instructions also make provision for some dangerous goods to be carried when an approval has been granted only by the State of Origin and the competent authority.
- (c) When an exemption is required, the States concerned are those of origin, transit, overflight and destination of the consignment and that of the operator. For the State of overflight, if none of the criteria for granting an exemption are relevant, an exemption may be granted based solely on whether it is believed that an equivalent level of safety in air transport has been achieved.
- (d) The Technical Instructions provide that exemptions and approvals are granted by the 'appropriate national authority', which is intended to be the authority responsible for the particular aspect against which the exemption or approval is being sought. The operator should ensure that all relevant conditions on an exemption or approval are met.
- (e) The exemption or approval referred to in (b) to (d) is in addition to the approval required by Annex V (Part SPA), Subpart G.

SUBPART B: OPERATIONAL PROCEDURES

NCC.OP.100 Use of aerodromes and operating sites

Regulation (EU) No 800/2013

The operator shall only use aerodromes and operating sites that are adequate for the type of aircraft and operation concerned.

AMC1 NCC.OP.100 Use of aerodromes and operating sites

ED Decision 2013/021/R

USE OF OPERATING SITES

- (a) The pilot-in-command should have available from a pre-survey or other publication, for each operating site to be used, diagrams or ground and aerial photographs, depiction (pictorial) and description of:
- (1) the overall dimensions of the operating site;
 - (2) location and height of relevant obstacles to approach and take-off profiles and in the manoeuvring area;
 - (3) approach and take-off flight paths;
 - (4) surface condition (blowing dust/snow/sand);
 - (5) provision of control of third parties on the ground (if applicable);
 - (6) lighting, if applicable;
 - (7) procedure for activating the operating site in accordance with national regulations, if applicable;
 - (8) other useful information, for example details of the appropriate ATS agency and frequency; and
 - (9) site suitability with reference to available aircraft performance.
- (b) Where the operator specifically permits operation from sites that are not pre-surveyed, the pilot-in-command should make, from the air, a judgement on the suitability of a site. At least (a)(1) to (a)(6) inclusive and (a)(9) should be considered.

GM1 NCC.OP.100 Use of aerodromes and operating sites

ED Decision 2013/021/R

PUBLICATIONS

'Other publication' mentioned in [AMC1 NCC.OP.100](#) refers to publication means, such as:

- (a) civil as well as military aeronautical information publication;
- (b) visual flight rules (VFR) guides;
- (c) commercially available aeronautical publications; and
- (d) non-commercially available publications.

NCC.OP.101 Altimeter check and settings

Regulation (EU) 2021/2237

- (a) The operator shall establish procedures for altimeter checking before each departure.
- (b) The operator shall establish procedures for altimeter settings for all phases of flight, which shall take into account the procedures established by the State of the aerodrome or the State of the airspace, if applicable.

GM1 NCC.OP.101 Altimeter check and settings

ED Decision 2022/014/R

ALTIMETER SETTING PROCEDURES

The following paragraphs of ICAO Doc 8168 (PANS-OPS), Volume III provide recommended guidance on how to develop the altimeter setting procedure:

- (a) 3.2 'Pre-flight operational test';
- (b) 3.3 'Take-off and climb';
- (c) 3.5 'Approach and landing'.

NCC.OP.105 Specification of isolated aerodromes – aeroplanes

Regulation (EU) 2021/1296

For the selection of alternate aerodromes and the fuel/energy planning and in-flight re-planning policy, the operator shall not consider an aerodrome as an isolated aerodrome unless the flying time to the nearest weather-permissible destination alternate aerodrome is more than:

- (a) for aeroplanes with reciprocating engines, 60 minutes; or
- (b) for turbine-engined aeroplanes, 90 minutes.

GM1 NCC.OP.105 Specification of isolated aerodromes — aeroplanes

ED Decision 2022/005/R

USE OF AN AERODROME AS AN ISOLATED AERODROME

The concept of an isolated aerodrome allows the operator to use aerodromes that would otherwise be impossible or impractical to use with sufficient fuel to fly to the destination aerodrome and then to a destination alternate aerodrome, provided that operational criteria are used to ensure a safe-landing option, for example by specifying a PNR. If alternate fuel is carried, the operator is not required to consider the aerodrome isolated and use the aforementioned operational criteria.

NCC.OP.110 Aerodrome operating minima — general

Regulation (EU) 2021/2237

- (a) The operator shall establish aerodrome operating minima for each departure, destination or alternate aerodrome that is planned to be used in order to ensure separation of the aircraft from terrain and obstacles and to mitigate the risk of loss of visual references during the visual flight segment of instrument approach operations.
- (b) The method used to establish aerodrome operating minima shall take all the following elements into account:

- (1) the type, performance, and handling characteristics of the aircraft;
 - (2) the equipment available on the aircraft for the purpose of navigation, acquisition of visual references, and/or control of the flight path during take-off, approach, landing, and missed approach;
 - (3) any conditions or limitations stated in the aircraft flight manual (AFM);
 - (4) the dimensions and characteristics of the runways/final approach and take-off areas (FATOs) that may be selected for use;
 - (5) the adequacy and performance of the available visual and non-visual aids and infrastructure;
 - (6) the obstacle clearance altitude/height (OCA/H) for the instrument approach procedures (IAPs);
 - (7) the obstacles in the climb-out areas and necessary clearance margins;
 - (8) any non-standard characteristics of the aerodrome, the IAP or the environment;
 - (9) the composition of the flight crew, their competence and experience;
 - (10) the IAP;
 - (11) the aerodrome characteristics and the available air navigation services (ANS);
 - (12) any minima that may be promulgated by the State of the aerodrome;
 - (13) the conditions prescribed in any specific approvals for low-visibility operations (LVOs) or operations with operational credits; and
 - (14) the relevant operational experience of the operator.
- (c) The operator shall specify a method of determining aerodrome operating minima in the operations manual.

AMC1 NCC.OP.110 Aerodrome operating minima – general

ED Decision 2013/021/R

COMMERCIALLY AVAILABLE INFORMATION

An acceptable method of specifying aerodrome operating minima is through the use of commercially available information.

AMC2 NCC.OP.110 Aerodrome operating minima – general

ED Decision 2013/021/R

GENERAL

- (a) The aerodrome operating minima should not be lower than the values given in [NCC.OP.111](#) or [AMC3 NCC.OP.110\(c\)](#).
- (b) Whenever practical approaches should be flown as stabilised approaches (SAPs). Different procedures may be used for a particular approach to a particular runway.
- (c) Whenever practical, non-precision approaches should be flown using the continuous descent final approach (CDFA) technique. Different procedures may be used for a particular approach to a particular runway.

- (d) For approaches not flown using the CDFA technique: when calculating the minima in accordance with [NCC.OP.111](#), the applicable minimum runway visual range (RVR) should be increased by 200 m for Category A and B aeroplanes and by 400 m for Category C and D aeroplanes, provided the resulting RVR/converted meteorological visibility (CMV) value does not exceed 5 000 m. SAP or CDFA should be used as soon as facilities are improved to allow these techniques.

AMC3 NCC.OP.110 Aerodrome operating minima — general

ED Decision 2022/012/R

TAKE-OFF OPERATIONS

- (a) General
- (1) Take-off minima should be expressed as VIS or RVR limits, taking into account all relevant factors for each aerodrome planned to be used and aircraft characteristics and equipment. Where there is a specific need to see and avoid obstacles on departure and/or for a forced landing, additional conditions, e.g. ceiling, should be specified.
 - (2) The pilot-in-command should not commence take-off unless the weather conditions at the aerodrome of departure are equal to or better than applicable minima for landing at that aerodrome, unless a weather-permissible take-off alternate aerodrome is available.
 - (3) When the reported VIS is below that required for take-off and the RVR is not reported, a take-off should only be commenced if the pilot-in-command can determine that the visibility along the take-off runway/area is equal to or better than the required minimum.
 - (4) When no reported VIS or RVR is available, a take-off should only be commenced if the pilot-in-command can determine that the visibility along the take-off runway/area is equal to or better than the required minimum.
- (b) Visual reference
- (1) The take-off minima should be selected to ensure sufficient guidance to control the aircraft in the event of both a rejected take-off in adverse circumstances and a continued take-off after failure of the critical engine.
 - (2) For night operations, the prescribed runway lights should be in operation to mark the runway and any obstacles.
- (c) Required RVR or VIS
- (1) Aeroplanes
 - (i) For multi-engined aeroplanes, with such performance that in the event of a critical engine failure at any point during take-off the aeroplane can either stop or continue the take-off to a height of 1 500 ft above the aerodrome while clearing obstacles by the required margins, the take-off minima specified by the operator should be expressed as RVR or VIS values not lower than those specified in Table 1.
 - (ii) Multi-engined aeroplanes without the performance to comply with the conditions in (c)(1)(i) in the event of a critical engine failure may need to re-land immediately and to see and avoid obstacles in the take-off area. Such aeroplanes may be operated to the following take-off minima provided that they are able to comply with the applicable obstacle clearance criteria, assuming engine failure at the specified height:

- (A) The take-off minima specified by the operator should be based on the height from which the one-engine-inoperative (OEI) net take-off flight path can be constructed.
- (B) The RVR minima used should not be lower than either of the values specified in Table 1 or Table 2.
- (iii) For single-engined complex aeroplane operations, the take-off minima specified by the operator should be expressed as RVR/CMV values not lower than those specified in Table 1 below.

Unless the operator is using a risk period, whenever the surface in front of the runway does not allow for a safe forced landing, the RVR values should not be lower than 800 m. In this case, the proportion of the flight to be considered starts at the lift-off position and ends when the aeroplane is able to turn back and land on the runway in the opposite direction or glide to the next landing site in case of power loss.

- (iv) When the RVR or the VIS is not available, the commander should not commence take-off unless he or she can determine that the actual conditions satisfy the applicable take-off minima.

Table 1
Take-off — aeroplanes (without LVTO approval)
RVR or VIS

Facilities	RVR or VIS (m)*
Day only: Nil**	500
Day: at least runway edge lights or runway centre line markings Night: at least runway edge lights or runway centre line lights and runway end lights	400

* The reported RVR or VIS value representative of the initial part of the take-off run can be replaced by pilot assessment.

** The pilot is able to continuously identify the take-off surface and maintain directional control.

Table 2
Take-off — aeroplanes (without LVTO approval)
Assumed engine failure height above the runway versus RVR or VIS

Assumed engine failure height above the take-off runway (ft)	RVR or VIS (m)*
<50	400
51–100	400
101–150	400
151–200	500
201–300	1 000
>300 or if no positive take-off flight path can be constructed	1 500

* The reported RVR or VIS value representative of the initial part of the take-off run can be replaced by pilot assessment.

- (2) Helicopters
- (i) For helicopters having a mass where it is possible to reject the take-off and land on the FATO in case of the critical engine failure being recognised at or before the take-off decision point (TDP), the operator should specify an RVR or VIS as take-off minima in accordance with Table 3.
 - (ii) For all other cases, the pilot-in-command should operate to take-off minima of 800 m RVR or VIS and remain clear of cloud during the take-off manoeuvre until reaching the performance capabilities of (c)(2)(i).
 - (iii) For point-in-space (PinS) departures to an initial departure fix (IDF), the take-off minima should be selected to ensure sufficient guidance to see and avoid obstacles and return to the heliport if the flight cannot continue visually to the IDF.

Table 3
Take-off — helicopters (without LVTO approval)
RVR or VIS

Onshore aerodromes or operating sites with instrument flight rules (IFR) departure procedures	RVR or VIS (m)**
No light and no markings (day only)	400 or the rejected take-off distance, whichever is the greater
No markings (night)	800
Runway edge/FATO light and centre line marking	400
Runway edge/FATO light, centre line marking and relevant RVR information	400
Offshore helideck*	
Two-pilot operations	400
Single-pilot operations	500

* The take-off flight path to be free of obstacles.

** On PinS departures to IDF, VIS should not be less than 800 m and the ceiling should not be less than 250 ft.

AMC4 NCC.OP.110 Aerodrome operating minima — general

ED Decision 2022/012/R

DETERMINATION OF DH/MDH FOR INSTRUMENT APPROACH OPERATIONS — AEROPLANES

- (a) The decision height (DH) to be used for a 3D approach operation or a 2D approach operation flown using the continuous descent final approach (CDFA) technique should not be lower than the highest of:
- (1) the obstacle clearance height (OCH) for the category of aircraft;
 - (2) the published approach procedure DH or minimum descent height (MDH) where applicable;
 - (3) the system minima specified in Table 4;
 - (4) the minimum DH permitted for the runway specified in Table 5; or

- (5) the minimum DH specified in the AFM or equivalent document, if stated.
- (b) The MDH for a 2D approach operation flown not using the CDFA technique should not be lower than the highest of:
 - (1) the OCH for the category of aircraft;
 - (2) the published approach procedure MDH where applicable;
 - (3) the system minima specified in Table 4;
 - (4) the lowest MDH permitted for the runway specified in Table 5; or
 - (5) the lowest MDH specified in the AFM, if stated.

DETERMINATION OF DH/MDH FOR INSTRUMENT APPROACH OPERATIONS — HELICOPTERS

- (c) The DH or MDH should not be lower than the highest of:
 - (1) the OCH for the category of aircraft used;
 - (2) the published approach procedure DH or MDH where applicable;
 - (3) the system minima specified in Table 4;
 - (4) the lowest DH or MDH permitted for the runway/FATO specified in Table 6 if applicable;
or
 - (5) the lowest DH or MDH specified in the AFM, if stated.

Table 4
System minima — all aircraft

Facility	Lowest DH/MDH (ft)
ILS/MLS/GLS	200
GNSS/SBAS (LPV)	200*
Precision approach radar (PAR)	200
GNSS/SBAS (LP)	250
GNSS (LNAV)	250
GNSS/Baro VNAV (LNAV/VNAV)	250
Helicopter PinS approach	250**
LOC with or without DME	250
SRA (terminating at ½ NM)	250
SRA (terminating at 1 NM)	300
SRA (terminating at 2 NM or more)	350
VOR	300
VOR/DME	250
NDB	350
NDB/DME	300
VDF	350

* For localiser performance with vertical guidance (LPV), a DH of 200 ft may be used only if the published final approach segment (FAS) datablock sets a vertical alert limit not exceeding 35 m. Otherwise, the DH should not be lower than 250 ft.

** For PinS approaches with instructions to ‘proceed VFR’ to an undefined or virtual destination, the DH or MDH should be with reference to the ground below the MAPt.

Table 5
Runway type minima — aeroplanes

Runway type	Lowest DH/MDH (ft)
Precision approach (PA) runway, category I	200
NPA runway	250
Non-instrument runway	Circling minima as shown in Table 1 in NCC.OP.112

Table 6
Type of runway/FATO versus lowest DH/MDH — helicopters

Type of runway/FATO	Lowest DH/MDH (ft)
PA runway, category I	200
NPA runway	
Non-instrument runway	
Instrument FATO	200
FATO	250

Table 6 does not apply to helicopter PinS approaches with instructions to ‘proceed VFR’.

AMC5 NCC.OP.110 Aerodrome operating minima

ED Decision 2022/014/R

DETERMINATION OF RVR OR VIS FOR INSTRUMENT APPROACH OPERATIONS — AEROPLANES

- (a) The RVR or VIS for straight-in instrument approach operations should not be less than the greatest of the following:
- (1) the minimum RVR or VIS for the type of runway used according to Table 7; or
 - (2) the minimum RVR determined according to the MDH or DH and class of lighting facility according to Table 8; or
 - (3) the minimum RVR according to the visual and non-visual aids and on-board equipment used according to Table 9.

If the value determined in (1) is a VIS, then the result is a minimum VIS. In all other cases, the result is a minimum RVR.

- (b) For Category A and B aeroplanes, if the RVR or VIS determined in accordance with point (a) is greater than 1 500 m, then 1 500 m should be used.
- (c) If the approach is flown with a level flight segment at or above the MDA/H, then 200 m should be added to the RVR calculated in accordance with (a) and (b) for Category A and B aeroplanes and 400 m for Category C and D aeroplanes.
- (d) The visual aids should comprise standard runway day markings, runway edge lights, threshold lights, runway end lights and approach lights as defined in Table 10.

Table 7
Type of runway versus minimum RVR or VIS — aeroplanes

Type of runway	Minimum RVR or VIS (m)
PA runway, category I	RVR 550
NPA runway	RVR 750
Non-instrument runway	VIS according to Table 1 in NCC.OP.112 (Circling minima)

Table 8
RVR versus DH/MDH

DH or MDH (ft)			Class of lighting facility			
			FALS	IALS	BALS	NALS
			RVR (m)			
200	-	210	550	750	1 000	1 200
211	-	240	550	800	1 000	1 200
241	-	250	550	800	1 000	1 300
251	-	260	600	800	1 100	1 300
261	-	280	600	900	1 100	1 300
281	-	300	650	900	1 200	1 400
301	-	320	700	1 000	1 200	1 400
321	-	340	800	1 100	1 300	1 500
341	-	360	900	1 200	1 400	1 600
361	-	380	1 000	1 300	1 500	1 700
381	-	400	1 100	1 400	1 600	1 800
401	-	420	1 200	1 500	1 700	1 900
421	-	440	1 300	1 600	1 800	2 000
441	-	460	1 400	1 700	1 900	2 100
461	-	480	1 500	1 800	2 000	2 200
481		500	1 500	1 800	2 100	2 300
501	-	520	1 600	1 900	2 100	2 400
521	-	540	1 700	2 000	2 200	2 400
541	-	560	1 800	2 100	2 300	2 400
561	-	580	1 900	2 200	2 400	2 400
581	-	600	2 000	2 300	2 400	2 400
601	-	620	2 100	2 400	2 400	2 400
621	-	640	2 200	2 400	2 400	2 400
641		660	2 300	2 400	2 400	2 400
661	and above		2 400	2 400	2 400	2 400

Table 9
Visual and non-visual aids and/or on-board equipment versus minimum RVR — aeroplanes

Type of approach	Facilities	Lowest RVR	
		Multi-pilot operations	Single-pilot operations
3D operations	runway touchdown zone lights (RTZL) and runway centre line lights (RCLL)	No limitation	
Final approach track offset $\leq 15^\circ$ for category A and B aeroplanes or $\leq 5^\circ$ for Category C and D aeroplanes	without RTZL and RCLL but using HUDLS or equivalent system; autopilot or flight director to the DH	No limitation	600 m
	No RTZL and RCLL, not using HUDLS or equivalent system or autopilot to the DH	750 m	800 m
3D operations	runway touchdown zone lights (RTZL) and runway centre line lights (RCLL) and Final approach track offset $> 15^\circ$ for Category A and B aeroplanes or Final approach track offset $> 5^\circ$ for Category C and D aeroplanes	800 m	1 000 m
3D operations	without RTZL and RCLL but using HUDLS or equivalent system; autopilot or flight director to the DH and Final approach track offset $> 15^\circ$ for Category A and B aeroplanes or Final approach track offset $> 5^\circ$ for Category C and D aeroplanes	800 m	1 000 m
2D operations	Final approach track offset $\leq 15^\circ$ for category A and B aeroplanes or $\leq 5^\circ$ for Category C and D aeroplanes	750 m	2D operations
	Final approach track offset $> 15^\circ$ for Category A and B aeroplanes	1 000 m	1 000 m
	Final approach track offset $> 5^\circ$ for Category C and D aeroplanes	1 200 m	1 200 m

Table 10
Approach lighting systems — aeroplanes

Class of lighting facility	Length, configuration and intensity of approach lights
FALS	CAT I lighting system (HIALS ≥ 720 m) distance coded centre line, barrette centre line
IALS	Simple approach lighting system (HIALS 420–719 m) single source, barrette
BALS	Any other approach lighting system (HIALS, MALS or ALS 210–419 m)
NALS	Any other approach lighting system (HIALS, MALS or ALS < 210 m) or no approach lights

- (e) For night operations or for any operation where credit for visual aids is required, the lights should be on and serviceable except as provided for in Table 15.
- (f) Where any visual or non-visual aid specified for the approach and assumed to be available in the determination of operating minima is unavailable, revised operating minima will need to be determined.

AMC6 NCC.OP.110 Aerodrome operating minima — general

ED Decision 2022/012/R

DETERMINATION OF RVR OR VIS FOR TYPE A INSTRUMENT APPROACH AND TYPE B CAT I INSTRUMENT APPROACH OPERATIONS — HELICOPTERS

- (a) For IFR operations, the RVR or VIS should not be less than the greatest of:
 - (1) the minimum RVR or VIS for the type of runway/FATO used according to Table 11;
 - (2) the minimum RVR determined according to the MDH or DH and class of lighting facility according to Table 12; or
 - (3) for PinS operations with instructions to ‘proceed visually’, the distance between the MAPt of the PinS and the FATO or its approach light system.

If the value determined in (1) is a VIS, then the result is a minimum VIS. In all other cases, the result is a minimum RVR.

- (b) For PinS operations with instructions to ‘proceed VFR’, the VIS should be compatible with visual flight rules.
- (c) For type A instrument approaches where the MAPt is within $\frac{1}{2}$ NM of the landing threshold, the approach minima specified for FALS may be used regardless of the length of approach lights available. However, FATO/runway edge lights, threshold lights, end lights and FATO/runway markings are still required.
- (d) An RVR of less than 800 m should not be used except when using a suitable autopilot coupled to an ILS, MLS, GLS or LPV, in which case normal minima apply.
- (e) For night operations, ground lights should be available to illuminate the FATO/runway and any obstacles.
- (f) The visual aids should comprise standard runway day markings, runway edge lights, threshold lights and runway end lights and approach lights as specified in Table 13.
- (g) For night operations or for any operation where credit for runway and approach lights as defined in Table 13 is required, the lights should be on and serviceable except as provided for in Table 15.

Table 11

Type of runway/FATO versus minimum RVR or VIS — helicopters

Type of runway/FATO	Minimum RVR or VIS
PA runway, category I NPA runway Non-instrument runway	RVR 550 m
Instrument FATO FATO	RVR 550 m RVR or VIS 800 m

Table 12

Onshore helicopter instrument approach minima

DH/MDH (ft)	Facilities versus RVR (m)			
	FALS	IALS	BALS	NALS
200	550	600	700	1 000
201–249	550	650	750	1 000
250–299	600*	700*	800	1 000
300 and above	750*	800	900	1 000

* Minima on 2D approach operations should be no lower than 800 m.

Table 13

Approach lighting systems — helicopters

Class of lighting facility	Length, configuration and intensity of approach lights
FALS	CAT I lighting system (HIALS \geq 720 m) distance coded centre line, barrette centre line
IALS	Simple approach lighting system (HIALS 420–719 m) single source, barrette
BALS	Any other approach lighting system (HIALS, MALS or ALS 210–419 m)
NALS	Any other approach lighting system (HIALS, MALS or ALS $<$ 210 m) or no approach lights

AMC7 NCC.OP.110 Aerodrome operating minima – general

ED Decision 2013/021/R

VISUAL APPROACH OPERATIONS

For a visual approach operation the RVR should not be less than 800 m.

AMC8 NCC.OP.110 Aerodrome operating minima — general

ED Decision 2022/012/R

CONVERSION OF VISIBILITY TO CMV — AEROPLANES

The following conditions should apply to the use of CMV instead of RVR:

- (a) If the reported RVR is not available, a CMV may be substituted for the RVR, except:
 - (1) to satisfy take-off minima; or
 - (2) for the purpose of continuation of an approach in LVO.

- (b) If the minimum RVR for an approach is more than the maximum value assessed by the aerodrome operator, then CMV should be used.
- (c) In order to determine CMV from visibility:
 - (1) for flight planning purposes, a factor of 1.0 should be used;
 - (2) for purposes other than flight planning, the conversion factors specified in Table 14 should be used.

Table 14
Conversion of reported VIS to CMV

Light elements in operation	CMV = reported VIS x	
	Day	Night
HI approach and runway lights	1.5	2.0
Any type of light installation other than above	1.0	1.5
No lights	1.0	not applicable

AMC9 NCC.OP.110 Aerodrome operating minima — general

ED Decision 2022/014/R

EFFECT ON LANDING MINIMA OF TEMPORARILY FAILED OR DOWNGRADED GROUND EQUIPMENT

- (a) General

These instructions are intended for both pre-flight and in-flight use. It is, however, not expected that the pilot-in-command would consult such instructions after passing 1 000 ft above the aerodrome. If failures of ground aids are announced at such a late stage, the approach could be continued at the pilot-in-command's discretion. If failures are announced before such a late stage in the approach, their effect on the approach should be considered as described in Table 15 and, if considered necessary, the approach should be abandoned.

- (b) Conditions applicable to Table 15:
 - (1) multiple failures of runway/FATO lights other than those indicated in Table 15 should not be acceptable;
 - (2) failures of approach and runway/FATO lights are acceptable at the same time, and the most demanding consequence should be applied; and
 - (3) failures other than ILS, GLS, or MLS affect RVR only and not DH.

Table 15

Failed or downgraded equipment — effect on landing minima

Failed or downgraded equipment	Effect on landing minima	
	Type B	Type A
Navaid standby transmitter	No effect	
Outer marker (ILS only)	No effect if the required height or glide path can be checked using other means, e.g. DME fix	APV — not applicable
		NPA with FAF: no effect unless used as FAF
		If the FAF cannot be identified (e.g. no method available for timing of descent), NPA operations cannot be conducted
Middle marker (ILS only)	No effect	No effect unless used as MAPt
RVR Assessment Systems	No effect	
Approach lights	Minima as for NALS	
Approach lights except the last 210 m	Minima as for BALS	
Approach lights except the last 420 m	Minima as for IALS	
Standby power for approach lights	No effect	
Edge lights, threshold lights and runway end lights	Day — no effect	
	Night — not allowed	
Centre line lights	Aeroplanes: No effect if flight director (F/D), HUDLS or auto-land; otherwise, RVR 750 m	No effect
	Helicopters: No effect on CAT I and SA CAT I approach operations	
Centre line lights spacing increased to 30 m	No effect	
TDZ lights	Aeroplanes: No effect if F/D, HUDLS or auto-land; otherwise, RVR 750 m	No effect
	Helicopters: No effect	
Taxiway lighting system	No effect	

GM1 NCC.OP.110 Aerodrome operating minima — general

ED Decision 2022/012/R

AIRCRAFT CATEGORIES

- (a) Aircraft categories should be based on the indicated airspeed at threshold (V_{AT}), which is equal to the stalling speed (V_{SO}) multiplied by 1.3 or where published 1-g (gravity) stall speed (V_{S1g}) multiplied by 1.23 in the landing configuration at the maximum certified landing mass. If both V_{SO} and V_{S1g} are available, the higher resulting V_{AT} should be used.
- (b) The aircraft categories specified in the following table should be used.

Table 16

Aircraft categories corresponding to VAT values

Aircraft category	V _{AT}
A	Less than 91 kt
B	from 91 to 120 kt
C	from 121 to 140 kt
D	from 141 to 165 kt
E	from 166 to 210 kt

GM2 NCC.OP.110 Aerodrome operating minima – general

ED Decision 2013/021/R

CONTINUOUS DESCENT FINAL APPROACH (CDFA) — AEROPLANES

(a) Introduction

- (1) Controlled flight into terrain (CFIT) is a major hazard in aviation. Most CFIT accidents occur in the final approach segment of non-precision approaches; the use of stabilised-approach criteria on a continuous descent with a constant, predetermined vertical path is seen as a major improvement in safety during the conduct of such approaches. Operators should ensure that the following techniques are adopted as widely as possible, for all approaches.
- (2) The elimination of level flight segments at MDA close to the ground during approaches, and the avoidance of major changes in attitude and power/thrust close to the runway that can destabilise approaches, are seen as ways to reduce operational risks significantly.
- (3) The term CDFA has been selected to cover a flight technique for any type of NPA operation.
- (4) The advantages of CDFA are as follows:
 - (i) the technique enhances safe approach operations by the utilisation of standard operating practices;
 - (ii) the technique is similar to that used when flying an ILS approach, including when executing the missed approach and the associated missed approach procedure manoeuvre;
 - (iii) the aeroplane attitude may enable better acquisition of visual cues;
 - (iv) the technique may reduce pilot workload;
 - (v) the approach profile is fuel-efficient;
 - (vi) the approach profile affords reduced noise levels;
 - (vii) the technique affords procedural integration with APV operations; and
 - (viii) when used and the approach is flown in a stabilised manner, CDFA is the safest approach technique for all NPA operations.

(b) CDFA

- (1) Continuous descent final approach is defined in Annex I to the Regulation on Air Operations.

- (2) An approach is only suitable for application of a CDFA technique when it is flown along a nominal vertical profile; a nominal vertical profile is not forming part of the approach procedure design, but can be flown as a continuous descent. The nominal vertical profile information may be published or displayed on the approach chart to the pilot by depicting the nominal slope or range/distance vs. height. Approaches with a nominal vertical profile are considered to be:
- (i) NDB, NDB/DME (non-directional beacon/distance measuring equipment);
 - (ii) VOR (VHF omnidirectional radio range), VOR/DME;
 - (iii) LOC (localiser), LOC/DME;
 - (iv) VDF (VHF direction finder), SRA (surveillance radar approach); or
 - (v) GNSS/LNAV (global navigation satellite system/lateral navigation);
- (3) Stabilised approach (SAp) is defined in Annex I to the Regulation on Air Operations.
- (i) The control of the descent path is not the only consideration when using the CDFA technique. Control of the aeroplane's configuration and energy is also vital to the safe conduct of an approach.
 - (ii) The control of the flight path, described above as one of the requirements for conducting an SAp, should not be confused with the path requirements for using the CDFA technique. The predetermined path requirements for conducting an SAp are established by the operator and published in the operations manual part B.
 - (iii) The predetermined approach slope requirements for applying the CDFA technique are established by the following:
 - (A) the published 'nominal' slope information when the approach has a nominal vertical profile; and
 - (B) the designated final approach segment minimum of 3 NM, and maximum, when using timing techniques, of 8 NM.
 - (iv) An SAp will never have any level segment of flight at DA/H or MDA/H, as applicable. This enhances safety by mandating a prompt missed approach procedure manoeuvre at DA/H or MDA/H.
 - (v) An approach using the CDFA technique will always be flown as an SAp, since this is a requirement for applying CDFA. However, an SAp does not have to be flown using the CDFA technique, for example a visual approach.

GM3 NCC.OP.110 Aerodrome operating minima – general

ED Decision 2013/021/R

TAKE-OFF MINIMA — HELICOPTERS

To ensure sufficient control of the helicopter in IMC, the speed, before entering in IMC, should be above the minimum authorised speed in IMC, V_{mini} . This is a limitation in the AFM. Therefore, the lowest speed before entering in IMC is the highest of V_{toss} (take-off safety speed) and V_{mini} .

As example, V_{toss} is 45 kt and V_{mini} 60 kt. In that case, the take-off minima have to include the distance to accelerate to 60 kt. The take-off distance should be increased accordingly.

GM4 NCC.OP.110 Aerodrome operating minima — general

ED Decision 2022/012/R

APPROACH LIGHTING SYSTEMS — ICAO AND FAA SPECIFICATIONS

The following table provides a comparison of the ICAO and FAA specifications.

Table 17

Approach lighting systems — ICAO and FAA specifications

Class of lighting facility	Length, configuration and intensity of approach lights
FALS	ICAO: CAT I lighting system (HIALS \geq 720 m) distance coded centre line, barrette centre line FAA: ALSF1, ALSF2, SSALR, MALSR, high- or medium-intensity and/or flashing lights, 720 m or more
IALS	ICAO: simple approach lighting system (HIALS 420–719 m) single source, barrette FAA: MALSF, MALS, SALS/SALSF, SSALF, SSALS, high- or medium-intensity and/or flashing lights, 420–719 m
BALS	Any other approach lighting system (e.g. HIALS, MALS or ALS 210–419 m) FAA: ODALS, high- or medium-intensity or flashing lights 210–419 m
NALS	Any other approach lighting system (e.g. HIALS, MALS or ALS $<$ 210 m) or no approach lights

GM5 NCC.OP.110 Aerodrome operating minima — general

ED Decision 2022/012/R

SBAS OPERATIONS

- (a) SBAS LPV operations with a DH of 200 ft depend on an SBAS approved for operations down to a DH of 200 ft.
- (b) The following systems are in operational use or in a planning phase:
 - (1) European geostationary navigation overlay service (EGNOS), operational in Europe;
 - (2) wide area augmentation system (WAAS), operational in the USA;
 - (3) multi-functional satellite augmentation system (MSAS), operational in Japan;
 - (4) system of differential correction and monitoring (SDCM), planned by Russia;
 - (5) GPS-aided geo-augmented navigation (GAGAN) system, planned by India; and
 - (6) satellite navigation augmentation system (SNAS), planned by China.

GM6 NCC.OP.110 Aerodrome operating minima — general

ED Decision 2022/012/R

MEANS TO DETERMINE THE REQUIRED RVR BASED ON DH AND LIGHTING FACILITIES

The values in Table 8 are derived from the formula below:

$$\text{RVR (m)} = \left[\frac{\text{DH/MDH (ft)} \times 0.3048}{\tan \alpha} \right] - \text{length of approach lights (m)},$$

where α is the calculation angle, being a default value of 3.00° increasing in steps of 0.10° for each line in Table 8 up to 3.77° and then remaining constant. An upper RVR limit of 2 400 m has been applied to the table.

GM7 NCC.OP.110 Aerodrome operating minima — general

ED Decision 2022/012/R

USE OF DH FOR NPAs FLOWN USING THE CDFA TECHNIQUE

The safety of the use of MDH as DH in CDFA operations has been verified by at least two independent analyses concluding that a CDFA using MDH as DH without any add-on is safer than the traditional step-down and level flight NPA operation. A comparison was made between the safety level of using MDH as DH without an add-on with the well-established safety level resulting from the ILS collision risk model (CRM). The NPA used was the most demanding, i.e. most tightly designed NPA, which offers the least additional margins. It should be noted that the design limits of the ILS approach design, e.g. the maximum glide path (GP) angle of 3,5 degrees, must be observed for the CDFA in order to keep the validity of the comparison.

There is a wealth of operational experience in Europe confirming the above-mentioned analytical assessments. It cannot be expected that each operator is able to conduct similar safety assessments, and this is not necessary. The safety assessments already performed take into account the most demanding circumstances at hand, like the most tightly designed NPA procedures and other 'worst-case scenarios'. The assessments naturally focus on cases where the controlling obstacle is located in the missed approach area.

However, it is necessary for operators to assess whether their cockpit procedures and training are adequate to ensure minimal height loss in case of a go-around manoeuvre. Suitable topics for the safety assessment required by each operator may include:

- understanding of the CDFA concept including use of the MDA/H as DA/H;
- cockpit procedures that ensure flight on speed, on path and with proper configuration and energy management;
- cockpit procedures that ensure gradual decision-making; and
- identification of cases where an increase of the DA/H may be necessary because of non-standard circumstances, etc.

GM8 NCC.OP.110 Aerodrome operating minima — general

ED Decision 2022/014/R

INCREMENTS SPECIFIED BY THE COMPETENT AUTHORITY

Additional increments to the published minima may be specified by the competent authority to take into account certain operations, such as downwind approaches, single-pilot operations or approaches flown not using the CDFA technique.

GM9 NCC.OP.110 Aerodrome operating minima — general

ED Decision 2022/014/R

USE OF COMMERCIALY AVAILABLE INFORMATION

When an operator uses commercially available information to establish aerodrome operating minima, the operator remains responsible for ensuring that the material used is accurate and suitable for its operation, and that the aerodrome operating minima are calculated in accordance with the method specified in Part C of its operations manual.

The operator should apply the procedures in [ORO.GEN.205](#) 'Contracted activities'.

GM1 NCC.OP.110(b)(5) Aerodrome operating minima

ED Decision 2022/014/R

VISUAL AND NON-VISUAL AIDS AND INFRASTRUCTURE

‘Visual and non-visual aids and infrastructure’ refers to all equipment and facilities required for the procedure to be used for the intended instrument approach operation. This includes but is not limited to lights, markings, ground- or space-based radio aids, etc.

NCC.OP.112 Aerodrome operating minima — circling operations with aeroplanes

Regulation (EU) 2021/2237

- (a) The MDH for a circling approach operation with aeroplanes shall not be lower than the highest of:
 - (1) the published circling OCH for the aeroplane category;
 - (2) the minimum circling height derived from Table 1; or
 - (3) the DH/MDH of the preceding IAP.
- (b) The minimum visibility for a circling approach operation with aeroplanes shall be the highest of:
 - (1) the circling visibility for the aeroplane category, if published; or
 - (2) the minimum visibility derived from Table 1.

Table 1

MDH and minimum visibility for circling vs. aeroplane category

	Aeroplane category			
	A	B	C	D
MDH (ft)	400	500	600	700
Minimum VIS (m)	1500	1600	2400	3600

GM1 NCC.OP.112 Aerodrome operating minima — circling operations with aeroplanes

ED Decision 2022/012/R

SUPPLEMENTAL INFORMATION

- (a) The purpose of this guidance material is to provide operators with supplemental information regarding the application of aerodrome operating minima in relation to circling approaches.
- (b) Conduct of flight — general:
 - (1) the MDH and OCH included in the procedure are referenced to aerodrome elevation;
 - (2) the MDA is referenced to mean sea level;
 - (3) for these procedures, the applicable visibility is the VIS; and
 - (4) operators should provide tabular guidance of the relationship between height above threshold and the in-flight visibility required to obtain and sustain visual contact during the circling manoeuvre.

- (c) Instrument approach followed by visual manoeuvring (circling) without prescribed tracks
- (1) When the aeroplane is on the initial instrument approach, before visual reference is stabilised, but not below MDA/H — the aeroplane should follow the corresponding instrument approach procedure (IAP) until the appropriate instrument MAPt is reached.
 - (2) At the beginning of the level flight phase at or above the MDA/H, the instrument approach track should be maintained until the pilot:
 - (i) estimates that, in all probability, visual contact with the runway of intended landing or the runway environment will be maintained during the entire circling procedure;
 - (ii) estimates that the aeroplane is within the circling area before commencing circling; and
 - (iii) is able to determine the aeroplane's position in relation to the runway of intended landing with the aid of the appropriate visual references.
 - (3) If the pilot cannot comply with the conditions in (c)(2) at the MAPt, then a missed approach should be executed in accordance with the IAP.
 - (4) After the aeroplane has left the track of the initial instrument approach, the flight phase outbound from the runway should be limited to an appropriate distance, which is required to align the aeroplane onto the final approach. Such manoeuvres should be conducted to enable the aeroplane to:
 - (i) attain a controlled and stable descent path to the intended landing runway; and
 - (ii) remain within the circling area and in such a way that visual contact with the runway of intended landing or runway environment is maintained at all times.
 - (5) Flight manoeuvres should be carried out at an altitude/height that is not less than the circling MDA/H.
 - (6) Descent below the MDA/H should not be initiated until the threshold of the runway to be used has been appropriately identified. The aeroplane should be in a position to continue with a normal rate of descent and land within the TDZ.
- (d) Instrument approach followed by a visual manoeuvring (circling) with prescribed track
- (1) The aeroplane should remain on the initial IAP until one of the following is reached:
 - (i) the prescribed divergence point to commence circling on the prescribed track; or
 - (ii) the MAPt.
 - (2) The aeroplane should be established on the instrument approach track in level flight at or above the MDA/H at or by the circling manoeuvre divergence point.
 - (3) If the divergence point is reached before the required visual reference is acquired, a missed approach should be initiated not later than the MAPt and completed in accordance with the initial instrument approach procedure.
 - (4) When commencing the prescribed circling manoeuvre at the published divergence point, the subsequent manoeuvres should be conducted to comply with the published routing and published heights/altitudes.
 - (5) Unless otherwise specified, once the aeroplane is established on the prescribed track(s), the published visual reference does not need to be maintained unless:

- (i) required by the State of the aerodrome; or
 - (ii) the circling MAPt (if published) is reached.
 - (6) If the prescribed circling manoeuvre has a published MAPt and the required visual reference has not been obtained by that point, a missed approach should be executed in accordance with (e)(2) and (e)(3).
 - (7) Subsequent further descent below MDA/H should only commence when the required visual reference has been obtained.
 - (8) Unless otherwise specified in the procedure, final descent should not be commenced from MDA/H until the threshold of the intended landing runway has been identified and the aeroplane is in a position to continue with a normal rate of descent to land within the TDZ.
- (e) Missed approach
- (1) Missed approach during the instrument procedure prior to circling
 - (i) if the missed approach procedure is required to be flown when the aeroplane is positioned on the instrument approach track and before commencing the circling manoeuvre, the published missed approach for the instrument approach should be followed; or
 - (ii) if the IAP is carried out with the aid of an ILS, MLS or a stabilised approach (SAp), the MAPt associated with an ILS or an MLS procedure without glide path (GP-out procedure) or the SAp, where applicable, should be used.
 - (2) If a prescribed missed approach is published for the circling manoeuvre, this overrides the manoeuvres prescribed below.
 - (3) If visual reference is lost while circling to land after the aeroplane has departed from the initial instrument approach track, the missed approach specified for that particular instrument approach should be followed. It is expected that the pilot will make an initial climbing turn toward the intended landing runway to a position overhead of the aerodrome where the pilot will establish the aeroplane in a climb on the instrument missed approach segment.
 - (4) The aeroplane should not leave the visual manoeuvring (circling) area, which is obstacle protected, unless:
 - (i) established on the appropriate missed approach procedure; or
 - (ii) at minimum sector altitude (MSA).
 - (5) All turns should be made in the same direction and the aeroplane should remain within the circling protected area while climbing either:
 - (i) to the altitude assigned to any published circling missed approach manoeuvre if applicable;
 - (ii) to the altitude assigned to the missed approach of the initial instrument approach;
 - (iii) to the MSA;
 - (iv) to the minimum holding altitude (MHA) applicable for transition to a holding facility or fix, or continue to climb to an MSA; or
 - (v) as directed by ATS.

When the missed approach procedure is commenced on the 'downwind' leg of the circling manoeuvre, an 'S' turn may be undertaken to align the aeroplane on the initial instrument approach missed approach path, provided the aeroplane remains within the protected circling area.

The pilot-in-command should be responsible for ensuring adequate terrain clearance during the above-stipulated manoeuvres, particularly during the execution of a missed approach initiated by ATS.

- (6) Because the circling manoeuvre may be accomplished in more than one direction, different patterns will be required to establish the aeroplane on the prescribed missed approach course depending on its position at the time visual reference is lost. In particular, all turns are to be in the prescribed direction if this is restricted, e.g. to the west/east (left or right hand) to remain within the protected circling area.
- (7) If a missed approach procedure is published for a particular runway onto which the aeroplane is conducting a circling approach and the aeroplane has commenced a manoeuvre to align with the runway, the missed approach for this direction may be accomplished. The ATS unit should be informed of the intention to fly the published missed approach procedure for that particular runway.
- (8) The pilot-in-command should advise ATS when any missed approach procedure has been commenced, the height/altitude the aeroplane is climbing to and the position the aeroplane is proceeding towards and/or heading the aeroplane is established on.

NCC.OP.113 Aerodrome operating minima – onshore circling operations with helicopters

Regulation (EU) No 800/2013

The MDH for an onshore circling operation with helicopters shall not be lower than 250 ft and the meteorological visibility not less than 800 m.

NCC.OP.115 Departure and approach procedures

Regulation (EU) No 800/2013

- (a) The pilot-in-command shall use the departure and approach procedures established by the State of the aerodrome, if such procedures have been published for the runway or FATO to be used.
- (b) Notwithstanding (a), the pilot-in-command shall only accept an ATC clearance to deviate from a published procedure:
 - (1) provided that obstacle clearance criteria are observed and full account is taken of the operating conditions; or
 - (2) when being radar-vectorred by an ATC unit.
- (c) In any case, the final approach segment shall be flown visually or in accordance with the published approach procedures.

AMC1 NCC.OP.115 Departure and approach procedures

ED Decision 2022/012/R

APPROACH FLIGHT TECHNIQUE — AEROPLANES

- (a) All approach operations should be flown as SAp operations.
- (b) The CDFA technique should be used for NPA procedures.

NCC.OP.116 Performance-based navigation — aeroplanes and helicopters

Regulation (EU) 2016/1199

The operator shall ensure that, when PBN is required for the route or procedure to be flown:

- (a) the relevant PBN specification is stated in the AFM or other document that has been approved by the certifying authority as part of an airworthiness assessment or is based on such approval; and
- (b) the aircraft is operated in conformance with the relevant navigation specification and limitations in the AFM or other document mentioned above.

AMC1 NCC.OP.116 Performance-based navigation — aeroplanes and helicopters

ED Decision 2016/017/R

PBN OPERATIONS

For operations where a navigation specification for performance-based navigation (PBN) has been prescribed and no specific approval is required in accordance with [SPA.PBN.100](#), the operator should:

- (a) establish operating procedures specifying:
 - (1) normal, abnormal and contingency procedures;
 - (2) electronic navigation database management; and
 - (3) relevant entries in the minimum equipment list (MEL);
- (b) specify the flight crew qualification and proficiency constraints and ensure that the training programme for relevant personnel is consistent with the intended operation; and
- (c) ensure continued airworthiness of the area navigation system.

AMC2 NCC.OP.116 Performance-based navigation — aeroplanes and helicopters

ED Decision 2022/012/R

MONITORING AND VERIFICATION

- (a) Preflight and general considerations
 - (1) At navigation system initialisation, the flight crew should confirm that the navigation database is current and verify that the aircraft position has been entered correctly, if required.
 - (2) The active flight plan, if applicable, should be checked by comparing the charts or other applicable documents with navigation equipment and displays. This includes

confirmation of the departing runway and the waypoint sequence, reasonableness of track angles and distances, any altitude or speed constraints, and, where possible, which waypoints are fly-by and which are fly-over. Where relevant, the RF leg arc radii should be confirmed.

- (3) The flight crew should check that the navigation aids critical to the operation of the intended PBN procedure are available.
 - (4) The flight crew should confirm the navigation aids that should be excluded from the operation, if any.
 - (5) An arrival, approach or departure procedure should not be used if the validity of the procedure in the navigation database has expired.
 - (6) The flight crew should verify that the navigation systems required for the intended operation are operational.
- (b) Departure
- (1) Prior to commencing a take-off on a PBN procedure, the flight crew should check that the indicated aircraft position is consistent with the actual aircraft position at the start of the take-off roll (aeroplanes) or lift-off (helicopters).
 - (2) Where GNSS is used, the signal should be acquired before the take-off roll (aeroplanes) or lift-off (helicopters) commences.
 - (3) Unless automatic updating of the actual departure point is provided, the flight crew should ensure initialisation on the runway or FATO by means of a manual runway threshold or intersection update, as applicable. This is to preclude any inappropriate or inadvertent position shift after take-off.
- (c) Arrival and approach
- (1) The flight crew should verify that the navigation system is operating correctly and the correct arrival procedure and runway (including any applicable transition) are entered and properly depicted.
 - (2) Any published altitude and speed constraints should be observed.
 - (3) The flight crew should check approach procedures (including alternate aerodromes if needed) as extracted by the system (e.g. CDU flight plan page) or presented graphically on the moving map, in order to confirm the correct loading and the reasonableness of the procedure content.
 - (4) Prior to commencing the approach operation (before the IAF), the flight crew should verify the correctness of the loaded procedure by comparison with the appropriate approach charts. This check should include:
 - (i) the waypoint sequence;
 - (ii) reasonableness of the tracks and distances of the approach legs and the accuracy of the inbound course; and
 - (iii) the vertical path angle, if applicable.
- (d) Altimetry settings for RNP APCH operations using Baro VNAV
- (1) Barometric settings

- (i) The flight crew should set and confirm the correct altimeter setting and check that the two altimeters provide altitude values that do not differ more than 100 ft at the most at or before the FAF.
- (ii) The flight crew should fly the procedure with:
 - (A) a current local altimeter setting source available — a remote or regional altimeter setting source should not be used; and
 - (B) the QNH/QFE, as appropriate, set on the aircraft's altimeters.
- (2) Temperature compensation
 - (i) For RNP APCH operations to LNAV/VNAV minima using Baro VNAV:
 - (A) the flight crew should not commence the approach when the aerodrome temperature is outside the promulgated aerodrome temperature limits for the procedure unless the area navigation system is equipped with approved temperature compensation for the final approach;
 - (B) when the temperature is within promulgated limits, the flight crew should not make compensation to the altitude at the FAF;
 - (C) since only the final approach segment is protected by the promulgated aerodrome temperature limits, the flight crew should consider the effect of temperature on terrain and obstacle clearance in other phases of flight.
 - (ii) For RNP APCH operations to LNAV minima, the flight crew should consider the effect of temperature on terrain and obstacle clearance in all phases of flight, in particular on any step-down fix.
- (e) Sensor and lateral navigation accuracy selection
 - (1) For multi-sensor systems, the flight crew should verify, prior to approach, that the GNSS sensor is used for position computation.
 - (2) Flight crew of aircraft with RNP input selection capability should confirm that the indicated RNP value is appropriate for the PBN operation.

AMC3 NCC.OP.116 Performance-based navigation – aeroplanes and helicopters

ED Decision 2016/017/R

MANAGEMENT OF THE NAVIGATION DATABASE

- (a) For RNAV 1, RNAV 2, RNP 1, RNP 2, and RNP APCH, the flight crew should neither insert nor modify waypoints by manual entry into a procedure (departure, arrival or approach) that has been retrieved from the database. User-defined data may be entered and used for waypoint altitude/speed constraints on a procedure where said constraints are not included in the navigation database coding.
- (b) For RNP 4 operations, the flight crew should not modify waypoints that have been retrieved from the database. User-defined data (e.g. for flex-track routes) may be entered and used.
- (c) The lateral and vertical definition of the flight path between the FAF and the missed approach point (MAPt) retrieved from the database should not be revised by the flight crew.

AMC4 NCC.OP.116 Performance-based navigation – aeroplanes and helicopters

ED Decision 2016/017/R

DISPLAYS AND AUTOMATION

- (a) For RNAV 1, RNP 1, and RNP APCH operations, the flight crew should use a lateral deviation indicator, and where available, flight director and/or autopilot in lateral navigation mode.
- (b) The appropriate displays should be selected so that the following information can be monitored:
 - (1) the computed desired path;
 - (2) aircraft position relative to the lateral path (cross-track deviation) for FTE monitoring;
 - (3) aircraft position relative to the vertical path (for a 3D operation).
- (c) The flight crew of an aircraft with a lateral deviation indicator (e.g. CDI) should ensure that lateral deviation indicator scaling (full-scale deflection) is suitable for the navigation accuracy associated with the various segments of the procedure.
- (d) The flight crew should maintain procedure centrelines unless authorised to deviate by ATC or demanded by emergency conditions.
- (e) Cross-track error/deviation (the difference between the area-navigation-system-computed path and the aircraft-computed position) should normally be limited to $\pm \frac{1}{2}$ time the RNAV/RNP value associated with the procedure. Brief deviations from this standard (e.g. overshoots or undershoots during and immediately after turns) up to a maximum of 1 time the RNAV/RNP value should be allowable.
- (f) For a 3D approach operation, the flight crew should use a vertical deviation indicator and, where required by AFM limitations, a flight director or autopilot in vertical navigation mode.
- (g) Deviations below the vertical path should not exceed 75 ft at any time, or half-scale deflection where angular deviation is indicated, and not more than 75 ft above the vertical profile, or half-scale deflection where angular deviation is indicated, at or below 1 000 ft above aerodrome level. The flight crew should execute a missed approach if the vertical deviation exceeds this criterion, unless the flight crew has in sight the visual references required to continue the approach.

AMC5 NCC.OP.116 Performance-based navigation – aeroplanes and helicopters

ED Decision 2016/017/R

VECTORIZING AND POSITIONING

- (a) ATC tactical interventions in the terminal area may include radar headings, 'direct to' clearances which bypass the initial legs of an approach procedure, interceptions of an initial or intermediate segments of an approach procedure or the insertion of additional waypoints loaded from the database.
- (b) In complying with ATC instructions, the flight crew should be aware of the implications for the navigation system.
- (c) 'Direct to' clearances may be accepted to the IF provided that it is clear to the flight crew that the aircraft will be established on the final approach track at least 2 NM before the FAF.

- (d) 'Direct to' clearance to the FAF should not be acceptable. Modifying the procedure to intercept the final approach track prior to the FAF should be acceptable for radar-vector arrivals or otherwise only with ATC approval.
- (e) The final approach trajectory should be intercepted no later than the FAF in order for the aircraft to be correctly established on the final approach track before starting the descent (to ensure terrain and obstacle clearance).
- (f) 'Direct to' clearances to a fix that immediately precede an RF leg should not be permitted.
- (g) For parallel offset operations en route in RNP 4 and A-RNP, transitions to and from the offset track should maintain an intercept angle of no more than 45° unless specified otherwise by ATC.

AMC6 NCC.OP.116 Performance-based navigation – aeroplanes and helicopters

ED Decision 2016/017/R

ALERTING AND ABORT

- (a) Unless the flight crew has sufficient visual reference to continue the approach operation to a safe landing, an RNP APCH operation should be discontinued if:
 - (1) navigation system failure is annunciated (e.g. warning flag);
 - (2) lateral or vertical deviations exceed the tolerances;
 - (3) loss of the on-board monitoring and alerting system.
- (b) Discontinuing the approach operation may not be necessary for a multi-sensor navigation system that includes demonstrated RNP capability without GNSS in accordance with the AFM.
- (c) Where vertical guidance is lost while the aircraft is still above 1 000 ft AGL, the flight crew may decide to continue the approach to LNAV minima, when supported by the navigation system.

AMC7 NCC.OP.116 Performance-based navigation – aeroplanes and helicopters

ED Decision 2016/017/R

CONTINGENCY PROCEDURES

- (a) The flight crew should make the necessary preparation to revert to a conventional arrival procedure where appropriate. The following conditions should be considered:
 - (1) failure of the navigation system components including navigation sensors, and a failure effecting flight technical error (e.g. failures of the flight director or autopilot);
 - (2) multiple system failures affecting aircraft performance;
 - (3) coasting on inertial sensors beyond a specified time limit; and
 - (4) RAIM (or equivalent) alert or loss of integrity function.
- (b) In the event of loss of PBN capability, the flight crew should invoke contingency procedures and navigate using an alternative means of navigation.
- (c) The flight crew should notify ATC of any problem with PBN capability.
- (d) In the event of communication failure, the flight crew should continue with the operation in accordance with published lost communication procedures.

AMC8 NCC.OP.116 Performance-based navigation – aeroplanes and helicopters

ED Decision 2016/017/R

RNAV 10

- (a) Operating procedures and routes should take account of the RNAV 10 time limit declared for the inertial system, if applicable, considering also the effect of weather conditions that could affect flight duration in RNAV 10 airspace.
- (b) The operator may extend RNAV 10 inertial navigation time by position updating. The operator should calculate, using statistically-based typical wind scenarios for each planned route, points at which updates can be made, and the points at which further updates will not be possible.

GM1 NCC.OP.116 Performance-based navigation – aeroplanes and helicopters

ED Decision 2016/017/R

DESCRIPTION

- (a) For both, RNP X and RNAV X designations, the 'X' (where stated) refers to the lateral navigation accuracy (total system error) in NM, which is expected to be achieved at least 95 % of the flight time by the population of aircraft operating within the airspace, route or procedure. For RNP APCH and A-RNP, the lateral navigation accuracy depends on the segment.
- (b) PBN may be required on notified routes, for notified procedures and in notified airspace.

RNAV 10

- (c) For purposes of consistency with the PBN concept, this Regulation is using the designation 'RNAV 10' because this specification does not include on-board performance monitoring and alerting.
- (d) However, it should be noted that many routes still use the designation 'RNP 10' instead of 'RNAV 10'. 'RNP 10' was used as designation before the publication of the fourth edition of ICAO Doc 9613 in 2013. The terms 'RNP 10' and 'RNAV 10' should be considered equivalent.

NCC.OP.120 Noise abatement procedures

Regulation (EU) No 800/2013

The operator shall develop operating procedures taking into account the need to minimise the effect of aircraft noise while ensuring that safety has priority over noise abatement.

AMC1 NCC.OP.120 Noise abatement procedures

ED Decision 2013/021/R

NADP DESIGN

- (a) For each aeroplane type two departure procedures should be defined, in accordance with ICAO Doc. 8168 (Procedures for Air Navigation Services, 'PANS-OPS'), Volume I:
 - (1) noise abatement departure procedure one (NADP 1), designed to meet the close-in noise abatement objective; and
 - (2) noise abatement departure procedure two (NADP 2), designed to meet the distant noise abatement objective.

- (b) For each type of NADP (1 and 2), a single climb profile should be specified for use at all aerodromes, which is associated with a single sequence of actions. The NADP 1 and NADP 2 profiles may be identical.

GM1 NCC.OP.120 Noise abatement procedures

ED Decision 2013/021/R

TERMINOLOGY

- (a) 'Climb profile' means in this context the vertical path of the NADP as it results from the pilot's actions (engine power reduction, acceleration, slats/flaps retraction).
- (b) 'Sequence of actions' means the order in which these pilot's actions are done and their timing.

GENERAL

- (c) The rule addresses only the vertical profile of the departure procedure. Lateral track has to comply with the standard instrument departure (SID).

EXAMPLE

- (d) For a given aeroplane type, when establishing the distant NADP, the operator should choose either to reduce power first and then accelerate, or to accelerate first and then wait until slats/flaps are retracted before reducing power. The two methods constitute two different sequences of actions.
- (e) For an aeroplane type, each of the two departure climb profiles may be defined by one sequence of actions (one for close-in, one for distant) and two above aerodrome level (AAL) altitudes/heights. These are:
- (1) the altitude of the first pilot's action (generally power reduction with or without acceleration). This altitude should not be less than 800 ft AAL; or
 - (2) the altitude of the end of the noise abatement procedure. This altitude should usually not be more than 3 000 ft AAL.

These two altitudes may be runway specific when the aeroplane flight management system (FMS) has the relevant function that permits the crew to change thrust reduction and/or acceleration altitude/height. If the aeroplane is not FMS equipped or the FMS is not fitted with the relevant function, two fixed heights should be defined and used for each of the two NADPs.

NCC.OP.125 Minimum obstacle clearance altitudes – IFR flights

Regulation (EU) No 800/2013

- (a) The operator shall specify a method to establish minimum flight altitudes that provide the required terrain clearance for all route segments to be flown in IFR.
- (b) The pilot-in-command shall establish minimum flight altitudes for each flight based on this method. The minimum flight altitudes shall not be lower than that published by the State overflown.

AMC1 NCC.OP.125 Minimum obstacle clearance altitudes – IFR flights

ED Decision 2013/021/R

GENERAL

Commercially available information specifying minimum obstacle clearance altitudes may be used.

NCC.OP.130 Fuel/energy scheme – aeroplanes and helicopters

Regulation (EU) 2021/1296

- (a) The operator shall establish, implement, and maintain a fuel/energy scheme that comprises:
 - (1) a fuel/energy planning and in-flight re-planning policy; and
 - (2) an in-flight fuel/energy management policy.
- (b) The fuel/energy scheme shall:
 - (1) be appropriate for the type(s) of operation performed; and
 - (2) correspond to the capability of the operator to support its implementation.

NCC.OP.131 Fuel/energy scheme – fuel/energy planning and in flight re-planning policy – aeroplanes and helicopters

Regulation (EU) 2021/1296

- (a) As part of the fuel/energy scheme, the operator shall establish a fuel/energy planning and in-flight re-planning policy to ensure that the aircraft carries a sufficient amount of usable fuel/energy to safely complete the planned flight and to allow for deviations from the planned operation.
- (b) The operator shall ensure that the fuel/energy planning of flights is based upon at least the following elements:
 - (1) procedures contained in the operations manual as well as:
 - (i) current aircraft-specific data derived from a fuel/energy consumption monitoring system, or, if not available;
 - (ii) data provided by the aircraft manufacturer; and
 - (2) the operating conditions under which the flight is to be conducted including:
 - (i) aircraft fuel/energy consumption data;
 - (ii) anticipated masses;
 - (iii) anticipated meteorological conditions;
 - (iv) the effects of deferred maintenance items or configuration deviations, or both; and
 - (v) anticipated delays.
- (c) For aeroplanes, the operator shall ensure that the pre-flight calculation of the usable fuel/energy that is required for a flight includes:
 - (1) taxi fuel/energy that shall not be less than the amount expected to be used prior to take-off;

- (2) trip fuel/energy that shall be the amount of fuel/energy that is required to enable the aeroplane to fly from take-off, or from the point of in-flight re-planning, to landing at the destination aerodrome;
 - (3) contingency fuel/energy that shall be the amount of fuel/energy required to compensate for unforeseen factors;
 - (4) destination alternate fuel/energy:
 - (i) when a flight is operated with at least one destination alternate aerodrome, it shall be the amount of fuel/energy required to fly from the destination aerodrome to the destination alternate aerodrome; or
 - (ii) when a flight is operated with no destination alternate aerodrome, it shall be the amount of fuel/energy required to hold at the destination aerodrome to compensate for the lack of a destination alternate aerodrome;
 - (5) final reserve fuel/energy that shall be the amount of fuel/energy that is calculated at holding speed at 1 500ft (450 m) above the aerodrome elevation in standard conditions according to the aircraft estimated mass on arrival at the destination alternate aerodrome, or destination aerodrome when no destination alternate aerodrome is required, and shall not be less than:
 - (i) for aeroplanes with reciprocating engines on visual flight rules (VFR) flights by night and instrument flight rules (IFR) flights, the fuel/energy to fly for 45 minutes; or
 - (ii) for aeroplanes with reciprocating engines on VFR flights by day, the fuel/energy to fly for 30 minutes;
 - (iii) for turbine-engined aeroplanes, the fuel/energy to fly for 30 minutes;
 - (6) additional fuel/energy, if required by the type of operation; it shall be the amount of fuel/energy to enable the aeroplane to perform a safe landing at a fuel/energy en route alternate aerodrome (fuel/energy ERA aerodrome critical scenario) in the event of an engine failure or loss of pressurisation, whichever requires the greater amount of fuel/energy, based on the assumption that such a failure occurs at the most critical point along the route; this additional fuel/energy is required only if the minimum amount of fuel/energy that is calculated according to points (c)(2) to (c)(5) is not sufficient for such an event;
 - (7) extra fuel/energy to take into account anticipated delays or specific operational constraints; and
 - (8) discretionary fuel/energy, if required by the commander.
- (d) For helicopters, the operator shall ensure that the pre-flight calculation of the usable fuel/energy that is required for a flight includes all of the following:
- (1) fuel/energy to fly to the aerodrome or operating site of intended landing;
 - (2) if a destination alternate is required, destination alternate fuel/energy, which shall be the amount of fuel/energy that is required to execute a missed approach at the aerodrome or operating site of intended landing, and thereafter, to fly to the specified destination alternate, approach and land; and
 - (3) final reserve fuel/energy, which shall not be less than:
 - (i) for flights under VFR, fuel/energy to fly for at least 20 minutes at best-range speed; or

- (ii) for IFR flights, fuel/energy to fly for at least 30 minutes at holding speed at 450 m (1 500 ft) above the aerodrome or operating site of intended landing or destination alternate in standard temperature conditions.
- (e) The operator shall ensure that if a flight has to proceed to a destination aerodrome other than the one originally planned, in-flight re-planning procedures for calculating the required usable fuel/energy are available and comply with points (c)(2) to (c)(7) for aeroplanes, and point (d) for helicopters.
- (f) The pilot in command shall only commence a flight or continue in the event of in-flight re-planning, when satisfied that the aircraft carries at least the planned amount of usable fuel/energy and oil to safely complete the flight.

AMC1 NCC.OP.131 Fuel/energy scheme — fuel/energy planning and in-flight re-planning policy — aeroplanes and helicopters

ED Decision 2022/005/R

FUEL PLANNING POLICY

For the fuel planning policy, the amount of the required usable fuel for a flight should not be less than the sum of the following:

- (a) taxi fuel that should take into account the local conditions at the departure aerodrome and the APU consumption;
- (b) trip fuel that should include:
 - (1) fuel for take-off and climb from the aerodrome elevation to the initial cruising level/altitude, taking into account the expected departure routing;
 - (2) fuel from the top of climb to the top of descent, including any step climb/descent;
 - (3) fuel from the top of descent to the point where the approach procedure is initiated, taking into account the expected arrival routing; and
 - (4) fuel for making an approach and landing at the destination aerodrome;
- (c) contingency fuel that should be:
 - (1) 5 % of the planned trip fuel or, in the event of in-flight re-planning, 5 % of the trip fuel for the remainder of the flight; or
 - (2) an amount to fly for 5 minutes at holding speed at 1 500 ft (450 m) above the destination aerodrome in standard conditions,whichever is higher;
- (d) destination alternate fuel that should be:
 - (1) when the aircraft is operated with one destination alternate aerodrome:
 - (i) fuel for a missed approach from the applicable DA/H or MDA/H at the destination aerodrome to the missed-approach altitude, taking into account the complete missed-approach procedure;
 - (ii) fuel for climb from the missed-approach altitude to the cruising level/altitude, taking into account the expected departure routing;
 - (iii) fuel for cruising from the top of climb to the top of descent, taking into account the expected routing;

- (iv) fuel for descent from the top of descent to the point where the approach is initiated, taking into account the expected arrival routing; and
- (v) fuel for making an approach and landing at the destination alternate aerodrome;
- (2) when the aircraft is operated with no destination alternate aerodrome, the amount of fuel to hold for 15 minutes at 1 500 ft (450 m) in standard conditions above the destination aerodrome elevation;
- (3) when the aerodrome of intended landing is an isolated aerodrome:
 - (i) for aeroplanes with reciprocating engines, the amount of fuel required to fly either for 45 minutes plus 15 % of the flight time planned for cruising, including the final reserve fuel (FRF), or for 2 hours, whichever is less; or
 - (ii) for turbine-engined aeroplanes, the amount of fuel required to fly for 2 hours with normal cruise consumption above the destination aerodrome, including the FRF.
- (e) FRF;
- (f) additional fuel that should be the amount of fuel that allows the aircraft to proceed, in the event of an engine failure or loss of pressurisation, from the most critical point along the route to a fuel en route alternate (fuel ERA) aerodrome in the relevant aeroplane configuration, hold there for 15 minutes at 1 500 ft (450 m) above the aerodrome elevation in standard conditions, make an approach, and land;
- (g) extra fuel if there are anticipated delays or specific operational constraints; and
- (h) discretionary fuel, if required by the pilot-in-command.

NCC.OP.135 Stowage of baggage and cargo

Regulation (EU) No 800/2013

The operator shall establish procedures to ensure that:

- (a) only hand baggage that can be adequately and securely stowed is taken into the passenger compartment; and
- (b) all baggage and cargo on board that might cause injury or damage, or obstruct aisles and exits if displaced, is stowed so as to prevent movement.

NCC.OP.140 Passenger briefing

Regulation (EU) No 800/2013

The pilot-in-command shall ensure that:

- (a) prior to take-off passengers have been made familiar with the location and use of the following:
 - (1) seat belts;
 - (2) emergency exits; and
 - (3) passenger emergency briefing cards;and if applicable:
 - (4) life-jackets;
 - (5) oxygen dispensing equipment;
 - (6) life-rafts; and

- (7) other emergency equipment provided for individual passenger use;
- and
- (b) in an emergency during flight, passengers are instructed in such emergency action as may be appropriate to the circumstances.

AMC1 NCC.OP.140 Passenger briefing

ED Decision 2013/021/R

TRAINING PROGRAMME

- (a) The operator may replace the briefing/demonstration with a passenger training programme covering all safety and emergency procedures for a given type of aircraft.
- (b) Only passengers who have been trained according to this programme and have flown on the aircraft type within the last 90 days may be carried on board without receiving a briefing/demonstration.

NCC.OP.145 Flight preparation

Regulation (EU) 2021/2237

- (a) Before commencing a flight, the pilot-in-command shall ascertain by every reasonable means available that the space-based facilities, ground and/or water facilities, including communication facilities and navigation aids available and directly required on such flight, for the safe operation of the aircraft, are adequate for the type of operation under which the flight is to be conducted.
- (b) Before commencing a flight, the pilot-in-command shall be familiar with all available meteorological information appropriate to the intended flight. Preparation for a flight away from the vicinity of the place of departure, and for every flight under IFR, shall include:
 - (1) a study of the available current meteorological reports and forecasts; and
 - (2) the planning of an alternative course of action to provide for the eventuality that the flight cannot be completed as planned, because of meteorological conditions.

GM1 NCC.OP.145(b) Flight preparation

ED Decision 2013/021/R

OPERATIONAL FLIGHT PLAN

- (a) Dependent on the length and complexity of the planned flight, an operational flight plan may be completed based on considerations of aircraft performance, other operating limitations and relevant expected conditions on the route to be followed and at the aerodromes/operating sites concerned.
- (b) The operational flight plan used and the entries made during flight may contain the following items:
 - (1) aircraft registration;
 - (2) aircraft type and variant;
 - (3) date of flight;
 - (4) flight identification;

- (5) names of flight crew members;
- (6) duty assignment of flight crew members;
- (7) place of departure;
- (8) time of departure (actual off-block time, take-off time);
- (9) place of arrival (planned and actual);
- (10) time of arrival (actual landing and on-block time);
- (11) type of operation (VFR, ferry flight, etc.);
- (12) route and route segments with checkpoints/waypoints, distances, time and tracks;
- (13) planned cruising speed and flying times between check-points/waypoints (estimated and actual times overhead);
- (14) safe altitudes and minimum levels;
- (15) planned altitudes and flight levels;
- (16) fuel calculations (records of in-flight fuel checks);
- (17) fuel on board when starting engines;
- (18) alternate(s) for destination and, where applicable, take-off and en-route;
- (19) initial ATS flight plan clearance and subsequent reclearance;
- (20) in-flight replanning calculations; and
- (21) relevant meteorological information.

NCC.OP.147 Destination alternate aerodromes planning minima — aeroplanes

Regulation (EU) 2021/2237

An aerodrome shall not be specified as a destination alternate aerodrome unless the available current meteorological information indicates, for the period from 1 hour before until 1 hour after the estimated time of arrival, or from the actual time of departure to 1 hour after the estimated time of arrival, whichever is the shorter period,

- (a) for an alternate aerodrome with an available instrument approach operation with DH less than 250 ft,
 - (1) a ceiling of at least 200 ft above the DH or MDH associated with the instrument approach operation; and
 - (2) a visibility of at least the higher of 1 500 m and 800 m above the instrument approach operation RVR/VIS minima; or
- (b) for an alternate aerodrome with an instrument approach operation with DH or MDH 250 ft or more,
 - (1) a ceiling of at least 400 ft above the DH or MDH associated with the instrument approach operation; and
 - (2) a visibility of at least 3 000 m; or

- (c) for an alternate aerodrome without an instrument approach procedure,
 - (1) a ceiling of at least the higher of 2 000 ft and the minimum safe IFR height; and
 - (2) a visibility of at least 5 000 m.

NCC.OP.148 Destination alternate aerodrome planning minima — helicopters

Regulation (EU) 2021/2237

The operator shall only select an aerodrome as a destination alternate aerodrome if the available current meteorological information indicates, for the period from 1 hour before until 1 hour after the estimated time of arrival, or from the actual time of departure to 1 hour after the estimated time of arrival, whichever is the shorter period;

- (a) for an alternate aerodrome with an instrument approach procedure (IAP):
 - (1) a ceiling of at least 200 ft above the DH or MDH associated with the IAP; and
 - (2) a visibility of at least 1 500 m by day or 3 000 m by night; or
- (b) for an alternate aerodrome without an IAP:
 - (1) a ceiling of at least 2 000 ft or the minimum safe IFR height — whichever is greater; and
 - (2) a visibility of at least 1 500 m by day or 3 000 m by night.

NCC.OP.150 Take-off alternate aerodromes — aeroplanes

Regulation (EU) 2021/2237

- (a) For IFR flights, the pilot-in-command shall specify at least one weather-permissible take-off alternate aerodrome in the flight plan if the meteorological conditions at the aerodrome of departure are at or below the applicable aerodrome operating minima or if it would not be possible to return to the aerodrome of departure for other reasons.
- (b) The take-off alternate aerodrome shall be located within the following distance from the aerodrome of departure:
 - (1) for aeroplanes having two engines, not more than a distance equivalent to a flight time of 1 hour at the single-engine cruise speed in still air standard conditions; and
 - (2) for aeroplanes having three or more engines, not more than a distance equivalent to a flight time of 2 hours at the one-engine-inoperative (OEI) cruise speed according to the AFM in still air standard conditions.
- (c) For an aerodrome to be selected as a take-off alternate aerodrome the available information shall indicate that, at the estimated time of use, the conditions will be at or above the aerodrome operating minima for that operation.

NCC.OP.151 Destination alternate aerodromes – aeroplanes

Regulation (EU) 2021/2237

For IFR flights, the pilot-in-command shall specify at least one weather-permissible destination alternate aerodrome in the flight plan, unless:

- (a) the available current meteorological information indicates that, for the period from 1 hour before until 1 hour after the estimated time of arrival, or from the actual time of departure to

- 1 hour after the estimated time of arrival, whichever is the shorter period, the approach and landing may be made under visual meteorological conditions (VMC); or
- (b) the place of intended landing is designated as an isolated aerodrome and:
- (1) an instrument approach procedure is prescribed for the aerodrome of intended landing; and
 - (2) available current meteorological information indicates that the following meteorological conditions will exist from 2 hours before to 2 hours after the estimated time of arrival:
 - (i) a cloud base of at least 300 m (1 000 ft) above the minimum associated with the instrument approach procedure; and
 - (ii) visibility of at least 5,5 km or of 4 km more than the minimum associated with the procedure.

NCC.OP.152 Destination alternate aerodromes – helicopters

Regulation (EU) 2016/1199

For IFR flights, the pilot-in-command shall specify at least one weather-permissible destination alternate in the flight plan, unless:

- (a) an instrument approach procedure is prescribed for the aerodrome of intended landing and the available current meteorological information indicates that the following meteorological conditions will exist from 2 hours before to 2 hours after the estimated time of arrival, or from the actual time of departure to 2 hours after the estimated time of arrival, whichever is the shorter period:
- (1) a cloud base of at least 120 m (400 ft) above the minimum associated with the instrument approach procedure; and
 - (2) visibility of at least 1 500 m more than the minimum associated with the procedure; or
- (b) the place of intended landing is isolated and:
- (1) an instrument approach procedure is prescribed for the aerodrome of intended landing;
 - (2) available current meteorological information indicates that the following meteorological conditions will exist from 2 hours before to 2 hours after the estimated time of arrival:
 - (i) the cloud base is at least 120 m (400 ft) above the minimum associated with the instrument approach procedure;
 - (ii) visibility is at least 1 500 m more than the minimum associated with the procedure.

NCC.OP.153 Destination aerodromes – instrument approach operations

Regulation (EU) 2016/1199

The pilot-in-command shall ensure that sufficient means are available to navigate and land at the destination aerodrome or at any destination alternate aerodrome in the case of loss of capability for the intended approach and landing operation.

AMC1 NCC.OP.153 Destination aerodromes — instrument approach operations

ED Decision 2022/012/R

PBN OPERATIONS

- (a) When the operator intends to use PBN, the operator should either:
- (1) demonstrate that the GNSS is robust against loss of capability; or
 - (2) select an aerodrome as a destination alternate aerodrome only if an IAP that does not rely on a GNSS is available either at that aerodrome or at the destination aerodrome.

GNSS ROBUSTNESS AGAINST LOSS OF CAPABILITY — HELICOPTERS

- (b) The operator may demonstrate robustness against the loss of capability of the GNSS if all of the following criteria are met:
- (1) SBAS or GBAS are available and used.
 - (2) The failure of a single receiver or system should not compromise the navigation capability required for the intended instrument approach.
 - (3) The temporary jamming of all GNSS frequencies should not compromise the navigation capability for the intended route. The operator should provide a procedure to deal with such cases unless other sensors are available to continue on the intended route.
 - (4) The duration of a jamming event should be determined as follows:
 - (i) Considering the average speed and height of a helicopter flight, the duration of a jamming event may be considered to be less than 2 minutes.
 - (ii) The time needed for the GNSS system to re-start and provide the aircraft position and navigation guidance should also be considered.
 - (iii) Based on (i) and (ii) above, the operator should establish the duration of the loss of GNSS navigation data due to jamming. This duration should be no less than 3 minutes, and may be no longer than 4 minutes.
 - (5) The operator should ensure resilience to jamming for the duration determined in (4) above, as follows:
 - (i) If the altitude of obstacles on both sides of the flight path are higher than the planned altitude for a given segment of the flight, the operator should ensure that there is no excessive drift on either side by relying on navigation sensors such as inertial systems with performance in accordance with the intended function.
 - (ii) If (i) does not apply and the operator cannot rely on sensors other than GNSS, the operator should develop a procedure to ensure that a drift from the intended route during the jamming event has no adverse consequences on the safety of the flight. This procedure may involve air traffic services.
 - (6) The operator should ensure that no space weather event is predicted to disrupt GNSS reliability and integrity at both the destination and the alternate.
 - (7) The operator should verify the availability of RAIM for all phases of flight based on GNSS, including navigation to the alternate.
 - (8) The operator's MEL should reflect the elements in points (b)(1) and (b)(2).

OPERATIONAL CREDITS

- (c) To comply with point [NCC.OP.153](#), when the operator intends to use ‘operational credits’ (e.g. EFVS, SA CAT I, etc.), the operator should select an aerodrome as destination alternate aerodrome only if an approach procedure that does not rely on the same ‘operational credit’ is available either at that aerodrome or at the destination aerodrome.

GM1 NCC.OP.153 Destination aerodromes – instrument approach operations*ED Decision 2016/017/R***INTENT OF AMC1**

- (a) The limitation applies only to destination alternate aerodromes for flights when a destination alternate aerodrome is required. A take-off or en route alternate aerodrome with instrument approach procedures relying on GNSS may be planned without restrictions. A destination aerodrome with all instrument approach procedures relying solely on GNSS may be used without a destination alternate aerodrome if the conditions for a flight without a destination alternate aerodrome are met.
- (b) The term ‘available’ means that the procedure can be used in the planning stage and complies with planning minima requirements.

GM2 NCC.OP.153 Destination aerodromes — instrument approach operations*ED Decision 2022/012/R***GNSS ROBUSTNESS AGAINST LOSS OF CAPABILITY — HELICOPTERS**

- (a) Redundancy of on-board systems ensures that no single on-board equipment failure (e.g. antenna, GNSS receiver, FMS, or navigation display failure) results in the loss of the GNSS capability.
- (b) Any shadowing of the GNSS signal or jamming of all GNSS frequencies from the ground is expected to be of a very short duration and affect a very small area. Additional sensors or functions such as inertial coasting may be used during jamming events. Jamming should be considered on all segments of the intended route, including the approach.
- (c) The availability of GNSS signals can be compromised if space weather events cause ‘loss of lock’ conditions and more than one satellite signal may be lost on a given GNSS frequency. Until space weather forecasts are available, the operator may use ‘nowcasts’ as short-term predictions for helicopter flights of short duration.
- (d) SBAS also contributes to the mitigation of space weather effects, both by providing integrity messages and by correcting ionosphere-induced errors.
- (e) Even though SBAS should be available and used, RAIM should remain available autonomously. In case of loss of the SBAS, the route and the approach to the destination or alternate should still be flown with an available RAIM function.
- (f) When available, GNSS based on more than one constellation and more than one frequency may provide better integrity and redundancy regarding failures in the space segment of GNSS, jamming, and resilience to space weather events.

NCC.OP.155 Refuelling with passengers embarking, on board or disembarking

Regulation (EU) 2021/1296

- (a) The aircraft shall not be refuelled with aviation gasoline (AVGAS) or wide-cut type fuel or a mixture of these types of fuel, when passengers are embarking, on board or disembarking.
- (b) For all other types of fuel/energy, necessary precautions shall be taken and the aircraft shall be properly manned by qualified personnel ready to initiate and direct an evacuation of the aircraft by the most practical and expeditious means available.

AMC1 NCC.OP.155 Refuelling with passengers embarking, on board or disembarking

ED Decision 2022/005/R

OPERATIONAL PROCEDURES — AEROPLANES

- (a) If passengers are on board when refuelling with:
 - (1) other than aviation gasoline (AVGAS); or
 - (2) wide-cut type fuel; or
 - (3) a mixture of these types of fuel,ground servicing activities and work inside the aeroplane, such as catering and cleaning, should be conducted in such a manner that they do not create a hazard and allow emergency evacuation to take place through those aisles and exits intended for emergency evacuation.
- (b) The deployment of integral aircraft stairs or the opening of emergency exits as a prerequisite to refuelling is not necessarily required.
- (c) Operational procedures should specify that at least the following precautions are taken:
 - (1) one qualified person should remain at a specified location during fuelling operations with passengers on board. This qualified person should be capable of handling emergency procedures concerning fire protection and fire-fighting, handling communications and initiating and directing an evacuation;
 - (2) two-way communication should be established and should remain available by the aeroplane's inter-communication system or other suitable means between the ground crew supervising the refuelling and the qualified personnel on board the aeroplane; the involved personnel should remain within easy reach of the system of communication;
 - (3) crew members, personnel and passengers should be warned that refuelling will take place;
 - (4) 'fasten seat belts' signs should be off;
 - (5) 'no smoking' signs should be on, together with interior lighting to enable emergency exits to be identified;
 - (6) passengers should be instructed to unfasten their seat belts and refrain from smoking;
 - (7) the minimum required number of cabin crew should be on board and be prepared for an immediate emergency evacuation;
 - (8) if the presence of fuel vapour is detected inside the aeroplane, or any other hazard arises during refuelling, fuelling should be stopped immediately;

- (9) the ground area beneath the exits intended for emergency evacuation and slide deployment areas, if applicable, should be kept clear at doors where stairs are not in position for use in the event of evacuation; and
- (10) provision should be made for a safe and rapid evacuation.

AMC2 NCC.OP.155 Refuelling with passengers embarking, on board or disembarking

ED Decision 2022/005/R

OPERATIONAL PROCEDURES — HELICOPTERS

When the helicopter rotors are stopped, the efficiency and speed of passengers disembarking from and re-embarking on board helicopters is such that disembarking before refuelling and re-embarking after refuelling is the general practice. However, if such operations are needed, the operator should refer to [AMC1 NCC.OP.157](#) and [AMC2 NCC.OP.157](#). Operational procedures to be described in the operations manual (OM) should specify that at least the relevant precautions of the aforementioned AMC are taken.

GM1 NCC.OP.155 Refuelling with passengers embarking, on board or disembarking

ED Decision 2013/021/R

AIRCRAFT REFUELLING PROVISIONS AND GUIDANCE ON SAFE REFUELLING PRACTICES

Provisions concerning aircraft refuelling are contained in Volume I (Aerodrome Design and Operations) of ICAO Annex 14 (Aerodromes), and guidance on safe refuelling practices is contained in Parts 1 and 8 of the ICAO Airport Services Manual (Doc 9137).

NCC.OP.157 Refuelling with engine(s) and/or rotors turning – helicopters

Regulation (EU) 2021/1296

- (a) Refuelling with engine(s) and/or rotors turning shall only be conducted:
 - (1) with no passengers embarking or disembarking;
 - (2) if the operator of the aerodrome/operating site allows such operations;
 - (3) in accordance with any specific procedures and limitations in the aircraft flight manual (AFM);
 - (4) with JET A or JET A-1 fuel types; and
 - (5) in the presence of the appropriate rescue and firefighting (RFF) facilities or equipment.
- (b) The operator shall assess the risks associated with refuelling with engine(s) and/or rotors turning.
- (c) The operator shall establish appropriate procedures to be followed by all involved personnel, such as crew members and ground operations personnel.
- (d) The operator shall train its crew members and ensure that the involved ground operations personnel is trained appropriately.

- (e) The operator shall ensure that the helicopter refuelling procedure with engine(s) and/or rotors turning are specified in the operations manual. This procedure and any change thereto shall require prior approval by the competent authority.

AMC1 NCC.OP.157 Refuelling with engine(s) running and/or rotors turning — helicopters

ED Decision 2022/005/R

OPERATIONAL PROCEDURES — NO PASSENGERS ON BOARD

Operational procedures in the OM should specify that at least the following precautions are taken:

- (a) all necessary information should be exchanged in advance with the aerodrome operator, operating-site operator, and refuelling operator;
- (b) the procedures to be used by crew members should be defined;
- (c) the procedures to be used by the operator's ground operations personnel that may be in charge of refuelling or assisting in emergency evacuations should be described;
- (d) the operator's training programmes for crew members and for the operator's ground operations personnel should be described;
- (e) the minimum distance between the helicopter turning parts and the refuelling vehicle or installations should be defined when the refuelling takes place outside an aerodrome or at an aerodrome where there are no such limitations;
- (f) besides any rescue and firefighting services (RFFSs) that are required to be available by aerodrome regulations, an additional handheld fire extinguisher with the equivalent of 5 kg of dry powder should be immediately available and ready for use;
- (g) a means for a two-way communication between the crew and the person in charge of refuelling should be defined and established;
- (h) if fuel vapour is detected inside the helicopter, or any other hazard arises, refuelling/defuelling should be stopped immediately;
- (i) one pilot should stay at the controls, constantly monitor the refuelling, and be ready to shut off the engines and evacuate at all times; and
- (j) any additional precautions should be taken, as determined by the risk assessment.

AMC2 NCC.OP.157 Refuelling with the engine(s) running and/or rotors turning — helicopters

ED Decision 2022/005/R

OPERATIONAL PROCEDURES — PASSENGERS ON BOARD

In addition to [AMC1 NCC.OP.157](#), for refuelling with passengers on board, operational procedures in the OM should specify that at least the following precautions are taken:

- (a) the positioning of the helicopter and the corresponding helicopter evacuation strategy should be defined taking into account the wind as well as the refuelling facilities or vehicles;
- (b) on a heliport, the ground area beneath the exits that are intended for emergency evacuation should be kept clear;

- (c) an additional passenger briefing as well as instructions should be defined, and the 'No smoking' signs should be on unless 'No smoking' placards are installed;
- (d) interior lighting should be set to enable identification of emergency exits;
- (e) the use of doors during refuelling should be defined: doors on the refuelling side should remain closed, while doors on the opposite side should remain unlocked or, weather permitting, open, unless otherwise specified in the AFM;
- (f) at least one suitable person capable of implementing emergency procedures for firefighting, communications, as well as for initiating and directing an evacuation, should remain at a specified location; this person should not be the qualified pilot at the controls or the person performing the refuelling; and
- (g) unless passengers are regularly trained in emergency evacuation procedures, an additional crew member or ground crew member should be assigned to assist in the rapid evacuation of the passengers.

GM1 NCC.OP.157 Refuelling with the engine(s) and/or rotors turning — helicopters

ED Decision 2022/005/R

RISK ASSESSMENT

The risk assessment should explain why it is not practical to refuel with the engine(s) and rotors stopped, identify any additional hazards, and describe how the additional risks are controlled. Helicopter offshore operations (HOFO) are typical operations where the benefits should outweigh the risks if mitigation measures are taken.

Guidance on safe refuelling practices is contained in ICAO Doc 9137 Airport Services Manual, Parts 1 and 8.

The operator's risk assessment may include, but not be limited to, the following risks, hazards and mitigation measures:

- (a) risk related to refuelling with rotors turning;
- (b) risk related to the shutting down of the engines, including the risk of failures during start-up;
- (c) environmental conditions, such as wind limitations, displacement of exhaust gases, and blade sailing;
- (d) risk related to human factors and fatigue management, especially for single-pilot operations for long periods of time;
- (e) risk mitigation, such as the safety features of the fuel installation, rescue and firefighting (RFF) capability, number of personnel members available, ease of emergency evacuation of the helicopter, etc.;
- (f) assessment of the use of radio transmitting equipment;
- (g) determination of the use of passenger seat belts;
- (h) review of the portable electronic device (PED) policy; and
- (i) if passengers are to disembark, consideration of their disembarking before rather than after the refuelling; and

- (j) if passengers are to embark, consideration of their embarking after rather than before the refuelling.

NCC.OP.160 Use of headset

Regulation (EU) No 800/2013

- (a) Each flight crew member required to be on duty in the flight crew compartment shall wear a headset with boom microphone or equivalent. The headset shall be used as the primary device for voice communications with ATS:
- (1) when on the ground:
 - (i) when receiving the ATC departure clearance via voice communication; and
 - (ii) when engines are running;
 - (2) when in flight:
 - (i) below transition altitude; or
 - (ii) 10 000 ft, whichever is higher;and
 - (3) whenever deemed necessary by the pilot in command.
- (b) In the conditions of (a), the boom microphone or equivalent shall be in a position that permits its use for two-way radio communications.

NCC.OP.165 Carriage of passengers

Regulation (EU) No 800/2013

The operator shall establish procedures to ensure that:

- (a) passengers are seated where, in the event that an emergency evacuation is required, they are able to assist and not hinder evacuation of the aircraft;
- (b) prior to and during taxiing, take-off and landing, and whenever deemed necessary in the interest of safety by the pilot-in-command, each passenger on board occupies a seat or berth and has his/her safety belt or restraint device properly secured; and
- (c) multiple occupancy is only allowed on specified aircraft seats occupied by one adult and one infant properly secured by a supplementary loop belt or other restraint device.

AMC1 NCC.OP.165 Carriage of passengers

ED Decision 2013/021/R

SEATS THAT PERMIT DIRECT ACCESS TO EMERGENCY EXITS

Passengers who occupy seats that permit direct access to emergency exits should appear to be reasonably fit, strong and able to assist the rapid evacuation of the aircraft in an emergency after an appropriate briefing by the crew.

GM1 NCC.OP.165 Carriage of passengers

ED Decision 2013/021/R

MEANING OF DIRECT ACCESS

'Direct access' means a seat from which a passenger can proceed directly to the exit without entering an aisle or passing around an obstruction.

NCC.OP.170 Securing of passenger compartment and galley(s)

Regulation (EU) No 800/2013

The pilot-in-command shall ensure that:

- (a) before taxiing, take-off and landing, all exits and escape paths are unobstructed; and
- (b) before take-off and landing, and whenever deemed necessary in the interest of safety, all equipment and baggage are properly secured.

NCC.OP.175 Smoking on board

Regulation (EU) No 800/2013

The pilot-in-command shall not allow smoking on board:

- (a) whenever considered necessary in the interest of safety;
- (b) during refuelling of the aircraft;
- (c) while the aircraft is on the surface unless the operator has determined procedures to mitigate the risks during ground operations;
- (d) outside designated smoking areas, in the aisle(s) and lavatory(ies);
- (e) in cargo compartments and/or other areas where cargo is carried that is not stored in flame-resistant containers or covered by flame-resistant canvas; and
- (f) in those areas of the passenger compartments where oxygen is being supplied.

NCC.OP.180 Meteorological conditions

Regulation (EU) 2021/2237

- (a) The pilot-in-command shall only commence or continue a VFR flight if the latest available meteorological information indicates that the meteorological conditions along the route and at the intended destination at the estimated time of use will be at or above the applicable VFR operating minima.
- (b) The pilot-in-command shall only commence or continue an IFR flight towards the planned destination aerodrome if the latest available meteorological information indicates that, at the estimated time of arrival, the meteorological conditions at the destination or at least one destination alternate aerodrome are at or above the applicable aerodrome operating minima.
- (c) If a flight contains VFR and IFR segments, the meteorological information referred to in (a) and (b) shall be applicable as far as relevant.

AMC1 NCC.OP.180 Meteorological conditions

ED Decision 2013/021/R

EVALUATION OF METEOROLOGICAL CONDITIONS

Pilots should carefully evaluate the available meteorological information relevant to the proposed flight, such as applicable surface observations, winds and temperatures aloft, terminal and area forecasts, air meteorological information reports (AIRMETs), significant meteorological information (SIGMET) and pilot reports. The ultimate decision whether, when, and where to make the flight rests with the pilot-in-command. Pilots should continue to re-evaluate changing weather conditions.

GM1 NCC.OP.180 Meteorological conditions

ED Decision 2013/021/R

CONTINUATION OF A FLIGHT

In the case of in-flight re-planning, continuation of a flight refers to the point from which a revised flight plan applies.

NCC.OP.185 Ice and other contaminants – ground procedures

Regulation (EU) No 800/2013

- (a) The operator shall establish procedures to be followed when ground de-icing and anti-icing and related inspections of the aircraft are necessary to allow the safe operation of the aircraft.
- (b) The pilot-in-command shall only commence take-off if the aircraft is clear of any deposit that might adversely affect the performance or controllability of the aircraft, except as permitted under the procedures referred to in (a) and in accordance with the AFM.

GM1 NCC.OP.185 Ice and other contaminants – ground procedures

ED Decision 2021/005/R

TERMINOLOGY

Terms used in the context of de-icing/anti-icing have the meaning defined in the following subparagraphs.

- (a) 'Anti-icing': the process of protecting the aircraft to prevent contamination due to existing or expected weather, typically by applying anti-icing fluids on uncontaminated aircraft surfaces.
- (b) 'Anti-icing fluid' includes, but is not limited to, the following:
 - (1) Typically, Type II, III or IV fluid (neat or diluted), normally applied unheated (*);
 - (2) Type I fluid/water mixture heated to minimum 60°C at the nozzle.(*) When de-icing and anti-icing in a one-step process, Type II and Type IV fluids are typically applied diluted and heated.
- (c) 'Clear ice': a coating of ice, generally clear and smooth, but with some air pockets. It forms on exposed objects, the temperatures of which are at, below or slightly above the freezing temperature, by the freezing of super-cooled drizzle, droplets or raindrops. Clear ice is very difficult to be detected visually.
- (d) 'Cold soaked surface frost (CSSF)': frost developed on cold soaked aircraft surfaces by sublimation of air humidity. This effect can take place at ambient temperatures above 0 °C. Cold soaked aircraft surfaces are more common on aircraft that have recently landed. External

surfaces of fuel tanks (e.g. wing skins) are typical areas of CSSF formation (known in this case as cold soaked fuel frost (CSFF)), due to the thermal inertia of very cold fuel that remains on the tanks after landing.

- (e) 'Conditions conducive to aircraft icing on the ground': freezing fog, freezing precipitation, frost, rain or high humidity (on cold soaked wings), hail, ice pellets, snow or mixed rain and snow.
- (f) 'Contamination': all forms of frozen or semi-frozen deposits on an aircraft, such as frost, snow, slush or ice.
- (g) 'Contamination check': a check of the aircraft for contamination to establish the need for de-icing.
- (h) 'De-icing': the process of eliminating frozen contamination from aircraft surfaces, typically by applying de-icing fluids.
- (i) 'De-icing fluid': such fluid includes, but is not limited to, the following:
 - (1) Heated water;
 - (2) Preferably, Type I fluid (neat or diluted (typically));
 - (3) Type II, III or IV fluid (neat or diluted).

The de-icing fluid is normally applied heated to ensure maximum efficiency and its freezing point should be at the outside air temperature (OAT) or below.

- (j) 'De-icing/anti-icing': this is the combination of de-icing and anti-icing performed in either one or two steps.
- (k) 'Ground ice detection system (GIDS)': a system used during aircraft ground operations to inform the personnel involved in the operation and/or the flight crew about the presence of frost, ice, snow or slush on the aircraft surfaces.
- (l) 'Holdover time (HOT)': the period of time during which an anti-icing fluid provides protection against frozen contamination to the treated aircraft surfaces. It depends among other variables, on the type and intensity of the precipitation, OAT, wind, the particular fluid (or fluid Type) and aircraft design and aircraft configuration during the treatment.
- (m) 'Liquid water equivalent (LWE) system': an automated weather measurement system that determines the LWE precipitation rate in conditions of frozen or freezing precipitation. The system provides flight crew with continuously updated information on the fluid protection capability under varying weather conditions.
- (n) 'Lowest operational use temperature (LOUT)': the lowest temperature at which a fluid has been tested and certified as acceptable in accordance with the appropriate aerodynamic acceptance test whilst still maintaining a freezing point buffer of not less than:
 - (1) 10°C for a Type I fluid; or
 - (2) 7°C for Type II, III or IV fluids.
- (o) 'Post-treatment check', 'Post- de-icing check' or 'Post- de-icing/anti-icing check': an external check of the aircraft after de-icing and/or anti-icing treatment accomplished by qualified staff and from suitably elevated observation points (e.g. from the de-icing/anti-icing equipment itself or other elevated equipment) to ensure that the aircraft is free from frost, ice, snow, or slush.
- (p) 'Pre-take-off check': The flight crew should continuously monitor the weather conditions after the de-icing/anti-icing treatment to assess whether the applied holdover time is still

appropriate. Within the aircraft's HOT and prior to take-off, the flight crew should check the aircraft's wings or representative aircraft surfaces for frozen contaminants.

- (q) 'Pre-take-off contamination check': a check of the treated surfaces for contamination, performed when the HOT has been exceeded or if any doubt exists regarding the continued effectiveness of the applied anti-icing treatment. It is normally accomplished externally, just before commencement of the take-off run.

ANTI-ICING CODES

- (r) Upon completion of the anti-icing treatment, a qualified staff provides the anti-icing code to the flight crew as follows: 'the fluid Type/the fluid name (except for Type I)/concentration (except for Type I)/local time at start of anti-icing/date (optional)/the statement 'post- de-icing/anti-icing check completed' (if check completed). Example:

'TYPE II / MANUFACTURER, BRAND X / 75% / 1335 / 15FEB20 / POST- DE-ICING/ANTI-ICING CHECK COMPLETED'.

- (s) When a two-step de-icing/anti-icing operation has been carried out, the anti-icing code should be determined by the second step fluid.

GM2 NCC.OP.185 Ice and other contaminants – ground procedures

ED Decision 2021/005/R

DE-ICING/ANTI-ICING — PROCEDURES

- (a) De-icing and/or anti-icing procedures should take into account manufacturer's recommendations, including those that are type-specific, and should cover:
- (1) contamination checks, including detection of clear ice and under-wing frost; limits on the thickness/area of contamination published in the AFM or other manufacturers' documentation should be followed;
 - (2) procedures to be followed if de-icing and/or anti-icing procedures are interrupted or unsuccessful;
 - (3) post-treatment checks;
 - (4) pre-take-off checks;
 - (5) pre-take-off contamination checks;
 - (6) the recording of any incidents relating to de-icing and/or anti-icing; and
 - (7) the responsibilities of all personnel involved in de-icing and/or anti-icing.
- (b) The operator's procedures should ensure the following:
- (1) When aircraft surfaces are contaminated by ice, frost, slush or snow, they are de-iced prior to take-off, according to the prevailing conditions. Removal of contaminants may be performed with mechanical tools, fluids (including hot water), infrared heat or forced air, taking account of aircraft type-specific provisions.
 - (2) Account is taken of the wing skin temperature versus OAT, as this may affect:
 - (i) the need to carry out aircraft de-icing and/or anti-icing; and/or
 - (ii) the performance of the de-icing/anti-icing fluids.
 - (3) When freezing precipitation occurs or there is a risk of freezing precipitation occurring that would contaminate the surfaces at the time of take-off, aircraft surfaces should be

anti-iced. Anti-icing fluids (neat or diluted) should not be applied at OAT below their LOUT. If both de-icing and anti-icing are required, the procedure may be performed in a one- or two-step process, depending upon weather conditions, available equipment, available fluids and the desired HOT. One-step de-icing/anti-icing means that de-icing and anti-icing are carried out at the same time, using a mixture of de-icing/anti-icing fluid and water. Two-step de-icing/anti-icing means that de-icing and anti-icing are carried out in two separate steps. The aircraft is first de-iced using heated water only or a heated mixture of de-icing/anti-icing fluid and water. After completion of the de-icing operation, a layer of a mixture of de-icing/anti-icing fluid and water, or of de-icing /anti-icing fluid only, is sprayed over the aircraft surfaces. The second step will be taken before the first step fluid freezes (typically within 3 minutes but severe conditions may shorten this) and, if necessary, area by area.

- (4) When an aircraft is anti-iced and a longer HOT is needed/desired, the use of a less diluted thickened fluid may be considered.
 - (5) All restrictions relative to OAT and fluid application (including, but not necessarily limited to, temperature and pressure) published by the fluid manufacturer and/or aircraft manufacturer, are followed and procedures, limitations and recommendations to prevent the formation of fluid residues are followed.
 - (6) During conditions conducive to aircraft icing on the ground or after de-icing and/or anti-icing, an aircraft is not dispatched for departure unless it has been given a contamination check or a post-treatment check by a trained and qualified person. This check should cover all treated surfaces of the aircraft and be performed from points offering sufficient visibility to these parts. To ensure that there is no clear ice on suspect areas, it may also be necessary to make a physical check (e.g. tactile).
 - (7) The required entry is made in the technical log.
 - (8) The commander continually monitors the environmental situation after the performed treatment. Prior to take-off, he/she performs a pre-take-off check, which is an assessment of whether the applied HOT is still appropriate. This pre-take-off check includes, but is not limited to, factors such as precipitation, wind and OAT.
 - (9) If any doubt exists as to whether a deposit may adversely affect the aircraft's performance and/or controllability characteristics, the commander should arrange for a re-treatment or a pre-take-off contamination check to be performed in order to verify that the aircraft's surfaces are free of contamination. Special methods and/or equipment may be necessary to perform this check, especially at nighttime or in extremely adverse weather conditions. If this check cannot be performed just before take-off, re-treatment should be applied.
 - (10) When retreatment is necessary, any residue of the previous treatment should be removed, and a completely new de-icing/anti-icing treatment should be applied.
 - (11) When a ground ice detection system (GIDS) is used to perform an aircraft surfaces check prior to and/or after a treatment, the use of GIDS by suitably trained personnel should be part of the procedure.
- (c) Special operational considerations
- (1) When using thickened de-icing/anti-icing fluids, the operator should consider a two-step de-icing/anti-icing procedure, the first step preferably with hot water and/or un-thickened fluids.

- (2) The use of de-icing/anti-icing fluids should be in accordance with the aircraft manufacturer's documentation. This is particularly important for thickened fluids to assure sufficient flow-off during take-off. Avoid applying excessive thickened fluid on the horizontal tail of aircraft with unpowered elevator controls.
 - (3) The operator should comply with any type-specific operational requirement(s), such as an aircraft mass decrease and/or a take-off speed increase associated with a fluid application.
 - (4) The operator should take into account any flight handling procedures (stick force, rotation speed and rate, take-off speed, aircraft attitude, etc.) laid down by the aircraft manufacturer when associated with a fluid application.
 - (5) The limitations or handling procedures resulting from (c)(3) and/or (c)(4) should be part of the flight crew pre-take-off briefing.
- (d) Communications
- (1) Before aircraft treatment. When the aircraft is to be treated with the flight crew on board, the flight and personnel involved in the operation should confirm the fluid to be used, the extent of treatment required and any aircraft type-specific procedure(s) to be used. Any other information needed to apply the HOT tables should be exchanged.
 - (2) Anti-icing code. The operator's procedures should include an anti-icing code, which indicates the treatment the aircraft has received. This code provides the flight crew with the minimum details necessary to estimate a HOT and confirms that the aircraft is free of contamination.
 - (3) After treatment. Before reconfiguring or moving the aircraft, the flight crew should receive a confirmation from the personnel involved in the operation that all de-icing and/or anti-icing operations are complete and that all personnel and equipment are clear of the aircraft.
- (e) Holdover protection & LWE systems
- The operator should publish in the operations manual, when required, the HOTs in the form of a table or a diagram, to account for the various types of ground icing conditions and the different types and concentrations of fluids used. However, the times of protection shown in these tables are to be used as guidelines only and are normally used in conjunction with the pre-take-off check.
- An operator may choose to operate using LWE systems instead of HOT tables whenever the required means for using these systems are in place.
- (f) Training
- The operator's initial and recurrent de-icing training programmes (including communication training) for flight crew and for other personnel involved in de-icing operations should include additional training if any of the following is introduced:
- (1) a new method, procedure and/or technique;
 - (2) a new type of fluid and/or equipment; or
 - (3) a new type of aircraft.

(g) Contracting

When the operator contracts de-icing/anti-icing functions, the operator should ensure that the contractor complies with the operator's training/qualification procedures, together with any specific procedures in respect of:

- (1) roles and responsibilities;
- (2) de-icing and/or anti-icing methods and procedures;
- (3) fluids to be used, including precautions for storage, preparation for use and chemical incompatibilities;
- (4) specific aircraft provisions (e.g. no-spray areas, propeller/engine de-icing, APU operation etc.);
- (5) different checks to be conducted; and
- (6) procedures for communications with flight crew and any other third party involved.

(h) Special maintenance considerations

(1) General

The operator should take proper account of the possible side effects of fluid use. Such effects may include, but are not necessarily limited to, dried and/or re-hydrated residues, corrosion and the removal of lubricants.

(2) Special considerations regarding residues of dried fluids

The operator should establish procedures to prevent or detect and remove residues of dried fluid. If necessary, the operator should establish appropriate inspection intervals based on the recommendations of the airframe manufacturers and/or the operator's own experience:

(i) Dried fluid residues

Dried fluid residues could occur when surfaces have been treated and the aircraft has not subsequently been flown and has not been subject to precipitation. The fluid may then have dried on the surfaces.

(ii) Re-hydrated fluid residues

Repetitive application of thickened de-icing/anti-icing fluids may lead to the subsequent formation/build-up of a dried residue in aerodynamically quiet areas, such as cavities and gaps. This residue may re-hydrate if exposed to high humidity conditions, precipitation, washing, etc., and increase to many times its original size/volume. This residue will freeze if exposed to conditions at or below 0 °C. This may cause moving parts, such as elevators, ailerons, and flap actuating mechanisms to stiffen or jam in-flight. Re-hydrated residues may also form on exterior surfaces, which can reduce lift, increase drag and stall speed. Re-hydrated residues may also collect inside control surface structures and cause clogging of drain holes or imbalances to flight controls. Residues may also collect in hidden areas, such as around flight control hinges, pulleys, grommets, on cables and in gaps.

- (iii) Operators are strongly recommended to obtain information about the fluid dry-out and re-hydration characteristics from the fluid manufacturers and to select products with optimised characteristics.

- (iv) Additional information should be obtained from fluid manufacturers for handling, storage, application and testing of their products.

GM3 NCC.OP.185 Ice and other contaminants – ground procedures

ED Decision 2021/005/R

DE-ICING/ANTI-ICING — BACKGROUND INFORMATION

Further guidance material on this issue is given in the ICAO *Manual of Aircraft Ground De-icing/Anti-icing Operations* (Doc 9640).

(a) General

- (1) Any deposit of frost, ice, snow or slush on the external surfaces of an aircraft may drastically affect its flying qualities because of reduced aerodynamic lift, increased drag, modified stability and control characteristics. Furthermore, freezing deposits may cause moving parts, such as elevators, ailerons, flap actuating mechanism, etc., to jam and create a potentially hazardous condition. Propeller/engine/APU/systems performance may deteriorate due to the presence of frozen contaminants on blades, intakes and components. Also, engine operation may be seriously affected by the ingestion of snow or ice, thereby causing engine stall or compressor damage. In addition, ice/frost may form on certain external surfaces (e.g. wing upper and lower surfaces, etc.) due to the effects of cold fuel/structures, even in ambient temperatures well above 0 °C.
- (2) Procedures established by the operator for de-icing and/or anti-icing are intended to ensure that the aircraft is clear of contamination so that degradation of aerodynamic characteristics or mechanical interference will not occur and, following anti-icing, to maintain the airframe in that condition during the appropriate HOT.
- (3) Under certain meteorological conditions, de-icing and/or anti-icing procedures may be ineffective in providing sufficient protection for continued operations. Examples of these conditions are freezing rain, ice pellets and hail snow exceeding certain intensities, high wind velocity, and fast-dropping OAT. No HOT guidelines exist for these conditions.
- (4) Material for establishing operational procedures can be found, for example, in:
 - (i) ICAO Annex 3 ‘Meteorological Service for International Air Navigation’;
 - (ii) ICAO ‘Manual of Aircraft Ground De-icing/Anti-icing Operations’;
 - (iii) SAE AS6285 ‘Aircraft Ground Deicing/Anti-Icing Processes’;
 - (iv) SAE AS6286 ‘Aircraft Ground Deicing/Anti-Icing Training and Qualification Program’;
 - (v) SAE AS6332 ‘Aircraft Ground Deicing/Anti-icing Quality Management’;
 - (vi) SAE ARP6257 ‘Aircraft Ground De/Anti-Icing Communication Phraseology for Flight and Ground Crews’;
 - (vii) FAA Holdover Time Guidelines
 - (viii) FAA 8900.xxx series Notice ‘Revised FAA-Approved Deicing Program Updates, Winter 20xx-20yy’.

(b) Fluids

- (1) Type I fluid: Due to its properties, Type I fluid forms a thin, liquid-wetting film on surfaces to which it is applied which, under certain weather conditions, gives a very limited HOT.

For anti-icing purposes the fluid/water mixture should have a freezing point of at least 10 °C below OAT; increasing the concentration of fluid in the fluid/water mix does not provide any extension in HOT.

- (2) Type II and Type IV fluids contain thickeners which enable the fluid to form a thicker liquid-wetting film on surfaces to which it is applied. Generally, this fluid provides a longer HOT than Type I fluids in similar conditions.
 - (3) Type III fluid is a thickened fluid especially intended for use on aircraft with low rotation speeds.
 - (4) Fluids used for de-icing and/or anti-icing should be acceptable to the operator and the aircraft manufacturer. These fluids normally conform to specifications such as SAE AMS1424 (Type I) or SAE AMS1428 (Types II, III and IV). Use of non-conforming fluids is not recommended due to their characteristics being unknown. The anti-icing and aerodynamic properties of thickened fluids may be seriously degraded by, for example, inappropriate storage, treatment, application, application equipment, age and in case they are applied on top of non-chemically compatible de-icing fluids.
- (c) Hold-over protection
- (1) Hold-over protection is achieved by a layer of anti-icing fluid remaining on and protecting aircraft surfaces for a period of time. With a one-step de-icing/anti-icing procedure, the HOT begins at the commencement of de-icing/anti-icing. With a two-step procedure, the HOT begins at the commencement of the second (anti-icing) step. The hold-over protection runs out:
 - (i) at the commencement of the take-off roll (due to aerodynamic shedding of fluid);
or
 - (ii) when frozen deposits start to form or accumulate on treated aircraft surfaces, thereby indicating the loss of effectiveness of the fluid.
 - (2) The duration of hold-over protection may vary depending on the influence of factors other than those specified in the HOT tables. Guidance should be provided by the operator to take account of such factors, which may include:
 - (i) atmospheric conditions, e.g. exact type and rate of precipitation, wind direction and velocity, relative humidity and solar radiation; and
 - (ii) the aircraft and its surroundings, such as aircraft component inclination angle, contour and surface roughness, surface temperature, operation in close proximity to other aircraft (jet or propeller blast) and ground equipment and structures.
 - (3) HOTs are not meant to imply that flight is safe in the prevailing conditions if the specified HOT has not been exceeded. Certain meteorological conditions, such as freezing drizzle or freezing rain, may be beyond the certification envelope of the aircraft.

NCC.OP.190 Ice and other contaminants – flight procedures

Regulation (EU) No 800/2013

- (a) The operator shall establish procedures for flights in expected or actual icing conditions.
- (b) The pilot-in-command shall only commence a flight or intentionally fly into expected or actual icing conditions if the aircraft is certified and equipped to cope with such conditions as referred to in 2.a.5 of Annex IV to Regulation (EC) No 216/2008.

- (c) If icing exceeds the intensity of icing for which the aircraft is certified or if an aircraft not certified for flight in known icing conditions encounters icing, the pilot-in-command shall exit the icing conditions without delay, by a change of level and/or route, and if necessary by declaring an emergency to ATC.

AMC1 NCC.OP.190 Ice and other contaminants – flight procedures

ED Decision 2013/021/R

FLIGHT IN EXPECTED OR ACTUAL ICING CONDITIONS

- (a) The procedures to be established by the operator should take account of the design, the equipment, the configuration of the aircraft and the necessary training. For these reasons, different aircraft types operated by the same company may require the development of different procedures. In every case, the relevant limitations are those that are defined in the AFM and other documents produced by the manufacturer.
- (b) The operator should ensure that the procedures take account of the following:
- (1) the equipment and instruments that should be serviceable for flight in icing conditions;
 - (2) the limitations on flight in icing conditions for each phase of flight. These limitations may be imposed by the aircraft's de-icing or anti-icing equipment or the necessary performance corrections that have to be made;
 - (3) the criteria the flight crew should use to assess the effect of icing on the performance and/or controllability of the aircraft;
 - (4) the means by which the flight crew detects, by visual cues or the use of the aircraft's ice detection system, that the flight is entering icing conditions; and
 - (5) the action to be taken by the flight crew in a deteriorating situation (which may develop rapidly) resulting in an adverse effect on the performance and/or controllability of the aircraft, due to:
 - (i) the failure of the aircraft's anti-icing or de-icing equipment to control a build-up of ice; and/or
 - (ii) ice build-up on unprotected areas.
- (c) Training for dispatch and flight in expected or actual icing conditions. The content of the operations manual should reflect the training, both conversion and recurrent, that flight crew, cabin crew and all other relevant operational personnel require in order to comply with the procedures for dispatch and flight in icing conditions:
- (1) For the flight crew, the training should include:
 - (i) instruction on how to recognise, from weather reports or forecasts that are available before flight commences or during flight, the risks of encountering icing conditions along the planned route and on how to modify, as necessary, the departure and in-flight routes or profiles;
 - (ii) instruction on the operational and performance limitations or margins;
 - (iii) the use of in-flight ice detection, anti-icing and de-icing systems in both normal and abnormal operation; and
 - (iv) instruction on the differing intensities and forms of ice accretion and the consequent action which should be taken.

- (2) For the cabin crew, the training should include:
 - (i) awareness of the conditions likely to produce surface contamination; and
 - (ii) the need to inform the flight crew of significant ice accretion.

NCC.OP.195 Take-off conditions — aeroplanes and helicopters

Regulation (EU) 2021/2237

Before commencing take-off, the pilot-in-command shall be satisfied that:

- (a) the meteorological conditions at the aerodrome or the operating site and the condition of the runway/FATO intended to be used will not prevent a safe take-off and departure; and
- (b) the selected aerodrome operating minima are consistent with all of the following:
 - (1) the operative ground equipment;
 - (2) the operative aircraft systems;
 - (3) the aircraft performance;
 - (4) flight crew qualifications.

NCC.OP.200 Simulated situations in flight

Regulation (EU) 2018/1975

- (a) The pilot-in-command shall, when carrying passengers or cargo, not simulate:
 - (1) situations that require the application of abnormal or emergency procedures; or
 - (2) flight in instrument meteorological conditions (IMC).
- (b) Notwithstanding point (a), when training flights are conducted by a training organisation referred to in Article 10a of Commission Regulation (EU) No 1178/2011, such situations may be simulated with student pilots on-board.

NCC.OP.205 Fuel/energy management policy — in-flight fuel/energy management policy

Regulation (EU) 2021/1296

- (a) The operator shall establish procedures to ensure that in-flight fuel/energy checks and fuel/energy management are performed.
- (b) The pilot-in-command shall monitor the amount of usable fuel/energy remaining on board to ensure that it is protected and not less than the fuel/energy that is required to proceed to an aerodrome or operating site where a safe landing can be made.
- (c) The pilot-in-command shall advise air traffic control (ATC) of a 'minimum fuel/energy' state by declaring 'MINIMUM FUEL' when the pilot-in-command has:
 - (1) committed to land at a specific aerodrome or operating site; and
 - (2) calculated that any change to the existing clearance to that aerodrome or operating site, or other air traffic delays, may result in landing with less than the planned final reserve fuel/energy.
- (d) The pilot-in-command shall declare a situation of 'fuel/energy emergency' by broadcasting 'MAYDAY MAYDAY MAYDAY FUEL' when the usable fuel/energy estimated to be available upon

landing at the nearest aerodrome or operating site where a safe landing can be made is less than the planned final reserve fuel/energy.

GM1 NCC.OP.205(b)&(d) Fuel/energy scheme — in-flight fuel/energy management policy

ED Decision 2022/005/R

FINAL RESERVE FUEL PROTECTION

To ensure a safe landing, the pilot needs to protect the FRF in accordance with point [NCC.OP.131\(c\)\(3\)](#). The objective of the FRF protection is to ensure that a safe landing is made at any aerodrome or operating site when unforeseen circumstances may not allow to safely complete the flight, as originally planned.

When the FRF can no longer be protected, then a fuel emergency needs to be declared, as per point [NCC.OP.205\(d\)](#), and any landing option explored (e.g. for aeroplanes, aerodromes not assessed by the operator, military aerodromes, closed runways), including deviating from rules, operational procedures, and methods in the interest of safety (as per point [CAT.GEN.MPA.105\(b\)](#)).

ICAO Doc 9976 Flight Planning and Fuel Management (FPFM) Manual and the EASA Fuel Manual contain further detailed guidance on the development of a comprehensive in-flight fuel management policy and related procedures.

For helicopters, the operating site may be different from the planned destination or alternate aerodrome.

GM1 NCC.OP.205(c) Fuel/energy scheme — in-flight fuel/energy management policy

ED Decision 2022/005/R

'MINIMUM FUEL' DECLARATION

The 'MINIMUM FUEL' declaration informs the ATC that all planned landing options have been reduced to a specific aerodrome or operating site of intended landing, and for helicopters, that no other landing site is available. It also informs the ATC that any change to the existing clearance may result in landing with less than the planned FRF. This is not an emergency situation but an indication that an emergency situation is possible, should any additional delay occur.

The pilot should not expect any form of priority handling as a result of a 'MINIMUM FUEL' declaration. However, the ATC should advise the flight crew of any additional expected delays, as well as coordinate with other ATC units when transferring the control of the aircraft, to ensure that the other ATC units are aware of the flight's fuel state.

ICAO Doc 9976 Flight Planning and Fuel Management (FPFM) Manual (1st Edition, 2015) and the EASA Fuel Manual contain guidance on declaring 'MINIMUM FUEL'.

NCC.OP.210 Use of supplemental oxygen

Regulation (EU) No 800/2013

The pilot-in-command shall ensure that he/she and flight crew members engaged in performing duties essential to the safe operation of an aircraft in flight use supplemental oxygen continuously whenever the cabin altitude exceeds 10 000 ft for a period of more than 30 minutes and whenever the cabin altitude exceeds 13 000 ft.

NCC.OP.215 Ground proximity detection

Regulation (EU) No 800/2013

When undue proximity to the ground is detected by a flight crew member or by a ground proximity warning system, the pilot flying shall take corrective action immediately in order to establish safe flight conditions.

GM1 NCC.OP.215 Ground proximity detection

ED Decision 2013/021/R

GUIDANCE MATERIAL FOR TERRAIN AWARENESS WARNING SYSTEM (TAWS) FLIGHT CREW TRAINING PROGRAMMES

(a) Introduction

- (1) This GM contains performance-based training objectives for TAWS flight crew training.
- (2) The training objectives cover five areas: theory of operation; pre-flight operations; general in-flight operations; response to TAWS cautions; response to TAWS warnings.
- (3) The term 'TAWS' in this GM means a ground proximity warning system (GPWS) enhanced by a forward-looking terrain avoidance function. Alerts include both cautions and warnings.
- (4) The content of this GM is intended to assist operators who are producing training programmes. The information it contains has not been tailored to any specific aircraft or TAWS equipment, but highlights features that are typically available where such systems are installed. It is the responsibility of the individual operator to determine the applicability of the content of this Guidance Material to each aircraft and TAWS equipment installed and their operation. Operators should refer to the AFM and/or aircraft/flight crew operating manual (A/FCOM), or similar documents, for information applicable to specific configurations. If there should be any conflict between the content of this Guidance Material and that published in the other documents described above, then the information contained in the AFM or A/FCOM will take precedence.

(b) Scope

- (1) The scope of this GM is designed to identify training objectives in the areas of: academic training; manoeuvre training; initial evaluation; recurrent qualification. Under each of these four areas, the training material has been separated into those items that are considered essential training items and those that are considered to be desirable. In each area, objectives and acceptable performance criteria are defined.
- (2) No attempt is made to define how the training programme should be implemented. Instead, objectives are established to define the knowledge that a pilot operating a TAWS is expected to possess and the performance expected from a pilot who has completed TAWS training. However, the guidelines do indicate those areas in which the pilot receiving the training should demonstrate his/her understanding, or performance, using a real time interactive training device, i.e. a flight simulator. Where appropriate, notes are included within the performance criteria that amplify or clarify the material addressed by the training objective.

-
- (c) Performance-based training objectives
- (1) TAWS academic training
- (i) This training is typically conducted in a classroom environment. The knowledge demonstrations specified in this section may be completed through the successful completion of written tests or by providing correct responses to non-real-time computer-based training (CBT) questions.
- (ii) Theory of operation. The pilot should demonstrate an understanding of TAWS operation and the criteria used for issuing cautions and warnings. This training should address system operation. Objective: to demonstrate knowledge of how a TAWS functions. Criteria: the pilot should demonstrate an understanding of the following functions:
- (A) Surveillance
- (a) The GPWS computer processes data supplied from an air data computer, a radio altimeter, an instrument landing system (ILS)/microwave landing system (MLS)/multi-mode (MM) receiver, a roll attitude sensor, and actual position of the surfaces and of the landing gear.
- (b) The forward-looking terrain avoidance function utilises an accurate source of known aircraft position, such as that which may be provided by a flight management system (FMS) or global positioning system (GPS), or an electronic terrain database. The source and scope of the terrain, obstacle and airport data, and features such as the terrain clearance floor, the runway picker, and geometric altitude (where provided), should all be described.
- (c) Displays required to deliver TAWS outputs include a loudspeaker for voice announcements, visual alerts (typically amber and red lights) and a terrain awareness display (that may be combined with other displays). In addition, means should be provided for indicating the status of the TAWS and any partial or total failures that may occur.
- (B) Terrain avoidance. Outputs from the TAWS computer provide visual and audio synthetic voice cautions and warnings to alert the flight crew about potential conflicts with terrain and obstacles.
- (C) Alert thresholds. Objective: to demonstrate knowledge of the criteria for issuing cautions and warnings. Criteria: the pilot should be able to demonstrate an understanding of the methodology used by a TAWS to issue cautions and alerts and the general criteria for the issuance of these alerts, including:
- (a) basic GPWS alerting modes specified in the ICAO standard:
- Mode 1: excessive sink rate;
- Mode 2: excessive terrain closure rate;
- Mode 3: descent after take-off or missed approach;
- Mode 4: unsafe proximity to terrain; and
- Mode 5: descent below ILS glide slope (caution only);

- (b) an additional, optional alert mode:
Mode 6: radio altitude call-out (information only); and
 - (c) TAWS cautions and warnings that alert the flight crew to obstacles and terrain ahead of the aircraft in line with or adjacent to its projected flight path (forward-looking terrain avoidance (FLTA) and premature descent alert (PDA) functions).
- (D) TAWS limitations. Objective: to verify that the pilot is aware of the limitations of TAWS. Criteria: the pilot should demonstrate knowledge and an understanding of TAWS limitations identified by the manufacturer for the equipment model installed, such as:
- (a) navigation should not be predicated on the use of the terrain display;
 - (b) unless geometric altitude data is provided, use of predictive TAWS functions is prohibited when altimeter subscale settings display 'QFE' (atmospheric pressure at aerodrome elevation/runway threshold);
 - (c) nuisance alerts can be issued if the aerodrome of intended landing is not included in the TAWS airport database;
 - (d) in cold weather operations, corrective procedures should be implemented by the pilot unless the TAWS has in-built compensation, such as geometric altitude data;
 - (e) loss of input data to the TAWS computer could result in partial or total loss of functionality. Where means exist to inform the flight crew that functionality has been degraded, this should be known and the consequences understood;
 - (f) radio signals not associated with the intended flight profile (e.g. ILS glide path transmissions from an adjacent runway) may cause false alerts;
 - (g) inaccurate or low accuracy aircraft position data could lead to false or non-annunciation of terrain or obstacles ahead of the aircraft; and
 - (h) minimum equipment list (MEL) restrictions should be applied in the event of the TAWS becoming partially or completely unserviceable. (It should be noted that basic GPWS has no forward-looking capability.)
- (E) TAWS inhibits. Objective: to verify that the pilot is aware of the conditions under which certain functions of a TAWS are inhibited. Criteria: the pilot should demonstrate knowledge and an understanding of the various TAWS inhibits, including the following means of:
- (a) silencing voice alerts;
 - (b) inhibiting ILS glide path signals (as may be required when executing an ILS back beam approach);
 - (c) inhibiting flap position sensors (as may be required when executing an approach with the flaps not in a normal position for landing);
 - (d) inhibiting the FLTA and PDA functions; and
 - (e) selecting or deselecting the display of terrain information, together with appropriate annunciation of the status of each selection.

- (2) Operating procedures. The pilot should demonstrate the knowledge required to operate TAWS avionics and to interpret the information presented by a TAWS. This training should address the following topics:
- (i) Use of controls. Objective: to verify that the pilot can properly operate all TAWS controls and inhibits. Criteria: the pilot should demonstrate the proper use of controls, including the following means by which:
 - (A) before flight, any equipment self-test functions can be initiated;
 - (B) TAWS information can be selected for display; and
 - (C) all TAWS inhibits can be operated and what the consequent annunciations mean with regard to loss of functionality.
 - (ii) Display interpretation. Objective: to verify that the pilot understands the meaning of all information that can be annunciated or displayed by a TAWS. Criteria: the pilot should demonstrate the ability to properly interpret information annunciated or displayed by a TAWS, including the following:
 - (A) knowledge of all visual and aural indications that may be seen or heard;
 - (B) response required on receipt of a caution;
 - (C) response required on receipt of a warning; and
 - (D) response required on receipt of a notification that partial or total failure of the TAWS has occurred (including annunciation that the present aircraft position is of low accuracy).
 - (iii) Use of basic GPWS or use of the FLTA function only. Objective: to verify that the pilot understands what functionality will remain following loss of the GPWS or of the FLTA function. Criteria: the pilot should demonstrate knowledge of how to recognise the following:
 - (A) un-commanded loss of the GPWS function, or how to isolate this function and how to recognise the level of the remaining controlled flight into terrain (CFIT) protection (essentially, this is the FLTA function); and
 - (B) un-commanded loss of the FLTA function, or how to isolate this function and how to recognise the level of the remaining CFIT protection (essentially, this is the basic GPWS).
 - (iv) Crew coordination. Objective: to verify that the pilot adequately briefs other flight crew members on how TAWS alerts will be handled. Criteria: the pilot should demonstrate that the pre-flight briefing addresses procedures that will be used in preparation for responding to TAWS cautions and warnings, including the following:
 - (A) the action to be taken, and by whom, in the event that a TAWS caution and/or warning is issued; and
 - (B) how multi-function displays will be used to depict TAWS information at take-off, in the cruise and for the descent, approach, landing (and any missed approach). This will be in accordance with procedures specified by the operator, who will recognise that it may be more desirable that other data is displayed at certain phases of flight and that the terrain display has an automatic 'pop-up' mode in the event that an alert is issued.

- (v) Reporting rules. Objective: to verify that the pilot is aware of the rules for reporting alerts to the controller and other authorities. Criteria: the pilot should demonstrate knowledge of the following:
 - (A) when, following recovery from a TAWS alert or caution, a transmission of information should be made to the appropriate ATC unit; and
 - (B) the type of written report that is required, how it is to be compiled and whether any cross-reference should be made in the aircraft technical log and/or voyage report (in accordance with procedures specified by the operator), following a flight in which the aircraft flight path has been modified in response to a TAWS alert, or if any part of the equipment appears not to have functioned correctly.
- (vi) Alert thresholds. Objective: to demonstrate knowledge of the criteria for issuing cautions and warnings. Criteria: the pilot should be able to demonstrate an understanding of the methodology used by a TAWS to issue cautions and warnings and the general criteria for the issuance of these alerts, including awareness of the following:
 - (A) modes associated with basic GPWS, including the input data associated with each; and
 - (B) visual and aural annunciations that can be issued by TAWS and how to identify which are cautions and which are warnings.
- (3) TAWS manoeuvre training. The pilot should demonstrate the knowledge required to respond correctly to TAWS cautions and warnings. This training should address the following topics:
 - (i) Response to cautions:
 - (A) Objective: to verify that the pilot properly interprets and responds to cautions. Criteria: the pilot should demonstrate an understanding of the need, without delay:
 - (a) to initiate action required to correct the condition that has caused the TAWS to issue the caution and to be prepared to respond to a warning, if this should follow; and
 - (b) if a warning does not follow the caution, to notify the controller of the new position, heading and/or altitude/flight level of the aircraft, and what the pilot-in-command intends to do next.
 - (B) The correct response to a caution might require the pilot to:
 - (a) reduce a rate of descent and/or to initiate a climb;
 - (b) regain an ILS glide path from below, or to inhibit a glide path signal if an ILS is not being flown;
 - (c) select more flap, or to inhibit a flap sensor if the landing is being conducted with the intent that the normal flap setting will not be used;
 - (d) select gear down; and/or
 - (e) initiate a turn away from the terrain or obstacle ahead and towards an area free of such obstructions if a forward-looking terrain display

indicates that this would be a good solution and the entire manoeuvre can be carried out in clear visual conditions.

- (ii) Response to warnings. Objective: to verify that the pilot properly interprets and responds to warnings. Criteria: the pilot should demonstrate an understanding of the following:
 - (A) The need, without delay, to initiate a climb in the manner specified by the operator.
 - (B) The need, without delay, to maintain the climb until visual verification can be made that the aircraft will clear the terrain or obstacle ahead or until above the appropriate sector safe altitude (if certain about the location of the aircraft with respect to terrain) even if the TAWS warning stops. If, subsequently, the aircraft climbs up through the sector safe altitude, but the visibility does not allow the flight crew to confirm that the terrain hazard has ended, checks should be made to verify the location of the aircraft and to confirm that the altimeter subscale settings are correct.
 - (C) When workload permits, that the flight crew should notify the air traffic controller of the new position and altitude/flight level and what the pilot-in-command intends to do next.
 - (D) That the manner in which the climb is made should reflect the type of aircraft and the method specified by the aircraft manufacturer (which should be reflected in the operations manual) for performing the escape manoeuvre. Essential aspects will include the need for an increase in pitch attitude, selection of maximum thrust, confirmation that external sources of drag (e.g. spoilers/speed brakes) are retracted and respect of the stick shaker or other indication of eroded stall margin.
 - (E) That TAWS warnings should never be ignored. However, the pilot's response may be limited to that which is appropriate for a caution, only if:
 - (a) the aircraft is being operated by day in clear, visual conditions; and
 - (b) it is immediately clear to the pilot that the aircraft is in no danger in respect of its configuration, proximity to terrain or current flight path.
- (4) TAWS initial evaluation:
 - (i) The flight crew member's understanding of the academic training items should be assessed by means of a written test.
 - (ii) The flight crew member's understanding of the manoeuvre training items should be assessed in a flight simulation training device (FSTD) equipped with TAWS visual and aural displays and inhibit selectors similar in appearance and operation to those in the aircraft that the pilot will fly. The results should be assessed by a flight simulation training instructor, synthetic flight examiner, type rating instructor or type rating examiner.
 - (iii) The range of scenarios should be designed to give confidence that proper and timely responses to TAWS cautions and warnings will result in the aircraft avoiding a CFIT accident. To achieve this objective, the pilot should demonstrate taking the correct action to prevent a caution developing into a warning and, separately, the escape manoeuvre needed in response to a warning. These demonstrations should take place when the external visibility is zero, though there is much to be learnt if,

initially, the training is given in 'mountainous' or 'hilly' terrain with clear visibility. This training should comprise a sequence of scenarios, rather than be included in line orientated flight training (LOFT).

- (iv) A record should be made, after the pilot has demonstrated competence, of the scenarios that were practised.
- (5) TAWS recurrent training:
- (i) TAWS recurrent training ensures that pilots maintain the appropriate TAWS knowledge and skills. In particular, it reminds pilots of the need to act promptly in response to cautions and warnings and of the unusual attitude associated with flying the escape manoeuvre.
 - (ii) An essential item of recurrent training is the discussion of any significant issues and operational concerns that have been identified by the operator. Recurrent training should also address changes to TAWS logic, parameters or procedures and to any unique TAWS characteristics of which pilots should be aware.
- (6) Reporting procedures:
- (i) Verbal reports. Verbal reports should be made promptly to the appropriate ATC unit:
 - (A) whenever any manoeuvre has caused the aircraft to deviate from an air traffic clearance;
 - (B) when, following a manoeuvre that has caused the aircraft to deviate from an air traffic clearance, the aircraft has returned to a flight path that complies with the clearance; and/or
 - (C) when an air traffic control unit issues instructions that, if followed, would cause the pilot to manoeuvre the aircraft towards terrain or obstacle or it would appear from the display that a potential CFIT occurrence is likely to result.
 - (ii) Written reports. Written reports should be submitted in accordance with the operator's occurrence reporting scheme and they also should be recorded in the aircraft technical log:
 - (A) whenever the aircraft flight path has been modified in response to a TAWS alert (false, nuisance or genuine);
 - (B) whenever a TAWS alert has been issued and is believed to have been false; and/or
 - (C) if it is believed that a TAWS alert should have been issued, but was not.
 - (iii) Within this GM, and with regard to reports:
 - (A) the term 'false' means that the TAWS issued an alert that could not possibly be justified by the position of the aircraft in respect to terrain and it is probable that a fault or failure in the system (equipment and/or input data) was the cause;
 - (B) the term 'nuisance' means that the TAWS issued an alert that was appropriate, but was not needed because the flight crew could determine by independent means that the flight path was, at that time, safe;

- (C) the term 'genuine' means that the TAWS issued an alert that was both appropriate and necessary;
- (D) the report terms described in (c)(6)(iii) are only meant to be assessed after the occurrence is over, to facilitate subsequent analysis, the adequacy of the equipment and the programmes it contains. The intention is not for the flight crew to attempt to classify an alert into any of these three categories when visual and/or aural cautions or warnings are annunciated.

NCC.OP.220 Airborne collision avoidance system (ACAS)

Regulation (EU) 2016/1199

The operator shall establish operational procedures and training programs when ACAS is installed and serviceable so that the flight crew is appropriately trained in the avoidance of collisions and competent in the use of ACAS II equipment.

GM1 NCC.OP.220 Airborne collision avoidance system (ACAS)

ED Decision 2019/019/R

GENERAL

- (a) The ACAS operational procedures and training programmes established by the operator should take into account this Guidance Material. It incorporates advice contained in:
 - (1) ICAO Annex 10, Volume IV;
 - (2) ICAO Doc 8168 (PANS-OPS), Volume III; and
 - (3) ICAO PANS-ATM.
- (b) Additional guidance material on ACAS may be referred to, including information available from such sources as EUROCONTROL.

ACAS FLIGHT CREW TRAINING

- (c) During the implementation of ACAS, several operational issues were identified that had been attributed to deficiencies in flight crew training programmes. As a result, the issue of flight crew training has been discussed within the ICAO, which has developed guidelines for operators to use when designing training programmes.
- (d) This Guidance Material contains performance-based training objectives for ACAS II flight crew training. Information contained here related to traffic advisories (TAs) is also applicable to ACAS I and ACAS II users. The training objectives cover five areas: theory of operation; pre-flight operations; general in-flight operations; response to TAs; and response to resolution advisories (RAs).
- (e) The information provided is valid for version 7 and 7.1 (ACAS II). Where differences arise, these are identified.
- (f) The performance-based training objectives are further divided into the areas of: academic training; manoeuvre training; initial evaluation and recurrent qualification. Under each of these four areas, the training material has been separated into those items which are considered essential training items and those which are considered desirable. In each area, objectives and acceptable performance criteria are defined.

(g) ACAS academic training

(1) This training is typically conducted in a classroom environment. The knowledge demonstrations specified in this section may be completed through the successful completion of written tests or through providing correct responses to non-real-time computer-based training (CBT) questions.

(2) Essential items

(i) Theory of operation. The flight crew member should demonstrate an understanding of ACAS II operation and the criteria used for issuing TAs and RAs. This training should address the following topics:

(A) System operation

Objective: to demonstrate knowledge of how ACAS functions.

Criteria: the flight crew member should demonstrate an understanding of the following functions:

(a) Surveillance

(1) ACAS interrogates other transponder-equipped aircraft within a nominal range of 14 NM.

(2) ACAS surveillance range can be reduced in geographic areas with a large number of ground interrogators and/or ACAS II-equipped aircraft.

(3) If the operator's ACAS implementation provides for the use of the Mode S extended squitter, the normal surveillance range may be increased beyond the nominal 14 NM. However, this information is not used for collision avoidance purposes.

(b) Collision avoidance

(1) TAs can be issued against any transponder-equipped aircraft that responds to the ICAO Mode C interrogations, even if the aircraft does not have altitude reporting capability.

(2) RAs can be issued only against aircraft that are reporting altitude and in the vertical plane only.

(3) RAs issued against an ACAS-equipped intruder are co-ordinated to ensure complementary RAs are issued.

(4) Failure to respond to an RA deprives own aircraft of the collision protection provided by own ACAS.

(5) Additionally, in ACAS-ACAS encounters, failure to respond to an RA also restricts the choices available to the other aircraft's ACAS and thus renders the other aircraft's ACAS less effective than if own aircraft were not ACAS equipped.

(B) Advisory thresholds

Objective: to demonstrate knowledge of the criteria for issuing TAs and RAs.

Criteria: the flight crew member should demonstrate an understanding of the methodology used by ACAS to issue TAs and RAs and the general criteria for the issuance of these advisories, including the following:

- (a) ACAS advisories are based on time to closest point of approach (CPA) rather than distance. The time should be short and vertical separation should be small, or projected to be small, before an advisory can be issued. The separation standards provided by ATS are different from the miss distances against which ACAS issues alerts.
 - (b) Thresholds for issuing a TA or an RA vary with altitude. The thresholds are larger at higher altitudes.
 - (c) A TA occurs from 15 to 48 seconds and an RA from 15 to 35 seconds before the projected CPA.
 - (d) RAs are chosen to provide the desired vertical miss distance at CPA. As a result, RAs can instruct a climb or descent through the intruder aircraft's altitude.
- (C) ACAS limitations

Objective: to verify that the flight crew member is aware of the limitations of ACAS.

Criteria: the flight crew member should demonstrate knowledge and understanding of ACAS limitations, including the following:

- (a) ACAS will neither track nor display non-transponder-equipped aircraft, nor aircraft not responding to ACAS Mode C interrogations.
- (b) ACAS will automatically fail if the input from the aircraft's barometric altimeter, radio altimeter or transponder is lost.
 - (1) In some installations, the loss of information from other on board systems such as an inertial reference system (IRS) or attitude heading reference system (AHRS) may result in an ACAS failure. Individual operators should ensure that their flight crews are aware of the types of failure which will result in an ACAS failure.
 - (2) ACAS may react in an improper manner when false altitude information is provided to own ACAS or transmitted by another aircraft. Individual operators should ensure that their flight crew are aware of the types of unsafe conditions which can arise. Flight crew members should ensure that when they are advised, if their own aircraft is transmitting false altitude reports, an alternative altitude reporting source is selected, or altitude reporting is switched off.
- (c) Some aeroplanes within 380 ft above ground level (AGL) (nominal value) are deemed to be 'on ground' and will not be displayed. If ACAS is able to determine an aircraft below this altitude is airborne, it will be displayed.
- (d) ACAS may not display all proximate transponder-equipped aircraft in areas of high density traffic.
- (e) The bearing displayed by ACAS is not sufficiently accurate to support the initiation of horizontal manoeuvres based solely on the traffic display.

- (f) ACAS will neither track nor display intruders with a vertical speed in excess of 10 000 ft/min. In addition, the design implementation may result in some short-term errors in the tracked vertical speed of an intruder during periods of high vertical acceleration by the intruder.
 - (g) Ground proximity warning systems/ground collision avoidance systems (GPWS/GCASs) warnings and wind shear warnings take precedence over ACAS advisories. When either a GPWS/GCAS or wind shear warning is active, ACAS aural annunciations will be inhibited and ACAS will automatically switch to the 'TA only' mode of operation.
- (D) ACAS inhibits
- Objective: to verify that the flight crew member is aware of the conditions under which certain functions of ACAS are inhibited.
- Criteria: the flight crew member should demonstrate knowledge and understanding of the various ACAS inhibits, including the following:
- (a) 'Increase Descent' RAs are inhibited below 1 450 ft AGL.
 - (b) 'Descend' RAs are inhibited below 1 100 ft AGL.
 - (c) All RAs are inhibited below 1 000 ft AGL.
 - (d) All TA aural annunciations are inhibited below 500 ft AGL.
 - (e) Altitude and configuration under which 'Climb' and 'Increase Climb' RAs are inhibited. ACAS can still issue 'Climb' and 'Increase Climb' RAs when operating at the aeroplane's certified ceiling. (In some aircraft types, 'Climb' or 'Increase Climb' RAs are never inhibited.)
- (ii) Operating procedures
- The flight crew member should demonstrate the knowledge required to operate the ACAS avionics and interpret the information presented by ACAS. This training should address the following:
- (A) Use of controls
- Objective: to verify that the pilot can properly operate all ACAS and display controls.
- Criteria: demonstrate the proper use of controls, including the following:
- (a) Aircraft configuration required to initiate a self-test.
 - (b) Steps required to initiate a self-test.
 - (c) Recognising when the self-test was successful and when it was unsuccessful. When the self-test is unsuccessful, recognising the reason for the failure and, if possible, correcting the problem.
 - (d) Recommended usage of range selection. Low ranges are used in the terminal area and the higher display ranges are used in the en-route environment and in the transition between the terminal and en-route environment.
 - (e) Recognising that the configuration of the display does not affect the ACAS surveillance volume.

- (f) Selection of lower ranges when an advisory is issued, to increase display resolution.
- (g) Proper configuration to display the appropriate ACAS information without eliminating the display of other needed information.
- (h) If available, recommended usage of the above/below mode selector. The above mode should be used during climb and the below mode should be used during descent.
- (i) If available, proper selection of the display of absolute or relative altitude and the limitations of using this display if a barometric correction is not provided to ACAS.

(B) Display interpretation

Objective: to verify that the flight crew member understands the meaning of all information that can be displayed by ACAS. The wide variety of display implementations require the tailoring of some criteria. When the training programme is developed, these criteria should be expanded to cover details for the operator's specific display implementation.

Criteria: the flight crew member should demonstrate the ability to properly interpret information displayed by ACAS, including the following:

- (a) Other traffic, i.e. traffic within the selected display range that is not proximate traffic, or causing a TA or RA to be issued.
- (b) Proximate traffic, i.e. traffic that is within 6 NM and $\pm 1\ 200$ ft.
- (c) Non-altitude reporting traffic.
- (d) No bearing TAs and RAs.
- (e) Off-scale TAs and RAs: the selected range should be changed to ensure that all available information on the intruder is displayed.
- (f) TAs: the minimum available display range that allows the traffic to be displayed should be selected, to provide the maximum display resolution.
- (g) RAs (traffic display): the minimum available display range of the traffic display that allows the traffic to be displayed should be selected, to provide the maximum display resolution.
- (h) RAs (RA display): flight crew members should demonstrate knowledge of the meaning of the red and green areas or the meaning of pitch or flight path angle cues displayed on the RA display. Flight crew members should also demonstrate an understanding of the RA display limitations, i.e. if a vertical speed tape is used and the range of the tape is less than 2 500 ft/min, an increase rate RA cannot be properly displayed.
- (i) If appropriate, awareness that navigation displays oriented on 'Track-Up' may require a flight crew member to make a mental adjustment for drift angle when assessing the bearing of proximate traffic.

(C) Use of the TA only mode

Objective: to verify that a flight crew member understands the appropriate times to select the TA only mode of operation and the limitations associated with using this mode.

Criteria: the flight crew member should demonstrate the following:

- (a) Knowledge of the operator's guidance for the use of TA only.
- (b) Reasons for using this mode. If TA only is not selected when an airport is conducting simultaneous operations from parallel runways separated by less than 1 200 ft, and to some intersecting runways, RAs can be expected. If, for any reason, TA only is not selected and an RA is received in these situations, the response should comply with the operator's approved procedures.
- (c) All TA aural annunciations are inhibited below 500 ft AGL. As a result, TAs issued below 500 ft AGL may not be noticed unless the TA display is included in the routine instrument scan.

(D) Crew coordination

Objective: to verify that the flight crew member understands how ACAS advisories will be handled.

Criteria: the flight crew member should demonstrate knowledge of the crew procedures that should be used when responding to TAs and RAs, including the following:

- (a) task sharing between the pilot flying and the pilot monitoring;
- (b) expected call-outs; and
- (c) communications with ATC.

(E) Phraseology rules

Objective: to verify that the flight crew member is aware of the rules for reporting RAs to the controller.

Criteria: the flight crew member should demonstrate the following:

- (a) the use of the phraseology contained in ICAO PANS-OPS;
- (b) an understanding of the procedures contained in ICAO PANS-ATM and ICAO Annex 2; and
- (c) the understanding that verbal reports should be made promptly to the appropriate ATC unit:
 - (1) whenever any manoeuvre has caused the aeroplane to deviate from an air traffic clearance;
 - (2) when, subsequent to a manoeuvre that has caused the aeroplane to deviate from an air traffic clearance, the aeroplane has returned to a flight path that complies with the clearance; and/or

- (3) when air traffic issue instructions that, if followed, would cause the crew to manoeuvre the aircraft contrary to an RA with which they are complying.

(F) Reporting rules

Objective: to verify that the flight crew member is aware of the rules for reporting RAs to the operator.

Criteria: the flight crew member should demonstrate knowledge of where information can be obtained regarding the need for making written reports to various States when an RA is issued. Various States have different reporting rules and the material available to the flight crew member should be tailored to the operator's operating environment. This responsibility is satisfied by the flight crew member reporting to the operator according to the applicable reporting rules.

(3) Non-essential items: advisory thresholds

Objective: to demonstrate knowledge of the criteria for issuing TAs and RAs.

Criteria: the flight crew member should demonstrate an understanding of the methodology used by ACAS to issue TAs and RAs and the general criteria for the issuance of these advisories, including the following:

- (i) The minimum and maximum altitudes below/above which TAs will not be issued.
- (ii) When the vertical separation at CPA is projected to be less than the ACAS-desired separation, a corrective RA that requires a change to the existing vertical speed will be issued. This separation varies from 300 ft at low altitude to a maximum of 700 ft at high altitude.
- (iii) When the vertical separation at CPA is projected to be just outside the ACAS-desired separation, a preventive RA that does not require a change to the existing vertical speed will be issued. This separation varies from 600 to 800 ft.
- (iv) RA fixed range thresholds vary between 0.2 and 1.1 NM.

(h) ACAS manoeuvre training

- (1) Demonstration of the flight crew member's ability to use ACAS displayed information to properly respond to TAs and RAs should be carried out in a full flight simulator equipped with an ACAS display and controls similar in appearance and operation to those in the aircraft. If a full flight simulator is utilised, crew resource management (CRM) should be practised during this training.
- (2) Alternatively, the required demonstrations can be carried out by means of an interactive CBT with an ACAS display and controls similar in appearance and operation to those in the aircraft. This interactive CBT should depict scenarios in which real-time responses should be made. The flight crew member should be informed whether or not the responses made were correct. If the response was incorrect or inappropriate, the CBT should show what the correct response should be.
- (3) The scenarios included in the manoeuvre training should include: corrective RAs; initial preventive RAs; maintain rate RAs; altitude crossing RAs; increase rate RAs; RA reversals; weakening RAs; and multi-aircraft encounters. The consequences of failure to respond correctly should be demonstrated by reference to actual incidents such as those publicised in EUROCONTROL ACAS II Bulletins (available on the EUROCONTROL website).

(i) TA responses

Objective: to verify that the pilot properly interprets and responds to TAs.

Criteria: the pilot should demonstrate the following:

- (A) Proper division of responsibilities between the pilot flying and the pilot monitoring. The pilot flying should fly the aircraft using any type-specific procedures and be prepared to respond to any RA that might follow. For aircraft without an RA pitch display, the pilot flying should consider the likely magnitude of an appropriate pitch change. The pilot monitoring should provide updates on the traffic location shown on the ACAS display, using this information to help visually acquire the intruder.
- (B) Proper interpretation of the displayed information. Flight crew members should confirm that the aircraft they have visually acquired is that which has caused the TA to be issued. Use should be made of all information shown on the display, note being taken of the bearing and range of the intruder (amber circle), whether it is above or below (data tag), and its vertical speed direction (trend arrow).
- (C) Other available information should be used to assist in visual acquisition, including ATC 'party-line' information, traffic flow in use, etc.
- (D) Because of the limitations described, the pilot flying should not manoeuvre the aircraft based solely on the information shown on the ACAS display. No attempt should be made to adjust the current flight path in anticipation of what an RA would advise, except that if own aircraft is approaching its cleared level at a high vertical rate with a TA present, vertical rate should be reduced to less than 1 500 ft/min.
- (E) When visual acquisition is attained, and as long as no RA is received, normal right of way rules should be used to maintain or attain safe separation. No unnecessary manoeuvres should be initiated. The limitations of making manoeuvres based solely on visual acquisition, especially at high altitude or at night, or without a definite horizon should be demonstrated as being understood.

(ii) RA responses

Objective: to verify that the pilot properly interprets and responds to RAs.

Criteria: the pilot should demonstrate the following:

- (A) Proper response to the RA, even if it is in conflict with an ATC instruction and even if the pilot believes that there is no threat present.
- (B) Proper task sharing between the pilot flying and the pilot monitoring. The pilot flying should respond to a corrective RA with appropriate control inputs. The pilot monitoring should monitor the response to the RA and should provide updates on the traffic location by checking the traffic display. Proper CRM should be used.
- (C) Proper interpretation of the displayed information. The pilot should recognise the intruder causing the RA to be issued (red square on display). The pilot should respond appropriately.

- (D) For corrective RAs, the response should be initiated in the proper direction within 5 seconds of the RA being displayed. The change in vertical speed should be accomplished with an acceleration of approximately $\frac{1}{4}$ g (gravitational acceleration of 9.81 m/sec^2).
- (E) Recognition of the initially displayed RA being modified. Response to the modified RA should be properly accomplished, as follows:
 - (a) For increase rate RAs, the vertical speed change should be started within $2\frac{1}{2}$ seconds of the RA being displayed. The change in vertical speed should be accomplished with an acceleration of approximately $\frac{1}{3}$ g.
 - (b) For RA reversals, the vertical speed reversal should be started within $2\frac{1}{2}$ seconds of the RA being displayed. The change in vertical speed should be accomplished with an acceleration of approximately $\frac{1}{3}$ g.
 - (c) For RA weakenings, the vertical speed should be modified to initiate a return towards the original clearance.
 - (d) An acceleration of approximately $\frac{1}{4}$ g will be achieved if the change in pitch attitude corresponding to a change in vertical speed of 1 500 ft/min is accomplished in approximately 5 seconds, and of $\frac{1}{3}$ g if the change is accomplished in approximately 3 seconds. The change in pitch attitude required to establish a rate of climb or descent of 1 500 ft/min from level flight will be approximately 6° when the true airspeed (TAS) is 150 kt, 4° at 250 kt, and 2° at 500 kt. (These angles are derived from the formula: 1 000 divided by TAS.)
- (F) Recognition of altitude crossing encounters and the proper response to these RAs.
- (G) For preventive RAs, the vertical speed needle or pitch attitude indication should remain outside the red area on the RA display.
- (H) For maintain rate RAs, the vertical speed should not be reduced. Pilots should recognise that a maintain rate RA may result in crossing through the intruder's altitude.
- (I) When the RA weakens, or when the green 'fly to' indicator changes position, the pilot should initiate a return towards the original clearance, and when 'clear of conflict' is annunciated, the pilot should complete the return to the original clearance.
- (J) The controller should be informed of the RA as soon as time and workload permit, using the standard phraseology.
- (K) When possible, an ATC clearance should be complied with while responding to an RA. For example, if the aircraft can level at the assigned altitude while responding to RA (an 'adjust vertical speed' RA (version 7) or 'level off' (version 7.1)), it should be done; the horizontal (turn) element of an ATC instruction should be followed.
- (L) Knowledge of the ACAS multi-aircraft logic and its limitations, and that ACAS can optimise separations from two aircraft by climbing or descending towards one of them. For example, ACAS only considers intruders that it considers to be a threat when selecting an RA. As such, it is possible for ACAS

to issue an RA against one intruder that results in a manoeuvre towards another intruder that is not classified as a threat. If the second intruder becomes a threat, the RA will be modified to provide separation from that intruder.

- (i) ACAS initial evaluation
 - (1) The flight crew member's understanding of the academic training items should be assessed by means of a written test or interactive CBT that records correct and incorrect responses to phrased questions.
 - (2) The flight crew member's understanding of the manoeuvre training items should be assessed in a full flight simulator equipped with an ACAS display and controls similar in appearance and operation to those in the aircraft the flight crew member will fly, and the results assessed by a qualified instructor, inspector, or check airman. The range of scenarios should include: corrective RAs; initial preventive RAs; maintain rate RAs; altitude crossing RAs; increase rate RAs; RA reversals; weakening RAs; and multi-threat encounters. The scenarios should also include demonstrations of the consequences of not responding to RAs, slow or late responses, and manoeuvring opposite to the direction called for by the displayed RA.
 - (3) Alternatively, exposure to these scenarios can be conducted by means of an interactive CBT with an ACAS display and controls similar in appearance and operation to those in the aircraft the pilot will fly. This interactive CBT should depict scenarios in which real-time responses should be made and a record made of whether or not each response was correct.
- (j) ACAS recurrent training
 - (1) ACAS recurrent training ensures that flight crew members maintain the appropriate ACAS knowledge and skills. ACAS recurrent training should be integrated into and/or conducted in conjunction with other established recurrent training programmes. An essential item of recurrent training is the discussion of any significant issues and operational concerns that have been identified by the operator. Recurrent training should also address changes to ACAS logic, parameters or procedures and to any unique ACAS characteristics which flight crew members should be made aware of.
 - (2) It is recommended that operator's recurrent training programmes using full flight simulators include encounters with conflicting traffic when these simulators are equipped with ACAS. The full range of likely scenarios may be spread over a 2 year period. If a full flight simulator, as described above, is not available, use should be made of an interactive CBT that is capable of presenting scenarios to which pilot responses should be made in real-time.

NCC.OP.225 Approach and landing conditions — aeroplanes and helicopters

Regulation (EU) 2021/2237

- (a) the meteorological conditions at the aerodrome or the operating site and the condition of the runway/FATO intended to be used will not prevent a safe approach, landing or go-around, considering the performance information contained in the operations manual; and

- (b) the selected aerodrome operating minima are consistent with all of the following:
 - (1) the operative ground equipment;
 - (2) the operative aircraft systems;
 - (3) the aircraft performance; and
 - (4) flight crew qualifications.

AMC1 NCC.OP.225 Approach and landing conditions — aeroplanes

ED Decision 2021/005/R

LANDING DISTANCE ASSESSMENT

- (a) The in-flight landing distance assessment should be based on the latest available weather report and runway condition report (RCR).
- (b) The assessment should be initially carried out when the weather report and the RCR are obtained, usually around top of descent. If the planned duration of the flight does not allow to carry out the assessment in non-critical phases of flight, the assessment should be carried out before departure.
- (c) When meteorological conditions may lead to a degradation of the runway surface condition, the assessment should include consideration of how much deterioration in runway surface friction characteristics may be tolerated, so that a quick decision can be made prior to landing.
- (d) The flight crew should monitor the evolution of the actual conditions during the approach, to ensure that they do not degrade below the condition that was previously determined to be the minimum acceptable.
- (e) The in-flight determination of the landing distance should be done in such way that either:
 - (1) the landing distance available (LDA) on the intended runway is at least 115 % of the landing distance at the estimated time of landing, determined in accordance with the performance information for the assessment of the landing distance at time of arrival (LDTA); or
 - (2) if performance information for the assessment of the LDTA is not available, the LDA on the intended runway at the estimated time of landing is at least the landing distance determined at the time of dispatch.
- (f) If performance information for the assessment of the LDTA is available, it should be based on approved data contained in the AFM, or on other data that is either determined in accordance with the applicable certification standards for aeroplanes or determined by the Agency.
- (g) Whenever the runway braking action encountered during the landing roll is not as good as reported by the aerodrome operator in the RCR, the pilot-in-command should notify the air traffic services (ATS) by means of a special air-report (AIREP) as soon as practicable.

GM1 NCC.OP.225 Approach and landing conditions — aeroplanes

ED Decision 2021/005/R

LANDING DISTANCE

The assessment of the LDTA begins with the acquisition of the latest available weather information and the RCR. The information provided in the RCR is divided in two sections:

- (a) The ‘aircraft performance’ section which contains information that is directly relevant in a performance computation.
- (b) The ‘situational awareness’ section which contains information that the flight crew should be aware of for a safe operation, but which does not have a direct impact on the performance assessment.

The ‘aircraft performance’ section of the RCR includes a runway condition code (RWYCC), the contaminant type, depth and coverage for each third of the runway.

The determination of the RWYCC is based on the use of the runway condition assessment matrix (RCAM); however, the presentation of the information in the RCAM is appropriate for use by aerodrome personnel trained and competent in assessing the runway condition in a way that is relevant to aircraft performance. While full implementation of the RCAM standard would eventually no longer require the flight crew to derive from various information available to them the appropriate runway condition to be used for the landing performance assessment at the time of arrival, it is desirable that pilots maintain an understanding of the performance effect of various components considered in the assessment.

It is the task of the aerodrome personnel to assess the appropriate RWYCC in order to allow the flight crew to assess any potential change of the runway in use. When no RWYCC is available in winter conditions, the RCAM provides the flight crew with a combination of the relevant information (runway surface conditions: state and/or contaminant or pilot report of braking action (AIREP)) in order to determine the RWYCC.

Table 1 below is an excerpt of the RCAM and permits to carry out the primary assessment based on the reported contaminant type and depth, as well as on the OAT.

Table 1: Association between the runway surface condition and the RWYCC based on the reported contaminant type and depth and OAT

Runway surface condition	Surface condition descriptor	Depth	Notes	RWYCC	
Dry		n/a		6	
Wet	Damp (any visible dampness)	3 mm or less	Including wet and contaminated runways below 25 % coverage in each runway third	5	
	Wet				
Slippery wet				3	
Contaminated	Compacted snow	Any	At or below OAT – 15 °C ³	4	
			Above OAT – 15 °C ³	3	
	Dry snow	3 mm or less		5	
			More than 3 mm up to 100 mm	Including when any depth occurs on top of compacted snow	3
			Any	On top of ice	0 ²
	Frost ¹	Any		5	
	Ice	Any	In cold and dry conditions	1	
	Slush	3 mm or less		5	
		More than 3 mm up to 15 mm		2	
Standing water	3 mm or less		5		

		More than 3 mm up to 15 mm		2
		Any	On top of ice	0 ²
	Wet ice	Any		0 ²
	Wet snow	3 mm or less		5
		More than 3 mm up to 30 mm	Including when any depth occurs on top of compacted snow	3
		Any	On top of ice	0 ²

Note 1: Under certain conditions, frost may cause the surface to become very slippery.

Note 2: Operations in conditions where less-than-poor braking action prevails are prohibited.

Note 3: The runway surface temperature should preferably be used where available.

A primary assessment may have to be downgraded by the aerodrome operator based on an AIREP of lower braking action than the one typically associated with the type and depth of contaminant on the runway.

Upgrading a RWYCC 5, 4, 3 or 2 determined by the aerodrome operator from the observed contaminant type is not allowed.

A RWYCC 1 or 0 maybe be upgraded by the aerodrome operator to a maximum of RWYCC 3. The reason for the upgrade will be specified in the ‘situational awareness’ section of the RCR.

When the aerodrome operator is approved for operations on specially prepared winter runways, in accordance with Annex V (Part-ADR.OPS) to Regulation (EU) No 139/2014, the RWYCC of a runway that is contaminated with compacted snow or ice, may be upgraded to RWYCC 4 depending upon a specific treatment of the runway. In such cases, the reason for the upgrade will be specified in the ‘situational awareness’ section of the RCR.

GM2 NCC.OP.225 Approach and landing conditions — aeroplanes

ED Decision 2021/005/R

RCR, RWYCC and RCAM

A detailed description of the RCR format and content, the RWYCC and the RCAM may be found in Annex V (Part-ADR.OPS) to Regulation (EU) No 139/2014. Further guidance may be found in the following documents:

- (a) ICAO Doc 9981 ‘PANS Aerodromes’;
- (b) ICAO Doc 4444 ‘PANS ATM’;
- (c) ICAO Doc 10064 ‘Aeroplane Performance Manual’; and
- (d) ICAO Circular 355 ‘Assessment, Measurement and Reporting of Runway Surface Conditions’.

GM3 NCC.OP.225 Approach and landing conditions — aeroplanes

ED Decision 2021/005/R

PERFORMANCE INFORMATION FOR THE ASSESSMENT OF LDTA

Guidance on performance information for the assessment of the LDTA may be found in:

- (a) AMC1 CAT.OP.MPA.303(e) of the AMC & GM to Annex IV (Part CAT) to Regulation (EU) No 965/2012; and
- (b) ICAO Doc 10064 ‘Aeroplane Performance Manual’.

GM4 NCC.OP.225 Approach and landing conditions — aeroplanes

ED Decision 2021/005/R

REPORTING ON RUNWAY BRAKING ACTION

The role of the flight crew in the runway surface condition reporting process does not end once a safe landing has been achieved. While the aerodrome operator is responsible for generating the RCR, flight crew are responsible for providing accurate braking action reports.

The flight crew braking action reports provide feedback to the aerodrome operator regarding the accuracy of the RCR resulting from the observed runway surface conditions.

ATC passes these braking action reports to the aerodrome operator, which in turn uses them in conjunction with the RCAM to determine if it is necessary to downgrade or upgrade the Runway Condition Code (RWYCC).

During busy times, runway inspections and maintenance may be less frequent and need to be sequenced with arrivals. Therefore, aerodrome operators may depend on braking action reports to confirm that the runway surface condition is not deteriorating below the assigned RCR.

Since both the ATC and the aerodrome operator rely on accurate braking action reports, flight crew should use standardised terminology in accordance with ICAO Doc 4444 ‘PANS ATM’.

The following Table 1 shows the correlation between the terminology to be used in the AIREP to report the braking action and the RWYCC.

Table 1: Association between AIREP and RWYCC

AIREP (braking action)	Description	RWYCC
N/A		6
GOOD	Braking deceleration is normal for the wheel braking effort applied AND directional control is normal.	5
GOOD TO MEDIUM	Braking deceleration OR directional control is between good and medium.	4
MEDIUM	Braking deceleration is noticeably reduced for the wheel braking effort applied OR directional control is noticeably reduced.	3
MEDIUM TO POOR	Braking deceleration OR directional control is between medium and poor.	2
POOR	Braking deceleration is significantly reduced for the wheel braking effort applied OR directional control is significantly reduced.	1

LESS THAN POOR	Braking deceleration is minimal to non-existent for the wheel braking effort applied OR directional control is uncertain.	0
----------------	---	---

An AIREP should be transmitted to the ATC, in accordance with one of the following specifications, as applicable:

- (a) Good braking action is reported as 'BRAKING ACTION GOOD'.
- (b) Good to medium braking action is reported as 'BRAKING ACTION GOOD TO MEDIUM'.
- (c) Medium braking action is reported as 'BRAKING ACTION MEDIUM'.
- (d) Medium to poor braking action is reported as "BRAKING ACTION MEDIUM TO POOR"
- (e) Poor braking action is reported as 'BRAKING ACTION POOR'.
- (f) Less than poor braking action is reported as 'BRAKING ACTION LESS THAN POOR'.

In some cases, the differences between two consecutive levels of the six braking action categories between 'Good' and 'Less than Poor' may be too subtle for the flight crew to detect. It is therefore acceptable for the flight crew to report on a more coarse scale of 'Good', 'Medium' and 'Poor'.

Whenever requested by ATC, or if the braking action encountered during the landing roll is not as previously reported by the aerodrome operator in the RCR, pilots should provide a braking action report. This is especially important and safety relevant where the experienced braking action is worse than the braking action associated with any RWYCC code currently in effect for that portion of the runway concerned.

When the experienced braking action is better than that reported by the aerodrome operator, it is important to report this information, which may trigger further actions for the aerodrome operator in order to upgrade the RCR.

If an aircraft-generated braking action report is available, it should be transmitted, identifying its origin accordingly. If the flight crew have a reason to modify the aircraft-generated braking action report based on their judgement, the commander should be able to amend such report.

A braking action AIREP of 'Less Than Poor' leads to a runway closure until the aerodrome operator can improve the runway condition.

An air safety report should be submitted whenever flight safety has been endangered due to low braking action.

GM5 NCC.OP.225 Approach and landing conditions — aeroplanes

ED Decision 2021/005/R

FLIGHT CREW TRAINING

Flight crew should be trained on the use of the RCR, on the use of performance data for the assessment of the LDTA, if available, and on reporting braking action using the AIREP format.

Guidance on the development of the content of the training may be found in:

- (a) AMC1 CAT.OP.MPA.303 & CAT.OP.MPA.311 of the AMC & GM to Annex IV (Part CAT) to Regulation (EU) No 965/2012, as applicable to the intended operations;
- (b) ICAO Doc 10064 'Aeroplane Performance Manual'; and
- (c) ICAO Circular 355 'Assessment, Measurement and Reporting of Runway Surface Conditions'.

NCC.OP.226 Approach and landing conditions – helicopters

Regulation (EU) 2019/1387

Before commencing an approach to land, the pilot-in-command shall be satisfied that, according to the information available, the weather at the aerodrome or the operating site and the condition of the final approach and take-off area (FATO) intended to be used would not prevent a safe approach, landing or missed approach.

AMC1 NCC.OP.226 Approach and landing conditions — helicopters

ED Decision 2021/005/R

FATO SUITABILITY

The in-flight determination of the final approach and take-off area (FATO) suitability should be based on the latest available meteorological report.

NCC.OP.230 Commencement and continuation of approach

Regulation (EU) 2021/2237

- (a) For aeroplanes, if the reported visibility (VIS) or controlling RVR for the runway to be used for landing is less than the applicable minimum, then an instrument approach operation shall not be continued:
 - (1) past a point at which the aeroplane is 1 000 ft above the aerodrome elevation; or
 - (2) into the final approach segment (FAS) if the DH or MDH is higher than 1 000 ft.
- (b) For helicopters, if the reported RVR is less than 550 m and the controlling RVR for the runway to be used for landing is less than the applicable minimum, then an instrument approach operation shall not be continued:
 - (1) past a point at which the helicopter is 1 000 ft above the aerodrome elevation; or
 - (2) into the FAS if the DH or MDH is higher than 1 000 ft.
- (c) If the required visual reference is not established, a missed approach shall be executed at or before the DA/H or the MDA/H.
- (d) If the required visual reference is not maintained after DA/H or MDA/H, a go-around shall be executed promptly.
- (e) Notwithstanding point (a), in the case where no RVR is reported, and the reported VIS is less than the applicable minimum, but the converted meteorological visibility (CMV) is equal or greater than the applicable minimum, then the instrument approach can be continued to the DA/H or MDA/H.
- (f) Notwithstanding points (a) and (b), if there is no intention to land, the instrument approach may be continued to the DA/H or the MDA/H. A missed approach shall be executed at or before the DA/H or the MDA/H.

GM1 NCC.OP.230 Commencement and continuation of approach

ED Decision 2022/012/R

APPLICATION OF RVR OR VIS REPORTS — AEROPLANES

- (a) There is no prohibition on the commencement of an approach based on the reported RVR or VIS. The restriction in [NCC.OP.230](#) applies only if the RVR or VIS is reported and applies to the

continuation of the approach past a point where the aircraft is 1 000 ft above the aerodrome elevation or in the FAS, as applicable.

APPLICATION OF RVR OR VIS REPORTS — HELICOPTERS

- (b) There is no prohibition on the commencement of an approach based on the reported RVR. The restriction in [NCC.OP.230](#) applies to the continuation of the approach past a point where the aircraft is 1 000 ft above the aerodrome elevation or in the FAS, as applicable.

The prohibition to continue the approach applies only if the RVR is reported and is below 550 m and is below the operating minima. There is no prohibition based on VIS.

- (c) If the reported RVR is 550 m or greater, but it is less than the RVR calculated in accordance with [AMC5 CAT.OP.MPA.110](#), a go-around is likely to be necessary since visual reference may not be established at the DH or MDH. Similarly, in the absence of an RVR report, the reported visibility or a digital image may indicate that a go-around is likely. The pilot-in-command should consider available options, based on a thorough assessment of risk, such as diverting to an alternate, before commencing the approach.

APPLICATION OF RVR OR VIS REPORTS — ALL AIRCRAFT

- (d) If a deterioration in the RVR or VIS is reported once the aircraft is below 1 000 ft or in the FAS, as applicable, then there is no requirement for the approach to be discontinued. In this situation, the normal visual reference requirements would apply at the DA/H.
- (e) Where additional RVR information is provided (e.g. midpoint and stop end), this is advisory; such information may be useful to the pilot in order to determine whether there will be sufficient visual reference to control the aircraft during roll-out and taxi. For operations where the aircraft will be controlled manually during roll-out, Table 1 in [AMC1 SPA.LVO.100\(a\)](#) provides an indication of the RVR that may be required to allow manual lateral control of the aircraft on the runway.

AMC1 NCC.OP.230(a) Commencement and continuation of approach

ED Decision 2022/012/R

MINIMUM RVR FOR CONTINUATION OF APPROACH — AEROPLANES

- (a) The touchdown RVR should be the controlling RVR.
- (b) If the touchdown RVR is not reported, then the midpoint RVR should be the controlling RVR.
- (c) Where the RVR is not available, CMV should be used, except for the purpose of continuation of an approach in LVO in accordance with [AMC8 NCC.OP.110](#).

AMC1 NCC.OP.230(b) Commencement and continuation of approach

ED Decision 2022/012/R

MINIMUM RVR FOR CONTINUATION OF APPROACH — HELICOPTERS

- (a) The touchdown RVR should be the controlling RVR.
- (b) If the touchdown RVR is not reported, then the midpoint RVR should be the controlling RVR.

AMC1 NCC.OP.230(c) Commencement and continuation of approach

ED Decision 2022/012/R

VISUAL REFERENCES FOR INSTRUMENT APPROACH OPERATIONS

For instrument approach operations Type A and CAT I instrument approach operations Type B, at least one of the visual references specified below should be distinctly visible and identifiable to the pilot at the MDA/H or the DA/H:

- (a) elements of the approach lighting system;
- (b) the threshold;
- (c) the threshold markings;
- (d) the threshold lights;
- (e) the threshold identification lights;
- (f) the visual glide path indicator;
- (g) the TDZ or TDZ markings;
- (h) the TDZ lights;
- (i) the FATO/runway edge lights;
- (j) for helicopter PinS approaches, the identification beacon light and visual ground reference;
- (k) for helicopter PinS approaches, the identifiable elements of the environment defined on the instrument chart;
- (l) for helicopter PinS approaches with instructions to 'proceed VFR', sufficient visual cues to determine that VFR criteria are met; or
- (m) other visual references specified in the operations manual.

GM1 NCC.OP.230(f) Commencement and continuation of approach

ED Decision 2022/012/R

APPROACHES WITH NO INTENTION TO LAND

The approach may be continued to the DA/H or the MDA/H regardless of the reported RVR or VIS. Such operations should be coordinated with air traffic services (ATS).

NCC.OP.235 EFVS 200 operations

Regulation (EU) 2021/2237

- (a) An operator that intends to conduct EFVS 200 operations with operational credits and without a specific approval shall ensure that:
 - (1) the aircraft is certified for the intended operations;
 - (2) only runways, FATOs and IAPs suitable for EFVS operations are used;
 - (3) the flight crew members are competent to conduct the intended operation, and a training and checking programme for the flight crew members and relevant personnel involved in the flight preparation is established;
 - (4) operating procedures are established;
 - (5) any relevant information is documented in the minimum equipment list (MEL);

- (6) any relevant information is documented in the maintenance programme;
 - (7) safety assessments are carried out and performance indicators are established to monitor the level of safety of the operation; and
 - (8) the aerodrome operating minima take into account the capability of the system used.
- (b) The operator shall not conduct EFVS 200 operations when conducting LVOs.
- (c) Notwithstanding point (a)(1), the operator may use EVSs meeting the minimum criteria to conduct EFVS 200 operations, provided that this is approved by the competent authority.

GM1 NCC.OP.235 EFVS 200 operations

ED Decision 2022/012/R

GENERAL

- (a) EFVS operations exploit the improved visibility provided by the EFVS to extend the visual segment of an instrument approach. EFVSs cannot be used to extend the instrument segment of an approach and thus the DH for EFVS 200 operations is always the same as for the same approach conducted without EFVS.
- (b) Equipment for EFVS 200 operations
- (1) In order to conduct EFVS 200 operations, a certified EFVS is used (EFVS-A or EFVS-L). An EFVS is an enhanced vision system (EVS) that also incorporates a flight guidance system and displays the image on a HUD or equivalent display. The flight guidance system will incorporate aircraft flight information and flight symbology.
 - (2) In multi-pilot operations, a suitable display of EFVS sensory imagery is provided to the pilot monitoring.
- (c) Suitable approach procedures
- (1) Types of approach operation are specified in [AMC1 NCC.OP.235\(a\)\(2\)](#).
EFVS 200 operations are used for 3D approach operations. This may include operations based on NPA procedures, approach procedures with vertical guidance and PA procedures including approach operations requiring specific approvals, provided that the operator holds the necessary approvals.
 - (2) Offset approaches
Refer to [AMC1 NCC.OP.235\(a\)\(2\)](#).
 - (3) Circling approaches
EFVSs incorporate a HUD or an equivalent system so that the EFVS image of the scene ahead of the aircraft is visible in the pilot's forward external FOV. Circling operations require the pilot to maintain visual references that may not be directly ahead of the aircraft and may not be aligned with the current flight path. EFVSs cannot therefore be used in place of natural visual reference for circling approaches.
- (d) The aerodrome operating minima for EFVS 200 operations are determined in accordance with [AMC1 NCC.OP.235\(a\)\(8\)](#).
The performance of EFVSs depends on the technology used and weather conditions encountered. Table 1 'Operations utilising EFVS: RVR reduction' has been developed after an operational evaluation of two different EVSs, both using infrared sensors, along with data and support provided by the FAA. Approaches were flown in a variety of conditions including fog,

rain and snow showers, as well as at night to aerodromes located in mountainous terrain. Table 1 contains conservative figures to cater for the expected performance of infrared sensors in the variety of conditions that might be encountered. Some systems may have better capability than those used for the evaluation, but credit cannot be taken for such performance in EFVS 200 operations.

- (e) The conditions for commencement and continuation of the approach are in accordance with [NCC.OP.230](#).

Pilots conducting EFVS 200 operations may commence an approach and continue that approach below 1 000 ft above the aerodrome or into the FAS if the reported RVR or CMV is equal to or greater than the lowest RVR minima determined in accordance with [AMC1 NCC.OP.235\(a\)\(8\)](#) and if all the conditions for the conduct of EFVS 200 operations are met.

Should any equipment required for EFVS 200 operations be unserviceable or unavailable, the conditions to conduct EFVS 200 operations would not be satisfied, and the approach should not be commenced. In the event of failure of the equipment required for EFVS 200 operations after the aircraft descends below 1 000 ft above the aerodrome or into the FAS, the conditions of [NCC.OP.230](#) would no longer be satisfied unless the RVR reported prior to commencement of the approach was sufficient for the approach to be flown without the use of EFVS in lieu of natural vision.

- (f) The EFVS image requirements at the DA/H are specified in [AMC1 NCC.OP.235\(a\)\(4\)](#).

The requirements for features to be identifiable on the EFVS image in order to continue approach below the DH are more stringent than the visual reference requirements for the same approach flown without EFVS. The more stringent standard is needed because the EFVS might not display the colour of lights used to identify specific portions of the runway and might not consistently display the runway markings. Any visual approach path indicator using colour-coded lights may be unusable.

- (g) Obstacle clearance in the visual segment

The 'visual segment' is the portion of the approach between the DH or the MAPt and the runway threshold. In the case of EFVS 200 operations, this part of the approach may be flown using the EFVS image as the primary reference and obstacles may not always be identifiable on an EFVS image. The operational assessment specified in [AMC1 NCC.OP.235\(a\)\(2\)](#) is therefore required to ensure obstacle clearance during the visual segment.

- (h) Visual reference requirements at 200 ft above the threshold

For EFVS 200 operations, natural visual reference is required by a height of 200 ft above the runway threshold. The objective of this requirement is to ensure that the pilot will have sufficient visual reference to land. The visual reference should be the same as the one required for the same approach flown without the use of EFVS.

Some EFVSs may have additional requirements that have to be fulfilled at this height to allow the approach to continue, such as a requirement to check that elements of the EFVS display remain correctly aligned and scaled to the external view. Any such requirements will be detailed in the AFM and included in the operator's procedures.

- (i) Specific approval for EFVS

In order to use an EFVS without natural visual reference below 200 ft above the threshold, the operator needs to hold a specific approval in accordance with Part-SPA.

(j) Go-around

A go-around will be promptly executed if the required visual references are not maintained on the EFVS image at any time after the aircraft has descended below the DA/H or if the required visual references are not distinctly visible and identifiable using natural vision after the aircraft is below 200 ft. It is considered more likely that an EFVS 200 operation could result in the initiation of a go-around below the DA/H than the equivalent approach flown without EFVS, and thus the operational assessment required by [AMC1 NCC.OP.235\(a\)\(2\)](#) takes into account the possibility of a balked landing.

An obstacle free zone (OFZ) may also be provided for CAT I precision approach (PA) procedures. Where an OFZ is not provided for a CAT I precision approach, this may be indicated on the approach chart. NPA procedures and approach procedures with vertical guidance provide obstacle clearance for the missed approach based on the assumption that a go-around is executed at the MAPt and not below the MDH.

AMC1 NCC.OP.235(a)(1) EFVS 200 operations

ED Decision 2022/012/R

EQUIPMENT CERTIFICATION

For EFVS 200 operations, the aircraft should be equipped with an approach system using EFVS-A or a landing system using EFVS-L.

AMC1 NCC.OP.235(a)(2) EFVS 200 operations

ED Decision 2022/012/R

AERODROMES AND INSTRUMENT PROCEDURES SUITABLE FOR EFVS 200 OPERATIONS

- (a) For EFVS 200 operations, the operator should verify the suitability of a runway before authorising EFVS operations to that runway through an operational assessment taking into account the following elements:
- (1) the obstacle situation;
 - (2) the type of aerodrome lighting;
 - (3) the available IAPs;
 - (4) the aerodrome operating minima; and
 - (5) any non-standard conditions that may affect the operations.
- (b) EFVS 200 operations should only be conducted as 3D operations, using an IAP in which the final approach track is offset by a maximum of 3 degrees from the extended centre line of the runway.
- (c) The IAP should be designed in accordance with PANS-OPS, Volume I (ICAO Doc 8168) or equivalent criteria.

AMC2 NCC.OP.235(a)(2) EFVS 200 operations

ED Decision 2022/014/R

VERIFICATION OF THE SUITABILITY OF RUNWAYS FOR EFVS 200 OPERATIONS

The operational assessment before authorising the use of a runway for EFVS 200 operations may be conducted as follows:

- (a) Check whether the runway has been promulgated as suitable for EFVS 200 operations or is certified as a PA category II or III runway by the State of the aerodrome. If this is so, then check whether and where the approach and runway lights installed (notably incandescent or LED lights) are adequate for the EFVS equipment used by the operator.
- (b) If the check in point (a) above comes out negative (the runway is not promulgated as EFVS suitable or is not category II or III), then proceed as follows:
 - (1) For straight-in IAPs, US Standard for Terminal Instrument Procedures (TERPS) may be considered to be acceptable as an equivalent to PANS-OPS. If other design criteria than PANS-OPS or US TERPS are used, the operations should not be conducted.
 - (2) If an OFZ is established, this will ensure adequate obstacle protection from 960 m before the threshold. If an OFZ is not established or if the DH for the approach is above 250 ft, then check whether there is a visual segment surface (VSS).
 - (3) VSSs are required for procedures published after 15 March 2007, but the existence of the VSS has to be verified through an aeronautical information publication (AIP), operations manual Part C, or direct contact with the aerodrome. Where the VSS is established, it may not be penetrated by obstacles. If the VSS is not established or is penetrated by obstacles and an OFZ is not established, then the operations should not be conducted. Note: obstacles of a height of less than 50 ft above the threshold may be disregarded when assessing the VSS.
 - (4) Runways with obstacles that require visual identification and avoidance should not be accepted.
 - (5) For the obstacle protection of a balked landing where an OFZ is not established, the operator may specify that pilots follow a departure procedure in the event of a balked landing, in which case it is necessary to verify that the aircraft will be able to comply with the climb gradients published for the instrument departure procedures for the expected landing conditions.
 - (6) Perform an assessment of the suitability of the runway which should include whether the approach and runway lights installed (notably incandescent or LED lights) are adequate for the EFVS equipment used by the operator.
- (c) If the AFM stipulates specific requirements for approach procedures, then the operational assessment should verify that these requirements can be met.

AMC1 NCC.OP.235(a)(3) EFVS 200 operations

ED Decision 2022/012/R

INITIAL TRAINING FOR EFVS 200 OPERATIONS

Operators should ensure that flight crew members complete the following conversion training before being authorised to conduct EFVS operations unless credits related to training and checking for previous experience on similar aircraft types are defined in the operational suitability data established in accordance with [Regulation \(EU\) No 748/2012](#):

- (a) A course of ground training including at least the following:
 - (1) characteristics and limitations of head-up displays (HUDs) or equivalent display systems including information presentation and symbology;
 - (2) EFVS sensor performance in different weather conditions, sensor limitations, scene interpretation, visual anomalies and other visual effects;

- (3) EFVS display, control, modes, features, symbology, annunciations and associated systems and components;
 - (4) the interpretation of EFVS imagery;
 - (5) the interpretation of approach and runway lighting systems and display characteristics when using EFVS;
 - (6) pre-flight planning and selection of suitable aerodromes and approach procedures;
 - (7) principles of obstacle clearance requirements;
 - (8) the use and limitations of RVR assessment systems;
 - (9) normal, abnormal and emergency procedures for EFVS 200 operations;
 - (10) the effect of specific aircraft/system malfunctions;
 - (11) human factors aspects of EFVS 200 operations; and
 - (12) qualification requirements for pilots to obtain and retain approval for EFVS 200 operations.
- (b) A course of FSTD training and/or flight training in two phases as follows:
- (1) Phase one (EFVS 200 operations with aircraft and all equipment serviceable) — objectives:
 - (i) understand the operation of equipment required for EFVS 200 operations;
 - (ii) understand operating limitations of the installed EFVS;
 - (iii) practise the use of HUD or equivalent display systems;
 - (iv) practise the set-up and adjustment of EFVS equipment in different conditions (e.g. day and night);
 - (v) practise the monitoring of automatic flight control systems, EFVS information and status annunciators;
 - (vi) practise the interpretation of EFVS imagery;
 - (vii) become familiar with the features needed on the EFVS image to continue approach below the DH;
 - (viii) practise the identification of visual references using natural vision while using EFVS equipment;
 - (ix) master the manual aircraft handling relevant to EFVS 200 operations including, where appropriate, the use of the flare cue and guidance for landing;
 - (x) practise coordination with other crew members; and
 - (xi) become proficient at procedures for EFVS 200 operations.
 - (2) Phase one of the training should include the following exercises:
 - (i) the required checks for satisfactory functioning of equipment, both on the ground and in flight;
 - (ii) the use of HUD or equivalent display systems during all phases of flight;
 - (iii) approach using the EFVSs installed on the aircraft to the appropriate DH and transition to visual flight and landing;

- (iv) approach with all engines operating using the EFVS, down to the appropriate DH followed by a missed approach, all without external visual reference, as appropriate.
- (3) Phase two (EFVS 200 operations with aircraft and equipment failures and degradations) — objectives:
 - (i) understand the effect of known aircraft unserviceabilities including use of the MEL;
 - (ii) understand the effect of failed or downgraded equipment on aerodrome operating minima;
 - (iii) understand the actions required in response to failures and changes in the status of the EFVS including HUD or equivalent display systems;
 - (iv) understand the actions required in response to failures above and below the DH;
 - (v) practise abnormal operations and incapacitation procedures; and
 - (vi) become proficient at dealing with failures and abnormal situations during EFVS 200 operations.
- (4) Phase two of the training should include the following exercises:
 - (i) approaches with engine failures at various stages of the approach;
 - (ii) approaches with failures of the EFVS at various stages of the approach, including failures between the DH and the height below which an approach should not be continued if natural visual reference is not acquired, require either:
 - (A) reversion to head down displays to control missed approach; or
 - (B) reversion to flight with downgraded or no guidance to control missed approaches from the DH or below, including those which may result in a touchdown on the runway;
 - (iii) incapacitation procedures appropriate to EFVS 200 operations;
 - (iv) failures and procedures applicable to the specific EFVS installation and aircraft type; and
 - (v) FSTD training, which should include minimum eight approaches.

AMC2 NCC.OP.235(a)(3) EFVS 200 operations

ED Decision 2022/012/R

RECURRENT TRAINING AND CHECKING FOR EFVS 200 OPERATIONS

- (a) The operator should ensure that the pilots' competence to perform EFVS 200 operations. To do so, pilots should be trained every 6 months by performing at least two approaches on each type of aircraft operated.
- (b) The operator should ensure that the pilots' competence to perform EFVS 200 operations is checked at each required demonstration of competence by performing at least two approaches on each type of aircraft operated, of which one should be flown without natural vision to 200 ft.

AMC3 NCC.OP.235(a)(3) EFVS 200 operations

ED Decision 2022/012/R

RECENT EXPERIENCE REQUIREMENTS FOR EFVS 200 OPERATIONS

Pilots should complete a minimum of four approaches using the operator's procedures for EFVS 200 operations during the validity period of the periodic demonstration of competence unless credits related to currency are defined in the operational suitability data established in accordance with [Regulation \(EU\) No 748/2012](#).

AMC4 NCC.OP.235(a)(3) EFVS 200 operations

ED Decision 2022/012/R

DIFFERENCES TRAINING FOR EFVS 200 OPERATIONS

- (a) The operator should ensure that the flight crew members authorised to conduct EFVS 200 operations are provided with differences training or familiarisation whenever there is a change to any of the following:
- (1) the technology used in the flight guidance and flight control system;
 - (2) the HUD or equivalent display systems;
 - (3) the operating procedures.
- (b) The differences training should:
- (1) meet the objectives of the appropriate initial training course;
 - (2) take into account the flight crew members' previous experience; and
 - (3) take into account the operational suitability data established in accordance with [Regulation \(EU\) No 748/2012](#).

AMC5 NCC.OP.235(a)(3) EFVS 200 operations

ED Decision 2022/012/R

TRAINING FOR EFVS 200 OPERATIONS

If a flight crew member is to be authorised to operate as pilot flying and pilot monitoring during EFVS 200 operations, then the flight crew member should complete the required FSTD training for each operating capacity.

GM1 NCC.OP.235(a)(3) EFVS 200 operations

ED Decision 2022/012/R

RECURRENT CHECKING FOR EFVS 200 OPERATIONS

In order to provide the opportunity to practise decision-making in the event of system failures and failure to acquire natural visual reference, the recurrent training and checking for EFVS 200 operations is recommended to periodically include different combinations of equipment failures, go-around due to loss of visual reference, and landings.

AMC1 NCC.OP.235(a)(4) EFVS 200 operations

ED Decision 2022/012/R

OPERATING PROCEDURES FOR EFVS 200 OPERATIONS

- (a) For EFVS 200 operations, the following should apply:
- (1) the pilot flying should use the EFVS throughout the approach;
 - (2) in multi-pilot operations, a suitable display of EFVS sensory imagery should be provided to the pilot monitoring;
 - (3) the approach between the FAF and the DA/H should be flown using vertical flight path guidance;
 - (4) the approach may be continued below the DA/H provided that the pilot can identify on the EFVS image either:
 - (i) the approach light system; or
 - (ii) both of the following:
 - (A) the runway threshold identified by the beginning of the runway landing surface, the threshold lights or the runway end identifier lights; and
 - (B) the TDZ identified by the TDZ lights, the TDZ runway markings or the runway lights;
 - (5) a missed approach should be executed promptly if the required visual reference is not distinctly visible and identifiable to the pilot without reliance on the EFVS by 200 ft above the threshold.
- (b) Operating procedures for EFVS 200 operations should:
- (1) be consistent with the AFM;
 - (2) be appropriate to the technology and equipment to be used;
 - (3) specify the duties and responsibilities of each flight crew member in each relevant phase of flight;
 - (4) ensure that flight crew workload is managed to facilitate effective decision-making and monitoring of the aircraft; and
 - (5) deviate to the minimum extent practicable from normal procedures used for routine operations.
- (c) Operating procedures should include:
- (1) the required checks for the satisfactory functioning of the aircraft equipment, both before departure and in flight;
 - (2) the correct seating and eye position;
 - (3) determination of aerodrome operating minima;
 - (4) the required visual references at the DH;
 - (5) the action to be taken if natural visual reference is not acquired by 200 ft;
 - (6) the action to be taken in the event of loss of the required visual reference; and
 - (7) procedures for balked landing.

- (d) Operating procedures for EFVS 200 operations should be included in the operations manual.

AMC1 NCC.OP.235(a)(8) EFVS 200 operations

ED Decision 2022/012/R

AERODROME OPERATING MINIMA — EFVS 200 OPERATIONS

When conducting EFVS 200 operations:

- (a) the DA/H used should be the same as for operations without EFVS;
- (b) the lowest RVR minima to be used should be determined by reducing the RVR presented in:
 - (1) Table 8 in [AMC5 NCC.OP.110](#) in accordance with Table 1 below for aeroplanes;
 - (2) Table 12 of [AMC6 NCC.OP.110](#) in accordance with Table 1 below for helicopters;
- (c) in case of failed or downgraded equipment, Table 15 in [AMC9 NCC.OP.110](#) should apply.

Table 1

Operations utilising EFVS: RVR reduction

RVR (m) presented in Table 8 in AMC5 NCC.OP.110 or in Table 12 of AMC6 NCC.OP.110	RVR (m) for EFVS 200 operations
550	550
600	550
650	550
700	550
750	550
800	550
900	600
1 000	650
1 100	750
1 200	800
1 300	900
1 400	900
1 500	1 000
1 600	1 100
1 700	1 100
1 800	1 200
1 900	1 300
2 000	1 300
2 100	1 400
2 200	1 500
2 300	1 500
2 400	1 600

AMC1 NCC.OP.235(c) EFVS 200 operations

ED Decision 2022/012/R

EFVS 200 WITH LEGACY SYSTEMS UNDER AN APPROVAL

The EVS should be certified before 1 January 2022 as ‘EVS with an operational credit’.

GM1 NCC.OP.235(c) EFVS 200 operations

ED Decision 2022/012/R

The competent authority referred to in [NCC.OP.235](#) point (c) is the competent authority for the oversight of the operator, as established in [ORO.GEN.105](#).

SUBPART C: AIRCRAFT PERFORMANCE AND OPERATING LIMITATIONS

NCC.POL.100 Operating limitations – all aircraft

Regulation (EU) No 800/2013

- (a) During any phase of operation, the loading, the mass and the centre of gravity (CG) position of the aircraft shall comply with any limitation specified in the AFM, or the operations manual, if more restrictive.
- (b) Placards, listings, instrument markings, or combinations thereof, containing those operating limitations prescribed by the AFM for visual presentation, shall be displayed in the aircraft.

NCC.POL.105 Mass and balance, loading

Regulation (EU) No 800/2013

- (a) The operator shall establish the mass and the CG of any aircraft by actual weighing prior to initial entry into service. The accumulated effects of modifications and repairs on the mass and balance shall be accounted for and properly documented. Aircraft shall be reweighed if the effect of modifications on the mass and balance is not accurately known.
- (b) The weighing shall be accomplished by the manufacturer of the aircraft or by an approved maintenance organisation.
- (c) The operator shall determine the mass of all operating items and crew members included in the aircraft dry operating mass by actual weighing, including any crew baggage, or by using standard masses. The influence of their position on the aircraft's CG shall be determined. When using standard masses the following mass values for crew members shall be used to determine the dry operating mass:
 - (1) 85 kg, including hand baggage, for flight crew/technical crew members; and
 - (2) 75 kg for cabin crew members.
- (d) The operator shall establish procedures to enable the pilot-in-command to determine the mass of the traffic load, including any ballast, by:
 - (1) actual weighing;
 - (2) determining the mass of the traffic load in accordance with standard passenger and baggage masses; or
 - (3) calculating passenger mass on the basis of a statement by, or on behalf of, each passenger and adding to it a predetermined mass to account for hand baggage and clothing, when the number of passenger seats available on the aircraft is:
 - (i) less than 10 for aeroplanes; or
 - (ii) less than six for helicopters.
- (e) When using standard masses the following mass values shall be used:
 - (1) for passengers, those in Tables 1 and 2, where hand baggage and the mass of any infant carried by an adult on one passenger seat are included:

Table 1
Standard masses for passengers — aircraft with a total number of passenger seats of 20 or more

Passenger seats	20 and more		30 and more
	Male	Female	All adult
Adults	88 kg	70 kg	84 kg
Children	35 kg	35 kg	35 kg

Table 2
Standard masses for passengers — aircraft with a total number of passenger seats of 19 or less

Passenger seats	1 – 5	6 – 9	10 – 19
Male	104 kg	96 kg	92 kg
Female	86 kg	78 kg	74 kg
Children	35 kg	35 kg	35 kg

- (2) for baggage:
- (i) for aeroplanes, when the total number of passenger seats available on the aeroplane is 20 or more, standard mass values for checked baggage in Table 3;

Table 3
Standard masses for baggage — aeroplanes with a total number of passenger seats of 20 or more

Type of flight	Baggage standard mass
Domestic	11 kg
Within the European region	13 kg
Intercontinental	15 kg
All other	13 kg

- (ii) for helicopters, when the total number of passenger seats available on the helicopters is 20 or more, the standard mass value for checked baggage of 13 kg.
- (f) For aircraft with 19 passenger seats or less, the actual mass of checked baggage shall be determined:
- (1) by weighing; or
- (2) by calculation on the basis of a statement by, or on behalf of, each passenger. Where this is impractical, a minimum standard mass of 13 kg shall be used.
- (g) The operator shall establish procedures to enable the pilot-in-command to determine the mass of the fuel load by using the actual density or, if not known, the density calculated in accordance with a method specified in the operations manual.
- (h) The pilot-in-command shall ensure that the loading of:
- (1) the aircraft is performed under the supervision of qualified personnel; and
- (2) traffic load is consistent with the data used for the calculation of the aircraft mass and balance.
- (i) The operator shall establish procedures to enable the pilot-in-command to comply with additional structural limits such as the floor strength limitations, the maximum load per running metre, the maximum mass per cargo compartment and the maximum seating limit.

- (j) The operator shall specify, in the operations manual, the principles and methods involved in the loading and in the mass and balance system that meet the requirements contained in (a) to (i). This system shall cover all types of intended operations.

AMC1 NCC.POL.105(a) Mass and balance, loading

ED Decision 2013/021/R

CENTRE OF GRAVITY LIMITS — OPERATIONAL CG ENVELOPE AND IN-FLIGHT CG

In the Certificate Limitations section of the AFM, forward and aft CG limits are specified. These limits ensure that the certification stability and control criteria are met throughout the whole flight and allow the proper trim setting for take-off. The operator should ensure that these limits are respected by:

- (a) Defining and applying operational margins to the certified CG envelope in order to compensate for the following deviations and errors:
- (1) Deviations of actual CG at empty or operating mass from published values due, for example, to weighing errors, unaccounted modifications and/or equipment variations.
 - (2) Deviations in fuel distribution in tanks from the applicable schedule.
 - (3) Deviations in the distribution of baggage and cargo in the various compartments as compared with the assumed load distribution as well as inaccuracies in the actual mass of baggage and cargo.
 - (4) Deviations in actual passenger seating from the seating distribution assumed when preparing the mass and balance documentation. Large CG errors may occur when 'free seating', i.e. freedom of passengers to select any seat when entering the aircraft, is permitted. Although in most cases reasonably even longitudinal passenger seating can be expected, there is a risk of an extreme forward or aft seat selection causing very large and unacceptable CG errors, assuming that the balance calculation is done on the basis of an assumed even distribution. The largest errors may occur at a load factor of approximately 50 % if all passengers are seated in either the forward or aft half of the cabin. Statistical analysis indicates that the risk of such extreme seating adversely affecting the CG is greatest on small aircraft.
 - (5) Deviations of the actual CG of cargo and passenger load within individual cargo compartments or cabin sections from the normally assumed mid position.
 - (6) Deviations of the CG caused by gear and flap positions and by application of the prescribed fuel usage procedure, unless already covered by the certified limits.
 - (7) Deviations caused by in-flight movement of cabin crew, galley equipment and passengers.
- (b) Defining and applying operational procedures in order to:
- (1) ensure an even distribution of passengers in the cabin;
 - (2) take into account any significant CG travel during flight caused by passenger/crew movement; and
 - (3) take into account any significant CG travel during flight caused by fuel consumption/transfer.

AMC1 NCC.POL.105(b) Mass and balance, loading

ED Decision 2013/021/R

WEIGHING OF AN AIRCRAFT

- (a) New aircraft that have been weighed at the factory may be placed into operation without reweighing if the mass and balance records have been adjusted for alterations or modifications to the aircraft. Aircraft transferred from one EU operator to another EU operator do not have to be weighed prior to use by the receiving operator, unless the mass and balance cannot be accurately established by calculation.
- (b) The mass and centre of gravity (CG) position of an aircraft should be revised whenever the cumulative changes to the dry operating mass exceed $\pm 0.5\%$ of the maximum landing mass or for aeroplanes the cumulative change in CG position exceeds 0.5% of the mean aerodynamic chord. This should be done either by weighing the aircraft or by calculation.
- (c) When weighing an aircraft, normal precautions should be taken, which are consistent with good practices such as:
 - (1) checking for completeness of the aircraft and equipment;
 - (2) determining that fluids are properly accounted for;
 - (3) ensuring that the aircraft is clean; and
 - (4) ensuring that weighing is accomplished in an enclosed building.
- (d) Any equipment used for weighing should be properly calibrated, zeroed and used in accordance with the manufacturer's instructions. Each scale should be calibrated either by the manufacturer, by a civil department of weights and measures or by an appropriately authorised organisation within 2 years or within a time period defined by the manufacturer of the weighing equipment, whichever is less. The equipment should enable the mass of the aircraft to be established accurately. One single accuracy criterion for weighing equipment cannot be given. However, the weighing accuracy is considered satisfactory if the accuracy criteria in Table 1 are met by the individual scales/cells of the weighing equipment used:

Table 1: Accuracy criteria for weighing equipment

For a scale/cell load	An accuracy of
below 2 000 kg	$\pm 1\%$
from 2 000 kg to 20 000 kg	± 20 kg
above 20 000 kg	$\pm 0.1\%$

AMC1 NCC.POL.105(c) Mass and balance, loading

ED Decision 2013/021/R

DRY OPERATING MASS

- (a) The dry operating mass should include:
 - (1) crew and crew baggage;
 - (2) catering and removable passenger service equipment; and
 - (3) tank water and lavatory chemicals.

- (b) The operator should correct the dry operating mass to account for any additional crew baggage. The position of this additional baggage should be accounted for when establishing the centre of gravity of the aircraft.
- (c) The operator should establish a procedure in the operations manual to determine when to select actual or standard masses for crew members.
- (d) When determining the actual mass by weighing, crew members' personal belongings and hand baggage should be included. Such weighing should be conducted immediately prior to boarding the aircraft.

AMC1 NCC.POL.105(d) Mass and balance, loading

ED Decision 2013/021/R

MASS VALUES FOR PASSENGERS AND BAGGAGE

- (a) The predetermined mass for hand baggage and clothing should be established by the operator on the basis of studies relevant to its particular operation. In any case, it should not be less than:
 - (1) 4 kg for clothing; and
 - (2) 6 kg for hand baggage.

The passengers' stated mass and the mass of passengers' clothing and hand baggage should be checked prior to boarding and adjusted, if necessary. The operator should establish a procedure in the operations manual when to select actual or standard masses and the procedure to be followed when using verbal statements.

- (b) When determining the actual mass by weighing, passengers' personal belongings and hand baggage should be included. Such weighing should be conducted immediately prior to boarding the aircraft.
- (c) When determining the mass of passengers by using standard mass values, provided in Tables 1 and 2 of [NCC.POL.105\(e\)](#), infants occupying separate passenger seats should be considered as children for the purpose of this AMC. When the total number of passenger seats available on an aircraft is 20 or more, the standard masses for males and females in Table 1 of [NCC.POL.105\(e\)](#) should be used. As an alternative, in cases where the total number of passenger seats available is 30 or more, the 'All Adult' mass values in Table 1 of [NCC.POL.105\(e\)](#) may be used.

On aeroplane flights with 19 passenger seats or less and all helicopter flights where no hand baggage is carried in the cabin or where hand baggage is accounted for separately, 6 kg may be deducted from male and female masses in Table 2 of [NCC.POL.105\(e\)](#). Articles such as an overcoat, an umbrella, a small handbag or purse, reading material or a small camera are not considered as hand baggage.

For helicopter operations in which a survival suit is provided to passengers, 3 kg should be added to the passenger mass value.

- (d) Mass values for baggage.

The mass of checked baggage should be checked prior to loading and increased, if necessary.
- (e) On any flight identified as carrying a significant number of passengers whose masses, including hand baggage, are expected to significantly deviate from the standard passenger mass, the operator should determine the actual mass of such passengers by weighing or by adding an adequate mass increment.

- (f) If standard mass values for checked baggage are used and a significant number of passengers' checked baggage is expected to significantly deviate from the standard baggage mass, the operator should determine the actual mass of such baggage by weighing or by adding an adequate mass increment.

GM1 NCC.POL.105(d) Mass and balance, loading

ED Decision 2013/021/R

ADJUSTMENT OF STANDARD MASSES

When standard mass values are used, item (e) of [AMC1 NCC.POL.105\(d\)](#) states that the operator should identify and adjust the passenger and checked baggage masses in cases where significant numbers of passengers or quantities of baggage are suspected of significantly deviating from the standard values. Therefore, the operations manual should contain instructions to ensure that:

- (a) check-in, operations and loading personnel as well as cabin and flight crew report or take appropriate action when a flight is identified as carrying a significant number of passengers whose masses, including hand baggage, are expected to significantly deviate from the standard passenger mass, and/or groups of passengers carrying exceptionally heavy baggage; and
- (b) on small aircraft, where the risks of overload and/or CG errors are the greatest, pilots pay special attention to the load and its distribution and make proper adjustments.

GM1 NCC.POL.105(e) Mass and balance, loading

ED Decision 2021/005/R

TYPE OF FLIGHTS

- (a) For the purpose of Table 3 of [NCC.POL.105\(e\)](#):
- (1) domestic flight means a flight with origin and destination within the borders of one State.
 - (2) flights within the European region means flights, other than domestic flights, whose origin and destination are within the area specified in item (b).
 - (3) Intercontinental flight means flights beyond the European region with origin and destination in different continents.
- (b) Flights within the European region are flights conducted within the following area:
- | | | |
|---|-------|--------|
| — | N7200 | E04500 |
| — | N4000 | E04500 |
| — | N3500 | E03700 |
| — | N3000 | E03700 |
| — | N3000 | W00600 |
| — | N2700 | W00900 |
| — | N2700 | W03000 |
| — | N6700 | W03000 |
| — | N7200 | W01000 |
| — | N7200 | E04500 |

as depicted in Figure 1: European region.

Figure 1:

The European region

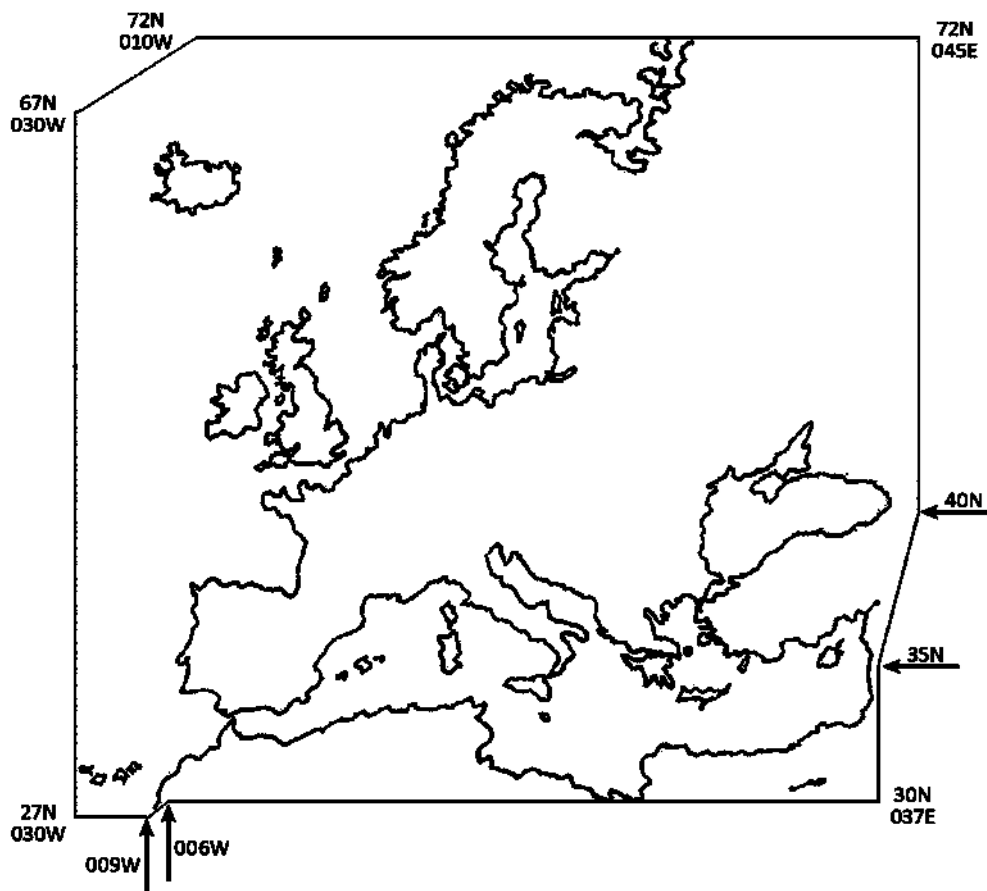

GM1 NCC.POL.105(g) Mass and balance, loading

ED Decision 2013/021/R

FUEL DENSITY

- (a) If the actual fuel density is not known, the operator may use standard fuel density values for determining the mass of the fuel load. Such standard values should be based on current fuel density measurements for the airports or areas concerned.
- (b) Typical fuel density values are:
- | | | |
|--|---|------|
| (1) Gasoline (reciprocating engine fuel) | – | 0.71 |
| (2) JET A1 (Jet fuel JP 1) | – | 0.79 |
| (3) JET B (Jet fuel JP 4) | – | 0.76 |
| (4) Oil | – | 0.88 |

NCC.POL.110 Mass and balance data and documentation

Regulation (EU) 2021/1296

- (a) The operator shall establish mass and balance data and produce mass and balance documentation prior to each flight specifying the load and its distribution in such a way that the

mass and balance limits of the aircraft are not exceeded. The mass and balance documentation shall contain the following information:

- (1) aircraft registration and type;
 - (2) flight identification, number and date, as applicable;
 - (3) name of the pilot-in-command;
 - (4) name of the person who prepared the document;
 - (5) dry operating mass and the corresponding CG of the aircraft;
 - (6) mass of the fuel/energy at take-off and mass of trip fuel/energy;
 - (7) mass of consumables other than fuel/energy, if applicable;
 - (8) load components including passengers, baggage, freight, and ballast;
 - (9) take-off mass, landing mass, and zero fuel/energy mass;
 - (10) applicable aircraft CG positions; and
 - (11) the limiting mass and CG values.
- (b) Where mass and balance data and documentation are generated by a computerised mass and balance system, the operator shall verify the integrity of the output data.
- (c) When the loading of the aircraft is not supervised by the pilot-in-command, the person supervising the loading of the aircraft shall confirm by hand signature or equivalent that the load and its distribution are in accordance with the mass and balance documentation established by the pilot-in-command. The pilot-in-command shall indicate his/her acceptance by hand signature or equivalent.
- (d) The operator shall specify procedures for last minute changes to the load to ensure that:
- (1) any last minute change after the completion of the mass and balance documentation is entered in the flight planning documents containing the mass and balance documentation;
 - (2) the maximum last minute change allowed in passenger numbers or hold load is specified; and
 - (3) new mass and balance documentation is prepared if this maximum number is exceeded.

AMC1 NCC.POL.110(a) Mass and balance data and documentation

ED Decision 2013/021/R

CONTENTS

The mass and balance documentation should include advice to the pilot-in-command whenever a non-standard method has been used for determining the mass of the load.

AMC2 NCC.POL.110(b) Mass and balance data and documentation

ED Decision 2013/021/R

INTEGRITY

The operator should verify the integrity of mass and balance data and documentation generated by a computerised mass and balance system, at intervals not exceeding 6 months. The operator should

establish a system to check that amendments of its input data are incorporated properly in the system and that the system is operating correctly on a continuous basis.

AMC1 NCC.POL.110(c) Mass and balance data and documentation

ED Decision 2013/021/R

SIGNATURE OR EQUIVALENT

Where a signature by hand is impracticable or it is desirable to arrange the equivalent verification by electronic means, the following conditions should be applied in order to make an electronic signature the equivalent of a conventional hand-written signature:

- (a) electronic 'signing' by entering a personal identification number (PIN) code with appropriate security, etc.;
- (b) entering the PIN code generates a print-out of the individual's name and professional capacity on the relevant document(s) in such a way that it is evident, to anyone having a need for that information, who has signed the document;
- (c) the computer system logs information to indicate when and where each PIN code has been entered;
- (d) the use of the PIN code is, from a legal and responsibility point of view, considered to be fully equivalent to signature by hand;
- (e) the requirements for record keeping remain unchanged; and
- (f) all personnel concerned are made aware of the conditions associated with electronic signature and this is documented.

AMC2 NCC.POL.110(c) Mass and balance data and documentation

ED Decision 2013/021/R

MASS AND BALANCE DOCUMENTATION SENT VIA DATA LINK

Whenever the mass and balance documentation is sent to the aircraft via data link, a copy of the final mass and balance documentation as accepted by the pilot-in-command should be available on the ground.

GM1 NCC.POL.110(b) Mass and balance data and documentation

ED Decision 2013/021/R

ON-BOARD INTEGRATED MASS AND BALANCE COMPUTER SYSTEM

An on-board integrated mass and balance computer system may be an aircraft installed system capable of receiving input data either from other aircraft systems or from a mass and balance system on the ground, in order to generate mass and balance data as an output.

GM2 NCC.POL.110(b) Mass and balance data and documentation

ED Decision 2013/021/R

STAND-ALONE COMPUTERISED MASS AND BALANCE SYSTEM

A stand-alone computerised mass and balance system may be a computer, either as part of an electronic flight bag (EFB) system or solely dedicated to mass and balance purposes, requiring input from the user, in order to generate mass and balance data as an output.

NCC.POL.111 Mass and balance data and documentation – alleviations

Regulation (EU) No 800/2013

Notwithstanding [NCC.POL.110\(a\)\(5\)](#), the CG position may not need to be on the mass and balance documentation, if the load distribution is in accordance with a pre-calculated balance table or if it can be shown that for the planned operations a correct balance can be ensured, whatever the real load is.

NCC.POL.115 Performance – general

Regulation (EU) No 800/2013

The pilot-in-command shall only operate the aircraft if the performance is adequate to comply with the applicable rules of the air and any other restrictions applicable to the flight, the airspace or the aerodromes or operating sites used, taking into account the charting accuracy of any charts and maps used.

NCC.POL.120 Take-off mass limitations – aeroplanes

Regulation (EU) No 800/2013

The operator shall ensure that:

- (a) the mass of the aeroplane at the start of take-off shall not exceed the mass limitations:
 - (1) at take-off as required in [NCC.POL.125](#);
 - (2) en-route with one engine inoperative (OEI) as required in [NCC.POL.130](#); and
 - (3) at landing as required in [NCC.POL.135](#);allowing for expected reductions in mass as the flight proceeds and for fuel jettisoning;
- (b) the mass at the start of take-off shall never exceed the maximum take-off mass specified in the AFM for the pressure altitude appropriate to the elevation of the aerodrome or operating site, and if used as a parameter to determine the maximum take-off mass, any other local atmospheric condition; and
- (c) the estimated mass for the expected time of landing at the aerodrome or operating site of intended landing and at any destination alternate aerodrome shall never exceed the maximum landing mass specified in the AFM for the pressure altitude appropriate to the elevation of those aerodromes or operating sites, and if used as a parameter to determine the maximum landing mass, any other local atmospheric condition.

NCC.POL.125 Take-off – aeroplanes

Regulation (EU) No 379/2014

- (a) When determining the maximum take-off mass, the pilot-in-command shall take the following into account:
 - (1) the calculated take-off distance shall not exceed the take-off distance available with a clearway distance not exceeding half of the take-off run available;
 - (2) the calculated take-off run shall not exceed the take-off run available;
 - (3) a single value of V_1 shall be used for the rejected and continued take-off, where a V_1 is specified in the AFM; and

- (4) on a wet or contaminated runway, the take-off mass shall not exceed that permitted for a take-off on a dry runway under the same conditions.
- (b) Except for an aeroplane equipped with turboprop engines and a maximum take-off mass at or below 5 700 kg, in the event of an engine failure during take-off, the pilot-in-command shall ensure that the aeroplane is able:
 - (1) to discontinue the take-off and stop within the accelerate-stop distance available or the runway available; or
 - (2) to continue the take-off and clear all obstacles along the flight path by an adequate margin until the aeroplane is in a position to comply with [NCC.POL.130](#).

AMC1 NCC.POL.125 Take-off — aeroplanes

ED Decision 2013/021/R

TAKE-OFF MASS

The following should be considered for determining the maximum take-off mass:

- (a) the pressure altitude at the aerodrome;
- (b) the ambient temperature at the aerodrome;
- (c) the runway surface condition and the type of runway surface;
- (d) the runway slope in the direction of take-off;
- (e) not more than 50 % of the reported head-wind component or not less than 150 % of the reported tailwind component; and
- (f) the loss, if any, of runway length due to alignment of the aeroplane prior to take-off.

AMC2 NCC.POL.125 Take-off – aeroplanes

ED Decision 2013/021/R

CONTAMINATED RUNWAY PERFORMANCE DATA

Wet and contaminated runway performance data, if made available by the manufacturer, should be taken into account. If such data is not made available, the operator should account for wet and contaminated runway conditions by using the best information available.

AMC3 NCC.POL.125 Take-off – aeroplanes

ED Decision 2013/021/R

ADEQUATE MARGIN

The adequate margin should be defined in the operations manual.

GM1 NCC.POL.125 Take-off – aeroplanes

ED Decision 2021/005/R

RUNWAY SURFACE CONDITION

Operation on runways contaminated with water, slush, snow or ice implies uncertainties with regard to runway friction and contaminant drag and therefore to the achievable performance and control of the aeroplane during take-off or landing, since the actual conditions may not completely match the assumptions on which the performance information is based. In the case of a contaminated runway,

the first option for the pilot-in-command is to wait until the runway is cleared. If this is impracticable, he or she may consider a take-off or landing, provided that he or she has applied the applicable performance adjustments, and any further safety measures he or she considers justified under the prevailing conditions. The excess runway length available including the criticality of the overrun area should also be considered.

The determination of take-off performance data for wet and contaminated runways should be based on the reported runway surface condition in terms of contaminant and depth.

GM2 NCC.POL.125 Take-off – aeroplanes

ED Decision 2013/021/R

ADEQUATE MARGIN

‘An adequate margin’ is illustrated by the appropriate examples included in Attachment C to ICAO Annex 6, Part I.

NCC.POL.130 En-route – one engine inoperative – aeroplanes

Regulation (EU) No 800/2013

The pilot-in-command shall ensure that in the event of an engine becoming inoperative at any point along the route, a multi-engined aeroplane shall be able to continue the flight to an adequate aerodrome or operating site without flying below the minimum obstacle clearance altitude at any point.

NCC.POL.135 Landing – aeroplanes

Regulation (EU) No 800/2013

The pilot-in-command shall ensure that at any aerodrome or operating site, after clearing all obstacles in the approach path by a safe margin, the aeroplane shall be able to land and stop, or a seaplane to come to a satisfactorily low speed, within the landing distance available. Allowance shall be made for expected variations in the approach and landing techniques, if such allowance has not been made in the scheduling of performance data.

AMC1 NCC.POL.135 Landing – aeroplanes

ED Decision 2013/021/R

GENERAL

The following should be considered to ensure that an aeroplane is able to land and stop, or a seaplane to come to a satisfactorily low speed, within the landing distance available:

- (a) the pressure altitude at the aerodrome;
- (b) the runway surface condition and the type of runway surface;
- (c) the runway slope in the direction of landing;
- (d) not more than 50 % of the reported head-wind component or not less than 150 % of the reported tailwind component; and
- (e) use of the most favourable runway, in still air;
- (f) use of the runway most likely to be assigned considering the probable wind speed and direction and the ground handling characteristics of the aeroplane, and considering other conditions such as landing aids and terrain.

AMC2 NCC.POL.135 Landing – aeroplanes

ED Decision 2013/021/R

ALLOWANCES

The allowances should be stated in the operations manual.

GM1 NCC.POL.135 Landing — aeroplanes

ED Decision 2021/005/R

WET AND CONTAMINATED RUNWAY DATA

The determination of landing performance data should be based on information provided in the operations manual (OM) on the reported RWYCC. The RWYCC is determined by the aerodrome operator using the RCAM and associated procedures defined in ICAO Doc 9981 'PANS Aerodromes'. The RWYCC is reported through an RCR in the SNOWTAM format in accordance with ICAO Annex 15.

SUBPART D: INSTRUMENTS, DATA AND EQUIPMENT

SECTION 1 – AEROPLANES

NCC.IDE.A.100 Instruments and equipment – general

Regulation (EU) 2019/1384

- (a) Instruments and equipment required by this Subpart shall be approved in accordance with the applicable airworthiness requirements if they are:
- (1) used by the flight crew to control the flight path;
 - (2) used to comply with [NCC.IDE.A.245](#);
 - (3) used to comply with [NCC.IDE.A.250](#); or
 - (4) installed in the aeroplane.
- (b) The following items, when required by this Subpart, do not need an equipment approval:
- (1) spare fuses;
 - (2) independent portable lights;
 - (3) an accurate time piece;
 - (4) chart holder;
 - (5) first-aid kits;
 - (6) survival and signalling equipment;
 - (7) sea anchor and equipment for mooring; and
 - (8) child restraint device.
- (c) Instruments and equipment or accessories not required under this Annex as well as any other equipment which is not required under this Regulation, but carried on a flight, shall comply with the following requirements:
- (1) the information provided by those instruments, equipment or accessories shall not be used by the flight crew members to comply with Annex II to Regulation (EU) 2018/1139 or points [NCC.IDE.A.245](#) and [NCC.IDE.A.250](#) of this Annex;
 - (2) the instruments and equipment shall not affect the airworthiness of the aeroplane, even in the case of failures or malfunction.
- (d) Instruments and equipment shall be readily operable or accessible from the station where the flight crew member that needs to use it is seated.
- (e) Those instruments that are used by a flight crew member shall be so arranged as to permit the flight crew member to see the indications readily from his/her station, with the minimum practicable deviation from the position and line of vision which he/she normally assumes when looking forward along the flight path.
- (f) All required emergency equipment shall be easily accessible for immediate use.

GM1 NCC.IDE.A.100(a) Instruments and equipment – general

ED Decision 2013/021/R

APPLICABLE AIRWORTHINESS REQUIREMENTS

The applicable airworthiness requirements for approval of instruments and equipment required by this Part are the following:

- (a) Regulation (EC) 748/2012¹ for:
 - (1) aeroplanes registered in the EU; and
 - (2) aeroplanes registered outside the EU but manufactured or designed by an EU organisation.
- (b) Airworthiness requirements of the state of registry for aeroplanes registered, designed and manufactured outside the EU.

GM1 NCC.IDE.A.100(b) Instruments and equipment – general

ED Decision 2017/010/R

REQUIRED INSTRUMENTS AND EQUIPMENT THAT DO NOT NEED TO BE APPROVED IN ACCORDANCE WITH THE APPLICABLE AIRWORTHINESS REQUIREMENTS

The functionality of non-installed instruments and equipment required by this Subpart and that do not need an equipment approval, as listed in [NCC.IDE.A.100\(b\)](#), should be checked against recognised industry standards appropriate to the intended purpose. The operator is responsible for ensuring the maintenance of these instruments and equipment.

GM1 NCC.IDE.A.100(c) Instruments and equipment – general

ED Decision 2017/010/R

NON-REQUIRED INSTRUMENTS AND EQUIPMENT THAT DO NOT NEED TO BE APPROVED IN ACCORDANCE WITH THE APPLICABLE AIRWORTHINESS REQUIREMENTS, BUT ARE CARRIED ON A FLIGHT

- (a) This Guidance Material does not exempt the item of equipment from complying with the applicable airworthiness requirements if the instrument or equipment is installed in the aeroplane. In this case, the installation should be approved as required in the applicable airworthiness requirements and should comply with the applicable Certification Specifications.
- (b) The failure of additional non-installed instruments or equipment not required by this Part or by the applicable airworthiness requirements or any applicable airspace requirements should not adversely affect the airworthiness and/or the safe operation of the aircraft. Examples are the following:
 - (1) instruments supplying additional flight information (e.g. stand-alone global positioning system (GPS));
 - (2) mission dedicated equipment (e.g. radios); and
 - (3) non-installed passenger entertainment equipment.

¹ Commission Regulation (EU) No 748/2012 of 3 August 2012 laying down implementing rules for the airworthiness and environmental certification of aircraft and related products, parts and appliances, as well as for the certification of design and production organisations (OJ L 224, 21.8.2012, p. 1).

GM1 NCC.IDE.A.100(d) Instruments and equipment – general

ED Decision 2013/021/R

POSITIONING OF INSTRUMENTS

This requirement implies that whenever a single instrument is required in an aeroplane operated in a multi-crew environment, the instrument needs to be visible from each flight crew station.

NCC.IDE.A.105 Minimum equipment for flight

Regulation (EU) 2019/1384

A flight shall not be commenced when any of the aeroplane's instruments, items of equipment, or functions, required for the intended flight are inoperative or missing, unless:

- (a) the aeroplane is operated in accordance with the operator's minimum equipment list (MEL);
- (b) the operator is approved by the competent authority to operate the aeroplane within the constraints of the master minimum equipment list (MMEL) in accordance with point [ORO.MLR.105\(j\)](#) of Annex III; or
- (c) the aeroplane is subject to a permit to fly issued in accordance with the applicable airworthiness requirements.

AMC1 NCC.IDE.A.105 Minimum equipment for flight

ED Decision 2021/005/R

MANAGEMENT OF THE STATUS OF CERTAIN INSTRUMENTS, EQUIPMENT OR FUNCTIONS

The operator should control and retain the status of the instruments, equipment or functions required for the intended operation, that are not controlled for the purpose of continuing airworthiness management.

GM1 NCC.IDE.A.105 Minimum equipment for flight

ED Decision 2021/005/R

MANAGEMENT OF THE STATUS OF CERTAIN INSTRUMENTS, EQUIPMENT OR FUNCTIONS

- (a) The operator should define responsibilities and procedures to retain and control the status of instruments, equipment or functions required for the intended operation, that are not controlled for the purpose of continuing airworthiness management.
- (b) Examples of such instruments, equipment or functions may be, but are not limited to, equipment related to navigation approvals as FM immunity or certain software versions.

NCC.IDE.A.110 Spare electrical fuses

Regulation (EU) No 800/2013

Aeroplanes shall be equipped with spare electrical fuses, of the ratings required for complete circuit protection, for replacement of those fuses that are allowed to be replaced in flight.

GM1 NCC.IDE.A.110 Spare electrical fuses

ED Decision 2013/021/R

FUSES

A spare electrical fuse means a replaceable fuse in the flight crew compartment, not an automatic circuit breaker or circuit breakers in the electric compartments.

NCC.IDE.A.115 Operating lights

Regulation (EU) No 800/2013

Aeroplanes operated at night shall be equipped with:

- (a) an anti-collision light system;
- (b) navigation/position lights;
- (c) a landing light;
- (d) lighting supplied from the aeroplane's electrical system to provide adequate illumination for all instruments and equipment essential to the safe operation of the aeroplane;
- (e) lighting supplied from the aeroplane's electrical system to provide illumination in all passenger compartments;
- (f) an independent portable light for each crew member station; and
- (g) lights to conform with the International Regulations for Preventing Collisions at Sea if the aeroplane is operated as a seaplane.

NCC.IDE.A.120 Operations under VFR – flight and navigational instruments and associated equipment

Regulation (EU) 2019/1384

- (a) Aeroplanes operated under VFR by day shall be equipped with a means of measuring and displaying the following:
 - (1) magnetic-heading;
 - (2) time in hours, minutes and seconds;
 - (3) barometric altitude;
 - (4) indicated airspeed;
 - (5) slip; and
 - (6) Mach number whenever speed limitations are expressed in terms of Mach number.
- (b) Aeroplanes operated under visual meteorological conditions (VMC) over water and out of sight of the land, or under VMC at night, or in conditions where the aeroplane cannot be maintained in a desired flight path without reference to one or more additional instruments, shall be, in addition to (a), equipped with:
 - (1) a means of measuring and displaying the following:
 - (i) turn and slip;
 - (ii) attitude;
 - (iii) vertical speed; and

- (iv) stabilised heading;
 - (2) a means of indicating when the supply of power to the gyroscopic instruments is not adequate; and
 - (3) a means of preventing malfunction of the airspeed indicating system required in (a)(4) due to condensation or icing.
- (c) Whenever two pilots are required for the operation, aeroplanes shall be equipped with an additional separate means of displaying the following:
- (1) barometric altitude;
 - (2) indicated airspeed;
 - (3) slip, or turn and slip, as applicable;
 - (4) attitude, if applicable;
 - (5) vertical speed, if applicable;
 - (6) stabilised heading, if applicable; and
 - (7) Mach number whenever speed limitations are expressed in terms of Mach number, if applicable.

AMC1 NCC.IDE.A.120&NCC.IDE.A.125 Operations under VFR & operations under IFR – flight and navigational instruments and associated equipment

ED Decision 2013/021/R

INTEGRATED INSTRUMENTS

- (a) Individual equipment requirements may be met by combinations of instruments, by integrated flight systems or by a combination of parameters on electronic displays. The information so available to each required pilot should not be less than that required in the applicable operational requirements, and the equivalent safety of the installation should be approved during type certification of the aeroplane for the intended type of operation.
- (b) The means of measuring and indicating turn and slip, aeroplane attitude and stabilised aeroplane heading may be met by combinations of instruments or by integrated flight director systems, provided that the safeguards against total failure, inherent in the three separate instruments, are retained.

AMC2 NCC.IDE.A.120 Operations under VFR – flight and navigational instruments and associated equipment

ED Decision 2013/021/R

LOCAL FLIGHTS

For flights that do not exceed 60 minutes' duration, that take off and land at the same aerodrome and that remain within 50 NM of that aerodrome, an equivalent means of complying with [NCC.IDE.A.120\(a\)\(5\) & \(b\)\(1\)\(i\)](#) may be:

- (a) a turn and slip indicator;
- (b) a turn coordinator; or

- (c) both an attitude indicator and a slip indicator.

AMC1 NCC.IDE.A.120(a)(1)&NCC.IDE.A.125(a)(1) Operations under VFR & operations under IFR – flight and navigational instruments and associated equipment

ED Decision 2013/021/R

MEANS OF MEASURING AND DISPLAYING MAGNETIC HEADING

The means of measuring and displaying magnetic heading should be a magnetic compass or equivalent.

AMC1 NCC.IDE.A.120(a)(2)&NCC.IDE.A.125(a)(2) Operations under VFR & operations under IFR – flight and navigational instruments and associated equipment

ED Decision 2013/021/R

MEANS OF MEASURING AND DISPLAYING THE TIME

An acceptable means of compliance is a clock displaying hours, minutes and seconds, with a sweep-second pointer or digital presentation.

AMC1 NCC.IDE.A.120(a)(3)&NCC.IDE.A.125(a)(3) Operations under VFR & operations under IFR – flight and navigational instruments and associated equipment

ED Decision 2019/019/R

CALIBRATION OF THE MEANS FOR MEASURING AND DISPLAYING PRESSURE ALTITUDE

The instrument measuring and displaying barometric altitude should be of a sensitive type calibrated in feet (ft), with a sub-scale setting, calibrated in hectopascals/millibars, adjustable for any barometric pressure likely to be set during flight.

NCC.IDE.A.125 Operations under IFR – flight and navigational instruments and associated equipment

Regulation (EU) 2019/1384

Aeroplanes operated under IFR shall be equipped with:

- (a) a means of measuring and displaying the following:
- (1) magnetic heading;
 - (2) time in hours, minutes and seconds;
 - (3) barometric altitude;
 - (4) indicated airspeed;
 - (5) vertical speed;
 - (6) turn and slip;
 - (7) attitude;

- (8) stabilised heading;
- (9) outside air temperature; and
- (10) Mach number whenever speed limitations are expressed in terms of Mach number;
- (b) a means of indicating when the supply of power to the gyroscopic instruments is not adequate;
- (c) whenever two pilots are required for the operation, an additional separate means of displaying for the second pilot:
 - (1) barometric altitude;
 - (2) indicated airspeed;
 - (3) vertical speed;
 - (4) turn and slip;
 - (5) attitude;
 - (6) stabilised heading; and
 - (7) Mach number whenever speed limitations are expressed in terms of Mach number, if applicable;
- (d) a means of preventing malfunction of the airspeed indicating systems required in (a)(4) and (c)(2) due to condensation or icing;
- (e) an alternate source of static pressure;
- (f) a chart holder in an easily readable position that can be illuminated for night operations;
- (g) a second independent means of measuring and displaying altitude; and
- (h) an emergency power supply, independent of the main electrical generating system, for the purpose of operating and illuminating an attitude indicating system for a minimum period of 30 minutes. The emergency power supply shall be automatically operative after the total failure of the main electrical generating system and clear indication shall be given on the instrument or on the instrument panel that the attitude indicator is being operated by emergency power.

AMC1 NCC.IDE.A.120(a)(4)&NCC.IDE.A.125(a)(4) Operations under VFR & operations under IFR – flight and navigational instruments and associated equipment

ED Decision 2013/021/R

CALIBRATION OF THE INSTRUMENT INDICATING AIRSPEED

The instrument indicating airspeed should be calibrated in knots (kt).

AMC1 NCC.IDE.A.120(c)&NCC.IDE.A.125(c) Operations under VFR & operations under IFR — flight and navigational instruments and associated equipment

ED Decision 2013/021/R

MULTI-PILOT OPERATIONS – DUPLICATE INSTRUMENTS

Duplicate instruments include separate displays for each pilot and separate selectors or other associated equipment where appropriate.

AMC1 NCC.IDE.A.125(a)(9) Operations under IFR – flight and navigational instruments and associated equipment

ED Decision 2013/021/R

MEANS OF DISPLAYING OUTSIDE AIR TEMPERATURE

- (a) The means of displaying outside air temperature should be calibrated in degrees Celsius.
- (b) The means of displaying outside air temperature may be an air temperature indicator that provides indications that are convertible to outside air temperature.

AMC1 NCC.IDE.A.125(d) Operations under IFR – flight and navigational instruments and associated equipment

ED Decision 2013/021/R

MEANS OF PREVENTING MALFUNCTION DUE TO CONDENSATION OR ICING

The means of preventing malfunction due to either condensation or icing of the airspeed indicating system should be a heated pitot tube or equivalent.

AMC1 NCC.IDE.A.125(f) Operations under IFR – flight and navigational instruments and associated equipment

ED Decision 2013/021/R

CHART HOLDER

An acceptable means of compliance with the chart holder requirement is to display a pre-composed chart on an electronic flight bag (EFB).

AMC2 NCC.IDE.A.125(a)(3) Operations under IFR – flight and navigational instruments and associated equipment

ED Decision 2013/021/R

ALTIMETERS — IFR OR NIGHT OPERATIONS

Except for unpressurised aeroplanes operating below 10 000 ft, the altimeters of aeroplanes operating under IFR or at night should have counter drum-pointer or equivalent presentation.

NCC.IDE.A.130 Additional equipment for single-pilot operations under IFR

Regulation (EU) No 800/2013

Aeroplanes operated under IFR with a single pilot shall be equipped with an autopilot with at least altitude hold and heading mode.

NCC.IDE.A.135 Terrain awareness warning system (TAWS)

Regulation (EU) No 800/2013

Turbine-powered aeroplanes with a maximum certified take-off mass (MCTOM) of more than 5 700 kg or a maximum operational passenger seating configuration (MOPSC) of more than nine shall be equipped with a TAWS that meets the requirements for:

- (a) class A equipment, as specified in an acceptable standard, in the case of aeroplanes for which the individual certificate of airworthiness (CofA) was first issued after 1 January 2011; or
- (b) class B equipment, as specified in an acceptable standard, in the case of aeroplanes for which the individual CofA was first issued on or before 1 January 2011.

AMC1 NCC.IDE.A.135 Terrain awareness warning system (TAWS)

ED Decision 2013/021/R

EXCESSIVE DOWNWARDS GLIDESLOPE DEVIATION WARNING FOR CLASS A TAWS

The requirement for a Class A TAWS to provide a warning to the flight crew for excessive downwards glideslope deviation should apply to all final approach glideslopes with angular vertical navigation (VNAV) guidance, whether provided by the instrument landing system (ILS), microwave landing system (MLS), satellite-based augmentation system approach procedure with vertical guidance (SBAS APV (localiser performance with vertical guidance approach LPV)), ground-based augmentation system (GBAS (GPS landing system, GLS)) or any other systems providing similar guidance. The same requirement should not apply to systems providing vertical guidance based on barometric VNAV.

GM1 NCC.IDE.A.135 Terrain awareness warning system (TAWS)

ED Decision 2013/021/R

ACCEPTABLE STANDARD FOR TAWS

An acceptable standard for Class A and Class B TAWS may be the applicable European technical standards order (ETSO) issued by the Agency or equivalent.

NCC.IDE.A.140 Airborne collision avoidance system (ACAS)

Regulation (EU) No 800/2013

Unless otherwise provided for by Regulation (EU) No 1332/2011, turbine-powered aeroplanes with an MCTOM of more than 5700 kg or an MOPSC of more than 19 shall be equipped with ACAS II.

NCC.IDE.A.145 Airborne weather detecting equipment

Regulation (EU) No 800/2013

The following aeroplanes shall be equipped with airborne weather detecting equipment when operated at night or in IMC in areas where thunderstorms or other potentially hazardous weather

conditions, regarded as detectable with airborne weather detecting equipment, may be expected to exist along the route:

- (a) pressurised aeroplanes;
- (b) non-pressurised aeroplanes with an MCTOM of more than 5 700 kg; and
- (c) non-pressurised aeroplanes with an MOPSC of more than nine.

AMC1 NCC.IDE.A.145 Airborne weather detecting equipment

ED Decision 2013/021/R

GENERAL

The airborne weather detecting equipment should be an airborne weather radar, except for propeller-driven pressurised aeroplanes with an MCTOM not more than 5 700 kg and an MOPSC of not more than nine, for which other equipment capable of detecting thunderstorms and other potentially hazardous weather conditions, regarded as detectable with airborne weather radar equipment, are also acceptable.

NCC.IDE.A.150 Additional equipment for operations in icing conditions at night

Regulation (EU) No 800/2013

- (a) Aeroplanes operated in expected or actual icing conditions at night shall be equipped with a means to illuminate or detect the formation of ice.
- (b) The means to illuminate the formation of ice shall not cause glare or reflection that would handicap flight crew members in the performance of their duties.

NCC.IDE.A.155 Flight crew interphone system

Regulation (EU) No 800/2013

Aeroplanes operated by more than one flight crew member shall be equipped with a flight crew interphone system, including headsets and microphones for use by all flight crew members.

AMC1 NCC.IDE.A.155 Flight crew interphone system

ED Decision 2013/021/R

TYPE OF FLIGHT CREW INTERPHONE

The flight crew interphone system should not be of a handheld type.

NCC.IDE.A.160 Cockpit voice recorder

Regulation (EU) 2020/2036

- (a) The following aeroplanes shall be equipped with a CVR:
 - (1) aeroplanes with an MCTOM of more than 27 000 kg and first issued with an individual CofA on or after 1 January 2016; and
 - (2) aeroplanes with an MCTOM of more than 2 250 kg:
 - (i) certified for operation with a minimum crew of at least two pilots;
 - (ii) equipped with turbojet engine(s) or more than one turboprop engine; and

- (iii) for which a type certificate is first issued on or after 1 January 2016.
- (b) The CVR shall be capable of retaining data recorded during at least:
 - (1) the preceding 25 hours for aeroplanes with an MCTOM of more than 27 000 kg and first issued with an individual CofA on or after 1 January 2022; or
 - (2) the preceding 2 hours in all other cases.
- (c) The CVR shall record with reference to a timescale:
 - (1) voice communications transmitted from or received in the flight crew compartment by radio;
 - (2) flight crew members' voice communications using the interphone system and the public address system, if installed;
 - (3) the aural environment of the flight crew compartment, including, without interruption, the audio signals received from each boom and mask microphone in use; and
 - (4) voice or audio signals identifying navigation or approach aids introduced into a headset or speaker.
- (d) The CVR shall start automatically to record prior to the aeroplane moving under its own power and shall continue to record until the termination of the flight when the aeroplane is no longer capable of moving under its own power.
- (e) In addition to (d), depending on the availability of electrical power, the CVR shall start to record as early as possible during the cockpit checks prior to engine start at the beginning of the flight until the cockpit checks immediately following engine shutdown at the end of the flight.
- (f) If the CVR is not deployable, it shall have a device to assist in locating it under water. By 1 January 2020 at the latest, this device shall have a minimum underwater transmission time of 90 days. If the CVR is deployable, it shall have an automatic emergency locator transmitter.

AMC1 NCC.IDE.A.160 Cockpit voice recorder

ED Decision 2015/021/R

GENERAL

- (a) The operational performance requirements for cockpit voice recorders (CVRs) should be those laid down in the European Organisation for Civil Aviation Equipment (EUROCAE) Document ED-112 (Minimum Operational Performance Specification for Crash Protected Airborne Recorder Systems), dated March 2003, including Amendments n°1 and 2, or any later equivalent standard produced by EUROCAE.
- (b) The operational performance requirements for equipment dedicated to the CVR should be those laid down in the European Organisation for Civil Aviation Equipment (EUROCAE) Document ED-56A (Minimum Operational Performance Requirements For Cockpit Voice Recorder Systems) dated December 1993, or EUROCAE Document ED-112 (Minimum Operational Performance Specification for Crash Protected Airborne Recorder Systems) dated March 2003, including Amendments No°1 and No°2, or any later equivalent standard produced by EUROCAE.

NCC.IDE.A.165 Flight data recorder

Regulation (EU) 2015/2338

- (a) Aeroplanes with an MCTOM of more than 5 700 kg and first issued with an individual CofA on or after 1 January 2016 shall be equipped with an FDR that uses a digital method of recording and storing data and for which a method of readily retrieving that data from the storage medium is available.
- (b) The FDR shall record the parameters required to determine accurately the aeroplane flight path, speed, attitude, engine power, configuration and operation and be capable of retaining data recorded during at least the preceding 25 hours.
- (c) Data shall be obtained from aeroplane sources that enable accurate correlation with information displayed to the flight crew.
- (d) The FDR shall start automatically to record the data prior to the aeroplane being capable of moving under its own power and shall stop automatically after the aeroplane is incapable of moving under its own power.
- (e) If the FDR is not deployable, it shall have a device to assist in locating it under water. By 1 January 2020 at the latest, this device shall have a minimum underwater transmission time of 90 days. If the FDR is deployable, it shall have an automatic emergency locator transmitter.

AMC1 NCC.IDE.A.165 Flight data recorder

ED Decision 2016/012/R

OPERATIONAL PERFORMANCE REQUIREMENTS FOR AEROPLANES FIRST ISSUED WITH AN INDIVIDUAL CofA ON OR AFTER 1 JANUARY 2016 AND BEFORE 1 JANUARY 2023

- (a) The operational performance requirements for flight data recorders (FDRs) should be those laid down in EUROCAE Document ED-112 (Minimum Operational Performance Specification for Crash Protected Airborne Recorder Systems) dated March 2003, including amendments n°1 and n°2, or any later equivalent standard produced by EUROCAE.
- (b) The flight data recorder should record, with reference to a timescale, the list of parameters in Table 1 and Table 2, as applicable.
- (c) The parameters to be recorded should meet the performance specifications (designated ranges, sampling intervals, accuracy limits and minimum resolution in read-out) as defined in the relevant tables of EUROCAE Document ED-112, dated March 2003, including amendments n°1 and 2, or any later equivalent standard produced by EUROCAE.

Table 1: All Aeroplanes

No*	Parameter
1a	Time; or
1b	Relative time count
1c	Global navigation satellite system (GNSS) time synchronisation
2	Pressure altitude
3	Indicated airspeed; or calibrated airspeed
4	Heading (primary flight crew reference) - when true or magnetic heading can be selected, the primary heading reference, a discrete indicating selection, should be recorded
5	Normal acceleration
6	Pitch attitude

No*	Parameter
7	Roll attitude
8	Manual radio transmission keying and CVR/FDR synchronisation reference.
9	Engine thrust/power:
9a	Parameters required to determine propulsive thrust/power on each engine
9b	Flight crew compartment thrust/power lever position (for aeroplanes with non-mechanically linked flight crew compartment — engine controls)
14	Total or outside air temperature
16	Longitudinal acceleration (body axis)
17	Lateral acceleration
18	Primary flight control surface and/or primary flight control pilot input (for aeroplanes with control systems in which movement of a control surface will back drive the pilot's control, 'or' applies. For aeroplanes with control systems in which movement of a control surface will not back drive the pilot's control, 'and' applies. For multiple or split surfaces, a suitable combination of inputs is acceptable instead of recording each surface separately. For aeroplanes that have a flight control break-away capability that allows either pilot to operate the controls independently, record both inputs):
18a	Pitch axis
18b	Roll axis
18c	Yaw axis
19	Pitch trim surface position
23	Marker beacon passage
24	Warnings — in addition to the master warning each 'red' warning (including smoke warnings from other compartments) should be recorded when the warning condition cannot be determined from other parameters or from the CVR
25	Each navigation receiver frequency selection
27	Air—ground status. Air—ground status (and a sensor of each landing gear if installed)

* The number in the left hand column reflects the serial number depicted in EUROCAE ED-112.

Table 2: Aeroplanes for which the data source for the parameter is either used by aeroplane systems or is available on the instrument panel for use by the flight crew to operate the aeroplane

No*	Parameter
10	Flaps
10a	Trailing edge flap position
10b	Flight crew compartment control selection
11	Slats
11a	Leading edge flap (slat) position
11b	Flight crew compartment control selection
12	Thrust reverse status
13	Ground spoiler and speed brake:
13a	Ground spoiler position
13b	Ground spoiler selection
13c	Speed brake position
13d	Speed brake selection
15	Autopilot, autothrottle, automatic flight control system (AFCS) mode and engagement status
20	Radio altitude. For auto-land/Category III operations, each radio altimeter should be recorded.
21	Vertical deviation — (the approach aid in use should be recorded. For auto-land/CAT III operations, each system should be recorded.):
21a	ILS/GPS/GLS glide path
21b	MLS elevation

No*	Parameter
21c	Integrated approach navigation (IAN)/integrated area navigation (IRNAV), vertical deviation
22	Horizontal deviation — (the approach aid in use should be recorded. For auto-land/CAT III operations, each system should be recorded. It is acceptable to arrange them so that at least one is recorded every second):
22a	ILS/GPS/GLS localiser
22b	MLS azimuth
22c	GNSS approach path/IRNAV lateral deviation
26	Distance measuring equipment (DME) 1 and 2 distances:
26a	Distance to runway threshold (GLS)
26b	Distance to missed approach - Point (IRNAV/IAN)
28	Ground proximity warning system (GPWS)/TAWS/ground collision avoidance system (GCAS) status:
28a	Selection of terrain display mode, including pop-up display status
28b	Terrain alerts, including cautions and warnings and advisories
28c	On/off switch position
29	Angle of attack
30	Low pressure warning (each system):
30a	Hydraulic pressure
30b	Pneumatic pressure
31	Ground speed
32	Landing gear:
32a	Landing gear position
32b	Gear selector position
33	Navigation data:
33a	Drift angle
33b	Wind speed
33c	Wind direction
33d	Latitude
33e	Longitude
33f	GNSS augmentation in use
34	Brakes:
34a	Left and right brake pressure
34b	Left and right brake pedal position
35	Additional engine parameters (if not already recorded in parameter 9 of Table 1 of AMC1 NCC.IDE.A.165 and if the aeroplane is equipped with a suitable data source):
35a	Engine pressure ratio (EPR)
35b	N ₁
35c	Indicated vibration level
35d	N ₂
35e	Exhaust gas temperature (EGT)
35f	Fuel flow
35g	Fuel cut-off lever position
35h	N ₃
36	Traffic alert and collision avoidance system (TCAS)/ACAS — a suitable combination of discrettes should be recorded to determine the status of the system:
36a	Combined control
36b	Vertical control
36c	Up advisory
36d	Down advisory
36e	Sensitivity level
37	Wind shear warning

No*	Parameter
38	Selected barometric setting:
38a	Pilot
38b	Co-pilot
39	Selected altitude (all pilot selectable modes of operation) — to be recorded for the aeroplane where the parameter is displayed electronically
40	Selected speed (all pilot selectable modes of operation) — to be recorded for the aeroplane where the parameter is displayed electronically
41	Selected Mach (all pilot selectable modes of operation) — to be recorded for the aeroplane where the parameter is displayed electronically
42	Selected vertical speed (all pilot selectable modes of operation) — to be recorded for the aeroplane where the parameter is displayed electronically
43	Selected heading (all pilot selectable modes of operation) — to be recorded for the aeroplane where the parameter is displayed electronically
44	Selected flight path (All pilot selectable modes of operation) - to be recorded for the aeroplane where the parameter is displayed electronically:
44a	Course/desired track (DSTRK)
44b	Path angle
44c	Coordinates of final approach path (IRNAV/IAN)
45	Selected decision height - to be recorded for the aeroplane where the parameter is displayed electronically
46	Electronic flight instrument system (EFIS) display format:
46a	Pilot
46b	Co-pilot
47	Multi-function/engine/alerts display format
48	AC electrical bus status — each bus
49	DC electrical bus status — each bus
50	Engine bleed valve position
51	Auxiliary power unit (APU) bleed valve position
52	Computer failure (all critical flight and engine control systems)
53	Engine thrust command
54	Engine thrust target
55	Computed centre of gravity (CG)
56	Fuel quantity in CG trim tank
57	Head-up display in use
58	Para visual display on
59	Operational stall protection, stick shaker and pusher activation
60	Primary navigation system reference:
60a	GNSS
60b	Inertial navigational system (INS)
60c	VHF omnidirectional radio range (VOR)/DME
60d	MLS
60e	Loran C
60f	ILS
61	Ice detection
62	Engine warning — each engine vibration
63	Engine warning — each engine over temperature
64	Engine warning — each engine oil pressure low
65	Engine warning — each engine over speed

No*	Parameter
66	Yaw trim surface position
67	Roll trim surface position
68	Yaw or sideslip angle
69	De-icing and/or anti-icing systems selection
70	Hydraulic pressure — each system
71	Loss of cabin pressure
72	Trim control input position in the flight crew compartment, pitch — when mechanical means for control inputs are not available, displayed trim position or trim command should be recorded
73	Trim control input position in the flight crew compartment, roll — when mechanical means for control inputs are not available, displayed trim position or trim command should be recorded
74	Trim control input position in the flight crew compartment, yaw — when mechanical means for control inputs are not available, displayed trim position or trim command should be recorded
75	All flight control input forces (for fly-by-wire flight control systems, where control surface position is a function of the displacement of the control input device only, it is not necessary to record this parameter):
75a	Control wheel
75b	Control column
75c	Rudder pedal
76	Event marker
77	Date
78	Actual navigation performance (ANP) or estimate of position error (EPE) or estimate of position uncertainty (EPU)

* The number in the left hand column reflects the serial number depicted in EUROCAE ED-112.

AMC2 NCC.IDE.A.165 Flight data recorder

ED Decision 2021/005/R

OPERATIONAL PERFORMANCE REQUIREMENTS FOR AEROPLANES FIRST ISSUED WITH AN INDIVIDUAL CofA ON OR AFTER 1 JANUARY 2023

- (a) The operational performance requirements for flight data recorders (FDRs) should be those laid down in EUROCAE Document 112A (Minimum Operational Performance Specification for Crash Protected Airborne Recorder Systems) dated September 2013, or any later equivalent standard produced by EUROCAE.
- (b) The FDR should, with reference to a timescale, record:
 - (1) the list of parameters in Table 1 below;
 - (2) the additional parameters listed in Table 2 below, when the information data source for the parameter is used by aeroplane systems or is available on the instrument panel for use by the flight crew to operate the aeroplane; and
 - (3) any dedicated parameters related to novel or unique design or operational characteristics of the aeroplane as determined by the Agency.
- (c) The parameters to be recorded should meet the performance specifications (range, sampling intervals, accuracy limits and resolution in read-out) as defined in the relevant tables of EUROCAE Document 112A, or any later equivalent standard produced by EUROCAE.

Table 1: FDR — All aeroplanes

No*	Parameter
1a	Time; or
1b	Relative time count
1c	Global navigation satellite system (GNSS) time synchronisation
2	Pressure altitude (including altitude values displayed on each flight crew member's primary flight display, unless the aeroplane is type certified before 1 January 2023 and recording the values displayed at the captain position or the first officer position would require extensive modification)
3	Indicated airspeed or calibrated airspeed (including values of indicated airspeed or calibrated airspeed displayed on each flight crew member's primary flight display, unless the aeroplane is type certified before 1 January 2023 and recording the values displayed at the captain position or the first officer position would require extensive modification)
4	Heading (primary flight crew reference) — when true or magnetic heading can be selected, the primary heading reference, a discrete indicating selection should be recorded.
5	Normal acceleration
6	Pitch attitude — pitch attitude values displayed on each flight crew member's primary flight display should be recorded, unless the aeroplane is type certified before 1 January 2023 and recording the values displayed at the captain position or the first officer position would require extensive modification.
7	Roll attitude — roll attitude values displayed on each flight crew member's primary flight display should be recorded, unless the aeroplane is type certified before 1 January 2023 and recording the values displayed at the captain position or the first officer position would require extensive modification.
8	Manual radio transmission keying and CVR/FDR synchronisation reference
9	Engine thrust/power:
9a	Parameters required to determine propulsive thrust/power on each engine, in both normal and reverse thrust
9b	Flight crew compartment thrust/power lever position (for aeroplanes with non-mechanically linked engine controls in the flight crew compartment)
14	Total or outside air temperature
16	Longitudinal acceleration (body axis)
17	Lateral acceleration
18	Primary flight control surface and/or primary flight control pilot input (For aeroplanes with control systems in which the movement of a control surface will back drive the pilot's control, 'or' applies. For aeroplanes with control systems in which the movement of a control surface will not back drive the pilot's control, 'and' applies. For multiple or split surfaces, a suitable combination of inputs is acceptable in lieu of recording each surface separately. For aeroplanes that have a flight control break-away capability that allows either pilot to operate the controls independently, record both inputs):
18a	Pitch axis
18b	Roll axis
18c	Yaw axis
19	Pitch trim surface position
23	Marker beacon passage
24	Warnings — in addition to the master warning, each 'red' warning that cannot be determined from other parameters or from the CVR and each smoke warning from other compartments should be recorded.
25	Each navigation receiver frequency selection
27	Air-ground status. Air-ground status and a sensor of each landing gear if installed

* The number in the left-hand column reflects the serial number depicted in EUROCAE 112A.

Table 2: FDR — Aeroplanes for which the data source for the parameter is either used by the aeroplane systems or is available on the instrument panel for use by the flight crew to operate the aeroplane

No*	Parameter
10	Flaps:
10a	Trailing edge flap position
10b	Flight crew compartment control selection
11	Slats:
11a	Leading edge flap (slat) position
11b	Flight crew compartment control selection
12	Thrust reverse status
13	Ground spoiler and speed brake:
13a	Ground spoiler position
13b	Ground spoiler selection
13c	Speed brake position
13d	Speed brake selection
15	Autopilot, autothrottle and automatic flight control system (AFCS): mode and engagement status (showing which systems are engaged and which primary modes are controlling the flight path and speed of the aircraft)
20	Radio altitude. For auto-land/category III operations, each radio altimeter should be recorded.
21	Vertical deviation — the approach aid in use should be recorded. For auto-land/category III operations, each system should be recorded:
21a	ILS/GPS/GLS glide path
21b	MLS elevation
21c	Integrated approach navigation (IAN) /Integrated Area Navigation, vertical deviation
22	Horizontal deviation — the approach aid in use should be recorded. For auto-land/category III operations, each system should be recorded:
22a	ILS/GPS/GLS localiser
22b	MLS azimuth
22c	GNSS approach path/IRNAV lateral deviation
26	Distance measuring equipment (DME) 1 and 2 distances:
26a	Distance to runway threshold (GLS)
26b	Distance to missed approach point (IRNAV/IAN)
28	Ground proximity warning system (GPWS)/terrain awareness warning system (TAWS)/ground collision avoidance system (GCAS) status — a suitable combination of discretes unless recorder capacity is limited in which case a single discrete for all modes is acceptable:
28a	Selection of terrain display mode, including pop-up display status
28b	Terrain alerts, including cautions and warnings and advisories
28c	On/off switch position
29	Angle of attack
30	Low pressure warning (each system):
30a	Hydraulic pressure
30b	Pneumatic pressure
31	Ground speed
32	Landing gear:
32a	Landing gear position
32b	Gear selector position
33	Navigation data:
33a	Drift angle
33b	Wind speed
33c	Wind direction
33d	Latitude
33e	Longitude

No*	Parameter
33f	GNSS augmentation in use
34	Brakes:
34a	Left and right brake pressure
34b	Left and right brake pedal position
35	Additional engine parameters (if not already recorded in parameter 9 of Table 1, and if the aeroplane is equipped with a suitable data source):
35a	Engine pressure ratio (EPR)
35b	N1
35c	Indicated vibration level
35d	N2
35e	Exhaust gas temperature (EGT)
35f	Fuel flow
35g	Fuel cut-off lever position
35h	N3
35i	Engine fuel metering valve position (or equivalent parameter from the system that directly controls the flow of fuel into the engine) — for aeroplanes type certified before 1 January 2023, to be recorded only if this does not require extensive modification.
36	Traffic alert and collision avoidance system (TCAS)/airborne collision avoidance system (ACAS) — a suitable combination of discrettes should be recorded to determine the status of the system:
36a	Combined control
36b	Vertical control
36c	Up advisory
36d	Down advisory
36e	Sensitivity level
37	Wind shear warning
38	Selected barometric setting — to be recorded for the aeroplane where the parameter is displayed electronically:
38a	Pilot selected barometric setting
38b	Co-pilot selected barometric setting
39	Selected altitude (all pilot selectable modes of operation) — to be recorded for the aeroplane where the parameter is displayed electronically
40	Selected speed (all pilot selectable modes of operation) — to be recorded for the aeroplane where the parameter is displayed electronically
41	Selected Mach (all pilot selectable modes of operation) — to be recorded for the aeroplane where the parameter is displayed electronically
42	Selected vertical speed (all pilot selectable modes of operation) — to be recorded for the aeroplane where the parameter is displayed electronically
43	Selected heading (all pilot selectable modes of operation) — to be recorded for the aeroplane where the parameter is displayed electronically
44	Selected flight path (all pilot selectable modes of operation) — to be recorded for the aeroplane where the parameter is displayed electronically:
44a	Course/desired track (DSTRK)
44b	Path angle
44c	Coordinates of final approach path (IRNAV/IAN)
45	Selected decision height — to be recorded for the aeroplane where the parameter is displayed electronically
46	Electronic flight instrument system (EFIS) display format, showing the display system status:
46a	Pilot
46b	Co-pilot
47	Multi-function/engine/alerts display format, showing the display system status
48	Alternating current (AC) electrical bus status — each bus

No*	Parameter
49	Direct current (DC) electrical bus status — each bus
50	Engine bleed valve(s) position
51	Auxiliary power unit (APU) bleed valve(s) position
52	Computer failure — all critical flight and engine control systems
53	Engine thrust command
54	Engine thrust target
55	Computed centre of gravity (CG)
56	Fuel quantity in CG trim tank
57	Head-up display in use
58	Paravirtual display on
59	Operational stall protection, stick shaker and pusher activation
60	Primary navigation system reference:
60a	GNSS
60b	Inertial navigational system (INS)
60c	VHF omnidirectional radio range (VOR)/distance measuring equipment (DME)
60d	MLS
60e	Loran C
60f	ILS
61	Ice detection
62	Engine warning — each engine vibration
63	Engine warning — each engine over temperature
64	Engine warning — each engine oil pressure low
65	Engine warning — each engine overspeed
66	Yaw trim surface position
67	Roll trim surface position
68	Yaw or sideslip angle
69	De-icing and/or anti-icing systems selection
70	Hydraulic pressure — each system
71	Loss of cabin pressure
72	Trim control input position in the flight crew compartment, pitch — when mechanical means for control inputs are not available, displayed trim position or trim command should be recorded.
73	Trim control input position in the flight crew compartment, roll — when mechanical means for control inputs are not available, displayed trim position or trim command should be recorded.
74	Trim control input position in the flight crew compartment, yaw — when mechanical means for control inputs are not available, displayed trim position or trim command should be recorded.
75	All flight control input forces (for fly-by-wire flight control systems, where control surface position is a function of the displacement of the control input device only, it is not necessary to record this parameter):
75a	Control wheel input forces
75b	Control column input forces
75c	Rudder pedal input forces
76	Event marker
77	Date
78	Actual navigation performance (ANP) or estimate of position error (EPE) or estimate of position uncertainty (EPU)
79	Cabin pressure altitude — for aeroplanes type certified before 1 January 2023, to be recorded only if this does not require extensive modification.

No*	Parameter
80	Aeroplane computed weight — for aeroplanes type certified before 1 January 2023, to be recorded only if this does not require extensive modification.
81	Flight director command:
81a	Left flight director pitch command — for aeroplanes type certified before 1 January 2023, to be recorded only if this does not require extensive modification.
81b	Left flight director roll command — for aeroplanes type certified before 1 January 2023, to be recorded only if this does not require extensive modification.
81c	Right flight director pitch command — for aeroplanes type certified before 1 January 2023, to be recorded only if this does not require extensive modification.
81d	Right flight director roll command — for aeroplanes type certified before 1 January 2023, to be recorded only if this does not require extensive modification.
82	Vertical speed — for aeroplanes type certified before 1 January 2023, to be recorded only if this does not require extensive modification.

* The number in the left-hand column reflects the serial number depicted in EUROCAE Document 112A.

NCC.IDE.A.170 Data link recording

Regulation (EU) 2015/2338

- (a) Aeroplanes first issued with an individual CofA on or after 1 January 2016 that have the capability to operate data link communications and are required to be equipped with a CVR shall record on a recorder, where applicable:
- (1) data link communication messages related to ATS communications to and from the aeroplane, including messages applying to the following applications:
 - (i) data link initiation;
 - (ii) controller–pilot communication;
 - (iii) addressed surveillance;
 - (iv) flight information;
 - (v) as far as is practicable, given the architecture of the system, aircraft broadcast surveillance;
 - (vi) as far as is practicable, given the architecture of the system, aircraft operational control data; and
 - (vii) as far as is practicable, given the architecture of the system, graphics;
 - (2) information that enables correlation to any associated records related to data link communications and stored separately from the aeroplane; and
 - (3) information on the time and priority of data link communications messages, taking into account the system’s architecture.
- (b) The recorder shall use a digital method of recording and storing data and information and a method for readily retrieving that data. The recording method shall allow the data to match the data recorded on the ground.
- (c) The recorder shall be capable of retaining data recorded for at least the same duration as set out for CVRs in [NCC.IDE.A.160](#).
- (d) If the recorder is not deployable, it shall have a device to assist in locating it under water. By 1 January 2020 at the latest, this device shall have a minimum underwater transmission time of 90 days. If the recorder is deployable, it shall have an automatic emergency locator transmitter.

- (e) The requirements applicable to the start and stop logic of the recorder are the same as the requirements applicable to the start and stop logic of the CVR contained in [NCC.IDE.A.160\(d\) and \(e\)](#).

AMC1 NCC.IDE.A.170 Data link recording

ED Decision 2013/021/R

GENERAL

- (a) As a means of compliance with [NCC.IDE.A.170\(a\)](#) the recorder on which the data link messages are recorded may be:
- (1) the CVR;
 - (2) the FDR;
 - (3) a combination recorder when [NCC.IDE.A.175](#) is applicable; or
 - (4) a dedicated flight recorder. In that case, the operational performance requirements for this recorder should be those laid down in EUROCAE Document ED-112 (Minimum Operational Performance Specification for Crash Protected Airborne Recorder Systems), dated March 2003, including amendments No 1 and 2, or any later equivalent standard produced by EUROCAE.
- (b) As a means of compliance with [NCC.IDE.A.170\(a\)\(2\)](#) the operator should enable correlation by providing information that allows an accident investigator to understand what data was provided to the aircraft and, when the provider identification is contained in the message, by which provider.
- (c) The timing information associated with the data link communications messages required to be recorded by [NCC.IDE.A.170\(a\)\(3\)](#) should be capable of being determined from the airborne-based recordings. This timing information should include at least the following:
- (1) the time each message was generated;
 - (2) the time any message was available to be displayed by the flight crew;
 - (3) the time each message was actually displayed or recalled from a queue; and
 - (4) the time of each status change.
- (d) The message priority should be recorded when it is defined by the protocol of the data link communication message being recorded.
- (e) The expression 'taking into account the system's architecture', in [NCC.IDE.A.170\(a\)\(3\)](#), means that the recording of the specified information may be omitted if the existing source systems involved would require a major upgrade. The following should be considered:
- (1) the extent of the modification required;
 - (2) the down-time period; and
 - (3) equipment software development.
- (f) Data link communications messages that support the applications in Table 1 below should be recorded.
- (g) Further details on the recording requirements can be found in the recording requirement matrix in Appendix D.2 of EUROCAE Document ED-93 (Minimum Aviation System Performance Specification for CNS/ATM Recorder Systems), dated November 1998.

Table 1: Data link recording

Item No.	Application Type	Application Description	Required Recording Content
1	Data link initiation	This includes any application used to log on to, or initiate, a data link service. In future air navigation system (FANS)-1/A and air traffic navigation (ATN), these are ATS facilities notification (AFN) and context management (CM), respectively.	C
2	Controller/pilot communication	This includes any application used to exchange requests, clearances, instructions and reports between the flight crew and controllers on the ground. In FANS-1/A and ATN, this includes the controller pilot data link communications (CPDLC) application. It also includes applications used for the exchange of oceanic clearances (OCL) and departure clearances (DCL), as well as data link delivery of taxi clearances.	C
3	Addressed surveillance	This includes any surveillance application in which the ground sets up contracts for delivery of surveillance data. In FANS-1/A and ATN, this includes the automatic dependent surveillance-contract (ADS-C) application.	C, F2
4	Flight information	This includes any application used for delivery of flight information data to specific aeroplanes. This includes for example digital automatic terminal information service (D ATIS), data link operational terminal information service (D OTIS), digital weather information services (data link-meteorological aerodrome or aeronautical report (D-METAR) or terminal weather information for pilots (TWIP)), data link flight information service (D-FIS), and Notice to Airmen (electronic NOTAM) delivery.	C
5	Broadcast surveillance	This includes elementary and enhanced surveillance systems, as well as automatic dependent surveillance-broadcast (ADS-B) output data.	M*, F2
6	Aeronautical operational control (AOC) data	This includes any application transmitting or receiving data used for AOC purposes (in accordance with the ICAO definition of AOC). Such systems may also process aeronautical administrative communication (AAC) messages, but there is no requirement to record AAC messages	M*
7	Graphics	This includes any application receiving graphical data to be used for operational purposes (i.e. excluding applications that are receiving such things as updates to manuals).	M* F1

GM1 NCC.IDE.A.170 Data link recording

ED Decision 2013/021/R

GENERAL

- (a) The letters and expressions in Table 1 of [AMC1 NCC.IDE.A.170](#) have the following meaning:
- (1) C: complete contents recorded.
 - (2) M: information that enables correlation with any associated records stored separately from the aeroplane.
 - (3) *: applications that are to be recorded only as far as is practicable, given the architecture of the system.

- (4) F1: graphics applications may be considered as AOC messages when they are part of a data link communications application service run on an individual basis by the operator itself in the framework of the operational control.
- (5) F2: where parametric data sent by the aeroplane, such as Mode S, is reported within the message, it should be recorded unless data from the same source is recorded on the FDR.
- (b) The definitions of the applications type in Table 1 of [AMC1 NCC.IDE.A.170](#) are described in Table 1 below.

Table 1: Definitions of the applications type

Item No.	Application Type	Messages	Comments
1	CM		CM is an ATN service
2	AFN		AFN is a FANS 1/A service
3	CPDLC		All implemented up and downlink messages to be recorded
4	ADS-C	ADS-C reports	All contract requests and reports recorded
		Position reports	Only used within FANS 1/A. Mainly used in oceanic and remote areas.
5	ADS-B	Surveillance data	Information that enables correlation with any associated records stored separately from the aeroplane.
6	D-FIS		D-FIS is an ATN service. All implemented up and downlink messages to be recorded
7	TWIP	TWIP messages	Terminal weather information for pilots
8	D-ATIS	ATIS messages	Refer to EUROCAE ED-89A, dated December 2003: Data Link Application System Document (DLASD) for the 'ATIS' data link service
9	OCL	OCL messages	Refer to EUROCAE ED-106A, dated March 2004: Data Link Application System Document (DLASD) for 'Oceanic Clearance' (OCL) data link service
10	DCL	DCL messages	Refer to EUROCAE ED-85A, dated December 2005: Data Link Application System Document (DLASD) for 'Departure Clearance' data link service
11	Graphics	Weather maps & other graphics	Graphics exchanged in the framework of procedures within the operational control, as specified in Part-ORO. Information that enables correlation with any associated records stored separately from the aeroplane.
12	AOC	Aeronautical operational control messages	Messages exchanged in the framework of procedures within the operational control, as specified in Part-ORO. Information that enables correlation with any associated records stored separately from the aeroplane. Definition in EUROCAE ED-112, dated March 2003.
13	Surveillance	Downlinked aircraft parameters (DAP)	As defined in ICAO Annex 10 Volume IV (Surveillance systems and ACAS).

AAC aeronautical administrative communications
 ADS-B automatic dependent surveillance - broadcast
 ADS-C automatic dependent surveillance – contract
 AFN aircraft flight notification

AOC	aeronautical operational control
ATIS	automatic terminal information service
ATSC	air traffic service communication
CAP	controller access parameters
CPDLC	controller pilot data link communications
CM	configuration/context management
D-ATIS	digital ATIS
D-FIS	data link flight information service
D-METAR	data link meteorological airport report
DCL	departure clearance
FANS	Future Air Navigation System
FLIPCY	flight plan consistency
OCL	oceanic clearance
SAP	system access parameters
TWIP	terminal weather information for pilots

GM1 NCC.IDE.A.170(a) Data link recording

ED Decision 2015/030/R

APPLICABILITY OF THE DATA LINK RECORDING REQUIREMENT

- (a) If it is certain that the aeroplane cannot use data link communication messages for ATS communications corresponding to any application designated by [NCC.IDE.A.170\(a\)\(1\)](#), then the data link recording requirement does not apply.
- (b) Examples where the aeroplane cannot use data link communication messages for ATS communications include but are not limited to the cases where:
 - (1) the aeroplane data link communication capability is disabled permanently and in a way that it cannot be enabled again during the flight;
 - (2) data link communications are not used to support air traffic service (ATS) in the area of operation of the aeroplane; and
 - (3) the aeroplane data link communication equipment cannot communicate with the equipment used by ATS in the area of operation of the aeroplane.

NCC.IDE.A.175 Flight data and cockpit voice combination recorder

Regulation (EU) No 800/2013

Compliance with CVR requirements and FDR requirements may be achieved by:

- (a) one flight data and cockpit voice combination recorder if the aeroplane has to be equipped with a CVR or an FDR; or
- (b) two flight data and cockpit voice combination recorders if the aeroplane has to be equipped with a CVR and an FDR.

AMC1 NCC.IDE.A.175 Flight data and cockpit voice combination recorder

ED Decision 2013/021/R

GENERAL

When two flight data and cockpit voice combination recorders are installed, one should be located near the flight crew compartment in order to minimise the risk of data loss due to a failure of the

wiring that gathers data to the recorder. The other should be located at the rear section of the aeroplane in order to minimise the risk of data loss due to recorder damage in the case of a crash.

GM1 NCC.IDE.A.175 Flight data and cockpit voice combination recorder

ED Decision 2013/021/R

GENERAL

- (a) A flight data and cockpit voice combination recorder is a flight recorder that records:
- (1) all voice communications and the aural environment required by [NCC.IDE.A.160](#); and
 - (2) all parameters required by [NCC.IDE.A.165](#),
- with the same specifications required by [NCC.IDE.A.160](#) and [NCC.IDE.A.165](#).
- (b) In addition, a flight data and cockpit voice combination recorder may record data link communication messages and related information required by [NCC.IDE.A.170](#).

NCC.IDE.A.180 Seats, seat safety belts, restraint systems and child restraint devices

Regulation (EU) 2019/1384

- (a) Aeroplanes shall be equipped with:
- (1) a seat or berth for each person on board who is aged 24 months or more;
 - (2) a seat belt on each passenger seat and restraining belts for each berth;
 - (3) a child restraint device (CRD) for each person on board younger than 24 months;
 - (4) a seat belt with upper torso restraint system incorporating a device that will automatically restrain the occupant's torso in the event of rapid deceleration:
 - (i) on each flight crew seat and on any seat alongside a pilot's seat; and
 - (ii) on each observer's seat located in the flight crew compartment;and
 - (5) a seat belt with upper torso restraint system on the seats for the minimum required cabin crew, in the case of aeroplanes first issued with an individual CofA after 31 December 1980.
- (b) A seat belt with upper torso restraint system shall have:
- (1) a single point release;
 - (2) on the seats for the minimum number of required cabin crew members, two shoulder straps and a seat belt that may be used independently;
 - (3) on flight crew members seats and on any seat alongside a pilot's seat, either of the following:
 - (i) two shoulder straps and a seat belt that may be used independently; or
 - (ii) a diagonal shoulder strap and a seat belt that may be used independently for the following aeroplanes:

- (A) aeroplanes with an MCTOM of 5 700 kg or less and with an MOPSC of nine or less that are compliant with the emergency landing dynamic conditions defined in the applicable certification specification;
- (B) aeroplanes with an MCTOM of 5 700 kg or less and with an MOPSC of nine or less that are not compliant with the emergency landing dynamic conditions defined in the applicable certification specification and having an individual CofA first issued before 25 August 2016.

AMC1 NCC.IDE.A.180 Seats, seat safety belts, restraint systems and child restraint devices

ED Decision 2019/019/R

CHILD RESTRAINT DEVICES (CRDs)

- (a) A CRD is considered to be acceptable if:
 - (1) it is a 'supplementary loop' belt manufactured with the same techniques and the same materials as the approved safety belts; or
 - (2) it complies with (b).
- (b) Provided the CRD can be installed properly on the respective aircraft seat, the following CRDs are considered acceptable:
 - (1) CRDs approved for use in aircraft according to the European Technical Standard Order ETSO-C100c on Aviation Child Safety Device (ACSD);
 - (2) CRDs approved by EASA through a Type Certificate or Supplemental Type Certificate;
 - (3) Child seat approved for use in motor vehicles on the basis of the technical standard specified in (i). The child seat must be also approved for use in aircraft on the basis of the technical standard specified in either point (ii) or point (iii):
 - (i) UN Standard ECE R44-04 (or 03), or ECE R129 bearing the respective 'ECE R' label; and
 - (ii) German 'Qualification Procedure for Child Restraint Systems for Use in Aircraft' (TÜV/958-01/2001) bearing the label 'For Use in Aircraft'; or
 - (iii) Other technical standard acceptable to the competent authority. The child seat should hold a qualification sign that it can be used in aircraft.
 - (4) Child seats approved for use in motor vehicles and aircraft according to Canadian CMVSS 213/213.1 bearing the respective label;
 - (5) Child seats approved for use in motor vehicles and aircraft according to US FMVSS No 213 and bearing one or two labels displaying the following two sentences:
 - (i) 'THIS CHILD RESTRAINT SYSTEM CONFORMS TO ALL APPLICABLE FEDERAL MOTOR VEHICLE SAFETY STANDARDS'; and
 - (ii) in red letters 'THIS RESTRAINT IS CERTIFIED FOR USE IN MOTOR VEHICLES AND AIRCRAFT';
 - (6) Child seats approved for use in motor vehicles and aircraft according to Australia/New Zealand's technical standard AS/NZS 1754:2013 bearing the green part on the label displaying 'For Use in Aircraft'; and

- (7) CRDs manufactured and tested according to other technical standards equivalent to those listed above. The devices should be marked with an associated qualification sign, which shows the name of the qualification organisation and a specific identification number, related to the associated qualification project. The qualifying organisation should be a competent and independent organisation that is acceptable to the competent authority.
- (c) Location
- (1) Forward-facing child seats may be installed on both forward-and rearward-facing passenger seats, but only when fitted in the same direction as the passenger seat on which they are positioned. Rearward-facing child seats should only be installed on forward-facing passenger seats. A child seat should not be installed within the radius of action of an airbag unless it is obvious that the airbag is de-activated or it can be demonstrated that there is no negative impact from the airbag.
 - (2) An infant/child in a CRD should be located in the vicinity of a floor level exit.
 - (3) An infant/child in a CRD should not hinder evacuation for any passenger.
 - (4) An infant/child in a CRD should neither be located in the row (where rows are existing) leading to an emergency exit nor located in a row immediately forward or aft of an emergency exit. A window passenger seat is the preferred location. An aisle passenger seat or a cross aisle passenger seat that forms part of the evacuation route to exits is not recommended. Other locations may be acceptable provided the access of neighbour passengers to the nearest aisle is not obstructed by the CRD.
 - (5) In general, only one CRD per row segment is recommended. More than one CRD per row segment is allowed if the infants/children are from the same family or travelling group provided the infants/children are accompanied by a responsible adult sitting next to them in the same row segment.
 - (6) A row segment is one or more seats side-by-side separated from the next row segment by an aisle.
- (d) Installation
- (1) CRDs tested and approved for use in aircraft should only be installed on a suitable passenger seat by the method shown in the manufacturer's instructions provided with each CRD and with the type of connecting device they are approved for the installation in aircraft. CRDs designed to be installed only by means of rigid bar lower anchorages (ISOFIX or equivalent) should only be used on passenger seats equipped with such connecting devices and should not be secured by passenger seat lap belt.
 - (2) All safety and installation instructions should be followed carefully by the responsible adult accompanying the infant/child. Operators should prohibit the use of a CRD not installed on the passenger seat according to the manufacturer's instructions or not approved for use in aircraft.
 - (3) If a forward-facing child seat with a rigid backrest is to be fastened by a seat lap belt, the restraint device should be fastened when the backrest of the passenger seat on which it rests is in a reclined position. Thereafter, the backrest is to be positioned upright. This procedure ensures better tightening of the child seat on the aircraft seat if the aircraft seat is reclinable.
 - (4) The buckle of the adult safety belt should be easily accessible for both opening and closing, and should be in line with the seat belt halves (not canted) after tightening.

- (5) Forward-facing restraint devices with an integral harness must not be installed such that the adult safety belt is secured over the infant.
- (e) Operation
- (1) Each CRD should remain secured to a passenger seat during all phases of flight, unless it is properly stowed when not in use.
- (2) Where a child seat is adjustable in recline, it should be in an upright position for all occasions when passenger restraint devices are required.

AMC2 NCC.IDE.A.180 Seats, seat safety belts, restraint systems and child restraint devices

ED Decision 2016/017/R

UPPER TORSO RESTRAINT SYSTEM

- (a) A restraint system including a seat belt, two shoulder straps and additional straps is deemed to be compliant with the requirement for restraint systems with two shoulder straps.
- (b) An upper torso restraint system which restrains permanently the torso of the occupant is deemed to be compliant with the requirement for an upper torso restraint system incorporating a device that will automatically restrain the occupant's torso in the event of rapid deceleration.
- (c) The use of the upper torso restraint independently from the use of the seat belt is intended as an option for the comfort of the occupant of the seat in those phases of flight where only the seat belt is required to be fastened. A restraint system including a seat belt and an upper torso restraint that both remain permanently fastened is also acceptable.

SEAT BELT

A seat belt with a diagonal shoulder strap (three anchorage points) is deemed to be compliant with the requirement for a seat belt (two anchorage points).

AMC3 NCC.IDE.A.180 Seats, seat safety belts, restraint systems and child restraint devices

ED Decision 2013/021/R

SEATS FOR MINIMUM REQUIRED CABIN CREW

- (a) Seats for the minimum required cabin crew members should be located near required floor level emergency exits, except if the emergency evacuation of passengers would be enhanced by seating cabin crew members elsewhere. In this case, other locations are acceptable.
- (b) Such seats should be forward or rearward facing within 15° of the longitudinal axis of the aeroplane.

GM1 NCC.IDE.A.180 Seats, seat safety belts, restraint systems and child restraint devices

ED Decision 2016/017/R

EMERGENCY LANDING DYNAMIC CONDITIONS

Emergency landing dynamic conditions are defined in 23.562 of CS-23 or equivalent and in 25.562 of CS-25 or equivalent.

GM2 NCC.IDE.A.180 Seats, seat safety belts, restraint systems and child restraint devices

ED Decision 2019/019/R

USE OF CHILD SEATS ON BOARD

Guidance on child restraint devices and facilitation of mutual acceptance of these devices can be found in ICAO Doc 10049 'Manual on the approval and use of child restraint systems'.

NCC.IDE.A.185 Fasten seat belt and no smoking signs

Regulation (EU) No 800/2013

Aeroplanes in which not all passenger seats are visible from the flight crew seat(s) shall be equipped with a means of indicating to all passengers and cabin crew when seat belts shall be fastened and when smoking is not allowed.

NCC.IDE.A.190 First-aid kit

Regulation (EU) No 800/2013

- (a) Aeroplanes shall be equipped with first-aid kits in accordance with Table 1.

Table 1

Number of first-aid kits required

Number of passenger seats installed	Number of first-aid kits required
0 – 100	1
101 – 200	2
201 – 300	3
301 – 400	4
401 – 500	5
501 or more	6

- (b) First-aid kits shall be:
- (1) readily accessible for use; and
 - (2) kept up-to-date.

AMC1 NCC.IDE.A.190 First-aid kit

ED Decision 2021/005/R

CONTENT OF FIRST-AID KITS

- (a) First-aid kits should be equipped with appropriate and sufficient medications and instrumentation. However, these kits should be supplemented by the operator according to the characteristics of the operation (scope of operation, flight duration, number and demographics of passengers, number of decks, etc.).
- (b) The following should be included in the FAKs:
- (1) Equipment:
 - (i) bandages (assorted sizes, including a triangular bandage);
 - (ii) burns dressings (unspecified);

- (iii) wound dressings (large and small);
 - (iv) adhesive dressings (assorted sizes);
 - (v) adhesive tape;
 - (vi) adhesive wound closures;
 - (vii) safety pins;
 - (viii) safety scissors;
 - (ix) antiseptic wound cleaner;
 - (x) disposable resuscitation aid;
 - (xi) disposable gloves;
 - (xii) tweezers: splinter;
 - (xiii) thermometers (non-mercury); and
 - (xiv) surgical masks.
- (2) Medications:
- (i) simple analgesic (including paediatric form – if the type of operation does not include transport of children or infants, the paediatric form may not be included);
 - (ii) antiemetic — non-injectable;
 - (iii) nasal decongestant;
 - (iv) gastrointestinal antacid, in the case of aeroplanes carrying more than nine passengers;
 - (v) anti-diarrhoeal medication, in the case of aeroplanes carrying more than nine passengers; and
 - (vi) antihistamine (including paediatric form – if the type of operation does not include transport of children or infants, the paediatric form may not be included).
- (3) Other content. The operator should make the instructions readily available. If an electronic format is available, then all instructions should be kept on the same device. If a paper format is used, then the instructions should be kept in the same kit with the applicable equipment and medication. The instructions should include, as a minimum, the following:
- (i) a list of contents in at least two languages (English and one other). This should include information on the effects and side effects of medications carried;
 - (ii) first-aid handbook, current edition;
 - (iii) basic life support instructions cards (summarising and depicting the current algorithm for basic life support); and
 - (iv) medical incident report form.
- (4) Additional equipment. The following additional equipment should be carried on board each aircraft equipped with a first-aid kit, though not necessarily in the first-aid kit. When operating multi-deck aircraft, operators should assess if the additional equipment is needed on each deck. The additional equipment should include, as a minimum:

- (i) automated external defibrillator (AED) on all aircraft required to carry at least one cabin crew;
- (ii) bag-valve masks (masks in three sizes: one for adults, one for children, and one for infants);
- (iii) suitable airway management device (e.g. supraglottic airway devices, oropharyngeal and nasopharyngeal airways);
- (iv) eye irrigator;
- (v) biohazard disposal bags; and
- (vi) basic delivery kit (including sterile umbilical cord scissors and a pair of cord clamps) on all aircraft required to carry at least one cabin crew.

AMC2 NCC.IDE.A.190 First-aid kit

ED Decision 2013/021/R

MAINTENANCE OF FIRST-AID KITS

To be kept up to date first-aid kits should be:

- (a) inspected periodically to confirm, to the extent possible, that contents are maintained in the condition necessary for their intended use;
- (b) replenished at regular intervals, in accordance with instructions contained on their labels, or as circumstances warrant; and
- (c) replenished after use in-flight at the first opportunity where replacement items are available.

GM1 NCC.IDE.A.190 First-aid kit

ED Decision 2021/005/R

LOCATION

The location of the first-aid kit in the cabin is normally indicated using internationally recognisable signs.

GM2 NCC.IDE.A.190 First-aid kit

ED Decision 2021/005/R

STORAGE

As a best practice and wherever practicable, the emergency medical equipment listed under [AMC1 NCC.IDE.A.190](#) should be kept close together.

GM3 NCC.IDE.A.190 First-aid kit

ED Decision 2021/005/R

CONTENT OF FIRST-AID KITS

The operator may supplement first-aid kits according to the characteristics of the operation based on a risk assessment. The assessment does not require an approval by the competent authority.

GM4 NCC.IDE.A.190 First-aid kit

ED Decision 2021/005/R

LITHIUM BATTERIES

Risks related to the presence of lithium batteries should be assessed. All equipment powered by lithium batteries carried on an aeroplane should comply with the provisions of [AMC1 NCC.GEN.130\(f\)](#) including applicable technical standards such as (E)TSO-C142.

NCC.IDE.A.195 Supplemental oxygen – pressurised aeroplanes

Regulation (EU) No 800/2013

- (a) Pressurised aeroplanes operated at flight altitudes for which the oxygen supply is required in accordance with (b) shall be equipped with oxygen storage and dispensing apparatus capable of storing and dispensing the required oxygen supplies.
- (b) Pressurised aeroplanes operated above flight altitudes at which the pressure altitude in the passenger compartments is above 10 000 ft shall carry enough breathing oxygen to supply:
 - (1) all crew members and:
 - (i) 100 % of the passengers for any period when the cabin pressure altitude exceeds 15 000 ft, but in no case less than 10 minutes' supply;
 - (ii) at least 30 % of the passengers, for any period when, in the event of loss of pressurisation and taking into account the circumstances of the flight, the pressure altitude in the passenger compartment will be between 14 000 ft and 15 000 ft; and
 - (iii) at least 10 % of the passengers for any period in excess of 30 minutes when the pressure altitude in the passenger compartment will be between 10 000 ft and 14 000 ft;
 - (2) all the occupants of the passenger compartment for no less than 10 minutes, in the case of aeroplanes operated at pressure altitudes above 25 000 ft, or operated below that altitude, but under conditions that will not allow them to descend safely to a pressure altitude of 13 000 ft within 4 minutes.
- (c) Pressurised aeroplanes operated at flight altitudes above 25 000 ft shall, in addition, be equipped with:
 - (1) a device to provide a warning indication to the flight crew of any loss of pressurisation; and
 - (2) quick donning masks for flight crew members.

AMC1 NCC.IDE.A.195 Supplemental oxygen – pressurised aeroplanes

ED Decision 2013/021/R

DETERMINATION OF OXYGEN

- (a) In the determination of the amount of oxygen required for the routes to be flown, it is assumed that the aeroplane will descend in accordance with the emergency procedures specified in the operations manual, without exceeding its operating limitations, to a flight altitude that will

allow the flight to be completed safely (i.e. flight altitudes ensuring adequate terrain clearance, navigational accuracy, hazardous weather avoidance, etc.).

- (b) The amount of oxygen should be determined on the basis of cabin pressure altitude and flight duration, and on the assumption that a cabin pressurisation failure will occur at the pressure altitude or point of flight that is most critical from the standpoint of oxygen need.
- (c) Following a cabin pressurisation failure, the cabin pressure altitude should be considered to be the same as the aeroplane pressure altitude, unless it can be demonstrated to the competent authority that no probable failure of the cabin or pressurisation system will result in a cabin pressure altitude equal to the aeroplane pressure altitude. Under these circumstances, the demonstrated maximum cabin pressure altitude may be used as a basis for determination of oxygen supply.

GM1 NCC.IDE.A.195(c)(2) Supplemental oxygen – pressurised aeroplanes

ED Decision 2013/021/R

QUICK DONNING MASKS

A quick donning mask is a type of mask that:

- (a) can be placed on the face from its ready position, properly secured, sealed and supplying oxygen upon demand, with one hand and within 5 seconds and will thereafter remain in position, both hands being free;
- (b) can be donned without disturbing eye glasses and without delaying the flight crew member from proceeding with assigned emergency duties;
- (c) once donned, does not prevent immediate communication between the flight crew members and other crew members over the aircraft intercommunication system; and
- (d) does not inhibit radio communications.

NCC.IDE.A.200 Supplemental oxygen – non-pressurised aeroplanes

Regulation (EU) No 800/2013

- (a) Non-pressurised aeroplanes operated at flight altitudes when the oxygen supply is required in accordance with (b) shall be equipped with oxygen storage and dispensing apparatus capable of storing and dispensing the required oxygen supplies.
- (b) Non-pressurised aeroplanes operated above flight altitudes at which the pressure altitude in the passenger compartments is above 10 000 ft shall carry enough breathing oxygen to supply:
 - (1) all crew members and at least 10 % of the passengers for any period in excess of 30 minutes when the pressure altitude in the passenger compartment will be between 10 000 ft and 13 000 ft; and
 - (2) all crew members and passengers for any period that the pressure altitude in the passenger compartments will be above 13 000 ft.

AMC1 NCC.IDE.A.200 Supplemental oxygen – non-pressurised aeroplanes

ED Decision 2013/021/R

DETERMINATION OF OXYGEN

- (a) On routes where the oxygen is necessary to be carried for 10 % of the passengers for the flight time between 10 000 ft and 13 000 ft, the oxygen may be provided by:
 - (1) a plug-in or drop-out oxygen system with sufficient outlets and dispensing units uniformly distributed throughout the cabin so as to provide oxygen to each passenger at his/her own discretion when seated on his/her assigned seat; or
 - (2) portable bottles, when a cabin crew member is required for the flight.
- (b) The amount of supplemental oxygen for sustenance for a particular operation should be determined on the basis of flight altitudes and flight duration, consistent with the operating procedures, including emergency procedures, established for each operation and the routes to be flown, as specified in the operations manual.

NCC.IDE.A.205 Hand fire extinguishers

Regulation (EU) No 800/2013

- (a) Aeroplanes shall be equipped with at least one hand fire extinguisher:
 - (1) in the flight crew compartment; and
 - (2) in each passenger compartment that is separate from the flight crew compartment, except if the compartment is readily accessible to the flight crew.
- (b) The type and quantity of extinguishing agent for the required fire extinguishers shall be suitable for the type of fire likely to occur in the compartment where the extinguisher is intended to be used and to minimise the hazard of toxic gas concentration in compartments occupied by persons.

AMC1 NCC.IDE.A.205 Hand fire extinguishers

ED Decision 2013/021/R

NUMBER, LOCATION AND TYPE

- (a) The number and location of hand fire extinguishers should be such as to provide adequate availability for use, account being taken of the number and size of the passenger compartments, the need to minimise the hazard of toxic gas concentrations and the location of toilets, galleys, etc. These considerations may result in the number of fire extinguishers being greater than the minimum required.
- (b) There should be at least one hand fire extinguisher installed in the flight crew compartment and this should be suitable for fighting both flammable fluid and electrical equipment fires. Additional hand fire extinguishers may be required for the protection of other compartments accessible to the crew in flight. Dry chemical fire extinguishers should not be used in the flight crew compartment, or in any compartment not separated by a partition from the flight crew compartment, because of the adverse effect on vision during discharge and, if conductive, interference with electrical contacts by the chemical residues.
- (c) Where only one hand fire extinguisher is required in the passenger compartments, it should be located near the cabin crew member's station, where provided.

- (d) Where two or more hand fire extinguishers are required in the passenger compartments and their location is not otherwise dictated by consideration of (a), an extinguisher should be located near each end of the cabin with the remainder distributed throughout the cabin as evenly as is practicable.
- (e) Unless an extinguisher is clearly visible, its location should be indicated by a placard or sign. Appropriate symbols may also be used to supplement such a placard or sign.

NCC.IDE.A.206 Crash axe and crowbar

Regulation (EU) No 800/2013

- (a) Aeroplanes with an MCTOM of more than 5 700 kg or with an MOPSC of more than nine shall be equipped with at least one crash axe or crowbar located in the flight crew compartment.
- (b) In the case of aeroplanes with an MOPSC of more than 200, an additional crash axe or crowbar shall be installed in or near the rearmost galley area.
- (c) Crash axes and crowbars located in the passenger compartment shall not be visible to passengers.

NCC.IDE.A.210 Marking of break-in points

Regulation (EU) No 800/2013

If areas of the aeroplane's fuselage suitable for break-in by rescue crews in an emergency are marked, such areas shall be marked as shown in Figure 1.

Figure 1

Marking of break-in points

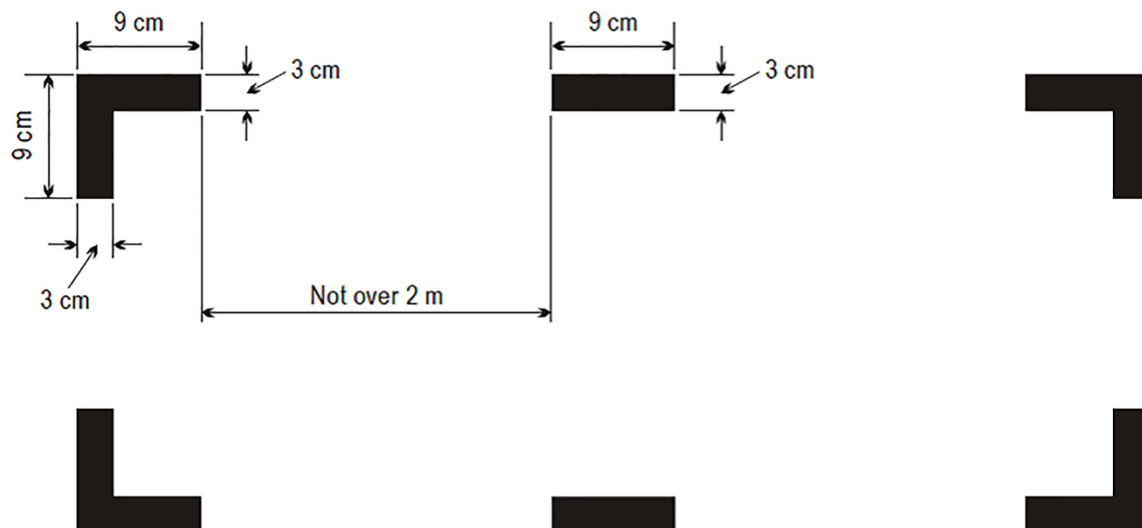

AMC1 NCC.IDE.A.210 Marking of break-in points

ED Decision 2013/021/R

MARKINGS – COLOUR AND CORNERS

- (a) The colour of the markings should be red or yellow and, if necessary, should be outlined in white to contrast with the background.
- (b) If the corner markings are more than 2 m apart, intermediate lines 9 cm x 3 cm should be inserted so that there is no more than 2 m between adjacent markings.

NCC.IDE.A.215 Emergency locator transmitter (ELT)

Regulation (EU) 2015/2338

- (a) Aeroplanes shall be equipped with:
 - (1) an ELT of any type or an aircraft localisation means meeting the requirement of Annex IV (Part CAT), [CAT.GEN.MPA.210](#), to Regulation (EU) No 965/2012, when first issued with an individual CofA on or before 1 July 2008;
 - (2) an automatic ELT or an aircraft localisation means meeting the requirement of Annex IV (Part CAT), [CAT.GEN.MPA.210](#), to Regulation (EU) No 965/2012, when first issued with an individual CofA after 1 July 2008.
- (b) ELTs of any type shall be capable of transmitting simultaneously on 121,5 MHz and 406 MHz.

AMC1 NCC.IDE.A.215 Emergency locator transmitter (ELT)

ED Decision 2013/021/R

ELT BATTERIES

Batteries used in the ELTs should be replaced (or recharged, if the battery is rechargeable) when the equipment has been in use for more than 1 cumulative hour, and also when 50 % of their useful life (or for rechargeable, 50 % of their useful life of charge), as established by the equipment manufacturer, has expired. The new expiry date for the replacement (or recharged) battery should be legibly marked on the outside of the equipment. The battery useful life (or useful life of charge) requirements of this paragraph do not apply to batteries (such as water-activated batteries) that are essentially unaffected during probable storage intervals.

AMC2 NCC.IDE.A.215 Emergency locator transmitter (ELT)

ED Decision 2021/008/R

TYPES OF ELTs AND GENERAL TECHNICAL SPECIFICATIONS

- (a) Point (a) of [AMC2 CAT.IDE.A.280](#) lists the applicable types of ELTs.
- (b) To minimise the possibility of damage in the event of a crash impact, the ELT(AF), ELT(AP), ELT(AD), and ELT(DT) should be rigidly fixed to the aircraft structure, as far as is practicable, with its antenna and connections arranged so as to maximise the probability of the signal being transmitted after a crash.
- (c) Point (c) of [AMC2 CAT.IDE.A.280](#) on crash survivability and homing-signal capability applies.
- (d) Any ELT carried should operate in accordance with the relevant provisions of ICAO Annex 10, Volume III and should be registered with the national agency responsible for initiating search and rescue or other nominated agency.

GM1 NCC.IDE.A.215 Emergency locator transmitter (ELT)

ED Decision 2021/008/R

TERMINOLOGY

[GM1 CAT.IDE.A.280](#) provides explanations of terms used in point [NCC.IDE.A.215](#) and in the related AMC.

GM2 NCC.IDE.A.215 Emergency locator transmitter (ELT)

ED Decision 2021/008/R

ADDITIONAL GUIDANCE

The guidance provided in [GM2 CAT.IDE.A.280](#) is also applicable to point [NCC.IDE.A.215](#).

NCC.IDE.A.220 Flight over water

Regulation (EU) No 800/2013

- (a) The following aeroplanes shall be equipped with a life-jacket for each person on board or equivalent individual flotation device for each person on board younger than 24 months, stowed in a position that is readily accessible from the seat or berth of the person for whose use it is provided:
 - (1) landplanes operated over water at a distance of more than 50 NM from land or taking off or landing at an aerodrome or operating site where, in the opinion of the pilot-in-command, the take-off or approach path is so disposed over water that there would be a likelihood of a ditching; and
 - (2) seaplanes operated over water.
- (b) Each life-jacket or equivalent individual flotation device shall be equipped with a means of electric illumination for the purpose of facilitating the location of persons.
- (c) Seaplanes operated over water shall be equipped with:
 - (1) a sea anchor and other equipment necessary to facilitate mooring, anchoring or manoeuvring the aeroplane on water, appropriate to its size, weight and handling characteristics; and
 - (2) equipment for making the sound signals as prescribed in the International Regulations for Preventing Collisions at Sea, where applicable.
- (d) The pilot-in-command of an aeroplane operated at a distance away from land where an emergency landing is possible greater than that corresponding to 30 minutes at normal cruising speed or 50 NM, whichever is the lesser, shall determine the risks to survival of the occupants of the aeroplane in the event of a ditching, based on which he/she shall determine the carriage of:
 - (1) equipment for making the distress signals;
 - (2) life-rafts in sufficient numbers to carry all persons on board, stowed so as to facilitate their ready use in emergency; and
 - (3) life-saving equipment to provide the means of sustaining life, as appropriate to the flight to be undertaken.

AMC1 NCC.IDE.A.220 Flight over water

ED Decision 2013/021/R

ACCESSIBILITY OF LIFE-JACKETS

The life-jacket should be accessible from the seat or berth of the person for whose use it is provided, with a safety belt or restraint system fastened.

ELECTRIC ILLUMINATION OF LIFE-JACKETS

The means of electric illumination should be a survivor locator light as defined in the applicable ETSO issued by the Agency or equivalent.

RISK ASSESSMENT

- (a) When conducting the risk assessment, the pilot-in-command should base his/her decision, as far as is practicable, on the Implementing Rules and AMCs applicable to the operation of the aeroplane.
- (b) The pilot-in-command should, for determining the risk, take the following operating environment and conditions into account:
 - (1) sea state;
 - (2) sea and air temperatures;
 - (3) the distance from land suitable for making an emergency landing; and
 - (4) the availability of search and rescue facilities.

AMC2 NCC.IDE.A.220 Flight over water

ED Decision 2013/021/R

LIFE-RAFTS AND EQUIPMENT FOR MAKING DISTRESS SIGNALS

- (a) The following should be readily available with each life-raft:
 - (1) means for maintaining buoyancy;
 - (2) a sea anchor;
 - (3) life-lines and means of attaching one life-raft to another;
 - (4) paddles for life-rafts with a capacity of six or less;
 - (5) means of protecting the occupants from the elements;
 - (6) a water-resistant torch;
 - (7) signalling equipment to make the pyrotechnic distress signals described in ICAO Annex 2, Rules of the Air;
 - (8) 100 g of glucose tablets for each four, or fraction of four, persons that the life-raft is designed to carry;
 - (9) at least 2 litres of drinkable water provided in durable containers or means of making sea water drinkable or a combination of both; and
 - (10) first-aid equipment.
- (b) As far as practicable, items listed in (a) should be contained in a pack.

GM1 NCC.IDE.A.220 Flight over water

ED Decision 2013/021/R

SEAT CUSHIONS

Seat cushions are not considered to be flotation devices.

NCC.IDE.A.230 Survival equipment

Regulation (EU) No 800/2013

- (a) Aeroplanes operated over areas in which search and rescue would be especially difficult shall be equipped with:
- (1) signalling equipment to make the distress signals;
 - (2) at least one survival ELT(S); and
 - (3) additional survival equipment for the route to be flown taking account of the number of persons on board.
- (b) The additional survival equipment specified in (a)(3) does not need to be carried when the aeroplane:
- (1) remains within a distance from an area where search and rescue is not especially difficult corresponding to:
 - (i) 120 minutes at one-engine-inoperative (OEI) cruising speed for aeroplanes capable of continuing the flight to an aerodrome with the critical engine(s) becoming inoperative at any point along the route or planned diversion routes; or
 - (ii) 30 minutes at cruising speed for all other aeroplanes;or
 - (2) remains within a distance no greater than that corresponding to 90 minutes at cruising speed from an area suitable for making an emergency landing, for aeroplanes certified in accordance with the applicable airworthiness standard.

AMC1 NCC.IDE.A.230(a)(2) Survival equipment

ED Decision 2013/021/R

SURVIVAL ELT

An ELT(AP) may be used to replace one required ELT(S) provided that it meets the ELT(S) requirements. A water-activated ELT(S) is not an ELT(AP).

AMC1 NCC.IDE.A.230(a)(3) Survival equipment

ED Decision 2013/021/R

ADDITIONAL SURVIVAL EQUIPMENT

- (a) The following additional survival equipment should be carried when required:
- (1) 500 ml of water for each four, or fraction of four, persons on board;
 - (2) one knife;
 - (3) first-aid equipment; and
 - (4) one set of air/ground codes.

- (b) In addition, when polar conditions are expected, the following should be carried:
- (1) a means of melting snow;
 - (2) one snow shovel and one ice saw;
 - (3) sleeping bags for use by 1/3 of all persons on board and space blankets for the remainder or space blankets for all passengers on board; and
 - (4) one arctic/polar suit for each crew member carried.
- (c) If any item of equipment contained in the above list is already carried on board the aircraft in accordance with another requirement, there is no need for this to be duplicated.

AMC1 NCC.IDE.A.230(b)(2) Survival equipment

ED Decision 2013/021/R

APPLICABLE AIRWORTHINESS STANDARD

The applicable airworthiness standard should be CS-25 or equivalent.

GM1 NCC.IDE.A.230 Survival equipment

ED Decision 2013/021/R

SIGNALLING EQUIPMENT

The signalling equipment for making distress signals is described in ICAO Annex 2, Rules of the Air.

GM2 NCC.IDE.A.230 Survival equipment

ED Decision 2013/021/R

AREAS IN WHICH SEARCH AND RESCUE WOULD BE ESPECIALLY DIFFICULT

The expression 'areas in which search and rescue would be especially difficult' should be interpreted, in this context, as meaning:

- (a) areas so designated by the competent authority responsible for managing search and rescue; or
- (b) areas that are largely uninhabited and where:
 - (1) the authority referred to in (a) has not published any information to confirm whether search and rescue would be or would not be especially difficult; and
 - (2) the authority referred to in (a) does not, as a matter of policy, designate areas as being especially difficult for search and rescue.

NCC.IDE.A.240 Headset

Regulation (EU) No 800/2013

- (a) Aeroplanes shall be equipped with a headset with a boom microphone or equivalent for each flight crew member at their assigned station in the flight crew compartment.
- (b) Aeroplanes operated under IFR or at night shall be equipped with a transmit button on the manual pitch and roll control for each required flight crew member.

AMC1 NCC.IDE.A.240 Headset

ED Decision 2013/021/R

GENERAL

- (a) A headset consists of a communication device that includes two earphones to receive and a microphone to transmit audio signals to the aeroplane's communication system. To comply with the minimum performance requirements, the earphones and microphone should match the communication system's characteristics and the flight crew compartment environment. The headset should be adequately adjustable in order to fit the flight crew's head. Headset boom microphones should be of the noise cancelling type.
- (b) If the intention is to utilise noise cancelling earphones, the operator should ensure that the earphones do not attenuate any aural warnings or sounds necessary for alerting the flight crew on matters related to the safe operation of the aeroplane.

GM1 NCC.IDE.A.240 Headset

ED Decision 2013/021/R

GENERAL

The term 'headset' includes any aviation helmet incorporating headphones and microphone worn by a flight crew member.

NCC.IDE.A.245 Radio communication equipment

Regulation (EU) No 800/2013

- (a) Aeroplanes operated under IFR or at night, or when required by the applicable airspace requirements, shall be equipped with radio communication equipment that, under normal radio propagating conditions, shall be capable of:
 - (1) conducting two-way communication for aerodrome control purposes;
 - (2) receiving meteorological information at any time during flight;
 - (3) conducting two-way communication at any time during flight with those aeronautical stations and on those frequencies prescribed by the appropriate authority; and
 - (4) providing for communication on the aeronautical emergency frequency 121,5 MHz.
- (b) When more than one communication equipment unit is required, each shall be independent of the other or others to the extent that a failure in any one will not result in failure of any other.

AMC1 NCC.IDE.A.245 & NCC.IDE.A.250 Radio communication equipment & Navigation equipment

ED Decision 2021/005/R

PERFORMANCE-BASED COMMUNICATION AND SURVEILLANCE (PBCS) OPERATIONS

For operations in airspaces where required communication performance (RCP) and required surveillance performance (RSP) for PBCS have been prescribed, the operator should:

- (a) ensure that the communication equipment and surveillance equipment meet the prescribed RCP and RSP specifications respectively, as shown by an AFM statement or equivalent.
- (b) ensure that operational constraints are reflected in the MEL;

- (c) establish and include in the OM:
 - (1) normal, abnormal and contingency procedures;
 - (2) the flight crew qualification and proficiency constraints; and
 - (3) a training programme for relevant personnel consistent with the intended operations;
- (d) ensure continued airworthiness of the communication equipment and surveillance equipment in accordance with the appropriate RCP and RSP specifications respectively;
- (e) ensure that the contracted communication service provider (CSP) for the airspace being flown complies with the required RCP and RSP specifications as well as with monitoring, recording and notification requirements; and
- (f) participate to monitoring programmes established in the airspace being flown in order to:
 - (1) submit the relevant reports of observed communication and surveillance performance respectively; and
 - (2) establish a process for immediate corrective action in case non-compliance with the appropriate RCP or RSP specifications is detected.

GM1 NCC.IDE.A.245 Radio communication equipment

ED Decision 2013/021/R

APPLICABLE AIRSPACE REQUIREMENTS

For aeroplanes being operated under European air traffic control, the applicable airspace requirements include the Single European Sky legislation.

GM1 NCC.IDE.A.245 & NCC.IDE.A.250 Radio communication equipment & Navigation equipment

ED Decision 2021/005/R

PBCS OPERATIONS — GENERAL

Detailed guidance material on PBCS operations may be found in the following documents:

- (a) ICAO Doc 9869 'Performance-based Communication and Surveillance (PBCS) Manual'
- (b) ICAO Doc 10037 'Global Operational Data Link (GOLD) Manual'

PBCS OPERATIONS — AIRCRAFT ELIGIBILITY

- (a) The aircraft eligibility for compliance with the required RCP/RSP specifications should be demonstrated by the aircraft manufacturer or equipment supplier and be specific to each individual aircraft or the combination of the aircraft type and the equipment. The demonstrated compliance with specific RCP/RSP specifications may be documented in one of the following documents:
 - (1) the type certificate (TC);
 - (2) the supplemental type certificate (STC);
 - (3) the aeroplane flight manual (AFM) or AFM Supplement; or

- (4) a compliance statement from the manufacturer or the holder of the design approval of the data link installation, approved by the State of Design.
- (b) In addition to the indication of compliance with specific RCP/RSP specifications, the aircraft manufacturer or equipment supplier should document any associated operating limitations, information and procedures in the AFM or other appropriate documents.

PBCS OPERATIONS — MEL ENTRIES

- (a) The operator should amend the MEL, in accordance with the items identified by the aircraft manufacturer or equipment supplier in the master minimum equipment list (MMEL) or MMEL supplement, in relation to PBCS capability, to address the impact of losing an associated system/sub-system on data link operational capability.
- (b) As an example, equipment required in current FANS 1/A-capable aircraft, potentially affecting RCP and RSP capabilities, may be the following:
 - (1) VHF, SATCOM, or HFDDL1 radios, as applicable;
 - (2) ACARS management unit (MU)/communications management unit (CMU);
 - (3) flight management computer (FMC) integration; and
 - (4) printer, if procedures require its use.

PBCS OPERATIONS — OPERATING PROCEDURES

The operator should establish operating procedures for the flight crew and other relevant personnel, such as but not limited to, flight dispatchers and maintenance personnel. These procedures should cover the usage of PBCS-relevant systems and include as a minimum:

- (a) pre-flight planning requirements including MEL consideration and flight plan filing;
- (b) actions to be taken in the data link operation, to include specific RCP/RSP required cases;
- (c) actions to be taken for the loss of data link capability while in and prior to entering the airspace requiring specific RCP/RSP specifications. Examples may be found in ICAO Doc 10037;
- (d) problem reporting procedures to the local/regional PBCS monitoring body or central reporting body as applicable; and
- (e) compliance with specific regional requirements and procedures, if applicable.

PBCS OPERATIONS — QUALIFICATION AND TRAINING

- (a) The operator should ensure that flight crew and other relevant personnel such as flight dispatchers and maintenance personnel are proficient with PBCS operations. A separate training programme is not required if data link communication is integrated in the current training programme. However, the operator should ensure that the existing training programme incorporates a basic PBCS concept and requirements for flight crew and other personnel that have direct impact on overall data link performance required for the provisions of air traffic services such as reduced separation.
- (b) The elements covered during the training should be as a minimum:
 - (1) Flight crew
 - (i) Data link communication system theory relevant to operational use;
 - (ii) AFM limitations;
 - (iii) Normal pilot response to data link communication messages;

- (iv) Message elements in the message set used in each environment;
- (v) RCP/RSP specifications and their performance requirements;
- (vi) Implementation of performance-based reduced separation with associated RCP/RSP specifications or other possible performance requirements associated with their routes;
- (vii) Other ATM operations involving data link communication services;
- (viii) Normal, non-normal and contingency procedures; and
- (ix) Data link communication failure/problem and reporting.

Note (1) If flight crew has already been trained on data link operations, additional training only on PBCS is required, addressing a basic concept and requirements that have direct impact on overall data link performance required for provisions of air traffic services (e.g. reduced separation).

Note (2) Training may be provided through training material and other means that simulate the functionality.

- (2) Dispatchers/flight operations officers
 - (i) Proper use of data link and PBCS flight plan designators;
 - (ii) Air traffic service provider's separation criteria and procedures relevant to RCP/RSP specifications;
 - (iii) MEL remarks or exceptions based on data link communication;
 - (iv) Procedures for transitioning to voice communication and other contingency procedures related to the operation in the event of abnormal behaviour of the data link communication;
 - (v) Coordination with the ATS unit related to, or following a special data link communication exceptional event (e.g. log-on or connection failures); and
 - (vi) Contingency procedures to transition to a different separation standard when data link communication fails.
- (3) Engineering and maintenance personnel
 - (i) Data link communication equipment including its installation, maintenance and modification;
 - (ii) MEL relief and procedures for return to service authorisations; and
 - (iii) Correction of reported non-performance of data link system.

PBCS OPERATIONS — CONTINUED AIRWORTHINESS

- (a) The operator should ensure that aircraft systems are properly maintained to continue to meet the applicable RCP/RSP specifications.
- (b) The operator should ensure that the following elements are documented and managed appropriately:
 - (1) configuration and equipment list detailing the pertinent hardware and software components for the aircraft/fleet(s) applicable to the specific RCP/RSP operation;
 - (2) configuration control for subnetwork, communication media and routing policies; and

- (3) description of systems including display and alerting functions (including message sets).

PBCS OPERATIONS — CSP COMPLIANCE

- (a) The operator should ensure that their contracted CSPs notify the ATS units of any failure condition that may have an impact on PBCS operations. Notification should be made to all relevant ATS units regardless of whether the CSP has a contract with them.
- (b) The operator may demonstrate the compliance of their contracted CSP through service level agreements (SLAs)/contractual arrangements for data link services or through a joint agreement among PBCS stakeholders such as a Memorandum of understanding (MOU) or a PBCS Charter.

PBCS OPERATIONS — PBCS CHARTER

A PBCS charter has been developed by PBCS stakeholders and is available as an alternative to SLAs in order to validate the agreement between the operator and the CSP for compliance with RCP/RSP required for PBCS operations. The charter is hosted on the website www.FANS-CRA.com where operators and CSPs can subscribe.

PBCS OPERATIONS — PARTICIPATION IN MONITORING PROGRAMMES

- (a) The operator should establish a process to participate in local or regional PBCS monitoring programmes and provide the following information, including any subsequent changes, to monitoring bodies:
 - (1) operator name;
 - (2) operator contact details; and
 - (3) other coordination information as applicable, including appropriate information means for the CSP/SSP service fail notification.
- (b) The process should also address the actions to be taken with respect to problem reporting and resolution of deficiencies, such as:
 - (1) reporting problems identified by the flight crew or other personnel to the PBCS monitoring bodies associated with the route of flight on which the problem occurred
 - (2) disclosing operational data in a timely manner to the appropriate PBCS monitoring bodies when requested for the purposes of investigating a reported problem
 - (3) investigating and resolving the cause of the deficiencies reported by the PBCS monitoring bodies.

NCC.IDE.A.250 Navigation equipment*Regulation (EU) 2019/1384*

- (a) Aeroplanes shall be equipped with navigation equipment that will enable them to proceed in accordance with:
 - (1) the ATS flight plan, if applicable; and
 - (2) the applicable airspace requirements.
- (b) Aeroplanes shall have sufficient navigation equipment to ensure that, in the event of the failure of one item of equipment at any stage of the flight, the remaining equipment shall allow safe navigation in accordance with (a), or an appropriate contingency action, to be completed safely.

- (c) Aeroplanes operated on flights in which it is intended to land in IMC shall be equipped with suitable equipment capable of providing guidance to a point from which a visual landing can be performed. This equipment shall be capable of providing such guidance for each aerodrome at which it is intended to land in IMC and for any designated alternate aerodromes.
- (d) For PBN operations the aircraft shall meet the airworthiness certification requirements for the appropriate navigation specification.
- (e) Aeroplanes shall be equipped with surveillance equipment in accordance with the applicable airspace requirements.

GM1 NCC.IDE.A.250 Navigation equipment

ED Decision 2016/017/R

AIRCRAFT ELIGIBILITY FOR PBN SPECIFICATION NOT REQUIRING SPECIFIC APPROVAL

- (a) The performance of the aircraft is usually stated in the AFM.
- (b) Where such a reference cannot be found in the AFM, other information provided by the aircraft manufacturer as TC holder, the STC holder or the design organisation having a privilege to approve minor changes may be considered.
- (c) The following documents are considered acceptable sources of information:
 - (1) AFM, supplements thereto, and documents directly referenced in the AFM;
 - (2) FCOM or similar document;
 - (3) Service Bulletin or Service Letter issued by the TC holder or STC holder;
 - (4) approved design data or data issued in support of a design change approval;
 - (5) any other formal document issued by the TC or STC holders stating compliance with PBN specifications, AMC, Advisory Circulars (AC) or similar documents issued by the State of Design; and
 - (6) written evidence obtained from the State of Design.
- (d) Equipment qualification data, in itself, is not sufficient to assess the PBN capabilities of the aircraft, since the latter depend on installation and integration.
- (e) As some PBN equipment and installations may have been certified prior to the publication of the PBN Manual and the adoption of its terminology for the navigation specifications, it is not always possible to find a clear statement of aircraft PBN capability in the AFM. However, aircraft eligibility for certain PBN specifications can rely on the aircraft performance certified for PBN procedures and routes prior to the publication of the PBN Manual.
- (f) Below, various references are listed which may be found in the AFM or other acceptable documents (see listing above) in order to consider the aircraft's eligibility for a specific PBN specification if the specific term is not used.
- (g) RNAV 5
 - (1) If a statement of compliance with any of the following specifications or standards is found in the acceptable documentation as listed above, the aircraft is eligible for RNAV 5 operations.
 - (i) B-RNAV;
 - (ii) RNAV 1;

- (iii) RNP APCH;
 - (iv) RNP 4;
 - (v) A-RNP;
 - (vi) AMC 20-4;
 - (vii) JAA TEMPORARY GUIDANCE MATERIAL, LEAFLET NO. 2 (TGL 2);
 - (viii) JAA AMJ 20X2;
 - (ix) FAA AC 20-130A for en route operations;
 - (x) FAA AC 20-138 for en route operations; and
 - (xi) FAA AC 90-96.
- (h) RNAV 1/RNAV 2
- (1) If a statement of compliance with any of the following specifications or standards is found in the acceptable documentation as listed above, the aircraft is eligible for RNAV 1/RNAV 2 operations.
 - (i) RNAV 1;
 - (ii) PRNAV;
 - (iii) US RNAV type A;
 - (iv) FAA AC 20-138 for the appropriate navigation specification;
 - (v) FAA AC 90-100A;
 - (vi) JAA TEMPORARY GUIDANCE MATERIAL, LEAFLET NO. 10 Rev1 (TGL 10); and
 - (vii) FAA AC 90-100.
 - (2) However, if position determination is exclusively computed based on VOR-DME, the aircraft is not eligible for RNAV 1/RNAV 2 operations.
- (i) RNP 1/RNP 2 continental
- (1) If a statement of compliance with any of the following specifications or standards is found in the acceptable documentation as listed above, the aircraft is eligible for RNP 1/RNP 2 continental operations.
 - (i) A-RNP;
 - (ii) FAA AC 20-138 for the appropriate navigation specification; and
 - (iii) FAA AC 90-105.
 - (2) Alternatively, if a statement of compliance with any of the following specifications or standards is found in the acceptable documentation as listed above and position determination is primarily based on GNSS, the aircraft is eligible for RNP 1/RNP 2 continental operations.

However, in the cases mentioned in:

 - (i) JAA TEMPORARY GUIDANCE MATERIAL, LEAFLET NO. 10 (TGL 10) (any revision); and
 - (ii) FAA AC 90-100,

loss of GNSS implies loss of RNP 1/RNP 2 capability.

(j) RNP APCH — LNAV minima

(1) If a statement of compliance with any of the following specifications or standards is found in the acceptable documentation as listed above, the aircraft is eligible for RNP APCH — LNAV operations.

- (i) A-RNP;
- (ii) AMC 20-27;
- (iii) AMC 20-28;
- (iv) FAA AC 20-138 for the appropriate navigation specification; and
- (v) FAA AC 90-105 for the appropriate navigation specification.

(2) Alternatively, if a statement of compliance with RNP 0.3 GNSS approaches in accordance with any of the following specifications or standards is found in the acceptable documentation as listed above, the aircraft is eligible for RNP APCH — LNAV operations. Any limitation such as ‘within the US National Airspace’ may be ignored since RNP APCH procedures are assumed to meet the same ICAO criteria around the world.

- (i) JAA TEMPORARY GUIDANCE MATERIAL, LEAFLET NO. 3 (TGL 3);
- (ii) AMC 20-4;
- (iii) FAA AC 20-130A; and
- (iv) FAA AC 20-138.

(k) RNP APCH — LNAV/VNAV minima

(1) If a statement of compliance with any of the following specifications or standards is found in the acceptable documentation as listed above, the aircraft is eligible for RNP APCH — LNAV/VNAV operations.

- (i) A-RNP;
- (ii) AMC 20-27 with Baro VNAV;
- (iii) AMC 20-28;
- (iv) FAA AC 20-138; and
- (v) FAA AC 90-105 for the appropriate navigation specification.

(2) Alternatively, if a statement of compliance with FAA AC 20-129 is found in the acceptable documentation as listed above, and the aircraft complies with the requirements and limitations of EASA SIB 2014-041, the aircraft is eligible for RNP APCH — LNAV/VNAV operations. Any limitation such as ‘within the US National Airspace’ may be ignored since RNP APCH procedures are assumed to meet the same ICAO criteria around the world.

(l) RNP APCH — LPV minima

(1) If a statement of compliance with any of the following specifications or standards is found in the acceptable documentation as listed above, the aircraft is eligible for RNP APCH — LPV operations.

¹ <http://ad.easa.europa.eu/ad/2014-04>

- (i) AMC 20-28;
 - (ii) FAA AC 20-138 for the appropriate navigation specification; and
 - (iii) FAA AC 90-107.
 - (2) For aircraft that have a TAWS Class A installed and do not provide Mode-5 protection on an LPV approach, the DH is limited to 250 ft.
- (m) RNAV 10
- (1) If a statement of compliance with any of the following specifications or standards is found in the acceptable documentation as listed above, the aircraft is eligible for RNAV 10 operations.
 - (i) RNP 10;
 - (ii) FAA AC 20-138 for the appropriate navigation specification;
 - (iii) AMC 20-12;
 - (iv) FAA Order 8400.12 (or later revision); and
 - (v) FAA AC 90-105.
- (n) RNP 4
- (1) If a statement of compliance with any of the following specifications or standards is found in the acceptable documentation as listed above, the aircraft is eligible for RNP 4 operations.
 - (i) FAA AC 20-138B or later, for the appropriate navigation specification;
 - (ii) FAA Order 8400.33; and
 - (iii) FAA AC 90-105 for the appropriate navigation specification.
- (o) RNP 2 oceanic
- (1) If a statement of compliance with FAA AC 90-105 for the appropriate navigation specification is found in the acceptable documentation as listed above, the aircraft is eligible for RNP 2 oceanic operations.
 - (2) If the aircraft has been assessed eligible for RNP 4, the aircraft is eligible for RNP 2 oceanic.
- (p) Special features
- (1) RF in terminal operations (used in RNP 1 and in the initial segment of the RNP APCH)
 - (i) If a statement of demonstrated capability to perform an RF leg, certified in accordance with any of the following specifications or standards, is found in the acceptable documentation as listed above, the aircraft is eligible for RF in terminal operations.
 - (A) AMC 20-26; and
 - (B) FAA AC 20-138B or later.
 - (ii) If there is a reference to RF and a reference to compliance with AC 90-105, then the aircraft is eligible for such operations.

- (q) Other considerations
- (1) In all cases, the limitations in the AFM need to be checked, in particular the use of AP or FD which can be required to reduce the FTE primarily for RNP APCH, RNAV 1, and RNP 1.
 - (2) Any limitation such as ‘within the US National Airspace’ may be ignored since RNP APCH procedures are assumed to meet the same ICAO criteria around the world.

GM2 NCC.IDE.A.250 Navigation equipment

ED Decision 2013/021/R

GENERAL

- (a) The PBN specifications for which the aircraft complies with the relevant airworthiness criteria are set out in the AFM, together with any limitations to be observed.
- (b) Because functional and performance requirements are defined for each navigation specification, an aircraft approved for an RNP specification is not automatically approved for all RNAV specifications. Similarly, an aircraft approved for an RNP or RNAV specification having a stringent accuracy requirement (e.g. RNP 0.3 specification) is not automatically approved for a navigation specification having a less stringent accuracy requirement (e.g. RNP 4).

RNP 4

- (c) For RNP 4, at least two LRNSs, capable of navigating to RNP 4, and listed in the AFM, may be operational at the entry point of the RNP 4 airspace. If an item of equipment required for RNP 4 operations is unserviceable, then the flight crew may consider an alternate route or diversion for repairs. For multi-sensor systems, the AFM may permit entry if one GNSS sensor is lost after departure, provided one GNSS and one inertial sensor remain available.

NCC.IDE.A.255 Transponder

Regulation (EU) No 800/2013

Aeroplanes shall be equipped with a pressure altitude reporting secondary surveillance radar (SSR) transponder and any other SSR transponder capability required for the route being flown.

AMC1 NCC.IDE.A.255 Transponder

ED Decision 2013/021/R

SSR TRANSPONDER

- (a) The secondary surveillance radar (SSR) transponders of aeroplanes being operated under European air traffic control should comply with any applicable Single European Sky legislation.
- (b) If the Single European Sky legislation is not applicable, the SSR transponders should operate in accordance with the relevant provisions of Volume IV of ICAO Annex 10.

NCC.IDE.A.260 Management of aeronautical databases

Regulation (EU) 2016/1199

- (a) Aeronautical databases used on certified aircraft system applications shall meet data quality requirements that are adequate for the intended use of the data.
- (b) The operator shall ensure the timely distribution and insertion of current and unaltered aeronautical databases to all aircraft that require them.

- (c) Notwithstanding any other occurrence reporting requirements as defined in Regulation (EU) No 376/2014, the operator shall report to the database provider instances of erroneous, inconsistent or missing data that might be reasonably expected to constitute a hazard to flight.

In such cases, the operator shall inform flight crew and other personnel concerned, and shall ensure that the affected data is not used.

AMC1 NCC.IDE.A.260 Management of aeronautical databases

ED Decision 2017/003/R

AERONAUTICAL DATABASES

When the operator of an aircraft uses an aeronautical database that supports an airborne navigation application as a primary means of navigation used to meet the airspace usage requirements, the database provider should be a Type 2 DAT provider certified in accordance with Regulation (EU) 2017/373 or equivalent.

GM1 NCC.IDE.A.260 Management of aeronautical databases

ED Decision 2017/003/R

AERONAUTICAL DATABASE APPLICATIONS

- (a) Applications using aeronautical databases for which Type 2 DAT providers should be certified in accordance with Regulation (EU) 2017/373 may be found in GM1 DAT.OR.100.
- (b) The certification of a Type 2 DAT provider in accordance with Regulation (EU) 2017/373 ensures data integrity and compatibility with the certified aircraft application/equipment.

GM2 NCC.IDE.A.260 Management of aeronautical databases

ED Decision 2017/003/R

TIMELY DISTRIBUTION

The operator should distribute current and unaltered aeronautical databases to all aircraft requiring them in accordance with the validity period of the databases or in accordance with a procedure established in the operations manual if no validity period is defined.

GM3 NCC.IDE.A.260 Management of aeronautical databases

ED Decision 2017/003/R

STANDARDS FOR AERONAUTICAL DATABASES AND DAT PROVIDERS

- (a) A 'Type 2 DAT provider' is an organisation as defined in Article 2(5)(b) of Regulation (EU) 2017/373.
- (b) Equivalent to a certified 'Type 2 DAT provider' is defined in any Aviation Safety Agreement between the European Union and a third country, including any Technical Implementation Procedures, or any Working Arrangements between EASA and the competent authority of a third country.

SECTION 2 – HELICOPTERS

NCC.IDE.H.100 Instruments and equipment – general

Regulation (EU) 2019/1384

- (a) Instruments and equipment required by this Subpart shall be approved in accordance with the applicable airworthiness requirements if they are:
- (1) used by the flight crew to control the flight path;
 - (2) used to comply with [NCC.IDE.H.245](#);
 - (3) used to comply with [NCC.IDE.H.250](#); or
 - (4) installed in the helicopter.
- (b) The following items, when required by this Subpart, do not need an equipment approval:
- (1) independent portable light;
 - (2) an accurate time piece;
 - (3) chart holder;
 - (4) first-aid kit;
 - (5) survival and signalling equipment;
 - (6) sea anchor and equipment for mooring; and
 - (7) child restraint device.
- (c) Instruments and equipment or accessories not required under this Annex, as well as any other equipment which is not required under this Regulation, but carried on a flight, shall comply with the following requirements:
- (1) the information provided by those instruments, equipment or accessories shall not be used by the flight crew members to comply with Annex II to Regulation (EU) 2018/1139 or points [NCC.IDE.H.245](#) and [NCC.IDE.H.250](#) of this Annex;
 - (2) the instruments and equipment shall not affect the airworthiness of the helicopter, even in the case of failures or malfunction.
- (d) Instruments and equipment shall be readily operable or accessible from the station where the flight crew member that needs to use it is seated.
- (e) Those instruments that are used by a flight crew member shall be so arranged as to permit the flight crew member to see the indications readily from his/her station, with the minimum practicable deviation from the position and line of vision which he/she normally assumes when looking forward along the flight path.
- (f) All required emergency equipment shall be easily accessible for immediate use.

GM1 NCC.IDE.H.100(a) Instruments and equipment – general

ED Decision 2013/021/R

APPLICABLE AIRWORTHINESS REQUIREMENTS

The applicable airworthiness requirements for approval of instruments and equipment required by this Part are the following:

- (a) Regulation (EC) 748/2012 for:
 - (1) helicopters registered in the EU; and
 - (2) helicopters registered outside the EU but manufactured or designed by an EU organisation.
- (b) Airworthiness requirements of the state of registry for helicopters registered, designed and manufactured outside the EU.

GM1 NCC.IDE.H.100(b) Instruments and equipment – general

ED Decision 2017/010/R

REQUIRED INSTRUMENTS AND EQUIPMENT THAT DO NOT NEED TO BE APPROVED IN ACCORDANCE WITH THE APPLICABLE AIRWORTHINESS REQUIREMENTS

The functionality of non-installed instruments and equipment required by this Subpart and that do not need an equipment approval, as listed in [NCC.IDE.H.100\(b\)](#), should be checked against recognised industry standards appropriate to the intended purpose. The operator is responsible for ensuring the maintenance of these instruments and equipment.

GM1 NCC.IDE.H.100(c) Instruments and equipment – general

ED Decision 2017/010/R

NON-REQUIRED INSTRUMENTS AND EQUIPMENT THAT DO NOT NEED TO BE APPROVED IN ACCORDANCE WITH THE APPLICABLE AIRWORTHINESS REQUIREMENTS, BUT ARE CARRIED ON A FLIGHT

- (a) This Guidance Material does not exempt the item of equipment from complying with the applicable airworthiness requirements if the instrument or equipment is installed in the helicopter. In this case, the installation should be approved as required in the applicable airworthiness requirements and should comply with the applicable Certification Specifications.
- (b) The failure of additional non-installed instruments or equipment not required by this Part or by the applicable airworthiness requirements or any applicable airspace requirements should not adversely affect the airworthiness and/or the safe operation of the aircraft. Examples are the following:
 - (1) instruments supplying additional flight information (e.g. stand-alone global positioning system (GPS));
 - (2) some aerial work equipment (e.g. some mission dedicated radios, wire cutters); and
 - (3) non-installed passenger entertainment equipment.

GM1 NCC.IDE.H.100(d) Instruments and equipment – general

ED Decision 2013/021/R

POSITIONING OF INSTRUMENTS

This requirement implies that whenever a single instrument is required in a helicopter operated in a multi-crew environment, the instrument needs to be visible from each flight crew station.

NCC.IDE.H.105 Minimum equipment for flight

Regulation (EU) 2019/1384

A flight shall not be commenced when any of the helicopter's instruments, items of equipment or functions required for the intended flight are inoperative or missing, unless:

- (a) the helicopter is operated in accordance with the operator's minimum equipment list (MEL);
- (b) the operator is approved by the competent authority to operate the helicopter within the constraints of the master minimum equipment list ("MMEL") in accordance with point [ORO.MLR.105\(j\)](#) of Annex III; or
- (c) the helicopter is subject to a permit to fly issued in accordance with the applicable airworthiness requirements.

AMC1 NCC.IDE.H.105 Minimum equipment for flight

ED Decision 2021/005/R

MANAGEMENT OF THE STATUS OF CERTAIN INSTRUMENTS, EQUIPMENT OR FUNCTIONS

The operator should control and retain the status of the instruments, equipment or functions required for the intended operation, that are not controlled for the purpose of continuing airworthiness management.

GM1 NCC.IDE.H.105 Minimum equipment for flight

ED Decision 2021/005/R

MANAGEMENT OF THE STATUS OF CERTAIN INSTRUMENTS, EQUIPMENT OR FUNCTIONS

- (a) The operator should define responsibilities and procedures to retain and control the status of instruments, equipment or functions required for the intended operation, that are not controlled for the purpose of continuing airworthiness management.
- (b) Examples of such instruments, equipment or functions may be, but are not limited to, equipment related to navigation approvals as FM immunity or certain software versions.

NCC.IDE.H.115 Operating lights

Regulation (EU) No 800/2013

Helicopters operated at night shall be equipped with:

- (a) an anti-collision light system;
- (b) navigation/position lights;
- (c) a landing light;
- (d) lighting supplied from the helicopter's electrical system to provide adequate illumination for all instruments and equipment essential to the safe operation of the helicopter;
- (e) lighting supplied from the helicopter's electrical system to provide illumination in all passenger compartments;
- (f) an independent portable light for each crew member station; and
- (g) lights to conform with the International Regulations for Preventing Collisions at Sea if the helicopter is amphibious.

AMC1 NCC.IDE.H.115 Operating lights

ED Decision 2017/010/R

LANDING LIGHT

The landing light should be trainable, at least in the vertical plane or optionally be supplemented by an additional fixed light or lights positioned to give a wide spread of illumination.

NCC.IDE.H.120 Operations under VFR – flight and navigational instruments and associated equipment

Regulation (EU) 2019/1384

- (a) Helicopters operated under VFR by day shall be equipped with a means of measuring and displaying the following:
- (1) magnetic heading;
 - (2) time in hours, minutes and seconds;
 - (3) barometric altitude;
 - (4) indicated airspeed; and
 - (5) slip.
- (b) Helicopters operated under VMC over water and out of sight of the land, or under VMC at night, or when the visibility is less than 1 500 m, or in conditions where the helicopter cannot be maintained in a desired flight path without reference to one or more additional instruments, shall be equipped, in addition to (a), with:
- (1) a means of measuring and displaying the following:
 - (i) attitude;
 - (ii) vertical speed; and
 - (iii) stabilised heading;
 - (2) a means of indicating when the supply of power to the gyroscopic instruments is not adequate; and
 - (3) a means of preventing malfunction of the airspeed indicating system required in (a)(4) due to condensation or icing.
- (c) Whenever two pilots are required for the operation, helicopters shall be equipped with an additional separate means of displaying the following:
- (1) barometric altitude;
 - (2) indicated airspeed;
 - (3) slip;
 - (4) attitude, if applicable;
 - (5) vertical speed, if applicable; and
 - (6) stabilised heading, if applicable.

AMC1 NCC.IDE.H.120&NCC.IDE.H.125 Operations under VFR & operations under IFR – flight and navigational instruments and associated equipment

ED Decision 2013/021/R

INTEGRATED INSTRUMENTS

- (a) Individual equipment requirements may be met by combinations of instruments or by integrated flight systems or by a combination of parameters on electronic displays. The information so available to each required pilot should not be less than that required in the applicable operational requirements, and the equivalent safety of the installation should be approved during type certification of the helicopter for the intended type of operation.
- (b) The means of measuring and indicating slip, helicopter attitude and stabilised helicopter heading may be met by combinations of instruments or by integrated flight director systems, provided that the safeguards against total failure, inherent in the three separate instruments, are retained.

AMC1 NCC.IDE.H.120(a)(1)&NCC.IDE.H.125(a)(1) Operations under VFR & operations under IFR – flight and navigational instruments and associated equipment

ED Decision 2013/021/R

MEANS OF MEASURING AND DISPLAYING MAGNETIC HEADING

The means of measuring and displaying magnetic heading should be a magnetic compass or equivalent.

AMC1 NCC.IDE.H.120(a)(2)&NCC.IDE.H.125(a)(2) Operations under VFR & operations under IFR – flight and navigational instruments and associated equipment

ED Decision 2013/021/R

MEANS FOR MEASURING AND DISPLAYING THE TIME

An acceptable means of compliance is be a clock displaying hours, minutes and seconds, with a sweep-second pointer or digital presentation.

AMC1 NCC.IDE.H.120(a)(3)&NCC.IDE.H.125(a)(3) Operations under VFR & operations under IFR – flight and navigational instruments and associated equipment

ED Decision 2013/021/R

CALIBRATION OF THE MEANS FOR MEASURING AND DISPLAYING PRESSURE ALTITUDE

The instrument measuring and displaying pressure altitude should be of a sensitive type calibrated in feet (ft), with a sub-scale setting, calibrated in hectopascals/millibars, adjustable for any barometric pressure likely to be set during flight.

AMC1 NCC.IDE.H.120(a)(4)&NCC.IDE.H.125(a)(4) Operations under VFR & operations under IFR – flight and navigational instruments and associated equipment

ED Decision 2013/021/R

CALIBRATION OF THE INSTRUMENT INDICATING AIRSPEED

The instrument indicating airspeed should be calibrated in knots (kt).

AMC1 NCC.IDE.H.120(b)(1)(iii)&NCC.IDE.H.125(a)(8) Operations under VFR & operations under IFR – flight and navigational instruments and associated equipment

ED Decision 2013/021/R

STABILISED HEADING

Stabilised heading should be achieved for VFR flights by a gyroscopic heading indicator, whereas for IFR flights this should be achieved through a magnetic gyroscopic heading indicator.

AMC1 NCC.IDE.H.120(c) Operations under VFR – flight and navigational instruments and associated equipment

ED Decision 2022/012/R

MULTI-PILOT OPERATIONS

Two pilots should be considered to be required by the operation if multi-pilot operations are required by one of the following:

- (a) the AFM;
- (b) at night, the operations manual.

GM1 NCC.IDE.H.120(c) Operations under VFR – flight and navigational instruments and associated equipment

ED Decision 2022/012/R

MULTI-PILOT OPERATIONS ON A VOLUNTARY BASIS – HELICOPTERS OPERATED BY DAY UNDER VFR

If the AFM permits single-pilot operations, and the operator decides that the crew composition is more than one pilot for day VFR operations only, then point [NCC.IDE.H.120\(c\)](#) does not apply. However, additional displays, including those referred to in [NCC.IDE.H.120\(c\)](#), may be required under point [NCC.IDE.H.100\(e\)](#).

NCC.IDE.H.125 Operations under IFR – flight and navigational instruments and associated equipment

Regulation (EU) 2019/1384

Helicopters operated under IFR shall be equipped with:

- (a) a means of measuring and displaying the following:
 - (1) magnetic heading;

- (2) time in hours, minutes and seconds;
 - (3) barometric altitude;
 - (4) indicated airspeed;
 - (5) vertical speed;
 - (6) slip;
 - (7) attitude;
 - (8) stabilised heading; and
 - (9) outside air temperature;
- (b) a means of indicating when the supply of power to the gyroscopic instruments is not adequate;
- (c) whenever two pilots are required for the operation, an additional separate means of displaying the following:
- (1) barometric altitude;
 - (2) indicated airspeed;
 - (3) vertical speed;
 - (4) slip;
 - (5) attitude; and
 - (6) stabilised heading;
- (d) a means of preventing malfunction of the airspeed indicating systems required in (a)(4) and (c)(2) due to condensation or icing;
- (e) an alternate source of static pressure;
- (f) a chart holder in an easily readable position that can be illuminated for night operations; and
- (g) an additional means of measuring and displaying attitude as a standby instrument.

GM1 NCC.IDE.H.125(a)(3) Operations under IFR – flight and navigational instruments and associated equipment

ED Decision 2017/010/R

ALTIMETERS

Altimeters with counter drum-pointer or equivalent presentation are considered to be less susceptible to misinterpretation for helicopters operating above 10 000 ft.

AMC1 NCC.IDE.H.125(a)(9) Operations under IFR – flight and navigational instruments and associated equipment

ED Decision 2013/021/R

OUTSIDE AIR TEMPERATURE

- (a) The means of displaying outside air temperature should be calibrated in degrees Celsius.
- (b) The means of displaying outside air temperature may be an air temperature indicator that provides indications that are convertible to outside air temperature.

AMC1 NCC.IDE.H.125(c) Operations under IFR — flight and navigational instruments and associated equipment

ED Decision 2022/012/R

MULTI-PILOT OPERATIONS

Two pilots should be considered to be required by the operation if multi-pilot operations are required by one of the following:

- (a) the AFM;
- (b) the operations manual.

AMC1 NCC.IDE.H.120(c)&NCC.IDE.H.125(c) Operations under VFR & operations under IFR – flight and navigational instruments and associated equipment

ED Decision 2013/021/R

MULTI-PILOT OPERATIONS — DUPLICATE INSTRUMENTS

Duplicate instruments include separate displays for each pilot and separate selectors or other associated equipment where appropriate.

AMC1 NCC.IDE.H.125(d) Operations under VFR & operations under IFR – flight and navigational instruments and associated equipment

ED Decision 2013/021/R

MEANS OF PREVENTING MALFUNCTION DUE TO CONDENSATION OR ICING

The means of preventing malfunction due to either condensation or icing of the airspeed indicating system should be a heated pitot tube or equivalent.

AMC1 NCC.IDE.H.125(f) Operations under IFR – flight and navigational instruments and associated equipment

ED Decision 2013/021/R

CHART HOLDER

An acceptable means of compliance with the chart holder requirement is to display a pre-composed chart on an electronic flight bag (EFB).

NCC.IDE.H.130 Additional equipment for single-pilot operations under IFR

Regulation (EU) No 800/2013

Helicopters operated under IFR with a single pilot shall be equipped with an autopilot with at least altitude hold and heading mode.

NCC.IDE.H.145 Airborne weather detecting equipment

Regulation (EU) No 800/2013

Helicopters with an MOPSC of more than nine and operated under IFR or at night shall be equipped with airborne weather detecting equipment when current weather reports indicate that thunderstorms or other potentially hazardous weather conditions, regarded as detectable with airborne weather detecting equipment, may be expected to exist along the route to be flown.

AMC1 NCC.IDE.H.145 Airborne weather detecting equipment

ED Decision 2013/021/R

GENERAL

The airborne weather detecting equipment should be an airborne weather radar.

NCC.IDE.H.150 Additional equipment for operations in icing conditions at night

Regulation (EU) No 800/2013

- (a) Helicopters operated in expected or actual icing conditions at night shall be equipped with a means to illuminate or detect the formation of ice.
- (b) The means to illuminate the formation of ice shall not cause glare or reflection that would handicap flight crew members in the performance of their duties.

NCC.IDE.H.155 Flight crew interphone system

Regulation (EU) No 800/2013

Helicopters operated by more than one flight crew member shall be equipped with a flight crew interphone system, including headsets and microphones for use by all flight crew members.

AMC1 NCC.IDE.H.155 Flight crew interphone system

ED Decision 2013/021/R

TYPE OF FLIGHT CREW INTERPHONE

The flight crew interphone system should not be of a handheld type.

NCC.IDE.H.160 Cockpit voice recorder

Regulation (EU) 2015/2338

- (a) Helicopters with an MCTOM of more than 7 000 kg and first issued with an individual CofA on or after 1 January 2016 shall be equipped with a CVR.
- (b) The CVR shall be capable of retaining data recorded during at least the preceding 2 hours.
- (c) The CVR shall record with reference to a timescale:
 - (1) voice communications transmitted from or received in the flight crew compartment by radio;
 - (2) flight crew members' voice communications using the interphone system and the public address system, if installed;

- (3) the aural environment of the cockpit, including, without interruption, the audio signals received from each crew microphone; and
 - (4) voice or audio signals identifying navigation or approach aids introduced into a headset or speaker.
- (d) The CVR shall start automatically to record prior to the helicopter moving under its own power and shall continue to record until the termination of the flight when the helicopter is no longer capable of moving under its own power.
- (e) In addition to (d), depending on the availability of electrical power, the CVR shall start to record as early as possible during the cockpit checks prior to engine start at the beginning of the flight until the cockpit checks immediately following engine shutdown at the end of the flight.
- (f) If the CVR is not deployable, it shall have a device to assist in locating it under water. By 1 January 2020 at the latest, this device shall have a minimum underwater transmission time of 90 days. If the CVR is deployable, it shall have an automatic emergency locator transmitter.

AMC1 NCC.IDE.H.160 Cockpit voice recorder

ED Decision 2015/021/R

GENERAL

- (a) The operational performance requirements for cockpit voice recorders (CVRs) should be those laid down in EUROCAE Document ED-112 Minimum Operational Performance Specification for Crash Protected Airborne Recorder Systems, March 2003, including Amendments No°1 and No°2, or any later equivalent standard produced by EUROCAE.
- (b) The operational performance requirements for equipment dedicated to the CVR should be those laid down in the European Organisation for Civil Aviation Equipment (EUROCAE) Document ED-56A (Minimum Operational Performance Requirements For Cockpit Voice Recorder Systems) dated December 1993, or EUROCAE Document ED-112 (Minimum Operational Performance Specification for Crash Protected Airborne Recorder Systems) dated March 2003, including Amendments No°1 and No°2, or any later equivalent standard produced by EUROCAE.

NCC.IDE.H.165 Flight data recorder

Regulation (EU) 2015/2338

- (a) Helicopters with an MCTOM of more than 3 175 kg and first issued with an individual CofA on or after 1 January 2016 shall be equipped with an FDR that uses a digital method of recording and storing data and for which a method of readily retrieving that data from the storage medium is available.
- (b) The FDR shall record the parameters required to determine accurately the helicopter flight path, speed, attitude, engine power, configuration and operation and be capable of retaining data recorded during at least the preceding 10 hours.
- (c) Data shall be obtained from helicopter sources that enable accurate correlation with information displayed to the flight crew.
- (d) The FDR shall start automatically to record the data prior to the helicopter being capable of moving under its own power and shall stop automatically after the helicopter is incapable of moving under its own power.

- (e) If the FDR is not deployable, it shall have a device to assist in locating it under water. By 1 January 2020 at the latest, this device shall have a minimum underwater transmission time of 90 days. If the FDR is deployable, it shall have an automatic emergency locator transmitter.

AMC1 NCC.IDE.H.165 Flight data recorder

ED Decision 2016/012/R

OPERATIONAL PERFORMANCE REQUIREMENTS FOR HELICOPTERS HAVING AN MCTOM OF MORE THAN 3 175 KG AND FIRST ISSUED WITH AN INDIVIDUAL CofA ON OR AFTER 1 JANUARY 2016 AND BEFORE 1 JANUARY 2023

- (a) The operational performance requirements for flight data recorders (FDRs) should be those laid down in EUROCAE Document ED-112 (Minimum Operational Performance Specification for Crash Protected Airborne Recorder Systems) dated March 2003, including amendments n°1 and n°2, or any later equivalent standard produced by EUROCAE.
- (b) The FDR should record, with reference to a timescale, the list of parameters in Table 1 and Table 2, as applicable.
- (c) The parameters recorded by the FDR should meet, as far as practicable, the performance specifications (designated ranges, sampling intervals, accuracy limits and minimum resolution in read-out) defined in EUROCAE ED-112, including amendments n°1 and n°2, or any later equivalent standard produced by EUROCAE.
- (d) FDR systems for which some recorded parameters do not meet the performance specifications of EUROCAE Document ED-112 may be acceptable to the Agency.

Table 1: FDR parameters — All helicopters

No*	Parameter
1	Time or relative time count
2	Pressure altitude
3	Indicated airspeed
4	Heading
5	Normal acceleration
6	Pitch attitude
7	Roll attitude
8	Manual radio transmission keying CVR/FDR synchronisation reference
9	Power on each engine:
9a	Free power turbine speed (N _F)
9b	Engine torque
9c	Engine gas generator speed (N _G)
9d	Flight crew compartment power control position
9e	Other parameters to enable engine power to be determined
10	Rotor:
10a	Main rotor speed
10b	Rotor brake (if installed)
11	Primary flight controls — Pilot input and/or control output position (if applicable):
11a	Collective pitch
11b	Longitudinal cyclic pitch
11c	Lateral cyclic pitch
11d	Tail rotor pedal
11e	Controllable stabilator (if applicable)

No*	Parameter
11f	Hydraulic selection
12	Hydraulics low pressure (each system should be recorded.)
13	Outside air temperature
18	Yaw rate or yaw acceleration
20	Longitudinal acceleration (body axis)
21	Lateral acceleration
25	Marker beacon passage
26	Warnings — a discrete should be recorded for the master warning, gearbox low oil pressure and stability augmentation system as failure. Other ‘red’ warnings should be recorded where the warning condition cannot be determined from other parameters or from the cockpit voice recorder.
27	Each navigation receiver frequency selection
37	Engine control modes

* The number in the left hand column reflects the serial number depicted in EUROCAE ED-112.

Table 2: FDR parameters — Helicopters for which the data source for the parameter is either used by helicopter systems or is available on the instrument panel for use by the flight crew to operate the helicopter

No*	Parameter
14	AFCS mode and engagement status
15	Stability augmentation system engagement (each system should be recorded)
16	Main gear box oil pressure
17	Gear box oil temperature:
17a	Main gear box oil temperature
17b	Intermediate gear box oil temperature
17c	Tail rotor gear box oil temperature
19	Indicated sling load force (if signals readily available)
22	Radio altitude
23	Vertical deviation — the approach aid in use should be recorded:
23a	ILS glide path
23b	MLS elevation
23c	GNSS approach path
24	Horizontal deviation — the approach aid in use should be recorded:
24a	ILS localiser
24b	MLS azimuth
24c	GNSS approach path
28	DME 1 & 2 distances
29	Navigation data:
29a	Drift angle
29b	Wind speed
29c	Wind direction
29d	Latitude
29e	Longitude
29f	Ground speed
30	Landing gear or gear selector position
31	Engine exhaust gas temperature (T ₄)
32	Turbine inlet temperature (TIT/ITT)
33	Fuel contents
34	Altitude rate (vertical speed) - only necessary when available from cockpit instruments
35	Ice detection

No*	Parameter
36	Helicopter health and usage monitor system (HUMS):
36a	Engine data
36b	Chip detector
36c	Track timing
36d	Exceedance discrettes
36e	Broadband average engine vibration
38	Selected barometric setting — to be recorded for helicopters where the parameter is displayed electronically:
38a	Pilot
38b	Co-pilot
39	Selected altitude (all pilot selectable modes of operation) — to be recorded for the helicopters where the parameter is displayed electronically
40	Selected speed (all pilot selectable modes of operation) — to be recorded for the helicopters where the parameter is displayed electronically
41	Not used (selected Mach)
42	Selected vertical speed (all pilot selectable modes of operation) — to be recorded for the helicopters where the parameter is displayed electronically
43	Selected heading (all pilot selectable modes of operation) — to be recorded for the helicopters where the parameter is displayed electronically
44	Selected flight path (all pilot selectable modes of operation) — to be recorded for the helicopters where the parameter is displayed electronically
45	Selected decision height (all pilot selectable modes of operation) — to be recorded for the helicopters where the parameter is displayed electronically
46	EFIS display format
47	Multi-function/engine/alerts display format
48	Event marker

* The number in the left hand column reflects the serial number depicted in EUROCAE ED-112.

AMC2 NCC.IDE.H.165 Flight data recorder

ED Decision 2016/012/R

OPERATIONAL PERFORMANCE REQUIREMENTS FOR HELICOPTERS HAVING AN MCTOM OF MORE THAN 3 175 KG AND FIRST ISSUED WITH AN INDIVIDUAL CoFA ON OR AFTER 1 JANUARY 2023

- (a) The operational performance requirements for flight data recorders (FDRs) should be those laid down in EUROCAE Document 112A (Minimum Operational Performance Specification for Crash Protected Airborne Recorder Systems) dated September 2013, or any later equivalent standard produced by EUROCAE.
- (b) The FDR should, with reference to a timescale, record:
 - (1) the list of parameters in Table 1 below;
 - (2) the additional parameters listed in Table 2 below, when the information data source for the parameter is used by helicopter systems or is available on the instrument panel for use by the flight crew to operate the helicopter; and
 - (3) any dedicated parameters related to novel or unique design or operational characteristics of the helicopter as determined by the Agency.
- (c) The parameters to be recorded should meet the performance specifications (range, sampling intervals, accuracy limits and resolution in read-out) as defined in the relevant tables of EUROCAE Document 112A, or any later equivalent standard produced by EUROCAE.

Table 1: FDR — All helicopters

No*	Parameter
1	Time or relative time count
2	Pressure altitude
3	Indicated airspeed or calibrated airspeed
4	Heading
5	Normal acceleration
6	Pitch attitude
7	Roll attitude
8	Manual radio transmission keying CVR/FDR synchronisation reference
9	Power on each engine:
9a	Free power turbine speed (N _F)
9b	Engine torque
9c	Engine gas generator speed (N _G)
9d	Flight crew compartment power control position
9e	Other parameters to enable engine power to be determined
10	Rotor:
10a	Main rotor speed
10b	Rotor brake (if installed)
11	Primary flight controls — pilot input or control output position if it is possible to derive either the control input or the control movement (one from the other) for all modes of operation and flight regimes. Otherwise, pilot input and control output position
11a	Collective pitch
11b	Longitudinal cyclic pitch
11c	Lateral cyclic pitch
11d	Tail rotor pedal
11e	Controllable stabilator (if applicable)
11f	Hydraulic selection
12	Hydraulics low pressure (each system should be recorded)
13	Outside air temperature
18	Yaw rate or yaw acceleration
20	Longitudinal acceleration (body axis)
21	Lateral acceleration
25	Marker beacon passage
26	Warnings — including master warning, gearbox low oil pressure and stability augmentation system failure, and other ‘red’ warnings where the warning condition cannot be determined from other parameters or from the cockpit voice recorder
27	Each navigation receiver frequency selection
37	Engine control modes

* The number in the left-hand column reflects the serial numbers depicted in EUROCAE Document 112A.

Table 2: Helicopters for which the data source for the parameter is either used by the helicopter systems or is available on the instrument panel for use by the flight crew to operate the helicopter

No*	Parameter
14	AFCS mode and engagement status (showing which systems are engaged and which primary modes are controlling the flight path)
15	Stability augmentation system engagement (each system should be recorded)
16	Main gear box oil pressure
17	Gear box oil temperature:

No*	Parameter
17a	Main gear box oil temperature
17b	Intermediate gear box oil temperature
17c	Tail rotor gear box oil temperature
19	Indicated sling load force (if signals readily available)
22	Radio altitude
23	Vertical deviation — the approach aid in use should be recorded:
23a	ILS glide path
23b	MLS elevation
23c	GNSS approach path
24	Horizontal deviation — the approach aid in use should be recorded:
24a	ILS localiser
24b	MLS azimuth
24c	GNSS approach path
28	DME 1 & 2 distances
29	Navigation data:
29a	Drift angle
29b	Wind speed
29c	Wind direction
29d	Latitude
29e	Longitude
29f	Ground speed
30	Landing gear or gear selector position
31	Engine exhaust gas temperature (T ₄)
32	Turbine inlet temperature (TIT)/interstage turbine temperature (ITT)
33	Fuel contents
34	Altitude rate (vertical speed) — only necessary when available from cockpit instruments
35	Ice detection
36	Helicopter health and usage monitor system (HUMS):
36a	Engine data
36b	Chip detector
36c	Track timing
36d	Exceedance discrettes
36e	Broadband average engine vibration
38	Selected barometric setting — to be recorded for helicopters where the parameter is displayed electronically:
38a	Pilot
38b	Co-pilot
39	Selected altitude (all pilot selectable modes of operation) — to be recorded for the helicopters where the parameter is displayed electronically.
40	Selected speed (all pilot selectable modes of operation) — to be recorded for the helicopters where the parameter is displayed electronically.
41	Selected Mach (all pilot selectable modes of operation) — to be recorded for the helicopters where the parameter is displayed electronically.
42	Selected vertical speed (all pilot selectable modes of operation) — to be recorded for the helicopters where the parameter is displayed electronically.
43	Selected heading (all pilot selectable modes of operation) — to be recorded for the helicopters where the parameter is displayed electronically.
44	Selected flight path (all pilot selectable modes of operation) — to be recorded for the helicopters where the parameter is displayed electronically.

No*	Parameter
45	Selected decision height (all pilot selectable modes of operation) — to be recorded for the helicopters where the parameter is displayed electronically.
46	EFIS display format (showing the display system status):
46a	Pilot
46b	First officer
47	Multi-function/engine/alerts display format (showing the display system status)
48	Event marker
49	Status of ground proximity warning system (GPWS)/terrain awareness warning system (TAWS)/ground collision avoidance system (GCAS):
49a	Selection of terrain display mode including pop-up display status — for helicopters type certified before 1 January 2023, to be recorded only if this does not require extensive modification.
49b	Terrain alerts, both cautions and warnings, and advisories — for helicopters type certified before 1 January 2023, to be recorded only if this does not require extensive modification
49c	On/off switch position — for helicopters type certified before 1 January 2023, to be recorded only if this does not require extensive modification
50	Traffic alert and collision avoidance system (TCAS)/airborne collision avoidance system (ACAS):
50a	Combined control — for helicopters type certified before 1 January 2023, to be recorded only if this does not require extensive modification.
50b	Vertical control — for helicopters type certified before 1 January 2023, to be recorded only if this does not require extensive modification.
50c	Up advisory — for helicopters type certified before 1 January 2023, to be recorded only if this does not require extensive modification.
50d	Down advisory — for helicopters type certified before 1 January 2023, to be recorded only if this does not require extensive modification.
50e	Sensitivity level — for helicopters type certified before 1 January 2023, to be recorded only if this does not require extensive modification.
51	Primary flight controls — pilot input forces:
51a	Collective pitch — for helicopters type certified before 1 January 2023, to be recorded only if this does not require extensive modification
51b	Longitudinal cyclic pitch — for helicopters type certified before 1 January 2023, to be recorded only if this does not require extensive modification.
51c	Lateral cyclic pitch — for helicopters type certified before 1 January 2023, to be recorded only if this does not require extensive modification.
51d	Tail rotor pedal — for helicopters type certified before 1 January 2023, to be recorded only if this does not require extensive modification.
52	Computed centre of gravity — for helicopters type certified before 1 January 2023, to be recorded only if this does not require extensive modification.
53	Helicopter computed weight — for helicopters type certified before 1 January 2023, to be recorded only if this does not require extensive modification.

* The number in the left-hand column reflects the serial numbers depicted in EUROCAE Document 112A.

NCC.IDE.H.170 Data link recording

Regulation (EU) 2015/2338

- (a) Helicopters first issued with an individual CofA on or after 1 January 2016 that have the capability to operate data link communications and are required to be equipped with a CVR shall record on a recorder, where applicable:
- (1) data link communication messages related to ATS communications to and from the helicopter, including messages applying to the following applications:
 - (i) data link initiation;

- (ii) controller–pilot communication;
 - (iii) addressed surveillance;
 - (iv) flight information;
 - (v) as far as is practicable, given the architecture of the system, aircraft broadcast surveillance;
 - (vi) as far as is practicable, given the architecture of the system, aircraft operational control data; and
 - (vii) as far as is practicable, given the architecture of the system, graphics;
- (2) information that enables correlation to any associated records related to data link communications and stored separately from the helicopter; and
- (3) information on the time and priority of data link communications messages, taking into account the system’s architecture.
- (b) The recorder shall use a digital method of recording and storing data and information and a method for readily retrieving that data. The recording method shall allow the data to match the data recorded on the ground.
- (c) The recorder shall be capable of retaining data recorded for at least the same duration as set out for CVRs in [NCC.IDE.H.160](#).
- (d) If the recorder is not deployable, it shall have a device to assist in locating it under water. By 1 January 2020 at the latest, this device shall have a minimum underwater transmission time of 90 days. If the recorder is deployable, it shall have an automatic emergency locator transmitter.
- (e) The requirements applicable to the start and stop logic of the recorder are the same as the requirements applicable to the start and stop logic of the CVR contained in [NCC.IDE.H.160\(d\) and \(e\)](#).

AMC1 NCC.IDE.H.170 Data link recording

ED Decision 2013/021/R

GENERAL

- (a) As a means of compliance with [NCC.IDE.H.170](#), the recorder on which the data link messages are recorded should be:
- (1) the CVR;
 - (2) the FDR;
 - (3) a combination recorder when [NCC.IDE.H.175](#) is applicable; or
 - (4) a dedicated flight recorder. In such a case, the operational performance requirements for this recorder should be those laid down in EUROCAE Document ED-112 (Minimum Operational Performance Specification for Crash Protected Airborne Recorder Systems), dated March 2003, including amendments n°1 and n°2, or any later equivalent standard produced by EUROCAE.
- (b) As a means of compliance with [NCC.IDE.H.170\(a\)\(2\)](#), the operator should enable correlation by providing information that allows an accident investigator to understand what data was provided to the aircraft and, when the provider identification is contained in the message, by which provider.

- (c) The timing information associated with the data link communications messages required to be recorded by [NCC.IDE.H.170\(a\)\(3\)](#) should be capable of being determined from the airborne-based recordings. This timing information should include at least the following:
- (1) the time each message was generated;
 - (2) the time any message was available to be displayed by the flight crew;
 - (3) the time each message was actually displayed or recalled from a queue; and
 - (4) the time of each status change.
- (d) The message priority should be recorded when it is defined by the protocol of the data link communication message being recorded.
- (e) The expression ‘taking into account the system’s architecture’, in [NCC.IDE.H.170\(a\)\(3\)](#), means that the recording of the specified information may be omitted if the existing source systems involved would require a major upgrade. The following should be considered:
- (1) the extent of the modification required;
 - (2) the down-time period; and
 - (3) equipment software development.
- (f) Data link communications messages that support the applications in Table 1 should be recorded.
- (g) Further details on the recording requirements can be found in the recording requirement matrix in Appendix D.2 of EUROCAE Document ED-93 (Minimum Aviation System Performance Specification for CNS/ATM Recorder Systems), dated November 1998.

Table 1: Data link recording

Item No	Application Type	Application Description	Required Recording Content
1	Data link initiation	This includes any application used to log on to, or initiate, a data link service. In future air navigation system (FANS)-1/A and air traffic navigation (ATN), these are ATS facilities notification (AFN) and context management (CM), respectively.	C
2	Controller/pilot communication	This includes any application used to exchange requests, clearances, instructions and reports between the flight crew and controllers on the ground. In FANS-1/A and ATN, this includes the controller pilot data link communications (CPDLC) application. It also includes applications used for the exchange of oceanic clearances (OCL) and departure clearances (DCL), as well as data link delivery of taxi clearances.	C
3	Addressed surveillance	This includes any surveillance application in which the ground sets up contracts for delivery of surveillance data. In FANS-1/A and ATN, this includes the automatic dependent surveillance-contract (ADS-C) application.	C, F2
4	Flight information	This includes any application used for delivery of flight information data to specific helicopters. This includes for example digital automatic terminal information service (D-ATIS), data link operational terminal information service (D-OTIS), digital weather information services (D-	C

Item No	Application Type	Application Description	Required Recording Content
		METAR or TWIP), data link-flight information service (D-FIS) and Notice to Airmen (electronic NOTAM) delivery.	
5	Broadcast surveillance	This includes elementary and enhanced surveillance systems, as well as automatic dependent surveillance-broadcast (ADS-B) output data.	M*, F2
6	AOC data	This includes any application transmitting or receiving data used for AOC purposes (in accordance with the ICAO definition of AOC). Such systems may also process AAC messages, but there is no requirement to record AAC messages	M*
7	Graphics	This includes any application receiving graphical data to be used for operational purposes (i.e. excluding applications that are receiving such things as updates to manuals).	M* F1

GM1 NCC.IDE.H.170 Data link recording

ED Decision 2013/021/R

GENERAL

- (a) The letters and expressions in Table 1 of [AMC1 NCC.IDE.H.170](#) have the following meaning:
- (1) C: complete contents recorded.
 - (2) M: information that enables correlation with any associated records stored separately from the helicopter.
 - (3) *: applications that are to be recorded only as far as is practicable, given the architecture of the system.
 - (4) F1: graphics applications may be considered as AOC messages when they are part of a data link communications application service run on an individual basis by the operator itself in the framework of the operational control.
 - (5) F2: where parametric data sent by the helicopter, such as Mode S, is reported within the message, it should be recorded unless data from the same source is recorded on the FDR.
- (b) The definitions of the applications type in Table 1 of [AMC1 NCC.IDE.H.170](#) are described in Table 1 below.

Table 1: Definitions of the applications type

Item No	Application Type	Messages	Comments
1	CM		CM is an ATN service
2	AFN		AFN is a FANS 1/A service
3	CPDLC		All implemented up and downlink messages to be recorded
4	ADS-C	ADS-C reports	All contract requests and reports recorded

Item No	Application Type	Messages	Comments
		Position reports	Only used within FANS 1/A. Mainly used in oceanic and remote areas.
5	ADS-B	Surveillance data	Information that enables correlation with any associated records stored separately from the helicopter.
6	D-FIS		D-FIS is an ATN service. All implemented up and downlink messages to be recorded
7	TWIP	TWIP messages	Terminal weather information for pilots
8	D ATIS	ATIS messages	Refer to EUROCAE ED-89A, dated December 2003: Data Link Application System Document (DLASD) for the 'ATIS' data link service
9	OCL	OCL messages	Refer to EUROCAE ED-106A, dated March 2004: Data Link Application System Document (DLASD) for 'Oceanic Clearance' (OCL) data link service
10	DCL	DCL messages	Refer to EUROCAE ED-85A, dated March 2003: Data Link Application System Document (DLASD) for 'Departure Clearance' data link service
11	Graphics	Weather maps & other graphics	Graphics exchanged in the framework of procedures within the operational control, as specified in Part-ORO. Information that enables correlation with any associated records stored separately from the helicopter.
12	AOC	Aeronautical operational control messages	Messages exchanged in the framework of procedures within the operational control, as specified in Part-ORO. Information that enables correlation with any associated records stored separately from the helicopter. Definition in EUROCAE ED-112, dated March 2003.
13	Surveillance	Downlinked Aircraft Parameters (DAP)	As defined in ICAO Annex 10 Volume IV (Surveillance systems and ACAS).

AAC	aeronautical administrative communications
ADS-B	automatic dependent surveillance - broadcast
ADS-C	automatic dependent surveillance – contract
AFN	aircraft flight notification
AOC	aeronautical operational control
ATIS	automatic terminal information service
ATSC	air traffic service communication
CAP	controller access parameters
CPDLC	controller pilot data link communications
CM	configuration/context management
D-ATIS	digital ATIS
D-FIS	data link flight information service
D-METAR	data link meteorological airport report
DCL	departure clearance
FANS	Future Air Navigation System
FLIPCY	flight plan consistency
OCL	oceanic clearance
SAP	system access parameters
TWIP	terminal weather information for pilots

GM1 NCC.IDE.H.170(a) Data link recording

ED Decision 2015/030/R

APPLICABILITY OF THE DATA LINK RECORDING REQUIREMENT

- (a) If it is certain that the helicopter cannot use data link communication messages for ATS communications corresponding to any application designated by [NCC.IDE.H.170\(a\)\(1\)](#), then the data link recording requirement does not apply.
- (b) Examples where the helicopter cannot use data link communication messages for ATS communications include but are not limited to the cases where:
 - (1) the helicopter data link communication capability is disabled permanently and in a way that it cannot be enabled again during the flight;
 - (2) data link communications are not used to support air traffic service (ATS) in the area of operation of the helicopter; and
 - (3) the helicopter data link communication equipment cannot communicate with the equipment used by ATS in the area of operation of the helicopter.

NCC.IDE.H.175 Flight data and cockpit voice combination recorder

Regulation (EU) No 800/2013

Compliance with CVR and FDR requirements may be achieved by one flight data and cockpit voice combination recorder.

GM1 NCC.IDE.H.175 Flight data and cockpit voice combination recorder

ED Decision 2013/021/R

COMBINATION RECORDERS

- (a) A flight data and cockpit voice combination recorder is a flight recorder that records:
 - (1) all voice communications and the aural environment required by [NCC.IDE.H.160](#); and
 - (2) all parameters required by [NCC.IDE.H.165](#),with the same specifications required by [NCC.IDE.H.160](#) and [NCC.IDE.H.165](#).
- (b) In addition, a flight data and cockpit voice combination recorder may record data link communication messages and related information required by the [NCC.IDE.H.170](#).

NCC.IDE.H.180 Seats, seat safety belts, restraint systems and child restraint devices

Regulation (EU) No 800/2013

- (a) Helicopters shall be equipped with:
 - (1) a seat or berth for each person on board who is aged 24 months or more;
 - (2) a seat belt on each passenger seat and restraining belts for each berth;
 - (3) for helicopters first issued with an individual CofA after 31 December 2012, a seat belt with an upper torso restraint system for each passenger who is aged 24 months or more;
 - (4) a child restraint device (CRD) for each person on board younger than 24 months;

- (5) a seat belt with upper torso restraint system incorporating a device that will automatically restrain the occupant's torso in the event of rapid deceleration on each flight crew seat; and
 - (6) a seat belt with upper torso restraint system on the seats for the minimum required cabin crew, in the case of helicopters first issued with an individual CofA after 31 December 1980.
- (b) A seat belt with upper torso restraint system shall:
- (1) have a single point release; and
 - (2) on flight crew seats, on any seat alongside a pilot's seat and on the seats for the minimum required cabin crew, include two shoulder straps and a seat belt that may be used independently.

AMC1 NCC.IDE.H.180 Seats, seat safety belts, restraint systems and child restraint devices

ED Decision 2019/019/R9/019/R

CHILD RESTRAINT DEVICES (CRDs)

- (a) A CRD is considered to be acceptable if:
- (1) it is a supplementary loop belt manufactured with the same techniques and the same materials of the approved safety belts; or
 - (2) it complies with (b).
- (b) Provided the CRD can be installed properly on the respective helicopter seat, the following CRDs are considered acceptable:
- (1) CRDs approved for use in aircraft according to the European Technical Standard Order ETSO-C100c on Aviation Child Safety Device (ACSD).
 - (2) CRDs approved by EASA through a Type Certificate or Supplemental Type Certificate;
 - (3) Child seat approved for use in motor vehicles on the basis of the technical standard specified in (i). The child seat must be also approved for use in aircraft on the basis of the technical standard specified in either point (ii) or point (iii):
 - (i) UN Standard ECE R44-04 (or 03), or ECE R129 bearing the respective 'ECE R' label; and
 - (ii) German 'Qualification Procedure for Child Restraint Systems for Use in Aircraft' (TÜV Doc.: TÜV/958-01/2001) bearing the label 'For Use in Aircraft'; or
 - (iii) Other technical standard acceptable to the competent authority. The child seat should hold a qualification sign that it can be used in aircraft.
 - (4) Child seat approved for use in motor vehicles and aircraft according to Canadian CMVSS 213/213.1 bearing the respective label;
 - (5) Child seat approved for use in motor vehicles and aircraft according to US FMVSS No 213 and bearing one or two labels displaying the following two sentences:
 - (i) 'THIS CHILD RESTRAINT SYSTEM CONFORMS TO ALL APPLICABLE FEDERAL MOTOR VEHICLE SAFETY STANDARDS'; and

- (ii) in red letters 'THIS RESTRAINT IS CERTIFIED FOR USE IN MOTOR VEHICLES AND AIRCRAFT';
 - (6) Child seats approved for use in motor vehicles and aircraft according to Australia/New Zealand's technical standard AS/NZS 1754:2013 bearing the green part on the label displaying 'For Use in Aircraft'; and
 - (7) CRDs manufactured and tested according to other technical standards equivalent to those listed above. The devices should be marked with an associated qualification sign, which shows the name of the qualification organisation and a specific identification number, related to the associated qualification project. The qualifying organisation should be a competent and independent organisation that is acceptable to the competent authority.
- (c) Location
- (1) Forward-facing child seats may be installed on both forward-and rearward-facing passenger seats, but only when fitted in the same direction as the passenger seat on which they are positioned. Rearward-facing child seats should only be installed on forward-facing passenger seats. A child seat should not be installed within the radius of action of an airbag unless it is obvious that the airbag is de-activated or it can be demonstrated that there is no negative impact from the airbag.
 - (2) An infant/child in a CRD should be located in the vicinity of a floor level exit.
 - (3) An infant/child in a CRD should not hinder evacuation for any passenger.
 - (4) An infant/child in a CRD should neither be located in the row (where rows are existing) leading to an emergency exit nor located in a row immediately forward or aft of an emergency exit. A window passenger seat is the preferred location. An aisle passenger seat or a cross aisle passenger seat that forms part of the evacuation route to exits is not recommended. Other locations may be acceptable provided the access of neighbour passengers to the nearest aisle is not obstructed by the CRD.
 - (5) In general, only one CRD per row segment is recommended. More than one CRD per row segment is allowed if the infants/children are from the same family or travelling group provided the infants/children are accompanied by a responsible adult sitting next to them.
 - (6) A row segment is one or more seats side-by-side separated from the next row segment by an aisle.
- (d) Installation
- (1) CRDs tested and approved for use in aircraft should only be installed on a suitable passenger seat by the method shown in the manufacturer's instructions provided with each CRD and with the type of connecting device they are approved for the installation in aircraft. CRDs designed to be installed only by means of rigid bar lower anchorages (ISOFIX or equivalent) should only be used on passenger seats equipped with such connecting devices and should not be secured by passenger seat lap belt.
 - (2) All safety and installation instructions should be followed carefully by the responsible person accompanying the infant/child. Operators should prohibit the use of a CRD not installed on the passenger seat according to the manufacturer's instructions or not approved for use in aircraft.

- (3) If a forward-facing child seat with a rigid backrest is to be fastened by a seat lap belt, the restraint device should be fastened when the backrest of the passenger seat on which it rests is in a reclined position. Thereafter, the backrest is to be positioned upright. This procedure ensures better tightening of the child seat on the aircraft seat if the aircraft seat is reclinable.
 - (4) The buckle of the adult safety belt should be easily accessible for both opening and closing, and should be in line with the seat belt halves (not canted) after tightening.
 - (5) Forward facing restraint devices with an integral harness should not be installed such that the adult safety belt is secured over the infant.
- (e) Operation
- (1) Each CRD should remain secured to a passenger seat during all phases of flight, unless it is properly stowed when not in use.
 - (2) Where a child seat is adjustable in recline, it should be in an upright position for all occasions when passenger restraint devices are required.

AMC2 NCC.IDE.H.180 Seats, seat safety belts, restraint systems and child restraint devices

ED Decision 2013/021/R

UPPER TORSO RESTRAINT SYSTEM

An upper torso restraint system having three straps is deemed to be compliant with the requirement for restraint systems with two shoulder straps.

SAFETY BELT

A safety belt with a diagonal shoulder strap (three anchorage points) is deemed to be compliant with the requirement for safety belts (two anchorage points).

AMC3 NCC.IDE.H.180 Seats, seat safety belts, restraint systems and child restraint devices

ED Decision 2013/021/R

SEATS FOR MINIMUM REQUIRED CABIN CREW

- (a) Seats for the minimum required cabin crew members should be located near required floor level emergency exits, except if the emergency evacuation of passengers would be enhanced by seating the cabin crew members elsewhere. In this case other locations are acceptable. This criterion should also apply if the number of required cabin crew members exceeds the number of floor level emergency exits.
- (b) Seats for cabin crew member(s) should be forward or rearward facing within 15° of the longitudinal axis of the helicopter.

NCC.IDE.H.185 Fasten seat belt and no smoking signs

Regulation (EU) No 800/2013

Helicopters in which not all passenger seats are visible from the flight crew seat(s) shall be equipped with a means of indicating to all passengers and cabin crew when seat belts shall be fastened and when smoking is not allowed.

NCC.IDE.H.190 First-aid kit

Regulation (EU) No 800/2013

- (a) Helicopters shall be equipped with at least one first-aid kit.
- (b) The first-aid kit(s) shall be:
 - (1) readily accessible for use; and
 - (2) kept up-to-date.

AMC1 NCC.IDE.H.190 First-aid kit

ED Decision 2021/005/R

CONTENT OF FIRST-AID KITS

- (a) First-aid kits should be equipped with appropriate and sufficient medications and instrumentation. However, these kits should be supplemented by the operator according to the characteristics of the operation (scope of operation, flight duration, number and demographics of passengers, etc.).
- (b) The following should be included in the FAKs:
 - (1) Equipment:
 - (i) bandages (assorted sizes, including a triangular bandage);
 - (ii) burns dressings (unspecified);
 - (iii) wound dressings (large and small);
 - (iv) adhesive dressings (assorted sizes);
 - (v) adhesive tape;
 - (vi) adhesive wound closures;
 - (vii) safety pins;
 - (viii) safety scissors;
 - (ix) antiseptic wound cleaner;
 - (x) disposable resuscitation aid;
 - (xi) disposable gloves;
 - (xii) tweezers: splinter;
 - (xiii) thermometers (non-mercury); and
 - (xiv) surgical masks.
 - (2) Medications:
 - (i) simple analgesic (including paediatric form — if the type of operation does not include transport of children or infants, the paediatric form may not be included);
 - (ii) antiemetic — non-injectable;
 - (iii) nasal decongestant;
 - (iv) gastrointestinal antacid, in the case of helicopters carrying more than nine passengers;

- (v) anti-diarrhoeal medication in the case of helicopters carrying more than nine passengers; and
 - (vi) antihistamine (including paediatric form — if the type of operation does not include transport of children or infants, the paediatric form may not be included).
- (3) Other content. The operator should make the instructions readily available. If an electronic format is available, then all instructions should be kept on the same device. If a paper format is used, then the instructions should be kept in the same kit with the applicable equipment and medication. The instructions should include, as a minimum, the following:
- (i) a list of contents in at least two languages (English and one other). This should include information on the effects and side effects of medications carried;
 - (ii) first-aid handbook, current edition;
 - (iii) Basic life support instructions cards (summarising and depicting the current algorithm for basic life support); and
 - (iv) medical incident report form.
- (4) Additional equipment. The following additional equipment should be carried on board each aircraft equipped with a first-aid kit, though not necessarily in the first-aid kit. The additional equipment should include, as a minimum:
- (i) automated external defibrillator (AED) on all aircraft required to carry at least one cabin crew;
 - (ii) bag-valve masks (masks in three sizes: one for adults, one for children, and one for infants);
 - (iii) suitable airway management device (e.g. supraglottic airway devices, oropharyngeal and nasopharyngeal airways);
 - (iv) eye irrigator; and
 - (v) biohazard disposal bags.

AMC2 NCC.IDE.H.190 First-aid kit

ED Decision 2013/021/R

MAINTENANCE OF FIRST-AID KITS

To be kept up to date, first-aid kits should be:

- (a) inspected periodically to confirm, to the extent possible, that contents are maintained in the condition necessary for their intended use;
- (b) replenished at regular intervals, in accordance with instructions contained on their labels, or as circumstances warrant; and
- (c) replenished after use in-flight at the first opportunity where replacement items are available.

GM1 NCC.IDE.H.190 First-aid kit

ED Decision 2021/005/R

LOCATION AND USE

The location of the first-aid kit is normally indicated using internationally recognisable signs.

The first-aid kit 'should be readily accessible for use' in helicopter operations should be understood as the first-aid kit being either accessible in flight or immediately after landing.

In some operations it is not practicable to use the first-aid kit during flight. Therefore, the first-aid kit can be carried in the cargo compartment, where it will be easily accessible for use as soon as the aircraft has landed, when the following conditions are met:

- (a) precautionary landing sites are available;
- (b) the lack of cabin space is such that movement or use of the first-aid kit is impaired; and
- (c) The installation of the first-aid kit in the cabin is not practicable.

GM2 NCC.IDE.H.190 First-aid kit

ED Decision 2021/005/R

STORAGE

As a best practice and wherever practicable, the emergency medical equipment listed under [AMC1 NCC.IDE.H.190](#) should be kept close together.

GM3 NCC.IDE.H.190 First-aid kit

ED Decision 2021/005/R

CONTENT OF FIRST-AID KITS

The operator may supplement first-aid kits according to the characteristics of the operation based on a risk assessment. The assessment does not require an approval by the competent authority.

GM4 NCC.IDE.H.190 First-aid kit

ED Decision 2021/005/R

LITHIUM BATTERIES

Risks related to the presence of lithium batteries should be assessed. All equipment powered by lithium batteries carried on an aeroplane should comply with the provisions of [AMC1 NCC.GEN.130\(f\)](#) including applicable technical standards such as (E)TSO-C142.

NCC.IDE.H.200 Supplemental oxygen – non-pressurised helicopters

Regulation (EU) No 800/2013

- (a) Non-pressurised helicopters operated at flight altitudes when the oxygen supply is required in accordance with (b) shall be equipped with oxygen storage and dispensing apparatus capable of storing and dispensing the required oxygen supplies.
- (b) Non-pressurised helicopters operated above flight altitudes at which the pressure altitude in the passenger compartments is above 10 000 ft shall carry enough breathing oxygen to supply:
 - (1) all crew members and at least 10 % of the passengers for any period in excess of 30 minutes when the pressure altitude in the passenger compartment will be between 10 000 ft and 13 000 ft; and
 - (2) all crew members and passengers for any period that the pressure altitude in the passenger compartment will be above 13 000 ft.

AMC1 NCC.IDE.H.200 Supplemental oxygen – non-pressurised helicopters

ED Decision 2013/021/R

DETERMINATION OF OXYGEN

The amount of supplemental oxygen required for a particular operation should be determined on the basis of flight altitudes and flight duration, consistent with the operating procedures, including emergency procedures, established for each operation and the routes to be flown as specified in the operations manual.

NCC.IDE.H.205 Hand fire extinguishers

Regulation (EU) No 800/2013

- (a) Helicopters shall be equipped with at least one hand fire extinguisher:
 - (1) in the flight crew compartment; and
 - (2) in each passenger compartment that is separate from the flight crew compartment, except if the compartment is readily accessible to the flight crew.
- (b) The type and quantity of extinguishing agent for the required fire extinguishers shall be suitable for the type of fire likely to occur in the compartment where the extinguisher is intended to be used and to minimise the hazard of toxic gas concentration in compartments occupied by persons.

AMC1 NCC.IDE.H.205 Hand fire extinguishers

ED Decision 2013/021/R

NUMBER, LOCATION AND TYPE

- (a) The number and location of hand fire extinguishers should be such as to provide adequate availability for use, account being taken of the number and size of the passenger compartments, the need to minimise the hazard of toxic gas concentrations and the location of toilets, galleys, etc. These considerations may result in the number of fire extinguishers being greater than the minimum required.
- (b) There should be at least one hand fire extinguisher installed in the flight crew compartment and this should be suitable for fighting both flammable fluid and electrical equipment fires. Additional hand fire extinguishers may be required for the protection of other compartments accessible to the crew in flight. Dry chemical fire extinguishers should not be used in the flight crew compartment, or in any compartment not separated by a partition from the flight crew compartment, because of the adverse effect on vision during discharge and, if conductive, interference with electrical contacts by the chemical residues.
- (c) Where only one hand fire extinguisher is required in the passenger compartments, it should be located near the cabin crew member's station, where provided.
- (d) Where two or more hand fire extinguishers are required in the passenger compartments and their location is not otherwise dictated by consideration of (a), an extinguisher should be located near each end of the cabin with the remainder distributed throughout the cabin as evenly as is practicable.
- (e) Unless an extinguisher is clearly visible, its location should be indicated by a placard or sign. Appropriate symbols may also be used to supplement such a placard or sign.

NCC.IDE.H.210 Marking of break-in points

Regulation (EU) No 800/2013

If areas of the helicopter's fuselage suitable for break-in by rescue crews in an emergency are marked, such areas shall be marked as shown in Figure 1.

Figure 1

Marking of break-in points

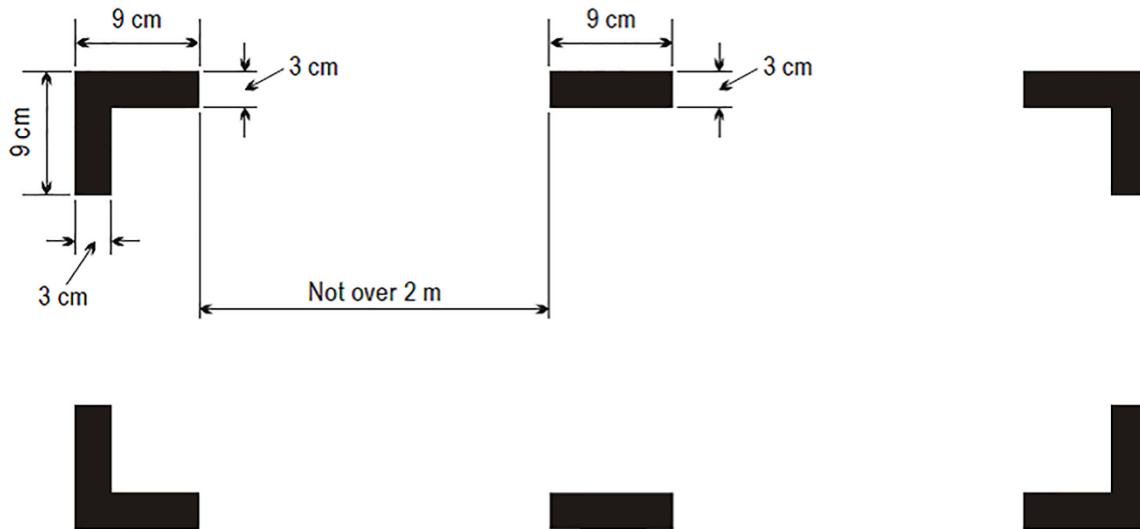

AMC1 NCC.IDE.H.210 Marking of break-in points

ED Decision 2013/021/R

MARKINGS – COLOUR AND CORNERS

- The colour of the markings should be red or yellow and, if necessary, should be outlined in white to contrast with the background.
- If the corner markings are more than 2 m apart, intermediate lines 9 cm x 3 cm should be inserted so that there is no more than 2 m between adjacent markings.

NCC.IDE.H.215 Emergency locator transmitter (ELT)

Regulation (EU) 2016/1199

- Helicopters shall be equipped with at least one automatic ELT.
- An ELT of any type shall be capable of transmitting simultaneously on 121,5 MHz and 406 MHz.

AMC1 NCC.IDE.H.215 Emergency locator transmitter (ELT)

ED Decision 2013/021/R

ELT BATTERIES

Batteries used in the ELTs should be replaced (or recharged, if the battery is rechargeable) when the equipment has been in use for more than 1 cumulative hour, and also when 50% of their useful life (or for rechargeable, 50% of their useful life of charge), as established by the equipment manufacturer,

has expired. The new expiry date for the replacement (or recharged) battery should be legibly marked on the outside of the equipment. The battery useful life (or useful life of charge) requirements of this paragraph do not apply to batteries (such as water-activated batteries) that are essentially unaffected during probable storage intervals.

AMC2 NCC.IDE.H.215 Emergency locator transmitter (ELT)

ED Decision 2021/008/R

TYPES OF ELTs AND GENERAL TECHNICAL SPECIFICATIONS

- (a) Point (a) of [AMC2 CAT.IDE.H.280](#) lists the applicable types of ELTs.
- (b) To minimise the possibility of damage in the event of crash impact, the automatic ELT should be rigidly fixed to the aircraft structure, as far aft as is practicable, with its antenna and connections arranged so as to maximise the probability of the signal being transmitted after a crash.
- (c) Any ELT carried should operate in accordance with the relevant provisions of ICAO Annex 10, Volume III and should be registered with the national agency responsible for initiating search and rescue or other nominated agency.

GM1 NCC.IDE.H.215 Emergency locator transmitter (ELT)

ED Decision 2021/008/R

TERMINOLOGY

[GM1 CAT.IDE.H.280](#) provides explanations of terms used in point [NCC.IDE.H.215](#) and in the related AMC.

GM2 NCC.IDE.H.215 Emergency locator transmitter (ELT)

ED Decision 2021/008/R

ADDITIONAL GUIDANCE

The guidance provided in [GM2 CAT.IDE.H.280](#) is also applicable to point [NCC.IDE.H.215](#).

NCC.IDE.H.225 Life-jackets

Regulation (EU) No 800/2013

- (a) Helicopters shall be equipped with a life-jacket for each person on board or equivalent individual floatation device for each person on board younger than 24 months, which shall be worn or stowed in a position that is readily accessible from the seat or berth of the person for whose use it is provided, when:
 - (1) operated on a flight over water at a distance from land corresponding to more than 10 minutes flying time at normal cruising speed, where in the case of the critical engine failure, the helicopter is able to sustain level flight;
 - (2) operated on a flight over water beyond autorotational distance from the land, where in the case of critical engine failure, the helicopter is not able to sustain level flight; or
 - (3) taking off or landing at an aerodrome or operating site where the take-off or approach path is over water.
- (b) Each life-jacket or equivalent individual floatation device shall be equipped with a means of electric illumination for the purpose of facilitating the location of persons.

AMC1 NCC.IDE.H.225(a) Life-jackets

ED Decision 2013/021/R

ACCESSIBILITY

The life-jacket should be accessible from the seat or berth of the person for whose use it is provided, with a safety belt or restraint system fastened.

AMC1 NCC.IDE.H.225(b) Life-jackets

ED Decision 2013/021/R

ELECTRIC ILLUMINATION

The means of electric illumination should be a survivor locator light as defined in the applicable ETSO issued by the Agency or equivalent.

GM1 NCC.IDE.H.225 Life-jackets

ED Decision 2013/021/R

SEAT CUSHIONS

Seat cushions are not considered to be flotation devices.

NCC.IDE.H.226 Crew survival suits

Regulation (EU) 2016/1199

Each crew member shall wear a survival suit when so determined by the pilot-in-command based on a risk assessment taking into account the following conditions:

- (a) flights over water beyond autorotational distance or safe forced landing distance from land, where in the case of a critical engine failure, the helicopter is not able to sustain level flight; and
- (b) the weather report or forecasts available to the commander/pilot-in-command indicate that the sea temperature will be less than plus 10 °C during the flight.

GM1 NCC.IDE.H.226 Crew survival suits

ED Decision 2013/021/R

ESTIMATING SURVIVAL TIME

- (a) Introduction
 - (1) A person accidentally immersed in cold seas (typically offshore Northern Europe) will have a better chance of survival if he/she is wearing an effective survival suit in addition to a life-jacket. By wearing the survival suit, he/she can slow down the rate which his/her body temperature falls and, consequently, protect himself/herself from the greater risk of drowning brought about by incapacitation due to hypothermia.
 - (2) The complete survival suit system — suit, life-jacket and clothes worn under the suit — should be able to keep the wearer alive long enough for the rescue services to find and recover him/her. In practice the limit is about 3 hours. If a group of persons in the water cannot be rescued within this time, they are likely to have become so scattered and separated that location will be extremely difficult, especially in the rough water typical of Northern European sea areas. If it is expected that in water protection could be required for periods greater than 3 hours, improvements should, rather, be sought in the search and rescue procedures than in the immersion suit protection.

(b) Survival times

- (1) The aim should be to ensure that a person in the water can survive long enough to be rescued, i.e. the survival time should be greater than the likely rescue time. The factors affecting both times are shown in Figure 1. The figure emphasises that survival time is influenced by many factors, physical and human. Some of the factors are relevant to survival in cold water and some are relevant in water at any temperature.

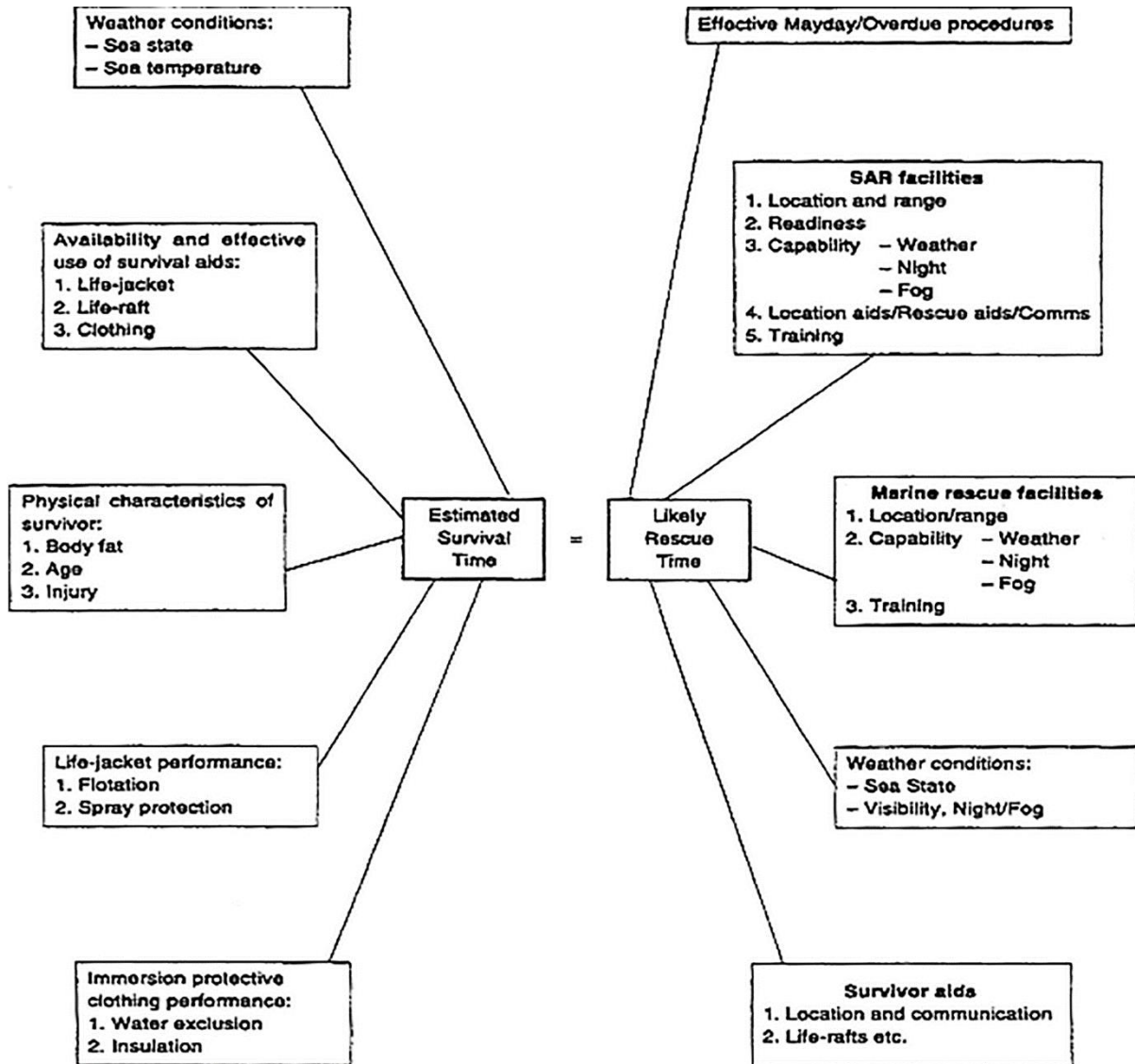

Figure 1: The survival equation

- (2) Broad estimates of likely survival times for the thin individual offshore are given in Table 1 below. As survival time is significantly affected by the prevailing weather conditions at the time of immersion, the Beaufort wind scale has been used as an indicator of these surface conditions.

Table 1: Timescale within which the most vulnerable individuals are likely to succumb to the prevailing conditions.

Clothing assembly	Beaufort wind force	Times within which the most vulnerable individuals are likely to drown	
		(water temp 5 °C)	(water temp 13 °C)
Working clothes (no immersion suit)	0 – 2	Within ¼ hour	Within 1 ¼ hours
	3 – 4	Within ½ hour	Within ½ hour
	5 and above	Significantly less than ½ hour	Significantly less than ½ hour
Immersion suit worn over working clothes (with leakage inside suit)	0 – 2	May well exceed 3 hours	May well exceed 3 hours
	3 – 4	Within 2 ¾ hours	May well exceed 3 hours
	5 and above	Significantly less than 2 ¾ hours. May well exceed 1 hour	May well exceed 3 hours

- (3) Consideration should also be given to escaping from the helicopter itself should it submerge or invert in the water. In this case, escape time is limited to the length of time the occupants can hold their breath. The breath holding time can be greatly reduced by the effect of cold shock. Cold shock is caused by the sudden drop in skin temperature on immersion, and is characterised by a gasp reflex and uncontrolled breathing. The urge to breath rapidly becomes overwhelming and, if still submerged, the individual will inhale water resulting in drowning. Delaying the onset of cold shock by wearing an immersion suit will extend the available escape time from a submerged helicopter.
- (4) The effects of water leakage and hydrostatic compression on the insulation quality of clothing are well recognised. In a nominally dry system the insulation is provided by still air trapped within the clothing fibres and between the layers of suit and clothes. It has been observed that many systems lose some of their insulating capacity either because the clothes under the 'waterproof' survival suit get wet to some extent or because of hydrostatic compression of the whole assembly. As a result of water leakage and compression, survival times will be shortened. The wearing of warm clothing under the suit is recommended.
- (5) Whatever type of survival suit and other clothing is provided, it should not be forgotten that significant heat loss can occur from the head.

NCC.IDE.H.227 Life-rafts, survival ELTs and survival equipment on extended overwater flights

Regulation (EU) No 800/2013

Helicopters operated:

- (a) on a flight over water at a distance from land corresponding to more than 10 minutes flying time at normal cruising speed, where in the case of the critical engine failure, the helicopter is able to sustain level flight; or
- (b) on a flight over water at a distance corresponding to more than 3 minutes flying time at normal cruising speed, where in the case of the critical engine failure, the helicopter is not able to sustain level flight, and if so determined by the pilot-in-command by means of a risk assessment;

shall be equipped with:

- (1) in the case of a helicopter carrying less than 12 persons, at least one life-raft with a rated capacity of not less than the maximum number of persons on board, stowed so as to facilitate their ready use in emergency;

- (2) in the case of a helicopter carrying more than 11 persons, at least two life-rafts, stowed so as to facilitate their ready use in an emergency, sufficient together to accommodate all persons capable of being carried on board and, if one is lost the remaining life-raft(s) having the overload capacity sufficient to accommodate all persons on the helicopter;
- (3) at least one survival ELT (ELT(S)) for each required life-raft; and
- (4) life-saving equipment, including means of sustaining life, as appropriate to the flight to be undertaken.

AMC1 NCC.IDE.H.227 Life-rafts, survival ELTs and survival equipment on extended overwater flights

ED Decision 2013/021/R

LIFE-RAFTS AND EQUIPMENT FOR MAKING DISTRESS SIGNALS

- (a) Each required life-raft should conform to the following specifications:
 - (1) be of an approved design and stowed so as to facilitate their ready use in an emergency;
 - (2) be radar conspicuous to standard airborne radar equipment;
 - (3) when carrying more than one life-raft on board, at least 50 % of the rafts should be able to be deployed by the crew while seated at their normal station, where necessary by remote control; and
 - (4) life-rafts that are not deployable by remote control or by the crew should be of such weight as to permit handling by one person. 40 kg should be considered a maximum weight.
- (b) Each required life-raft should contain at least the following:
 - (1) one approved survivor locator light;
 - (2) one approved visual signalling device;
 - (3) one canopy (for use as a sail, sunshade or rain catcher) or other means to protect occupants from the elements;
 - (4) one radar reflector;
 - (5) one 20 m retaining line designed to hold the life-raft near the helicopter but to release it if the helicopter becomes totally submerged;
 - (6) one sea anchor; and
 - (7) one survival kit, appropriately equipped for the route to be flown, which should contain at least the following:
 - (i) one life-raft repair kit;
 - (ii) one bailing bucket;
 - (iii) one signalling mirror;
 - (iv) one police whistle;
 - (v) one buoyant raft knife;
 - (vi) one supplementary means of inflation;
 - (vii) sea sickness tablets;

- (viii) one first-aid kit;
- (ix) one portable means of illumination;
- (x) 500 ml of pure water and one sea water desalting kit; and
- (xi) one comprehensive illustrated survival booklet in an appropriate language.

AMC1 NCC.IDE.H.227(b)(3) Life rafts, survival ELTs, and survival equipment on extended overwater flights

ED Decision 2021/008/R

SURVIVAL ELT

[AMC1 CAT.IDE.H.300\(b\)\(3\)](#) & [CAT.IDE.H.305\(b\)](#) provides the types of ELT that may be installed on a required life raft.

NCC.IDE.H.230 Survival equipment

Regulation (EU) No 800/2013

Helicopters operated over areas in which search and rescue would be especially difficult shall be equipped with:

- (a) signalling equipment to make distress signals;
- (b) at least one survival ELT (ELT(S)); and
- (c) additional survival equipment for the route to be flown taking account of the number of persons on board.

AMC1 NCC.IDE.H.230 Survival equipment

ED Decision 2013/021/R

ADDITIONAL SURVIVAL EQUIPMENT

- (a) The following additional survival equipment should be carried when required:
 - (1) 500 ml of water for each four, or fraction of four, persons on board;
 - (2) one knife;
 - (3) first-aid equipment; and
 - (4) one set of air/ground codes.
- (b) In addition, when polar conditions are expected, the following should be carried:
 - (1) a means of melting snow;
 - (2) one snow shovel and one ice saw;
 - (3) sleeping bags for use by 1/3 of all persons on board and space blankets for the remainder or space blankets for all passengers on board; and
 - (4) one arctic/polar suit for each crew member carried.
- (c) If any item of equipment contained in the above list is already carried on board the aircraft in accordance with another requirement, there is no need for this to be duplicated.

AMC2 NCC.IDE.H.230 Survival equipment

ED Decision 2013/021/R

SURVIVAL ELT

An ELT(AP) may be used to replace one required ELT(S) provided that it meets the ELT(S) requirements. A water-activated ELT(S) is not an ELT(AP).

GM1 NCC.IDE.H.230 Survival equipment

ED Decision 2013/021/R

SIGNALLING EQUIPMENT

The signalling equipment for making distress signals is described in ICAO Annex 2, Rules of the Air.

GM2 NCC.IDE.H.230 Survival equipment

ED Decision 2013/021/R

AREAS IN WHICH SEARCH AND RESCUE WOULD BE ESPECIALLY DIFFICULT

The expression 'areas in which search and rescue would be especially difficult' should be interpreted, in this context, as meaning:

- (a) areas so designated by the competent authority responsible for managing search and rescue; or
- (b) areas that are largely uninhabited and where:
 - (1) the authority referred to in (a) has not published any information to confirm whether search and rescue would be or would not be especially difficult; and
 - (2) the authority referred to in (a) does not, as a matter of policy, designate areas as being especially difficult for search and rescue.

NCC.IDE.H.231

Regulation (EU) No 800/2013

[deleted with Reg. (EU) 2016/1199 as of 1/07/2018]

NCC.IDE.H.232 Helicopters certified for operating on water – miscellaneous equipment

Regulation (EU) No 800/2013

Helicopters certified for operating on water shall be equipped with:

- (a) a sea anchor and other equipment necessary to facilitate mooring, anchoring or manoeuvring the helicopter on water, appropriate to its size, weight and handling characteristics; and
- (b) equipment for making the sound signals prescribed in the International Regulations for Preventing Collisions at Sea, where applicable.

GM1 NCC.IDE.H.232 Helicopters certificated for operating on water – Miscellaneous equipment

ED Decision 2015/003/R

INTERNATIONAL REGULATIONS FOR PREVENTING COLLISIONS AT SEA

International Regulations for Preventing Collisions at Sea are those that were published by the International Maritime Organisation (IMO) in 1972.

NCC.IDE.H.235 All helicopters on flights over water – ditching

Regulation (EU) 2019/1384

Helicopters shall be designed for landing on water or certified for ditching in accordance with the relevant certification specifications or fitted with emergency flotation equipment when operated on a flight over water in a hostile environment at a distance from land corresponding to more than 10 minutes flying time at normal cruising speed.

AMC1 NCC.IDE.H.235 All helicopters on flight over water – ditching

ED Decision 2016/022/R

The considerations of [AMC1 SPA.HOFO.165\(d\)](#) should apply in respect of emergency flotation equipment.

GENERAL

- (a) A headset consists of a communication device that includes two earphones to receive and a microphone to transmit audio signals to the helicopter's communication system. To comply with the minimum performance requirements, the earphones and microphone should match the communication system's characteristics and the flight crew compartment environment. The headset should be adequately adjustable in order to fit the flight crew's head. Headset boom microphones should be of the noise cancelling type.
- (b) If the intention is to utilise noise cancelling earphones, the operator should ensure that the earphones do not attenuate any aural warnings or sounds necessary for alerting the flight crew on matters related to the safe operation of the helicopter.

NCC.IDE.H.240 Headset

Regulation (EU) No 800/2013

Whenever a radio communication and/or radio navigation system is required, helicopters shall be equipped with a headset with boom microphone or equivalent and a transmit button on the flight controls for each required pilot and/or crew member at his/her assigned station.

GM1 NCC.IDE.H.240 Headset

ED Decision 2013/021/R

GENERAL

The term 'headset' includes any aviation helmet incorporating headphones and microphone worn by a flight crew member.

NCC.IDE.H.245 Radio communication equipment

Regulation (EU) No 800/2013

- (a) Helicopters operated under IFR or at night, or when required by the applicable airspace requirements, shall be equipped with radio communication equipment that, under normal radio propagating conditions, shall be capable of:
 - (1) conducting two-way communication for aerodrome control purposes;
 - (2) receiving meteorological information;
 - (3) conducting two-way communication at any time during flight with those aeronautical stations and on those frequencies prescribed by the appropriate authority; and
 - (4) providing for communication on the aeronautical emergency frequency 121,5 MHz.
- (b) When more than one communications equipment unit is required, each shall be independent of the other or others to the extent that a failure in any one will not result in failure of any other.
- (c) When a radio communication system is required, and in addition to the flight crew interphone system required in [NCC.IDE.H.155](#), helicopters shall be equipped with a transmit button on the flight controls for each required pilot and crew member at his/her assigned station.

GM1 NCC.IDE.H.245 Radio communication equipment

ED Decision 2013/021/R

APPLICABLE AIRSPACE REQUIREMENTS

For helicopters being operated under European air traffic control, the applicable airspace requirements include the Single European Sky legislation.

NCC.IDE.H.250 Navigation equipment

Regulation (EU) 2019/1384

- (a) Helicopters shall be equipped with navigation equipment that will enable them to proceed in accordance with:
 - (1) the ATS flight plan, if applicable; and
 - (2) the applicable airspace requirements.
- (b) Helicopters shall have sufficient navigation equipment to ensure that, in the event of the failure of one item of equipment at any stage of the flight, the remaining equipment shall allow safe navigation in accordance with (a), or an appropriate contingency action, to be completed safely.
- (c) Helicopters operated on flights in which it is intended to land in IMC shall be equipped with navigation equipment capable of providing guidance to a point from which a visual landing can be performed. This equipment shall be capable of providing such guidance for each aerodrome at which it is intended to land in IMC and for any designated alternate aerodromes.
- (d) When PBN is required the aircraft shall meet the airworthiness certification requirements for the appropriate navigation specification.
- (e) Helicopters shall be equipped with surveillance equipment in accordance with the applicable airspace requirements.

GM1 NCC.IDE.H.250 Navigation equipment

ED Decision 2016/017/R

AIRCRAFT ELIGIBILITY FOR PBN SPECIFICATION NOT REQUIRING SPECIFIC APPROVAL

- (a) The performance of the aircraft is usually stated in the AFM.
- (b) Where such a reference cannot be found in the AFM, other information provided by the aircraft manufacturer as TC holder, the STC holder or the design organisation having a privilege to approve minor changes may be considered.
- (c) The following documents are considered acceptable sources of information:
 - (1) AFM, supplements thereto and documents directly referenced in the AFM;
 - (2) FCOM or similar document;
 - (3) Service Bulletin or Service Letter issued by the TC holder or STC holder;
 - (4) approved design data or data issued in support of a design change approval;
 - (5) any other formal document issued by the TC or STC holders stating compliance with PBN specifications, AMC, Advisory Circulars (AC) or similar documents issued by the State of Design; and
 - (6) written evidence obtained from the State of Design.
- (d) Equipment qualification data, in itself, is not sufficient to assess the PBN capabilities of the aircraft, since the latter depend on installation and integration.
- (e) As some PBN equipment and installations may have been certified prior to the publication of the PBN Manual and the adoption of its terminology for the navigation specifications, it is not always possible to find a clear statement of aircraft PBN capability in the AFM. However, aircraft eligibility for certain PBN specifications can rely on the aircraft performance certified for PBN procedures and routes prior to the publication of the PBN Manual.
- (f) Below, various references are listed which may be found in the AFM or other acceptable documents (see listing above) in order to consider the aircraft's eligibility for a specific PBN specification if the specific term is not used.
- (g) RNAV 5
 - (1) If a statement of compliance with any of the following specifications or standards is found in the acceptable documentation as listed above, the aircraft is eligible for RNAV 5 operations.
 - (i) B-RNAV;
 - (ii) RNAV 1;
 - (iii) RNP APCH;
 - (iv) RNP 4;
 - (v) A-RNP;
 - (vi) AMC 20-4;
 - (vii) JAA TEMPORARY GUIDANCE MATERIAL, LEAFLET NO. 2 (TGL 2);
 - (viii) JAA AMJ 20X2;
 - (ix) FAA AC 20-130A for en route operations;

- (x) FAA AC 20-138 for en route operations; and
 - (xi) FAA AC 90-96.
- (h) RNAV 1/RNAV 2
- (1) If a statement of compliance with any of the following specifications or standards is found in the acceptable documentation as listed above, the aircraft is eligible for RNAV 1/RNAV 2 operations.
 - (i) RNAV 1;
 - (ii) PRNAV;
 - (iii) US RNAV type A;
 - (iv) FAA AC 20-138 for the appropriate navigation specification;
 - (v) FAA AC 90-100A;
 - (vi) JAA TEMPORARY GUIDANCE MATERIAL, LEAFLET NO. 10 Rev1 (TGL 10); and
 - (vii) FAA AC 90-100.
 - (2) However, if position determination is exclusively computed based on VOR-DME, the aircraft is not eligible for RNAV 1/RNAV 2 operations.
- (i) RNP 1/RNP 2 continental
- (1) If a statement of compliance with any of the following specifications or standards is found in the acceptable documentation as listed above, the aircraft is eligible for RNP 1/RNP 2 continental operations.
 - (i) A-RNP;
 - (ii) FAA AC 20-138 for the appropriate navigation specification; and
 - (iii) FAA AC 90-105.
 - (2) Alternatively, if a statement of compliance with any of the following specifications or standards is found in the acceptable documentation as listed above and position determination is primarily based on GNSS, the aircraft is eligible for RNP 1/RNP 2 continental operations. However, in these cases, loss of GNSS implies loss of RNP 1/RNP 2 capability.
 - (i) JAA TEMPORARY GUIDANCE MATERIAL, LEAFLET NO. 10 (TGL 10) (any revision); and
 - (ii) FAA AC 90-100.
- (j) RNP APCH — LNAV minima
- (1) If a statement of compliance with any of the following specifications or standards is found in the acceptable documentation as listed above, the aircraft is eligible for RNP APCH — LNAV operations.
 - (i) A-RNP;
 - (ii) AMC 20-27;
 - (iii) AMC 20-28;
 - (iv) FAA AC 20-138 for the appropriate navigation specification; and

- (v) FAA AC 90-105 for the appropriate navigation specification.
- (2) Alternatively, if a statement of compliance with RNP 0.3 GNSS approaches in accordance with any of the following specifications or standards is found in the acceptable documentation as listed above, the aircraft is eligible for RNP APCH — LNAV operations. Any limitation such as ‘within the US National Airspace’ may be ignored since RNP APCH procedures are assumed to meet the same ICAO criteria around the world.
 - (i) JAA TEMPORARY GUIDANCE MATERIAL, LEAFLET NO. 3 (TGL 3);
 - (ii) AMC 20-4;
 - (iii) FAA AC 20-130A; and
 - (iv) FAA AC 20-138.
- (k) RNP APCH — LNAV/VNAV minima
 - (1) If a statement of compliance with any of the following specifications or standards is found in the acceptable documentation as listed above, the aircraft is eligible for RNP APCH — LNAV/VNAV operations.
 - (i) A-RNP;
 - (ii) AMC 20-27 with Baro VNAV;
 - (iii) AMC 20-28;
 - (iv) FAA AC 20-138; and
 - (v) FAA AC 90-105 for the appropriate navigation specification.
 - (2) Alternatively, if a statement of compliance with FAA AC 20-129 is found in the acceptable documentation as listed above, and the aircraft complies with the requirements and limitations of EASA SIB 2014-041, the aircraft is eligible for RNP APCH — LNAV/VNAV operations. Any limitation such as ‘within the US National Airspace’ may be ignored since RNP APCH procedures are assumed to meet the same ICAO criteria around the world.
- (l) RNP APCH — LPV minima
 - (1) If a statement of compliance with any of the following specifications or standards is found in the acceptable documentation as listed above, the aircraft is eligible for RNP APCH — LPV operations.
 - (i) AMC 20-28;
 - (ii) FAA AC 20-138 for the appropriate navigation specification; and
 - (iii) FAA AC 90-107.
 - (2) For aircraft that have a TAWS Class A installed and do not provide Mode-5 protection on an LPV approach, the DH is limited to 250 ft.
- (m) RNAV 10
 - (1) If a statement of compliance with any of the following specifications or standards is found in the acceptable documentation as listed above, the aircraft is eligible for RNAV 10 operations.

¹ <http://ad.easa.europa.eu/ad/2014-04>

- (i) RNP 10;
 - (ii) FAA AC 20-138 for the appropriate navigation specification;
 - (iii) AMC 20-12;
 - (iv) FAA Order 8400.12 (or later revision); and
 - (v) FAA AC 90-105.
- (n) RNP 4
- (1) If a statement of compliance with any of the following specifications or standards is found in the acceptable documentation as listed above, the aircraft is eligible for RNP 4 operations.
 - (i) FAA AC 20-138B or later, for the appropriate navigation specification;
 - (ii) FAA Order 8400.33; and
 - (iii) FAA AC 90-105 for the appropriate navigation specification.
- (o) RNP 2 oceanic
- (1) If a statement of compliance with FAA AC 90-105 for the appropriate navigation specification is found in the acceptable documentation as listed above, the aircraft is eligible for RNP 2 oceanic operations.
 - (2) If the aircraft has been assessed eligible for RNP 4, the aircraft is eligible for RNP 2 oceanic.
- (p) Special features
- (1) RF in terminal operations (used in RNP 1 and in the initial segment of the RNP APCH)
 - (i) If a statement of demonstrated capability to perform an RF leg, certified in accordance with any of the following specifications or standards, is found in the acceptable documentation as listed above, the aircraft is eligible for RF in terminal operations.
 - (A) AMC 20-26; and
 - (B) FAA AC 20-138B or later.
 - (ii) If there is a reference to RF and a reference to compliance with AC 90-105, then the aircraft is eligible for such operations.
- (q) Other considerations
- (1) In all cases, the limitations in the AFM need to be checked, in particular the use of AP or FD which can be required to reduce the FTE primarily for RNP APCH, RNAV 1, and RNP 1.
 - (2) Any limitation such as 'within the US National Airspace' may be ignored since RNP APCH procedures are assumed to meet the same ICAO criteria around the world.

GM2 NCC.IDE.H.250 Navigation equipment

ED Decision 2016/017/R

GENERAL

- (a) The PBN specifications for which the aircraft complies with the relevant airworthiness criteria are set out in the AFM, together with any limitations to be observed.

- (b) Because functional and performance requirements are defined for each navigation specification, an aircraft approved for an RNP specification is not automatically approved for all RNAV specifications. Similarly, an aircraft approved for an RNP or RNAV specification having a stringent accuracy requirement (e.g. RNP 0.3 specification) is not automatically approved for a navigation specification having a less stringent accuracy requirement (e.g. RNP 4).

RNP 4

- (c) For RNP 4, at least two LRNSs, capable of navigating to RNP 4, and listed in the AFM, may be operational at the entry point of the RNP 4 airspace. If an item of equipment required for RNP 4 operations is unserviceable, then the flight crew may consider an alternate route or diversion for repairs. For multi-sensor systems, the AFM may permit entry if one GNSS sensor is lost after departure, provided one GNSS and one inertial sensor remain available.

NCC.IDE.H.255 Transponder*Regulation (EU) No 800/2013*

Helicopters shall be equipped with a pressure altitude reporting secondary surveillance radar (SSR) transponder and any other SSR transponder capability required for the route being flown.

AMC1 NCC.IDE.H.255 Transponder*ED Decision 2013/021/R***SSR TRANSPONDER**

- (a) The secondary surveillance radar (SSR) transponders of helicopters being operated under European air traffic control should comply with any applicable Single European Sky legislation.
- (b) If the Single European Sky legislation is not applicable, the SSR transponders should operate in accordance with the relevant provisions of Volume IV of ICAO Annex 10.

NCC.IDE.H.260 Management of aeronautical databases*Regulation (EU) 2016/1199*

- (a) Aeronautical databases used on certified aircraft system applications shall meet data quality requirements that are adequate for the intended use of the data.
- (b) The operator shall ensure the timely distribution and insertion of current and unaltered aeronautical databases to all aircraft that require them.
- (c) Notwithstanding any other occurrence reporting requirements as defined in Regulation (EU) No 376/2014, the operator shall report to the database provider instances of erroneous, inconsistent or missing data that might be reasonably expected to constitute a hazard to flight.

In such cases, the operator shall inform flight crew and other personnel concerned, and shall ensure that the affected data is not used.

AMC1 NCC.IDE.H.260 Management of aeronautical databases*ED Decision 2017/003/R***AERONAUTICAL DATABASES**

When the operator of an aircraft uses an aeronautical database that supports an airborne navigation application as a primary means of navigation used to meet the airspace usage requirements, the

database provider should be a Type 2 DAT provider certified in accordance with Regulation (EU) 2017/373 or equivalent.

GM1 NCC.IDE.H.260 Management of aeronautical databases

ED Decision 2017/003/R

AERONAUTICAL DATABASE APPLICATIONS

- (a) Applications using aeronautical databases for which Type 2 DAT providers should be certified in accordance with Regulation (EU) 2017/373 may be found in GM1 DAT.OR.100.
- (b) The certification of a Type 2 DAT provider in accordance with Regulation (EU) 2017/373 ensures data integrity and compatibility with the certified aircraft application/equipment.

GM2 NCC.IDE.H.260 Management of aeronautical databases

ED Decision 2017/003/R

TIMELY DISTRIBUTION

The operator should distribute current and unaltered aeronautical databases to all aircraft requiring them in accordance with the validity period of the databases or in accordance with a procedure established in the operations manual if no validity period is defined.

GM3 NCC.IDE.H.260 Management of aeronautical databases

ED Decision 2017/003/R

STANDARDS FOR AERONAUTICAL DATABASES AND DAT PROVIDERS

- (a) A 'Type 2 DAT provider' is an organisation as defined in Article 2(5)(b) of Regulation (EU) 2017/373.
- (b) Equivalent to a certified 'Type 2 DAT provider' is defined in any Aviation Safety Agreement between the European Union and a third country, including any Technical Implementation Procedures, or any Working Arrangements between EASA and the competent authority of a third country.

ANNEX VII (PART-NCO)

SUBPART A: GENERAL REQUIREMENTS

NCO.GEN.100 Competent authority

Regulation (EU) 2019/1384

- (a) The competent authority shall be the authority designated by the Member State where the aircraft is registered.
- (b) If the aircraft is registered in a third country, the competent authority shall be the authority designated by the Member State where the operator has its principal place of business, is established or is residing.

GM1 NCO.GEN.100(b) Competent authority

ED Decision 2019/019/R

DETERMINING THE PLACE WHERE AN OPERATOR IS RESIDING

For the purpose of Regulation (EU) No 965/2012, the concept of ‘place where the operator is residing’ is mainly addressed to a natural person.

The place where the operator resides is the place where the operator complies with his or her tax obligations.

Several criteria can be used to help determining a person’s place of residence. These include, for example:

- (a) the duration of a person’s presence on the territory of the countries concerned;
- (b) the person’s family status and ties;
- (c) the person’s housing situation and how permanent it is;
- (d) the place where the person pursues professional or non-profit activities;
- (e) the characteristics of the person’s professional activity;
- (f) the Member State where the person resides for taxation purposes.

NCO.GEN.101 Means of compliance

Regulation (EU) No 800/2013

Alternative means of compliance to those adopted by the Agency may be used by an operator to establish compliance with Regulation (EC) No 216/2008 and its Implementing Rules.

NCO.GEN.103 Introductory flights

Regulation (EU) 2018/1975

Introductory flights referred to in Article 6(4a)(c) of this Regulation when conducted in accordance with this Annex, shall:

- (a) start and end at the same aerodrome or operating site;
- (b) be operated under VFR by day;
- (c) be overseen by a nominated person responsible for their safety; and

- (d) comply with any other conditions stipulated by the competent authority.

NCO.GEN.104 Use of aircraft included in an AOC by an NCO operator

Regulation (EU) 2019/1384

- (a) An NCO operator may use other than complex motor-powered aircraft listed on an operator's AOC to conduct non-commercial operations in accordance with this Annex.
- (b) The NCO operator using the aircraft in accordance with point (a) shall establish a procedure:
- (1) clearly describing how operational control of the aircraft is transferred between the AOC holder and the NCO operator, as referred to in point ORO.GEN.310 of Annex III;
 - (2) describing the handover procedure of the aircraft upon its return to the AOC holder.
- That procedure shall be included in a contract between the AOC holder and the NCO operator.
- The NCO operator shall ensure that the procedure is communicated to the relevant personnel.
- (c) The continuing airworthiness of the aircraft used pursuant to point (a) shall be managed by organisation responsible for the continuing airworthiness for the aircraft included in the AOC, in accordance with Regulation (EU) No 1321/2014.
- (d) The NCO operator using the aircraft in accordance with point (a) shall ensure the following:
- (1) that every flight conducted under its operational control is recorded in the aircraft technical log system;
 - (2) that no changes to the aircraft systems or configuration are made;
 - (3) that any defect or technical malfunction occurring while the aircraft is under its operational control is reported to the organisation referred to in point (c) immediately after the flight;
 - (4) that the AOC holder receives a copy of any occurrence report related to the flights performed with the aircraft, completed in accordance with Regulation (EU) No 376/2014 and Regulation (EU) 2015/1018.

AMC1 NCO.GEN.104 Use of aircraft included in an AOC by an NCO operator

ED Decision 2019/019/R

RESPONSIBILITIES OF THE NCO OPERATOR

The operator using the aircraft included in an AOC for operations performed in accordance with Part-NCO should describe the following elements in its procedure required in [NCO.GEN.104](#):

- (a) the way in which the shifting of operational control is communicated, including how, when and to whom the information is communicated;
- (b) the means to ensure that the relevant personnel are instructed on the following:
- (1) to contact the organisation responsible for the management of continuing airworthiness of the aircraft of the AOC holder (CAMO or CAO) for any defect or technical malfunction which occurs before or during the operation.

The information about any defect or malfunction should be transmitted to the CAMO/CAO of the AOC holder before the aircraft is used for the next flight. The same information should be confirmed by the entries in the aircraft technical log system; and

- (2) to report any occurrence in accordance with the applicable rules and the internal procedures; and
- (c) the way in which the operator deals with failures and defects identified before the flight.

GM1 NCO.GEN.104 Use of aircraft included in an AOC by an NCO operator

ED Decision 2019/019/R

SCOPE

As per [SPO.GEN.005\(b\)](#), operators performing non-commercial specialised operations with other than complex motor-powered aircraft will comply with Annex VII (Part-NCO). Thus, such operators are also covered by [NCO.GEN.104](#).

GM1 NCO.GEN.104(c) Use of aircraft included in an AOC by an NCO operator

ED Decision 2019/019/R

CONTINUING AIRWORTHINESS MANAGEMENT

In accordance with Annex I (Part-M) and Annex Vb (Part-ML) to Regulation (EU) No 1321/2014, the management of the continuing airworthiness of the aircraft by the CAMO/CAO of the AOC holder means that the NCO operator has established a written contract as per Appendix I to Part-M or Appendix I to Part-ML with this CAMO/CAO.

NCO.GEN.105 Pilot-in-command responsibilities and authority

Regulation (EU) 2018/1975

- (a) The pilot-in-command shall be responsible for:
 - (1) the safety of the aircraft and of all crew members, passengers and cargo on board during aircraft operations as referred to in 1.c of Annex IV to Regulation (EC) No 216/2008;
 - (2) the initiation, continuation, termination or diversion of a flight in the interest of safety;
 - (3) ensuring that all operational procedures and checklists are complied with as referred to in 1.b of Annex IV to Regulation (EC) No 216/2008;
 - (4) only commencing a flight if he/she is satisfied that all operational limitations referred to in 2.a.3 of Annex IV to Regulation (EC) No 216/2008 are complied with, as follows:
 - (i) the aircraft is airworthy;
 - (ii) the aircraft is duly registered;
 - (iii) instruments and equipment required for the execution of that flight are installed in the aircraft and are operative, unless operation with inoperative equipment is permitted by the minimum equipment list (MEL) or equivalent document, if applicable, as provided for in points [NCO.IDE.A.105](#) or [NCO.IDE.H.105](#);

- (iv) the mass of the aircraft and the centre of gravity location are such that the flight can be conducted within limits prescribed in the airworthiness documentation;
 - (v) all equipment, baggage and cargo are properly loaded and secured and an emergency evacuation remains possible;
 - (vi) the aircraft operating limitations as specified in the aircraft flight manual (AFM) will not be exceeded at any time during the flight; and
 - (vii) any navigational database required for PBN is suitable and current;
- (5) not commencing a flight if he/she is incapacitated from performing duties by any cause such as injury, sickness, fatigue or the effects of any psychoactive substance;
- (6) not continuing a flight beyond the nearest weather-permissible aerodrome or operating site when his/her capacity to perform duties is significantly reduced from causes such as fatigue, sickness or lack of oxygen;
- (7) deciding on acceptance of the aircraft with unserviceabilities in accordance with the configuration deviation list (CDL) or minimum equipment list (MEL), as applicable; and
- (8) recording utilisation data and all known or suspected defects in the aircraft at the termination of the flight, or series of flights, in the aircraft technical log or journey log for the aircraft.
- (b) The pilot-in-command shall ensure that during critical phases of flight or whenever deemed necessary in the interest of safety, all crew members are seated at their assigned stations and do not perform any activities other than those required for the safe operation of the aircraft.
- (c) The pilot-in-command shall have the authority to refuse carriage of or disembark any person, baggage or cargo that may represent a potential hazard to the safety of the aircraft or its occupants.
- (d) The pilot-in-command shall, as soon as possible, report to the appropriate air traffic services (ATS) unit any hazardous weather or flight conditions encountered that are likely to affect the safety of other aircraft.
- (e) The pilot-in-command shall, in an emergency situation that requires immediate decision and action, take any action he/she considers necessary under the circumstances in accordance with 7.d of Annex IV to Regulation (EC) No 216/2008. In such cases he/she may deviate from rules, operational procedures and methods in the interest of safety.
- (f) During flight, the pilot-in-command shall:
- (1) keep his/her safety belt fastened while at his/her station; and
 - (2) remain at the controls of the aircraft at all times except if another pilot is taking the controls.
- (g) The pilot-in-command shall submit a report of an act of unlawful interference without delay to the competent authority and shall inform the designated local authority.
- (h) The pilot-in-command shall notify the nearest appropriate authority by the quickest available means of any accident involving the aircraft that results in serious injury or death of any person or substantial damage to the aircraft or property.

AMC1 NCO.GEN.105 Pilot-in-command responsibilities and authority

ED Decision 2016/018/R

FLIGHT PREPARATION FOR PBN OPERATIONS

- (a) The pilot-in-command should ensure that RNAV 1, RNAV 2, RNP 1, RNP 2, and RNP APCH routes or procedures to be used for the intended flight, including for any alternate aerodromes, are selectable from the navigation database and are not prohibited by NOTAM.
- (b) The pilot-in-command should take account of any NOTAMs or pilot-in-command briefing material that could adversely affect the aircraft system operation along its flight plan including any alternate aerodromes.
- (c) When PBN relies on GNSS systems for which RAIM is required for integrity, its availability should be verified during the preflight planning. In the event of a predicted continuous loss of fault detection of more than five minutes, the flight planning should be revised to reflect the lack of full PBN capability for that period.
- (d) For RNP 4 operations with only GNSS sensors, a fault detection and exclusion (FDE) check should be performed. The maximum allowable time for which FDE capability is projected to be unavailable on any one event is 25 minutes. If predictions indicate that the maximum allowable FDE outage will be exceeded, the operation should be rescheduled to a time when FDE is available.
- (e) For RNAV 10 operations, the pilot-in-command should take account of the RNAV 10 time limit declared for the inertial system, if applicable, considering also the effect of weather conditions that could affect flight duration in RNAV 10 airspace. Where an extension to the time limit is permitted, the pilot-in-command will need to ensure that en route radio facilities are serviceable before departure, and to apply radio updates in accordance with any AFM/POH limitation.

AMC2 NCO.GEN.105 Pilot-in-command responsibilities and authority

ED Decision 2016/018/R

DATABASE SUITABILITY

- (a) The pilot-in-command should check that any navigational database required for PBN operations includes the routes and procedures required for the flight.

DATABASE CURRENCY

- (b) The database validity (current AIRAC cycle) should be checked before the flight.
- (c) Navigation databases should be current for the duration of the flight. If the AIRAC cycle is due to change during flight, the pilot-in-command should follow procedures established by the pilot-in-command to ensure the accuracy of navigation data, including the suitability of navigation facilities used to define the routes and procedures for the flight.
- (d) An expired database may only be used if the following conditions are satisfied:
 - (1) the pilot-in-command has confirmed that the parts of the database which are intended to be used during the flight and any contingencies that are reasonable to expect are not changed in the current version;
 - (2) any NOTAMs associated with the navigational data are taken into account;

- (3) maps and charts corresponding to those parts of the flight are current and have not been amended since the last cycle;
- (4) any MEL limitations, where available, are observed; and
- (5) the database has expired by no more than 28 days.

GM1 NCO.GEN.105 Pilot-in-command responsibilities and authority

ED Decision 2019/008/R

GENERAL

In accordance with point 1.3 of Annex V to Regulation (EU) 2018/1139¹ (essential requirements for air operations), the pilot-in-command is responsible for the operation and safety of the aircraft and for the safety of all passengers and cargo on board. This includes the following:

- (a) the safety of all passengers and cargo on board, as soon as he/she arrives on board, until he/she leaves the aircraft at the end of the flight; and
- (b) the operation and safety of the aircraft:
 - (1) for aeroplanes, from the moment it is first ready to move for the purpose of flight until the moment it comes to rest at the end of the flight and the engine(s) used as primary propulsion unit(s) is/are shut down;
 - (2) for helicopters, from the moment the engine(s) are started until the helicopter comes to rest at the end of the flight with the engine(s) shut down and the rotor blades stopped.

GM1 NCO.GEN.105(a)(8) Pilot-in-command responsibilities and authority

ED Decision 2014/016/R

RECORDING UTILISATION DATA

Where an aircraft conducts a series of flights of short duration — such as a helicopter doing a series of lifts — and the aircraft is operated by the same pilot-in-command, the utilisation data for the series of flights may be recorded in the aircraft technical log or journey log as a single entry.

AMC1 NCO.GEN.105(a)(3) Pilot-in-command responsibilities and authority

ED Decision 2022/005/R

CHECKLISTS

- (a) The pilot-in-command should use the latest checklists provided by the manufacturer.
- (b) If checks conducted prior to take-off are suspended at any point, the pilot-in-command should restart them from a safe point prior to the interruption.

¹ Regulation (EU) 2018/1139 of the European Parliament and of the Council of 4 July 2018 on common rules in the field of civil aviation and establishing a European Union Aviation Safety Agency, and amending Regulations (EC) No 2111/2005, (EC) No 1008/2008, (EU) No 996/2010, (EU) No 376/2014 and Directives 2014/30/EU and 2014/53/EU of the European Parliament and of the Council, and repealing Regulations (EC) No 552/2004 and (EC) No 216/2008 of the European Parliament and of the Council and Council Regulation (EEC) No 3922/91 (OJ L 212, 22.8.2018, p. 1).

GM1 NCO.GEN.105(d) Pilot-in-command responsibilities and authority

ED Decision 2014/016/R

REPORTING OF HAZARDOUS FLIGHT CONDITIONS

- (a) These reports should include any detail which may be pertinent to the safety of other aircraft.
- (b) Such reports should be made whenever any of the following conditions are encountered or observed:
 - (1) severe turbulence;
 - (2) severe icing;
 - (3) severe mountain wave;
 - (4) thunderstorms, with or without hail, that are obscured, embedded, widespread or in squall lines;
 - (5) heavy dust storm or heavy sandstorm;
 - (6) volcanic ash cloud; and
 - (7) unusual and/or increasing volcanic activity or a volcanic eruption.
- (c) When other meteorological conditions not listed above, e.g. wind shear, are encountered that, in the opinion of the pilot-in-command, may affect the safety or the efficiency of other aircraft operations, the pilot-in-command should advise the appropriate air traffic services (ATS) unit as soon as practicable.

AMC1 NCO.GEN.105(e) Pilot-in-command responsibilities and authority

ED Decision 2014/016/R

VIOLATION REPORTING

If required by the State in which the incident occurs, the pilot-in-command should submit a report on any such violation to the appropriate authority of such State; in that event, the pilot-in-command should also submit a copy of it to the competent authority. Such reports should be submitted as soon as possible and normally within 10 days.

NCO.GEN.110 Compliance with laws, regulations and procedure

Regulation (EU) No 800/2013

- (a) The pilot-in-command shall comply with the laws, regulations and procedures of those States where operations are conducted.
- (b) The pilot-in-command shall be familiar with the laws, regulations and procedures, pertinent to the performance of his/her duties, prescribed for the areas to be traversed, the aerodromes or operating sites to be used and the related air navigation facilities as referred to in 1.a of Annex IV to Regulation (EC) No 216/2008.

NCO.GEN.115 Taxiing of aeroplanes

Regulation (EU) No 800/2013

An aeroplane shall only be taxied on the movement area of an aerodrome if the person at the controls:

- (a) is an appropriately qualified pilot; or
- (b) has been designated by the operator and:
 - (1) is trained to taxi the aeroplane;
 - (2) is trained to use the radio telephone, if radio communications are required;
 - (3) has received instruction in respect of aerodrome layout, routes, signs, marking, lights, air traffic control (ATC) signals and instructions, phraseology and procedures; and
 - (4) is able to conform to the operational standards required for safe aeroplane movement at the aerodrome.

GM1 NCO.GEN.115 Taxiing of aeroplanes

ED Decision 2015/004/R

SAFETY-CRITICAL ACTIVITY

- (a) Taxiing should be treated as a safety-critical activity due to the risks related to the movement of the aeroplane and the potential for a catastrophic event on the ground.
- (b) Taxiing is a high-workload phase of flight that requires the full attention of the pilot-in-command.

GM1 NCO.GEN.115(b)(4) Taxiing of aeroplanes

ED Decision 2014/016/R

SKILLS AND KNOWLEDGE

The person designated by the operator to taxi an aeroplane should possess the following skills and knowledge:

- (a) positioning of the aeroplane to ensure safety when starting engine;
- (b) getting ATIS reports and taxi clearance, where applicable;
- (c) interpretation of airfield markings/lights/signals/indicators;
- (d) interpretation of marshalling signals, where applicable;
- (e) identification of suitable parking area;
- (f) maintaining lookout and right-of-way rules and complying with ATC or marshalling instructions when applicable;
- (g) avoidance of adverse effect of propeller slipstream or jet wash on other aeroplanes, aerodrome facilities and personnel;
- (h) inspection of taxi path when surface conditions are obscured;
- (i) communication with others when controlling an aeroplane on the ground;
- (j) interpretation of operational instructions;
- (k) reporting of any problem that may occur while taxiing an aeroplane; and

- (l) adapting the taxi speed in accordance with prevailing aerodrome, traffic, surface and weather conditions.

NCO.GEN.120 Rotor engagement – helicopters

Regulation (EU) No 800/2013

A helicopter rotor shall only be turned under power for the purpose of flight with a qualified pilot at the controls.

GM1 NCO.GEN.120 Rotor engagement

ED Decision 2014/016/R

INTENT OF THE RULE

- (a) The following two situations where it is allowed to turn the rotor under power should be distinguished:
- (1) for the purpose of flight, this is described in the implementing rule;
 - (2) for maintenance purposes.
- (b) Rotor engagement for the purpose of flight: it should be noted that the pilot should not leave the control when the rotors are turning. For example, the pilot is not allowed to get out of the aircraft in order to welcome passengers and adjust their seat belts with the rotors turning.
- (c) Rotor engagement for the purpose of maintenance: the implementing rule, however, should not prevent ground runs being conducted by qualified personnel other than pilots for maintenance purposes.

The following conditions should be applied:

- (1) The operator should ensure that the qualification of personnel, other than pilots, who are authorised to conduct maintenance runs is described in the appropriate manual.
- (2) Ground runs should not include taxiing the helicopter.
- (3) There should be no passengers on board.
- (4) Maintenance runs should not include collective increase or auto pilot engagement (risk of ground resonance).

NCO.GEN.125 Portable electronic devices

Regulation (EU) 2018/1975

The pilot-in-command shall not permit any person to use a portable electronic device (PED) on board an aircraft, including an electronic flight bag (EFB), that could adversely affect the performance of the aircraft systems and equipment or the ability of the flight crew member to operate the aircraft.

AMC1 NCO.GEN.125 Portable electronic devices (PEDs)

ED Decision 2019/008/R

ELECTRONIC FLIGHT BAGS (EFBS) — HARDWARE

- (a) EFB viewable stowage

When a viewable stowage device is used, the pilot-in-command should ensure that, if the EFB moves or is separated from its stowage, or if the viewable stowage is unsecured from the

aircraft (as a result of turbulence, manoeuvring, or other action), it will not jam flight controls, damage flight deck equipment, or injure any person on board.

The viewable stowage device should not be positioned in such a way that it obstructs visual or physical access to aircraft controls and/or displays, flight crew ingress or egress, or external vision. The design of the viewable stowage device should allow the user easy access to any item of the EFB system, and notably to the EFB controls and a clear view of the EFB display while in use.

(b) Cables

If cables are used to connect an EFB to an aircraft system, power source, or any other equipment:

- (1) the cables should not hang loosely in a way that compromises task performance and safety; flight crew should be able to easily secure the cables out of the way during operations (e.g. by using cable tether straps); and
- (2) the cables should be of sufficient length so that they do not obstruct the use of any movable device on the flight deck.

AMC2 NCO.GEN.125 Portable electronic devices (PEDs)

ED Decision 2019/008/R

ELECTRONIC FLIGHT BAGS (EFBs) — FUNCTIONS

(a) Familiarisation

The pilot-in-command should familiarise himself or herself with the use of the EFB hardware and its applications on the ground before using them in flight for the first time.

A user guide should be available for the pilot-in-command.

(b) Check before flight

Before each flight, the pilot-in-command should perform the following checks to ensure the continued safe operation of the EFB during the flight:

- (1) general check of the EFB operation by switching it ON and checking that the applications they intend to use in flight are adequately operative;
- (2) check of the remaining available battery power, if applicable, to ensure the availability of the EFB during the planned flight;
- (3) check of the version effectivity of the EFB databases, if applicable (e.g. for charts, performance calculation and weight and balance applications); and
- (4) check that an appropriate backup is available when a chart application or an application displaying aircraft checklists is used.

(c) Chart applications

The navigation charts that are depicted should contain the necessary information in an appropriate format, to perform the operation safely. Consideration should be given to the size of the display to ensure legibility.

(d) Performance calculation and weight and balance functions or applications

Prior to the first use of a performance calculation or weight and balance function or application, and following any update of the database supporting the function or the application, a check

should be performed on the ground to verify that the output of the application corresponds with the data derived from the AFM (or other appropriate sources);

(e) Airport moving map display (AMMD) application

An AMMD application should not be used as a primary means of navigation for taxiing, but as a confirmation of outside visual references.

(f) Other functions

If advanced functions on non-certified devices that display information related to the aircraft position in flight, navigation, surroundings in terms of e.g. terrain or traffic, or attitude are used, the pilot in command should be aware of the potential misleading or erroneous information displayed and should only use these functions as an advisory or supplementary means.

GM1 NCO.GEN.125 Portable electronic devices

ED Decision 2014/031/R

DEFINITIONS

(a) Definition and categories of PEDs

PEDs are any kind of electronic device, typically but not limited to consumer electronics, brought on board the aircraft by crew members, passengers, or as part of the cargo and that are not included in the approved aircraft configuration. All equipment that is able to consume electrical energy falls under this definition. The electrical energy can be provided from internal sources as batteries (chargeable or non-rechargeable) or the devices may also be connected to specific aircraft power sources.

PEDs include the following two categories:

- (1) Non-intentional transmitters can non-intentionally radiate RF transmissions, sometimes referred to as spurious emissions. This category includes, but is not limited to, calculators, cameras, radio receivers, audio and video players, electronic games and toys; when these devices are not equipped with a transmitting function.
- (2) Intentional transmitters radiate RF transmissions on specific frequencies as part of their intended function. In addition, they may radiate non-intentional transmissions like any PED. The term 'transmitting PED' (T-PED) is used to identify the transmitting capability of the PED. Intentional transmitters are transmitting devices such as RF-based remote control equipment, which may include some toys, two-way radios (sometimes referred to as private mobile radio), mobile phones of any type, satellite phones, computers with mobile phone data connection, wireless local area network (WLAN) or Bluetooth capability. After deactivation of the transmitting capability, e.g. by activating the so-called 'flight mode' or 'flight safety mode', the T-PED remains a PED having non-intentional emissions.

(b) Definition of the switched-off status

Many PEDs are not completely disconnected from the internal power source when switched off. The switching function may leave some remaining functionality e.g. data storage, timer, clock, etc. These devices can be considered switched off when in the deactivated status. The same applies for devices having no transmitting capability and are operated by coin cells without further deactivation capability, e.g. wrist watches.

GM2 NCO.GEN.125 Portable electronic devices

ED Decision 2014/031/R

GENERAL

- (a) PEDs can pose a risk of interference with electronically operated aircraft systems. Those systems could range from the electronic engine control, instruments, navigation or communication equipment, autopilots to any other type of avionic equipment on the aircraft. The interference can result in on-board systems malfunctioning or providing misleading information and communication disturbance. These can also lead to an increased workload for the flight crew.
- (b) Interference may be caused by transmitters being part of the PED's functionality or by unintentional transmissions from the PED. Due to the likely proximity of the PED to any electronically operated aircraft system and the generally limited shielding found in small aircraft, the risk of interference is to be considered higher than that for larger aircraft with metal airframes.
- (c) During certification of the aircraft, when qualifying the aircraft functions consideration may only have been made of short-term exposure to a high radiating field, with an acceptable mitigating measure being a return to normal function after removal of the threat. This certification assumption may not be true when operating the transmitting PED on board the aircraft.
- (d) It has been found that compliance with the electromagnetic compatibility (EMC) Directive 2004/108/EC and related European standards, as indicated by the CE marking, is not sufficient to exclude the existence of interference. A well-known interference is the demodulation of the transmitted signal from GSM (global system for mobile communications) mobile phones leading to audio disturbances in other systems. Similar interferences are difficult to predict during the PED design and protecting the aircraft's electronic systems against the full range of potential interferences is practically impossible. Therefore, not operating PEDs on-board aircraft is the safest option, especially as effects may not be identified immediately but under the most inconvenient circumstances.
- (e) Guidance to follow in case of fire caused by PEDs is provided by the International Civil Aviation Organisation, 'Emergency response guidance for aircraft incidents involving dangerous goods', ICAO Doc 9481-AN/928.

NCO.GEN.130 Information on emergency and survival equipment carried

Regulation (EU) No 800/2013

Except for aircraft taking-off and landing at the same aerodrome/operating site, the operator shall, at all times, have available for immediate communication to rescue coordination centres (RCCs) lists containing information on the emergency and survival equipment carried on board.

AMC1 NCO.GEN.130 Information on emergency and survival equipment carried

ED Decision 2014/016/R

CONTENT OF INFORMATION

The information, compiled in a list, should include, as applicable:

- (a) the number, colour and type of life rafts and pyrotechnics,

- (b) details of emergency medical supplies and water supplies; and
- (c) the type and frequencies of the emergency portable radio equipment.

NCO.GEN.135 Documents, manuals and information to be carried

Regulation (EU) 2018/1975

- (a) The following documents, manuals and information shall be carried on each flight as originals or copies unless otherwise specified:
 - (1) the AFM, or equivalent document(s);
 - (2) the original certificate of registration;
 - (3) the original certificate of airworthiness (CofA);
 - (4) the noise certificate, if applicable;
 - (5) the list of specific approvals, if applicable;
 - (6) the aircraft radio licence, if applicable;
 - (7) the third party liability insurance certificate(s);
 - (8) the journey log, or equivalent, for the aircraft;
 - (9) details of the filed ATS flight plan, if applicable;
 - (10) current and suitable aeronautical charts for the route area of the proposed flight and all routes along which it is reasonable to expect that the flight may be diverted;
 - (11) procedures and visual signals information for use by intercepting and intercepted aircraft;
 - (12) the MEL or CDL, if applicable; and
 - (13) any other documentation that may be pertinent to the flight or is required by the States concerned with the flight.
- (b) Notwithstanding (a), on flights:
 - (1) intending to take off and land at the same aerodrome/operating site; or
 - (2) remaining within a distance or area determined by the competent authority,the documents and information in (a)(2) to (a)(8) may be retained at the aerodrome or operating site.
- (c) The pilot-in-command shall make available within a reasonable time of being requested to do so by the competent authority, the documentation required to be carried on board.

AMC1 NCO.GEN.135(a)(3) Documents, manuals and information to be carried

ED Decision 2014/016/R

CERTIFICATE OF AIRWORTHINESS

The certificate of airworthiness should be a normal certificate of airworthiness, a restricted certificate of airworthiness or a permit to fly issued in accordance with the applicable airworthiness requirements.

AMC1 NCO.GEN.135(a)(10) Documents, manuals and information to be carried

ED Decision 2014/016/R

CURRENT AND SUITABLE AERONAUTICAL CHARTS

- (a) The aeronautical charts carried should contain data appropriate to the applicable air traffic regulations, rules of the air, flight altitudes, area/route and nature of the operation. Due consideration should be given to carriage of textual and graphic representations of:
- (1) aeronautical data, including, as appropriate for the nature of the operation:
 - (i) airspace structure;
 - (ii) significant points, navigation aids (navaids) and air traffic services (ATS) routes;
 - (iii) navigation and communication frequencies;
 - (iv) prohibited, restricted and danger areas; and
 - (v) sites of other relevant activities that may hazard the flight; and
 - (2) topographical data, including terrain and obstacle data.
- (b) A combination of different charts and textual data may be used to provide adequate and current data.
- (c) The aeronautical data should be appropriate for the current aeronautical information regulation and control (AIRAC) cycle.
- (d) The topographical data should be reasonably recent, having regard to the nature of the planned operation.

GM1 NCO.GEN.135 Documents, manuals and information to be carried

ED Decision 2014/016/R

GENERAL

- (a) In case of loss or theft of documents specified in NCO.GEN.135, the operation may continue until the flight reaches the base or a place where a replacement document can be provided.
- (b) The documents, manuals and information may be available in a form other than on printed paper. An electronic storage medium is acceptable if accessibility, usability and reliability can be assured.

GM1 NCO.GEN.135(a)(1) Documents, manuals and information to be carried

ED Decision 2018/003/R

AFM OR EQUIVALENT DOCUMENT

‘Aircraft flight manual (AFM), or equivalent document’ means the flight manual for the aircraft or other documents containing information required for the operation of the aircraft within the terms of its certificate of airworthiness.

GM1 NCO.GEN.135(a)(8) Documents, manuals and information to be carried

ED Decision 2014/016/R

JOURNEY LOG OR EQUIVALENT

'Journey log or equivalent' means that the required information may be recorded in documentation other than a log book, such as the operational flight plan or the aircraft technical log.

GM1 NCO.GEN.135(a)(11) Documents, manuals and information to be carried

ED Decision 2014/016/R

PROCEDURES AND VISUAL SIGNALS FOR USE BY INTERCEPTING AND INTERCEPTED AIRCRAFT

The procedures and the visual signals information for use by intercepting and intercepted aircraft are those contained in the International Civil Aviation Organisation's (ICAO) Annex 2.

GM1 NCO.GEN.135(a)(13) Documents, manuals and information to be carried

ED Decision 2014/016/R

DOCUMENTS THAT MAY BE PERTINENT TO THE FLIGHT

Any other documents that may be pertinent to the flight or required by the States concerned with the flight may include, for example, forms to comply with reporting requirements.

STATES CONCERNED WITH THE FLIGHT

The States concerned are those of origin, transit, overflight and destination of the flight.

NCO.GEN.140 Transport of dangerous goods

Regulation (EU) 2016/1119

- (a) The transport of dangerous goods by air shall be conducted in accordance with Annex 18 to the Chicago Convention as last amended and amplified by the Technical Instructions for the Safe Transport of Dangerous Goods by Air (ICAO Doc 9284-AN/905), including its supplements and any other addenda or corrigenda.
- (b) Dangerous goods shall only be transported by the operator approved in accordance with Annex V (Part-SPA), Subpart G, to Regulation (EU) No 965/2012 except when:
 - (1) they are not subject to the Technical Instructions in accordance with Part 1 of those Instructions; or
 - (2) they are carried by passengers or the pilot-in-command, or are in baggage, in accordance with Part 8 of the Technical Instructions;
 - (3) they are carried by operators of ELA2 aircraft.
- (c) The pilot-in-command shall take all reasonable measures to prevent dangerous goods from being carried on board inadvertently.
- (d) The pilot-in-command shall, in accordance with the Technical Instructions, report without delay to the competent authority and the appropriate authority of the State of occurrence in the event of any dangerous goods accidents or incidents.

- (e) The pilot-in-command shall ensure that passengers are provided with information about dangerous goods in accordance with the Technical Instructions.
- (f) Reasonable quantities of articles and substances that would otherwise be classified as dangerous goods and that are used to facilitate flight safety, where carriage aboard the aircraft is advisable to ensure their timely availability for operational purposes, shall be considered authorised under paragraph 1;2.2.1(a) of the Technical Instructions. This is regardless of whether or not such articles and substances are required to be carried or intended to be used in connection with a particular flight.

The packing and loading on board of the above-mentioned articles and substances shall be performed, under the responsibility of the pilot in command, in such a way as to minimise the risks posed to crew members, passengers, cargo or the aircraft during aircraft operations.

GM1 NCO.GEN.140(a) Transport of dangerous goods

ED Decision 2014/016/R

GENERAL

- (a) The requirement to transport dangerous goods by air in accordance with the Technical Instructions is irrespective of whether:
 - (1) the flight is wholly or partly within or wholly outside the territory of a State; or
 - (2) an approval to carry dangerous goods in accordance with Annex V (Part-SPA), Subpart G is held.
- (b) The Technical Instructions provide that in certain circumstances dangerous goods, which are normally forbidden on an aircraft, may be carried. These circumstances include cases of extreme urgency or when other forms of transport are inappropriate or when full compliance with the prescribed requirements is contrary to the public interest. In these circumstances all the States concerned may grant exemptions from the provisions of the Technical Instructions provided that an overall level of safety that is at least equivalent to that provided by the Technical Instructions is achieved. Although exemptions are most likely to be granted for the carriage of dangerous goods that are not permitted in normal circumstances, they may also be granted in other circumstances, such as when the packaging to be used is not provided for by the appropriate packing method or the quantity in the packaging is greater than that permitted. The Technical Instructions also make provision for some dangerous goods to be carried when an approval has been granted only by the State of origin and the competent authority.
- (c) When an exemption is required, the States concerned are those of origin, transit, overflight and destination of the consignment and that of the operator. For the State of overflight, if none of the criteria for granting an exemption are relevant, an exemption may be granted based solely on whether it is believed that an equivalent level of safety in air transport has been achieved.
- (d) The Technical Instructions provide that exemptions and approvals are granted by the 'appropriate national authority', which is intended to be the authority responsible for the particular aspect against which the exemption or approval is being sought. The operator should ensure that all relevant conditions on an exemption or approval are met.
- (e) The exemption or approval referred to in (b) to (d) is in addition to the approval required by Annex V (Part-SPA), Subpart G.

AMC1 NCO.GEN.140(d) Transport of dangerous goods

ED Decision 2014/016/R

DANGEROUS GOODS ACCIDENT AND INCIDENT REPORTING

- (a) Any type of dangerous goods incident or accident, or the finding of:
- (1) undeclared or misdeclared dangerous goods in cargo;
 - (2) forbidden dangerous goods in mail; or
 - (3) forbidden dangerous goods in passenger or crew baggage, or on the person of a passenger or crew member
- should be reported. For this purpose, the Technical Instructions consider that reporting of undeclared and misdeclared dangerous goods found in cargo also applies to items of operators' stores that are classified as dangerous goods.
- (b) The first report should be dispatched within 72 hours of the event. It may be sent by any means, including e-mail, telephone or fax. This report should include the details that are known at that time, under the headings identified in 3. If necessary, a subsequent report should be made as soon as possible giving all the details that were not known at the time the first report was sent. If a report has been made verbally, written confirmation should be sent as soon as possible.
- (c) The first and any subsequent report should be as precise as possible and contain the following data, where relevant:
- (1) date of the incident or accident or the finding of undeclared or misdeclared dangerous goods;
 - (2) location and date of flight;
 - (3) description of the goods;
 - (4) proper shipping name (including the technical name, if appropriate) and United Nations (UN)/identification (ID) number, when known;
 - (5) class or division and any subsidiary risk;
 - (6) type of packaging, and the packaging specification marking on it;
 - (7) quantity;
 - (8) name and address of the passenger, etc.;
 - (9) any other relevant details;
 - (10) suspected cause of the incident or accident;
 - (11) action taken;
 - (12) any other reporting action taken; and
 - (13) name, title, address and telephone number of the person making the report.
- (d) Copies of relevant documents and any photographs taken should be attached to the report.
- (e) A dangerous goods accident or incident may also constitute an aircraft accident, serious incident or incident. The criteria for reporting both types of occurrence should be met.
- (f) The following dangerous goods reporting form should be used, but other forms, including electronic transfer of data, may be used provided that at least the minimum information of this AMC is supplied:

DANGEROUS GOODS OCCURRENCE REPORT			DGOR No:
1. Operator:	2. Date of Occurrence:	3. Local time of occurrence:	
4. Flight date:			
5. Departure aerodrome:		6. Destination aerodrome:	
7. Aircraft type:		8. Aircraft registration:	
9. Location of occurrence:		10. Origin of the goods:	
11. Description of the occurrence, including details of injury, damage, etc. (if necessary continue on the reverse of this form)			
12. Proper shipping name (including the technical name):			13. UN/ID No (when known):
14. Class/Division (when known):	15. Subsidiary risk(s):	16. Packing group:	17. Category (Class 7 only):
18. Type of packaging:	19. Packaging specification marking:	20. No of packages:	21. Quantity (or transport index, if applicable):
22. Name and address of passenger, etc.:			
23. Other relevant information (including suspected cause, any action taken):			
24. Name and title of person making report:		25. Telephone No:	
26. Company:		27. Reporters ref:	
28. Address:		29. Signature:	
		30. Date:	
Description of the occurrence (continuation)			

Notes for completion of the form:

1. A dangerous goods accident is as defined in Annex I. For this purpose serious injury is as defined in Regulation (EU) No 996/2010 of the European Parliament and of the Council¹.
2. The initial report should be dispatched unless exceptional circumstances prevent this. This occurrence report form, duly completed, should be sent as soon as possible, even if all the information is not available.
3. Copies of all relevant documents and any photographs should be attached to this report.
4. Any further information, or any information not included in the initial report, should be sent as soon as possible to the authorities identified in NCO.GEN.140(d).
5. Providing it is safe to do so, all dangerous goods, packaging, documents, etc. relating to the occurrence should be retained until after the initial report has been sent to the authorities identified in NCO.GEN.140(d), and they have indicated whether or not these should continue to be retained.

AMC1 NCO.GEN.140(f) Transport of dangerous goods

ED Decision 2016/018/R

GENERAL

The quantities of DG carried for operational purposes should be reasonable considering the purposes for which they might be required before the aircraft is able to replenish its supplies, e.g. at its home base or, in the case of a long tour, at any aerodrome along the route where the aircraft is planned to land and where such supplies are available.

GM1 NCO.GEN.140(f) Transport of dangerous goods

ED Decision 2016/018/R

GENERAL

In addition to items authorised under paragraph 1;2.2.1(a) of the Technical Instructions, the articles and substances should be items such as, e.g. aircraft spare parts, components/substances needed for aircraft repair, oil (for aircraft engine/gearbox), aircraft fuel, de-icing fluid, aircraft battery, and air starter unit.

NCO.GEN.145 Immediate reaction to a safety problem

Regulation (EU) No 800/2013

The operator shall implement:

- (a) any safety measures mandated by the competent authority in accordance with [ARO.GEN.135\(c\)](#); and
- (b) any relevant mandatory safety information issued by the Agency, including airworthiness directives.

¹ OJ L 295, 12.11.2010, p. 35.

NCO.GEN.150 Journey log

Regulation (EU) No 800/2013

Particulars of the aircraft, its crew and each journey shall be retained for each flight, or series of flights, in the form of a journey log, or equivalent.

AMC1 NCO.GEN.150 Journey log

ED Decision 2014/016/R

GENERAL

- (a) The aircraft journey log, or equivalent, should include the following items, where applicable:
- (1) aircraft nationality and registration;
 - (2) date;
 - (3) name of crew member(s);
 - (4) duty assignments of crew members, if applicable;
 - (5) place of departure;
 - (6) place of arrival;
 - (7) time of departure;
 - (8) time of arrival;
 - (9) hours of flight;
 - (10) nature of flight;
 - (11) incidents and observations (if any); and
 - (12) signature of the pilot-in-command.
- (b) The information or parts thereof may be recorded in a form other than on printed paper. Accessibility, usability and reliability should be assured.

NCO.GEN.155 Minimum equipment list

Regulation (EU) No 800/2013

- (a) An MEL may be established taking into account the following:
- (1) the document shall provide for the operation of the aircraft, under specified conditions, with particular instruments, items of equipment or functions inoperative at the commencement of the flight;
 - (2) the document shall be prepared for each individual aircraft, taking account of the operator's relevant operational and maintenance conditions; and
 - (3) the MEL shall be based on the relevant Master Minimum Equipment List (MMEL), as defined in the data established in accordance with Commission Regulation (EU) No 748/2012¹, and shall not be less restrictive than the MMEL.
- (b) The MEL and any amendment thereto shall be notified to the competent authority.

¹ OJ L 224, 21.8.2012, p. 1.

AMC1 NCO.GEN.155 Minimum equipment list

ED Decision 2015/004/R

CONTENT AND APPROVAL OF THE MEL

- (a) When an MEL is established, the operator should amend the MEL after any applicable change to the MMEL within the acceptable timescales. The following are applicable changes to the MMEL that require amendment of the MEL:
- (1) a reduction of the rectification interval;
 - (2) change of an item, only when the change is applicable to the aircraft or type of operations and is more restrictive;
 - (3) reduced timescales for the implementation of safety-related amendments may be required by the Agency and/or the competent authority.
- (b) An acceptable timescale for notifying the amended MEL to the competent authority is 90 days from the effective date specified in the approved change to the MMEL.
- (c) In addition to the list of items and related dispatch conditions, the MEL should contain:
- (1) a preamble, including guidance and definitions for flight crew members and maintenance personnel using the MEL. The MEL preamble should:
 - (i) reflect the content of the MMEL preamble as applicable to the MEL scope and extent;
 - (ii) contain terms and definitions used in the MEL;
 - (iii) contain any other relevant specific information for the MEL scope and use that is not originally provided in the MMEL;
 - (iv) provide guidance on how to identify the origin of a failure or malfunction to the extent necessary for appropriate application of the MEL;
 - (v) provide guidance on the management of multiple unserviceabilities, based on the guidance given in the MMEL; and
 - (vi) provide guidance on placarding of inoperative items to inform crew members of equipment condition as appropriate. In particular, when such items are accessible to the crew during flight, the control(s) and indicator(s) related to inoperative unit(s) should be clearly placarded.
 - (2) the revision status of the MMEL upon which the MEL is based and the revision status of the MEL;
 - (3) the scope, extent and purpose of the MEL;
 - (4) operational and maintenance procedures as part of the MEL or by means of reference to another appropriate document, based on the operational and maintenance procedures referenced in the MMEL; and
 - (5) the dispatch conditions associated with flights conducted in accordance with special approvals held by the operator in accordance with Part-SPA.
- (d) The operator should:
- (1) establish rectification intervals for each inoperative instrument, item of equipment or function listed in the MEL. The rectification interval in the MEL should not be less restrictive than the corresponding rectification interval in the MMEL. The definitions and

categories of rectification intervals are provided in CS-MMEL as well as in CS-GEN-MMEL; and

- (2) establish an effective rectification programme.
- (e) The operator should establish the operational and maintenance procedures referenced in the MEL, taking into account the operational and maintenance procedures referenced in the MMEL. These procedures should be part of the operator's manuals or the MEL.
- (f) The operator should amend the operational and maintenance procedures referenced in the MEL after any applicable change to the operational and maintenance procedures referenced in the MMEL.
- (g) Unless otherwise specified in the MEL, the operator should complete:
 - (1) the operational procedures referenced in the MEL when planning for and/or operating with the listed item inoperative; and
 - (2) the maintenance procedures referenced in the MEL prior to operating with the listed item inoperative.

AMC2 NCO.GEN.155 Minimum equipment list

ED Decision 2014/016/R

FORMAT OF THE MEL

The MEL format, the presentation of MEL items and dispatch conditions should:

- (a) reflect those of the MMEL;
- (b) follow the ATA 100/2200 Specification numbering system for MEL items; and
- (c) when different from (a) and (b), be clear and unambiguous.

AMC3 NCO.GEN.155 Minimum equipment list

ED Decision 2014/016/R

EXTENT OF THE MEL

The operator should include guidance in the MEL on how to deal with any failures that occur between the commencement of the flight and the start of the take-off. If a failure occurs between the commencement of the flight and the start of the take-off, any decision to continue the flight should be subject to pilot judgement and good airmanship. The pilot-in-command may refer to the MEL before any decision to continue the flight is taken.

AMC4 NCO.GEN.155 Minimum equipment list

ED Decision 2014/016/R

OPERATIONAL AND MAINTENANCE PROCEDURES

- (a) The operational and maintenance procedures referenced in the MEL should be based on the operational and maintenance procedures referenced in the MMEL. Modified procedures may, however, be developed by the operator when they provide the same level of safety as required by the MMEL. Modified maintenance procedures should be developed in accordance with the applicable airworthiness requirements.
- (b) Providing appropriate operational and maintenance procedures referenced in the MEL, regardless of who developed them, is the responsibility of the operator.

- (c) Any item in the MEL requiring an operational or maintenance procedure to ensure an acceptable level of safety should be so identified in the 'remarks' or 'exceptions' column/part/section of the MEL. This will normally be '(O)' for an operational procedure, or '(M)' for a maintenance procedure. '(O)(M)' means both operational and maintenance procedures are required.
- (d) The satisfactory accomplishment of all procedures, regardless of who performs them, is the responsibility of the operator.

AMC5 NCO.GEN.155 Minimum equipment list

ED Decision 2014/016/R

OPERATIONAL AND MAINTENANCE PROCEDURES — APPLICABLE CHANGES

- (a) Changes to the operational and maintenance procedures referenced in the MMEL are considered applicable and require the amendment of the maintenance and operating procedures referenced in the MEL when:
 - (1) the modified procedure is applicable to the operator's MEL; and
 - (2) the purpose of this change is to improve compliance with the intent of the associated MMEL dispatch condition.
- (b) An acceptable timescale for the amendments of maintenance and operating procedures, as defined in (a), should be 90 days from the date when the amended procedures referenced in the MMEL are made available. Reduced timescales for the implementation of safety-related amendments may be required if the competent authority consider it necessary.

GM1 NCO.GEN.155 Minimum equipment list

ED Decision 2014/016/R

GENERAL

- (a) The Minimum Equipment List (MEL) is a document that lists the equipment that may be temporarily inoperative, subject to certain conditions, at the commencement of flight. This document is prepared by the operator for their own particular aircraft, taking account of their aircraft configuration and all those individual variables that cannot be addressed at MMEL level, such as operating environment, route structure, geographic location, aerodromes where spare parts and maintenance capabilities are available, etc.
- (b) The MMEL, as defined in the mandatory part of the operational suitability data established in accordance with Regulation (EU) No 748/2012, is developed in compliance with CS-MMEL or CS-GEN-MMEL. These Certification Specifications contain, among other, guidance intended to standardise the level of relief granted in MMELs, in particular for items that are subject to operational requirements. If an MMEL established as part of the operational suitability data is not available and items subject to operational requirements are listed in the available MMEL without specific relief or dispatch conditions but only with a reference to the operational requirements, the operator may refer to CS-MMEL or CS-GEN-MMEL guidance material, as applicable, to develop the relevant MEL content for such items.

GM2 NCO.GEN.155 Minimum equipment list

ED Decision 2014/016/R

SCOPE OF THE MEL

- (a) Examples of special approvals in accordance with Part-SPA may be:
 - (1) RVSM
 - (2) LVO
- (b) When an aircraft has installed equipment which is not required for the operations conducted, the operator may wish to delay rectification of such items for an indefinite period. Such cases are considered to be out of the scope of the MEL, therefore modification of the aircraft is appropriate and deactivation, inhibition or removal of the item should be accomplished by an appropriate approved modification procedure.

GM3 NCO.GEN.155 Minimum equipment list

ED Decision 2014/016/R

PURPOSE OF THE MEL

The MEL is an alleviating document having the purpose to identify the minimum equipment and conditions to operate safely an aircraft having inoperative equipment. Its purpose is not, however, to encourage the operation of aircraft with inoperative equipment. It is undesirable for aircraft to be dispatched with inoperative equipment and such operations are permitted only as a result of careful analysis of each item to ensure that the acceptable level of safety, as intended in the applicable airworthiness and operational requirements, is maintained. The continued operation of an aircraft in this condition should be minimised.

GM4 NCO.GEN.155 Minimum equipment list

ED Decision 2014/016/R

OPERATIONAL AND MAINTENANCE PROCEDURES

- (a) Operational and maintenance procedures are an integral part of the compensating conditions needed to maintain an acceptable level of safety, enabling the competent authority to approve the MEL.
- (b) Normally, operational procedures are accomplished by the flight crew; however, other personnel may be qualified and authorised to perform certain functions.
- (c) Normally, maintenance procedures are accomplished by the maintenance personnel; however, other personnel may be qualified and authorised to perform certain functions in accordance with the applicable airworthiness requirements.
- (d) Operational and maintenance procedures, regardless of the document where they are contained, should be readily available for use when needed for the application of the MEL.
- (e) Unless specifically permitted by a maintenance procedure, an inoperative item may not be removed from the aircraft.

SUBPART B: OPERATIONAL PROCEDURES

NCO.OP.100 Use of aerodromes and operating sites

Regulation (EU) No 800/2013

The pilot-in-command shall only use aerodromes and operating sites that are adequate for the type of aircraft and operation concerned.

NCO.OP.101 Altimeter check and settings

Regulation (EU) 2021/2237

- (a) The pilot-in-command shall check the proper operation of the altimeter before each departure.
- (b) The pilot-in-command shall use appropriate altimeter settings for all phases of flight, taking into account any procedure prescribed by the State of the aerodrome or the State of the airspace.

AMC1 NCO.OP.101(a) Altimeter check and settings

ED Decision 2022/012/R

PRE-FLIGHT ALTIMETER CHECK

A serviceable altimeter indicates the elevation of the point selected, plus the height of the altimeter above this point, within a tolerance of ± 60 ft.

If the altimeter does not indicate the reference elevation or height exactly but is within the specified tolerances, no adjustment of this indication should be made at any stage of a flight. Also, any error which is within tolerance on the ground should be ignored by the pilot during flight.

If no altimeter setting is available at the aerodrome or operating site of departure, the altimeter should be set using the elevation of the aerodrome or operating site, and the altimeter setting should be verified on first contact with an ATS unit.

NCO.OP.105

INTENTIONALLY LEFT BLANK

NCO.OP.110 Aerodrome operating minima — aeroplanes and helicopters

Regulation (EU) 2021/2237

- (a) For instrument flight rules (IFR) flights, the pilot-in-command shall establish aerodrome operating minima for each departure, destination or alternate aerodrome that is planned to be used in order to ensure separation of the aircraft from terrain and obstacles and to mitigate the risk of loss of visual references during the visual flight segment of instrument approach operations.
- (b) The aerodrome operating minima shall take the following elements into account, if relevant:
 - (1) the type, performance, and handling characteristics of the aircraft;
 - (2) the equipment available on the aircraft for the purpose of navigation, acquisition of visual references, and/or control of the flight path during take-off, approach, landing, and missed approach;

- (3) any conditions or limitations stated in the aircraft flight manual (AFM);
- (4) the dimensions and characteristics of the runways/final approach and take-off areas (FATOs) that may be selected for use;
- (5) the adequacy and performance of the available visual and non-visual aids and infrastructure;
- (6) the obstacle clearance altitude/height (OCA/H) for the instrument approach procedures (IAPs), if established;
- (7) the obstacles in the climb-out areas and clearance margins;
- (8) the competence and relevant operational experience of the pilot-in-command;
- (9) the IAP, if established;
- (10) the aerodrome characteristics and the type of air navigation services (ANS) available, if any;
- (11) any minima that may be promulgated by the State of the aerodrome;
- (12) the conditions prescribed in any specific approvals for low-visibility operations (LVOs) or operations with operational credits.

AMC1 NCO.OP.110 Aerodrome operating minima — aeroplanes and helicopters

ED Decision 2022/012/R

TAKE-OFF OPERATIONS

(a) General

Take-off minima should be expressed as visibility (VIS) or runway visual range (RVR) limits, taking into account all relevant factors for each runway/final approach and take-off area (FATO)/operating site planned to be used and aircraft characteristics and equipment. Where there is a specific need to see and avoid obstacles on departure and/or for a forced landing, additional conditions, e.g. ceiling, it should be specified.

(b) Visual reference

- (1) The take-off minima should be selected to ensure sufficient guidance to control the aircraft in the event of both a rejected take-off in adverse circumstances and an engine failure after rotation.
- (2) For night operations, sufficient lighting should be in operation to illuminate the runway/final approach and take-off area (FATO) and any relevant obstacles.
- (3) For point-in-space (PinS) departures to an initial departure fix (IDF), the take-off minima should be selected to ensure sufficient guidance to see and avoid obstacles and return to the heliport if the flight cannot be continued visually to the IDF. The minimum VIS should be 800 m and the minimum ceiling should be 250 ft.
- (4) For helicopters outside of a runway environment, the minimum VIS should be 800 m, and for offshore helideck operations, the minimum VIS should be 500 m.

AMC2 NCO.OP.110 Aerodrome operating minima — aeroplanes and helicopters

ED Decision 2022/012/R

RVR OR VIS FOR INSTRUMENT APPROACH OPERATIONS — DETERMINATION OF DH/MDH FOR INSTRUMENT APPROACH OPERATIONS — AEROPLANES

- (a) The RVR (or for non-instrument runways, VIS) for straight-in instrument approach operations should not be less than the greatest of the following:
 - (1) the minimum RVR (or for non-instrument runways, VIS) for the type of runway used according to Table 1;
 - (2) the minimum RVR determined according to the MDH or DH and class of lighting facility according to Table 2;
 - (3) the minimum RVR according to the visual and non-visual aids and on-board equipment used according to Table 3.
- (b) For Category A and B aeroplanes, if the RVR determined in accordance with (a) is greater than 1 500 m, then 1 500 m should be used.
- (d) The visual aids, if available, may comprise standard runway day markings, runway edge lights, threshold lights, runway end lights and approach lights as defined in Table 6.
- (e) For night operations or for any operation where credit for visual aids is required, the lights should be on and serviceable except as provided for in [GM5 NCO.OP.110](#).

Table 1

Type of runway versus minimum RVR or VIS — aeroplanes

Type of runway	Minimum RVR or VIS (m)
Precision approach (PA) runway, category I	550
Non-precision approach (NPA) runway	750
Non-instrument runway	Visibility according to Table 1 in NCO.OP.112 (Circling minima)

Table 2

RVR versus DH/MDH

DH or MDH			Class of lighting facility			
			FALS	IALS	BALS	NALS
ft			RVR (m)			
200	-	210	550	750	1 000	1 200
211	-	240	550	800	1 000	1 200
241	-	250	550	800	1 000	1 300
251	-	260	600	800	1 100	1 300
261	-	280	600	900	1 100	1 300
281	-	300	650	900	1 200	1 400
301	-	320	700	1 000	1 200	1 400
321	-	340	800	1 100	1 300	1 500
341	-	360	900	1 200	1 400	1 600
361	-	380	1 000	1 300	1 500	1 700
381	-	400	1 100	1 400	1 600	1 800

401	-	420	1 200	1 500	1 700	1 900
421	-	440	1 300	1 600	1 800	2 000
441	-	460	1 400	1 700	1 900	2 100
461	-	480	1 500	1 800	2 000	2 200
481		500	1 500	1 800	2 100	2 300
501	-	520	1 600	1 900	2 100	2 400
521	-	540	1 700	2 000	2 200	2 400
541	-	560	1 800	2 100	2 300	2 400
561	-	580	1 900	2 200	2 400	2 400
581	-	600	2 000	2 300	2 400	2 400
601	-	620	2 100	2 400	2 400	2 400
621	-	640	2 200	2 400	2 400	2 400
641		660	2 300	2 400	2 400	2 400
661		and above	2 400	2 400	2 400	2 400

Table 3
Visual and non-visual aids and/or on-board equipment versus minimum RVR — aeroplanes

Type of approach	Facilities	Lowest RVR (m)
PA and APV procedure	RTZL and RCLL	[no limitation]
	without RTZL and RCLL but using HUDLS or equivalent system; coupled autopilot or flight director to DH	[no limitation]
	No RTZL and RCLL, not using HUDLS or equivalent system or autopilot to DH.	750
NPA procedure	Final approach track offset <15° for category A and B aeroplanes or <5° Category C and D aeroplanes	750
	Final approach track offset ≥ 15° for category A or B aeroplanes	1 000
	Final approach track offset ≥ 5° for category C or D aeroplanes	1 200

DETERMINATION OF RVR FOR INSTRUMENT APPROACH OPERATIONS — HELICOPTERS

- (a) For IFR operations, the RVR should not be less than the greatest of the following:
- (1) the minimum RVR for the type of runway/FATO used according to Table 4; or
 - (2) the minimum RVR determined according to the MDH or DH and class of lighting facility according to Table 5;
 - (3) for PinS operations with instructions to ‘proceed visually’, the distance between the MAPt of the PinS and the FATO/approach light system.
- (b) For PinS operations with instructions to ‘proceed VFR’, the VIS should be compatible with visual flight rules.
- (c) The visual aids, if available, may comprise standard runway day markings, runway edge lights, threshold lights, runway, end lights and approach lights as defined in Table 6 of [AMC3 NCO.OP.110](#).
- (d) For night operations or for any operation where credit for visual aids is required, the lights should be on and serviceable.

Table 4

Type of runway/FATO versus minimum RVR — helicopters

Type of runway/FATO	Minimum RVR or VIS (m)
PA runway, category I NPA runway Non-instrument runway	RVR 550
Instrument FATO FATO	RVR 550 RVR or VIS 800

Table 5

DH/MDH versus minimum RVR — helicopters

DH/MDH (ft)	Facilities versus RVR (m)*			
	FALS	IALS	BALS	NALS
200	550	600	700	1 000
201–249	550	650	750	1 000
250–299	600*	700*	800	1 000
300 and above	750*	800	900	1 000

* Minima on 2D approach operations should be no lower than 800 m.

APPROACH LIGHTING SYSTEMS — AEROPLANES AND HELICOPTERS

Table 6

Approach lighting systems

Class of lighting facility	Length, configuration and intensity of approach lights
FALS	CAT I lighting system (HIALS ≥ 720 m) distance coded centre line, barrette centre line
IALS	Simple approach lighting system (HIALS 420–719 m) single source, barrette
BALS	Any other approach lighting system (HIALS, MALS or ALS 210–419 m)
NALS	Any other approach lighting system (HIALS, MALS or ALS < 210 m) or no approach lights

AMC3 NCO.OP.110 Aerodrome operating minima — aeroplanes and helicopters

ED Decision 2022/012/R

VISUAL APPROACH

For a visual approach operation, the RVR should not be less than 800 m.

GM1 NCO.OP.110 Aerodrome operating minima — aeroplanes and helicopters

ED Decision 2022/012/R

AIRCRAFT CATEGORIES

- (a) Aircraft categories should be based on the indicated airspeed at threshold (V_{AT}), which is equal to the stalling speed (V_{SO}) multiplied by 1.3 or where published 1-g (gravity) stall speed (V_{S1g}) multiplied by 1.23 in the landing configuration at the maximum certified landing mass. If both V_{SO} and V_{S1g} are available, the higher resulting V_{AT} should be used.
- (b) The aircraft categories specified in the Table 6 should be used.

Table 7: Aircraft categories corresponding to V_{AT} values

Aircraft category	V_{AT}
A	Less than 91 kt
B	from 91 to 120 kt
C	from 121 to 140 kt
D	from 141 to 165 kt
E	from 166 to 210 kt

- (c) Helicopters are also eligible for Category H where applicable.

GM2 NCO.OP.110 Aerodrome operating minima — aeroplanes and helicopters

ED Decision 2022/012/R

FLIGHTS WITH VFR AND IFR SEGMENTS

Where a flight contains VFR and IFR segments, aerodrome operating minima need be established only as far as relevant to the IFR segments. Attention is drawn to [NCO.OP.160 \(a\) and \(c\)](#), according to which, the pilot-in-command shall be satisfied that the VFR segments will be conducted in conditions at or above the applicable VFR operating minima. For example, for a VFR departure changing to IFR at a transition point en-route and an IFR arrival at destination, the pilot-in-command should be satisfied that VMC will exist up to the transition point, and aerodrome operating minima should be established for the destination and any alternate destinations required.

GM3 NCO.OP.110 Aerodrome operating minima — aeroplanes and helicopters

ED Decision 2022/012/R

MEANS TO DETERMINE THE REQUIRED RVR BASED ON DH AND LIGHTING FACILITIES

- (a) The values in Table 2 are derived from the formula below:

$$RVR (m) = [(DH/MDH (ft) \times 0.3048) / \tan \alpha] - \text{length of approach lights (m)},$$
 where α is the calculation angle, being a default value of 3.00° increasing in steps of 0.10° for each line in Table 2 up to 3.77° and then remaining constant. An upper RVR limit of 2 400 m has been applied to the table.
- (b) The lighting system classes in Table 2 have the meaning specified in Table 6.

GM4 NCO.OP.110 Aerodrome operating minima — aeroplanes and helicopters

ED Decision 2022/012/R

USE OF THIRD-PARTY INFORMATION

If a pilot-in-command uses information provided by a third party for aerodrome operating minima, the pilot-in-command verifies that the method for calculating minima is in accordance with this Regulation.

GM5 NCO.OP.110 Aerodrome operating minima — aeroplanes and helicopters

ED Decision 2022/012/R

EFFECT OF TEMPORARILY FAILED OR DOWNGRADED GROUND EQUIPMENT ON LANDING MINIMA

- (a) Lighting in Table 5 should be considered only if the relevant lighting is operating. For example, if components of a FALS have failed leaving only the last 250 m operating normally, the lighting facilities should be treated as BALS.
- (b) Failures of standby equipment, standby power systems, middle markers and RVR assessment systems have no effect on minima.

GM1 NCO.OP.110(b)(5) Aerodrome operating minima — aeroplanes and helicopters

ED Decision 2022/012/R

VISUAL AND NON-VISUAL AIDS AND INFRASTRUCTURE

‘Visual and non-visual aids and infrastructure’ refers to all equipment and facilities required for the procedure to be used for the intended instrument approach operation. This includes but is not limited to, lights, markings, ground or space-based radio aids, etc.

NCO.OP.111 Aerodrome operating minima — 2D and 3D approach operations

Regulation (EU) 2021/2237

- (a) The decision height (DH) to be used for a 3D approach operation or a 2D approach operation flown with the continuous descent final approach (CDFA) technique shall not be lower than the highest of:
 - (1) the obstacle clearance height (OCH) for the category of aircraft;
 - (2) the published approach procedure DH or minimum descent height (MDH), where applicable;
 - (3) the system minimum specified in Table 1;
 - (4) the minimum DH specified in the AFM or equivalent document, if stated.
- (b) The MDH for a 2D approach operation flown without the CDFA technique shall not be lower than the highest of:
 - (1) the OCH for the category of aircraft;

- (2) the published approach procedure MDH, where applicable;
- (3) the system minimum specified in Table 1; or
- (4) the minimum MDH specified in the AFM, if stated.

Table 1
System minima

Facility	Lowest DH/MDH (ft)
ILS/MLS/ GLS	200
GNSS/SBAS (LPV)	200
Precision approach radar (PAR)	200
GNSS/SBAS (LP)	250
GNSS (LNAV)	250
GNSS/Baro-VNAV (LNAV/VNAV)	250
Helicopter point-in-space approach	250
LOC with or without DME	250
SRA (terminating at ½ NM)	250
SRA (terminating at 1 NM)	300
SRA (terminating at 2 NM or more)	350
VOR	300
VOR/DME	250
NDB	350
NDB/DME	300
VDF	350

AMC1 NCO.OP.111 Aerodrome operating minima — 2D and 3D approach operations

ED Decision 2022/012/R

DETERMINATION OF DH/MDH FOR INSTRUMENT APPROACH OPERATIONS AND RUNWAY

When determining the DH/MDH in accordance with the obstacle clearance height (OCH) for the category of aircraft and the published approach procedure DH or minimum descent height (MDH), the pilot should determine whether the obstacle limitation surface is appropriate for the type of instrument approach flown and runway as this matter may have an impact on the calculation of the OCH and DH/MDH. When this information is not available (e.g. not mentioned in the AIP, etc.), then the pilot should take into account Table 8 or 9 below, as applicable, when determining the DH/MDH:

Table 8

Runway type minima — aeroplanes

Runway type	Lowest DH/MDH (ft)
PA runway, category I	200
NPA runway	250
Non-instrument runway	Circling minima as shown in Table 1 in NCC.OP.112

Table 9
Type of runway/FATO minima — helicopters

Type of runway/FATO	Lowest DH/MDH (ft)
PA runway, category I NPA runway Non-instrument runway	200
Instrument FATO FATO	200 250

Table 8 does not apply to helicopter PinS approaches with instructions to ‘proceed VFR’.

GM1 NCO.OP.111 Aerodrome operating minima — 2D and 3D approach operations

ED Decision 2022/012/R
APPROACH OPERATIONS — VERTICAL PATH CONTROL FOR NPA

- (a) During a 3D instrument approach operation (using both lateral and vertical navigation guidance), the displayed vertical path should be followed continuously. The approach may be continued to DA/H, at which point a missed approach must be initiated if visual reference is not acquired.
- (b) During a 2D instrument approach operation (using lateral navigation guidance only) flown using the continuous descent final approach (CDFA) technique, the vertical path should be approximated continuously by:
 - (1) choosing an appropriate vertical speed;
 - (2) cross-checking level against position along the approach; and
 - (3) adapting the vertical speed as required.

The approach may be continued to DA/H or the missed approach point (MAPt) (whichever is reached first), at which point a missed approach must be initiated if visual reference is not acquired. There is no MDH for an NPA flown using the CDFA technique. An aircraft may descend briefly below the DH on an NPA flown using the CDFA technique, in the same way as it may on a PA or APV.

- (c) During a 2D instrument approach operation (using lateral navigation guidance only) flown using the step-down (non-CDFA) technique, the vertical path consists of a sequence of one or more descents to the next published level (i.e. the MDA/H or height at the next stepdown fix). The aircraft may fly level at the MDA/H until reaching the MAPt, where a missed approach must be initiated if visual reference is not acquired.

The CDFA technique has substantially improved safety performance in commercial air transport operations with complex motor-powered aircraft. In lighter, more manoeuvrable aircraft, operated by a single pilot, which may be accustomed to shorter and steeper visual approaches, there may sometimes be advantages to a step-down technique. Due consideration should be given to the choice of vertical path control at the planning stage of flight.

GM2 NCO.OP.111 Aerodrome operating minima — 2D and 3D approach operations

ED Decision 2022/012/R

DH/MDH — CALCULATION OF DA/MDA

[NCO.OP.111](#) refers to DH and MDH because the rule compares heights with other heights (system minima, minimum DH in the AFM, etc.). Usually, the DH or MDH will be converted to DA or MDA for operational use by adding the threshold elevation.

GM3 NCO.OP.111 Aerodrome operating minima — 2D and 3D approach operations

ED Decision 2022/012/R

DH/MDH — PinS APPROACHES WITH VIRTUAL DESTINATION

For PinS approaches with instructions to ‘proceed VFR’ that are not associated with a runway/FATO/operating site, DH/MDH can be established with reference to the ground below the MAPt.

NCO.OP.112 Aerodrome operating minima — circling operations with aeroplanes

Regulation (EU) 2021/2237

- (a) The MDH for a circling approach operation with aeroplanes shall not be lower than the highest of:
- (1) the published circling OCH for the aeroplane category;
 - (2) the minimum circling height derived from Table 1; or
 - (3) the DH/MDH of the preceding IAP.
- (b) The minimum visibility for a circling approach operation with aeroplanes shall be the highest of:
- (1) the circling visibility for the aeroplane category, if published; or
 - (2) the minimum visibility derived from Table 1.

Table 1
MDH and minimum visibility for circling per aeroplane category

	Aeroplane category			
	A	B	C	D
MDH (ft)	400	500	600	700
Minimum VIS (m)	1 500	1 500	2 400	3 600

GM1 NCO.OP.112 Aerodrome operating minima — circling operations with aeroplanes

ED Decision 2022/012/R

SUPPLEMENTAL INFORMATION

- (a) The purpose of this Guidance Material is to provide pilots with supplemental information regarding the application of aerodrome operating minima in relation to circling approaches.
- (b) Conduct of flight — general:
 - (1) the MDH and obstacle clearance height (OCH) included in the procedure are referenced to aerodrome elevation;
 - (2) the MDA is referenced to mean sea level; and
 - (3) for these procedures, the applicable visibility is the flight visibility.
- (c) Instrument approach followed by visual manoeuvring (circling) without prescribed tracks:
 - (1) When the aeroplane is on the initial instrument approach, before visual reference is established, but not below MDA/H — the aeroplane should follow the corresponding instrument approach procedure (IAP) until the appropriate instrument MAPt is reached.
 - (2) At the beginning of the level flight phase at or above the MDA/H, the instrument approach track should be maintained until the pilot:
 - (i) estimates that, in all probability, visual contact with the runway of intended landing or the runway environment will be maintained during the entire circling procedure;
 - (ii) estimates that the aeroplane is within the circling area before commencing circling; and
 - (iii) is able to determine the aeroplane's position in relation to the runway of intended landing with the aid of the appropriate visual references.
 - (3) When reaching the published instrument MAPt and the conditions stipulated in (c)(2) are unable to be established by the pilot, a missed approach should be carried out in accordance with that instrument approach procedure.
 - (4) After the aeroplane has left the track of the initial instrument approach, the flight phase outbound from the runway should be limited to an appropriate distance, which is required to align the aeroplane onto the final approach. Such manoeuvres should be conducted to enable the aeroplane:
 - (i) to attain a controlled and stable descent path to the intended landing runway; and
 - (ii) to remain within the circling area and in such a way that visual contact with the runway of intended landing or runway environment is maintained at all times.
 - (5) Flight manoeuvres should be carried out at an altitude/height that is not less than the circling MDA/H.
 - (6) Descent below MDA/H should not be initiated until the threshold of the runway to be used has been appropriately identified. The aeroplane should be in a position to continue with a normal rate of descent and land within the touchdown zone.

- (d) Instrument approach followed by a visual manoeuvring (circling) with prescribed track:
- (1) The aeroplane should remain on the initial instrument approach procedure until one of the following is reached:
 - (i) the prescribed divergence point to commence circling on the prescribed track; or
 - (ii) the MAPt.
 - (2) The aeroplane should be established on the instrument approach track determined by the radio navigation aids, RNAV, RNP, or ILS, MLS or GLS in level flight at or above the MDA/H at or by the circling manoeuvre divergence point.
 - (3) If the divergence point is reached before the required visual reference is acquired, a missed approach should be initiated not later than the MAPt and completed in accordance with the initial instrument approach procedure.
 - (4) When commencing the prescribed circling manoeuvre at the published divergence point, the subsequent manoeuvres should be conducted to comply with the published routing and published heights/altitudes.
 - (5) Unless otherwise specified, once the aeroplane is established on the prescribed track(s), the published visual reference does not need to be maintained unless:
 - (i) required by the State of the aerodrome; or
 - (ii) the circling MAPt (if published) is reached.
 - (6) If the prescribed circling manoeuvre has a published MAPt and the required visual reference has not been obtained by that point, a missed approach should be executed in accordance with (e)(2) and (e)(3).
 - (7) Subsequent further descent below MDA/H should only commence when the required visual reference has been obtained.
 - (8) Unless otherwise specified in the procedure, final descent should not be commenced from MDA/H until the threshold of the intended landing runway has been identified and the aeroplane is in a position to continue with a normal rate of descent to land within the touchdown zone.
- (e) Missed approach:
- (1) Missed approach during the instrument procedure prior to circling:
 - (i) if the missed approach is required to be flown when the aeroplane is positioned on the instrument approach track defined by radio navigation aids, RNAV, RNP or ILS, MLS or GLS and before commencing the circling manoeuvre, the published missed approach for the instrument approach should be followed; or
 - (ii) if the instrument approach procedure is carried out with the aid of an ILS, MLS or a stabilised approach (SAp), the MAPt associated with an ILS or MLS procedure without glide path (GP-out procedure) or the SAp, where applicable, should be used.
 - (2) If a prescribed missed approach is published for the circling manoeuvre, this overrides the manoeuvres prescribed below.
 - (3) If visual reference is lost while circling to land after the aeroplane has departed from the initial instrument approach track, the missed approach specified for that particular instrument approach should be followed. It is expected that the pilot will make an initial

climbing turn toward the intended landing runway to a position overhead of the aerodrome where the pilot will establish the aeroplane in a climb on the instrument missed approach segment.

- (4) The aeroplane should not leave the visual manoeuvring (circling) area, which is obstacle protected, unless:
 - (i) established on the appropriate missed approach procedure; or
 - (ii) at minimum sector altitude (MSA).
- (5) All turns should be made in the same direction and the aeroplane should remain within the circling protected area while climbing either:
 - (i) to the altitude assigned to any published circling missed approach manoeuvre if applicable;
 - (ii) to the altitude assigned to the missed approach of the initial instrument approach;
 - (iii) to the MSA;
 - (iv) to the minimum holding altitude (MHA) applicable for transition to a holding facility or fix, or continue to climb to an MSA; or
 - (v) as directed by ATS.

When the missed approach procedure is commenced on the 'downwind' leg of the circling manoeuvre, an 'S' turn may be undertaken to align the aeroplane on the initial instrument approach missed approach path, provided the aeroplane remains within the protected circling area.

The pilot-in-command should be responsible for ensuring adequate terrain clearance during the above-stipulated manoeuvres, particularly during the execution of a missed approach initiated by ATS.

- (6) Because the circling manoeuvre may be accomplished in more than one direction, different patterns will be required to establish the aeroplane on the prescribed missed approach course, depending on its position at the time visual reference is lost. In particular, all turns are to be in the prescribed direction if this is restricted, e.g. to the west/east (left or right hand) to remain within the protected circling area.
- (7) If a missed approach procedure is published for a particular runway onto which the aeroplane is conducting a circling approach and the aeroplane has commenced a manoeuvre to align with the runway, the missed approach for this direction may be accomplished. The ATS unit should be informed of the intention to fly the published missed approach procedure for that particular runway.
- (8) The pilot-in-command should advise ATS when any missed approach procedure has been commenced, the height/altitude the aeroplane is climbing to and the position the aeroplane is proceeding towards and/or heading the aeroplane is established on.

GM2 NCO.OP.112 Aerodrome operating minima — circling operations with aeroplanes

ED Decision 2022/012/R

DH/MDH — CALCULATION OF DA/MDA

[NCO.OP.112](#) refers to MDH because the rule compares heights with other heights (minimum circling height, OCH, etc.). Usually, the MDH will be converted to MDA for operational use by adding the aerodrome elevation.

NCO.OP.113 Aerodrome operating minima – onshore circling operations with helicopters

Regulation (EU) No 379/2014

The MDH for an onshore circling operation with helicopters shall not be lower than 250 ft and the meteorological visibility not less than 800 m.

NCO.OP.115 Departure and approach procedures – aeroplanes and helicopters

Regulation (EU) No 800/2013

- (a) The pilot-in-command shall use the departure and approach procedures established by the State of the aerodrome, if such procedures have been published for the runway or FATO to be used.
- (b) The pilot-in-command may deviate from a published departure route, arrival route or approach procedure:
 - (1) provided obstacle clearance criteria can be observed, full account is taken of the operating conditions and any ATC clearance is adhered to; or
 - (2) when being radar-vectored by an ATC unit.

AMC1 NCO.OP.115 Departure and approach procedures — aeroplanes and helicopters

ED Decision 2022/012/R

ARRIVALS AND DEPARTURES UNDER IFR WHERE NO INSTRUMENT FLIGHT PROCEDURES ARE PUBLISHED

When arriving or departing under IFR to/from an aerodrome or operating site with no published instrument flight procedure, the pilot-in-command should ensure that sufficient obstacle clearance is available for safe operation. This may be achieved, for example, by climbing or descending visually when below a minimum altitude at which obstacle clearance is known to exist.

When operating IFR in uncontrolled airspace, separation from other aircraft remains the responsibility of the pilot-in-command. The pilot-in-command should also comply with any flight planning and communication requirements designated by the competent authority under SERA.4001(b)(3) and SERA.5025(b). Any ATC clearance required to enter controlled airspace must be obtained prior to entry.

NCO.OP.116 Performance-based navigation – aeroplanes and helicopters

Regulation (EU) 2016/1119

The pilot-in-command shall ensure that, when PBN is required for the route or procedure to be flown:

- (a) the relevant PBN navigation specification is stated in the AFM or other document that has been approved by the certifying authority as part of an airworthiness assessment or is based on such approval; and
- (b) the aircraft is operated in conformance with the relevant navigation specification and limitations in the AFM or other document mentioned above.

AMC1 NCO.OP.116 Performance-based navigation – aeroplanes and helicopters

ED Decision 2016/018/R

PBN OPERATIONS

For operations where a navigation specification for performance-based navigation (PBN) has been prescribed and no specific approval is required in accordance with [SPA.PBN.100](#), the pilot-in-command should:

- (a) use operating procedures specifying:
 - (1) normal, abnormal and contingency procedures;
 - (2) electronic navigation database management; and
 - (3) relevant entries in the minimum equipment list (MEL), where applicable;
- (b) ensure that he/she is appropriately trained for the intended operation.

AMC2 NCO.OP.116 Performance-based navigation – aeroplanes and helicopters

ED Decision 2016/018/R

MONITORING AND VERIFICATION

- (a) Preflight and general considerations
 - (1) At navigation system initialisation, the pilot-in-command should confirm that the navigation database is current and verify that the aircraft position, if required, has been entered correctly.
 - (2) The active flight plan, if applicable, should be checked by comparing the charts or other applicable documents with navigation equipment and displays. This includes confirmation of the waypoint sequence, reasonableness of track angles and distances, any altitude or speed constraints, and, where possible, which waypoints are fly-by and which are fly-over. Where relevant, the RF leg arc radii should be confirmed.
 - (3) The pilot-in-command should check that the navigation aids critical to the operation of the intended PBN procedure are available.
 - (4) The pilot-in-command should confirm the navigation aids that should be excluded from the operation, if any.

-
- (5) An arrival, approach or departure procedure should not be used if the validity of the procedure in the navigation database has expired.
- (b) Departure
- (1) Prior to commencing a take-off on a PBN procedure, the pilot-in-command should verify that the area navigation system is available and operating correctly and the correct aerodrome and runway data has been loaded. A positive check should be made that the indicated aircraft position is consistent with the actual aircraft position at the start of the take-off roll (aeroplanes) or lift-off (helicopters).
 - (2) Where GNSS is used, the signal should be acquired before the take-off roll (aeroplanes) or lift-off (helicopters) commences.
 - (3) Unless automatic updating of the actual departure point is provided, the pilot-in-command should ensure initialisation on the runway or FATO either by means of a manual runway threshold or intersection update, as applicable. This is to preclude any inappropriate or inadvertent position shift after take-off.
- (c) Arrival and approach
- (1) The pilot-in-command should verify that the navigation system is operating correctly and the correct arrival procedure and runway (including any applicable transition) are entered and properly depicted.
 - (2) Any published altitude and speed constraints should be observed.
 - (3) The pilot-in-command should check approach procedures (including alternate aerodromes if needed) as extracted by the system (e.g. CDU flight plan page) or presented graphically on the moving map, in order to confirm the correct loading and the reasonableness of the procedure content.
 - (4) Prior to commencing the approach operation (before the IAF), the pilot-in-command should verify the correctness of the loaded procedure by comparison with the appropriate approach charts. This check should include:
 - (i) the waypoint sequence;
 - (ii) reasonableness of the tracks and distances of the approach legs and the accuracy of the inbound course; and
 - (iii) the vertical path angle, if applicable.
- (d) Altimetry settings for RNP APCH operations using Baro VNAV
- (1) Barometric settings
 - (i) The pilot-in-command should set and confirm the correct altimeter setting and check that the two altimeters provide altitude values that do not differ more than 100 ft at the most at or before the FAF.
 - (ii) The pilot-in-command should fly the procedure with:
 - (A) a current local altimeter setting source available — a remote or regional altimeter setting source should not be used; and
 - (B) the QNH/QFE, as appropriate, set on the aircraft's altimeters.
 - (2) Temperature compensation
 - (i) For RNP APCH operations to LNAV/VNAV minima using Baro VNAV:

- (A) the pilot-in-command should not commence the approach when the aerodrome temperature is outside the promulgated aerodrome temperature limits for the procedure, unless the area navigation system is equipped with approved temperature compensation for the final approach;
 - (B) when the temperature is within promulgated limits, the pilot-in-command should not make compensation to the altitude at the FAF; and
 - (C) since only the final approach segment is protected by the promulgated aerodrome temperature limits, the pilot-in-command should consider the effect of temperature on terrain and obstacle clearance in other phases of flight.
- (ii) For RNP APCH operations to LNAV minima using Baro VNAV:
- (A) the pilot-in-command should consider the effect of temperature on terrain and obstacle clearance in all phases of flight, in particular on any step-down fix;
 - (B) if the temperature is outside promulgated limits for RNP APCH to LNAV/VNAV minima, the pilot-in-command should not use a Baro VNAV function for vertical guidance, unless the area navigation system is equipped with approved temperature compensation for the final approach.
- (e) Sensor and lateral navigation accuracy selection
- (1) For multi-sensor systems, the pilot-in-command should verify, during the approach, that the GNSS sensor is used for position computation.
 - (2) For aircraft with RNP input selection capability, the pilot-in-command should confirm that the indicated RNP value is appropriate for the PBN operation.

AMC3 NCO.OP.116 Performance-based navigation – aeroplanes and helicopters

ED Decision 2016/018/R

MANAGEMENT OF THE NAVIGATION DATABASE

- (a) For RNAV 1, RNAV 2, RNP 1, RNP 2, and RNP APCH, the pilot-in-command should neither insert nor modify waypoints by manual entry into a procedure (departure, arrival or approach) that has been retrieved from the database. User-defined data may be entered and used for waypoint altitude/speed constraints on a procedure where said constraints are not included in the navigation database coding.
- (b) For RNP 4 operations, the pilot-in-command should not modify waypoints that have been retrieved from the database. User-defined data (e.g. for flex-track routes) may be entered and used.
- (c) The lateral and vertical definition of the flight path between the FAF and the missed approach point (MAPt) retrieved from the database should not be revised by the pilot-in-command.

AMC4 NCO.OP.116 Performance-based navigation – aeroplanes and helicopters

ED Decision 2016/018/R

DISPLAYS AND AUTOMATION

- (a) For RNAV 1, RNP 1, and RNP APCH operations, the pilot-in-command should use a lateral deviation indicator, and where available, flight director and/or autopilot in lateral navigation mode.
- (b) The appropriate displays should be selected so that the following information can be monitored:
 - (1) the computed desired path;
 - (2) aircraft position relative to the lateral path (cross-track deviation) for FTE monitoring; and
 - (3) aircraft position relative to the vertical path (for a 3D operation).
- (c) The pilot-in-command of an aircraft with a lateral deviation indicator (e.g. CDI) should ensure that lateral deviation indicator scaling (full-scale deflection) is suitable for the navigation accuracy associated with the various segments of the procedure.
- (d) The pilot-in-command should maintain procedure centrelines unless authorised to deviate by ATC or demanded by emergency conditions.
- (e) Cross-track error/deviation (the difference between the area-navigation-system-computed path and the aircraft-computed position) should normally be limited to $\pm \frac{1}{2}$ time the RNAV/RNP value associated with the procedure. Brief deviations from this standard (e.g. overshoots or undershoots during and immediately after turns) up to a maximum of 1 time the RNAV/RNP value should be allowable.
- (f) For a 3D approach operation, the pilot-in-command should use a vertical deviation indicator and, where required by AFM/POH limitations, a flight director or autopilot in vertical navigation mode.
- (g) Deviations below the vertical path should not exceed 75 ft at any time, or half-scale deflection where angular deviation is indicated, and not more than 75 ft above the vertical profile, or half-scale deflection where angular deviation is indicated, at or below 1 000 ft above aerodrome level. The pilot-in-command should execute a missed approach if the vertical deviation exceeds this criterion, unless the pilot-in-command has in sight the visual references required to continue the approach.

AMC5 NCO.OP.116 Performance-based navigation – aeroplanes and helicopters

ED Decision 2016/018/R

VECTORING AND POSITIONING

- (a) ATC tactical interventions in the terminal area may include radar headings, 'direct to' clearances which bypass the initial legs of an approach procedure, interceptions of an initial or intermediate segments of an approach procedure or the insertion of additional waypoints loaded from the database.
- (b) In complying with ATC instructions, the pilot-in-command should be aware of the implications for the navigation system.

- (c) 'Direct to' clearances may be accepted to the IF provided that it is clear to the pilot-in-command that the aircraft will be established on the final approach track at least 2 NM before the FAF.
- (d) 'Direct to' clearance to the FAF should not be acceptable. Modifying the procedure to intercept the final approach track prior to the FAF should be acceptable for radar-vectorred arrivals or otherwise only with ATC approval.
- (e) The final approach trajectory should be intercepted no later than the FAF in order for the aircraft to be correctly established on the final approach track before starting the descent (to ensure terrain and obstacle clearance).
- (f) 'Direct to' clearances to a fix that immediately precede an RF leg should not be permitted.
- (g) For parallel offset operations en route in RNP 4 and A-RNP, transitions to and from the offset track should maintain an intercept angle of no more than 45° unless specified otherwise by ATC.

AMC6 NCO.OP.116 Performance-based navigation – aeroplanes and helicopters

ED Decision 2016/018/R

ALERTING AND ABORT

- (a) Unless the pilot-in-command has sufficient visual reference to continue the approach operation to a safe landing, an RNP APCH operation should be discontinued if:
 - (1) navigation system failure is annunciated (e.g. warning flag);
 - (2) lateral or vertical deviations exceed the tolerances; and
 - (3) loss of the on-board monitoring and alerting system.
- (b) Discontinuing the approach operation may not be necessary for a multi-sensor navigation system that includes demonstrated RNP capability without GNSS in accordance with the AFM/POH.
- (c) Where vertical guidance is lost while the aircraft is still above 1 000 ft AGL, the pilot-in-command may decide to continue the approach to LNAV minima, when supported by the navigation system.

AMC7 NCO.OP.116 Performance-based navigation – aeroplanes and helicopters

ED Decision 2016/018/R

CONTINGENCY PROCEDURES

- (a) The pilot-in-command should make the necessary preparation to revert to a conventional arrival procedure where appropriate. The following conditions should be considered:
 - (1) failure of the navigation system components including navigation sensors, and a failure effecting flight technical error (e.g. failures of the flight director or autopilot);
 - (2) multiple system failures affecting aircraft performance;
 - (3) coasting on inertial sensors beyond a specified time limit; and
 - (4) RAIM (or equivalent) alert or loss of integrity function.

- (b) In the event of loss of PBN capability, the pilot-in-command should invoke contingency procedures and navigate using an alternative means of navigation.
- (c) The pilot-in-command should notify ATC of any problem with PBN capability.
- (d) In the event of communication failure, the pilot-in-command should continue with the operation in accordance with published lost communication procedures.

AMC8 NCO.OP.116 Performance-based navigation – aeroplanes and helicopters

ED Decision 2016/018/R

RNAV 10

- (a) Operating procedures and routes should take account of the RNAV 10 time limit declared for the inertial system, if applicable, considering also the effect of weather conditions that could affect flight duration in RNAV 10 airspace.
- (b) The operator may extend RNAV 10 inertial navigation time by position updating. The operator should calculate, using statistically-based typical wind scenarios for each planned route, points at which updates can be made, and the points at which further updates will not be possible.

GM1 NCO.OP.116 Performance-based navigation – aeroplanes and helicopters

ED Decision 2016/018/R

DESCRIPTION

- (a) For both, RNP X and RNAV X designations, the 'X' (where stated) refers to the lateral navigation accuracy (total system error) in NM, which is expected to be achieved at least 95 % of the flight time by the population of aircraft operating within the airspace, route or procedure. For RNP APCH and A-RNP, the lateral navigation accuracy depends on the segment.
- (b) PBN may be required on notified routes, for notified procedures and in notified airspace.

RNAV 10

- (c) For purposes of consistency with the PBN concept, this Regulation is using the designation 'RNAV 10' because this specification does not include on-board performance monitoring and alerting.
- (d) However, it should be noted that many routes still use the designation 'RNP 10' instead of 'RNAV 10'. 'RNP 10' was used as designation before the publication of the fourth edition of ICAO Doc 9613 in 2013. The terms 'RNP 10' and 'RNAV 10' should be considered equivalent.

NCO.OP.120 Noise abatement procedures – aeroplanes and helicopters

Regulation (EU) 2018/1975

The pilot-in-command shall take into account published noise abatement procedures to minimise the effect of aircraft noise while ensuring that safety has priority over noise abatement.

NCO.OP.125 Fuel/energy and oil supply – aeroplanes and helicopters

Regulation (EU) 2021/1296

- (a) The pilot-in-command shall ensure that the quantity of fuel/energy and oil that is carried on board is sufficient, taking into account the meteorological conditions, any element affecting the performance of the aircraft, any delays that are expected in flight, and any contingencies that may reasonably be expected to affect the flight.
- (b) The pilot-in-command shall plan a quantity of fuel/energy to be protected as final reserve fuel/energy to ensure a safe landing. The pilot-in-command shall take into account all of the following, and in the following order of priority, to determine the quantity of the final reserve fuel/energy:
 - (1) the severity of the hazard to persons or property that may result from an emergency landing after fuel/energy starvation; and
 - (2) the likelihood of unexpected circumstances that the final reserve fuel/energy may no longer be protected.
- (c) The pilot-in-command shall commence a flight only if the aircraft carries sufficient fuel/energy and oil:
 - (1) when no destination alternate is required, to fly to the aerodrome or operating site of intended landing, plus the final reserve fuel/energy; or
 - (2) when a destination alternate is required, to fly to the aerodrome or operating site of intended landing, and thereafter, to an alternate aerodrome, plus the final reserve fuel/energy.

AMC1 NCO.OP.125(b) Fuel/energy and oil supply — aeroplanes and helicopters

ED Decision 2022/005/R

PLANNING CRITERIA — FINAL RESERVE FUEL/ENERGY

The final reserve fuel (FRF)/energy should be no less than the required fuel/energy to fly:

- (a) for aeroplanes:
 - (1) for 10 minutes at maximum continuous cruise power at 1 500 ft (450 m) above the destination under VFR by day, taking off and landing at the same aerodrome/landing site, and always remaining within sight of that aerodrome/landing site;
 - (2) for 30 minutes at holding speed at 1 500 ft (450 m) above the destination under VFR by day; and
 - (3) for 45 minutes at holding speed at 1 500 ft (450 m) above the destination or destination alternate aerodrome under VFR flights by night and IFR; and
- (b) for helicopters:
 - (1) for 10 minutes at best-range speed under VFR by day, taking off and landing at the same aerodrome/landing site, and always remaining within 25 NM of that aerodrome/landing site, when needed for the purpose of specialised operations;
 - (2) for 20 minutes at best-range speed for other VFR flights; and
 - (3) for 30 minutes at holding speed at 1 500 ft (450 m) above the destination or destination alternate aerodrome under IFR.

AMC2 NCO.OP.125(b) Fuel/energy and oil supply — aeroplanes and helicopters

ED Decision 2022/005/R

FINAL RESERVE FUEL/ENERGY

The quantity of the FRF/energy should be planned before flight and be an easily recalled figure against which the pilot-in-command can assess the current fuel/energy state of the aircraft.

AMC3 NCO.OP.125(b) Fuel/energy and oil supply — aeroplanes and helicopters

ED Decision 2022/005/R

FINAL RESERVE FUEL/ENERGY PROTECTION

The planned FRF/energy should be protected as a reserve in normal operations. If the fuel/energy on board falls below the FRF/energy, the pilot-in-command should consider this to be an emergency. The FRF/energy should not be used as contingency fuel in normal operations.

When the FRF/energy can no longer be protected, then a fuel/energy emergency should be declared and any landing option explored, including deviating from rules, operational procedures, and methods in the interest of safety (as per point [CAT.GEN.MPA.105\(b\)](#)).

GM1 NCO.OP.125(b) Fuel/energy and oil supply — aeroplanes and helicopters

ED Decision 2022/005/R

LIKELIHOOD OF UNEXPECTED CIRCUMSTANCES TO INCREASE WITH FLIGHT DURATION

The likelihood of unexpected circumstances arising after the aircraft is fuelled may increase with the duration of the planned flight (for example, during a long flight, a problem at the destination aerodrome or operating site is more likely to have occurred than during a short local flight).

GM2 NCO.OP.125(b) Fuel/energy and oil supply — aeroplanes and helicopters

ED Decision 2022/005/R

PLANNING of FUEL/ENERGY QUANTITY — HOLDING

When planning the fuel/energy quantity, in case of holding, and if the aircraft documentation does not provide approved data for the holding regime, the pilot should derive the fuel/energy flow data from the long-range/best-range cruise data or, if this is not provided, from the lowest available cruise data in power setting tables.

NCO.OP.130 Passenger briefing

Regulation (EU) No 800/2013

The pilot-in-command shall ensure that before or, where appropriate, during the flight, passengers are given a briefing on emergency equipment and procedures.

AMC1 NCO.OP.130 Passenger briefing

ED Decision 2019/008/R

GENERAL

- (a) The briefing should include the locations and use of seat belts and if applicable:
 - (1) emergency exits;
 - (2) passenger emergency briefing cards;
 - (3) life-jackets;
 - (4) oxygen dispensing equipment;
 - (5) life rafts; and
 - (6) other emergency equipment provided for individual passenger use.
- (b) The briefing should also include the location and general manner of use of the principal emergency equipment carried for collective use.

NCO.OP.135 Flight preparation

Regulation (EU) 2021/2237

- (a) Before commencing a flight, the pilot-in-command shall ascertain by every reasonable means available that the space-based facilities, ground and/or water facilities, including communication facilities and navigation aids available and directly required on such flight, for the safe operation of the aircraft, are adequate for the type of operation under which the flight is to be conducted.
- (b) Before commencing a flight, the pilot-in-command shall be familiar with all available meteorological information appropriate to the intended flight. Preparation for a flight away from the vicinity of the place of departure, and for every flight under IFR, shall include:
 - (1) a study of the available current meteorological reports and forecasts; and
 - (2) the planning of an alternative course of action to provide for the eventuality that the flight cannot be completed as planned, because of meteorological conditions.

NCO.OP.140 Destination alternate aerodromes — aeroplanes

Regulation (EU) 2021/2237

For IFR flights, the pilot-in-command shall specify at least one destination alternate aerodrome in the flight plan, unless the available current meteorological information for the destination indicates, for the period from 1 hour before until 1 hour after the estimated time of arrival, or from the actual time of departure to 1 hour after the estimated time of arrival, whichever is the shorter period, a ceiling of at least 1 000ft above the DH/MDH for an available instrument approach procedure (IAP) and a visibility of at least 5 000m.

NCO.OP.141 Destination alternate aerodromes — helicopters

Regulation (EU) 2021/2237

For IFR flights, the pilot-in-command shall specify at least one destination alternate aerodrome in the flight plan, unless the available current meteorological information for the destination indicates, for the period from 1 hour before until 1 hour after the estimated time of arrival, or from the actual time

of departure to 1 hour after the estimated time of arrival, whichever is the shorter period, a ceiling of at least 1 000ft above the DH/MDH for an available IAP and a visibility of at least 3 000m.

NCO.OP.142 Destination alternate aerodromes — instrument approach operations

Regulation (EU) 2021/2237

The pilot-in-command shall only select an aerodrome as a destination alternate aerodrome if either:

- (a) an IAP that does not rely on GNSS is available either at the destination aerodrome or at a destination alternate aerodrome, or
- (b) all of the following conditions are met:
 - (1) the onboard GNSS equipment is SBAS-capable;
 - (2) the destination aerodrome, any destination alternate aerodrome, and the route between them are within SBAS service area;
 - (3) ABAS is predicted to be available in the event of the unexpected unavailability of SBAS;
 - (4) an IAP is selected (either at destination or destination alternate aerodrome) that does not rely on the availability of SBAS;
 - (5) an appropriate contingency action allows the flight to be completed safely in the event of unavailability of GNSS.

AMC1 NCO.OP.142(b)(1) Destination alternate aerodromes — instrument approach operations

ED Decision 2022/012/R

SBAS-CAPABLE GNSS EQUIPMENT

GNSS system which are (E)TSO-C145() or (E)TSO-C146() are SBAS-capable. Aircraft certified for RNP APCH to LPV minima (see [AMC1 NCO.IDE.A/H.195\(l\)](#)) are considered compliant.

AMC2 NCO.OP.142(b)(3) Destination alternate aerodromes — instrument approach operations

ED Decision 2022/012/R

USE OF RAIM FOR SBAS

Where a receiver with RAIM is used to meet the requirement for SBAS, its availability should be predicted by a pre-flight RAIM check, in accordance with [AMC1 NCO.GEN.105\(c\)](#).

GM1 NCO.OP.142(b)(4) Destination alternate aerodromes — instrument approach operations

ED Decision 2022/012/R

IAPs THAT DO NOT RELY ON SBAS

This instrument approach can be an RNP APCH to LNAV minima. It can also be an RNP APCH to LNAV/VNAV minima using Baro VNAV if the aircraft is equipped with a Baro VNAV function certified for APV.

This requirement is only used for planning purposes to cover the possibility of an SBAS loss; it does not prevent the pilot from flying an approach relying on SBAS if SBAS is available.

AMC1 NCO.OP.142(b)(5) Destination alternate aerodromes — instrument approach operations

ED Decision 2022/012/R

APPROPRIATE CONTINGENCY ACTION

An appropriate contingency action is an alternative offered in [NCO.OP.142\(b\)\(5\)](#) to completion of the planned flight to a safe landing, either at the planned destination or a destination alternate, using normal procedures and using navigation equipment meeting the requirements of [NCO.IDE.A/H.100](#), installed for redundancy or as a backup.

The contingency action should be considered before flight and take into account the information identified by flight preparation according to [NCO.OP.135](#). It may depend on the flight and availability of navigation solutions (satellites, ground navaids, etc.) and weather conditions (IMC, VMC) along the flight.

The contingency action addresses partial loss of navigation capability, such as:

- loss of the stand-alone GNSS equipment;
- local loss of GNSS signal-in-space (e.g. local jamming at destination);
- loss of GNSS signal-in-space.

It should take into account what options remain in case of loss of GNSS signal; for instance, (non-GNSS-based) radar vectoring by ATC, non-GNSS-based navigation systems or the possibility to reach VMC.

Examples of contingency actions include:

- seeking navigational assistance from ATS, using communication and surveillance systems that remain operational, to enable safe descent to VMC;
- the emergency use of navigation equipment not meeting the requirements of [NCO.IDE.A/H.100](#) by making use of the provisions in [NCO.OP.105\(e\)](#);
- descent over water or very flat terrain to levels with reduced (but reasonable) obstacle clearance; and
- unusually long periods of dead reckoning.

NCO.OP.143 Destination alternate aerodromes planning minima — aeroplanes

Regulation (EU) 2021/2237

An aerodrome shall not be specified as a destination alternate aerodrome unless the available current meteorological information indicates, for the period from 1 hour before until 1 hour after the estimated time of arrival, or from the actual time of departure to 1 hour after the estimated time of arrival, whichever is the shorter period:

- (a) for an alternate aerodrome with an available instrument approach operation with DH less than 250 ft,
 - (1) a ceiling of at least 200 ft above the decision height (DH) or minimum descent height (MDH) associated with the instrument approach operation; and

- (2) a visibility of at least 1 500m; or
- (b) for an alternate aerodrome with an instrument approach operation with DH or MDH 250 ft or more,
 - (1) a ceiling of at least 400 ft above the DH or MDH associated with the instrument approach operation; and
 - (2) a visibility of at least 3 000m; or
- (c) for an alternate aerodrome without an IAP,
 - (1) a ceiling of at least the higher of 2 000ft and the minimum safe IFR height; and
 - (2) a visibility of at least 5 000m.

GM1 NCO.OP.143 Destination alternate aerodromes planning minima — aeroplanes

ED Decision 2022/012/R

MINIMUM SAFE IFR HEIGHT

For the purpose of [NCO.OP.143](#), the minimum safe IFR height is the height above the aerodrome of the lowest level compatible with SERA.5015(b) for en-route flight at a point from which visual flight to the aerodrome could reasonably be commenced.

NCO.OP.144 Destination alternate aerodromes planning minima — helicopters

Regulation (EU) 2021/2237

An aerodrome shall not be specified as a destination alternate aerodrome unless the available current meteorological information indicates, for the period from 1 hour before until 1 hour after the estimated time of arrival, or from the actual time of departure to 1 hour after the estimated time of arrival, whichever is the shorter period,

- (a) for an alternate aerodrome with an IAP:
 - (1) a ceiling of at least 200 ft above the DH or MDH associated with the IAP; and
 - (2) a visibility of at least 1 500m by day or 3 000m by night; or
- (b) for an alternate aerodrome without an IAP:
 - (1) a ceiling of at least the higher of 2 000ft and the minimum safe IFR height; and
 - (2) a visibility of at least 1 500m by day or 3 000m by night.

GM1 NCO.OP.144 Destination alternate aerodromes planning minima — helicopters

ED Decision 2022/012/R

MINIMUM SAFE IFR HEIGHT

For the purpose of [NCO.OP.144](#), the minimum safe IFR height is the height above the aerodrome of the lowest level compatible with SERA.5015(b) for en-route flight at a point from which visual flight to the aerodrome could reasonably be commenced.

NCO.OP.145 Refuelling with passengers embarking, on board or disembarking

Regulation (EU) 2021/1296

- (a) The aircraft shall not be refuelled with aviation gasoline (AVGAS) or wide-cut type fuel or a mixture of these types of fuel, when passengers are embarking, on board or disembarking.
- (b) For all other types of fuel/energy, the aircraft shall not be refuelled when passengers are embarking, on board or disembarking, unless it is attended by the pilot-in-command or other qualified personnel ready to initiate and direct an evacuation of the aircraft by the most practical and expeditious means available.

AMC1 NCO.OP.145 Refuelling with passengers embarking, on board or disembarking

ED Decision 2014/016/R

OPERATIONAL PROCEDURES

If passengers are on board when refuelling with other than aviation gasoline (AVGAS), wide-cut type fuel or a mixture of these types of fuel, the following precautions should be taken:

- (a) the pilot-in-command should remain at a location during fuelling operations with passengers on board which allows him to handle emergency procedures concerning fire protection and fire-fighting and initiate and direct an evacuation;
- (b) personnel and passengers should be warned that refuelling will take place;
- (c) passengers should be instructed to unfasten their seat belts and refrain from smoking; and
- (d) if the presence of fuel vapour is detected inside the aircraft, or any other hazard arises during refuelling, fuelling should be stopped immediately.

NCO.OP.147 Refuelling with engine(s) and/or rotors turning – helicopters

Regulation (EU) 2021/1296

Refuelling with engine(s) and/or rotors turning shall only be conducted if all those conditions are met simultaneously:

- (a) if it is not practical to shut down or restart the engine;
- (b) in accordance with any specific procedures and limitations in the aircraft flight manual (AFM);
- (c) with JET A or JET A-1 fuel types;
- (d) with no passengers or task specialists on board, embarking or disembarking;
- (e) if the operator of the aerodrome or operating site allows such operations;
- (f) in the presence of the appropriate rescue and firefighting (RFF) facilities or equipment; and
- (g) in accordance with a checklist that shall contain:
 - (1) normal and contingency procedures;
 - (2) the required equipment;
 - (3) any limitations; and

- (4) responsibilities and duties of the pilot-in-command and, if applicable, crew members and task specialists.

AMC1 NCO.OP.147 Refuelling with the engine(s) running and/or rotors turning — helicopters

ED Decision 2022/005/R

CHECKLIST — HELICOPTERS

- (a) Before commencing a refuelling with rotors turning, the pilot-in-command should conduct a risk assessment, assessing the complexity of the activity in order to determine the hazards and associated risks inherent in the operation, and establish mitigating measures.
- (b) Refuelling with rotors turning should be performed in accordance with a checklist. Based on the risk assessment, the pilot-in-command should establish a checklist appropriate to the activity and aircraft used, taking into account this AMC.
- (c) The checklist should cover relevant elements of [GM1 NCO.SPEC.105](#).
- (d) The checklist that is relevant to the duties of the pilot-in-command, crew members, and task specialists should be readily accessible.
- (e) The checklist should be regularly reviewed and updated, as appropriate.

GM1 NCO.OP.147 Refuelling with the engine(s) running and/or rotors turning — helicopters

ED Decision 2022/005/R

PROCEDURES — HELICOPTERS

[AMC1 SPO.OP.157](#) and [GM1 SPO.OP.157](#) provide a generic framework for the development of standard operating procedures (SOPs) for refuelling with the rotors turning.

NCO.OP.150 Carriage of passengers

Regulation (EU) 2018/394

The pilot-in-command shall ensure that, prior to and during taxiing, take-off and landing, and whenever deemed necessary in the interest of safety, each passenger on board occupies a seat or berth and has his/her safety belt or restraint device properly secured.

NCO.OP.155 Smoking on board — aeroplanes and helicopters

Regulation (EU) No 800/2013

The pilot-in-command shall not allow smoking on board:

- (a) whenever considered necessary in the interest of safety; and
- (b) during refuelling of the aircraft.

NCO.OP.160 Meteorological conditions

Regulation (EU) 2021/2237

- (a) The pilot-in-command shall only commence or continue a VFR flight if the latest available meteorological information indicates that the meteorological conditions along the route and at

the intended destination at the estimated time of use will be at or above the applicable VFR operating minima.

- (b) The pilot-in-command shall only commence or continue an IFR flight towards the planned destination aerodrome if the latest available meteorological information indicates that, at the estimated time of arrival, the meteorological conditions at the destination or at least one destination alternate aerodrome are at or above the applicable aerodrome operating minima.
- (c) If a flight contains VFR and IFR segments, the meteorological information referred to in (a) and (b) shall be applicable as far as relevant.

AMC1 NCO.OP.160 Meteorological conditions

ED Decision 2014/016/R

APPLICATION OF AERODROME FORECASTS (TAF & TREND) — AEROPLANES AND HELICOPTERS

Where a terminal area forecast (TAF) or meteorological aerodrome or aeronautical report (METAR) with landing forecast (TREND) is used as forecast, the following criteria should be used:

- (a) From the start of a TAF validity period up to the time of applicability of the first subsequent 'FM...' or 'BECMG' or, if no 'FM' or 'BECMG' is given, up to the end of the validity period of the TAF, the prevailing weather conditions forecast in the initial part of the TAF should be applied.
- (b) From the time of observation of a METAR up to the time of applicability of the first subsequent 'FM...' or 'BECMG' or, if no 'FM' or 'BECMG' is given, up to the end of the validity period of the TREND, the prevailing weather conditions forecast in the METAR should be applied.
- (c) Following FM (alone) or BECMG AT, any specified change should be applied from the time of the change.
- (d) Following BECMG (alone), BECMG FM, BECMG TL, BECMG FM TL:
 - (1) in the case of deterioration, any specified change should be applied from the start of the change; and
 - (2) in the case of improvement, any specified change should be applied from the end of the change.
- (e) In a period indicated by TEMPO (alone), TEMPO FM, TEMPO TL, TEMPO FM TL, PROB30/40 (alone):
 - (1) deteriorations associated with persistent conditions in connection with e.g. haze, mist, fog, dust/sandstorm, continuous precipitation should be applied;
 - (2) deteriorations associated with transient/showery conditions in connection with short-lived weather phenomena, e.g. thunderstorms, showers may be ignored; and
 - (3) improvements should in all cases be disregarded.
- (f) In a period indicated by PROB30/40 TEMPO:
 - (1) deteriorations may be disregarded; and
 - (2) improvements should be disregarded.

Note: Abbreviations used in the context of this AMC are as follows:

FM:	from
BECMG:	becoming
AT:	at
TL:	till

TEMPO: temporarily
PROB: probability

GM1 NCO.OP.160 Meteorological conditions

ED Decision 2014/016/R

CONTINUATION OF A FLIGHT — AEROPLANES AND HELICOPTERS

In the case of in-flight re-planning, continuation of a flight refers to the point from which a revised flight plan applies.

GM2 NCO.OP.160 Meteorological conditions

ED Decision 2014/016/R

EVALUATION OF METEOROLOGICAL CONDITIONS — AEROPLANES AND HELICOPTERS

It is recommended that the pilot-in-command carefully evaluates the available meteorological information relevant to the proposed flight, such as applicable surface observations, winds, temperatures aloft, terminal and area forecasts, air meteorological information reports (AIRMETs), significant meteorological information (SIGMET) and pilot reports. The ultimate decision whether, when, and where to make the flight rests with the pilot-in-command. The pilot-in-command also should continue to re-evaluate changing weather conditions.

NCO.OP.165 Ice and other contaminants – ground procedures

Regulation (EU) No 800/2013

The pilot-in-command shall only commence take-off if the aircraft is clear of any deposit that might adversely affect the performance or controllability of the aircraft, except as permitted in the AFM.

NCO.OP.170 Ice and other contaminants – flight procedures

Regulation (EU) No 800/2013

- (a) The pilot-in-command shall only commence a flight or intentionally fly into expected or actual icing conditions if the aircraft is certified and equipped to cope with such conditions as referred to in 2.a.5 of Annex IV to Regulation (EC) No 216/2008.
- (b) If icing exceeds the intensity of icing for which the aircraft is certified or if an aircraft not certified for flight in known icing conditions encounters icing, the pilot-in-command shall exit the icing conditions without delay, by a change of level and/or route, and if necessary by declaring an emergency to ATC.

GM1 NCO.OP.170(b) Ice and other contaminants – flight procedures

ED Decision 2014/016/R

KNOWN ICING CONDITIONS

Known icing conditions are conditions where actual ice is observed visually to be on the aircraft by the pilot or identified by on-board sensors.

NCO.OP.175 Take-off conditions — aeroplanes and helicopters

Regulation (EU) 2021/2237

Before commencing take-off, the pilot-in-command shall be satisfied that:

- (a) according to the information available, the meteorological conditions at the aerodrome or the operating site and the condition of the runway/FATO intended to be used will not prevent a safe take-off and departure; and
- (b) the selected aerodrome operating minima are consistent with all of the following:
 - (1) the operative ground equipment;
 - (2) the operative aircraft systems;
 - (3) the aircraft performance;
 - (4) flight crew qualifications.

AMC1 NCO.OP.175 Take-off conditions — aeroplanes and helicopters

ED Decision 2022/012/R

METEOROLOGICAL CONDITIONS FOR TAKE-OFF — AEROPLANES

- (a) When the reported visibility is below that required for take-off and RVR is not reported, a take-off should only be commenced if the pilot-in-command can determine that the visibility along the take-off runway/area is equal to or better than the required minimum.
- (b) When no reported visibility or RVR is available, a take-off should only be commenced if the pilot-in-command can determine that the RVR/VIS along the take-off runway/area is equal to or better than the required minimum.

NCO.OP.180 Simulated situations in flight

Regulation (EU) 2018/1975

- (a) The pilot-in-command shall, when carrying passengers or cargo, not simulate:
 - (1) situations that require the application of abnormal or emergency procedures; or
 - (2) flight in instrument meteorological conditions (IMC).
- (b) Notwithstanding (a), when training flights are conducted by a training organisation referred to in Article 10a of Commission Regulation (EU) No 1178/2011, such situations may be simulated with student pilots on-board.

GM1.NCO.OP.180 Simulated situations in flight

ED Decision 2017/011/R

DESIGNATION OF PERSONS AS CREW MEMBERS

- (a) The operator may designate any person as a crew member (including a task specialist) provided that:
 - (1) the role, according to the reasonable expectation of the operator, will enhance the safety of the flight or achieve an operational objective of the flight;

- (2) the person, according to the reasonable expectation of the operator, is capable of fulfilling the role;
 - (3) the person has been briefed on the role as a crew member and informed that they are crew, not a passenger; and
 - (4) the person agrees to the role as a crew member.
- (b) Crew members are not considered to be passengers.
- (c) Crew members may be required, by specific provisions of this Regulation and other Implementing Rules, to hold licences, ratings or other personnel certificates to fulfil certain roles such as instructor, examiner or flight engineer in certain circumstances.

NCO.OP.185 In-flight fuel/energy management

Regulation (EU) 2021/1296

- (a) The pilot-in-command shall monitor the amount of usable fuel/energy remaining on board to ensure that it is protected and not less than the fuel/energy that is required to proceed to an aerodrome or operating site where a safe landing can be made.
- (b) The pilot-in-command of a controlled flight shall advise air traffic control (ATC) of a 'minimum fuel/energy' state by declaring 'MINIMUM FUEL' when the pilot-in-command has:
- (1) committed to land at a specific aerodrome or operating site; and
 - (2) calculated that any change to the existing clearance to that aerodrome or operating site, or other air traffic delays, may result in landing with less than the planned final reserve fuel/energy.
- (c) The pilot-in-command of a controlled flight shall declare a situation of 'fuel/energy emergency' by broadcasting 'MAYDAY MAYDAY MAYDAY FUEL' when the usable fuel/energy estimated to be available upon landing at the nearest aerodrome or operating site where a safe landing can be made is less than the planned final reserve fuel/energy.

GM1 NCO.OP.185(b)&(c) In-flight fuel/energy management

ED Decision 2022/005/R

'MINIMUM FUEL' DECLARATION

- (a) The pilot-in-command may consider reporting the remaining fuel/energy endurance after a 'MINIMUM FUEL' or 'MAYDAY MAYDAY MAYDAY FUEL' declaration.

Note: For Part-NCO operators, the FRF/energy varies; therefore, the ATC may not be aware of the amount of the remaining fuel/energy endurance.

- (b) The 'MINIMUM FUEL' declaration informs the ATC that all planned landing options have been reduced to a specific aerodrome or operating site of intended landing, and that for helicopters, no other landing site is available. It also informs the ATC that any change to the existing clearance may result in landing with less than the planned FRF/energy. This is not an emergency situation but an indication that an emergency situation is possible, should any additional delay occur.

The pilot should not expect any form of priority handling as a result of a 'MINIMUM FUEL' declaration. However, the ATC should advise the flight crew of any additional expected delays, as well as coordinate with other ATC units when transferring the control of the aircraft, to ensure that the other ATC units are aware of the flight's fuel/energy state.

- (c) The requirement for declaring 'MINIMUM FUEL' and 'MAYDAY MAYDAY MAYDAY FUEL' applies only to controlled flights; however, these declarations may also be made during uncontrolled flights if the pilot-in-command considers this advisable.

NCO.OP.190 Use of supplemental oxygen

Regulation (EU) 2016/1119

- (a) The pilot-in-command shall ensure that all flight crew members engaged in performing duties essential to the safe operation of an aircraft in flight use supplemental oxygen continuously whenever he/she determines that at the altitude of the intended flight the lack of oxygen might result in impairment of the faculties of crew members, and shall ensure that supplemental oxygen is available to passengers when lack of oxygen might harmfully affect passengers.
- (b) In any other case when the pilot-in-command cannot determine how the lack of oxygen might affect all occupants on board, he/she shall ensure that:
- (1) all crew members engaged in performing duties essential to the safe operation of an aircraft in flight use supplemental oxygen for any period in excess of 30 minutes when the pressure altitude in the the passenger compartment will be between 10 000 ft and 13 000 ft; and
 - (2) all occupants use supplemental oxygen for any period that the pressure altitude in the the passenger compartment will be above 13 000 ft.

AMC1 NCO.OP.190(a) Use of supplemental oxygen

ED Decision 2016/018/R

DETERMINATION OF SUPPLEMENTAL OXYGEN NEED

When determining the need for supplemental oxygen carriage and use, the pilot-in-command should:

- (a) in the preflight phase:
- (1) be aware of hypoxia conditions and associated risks;
 - (2) consider the following objective conditions for the intended flight:
 - (i) altitude;
 - (ii) duration of the flight; and
 - (iii) any other relevant operational conditions.
 - (3) consider individual conditions of flight crew members and passengers in relation to:
 - (i) altitude of the place of residence;
 - (ii) smoking;
 - (iii) experience in flights at high altitudes;
 - (iv) actual medical conditions and medications;
 - (v) age
 - (vi) disabilities; and
 - (vii) any other relevant factor that may be detected, or reported by the person; and

- (4) when relevant, ensure that all flight crew members and passengers are briefed on hypoxia conditions and symptoms, as well as on the usage of supplemental oxygen equipment.
- (b) during flight:
 - (1) monitor for early symptoms of hypoxia conditions; and
 - (2) if detecting early symptoms of hypoxia conditions:
 - (i) consider to return to a safe altitude, and
 - (ii) ensure that supplemental oxygen is used, if available.

GM1 NCO.OP.190 Use of supplemental oxygen

ED Decision 2016/018/R

GENERAL

- (a) The responsibility of the pilot-in-command for safety of all persons on board, as required by [NCO.GEN.105\(a\)\(1\)](#), includes the determination of need for supplemental oxygen use.
- (b) The altitudes above which [NCO.OP.190\(b\)](#) requires oxygen to be available and used are applicable to those cases when the pilot-in-command cannot determine the need for supplemental oxygen. However, if the pilot-in-command is able to make this determination, he/she may elect in the interest of safety to require oxygen also for operations at or below such altitudes.
- (c) The pilot-in-command should be aware that flying below altitudes mentioned in [NCO.OP.190\(b\)](#) does not provide absolute protection against hypoxia symptoms, should individual conditions and aptitudes be prevalent.

GM2 NCO.OP.190 Use of supplemental oxygen

ED Decision 2016/018/R

DETERMINATION OF OXYGEN NEED — BEFORE FLIGHT

Detailed information and guidance on hypoxia conditions and symptoms, content of the briefing on hypoxia and assessment of individual conditions may be found in the EASA leaflet 'Hypoxia'.

DETERMINATION OF OXYGEN NEED — IN FLIGHT

Several methods for monitoring hypoxia early symptoms may be used and some methods may be aided by personal equipment, such as finger-mounted pulse oximeters. Detailed information and guidance on entering hypoxia conditions, on hypoxia symptoms early detection, and on use of personal equipment such as finger-mounted pulse oximeters or equivalent may be found in the EASA leaflet 'Hypoxia'.

NCO.OP.195 Ground proximity detection

Regulation (EU) No 800/2013

When undue proximity to the ground is detected by the pilot-in-command or by a ground proximity warning system, the pilot-in-command shall take corrective action immediately in order to establish safe flight conditions.

NCO.OP.200 Airborne collision avoidance system (ACAS II)

Regulation (EU) No 800/2013

When ACAS II is used, operational procedures and training shall be in accordance with Regulation (EU) No 1332/2011.

NCO.OP.205 Approach and landing conditions — aeroplanes

Regulation (EU) 2021/2237

Before commencing an approach to land, the pilot-in-command shall be satisfied that:

- (a) according to the information available, the meteorological conditions at the aerodrome or the operating site, and the condition of the runway intended to be used will not prevent a safe approach, landing, or missed approach; and
- (b) the selected aerodrome operating minima are consistent with all of the following:
 - (1) the operative ground equipment;
 - (2) the operative aircraft systems;
 - (3) the aircraft performance, and
 - (4) flight crew qualifications.

AMC1 NCO.OP.205 Approach and landing conditions — aeroplanes

ED Decision 2021/005/R

LANDING DISTANCE ASSESSMENT

- (a) The in-flight landing distance assessment should be based on the latest available weather report and, if available, runway condition report (RCR).
- (b) The assessment should be initially carried out when weather report and RCR, if available, are obtained, usually around top of descent. If the planned duration of the flight does not allow to carry out the assessment in non-critical phases of flight, the assessment should be carried out before departure.
- (c) When meteorological conditions may lead to a degradation of the runway surface condition, the assessment should include consideration of how much deterioration in runway surface friction characteristics may be tolerated, so that a quick decision can be made prior to landing.
- (d) Whenever the RCR is in use and the runway braking action encountered during the landing roll is not as good as reported by the aerodrome operator in the RCR, the pilot-in-command should notify the air traffic services (ATS) by means of a special air-report (AIREP) as soon as practicable.

GM1 NCO.OP.205 Approach and landing conditions — aeroplanes

ED Decision 2021/005/R

RUNWAY CONDITION REPORT (RCR)

When the aerodrome reports the runway conditions by means of an RCR, the information contained therein includes a runway condition code (RWYCC). The determination of the RWYCC is based on the use of the runway condition assessment matrix (RCAM). The RCAM correlates the RWYCC with the contaminants present on the runway and the braking action.

A detailed description of the RCR format and content, the RWYCC and the RCAM may be found in Annex V (Part-ADR.OPS) to Regulation (EU) No 139/2014, in Regulation (EU) 2017/373 and in Regulation (EU) No 923/2012 (SERA). Further guidance may be found in the following documents:

- (a) ICAO Doc 9981 'PANS Aerodromes';
- (b) ICAO Doc 4444 'PANS ATM';
- (c) ICAO Doc 10064 'Aeroplane Performance Manual'; and
- (d) ICAO Circular 355 'Assessment, Measurement and Reporting of Runway Surface Conditions'.

NCO.OP.206 Approach and landing conditions — helicopters

Regulation (EU) 2021/2237

Before commencing an approach to land, the pilot-in-command shall be satisfied that:

- (a) according to the information available, the meteorological conditions at the aerodrome or the operating site and the condition of the final approach and take-off area (FATO) intended to be used will not prevent a safe approach, landing or missed approach; and
- (b) the selected aerodrome operating minima are consistent with all of the following:
 - (1) the operative ground equipment;
 - (2) the operative aircraft systems;
 - (3) the aircraft performance;
 - (4) flight crew qualifications.

AMC1 NCO.OP.206 Approach and landing conditions — helicopters

ED Decision 2021/005/R

FATO SUITABILITY

The in-flight determination of the FATO suitability should be based on the latest available meteorological report.

NCO.OP.210 Commencement and continuation of approach — aeroplanes and helicopters

Regulation (EU) 2021/2237

- (a) If the controlling RVR for the runway to be used for landing is less than 550 m (or any lower value established in accordance with an approval under SPA.LVO), then an instrument approach operation shall not be continued:
 - (1) past a point at which the aircraft is 1 000 ft above the aerodrome elevation; or
 - (2) into the final approach segment if the DH or MDH is higher than 1 000 ft.
- (b) If the required visual reference is not established, a missed approach shall be executed at or before the DA/H or the MDA/H.
- (c) If the required visual reference is not maintained after DA/H or MDA/H, a go-around shall be executed promptly.

AMC1 NCO.OP.210 Commencement and continuation of approach — aeroplanes and helicopters

ED Decision 2022/012/R

VISUAL REFERENCES

- (a) For a straight-in approach, at DH or MDH, at least one of the visual references specified below should be distinctly visible and identifiable to the pilot:
- (1) elements of the approach lighting system;
 - (2) the threshold;
 - (3) the threshold markings;
 - (4) the threshold lights;
 - (5) the threshold identification lights;
 - (6) the visual glide path indicator;
 - (7) the touchdown zone (TDZ) or TDZ markings;
 - (8) the TDZ lights;
 - (9) FATO/runway edge lights;
 - (10) for helicopter PinS approaches, the identification beacon light and visual ground reference;
 - (11) for helicopter PinS approaches, the identifiable elements of the environment defined on the instrument chart; or
 - (12) for helicopter PinS approaches with instructions to 'proceed VFR', sufficient visual cues to determine that the conditions for VFR are met.
- (b) For a circling approach, the required visual reference is the runway environment.

AMC2 NCO.OP.210 Commencement and continuation of approach — aeroplanes and helicopters

ED Decision 2022/012/R

RVR MINIMA FOR CONTINUED APPROACH

- (a) The controlling RVR should be the touchdown RVR.
- (b) If the touchdown RVR is not reported, then the midpoint RVR should be the controlling RVR.
- (c) If neither the touchdown RVR nor the midpoint RVR is reported, then [NCO.OP.210\(a\)](#) is not applicable.

GM1 NCO.OP.210 Commencement and continuation of approach — aeroplanes and helicopters

ED Decision 2022/012/R

APPLICATION OF RVR REPORTS

- (a) There is no prohibition on the commencement of an approach based on reported RVR. The restriction in [NCO.OP.210](#) applies only if the RVR is reported and applies to the continuation of

the approach past a point where the aircraft is 1 000 ft above the aerodrome elevation or into the final approach segment (FAS) as applicable.

- (b) If a deterioration in the RVR is reported once the aircraft is below 1 000 ft on in the FAS, as applicable, then there is no requirement for the approach to be discontinued. In this situation, the normal visual reference requirements would apply at the DA/H.
- (c) Where additional RVR information is provided (e.g. midpoint and stop end), this is advisory; such information may be useful to the pilot in order to determine whether there will be sufficient visual reference to control the aircraft during roll-out and taxi.
- (d) If the RVR is less than the RVR calculated in accordance with [AMC3 NCO.OP.110](#), a go-around is likely to be necessary since visual reference may not be established at the DH, or at the MDH at a point where a stable approach to landing in the TDZ remains possible. Similarly, in the absence of an RVR report, the reported visibility may indicate that a go-around is likely. The pilot-in-command should consider available options, based on a thorough assessment of risk, such as diverting to an alternate, before commencing the approach.

NCO.OP.220 Airborne collision avoidance system (ACAS II)

Regulation (EU) 2016/1199

When ACAS II is used, pilot-in-command shall apply the appropriate operational procedures and be adequately trained.

SUBPART C: AIRCRAFT PERFORMANCE AND OPERATING LIMITATIONS

NCO.POL.100 Operating limitations – all aircraft

Regulation (EU) 2018/394

- (a) During any phase of operation, the loading, the mass and, the centre of gravity (CG) position of the aircraft shall comply with any limitation specified in the AFM or equivalent document.
- (b) Placards, listings, instrument markings, or combinations thereof, containing those operating limitations prescribed by the AFM for visual presentation, shall be displayed in the aircraft.

NCO.POL.105 Weighing

Regulation (EU) 2018/1975

- (a) The operator shall ensure that the mass and, the CG of the aircraft have been established by actual weighing prior to the initial entry into service of the aircraft. The accumulated effects of modifications and repairs on the mass and balance shall be accounted for and properly documented. Such information shall be made available to the pilot-in-command. The aircraft shall be reweighed if the effect of modifications on the mass and balance is not accurately known.
- (b) The weighing shall be accomplished by the manufacturer of the aircraft or by an approved maintenance organisation.

GM1 NCO.POL.105 Weighing

ED Decision 2018/003/R

GENERAL

- (a) New aircraft that have been weighed at the factory may be placed into operation without reweighing if the mass records and, balance records have been adjusted for alterations or modifications to the aircraft. Aircraft transferred from one EU operator to another EU operator do not have to be weighed prior to use by the receiving operator, unless the mass and balance cannot be accurately established by calculation.
- (b) The mass and centre of gravity (CG) position should be revised whenever the cumulative changes to the dry operating mass exceed $\pm 0.5\%$ of the maximum landing mass or, for aeroplanes, the cumulative change in CG position exceeds 0.5% of the mean aerodynamic chord. This may be done by weighing the aircraft or by calculation. If the AFM requires to record changes to mass and CG position below these thresholds, or to record changes in any case, and make them known to the pilot-in-command, mass and CG position should be revised accordingly and made known to the pilot-in-command.

NCO.POL.110 Performance – general

Regulation (EU) No 800/2013

The pilot-in-command shall only operate the aircraft if the performance is adequate to comply with the applicable rules of the air and any other restrictions applicable to the flight, the airspace or the aerodromes or operating sites used, taking into account the charting accuracy of any charts and maps used.

SUBPART D: INSTRUMENTS, DATA AND EQUIPMENT

SECTION 1 – AEROPLANES

NCO.IDE.A.100 Instruments and equipment – general

Regulation (EU) 2019/1384

- (a) Instruments and equipment required by this Subpart shall be approved in accordance with the applicable airworthiness requirements if they are:
- (1) used by the flight crew to control the flight path;
 - (2) used to comply with [NCO.IDE.A.190](#);
 - (3) used to comply with [NCO.IDE.A.195](#); or
 - (4) installed in the aeroplane.
- (b) The following items, when required under this Subpart, do not need an equipment approval:
- (1) spare fuses;
 - (2) independent portable lights;
 - (3) an accurate time piece;
 - (4) first-aid kit;
 - (5) survival and signalling equipment;
 - (6) sea anchor and equipment for mooring;
 - (7) child restraint device;
 - (8) a simple PCDS used by a task specialist as a restraint device.
- (c) Instruments and equipment not required under Annex VII (Part-NCO) as well as any other equipment that is not required under this Regulation, but is carried on a flight, shall comply with the following requirements:
- (1) the information provided by those instruments or equipment shall not be used by the flight crew members to comply with Annex II to Regulation (EU) 2018/1139 or points [NCO.IDE.A.190](#) and [NCO.IDE.A.195](#) of Annex VII;
 - (2) the instruments and equipment shall not affect the airworthiness of the aeroplane, even in the case of failures or malfunction.
- (d) Instruments and equipment shall be readily operable or accessible from the station where the flight crew member that needs to use it is seated.
- (e) All required emergency equipment shall be easily accessible for immediate use.

GM1 NCO.IDE.A.100(a) Instruments and equipment – general

ED Decision 2014/016/R

APPLICABLE AIRWORTHINESS REQUIREMENTS

The applicable airworthiness requirements for approval of instruments and equipment required by this Part are the following:

- (a) Regulation (EU) No 748/2012¹ for aeroplanes registered in the EU; and
- (b) Airworthiness requirements of the State of registry for aeroplanes registered outside the EU.

GM1 NCO.IDE.A.100(b) Instruments and equipment – general

ED Decision 2014/016/R

REQUIRED INSTRUMENTS AND EQUIPMENT THAT DO NOT NEED TO BE APPROVED IN ACCORDANCE WITH THE APPLICABLE AIRWORTHINESS REQUIREMENTS

The functionality of non-installed instruments and equipment required by this Subpart and that do not need an equipment approval, as listed in [NCO.IDE.A.100\(b\)](#), should be checked against recognised industry standards appropriate to the intended purpose. The operator is responsible for ensuring the maintenance of these instruments and equipment.

GM1 NCO.IDE.A.100(c) Instruments and equipment – general

ED Decision 2014/016/R

NOT REQUIRED INSTRUMENTS AND EQUIPMENT THAT DO NOT NEED TO BE APPROVED IN ACCORDANCE WITH THE APPLICABLE AIRWORTHINESS REQUIREMENTS, BUT ARE CARRIED ON A FLIGHT

- (a) The provision of this paragraph does not exempt any installed instrument or item of equipment from complying with the applicable airworthiness requirements. In this case, the installation should be approved as required in the applicable airworthiness requirements and should comply with the applicable Certification Specifications.
- (b) The failure of additional non-installed instruments or equipment not required by this Part or by the applicable airworthiness requirements or any applicable airspace requirements should not adversely affect the airworthiness and/or the safe operation of the aeroplane. Examples may be the following:
 - (1) portable electronic flight bag (EFB);
 - (2) portable electronic devices carried by crew members; and
 - (3) non-installed passenger entertainment equipment.

NCO.IDE.A.105 Minimum equipment for flight

Regulation (EU) No 800/2013

A flight shall not be commenced when any of the aeroplane instruments, items of equipment or functions required for the intended flight are inoperative or missing, unless:

- (a) the aeroplane is operated in accordance with the MEL, if established; or
- (b) the aeroplane is subject to a permit to fly issued in accordance with the applicable airworthiness requirements.

¹ Commission Regulation (EU) No 748/2012 of 3 August 2012 laying down implementing rules for the airworthiness and environmental certification of aircraft and related products, parts and appliances, as well as for the certification of design and production organisations, OJ L 224, 21.8.2012, p. 1.

AMC1 NCO.IDE.A.105 Minimum equipment for flight

ED Decision 2021/005/R

MANAGEMENT OF THE STATUS OF CERTAIN INSTRUMENTS, EQUIPMENT OR FUNCTIONS

The operator should control and retain the status of the instruments, equipment or functions required for the intended operation, that are not controlled for the purpose of continuing airworthiness management.

GM1 NCO.IDE.A.105 Minimum equipment for flight

ED Decision 2021/005/R

MANAGEMENT OF THE STATUS OF CERTAIN INSTRUMENTS, EQUIPMENT OR FUNCTIONS

- (a) The operator should define responsibilities and procedures to retain and control the status of instruments, equipment or functions required for the intended operation, that are not controlled for the purpose of continuing airworthiness management.
- (b) Examples of such instruments, equipment or functions may be, but are not limited to, equipment related to navigation approvals as FM immunity or certain software versions.

NCO.IDE.A.110 Spare electrical fuses

Regulation (EU) No 800/2013

Aeroplanes shall be equipped with spare electrical fuses, of the ratings required for complete circuit protection, for replacement of those fuses that are allowed to be replaced in flight.

GM1 NCO.IDE.A.110 Spare electrical fuses

ED Decision 2014/016/R

FUSES

A spare electrical fuse means a replaceable fuse in the flight crew compartment, not an automatic circuit breaker or circuit breakers in the electric compartments.

NCO.IDE.A.115 Operating lights

Regulation (EU) No 800/2013

Aeroplanes operated at night shall be equipped with:

- (a) an anti-collision light system;
- (b) navigation/position lights;
- (c) a landing light;
- (d) lighting supplied from the aeroplane's electrical system to provide adequate illumination for all instruments and equipment essential to the safe operation of the aeroplane;
- (e) lighting supplied from the aeroplane's electrical system to provide illumination in all passenger compartments;
- (f) an independent portable light for each crew member station; and
- (g) lights to conform with the International Regulations for Preventing Collisions at Sea if the aeroplane is operated as a seaplane.

NCO.IDE.A.120 Operations under VFR – flight and navigational instruments and associated equipment

Regulation (EU) 2019/1384

- (a) Aeroplanes operated under VFR by day shall be equipped with a means of measuring and displaying the following:
- (1) magnetic heading;
 - (2) time, in hours, minutes and seconds;
 - (3) barometric altitude;
 - (4) indicated airspeed; and
 - (5) Mach number, whenever speed limitations are expressed in terms of Mach number.
- (b) Aeroplanes operated under visual meteorological conditions (VMC) at night, or in conditions where the aeroplane cannot be maintained in a desired flight path without reference to one or more additional instruments, shall be, in addition to (a), equipped with:
- (1) a means of measuring and displaying the following:
 - (i) turn and slip;
 - (ii) attitude;
 - (iii) vertical speed; and
 - (iv) stabilised heading;and
 - (2) a means of indicating when the supply of power to the gyroscopic instruments is not adequate.
- (c) Aeroplanes operated in conditions where they cannot be maintained in a desired flight path without reference to one or more additional instruments, shall be, in addition to (a) and (b), equipped with a means of preventing malfunction of the airspeed indicating system required in (a)(4) due to condensation or icing.

AMC1 NCO.IDE.A.120&NCO.IDE.A.125 Operations under VFR & operations under IFR – flight and navigational instruments and associated equipment

ED Decision 2014/016/R

INTEGRATED INSTRUMENTS

- (a) Individual equipment requirements may be met by combinations of instruments, by integrated flight systems or by a combination of parameters on electronic displays. The information so available to each required pilot should not be less than that required in the applicable operational requirements, and the equivalent safety of the installation should be approved during type certification of the aeroplane for the intended type of operation.
- (b) The means of measuring and indicating turn and slip, aeroplane attitude and stabilised aeroplane heading may be met by combinations of instruments or by integrated flight director systems, provided that the safeguards against total failure, inherent in the three separate instruments, are retained.

AMC2 NCO.IDE.A.120 Operations under VFR – flight and navigational instruments and associated equipment

ED Decision 2014/016/R

LOCAL FLIGHTS

For flights that do not exceed 60 minutes duration, that take off and land at the same aerodrome, and that remain within 50 NM of that aerodrome, an equivalent means of complying with [NCO.IDE.A.120\(b\)\(1\)\(i\), \(b\)\(1\)\(ii\)](#) may be:

- (a) a turn and slip indicator;
- (b) a turn co-ordinator; or
- (c) both an attitude indicator and a slip indicator.

GM1 NCO.IDE.A.120 Operations under VFR – flight and navigational instruments and associated equipment

ED Decision 2014/016/R

SLIP INDICATION

Aeroplanes should be equipped with a means of measuring and displaying slip.

NCO.IDE.A.125 Operations under IFR – flight and navigational instruments and associated equipment

Regulation (EU) 2019/1384

Aeroplanes operated under IFR shall be equipped with:

- (a) a means of measuring and displaying the following:
 - (1) magnetic heading;
 - (2) time in hours, minutes and seconds;
 - (3) barometric altitude;
 - (4) indicated airspeed;
 - (5) vertical speed;
 - (6) turn and slip;
 - (7) attitude;
 - (8) stabilised heading;
 - (9) outside air temperature; and
 - (10) Mach number, whenever speed limitations are expressed in terms of Mach number;
- (b) a means of indicating when the supply of power to the gyroscopic instruments is not adequate; and
- (c) a means of preventing malfunction of the airspeed indicating system required in (a)(4) due to condensation or icing.

GM1 NCO.IDE.A.125 Operations under IFR – flight and navigational instruments and associated equipment

ED Decision 2014/016/R

ALTERNATE SOURCE OF STATIC PRESSURE

Aeroplanes should be equipped with an alternate source of static pressure.

AMC1 NCO.IDE.A.120(a)(1)&NCO.IDE.A.125(a)(1) Operations under VFR & operations under IFR – flight and navigational instruments and associated equipment

ED Decision 2014/016/R

MEANS OF MEASURING AND DISPLAYING MAGNETIC HEADING

The means of measuring and displaying magnetic direction should be a magnetic compass or equivalent.

AMC1 NCO.IDE.A.120(a)(2)&NCO.IDE.A.125(a)(2) Operations under VFR & operations under IFR – flight and navigational instruments and associated equipment

ED Decision 2014/016/R

MEANS OF MEASURING AND DISPLAYING THE TIME

A means of measuring and displaying the time in hours, minutes and seconds may be a wrist watch capable of the same functions.

AMC1 NCO.IDE.A.120(a)(3)&NCO.IDE.A.125(a)(3) Operations under VFR operations & operations under IFR – flight and navigational instruments and associated equipment

ED Decision 2019/019/R

CALIBRATION OF THE MEANS OF MEASURING AND DISPLAYING PRESSURE ALTITUDE

The instrument measuring and displaying barometric altitude should be of a sensitive type calibrated in feet (ft), with a sub-scale setting, calibrated in hectopascals/millibars, adjustable for any barometric pressure likely to be set during flight.

GM1 NCO.IDE.A.125(a)(3) Operations under IFR – flight and navigational instruments and associated equipment

ED Decision 2014/016/R

ALTIMETERS

Altimeters with counter drum-pointer or equivalent presentation are considered to be less susceptible to misinterpretation for aeroplanes operating above 10 000 ft.

AMC1 NCO.IDE.A.120(a)(4)&NCO.IDE.A.125(a)(4) Operations under VFR & operations under IFR – flight and navigational instruments and associated equipment

ED Decision 2015/004/R

CALIBRATION OF THE INSTRUMENT INDICATING AIRSPEED

- (a) The instrument indicating airspeed should be calibrated in knots (kt).
- (b) In the case of aeroplanes with a maximum certified take-off mass (MCTOM) below 2 000 kg, calibration in kilometres per hour (kph) or in miles per hour (mph) is acceptable when such units are used in the AFM.

AMC1 NCO.IDE.A.120(c)&NCO.IDE.A.125(c) Operations under IFR — flight and navigational instruments and associated equipment

ED Decision 2014/016/R

MEANS OF PREVENTING MALFUNCTION DUE TO CONDENSATION OR ICING

The means of preventing malfunction due to either condensation or icing of the airspeed indicating system should be a heated pitot tube or equivalent.

AMC1 NCO.IDE.A.125(a)(9) Operations under IFR – flight and navigational instruments and associated equipment

ED Decision 2014/016/R

MEANS OF DISPLAYING OUTSIDE AIR TEMPERATURE

- (a) The means of displaying outside air temperature should be calibrated in degrees Celsius.
- (b) In the case of aeroplanes with a maximum certified take-off mass (MCTOM) below 2 000 kg, calibration in degrees Fahrenheit is acceptable, when such unit is used in the AFM.
- (c) The means of displaying outside air temperature may be an air temperature indicator that provides indications that are convertible to outside air temperature.

NCO.IDE.A.130 Terrain awareness warning system (TAWS)

Regulation (EU) No 800/2013

Turbine-powered aeroplanes certified for a maximum passenger seating configuration of more than nine shall be equipped with a TAWS that meets the requirements for:

- (a) class A equipment, as specified in an acceptable standard, in the case of aeroplanes for which the individual certificate of airworthiness (CofA) was first issued after 1 January 2011; or
- (b) class B equipment, as specified in an acceptable standard, in the case of aeroplanes for which the individual CofA was first issued on or before 1 January 2011.

AMC1 NCO.IDE.A.130 Terrain awareness warning system (TAWS)

ED Decision 2014/016/R

EXCESSIVE DOWNWARDS GLIDESLOPE DEVIATION WARNING FOR CLASS A TAWS

The requirement for a Class A TAWS to provide a warning to the flight crew for excessive downwards glideslope deviation should apply to all final approach glideslopes with angular vertical navigation (VNAV) guidance, whether provided by the instrument landing system (ILS), microwave landing system (MLS), satellite-based augmentation system approach procedure with vertical guidance (SBAS APV (localiser performance with vertical guidance approach LPV)), ground-based augmentation system (GBAS (GPS landing system, GLS)) or any other systems providing similar guidance. The same requirement should not apply to systems providing vertical guidance based on barometric VNAV.

GM1 NCO.IDE.A.130 Terrain awareness warning system (TAWS)

ED Decision 2014/016/R

ACCEPTABLE STANDARD FOR TAWS

An acceptable standard for Class A and Class B TAWS may be the applicable European Technical Standards Order (ETSO) issued by the Agency or equivalent.

NCO.IDE.A.135 Flight crew interphone system

Regulation (EU) No 800/2013

Aeroplanes operated by more than one flight crew member shall be equipped with a flight crew interphone system, including headsets and microphones for use by all flight crew members.

AMC1 NCO.IDE.A.135 Flight crew interphone system

ED Decision 2014/016/R

GENERAL

- (a) The flight crew interphone system should not be of a handheld type.
- (b) A headset consists of a communication device that includes two earphones to receive and a microphone to transmit audio signals to the aeroplane's communication system. To comply with the minimum performance requirements, the earphones and microphone should match the communication system's characteristics and the flight crew compartment environment. The headset should be adequately adjustable in order to fit the pilot's head. Headset boom microphones should be of the noise cancelling type.
- (c) If the intention is to utilise noise cancelling earphones, the pilot-in-command should ensure that the earphones do not attenuate any aural warnings or sounds necessary for alerting the flight crew on matters related to the safe operation of the aeroplane.

GM1 NCO.IDE.A.135 Flight crew interphone system

ED Decision 2014/016/R

HEADSET

The term 'headset' includes any aviation helmet incorporating headphones and microphone worn by a flight crew member.

NCO.IDE.A.140 Seats, seat safety belts, restraint systems and child restraint devices

Regulation (EU) 2019/1384

- (a) Aeroplanes shall be equipped with:
- (1) a seat or berth for each person on board who is aged 24 months or more;
 - (2) a seat belt on each seat and restraining belts for each berth;
 - (3) a child restraint device (CRD) for each person on board younger than 24 months; and
 - (4) a seat belt with upper torso restraint system on each flight crew seat, having a single point release for aeroplanes having a CofA first issued on or after 25 August 2016.

AMC1 NCO.IDE.A.140 Seats, seat safety belts, restraint systems and child restraint devices

ED Decision 2019/019/R

CHILD RESTRAINT DEVICES (CRDs)

- (a) A CRD is considered to be acceptable if:
- (1) it is a supplementary loop belt manufactured with the same techniques and the same materials as the approved safety belts; or
 - (2) it complies with (b).
- (b) Provided the CRD can be installed properly on the respective aircraft seat, the following CRDs are considered acceptable:
- (1) CRDs approved for use in aircraft according to the European Technical Standard Order ETSO-C100c on Aviation Child Safety Device (ACSD);
 - (2) CRDs approved by EASA through a Type Certificate or Supplemental Type Certificate;
 - (3) Child seats approved for use in motor vehicles on the basis of the technical standard specified in (i). The child seat must be also approved for use in aircraft on the basis of the technical standard specified in either point (ii) or point (iii):
 - (i) UN Standard ECE R44-04 (or 03), or ECE R129 bearing the respective 'ECE R' label; and
 - (ii) German 'Qualification Procedure for Child Restraint Systems for Use in Aircraft' (TÜV/958-01/2001) bearing the label 'For Use in Aircraft'; or
 - (iii) Other technical standard acceptable to the competent authority. The child seat should hold a qualification sign that it can be used in aircraft.
 - (4) Child seats approved for use in motor vehicles and aircraft according to Canadian CMVSS 213/213.1 bearing the respective label;
 - (5) Child seats approved for use in motor vehicles and aircraft according to US FMVSS No 213 and bearing one or two labels displaying the following two sentences:
 - (i) 'THIS CHILD RESTRAINT SYSTEM CONFORMS TO ALL APPLICABLE FEDERAL MOTOR VEHICLE SAFETY STANDARDS'; and
 - (ii) in red letters 'THIS RESTRAINT IS CERTIFIED FOR USE IN MOTOR VEHICLES AND AIRCRAFT';

- (6) Child seats approved for use in motor vehicles and aircraft according to Australia/New Zealand's technical standard AS/NZS 1754:2013 bearing the green part on the label displaying 'For Use in Aircraft'; and
 - (7) CRDs manufactured and tested according to other technical standards equivalent to those listed above. The devices should be marked with an associated qualification sign, which shows the name of the qualification organisation and a specific identification number, related to the associated qualification project. The qualifying organisation should be a competent and independent organisation that is acceptable to the competent authority.
- (c) Location
- (1) Forward-facing child seats may be installed on both forward-and rearward-facing passenger seats, but only when fitted in the same direction as the passenger seat on which they are positioned. Rearward-facing child seats should only be installed on forward-facing passenger seats. A child seat may not be installed within the radius of action of an airbag unless it is obvious that the airbag is de-activated or it can be demonstrated that there is no negative impact from the airbag.
 - (2) An infant/child in a CRD should be located in the vicinity of a floor level exit.
 - (3) An infant/child in a CRD should not hinder evacuation for any passenger.
- (d) Installation
- (1) CRDs tested and approved for use in aircraft should only be installed on a suitable passenger seat by the method shown in the manufacturer's instructions provided with each CRD and with the type of connecting device they are approved for the installation in aircraft. CRDs designed to be installed only by means of rigid bar lower anchorages (ISOFIX or equivalent) should only be used on passenger seats equipped with such connecting devices and should not be secured by passenger seat lap belt.
 - (2) All safety and installation instructions should be followed carefully by the responsible adult accompanying the infant/child. Operators should prohibit the use of a CRD not installed on the passenger seat according to the manufacturer's instructions or not approved for use in aircraft.
 - (3) If a forward-facing child seat with a rigid backrest is to be fastened by a seat lap belt, the restraint device should be fastened when the backrest of the passenger seat on which it rests is in a reclined position. Thereafter, the backrest is to be positioned upright. This procedure ensures better tightening of the child seat on the aircraft seat if the aircraft seat is reclinable.
 - (4) The buckle of the adult safety belt should be easily accessible for both opening and closing, and should be in line with the seat belt halves (not canted) after tightening.
 - (5) Forward-facing restraint devices with an integral harness must not be installed such that the adult safety belt is secured over the infant.
- (e) Operation
- (1) Each CRD should remain secured to a passenger seat during all phases of flight unless it is properly stowed when not in use.
 - (2) Where a child seat is adjustable in recline, it should be in an upright position for all occasions when passenger restraint devices are required.

AMC2 NCO.IDE.A.140 Seats, seat safety belts, restraint systems and child restraint devices

ED Decision 2016/018/R

UPPER TORSO RESTRAINT SYSTEM

- (a) The following systems are deemed to be compliant with the requirement for an upper torso restraint system:
- (1) A seat belt with a diagonal shoulder strap;
 - (2) A restraint system having a seat belt and two shoulder straps that may be used independently;
 - (3) A restraint system having a seat belt, two shoulder straps and additional straps that may be used independently.
- (b) The use of the upper torso restraint independently from the use of the seat belt is intended as an option for the comfort of the occupant of the seat in those phases of flight where only the seat belt is required to be fastened. A restraint system including a seat belt and an upper torso restraint that both remain permanently fastened is also acceptable.

SEAT BELT

A seat belt with a diagonal shoulder strap (three anchorage points) is deemed to be compliant with the requirement for a seat belt (two anchorage points).

NCO.IDE.A.145 First-aid kit

Regulation (EU) No 800/2013

- (a) Aeroplanes shall be equipped with a first-aid kit.
- (b) The first-aid kit shall be:
- (1) readily accessible for use; and
 - (2) kept up-to-date.

AMC1 NCO.IDE.A.145 First-aid kit

ED Decision 2021/005/R

CONTENT OF FIRST-AID KITS

- (a) First-aid kits should be equipped with appropriate and sufficient medications and instrumentation. However, these kits should be supplemented by the operator according to the characteristics of the operation (scope of operation, flight duration, number and demographics of passengers, etc.).
- (b) The following should be included in the FAKs:
- (1) bandages (assorted sizes, including a triangular bandage),
 - (2) burns dressings (large and small),
 - (3) wound dressings (large and small),
 - (4) adhesive dressings (assorted sizes),
 - (5) antiseptic wound cleaner,

- (6) safety scissors,
- (7) disposable gloves,
- (8) disposable resuscitation aid, and
- (9) surgical masks.

AMC2 NCO.IDE.A.145 First-aid kit

ED Decision 2014/016/R

MAINTENANCE OF FIRST-AID KIT

To be kept up-to-date, the first-aid kit should be:

- (a) inspected periodically to confirm, to the extent possible, that contents are maintained in the condition necessary for their intended use;
- (b) replenished at regular intervals, in accordance with instructions contained on their labels, or as circumstances warrant; and
- (c) replenished after use in-flight at the first opportunity where replacement items are available.

GM1 NCO.IDE.A.145 First-aid kit

ED Decision 2021/005/R

LOCATION

The location of the first-aid kit in the cabin is normally indicated using internationally recognisable signs.

GM2 NCO.IDE.A.145 First-aid kit

ED Decision 2021/005/R

CONTENT OF FIRST-AID KITS

The operator may supplement first-aid kits according to the characteristics of the operation based on a risk assessment. The assessment does not require an approval by the competent authority.

NCO.IDE.A.150 Supplemental oxygen – pressurised aeroplanes

Regulation (EU) No 800/2013

- (a) Pressurised aeroplanes operated at flight altitudes for which the oxygen supply is required in accordance with (b) shall be equipped with oxygen storage and dispensing apparatus capable of storing and dispensing the required oxygen supplies.
- (b) Pressurised aeroplanes operated above flight altitudes at which the pressure altitude in the passenger compartments is above 10 000 ft shall carry enough breathing oxygen to supply:
 - (1) all crew members and:
 - (i) 100 % of the passengers for any period when the cabin pressure altitude exceeds 15 000 ft, but in no case less than 10 minutes' supply;
 - (ii) at least 30 % of the passengers, for any period when, in the event of loss of pressurisation and taking into account the circumstances of the flight, the pressure altitude in the passenger compartment will be between 14 000 ft and 15 000 ft; and

- (iii) at least 10 % of the passengers for any period in excess of 30 minutes when the pressure altitude in the passenger compartment will be between 10 000 ft and 14 000 ft;
- and
- (2) all the occupants of the passenger compartment for no less than 10 minutes, in the case of aeroplanes operated at pressure altitudes above 25 000 ft, or operated below that altitude but under conditions that will not allow them to descend safely to a pressure altitude of 13 000 ft within 4 minutes.
- (c) Pressurised aeroplanes operated at flight altitudes above 25 000 ft shall, in addition, be equipped with a device to provide a warning indication to the flight crew of any loss of pressurisation.

AMC1 NCO.IDE.A.150 Supplemental oxygen – pressurised aeroplanes

ED Decision 2014/016/R

DETERMINATION OF OXYGEN

- (a) In the determination of the amount of oxygen for the routes to be flown, it is assumed that the aeroplane will descend in accordance with the emergency procedures specified in the AFM, without exceeding its operating limitations, to a flight altitude that will allow the flight to be completed safely (i.e. flight altitudes ensuring adequate terrain clearance, navigational accuracy, hazardous weather avoidance, etc.).
- (b) The amount of oxygen should be determined on the basis of cabin pressure altitude, flight duration, and on the assumption that a cabin pressurisation failure will occur at the pressure altitude or point of flight that is most critical from the standpoint of oxygen need.
- (c) Following a cabin pressurisation failure, the cabin pressure altitude should be considered to be the same as the aeroplane pressure altitude, unless it can be demonstrated to the competent authority that no probable failure of the cabin or pressurisation system will result in a cabin pressure altitude equal to the aeroplane pressure altitude. Under these circumstances, the demonstrated maximum cabin pressure altitude may be used as a basis for determination of oxygen supply.

NCO.IDE.A.155 Supplemental oxygen – non-pressurised aeroplanes

Regulation (EU) 2016/1119

Non-pressurised aeroplanes operated when an oxygen supply is required in accordance with [NCO.OP.190](#) shall be equipped with oxygen storage and dispensing apparatus capable of storing and dispensing the required oxygen supplies.

AMC1 NCO.IDE.A.155 Supplemental oxygen – non-pressurised aeroplanes

ED Decision 2014/016/R

DETERMINATION OF OXYGEN

- (a) In the determination of the amount of oxygen for the routes to be flown, it is assumed that the aeroplane will operate at a flight altitude that will allow the flight to be completed safely (i.e.

flight altitudes ensuring adequate terrain clearance, navigational accuracy, hazardous weather avoidance, etc.).

- (b) The amount of oxygen should be determined on the basis of cabin pressure altitude and flight duration.

AMC2 NCO.IDE.A.155 Supplemental oxygen supply – non-pressurised aeroplanes

ED Decision 2016/018/R

OXYGEN SUPPLY

The need for oxygen supply, when required by [NCO.OP.190](#), may be met either by means of installed equipment or portable equipment.

NCO.IDE.A.160 Hand fire extinguishers

Regulation (EU) 2018/1975

- (a) Aeroplanes, except ELA1 aeroplanes, shall be equipped with at least one hand fire extinguisher:
 - (1) in the flight crew compartment; and
 - (2) in each passenger compartment that is separate from the flight crew compartment, except if the compartment is readily accessible to the flight crew.
- (b) The type and quantity of extinguishing agent for the required fire extinguishers shall be suitable for the type of fire likely to occur in the compartment where the extinguisher is intended to be used and to minimise the hazard of toxic gas concentration in compartments occupied by persons.

NCO.IDE.A.165 Marking of break-in points

Regulation (EU) No 800/2013

If areas of the aeroplane’s fuselage suitable for break-in by rescue crews in an emergency are marked, such areas shall be marked as shown in Figure 1.

Figure 1
Marking of break-in points

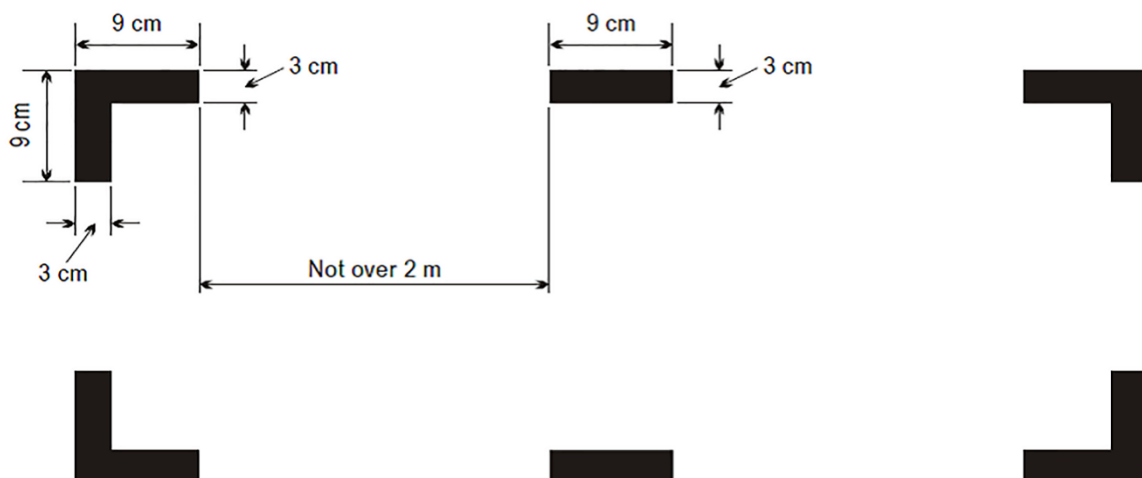

AMC1 NCO.IDE.A.165 Marking of break-in points

ED Decision 2014/016/R

MARKINGS — COLOUR AND CORNERS

- (a) The colour of the markings should be red or yellow and, if necessary, should be outlined in white to contrast with the background.
- (b) If the corner markings are more than 2 m apart, intermediate lines 9 cm x 3 cm should be inserted so that there is no more than 2 m between adjacent markings.

NCO.IDE.A.170 Emergency locator transmitter (ELT)

Regulation (EU) No 800/2013

- (a) Aeroplanes shall be equipped with:
 - (1) an ELT of any type, when first issued with an individual CofA on or before 1 July 2008;
 - (2) an automatic ELT, when first issued with an individual CofA after 1 July 2008; or
 - (3) a survival ELT (ELT(S)) or a personal locator beacon (PLB), carried by a crew member or a passenger, when certified for a maximum passenger seating configuration of six or less.
- (b) ELTs of any type and PLBs shall be capable of transmitting simultaneously on 121,5 MHz and 406 MHz.

AMC1 NCO.IDE.A.170 Emergency locator transmitter (ELT)

ED Decision 2014/016/R

BATTERIES

- (a) All batteries used in ELTs or PLBs should be replaced (or recharged, if the battery is rechargeable) when the equipment has been in use for more than 1 cumulative hour or in the following cases:
 - (1) Batteries specifically designed for use in ELTs and having an airworthiness release certificate (EASA Form 1 or equivalent) should be replaced (or recharged, if the battery is rechargeable) before the end of their useful life in accordance with the maintenance instructions applicable to the ELT.
 - (2) Standard batteries manufactured in accordance with an industry standard and not having an airworthiness release certificate (EASA Form 1 or equivalent), when used in ELTs should be replaced (or recharged, if the battery is rechargeable) when 50 % of their useful life (or for rechargeable, 50 % of their useful life of charge), as established by the battery manufacturer, has expired.
 - (3) All batteries used in PLBs should be replaced (or recharged, if the battery is rechargeable) when 50 % of their useful life (or for rechargeable, 50 % of their useful life of charge), as established by the battery manufacturer, has expired.
 - (4) The battery useful life (or useful life of charge) criteria in (1),(2) and (3) do not apply to batteries (such as water-activated batteries) that are essentially unaffected during probable storage intervals.
- (b) The new expiry date for a replaced (or recharged) battery should be legibly marked on the outside of the equipment.

AMC2 NCO.IDE.A.170 Emergency locator transmitter (ELT)

ED Decision 2021/008/R

TYPES OF ELTs AND GENERAL TECHNICAL SPECIFICATIONS

- (a) The ELT required by this provision should be one of the following:
- (1) Automatic fixed (ELT(AF)). An automatically activated ELT that is permanently attached to an aircraft and is designed to aid search and rescue (SAR) teams in locating the crash site.
 - (2) Automatic portable (ELT(AP)). An automatically activated ELT that is rigidly attached to an aircraft before a crash, but is readily removable from the aircraft after a crash. It functions as an ELT during the crash sequence. If the ELT does not employ an integral antenna, the aircraft-mounted antenna may be disconnected and an auxiliary antenna (stored on the ELT case) attached to the ELT. The ELT can be tethered to a survivor or a life-raft. This type of ELT is intended to aid SAR teams in locating the crash site or survivor(s).
 - (3) Automatic deployable (ELT(AD)). An ELT that is rigidly attached to the aircraft before the crash and that is automatically deployed and activated by an impact, and, in some cases, also by water sensors. This type of ELT should float in water and is intended to aid SAR teams in locating the crash site. The ELT(AD) may be either a stand-alone beacon or an inseparable part of a deployable recorder.
 - (4) Survival ELT (ELT(S)). An ELT that is removable from an aircraft, stowed so as to facilitate its ready use in an emergency and manually activated by a survivor. An ELT(S) may be activated manually or automatically (e.g. by water activation). It should be designed either to be tethered to a life-raft or a survivor. A water-activated ELT(S) is not an ELT(AP).
- (b) To minimise the possibility of damage in the event of crash impact, the automatic ELT should be rigidly fixed to the aircraft structure, as far aft as is practicable, with its antenna and connections arranged so as to maximise the probability of the signal being transmitted after a crash.
- (c) Any ELT carried should operate in accordance with the relevant provisions of ICAO Annex 10, Volume III, and should be registered with the national agency responsible for initiating search and rescue or other nominated agency.

AMC3 NCO.IDE.A.170 Emergency locator transmitter (ELT)

ED Decision 2014/016/R

PLB TECHNICAL SPECIFICATIONS

- (a) A personal locator beacon (PLB) should have a built-in GNSS receiver with a *cosmicheskaya sistyema poiska avariynich sudov* — search and rescue satellite-aided tracking (COSPAS-SARSAT) type approval number. However, devices with a COSPAS-SARSAT number belonging to series 700 are excluded as this series of numbers identifies the special-use beacons not meeting all the technical requirements and all the tests specified by COSPAS-SARSAT.
- (b) Any PLB carried should be registered with the national agency responsible for initiating search and rescue or other nominated agency.

AMC4 NCO.IDE.A.170 Emergency locator transmitter (ELT)

ED Decision 2014/016/R

BRIEFING ON PLB USE

When a PLB is carried by a passenger, he/she should be briefed on its characteristics and use by the pilot-in-command before the flight.

GM1 NCO.IDE.A.170 Emergency locator transmitter (ELT)

ED Decision 2021/008/R

TERMINOLOGY

[GM1 CAT.IDE.A.280](#) contains explanations of terms used in point [NCO.IDE.A.170](#) and in the related AMC.

NCO.IDE.A.175 Flight over water

Regulation (EU) No 800/2013

- (a) The following aeroplanes shall be equipped with a life-jacket for each person on board, or equivalent individual floatation device for each person on board younger than 24 months, that shall be worn or stowed in a position that is readily accessible from the seat or berth of the person for whose use it is provided:
- (1) single-engined landplanes when:
 - (i) flying over water beyond gliding distance from land; or
 - (ii) taking off or landing at an aerodrome or operating site where, in the opinion of the pilot-in-command, the take-off or approach path is so disposed over water that there would be a likelihood of a ditching;
 - (2) seaplanes operated over water; and
 - (3) aeroplanes operated at a distance away from land where an emergency landing is possible greater than that corresponding to 30 minutes at normal cruising speed or 50 NM, whichever is less.
- (b) Seaplanes operated over water shall be equipped with:
- (1) one anchor;
 - (2) one sea anchor (drogue), when necessary to assist in manoeuvring; and
 - (3) equipment for making the sound signals, as prescribed in the International Regulations for Preventing Collisions at Sea, where applicable.
- (c) The pilot-in-command of an aeroplane operated at a distance away from land where an emergency landing is possible greater than that corresponding to 30 minutes at normal cruising speed or 50 NM, whichever is the lesser, shall determine the risks to survival of the occupants of the aeroplane in the event of a ditching, based on which he/she shall determine the carriage of:
- (1) equipment for making the distress signals;
 - (2) life-rafts in sufficient numbers to carry all persons on board, stowed so as to facilitate their ready use in emergency; and

- (3) life-saving equipment, to provide the means of sustaining life, as appropriate to the flight to be undertaken.

AMC1 NCO.IDE.A.175 Flight over water

ED Decision 2014/016/R

ACCESSIBILITY OF LIFE-JACKETS

The life-jacket, if not worn, should be accessible from the seat or berth of the person for whose use it is provided, with a safety belt or a restraint system fastened.

MEANS OF ILLUMINATION FOR LIFE-JACKETS

Each life-jacket or equivalent individual flotation device should be equipped with a means of electric illumination for the purpose of facilitating the location of persons.

RISK ASSESSMENT

- (a) When conducting the risk assessment, the pilot-in-command should base his/her decision, as far as is practicable, on the Implementing Rules and AMCs applicable to the operation of the aeroplane.
- (b) The pilot-in-command should, for determining the risk, take the following operating environment and conditions into account:
 - (1) sea state;
 - (2) sea and air temperatures;
 - (3) the distance from land suitable for making an emergency landing; and
 - (4) the availability of search and rescue facilities.

GM1 NCO.IDE.A.175 Flight over water

ED Decision 2014/016/R

SEAT CUSHIONS

Seat cushions are not considered to be flotation devices.

NCO.IDE.A.180 Survival equipment

Regulation (EU) No 800/2013

Aeroplanes operated over areas in which search and rescue would be especially difficult shall be equipped with such signalling devices and life-saving equipment, including means of sustaining life, as may be appropriate to the area overflown.

AMC1 NCO.IDE.A.180 Survival equipment

ED Decision 2014/016/R

GENERAL

- (a) Aeroplanes operated across land areas in which search and rescue would be especially difficult should be equipped with the following:
 - (1) signalling equipment to make the distress signals;
 - (2) at least one ELT(S) or a PLB, carried by the pilot-in-command or a passenger; and

- (3) additional survival equipment for the route to be flown, taking account of the number of persons on board.
- (b) The additional survival equipment specified in (a)(3) does not need to be carried when the aeroplane remains within a distance from an area where search and rescue is not especially difficult, that corresponds to:
 - (1) 120 minutes at one-engine-inoperative (OEI) cruising speed for aeroplanes capable of continuing the flight to an aerodrome with the critical engine(s) becoming inoperative at any point along the route or planned diversion routes; or
 - (2) 30 minutes at cruising speed for all other aeroplanes.

AMC2 NCO.IDE.A.180 Survival equipment

ED Decision 2014/016/R

ADDITIONAL SURVIVAL EQUIPMENT

- (a) The following additional survival equipment should be carried when required:
 - (1) 500 ml of water for each four, or fraction of four, persons on board;
 - (2) one knife;
 - (3) first-aid equipment; and
 - (4) one set of air/ground codes.
- (b) If any item of equipment contained in the above list is already carried on board the aeroplane in accordance with another requirement, there is no need for this to be duplicated.

GM1 NCO.IDE.A.180 Survival equipment

ED Decision 2014/016/R

SIGNALLING EQUIPMENT

The signalling equipment for making distress signals is described in ICAO Annex 2, Rules of the Air.

GM2 NCO.IDE.A.180 Survival equipment

ED Decision 2014/016/R

AREAS IN WHICH SEARCH AND RESCUE WOULD BE ESPECIALLY DIFFICULT

The expression 'areas in which search and rescue would be especially difficult' should be interpreted, in this context, as meaning:

- (a) areas so designated by the competent authority responsible for managing search and rescue; or
- (b) areas that are largely uninhabited and where:
 - (1) the authority referred to in (a) has not published any information to confirm whether search and rescue would be or would not be especially difficult; and
 - (2) the authority referred to in (a) does not, as a matter of policy, designate areas as being especially difficult for search and rescue.

NCO.IDE.A.190 Radio communication equipment

Regulation (EU) No 800/2013

- (a) Where required by the airspace being flown aeroplanes shall be equipped with radio communication equipment capable of conducting two-way communication with those aeronautical stations and on those frequencies to meet airspace requirements.
- (b) Radio communication equipment, if required by (a), shall provide for communication on the aeronautical emergency frequency 121,5 MHz.
- (c) When more than one communication equipment unit is required, each shall be independent of the other or others to the extent that a failure in any one will not result in failure of any other.

GM1 NCO.IDE.A.190 Radio communication equipment

ED Decision 2014/016/R

APPLICABLE AIRSPACE REQUIREMENTS

For aeroplanes being operated under European air traffic control, the applicable airspace requirements include the Single European Sky legislation.

NCO.IDE.A.195 Navigation equipment

Regulation (EU) 2019/1384

- (a) Aeroplanes operated over routes that cannot be navigated by reference to visual landmarks shall be equipped with any navigation equipment necessary to enable them to proceed in accordance with:
 - (1) the ATS flight plan; if applicable; and
 - (2) the applicable airspace requirements.
- (b) Aeroplanes shall have sufficient navigation equipment to ensure that, in the event of the failure of one item of equipment at any stage of the flight, the remaining equipment shall allow safe navigation in accordance with (a), or an appropriate contingency action, to be completed safely.
- (c) Aeroplanes operated on flights in which it is intended to land in IMC shall be equipped with suitable equipment capable of providing guidance to a point from which a visual landing can be performed. This equipment shall be capable of providing such guidance for each aerodrome at which it is intended to land in IMC and for any designated alternate aerodromes.
- (d) For PBN operations the aircraft shall meet the airworthiness certification requirements for the appropriate navigation specification.
- (e) Aeroplanes shall be equipped with surveillance equipment in accordance with the applicable airspace requirements.

AMC1 NCO.IDE.A.195 Navigation equipment

ED Decision 2014/016/R

NAVIGATION WITH VISUAL REFERENCE TO LANDMARKS

Where aeroplanes, with the surface in sight, can proceed according to the ATS flight plan by navigation with visual reference to landmarks, no additional equipment is needed to comply with [NCO.IDE.A.195\(a\)\(1\)](#).

GM1 NCO.IDE.A.195 Navigation equipment

ED Decision 2016/018/R

AIRCRAFT ELIGIBILITY FOR PBN SPECIFICATION NOT REQUIRING SPECIFIC APPROVAL

- (a) The performance of the aircraft is usually stated in the AFM/POH.
- (b) Where such a reference cannot be found in the AFM/POH, other information provided by the aircraft manufacturer as TC holder, the STC holder or the design organisation having a privilege to approve minor changes may be considered.
- (c) The following documents are considered acceptable sources of information:
 - (1) AFM/POH, supplements thereto, and documents directly referenced in the AFM/POH;
 - (2) FCOM or similar document;
 - (3) Service Bulletin or Service Letter issued by the TC holder or STC holder;
 - (4) approved design data or data issued in support of a design change approval;
 - (5) any other formal document issued by the TC or STC holders stating compliance with PBN specifications, AMC, Advisory Circulars (AC) or similar documents issued by the State of Design; and
 - (6) written evidence obtained from the State of Design.
- (d) Equipment qualification data, in itself, is not sufficient to assess the PBN capabilities of the aircraft, since the latter depend on installation and integration.
- (e) As some PBN equipment and installations may have been certified prior to the publication of the PBN Manual and the adoption of its terminology for the navigation specifications, it is not always possible to find a clear statement of aircraft PBN capability in the AFM/POH. However, aircraft eligibility for certain PBN specifications can rely on the aircraft performance certified for PBN procedures and routes prior to the publication of the PBN Manual.
- (f) Below, various references are listed which may be found in the AFM/POH or other acceptable documents (see listing above) in order to consider the aircraft's eligibility for a specific PBN specification if the specific term is not used.
- (g) RNAV 5
 - (1) If a statement of compliance with any of the following specifications or standards is found in the acceptable documentation as listed above, the aircraft is eligible for RNAV 5 operations.
 - (i) B-RNAV;
 - (ii) RNAV 1;
 - (iii) RNP APCH;
 - (iv) RNP 4;
 - (v) A-RNP;
 - (vi) AMC 20-4;
 - (vii) JAA TEMPORARY GUIDANCE MATERIAL, LEAFLET NO. 2 (TGL 2);
 - (viii) JAA AMJ 20X2;
 - (ix) FAA AC 20-130A for en route operations;

- (x) FAA AC 20-138 for en route operations; and
 - (xi) FAA AC 90-96.
- (h) RNAV 1/RNAV 2
- (1) If a statement of compliance with any of the following specifications or standards is found in the acceptable documentation as listed above, the aircraft is eligible for RNAV 1/RNAV 2 operations.
 - (i) RNAV 1;
 - (ii) PRNAV;
 - (iii) US RNAV type A;
 - (iv) FAA AC 20-138 for the appropriate navigation specification;
 - (v) FAA AC 90-100A;
 - (vi) JAA TEMPORARY GUIDANCE MATERIAL, LEAFLET NO. 10 Rev1 (TGL 10); and
 - (vii) FAA AC 90-100.
 - (2) However, if position determination is exclusively computed based on VOR-DME, the aircraft is not eligible for RNAV 1/RNAV 2 operations.
- (i) RNP 1/RNP 2 continental
- (1) If a statement of compliance with any of the following specifications or standards is found in the acceptable documentation as listed above, the aircraft is eligible for RNP 1/RNP 2 continental operations.
 - (i) A-RNP;
 - (ii) FAA AC 20-138 for the appropriate navigation specification; and
 - (iii) FAA AC 90-105.
 - (2) Alternatively, if a statement of compliance with any of the following specifications or standards is found in the acceptable documentation as listed above and position determination is primarily based on GNSS, the aircraft is eligible for RNP 1/RNP 2 continental operations. However, in these cases, loss of GNSS implies loss of RNP 1/RNP 2 capability.
 - (i) JAA TEMPORARY GUIDANCE MATERIAL, LEAFLET NO. 10 (TGL 10) (any revision); and
 - (ii) FAA AC 90-100.
- (j) RNP APCH — LNAV minima
- (1) If a statement of compliance with any of the following specifications or standards is found in the acceptable documentation as listed above, the aircraft is eligible for RNP APCH — LNAV operations.
 - (i) A-RNP;
 - (ii) AMC 20-27;
 - (iii) AMC 20-28;
 - (iv) FAA AC 20-138 for the appropriate navigation specification; and

- (v) FAA AC 90-105 for the appropriate navigation specification.
- (2) Alternatively, if a statement of compliance with RNP 0.3 GNSS approaches in accordance with any of the following specifications or standards is found in the acceptable documentation as listed above, the aircraft is eligible for RNP APCH — LNAV operations. Any limitation such as ‘within the US National Airspace’ may be ignored since RNP APCH procedures are assumed to meet the same ICAO criteria around the world.
 - (i) JAA TEMPORARY GUIDANCE MATERIAL, LEAFLET NO. 3 (TGL 3);
 - (ii) AMC 20-4;
 - (iii) FAA AC 20-130A; and
 - (iv) FAA AC 20-138.
- (k) RNP APCH — LNAV/VNAV minima
 - (1) If a statement of compliance with any of the following specifications or standards is found in the acceptable documentation as listed above, the aircraft is eligible for RNP APCH — LNAV/VNAV operations.
 - (i) A-RNP;
 - (ii) AMC 20-27 with Baro VNAV;
 - (iii) AMC 20-28;
 - (iv) FAA AC 20-138; and
 - (v) FAA AC 90-105 for the appropriate navigation specification.
 - (2) Alternatively, if a statement of compliance with FAA AC 20-129 is found in the acceptable documentation as listed above, and the aircraft complies with the requirements and limitations of EASA SIB 2014-04¹, the aircraft is eligible for RNP APCH — LNAV/VNAV operations. Any limitation such as ‘within the US National Airspace’ may be ignored since RNP APCH procedures are assumed to meet the same ICAO criteria around the world.
- (l) RNP APCH — LPV minima
 - (1) If a statement of compliance with any of the following specifications or standards is found in the acceptable documentation as listed above, the aircraft is eligible for RNP APCH — LPV operations.
 - (i) AMC 20-28;
 - (ii) FAA AC 20-138 for the appropriate navigation specification; and
 - (iii) FAA AC 90-107.
 - (2) For aircraft that have a TAWS Class A installed and do not provide Mode-5 protection on an LPV approach, the DH is limited to 250 ft.
- (m) RNAV 10
 - (1) If a statement of compliance with any of the following specifications or standards is found in the acceptable documentation as listed above, the aircraft is eligible for RNAV 10 operations.

¹ <http://ad.easa.europa.eu/ad/2014-04>

- (i) RNP 10;
 - (ii) FAA AC 20-138 for the appropriate navigation specification;
 - (iii) AMC 20-12;
 - (iv) FAA Order 8400.12 (or later revision); and
 - (v) FAA AC 90-105.
- (n) RNP 4
- (1) If a statement of compliance with any of the following specifications or standards is found in the acceptable documentation as listed above, the aircraft is eligible for RNP 4 operations.
 - (i) FAA AC 20-138B or later, for the appropriate navigation specification;
 - (ii) FAA Order 8400.33; and
 - (iii) FAA AC 90-105 for the appropriate navigation specification.
- (o) RNP 2 oceanic
- (1) If a statement of compliance with FAA AC 90-105 for the appropriate navigation specification is found in the acceptable documentation as listed above, the aircraft is eligible for RNP 2 oceanic operations.
 - (2) If the aircraft has been assessed eligible for RNP 4, the aircraft is eligible for RNP 2 oceanic.
- (p) Special features
- (1) RF in terminal operations (used in RNP 1 and in the initial segment of the RNP APCH)
 - (i) If a statement of demonstrated capability to perform an RF leg, certified in accordance with any of the following specifications or standards, is found in the acceptable documentation as listed above, the aircraft is eligible for RF in terminal operations.
 - (A) AMC 20-26; and
 - (B) FAA AC 20-138B or later.
 - (ii) If there is a reference to RF and a reference to compliance with AC 90-105, then the aircraft is eligible for such operations.
- (q) Other considerations
- (1) In all cases, the limitations in the AFM/POH need to be checked, in particular the use of AP or FD which can be required to reduce the FTE primarily for RNP APCH, RNAV 1, and RNP 1.
 - (2) Any limitation such as 'within the US National Airspace' may be ignored since RNP APCH procedures are assumed to meet the same ICAO criteria around the world.

GM2 NCO.IDE.A.195 Navigation equipment

ED Decision 2016/018/R

GENERAL

- (a) The PBN specifications for which the aircraft complies with the relevant airworthiness criteria are set out in the AFM/POH, together with any limitations to be observed.
- (b) Because functional and performance requirements are defined for each navigation specification, an aircraft approved for an RNP specification is not automatically approved for all RNAV specifications. Similarly, an aircraft approved for an RNP or RNAV specification having a stringent accuracy requirement (e.g. RNP 0.3 specification) is not automatically approved for a navigation specification having a less stringent accuracy requirement (e.g. RNP 4).

RNP 4

- (c) For RNP 4, at least two LRSs, capable of navigating to RNP 4, and listed in the AFM/POH, may be operational at the entry point of the RNP 4 airspace. If an item of equipment required for RNP 4 operations is unserviceable, then the pilot-in-command may consider an alternate route or diversion for repairs. For multi-sensor systems, the AFM/POH may permit entry if one GNSS sensor is lost after departure, provided one GNSS and one inertial sensor remain available.

AMC1 NCO.IDE.A.195(a) Navigation equipment

ED Decision 2022/012/R

NAVIGATION EQUIPMENT — RNAV SUBSTITUTION

An RNAV system may be used to substitute for conventional navigation aids and radio equipment, without monitoring of the raw data from conventional navigation aids, under the following conditions:

SCOPE OF RNAV SUBSTITUTION

- (a) RNAV substitution may be used in all the phases of flight except:
 - (1) to provide lateral guidance in the FAS of an IAP; and
 - (2) to substitute for DME, if a DME transceiver is either not installed on the aircraft or found to be unserviceable before flight.

SUITABILITY OF THE RNAV SYSTEM FOR RNAV SUBSTITUTION

- (b) The RNAV system should meet:
 - (1) at least the requirements of (E)TSO-C129/-C196/-C145/-C146 (or later equivalent standards); and
 - (2) the requirements of [NCO.OP.116\(a\)](#) for RNAV 1, RNP 1 or RNP APCH as regards its installation in the aircraft.

OPERATING PROCEDURE

- (c) The pilot-in-command is responsible for:
 - (1) ensuring that any procedure and waypoints used are retrieved from a navigation database which meets the requirements of [NCO.IDE.A.205](#);
 - (2) verifying waypoint sequence, reasonableness of track angles, and distances of any overlay procedure used;
 - (3) applying pre-flight procedures associated with GNSS use (e.g. RAIM check if applicable); and

- (4) complying with any limitation on RNAV substitution in the AFM.

PILOT COMPETENCE

- (d) The pilot-in-command should be aware of the limitations of RNAV substitution.

AIRSPACE LIMITATIONS

- (e) RNAV substitution should not be applied on any procedure where RNAV substitution has been indicated as 'not authorised' by an AIP entry or a notice to airmen (NOTAM).

CONTINGENCY PLANNING

- (f) Nothing in this AMC relieves the pilot-in-command from compliance with [NCO.IDE.A.195\(b\)](#) which requires sufficient navigation equipment to ensure that, in the event of the failure of one item of equipment at any stage of the flight, the remaining equipment shall allow safe navigation according to the flight plan, or an appropriate contingency action, to be completed safely.

GM1 NCO.IDE.A.195(a) Navigation equipment

*ED Decision 2022/012/R***NAVIGATION EQUIPMENT — SCOPE OF RNAV SUBSTITUTION**

- (a) Applications of RNAV substitution include use to:
- (1) determine aircraft position relative to or distance from a VOR, marker, DME fix or a named fix defined by a VOR radial or NDB bearing;
 - (2) navigate to or from a VOR, or NDB, except as lateral guidance in the FAS of an IAP;
 - (3) hold over a VOR, NDB, or DME fix;
 - (4) fly an arc based upon DME;
 - (5) fly an overlay of a conventional departure, arrival, approach or route except as lateral guidance in the FAS of an IAP.
- (b) RNAV substitution for ADF, marker and VOR may be used where airborne and/or ground-based equipment is not available.
- (c) RNAV substitution for DME may be used where the ground-based DME transponder is unserviceable or the airborne DME transceiver is found to be unserviceable in flight. Caution must be exercised by the pilot-in-command when calculating and using GNSS distances to the active waypoint as reference points are often different.

GM2 NCO.IDE.A.195(a) Navigation equipment

*ED Decision 2022/012/R***NAVIGATION EQUIPMENT — SUITABILITY OF THE RNAV SYSTEM FOR RNAV SUBSTITUTION**

GNSS (E)TSOs are referenced in [AMC1 NCO.IDE.A.195\(a\)](#) since most of the aircraft conducting NCO are equipped with an RNAV stand-alone system which exclusively bases its positioning on GNSS.

GM3 NCO.IDE.A.195(a) Navigation equipment

ED Decision 2022/012/R

NAVIGATION EQUIPMENT — RNAV SUBSTITUTION — OPERATING PROCEDURE

Although RNAV substitution may not be used for lateral guidance in the FAS, this does not preclude the use of the RNAV system to fly the FAS, provided that raw data from the associated conventional navigation aids is monitored.

AMC1 NCO.IDE.A.195(b) Navigation equipment

ED Decision 2022/012/R

APPROPRIATE CONTINGENCY ACTION

An appropriate contingency action is an alternative offered in [NCO.IDE.A.195\(b\)](#) to completion of the planned flight to a safe landing, either at the planned destination or a destination alternate, using normal procedures and using navigation equipment meeting the requirements of [NCO.IDE.A.100](#), installed for redundancy or as a backup.

The contingency action should be considered before flight and take into account the information identified by flight preparation according to [NCO.OP.135](#). It may depend on the flight and availability of navigation solutions (satellites, ground navaids, etc.) and weather conditions (IMC, VMC) along the flight.

The contingency action addresses partial loss of navigation capability. An appropriate contingency action to meet the requirements of [NCO.IDE.A.195\(b\)](#) does not rely on the performance of any function of the item of equipment whose potential failure is being considered. For example, in considering the failure of a VOR/LOC/DME receiver, none of the functions of that receiver should be relied upon in the contingency action.

Examples of contingency actions include:

- seeking navigational assistance from ATS, using communication, navigation and surveillance systems that remain operational, to enable a safe instrument approach or a safe descent to VMC;
- unusually long periods of dead reckoning.

A contingency action is required such that the failure of one item of navigation equipment has a reasonable likelihood of a safe outcome to the flight, consistent with other risks to which the operation is exposed.

NCO.IDE.A.200 Transponder

Regulation (EU) No 800/2013

Where required by the airspace being flown, aeroplanes shall be equipped with a secondary surveillance radar (SSR) transponder with all the required capabilities.

AMC1 NCO.IDE.A.200 Transponder

ED Decision 2014/016/R

GENERAL

- (a) The secondary surveillance radar (SSR) transponders of aeroplanes being operated under European air traffic control should comply with any applicable Single European Sky legislation.

- (b) If the Single European Sky legislation is not applicable, the SSR transponders should operate in accordance with the relevant provisions of Volume IV of ICAO Annex 10.

NCO.IDE.A.205 Management of aeronautical databases

Regulation (EU) 2016/1119

- (a) Aeronautical databases used on certified aircraft system applications shall meet data quality requirements that are adequate for the intended use of the data.
- (b) The pilot-in-command shall ensure the timely distribution and insertion of current and unaltered aeronautical databases to the aircraft that require them.
- (c) Notwithstanding any other occurrence reporting requirements as defined in Regulation (EU) No 376/2014, the pilot-in-command shall report to the database provider instances of erroneous, inconsistent or missing data that might be reasonably expected to constitute a hazard to flight.

In such cases, the pilot-in-command shall not use the affected data.

AMC1 NCO.IDE.A.205 Management of aeronautical databases

ED Decision 2017/003/R

AERONAUTICAL DATABASES

When the operator of an aircraft uses an aeronautical database that supports an airborne navigation application as a primary means of navigation used to meet the airspace usage requirements, the database provider should be a Type 2 DAT provider certified in accordance with Regulation (EU) 2017/373 or equivalent.

GM1 NCO.IDE.A.205 Management of aeronautical databases

ED Decision 2017/003/R

AERONAUTICAL DATABASE APPLICATIONS

The certification of a Type 2 DAT provider in accordance with Regulation (EU) 2017/373 ensures data integrity and compatibility with the certified aircraft application/equipment.

GM2 NCO.IDE.A.205 Management of aeronautical databases

ED Decision 2017/003/R

TIMELY DISTRIBUTION

The operator should distribute current and unaltered aeronautical databases to all aircraft requiring them in accordance with the validity period of the databases or in accordance with an established procedure if no validity period is defined.

GM3 NCO.IDE.A.205 Management of aeronautical databases

ED Decision 2017/003/R

STANDARDS FOR AERONAUTICAL DATABASES AND DAT PROVIDERS

- (a) A 'Type 2 DAT provider' is an organisation as defined in Article 2(5)(b) of Regulation (EU) 2017/373.

- (b) Equivalent to a certified 'Type 2 DAT provider' is defined in any Aviation Safety Agreement between the European Union and a third country, including any Technical Implementation Procedures, or any Working Arrangements between EASA and the competent authority of a third country.

SECTION 2 – HELICOPTERS

NCO.IDE.H.100 Instruments and equipment – general

Regulation (EU) 2019/1384

- (a) Instruments and equipment required by this Subpart shall be approved in accordance with the applicable airworthiness requirements if they are:
- (1) used by the flight crew to control the flight path;
 - (2) used to comply with [NCO.IDE.H.190](#);
 - (3) used to comply with [NCO.IDE.H.195](#); or
 - (4) installed in the helicopter.
- (b) The following items, when required under this Subpart, do not need an equipment approval:
- (1) independent portable lights;
 - (2) an accurate time piece;
 - (3) first-aid kit;
 - (4) survival and signalling equipment;
 - (5) sea anchor and equipment for mooring;
 - (6) child restraint device;
 - (7) a simple PCDS used by a task specialist as a restraint device.
- (c) Instruments and equipment or accessories not required under Annex VII (Part-NCO), as well as any other equipment that is not required under this Regulation, but carried on a flight, shall comply with the following requirements:
- (1) the information provided by those instruments, equipment or accessories shall not be used by the flight crew members to comply with Annex II to Regulation (EU) 2018/1139 or points [NCO.IDE.H.190](#) and [NCO.IDE.H.195](#) of Annex VII;
 - (2) the instruments and equipment shall not affect the airworthiness of the helicopter, even in the case of failures or malfunction.
- (d) Instruments and equipment shall be readily operable or accessible from the station where the flight crew member that needs to use it is seated.
- (e) All required emergency equipment shall be easily accessible for immediate use.

GM1 NCO.IDE.H.100(a) Instruments and equipment – general

ED Decision 2014/016/R

APPLICABLE AIRWORTHINESS REQUIREMENTS

The applicable airworthiness requirements for approval of instruments and equipment required by this Part are the following:

- (a) Regulation (EU) No 748/2012 for helicopters registered in the EU; and
- (b) Airworthiness requirements of the State of registry for helicopters registered outside the EU.

GM1 NCO.IDE.H.100(b) Instruments and equipment – general

ED Decision 2014/016/R

REQUIRED INSTRUMENTS AND EQUIPMENT THAT DO NOT NEED TO BE APPROVED IN ACCORDANCE WITH THE APPLICABLE AIRWORTHINESS REQUIREMENTS

The functionality of non-installed instruments and equipment required by this Subpart and that do not need an equipment approval, as listed in [NCO.IDE.H.100\(b\)](#), should be checked against recognised industry standards appropriate to the intended purpose. The operator is responsible for ensuring the maintenance of these instruments and equipment.

GM1 NCO.IDE.H.100(c) Instruments and equipment – general

ED Decision 2014/016/R

NOT REQUIRED INSTRUMENTS AND EQUIPMENT THAT DO NOT NEED TO BE APPROVED IN ACCORDANCE WITH THE APPLICABLE AIRWORTHINESS REQUIREMENTS, BUT ARE CARRIED ON A FLIGHT

- (a) The provision of this paragraph does not exempt any installed instrument or item of equipment from complying with the applicable airworthiness requirements. In this case, the installation should be approved as required in the applicable airworthiness requirements and should comply with the applicable Certification Specifications.
- (b) The failure of additional non-installed instruments or equipment not required by this Part or by the applicable airworthiness requirements or any applicable airspace requirements should not adversely affect the airworthiness and/or the safe operation of the helicopter. Examples may be the following:
 - (1) portable electronic flight bag (EFB);
 - (2) portable electronic devices carried by crew members; and
 - (3) non-installed passenger entertainment equipment.

NCO.IDE.H.105 Minimum equipment for flight

Regulation (EU) No 800/2013

A flight shall not be commenced when any of the helicopter's instruments, items of equipment or functions required for the intended flight are inoperative or missing, unless:

- (a) the helicopter is operated in accordance with the MEL, if established; or
- (b) the helicopter is subject to a permit to fly issued in accordance with the applicable airworthiness requirements.

AMC1 NCO.IDE.H.105 Minimum equipment for flight

ED Decision 2021/005/R

MANAGEMENT OF THE STATUS OF CERTAIN INSTRUMENTS, EQUIPMENT OR FUNCTIONS

The operator should control and retain the status of the instruments, equipment or functions required for the intended operation, that are not controlled for the purpose of continuing airworthiness management.

GM1 NCO.IDE.H.105 Minimum equipment for flight

ED Decision 2021/005/R

MANAGEMENT OF THE STATUS OF CERTAIN INSTRUMENTS, EQUIPMENT OR FUNCTIONS

- (a) The operator should define responsibilities and procedures to retain and control the status of instruments, equipment or functions required for the intended operation, that are not controlled for the purpose of continuing airworthiness management.
- (b) Examples of such instruments, equipment or functions may be, but are not limited to, equipment related to navigation approvals as FM immunity or certain software versions.

NCO.IDE.H.115 Operating lights

Regulation (EU) No 800/2013

Helicopters operated at night shall be equipped with:

- (a) an anti-collision light system;
- (b) navigation/position lights;
- (c) a landing light;
- (d) lighting supplied from the helicopter's electrical system to provide adequate illumination for all instruments and equipment essential to the safe operation of the helicopter;
- (e) lighting supplied from the helicopter's electrical system to provide illumination in all passenger compartments;
- (f) an independent portable light for each crew member station; and
- (g) lights to conform with the International Regulations for Preventing Collisions at Sea if the helicopter is amphibious.

AMC1 NCO.IDE.H.115 Operating lights

ED Decision 2014/016/R

LANDING LIGHT

The landing light should be trainable, at least in the vertical plane, or optionally be an additional fixed light or lights positioned to give a wide spread of illumination.

NCO.IDE.H.120 Operations under VFR – flight and navigational instruments and associated equipment

Regulation (EU) 2019/1394 2019/1394

- (a) Helicopters operated under VFR by day shall be equipped with a means of measuring and displaying the following:

- (1) magnetic heading;
 - (2) time in hours, minutes and seconds;
 - (3) barometric altitude;
 - (4) indicated airspeed; and
 - (5) slip.
- (b) Helicopters operated under VMC at night, or when the visibility is less than 1 500 m, or in conditions where the helicopter cannot be maintained in a desired flight path without reference to one or more additional instruments, shall be, in addition to (a), equipped with:
- (1) a means of measuring and displaying the following:
 - (i) attitude;
 - (ii) vertical speed; and
 - (iii) stabilised heading; and
 - (2) a means of indicating when the supply of power to the gyroscopic instruments is not adequate.
- (c) Helicopters operated when the visibility is less than 1 500 m, or in conditions where the helicopter cannot be maintained in a desired flight path without reference to one or more additional instruments, shall be, in addition to (a) and (b), equipped with a means of preventing malfunction of the airspeed indicating system required in (a)(4) due to condensation or icing.

AMC1 NCO.IDE.H.120&NCO.IDE.H.125 Operations under VFR & operations under IFR – flight and navigational instruments and associated equipment

ED Decision 2014/016/R

INTEGRATED INSTRUMENTS

- (a) Individual equipment requirements may be met by combinations of instruments, by integrated flight systems or by a combination of parameters on electronic displays. The information so available to each required pilot should not be less than that required in the applicable operational requirements, and the equivalent safety of the installation should be approved during type certification of the helicopter for the intended type of operation.
- (b) The means of measuring and indicating turn and slip, helicopter attitude and stabilised helicopter heading may be met by combinations of instruments or by integrated flight director systems, provided that the safeguards against total failure, inherent in the three separate instruments, are retained.

AMC1 NCO.IDE.H.120(a)(1)&NCO.IDE.H.125(a)(1) Operations under VFR & operations under IFR – flight and navigational instruments and associated equipment

ED Decision 2014/016/R

MEANS OF MEASURING AND DISPLAYING MAGNETIC HEADING

The means of measuring and displaying magnetic direction should be a magnetic compass or equivalent.

AMC1 NCO.IDE.H.120(a)(2)&NCO.IDE.H.125(a)(2) Operations under VFR & operations under IFR – flight and navigational instruments and associated equipment

ED Decision 2014/016/R

MEANS OF MEASURING AND DISPLAYING THE TIME

A means of measuring and displaying the time in hours, minutes and seconds may be a wrist watch capable of the same functions.

AMC1 NCO.IDE.H.120(a)(3)&NCO.IDE.H.125(a)(3) Operations under VFR & operations under IFR – flight and navigational instruments and associated equipment

ED Decision 2014/016/R

CALIBRATION OF THE MEANS OF MEASURING AND DISPLAYING PRESSURE ALTITUDE

The instrument measuring and displaying pressure altitude should be of a sensitive type calibrated in feet (ft), with a sub-scale setting, calibrated in hectopascals/millibars, adjustable for any barometric pressure likely to be set during flight.

AMC1 NCO.IDE.H.120(a)(5) Operations under VFR – flight and navigational instruments and associated equipment

ED Decision 2014/016/R

SLIP

The means of measuring and displaying slip may be a slip string for operations under VFR.

NCO.IDE.H.125 Operations under IFR – flight and navigational instruments and associated equipment

Regulation (EU) 2019/1384

Helicopters operated under IFR shall be equipped with:

- (a) a means of measuring and displaying the following:
 - (1) magnetic heading;
 - (2) time in hours, minutes and seconds;
 - (3) barometric altitude;

- (4) indicated airspeed;
 - (5) vertical speed;
 - (6) slip;
 - (7) attitude;
 - (8) stabilised heading; and
 - (9) outside air temperature;
- (b) a means of indicating when the supply of power to the gyroscopic instruments is not adequate;
- (c) a means of preventing malfunction of the airspeed indicating system required by (a)(4) due to condensation or icing; and
- (d) an additional means of measuring and displaying attitude as a standby instrument.

GM1 NCO.IDE.H.125(a)(3) Operations under IFR – flight and navigational instruments and associated equipment

ED Decision 2014/016/R

ALTIMETERS

Altimeters with counter drum-pointer or equivalent presentation are considered to be less susceptible to misinterpretation for helicopters operating above 10 000 ft.

AMC1 NCO.IDE.H.120(a)(4)&NCO.IDE.H.125(a)(4) Operations under VFR & operations under IFR – flight and navigational instruments and associated equipment

ED Decision 2015/004/R

CALIBRATION OF THE INSTRUMENT INDICATING AIRSPEED

- (a) The instrument indicating airspeed should be calibrated in knots (kt).
- (b) In the case of helicopters with an MCTOM below 2 000 kg, calibration in kilometres per hour (kph) or in miles per hour (mph) is acceptable when such units are used in the AFM.

AMC1 NCO.IDE.H.120(b)(1)(iii)&NCO.IDE.H.125(a)(8) Operations under VFR & operations under IFR – flight and navigational instruments and associated equipment

ED Decision 2014/016/R

STABILISED HEADING

Stabilised direction should be achieved for VFR flights by a gyroscopic direction indicator, whereas for IFR flights, this should be achieved through a magnetic gyroscopic direction indicator.

AMC1 NCO.IDE.H.120(c)&NCO.IDE.H.125(c) Operations under VFR & Operations under IFR – flight and navigational instruments and associated equipment

ED Decision 2014/016/R

MEANS OF PREVENTING MALFUNCTION DUE TO CONDENSATION OR ICING

The means of preventing malfunction due to either condensation or icing of the airspeed indicating system should be a heated pitot tube or equivalent.

AMC1 NCO.IDE.H.125(a)(9) Operations under IFR – flight and navigational instruments and associated equipment

ED Decision 2014/016/R

MEANS OF DISPLAYING OUTSIDE AIR TEMPERATURE

- (a) The means of displaying outside air temperature should be calibrated in degrees Celsius.
- (b) In the case of helicopters with a maximum certified take-off mass (MCTOM) below 2 000 kg, calibration in degrees Fahrenheit is acceptable, when such unit is used in the AFM.
- (c) The means of displaying outside air temperature may be an air temperature indicator that provides indications that are convertible to outside air temperature.

NCO.IDE.H.126 Additional equipment for single pilot operations under IFR

Regulation (EU) No 800/2013

Helicopters operated under IFR with a single pilot shall be equipped with an autopilot with at least altitude hold and heading mode.

NCO.IDE.H.135 Flight crew interphone system

Regulation (EU) No 800/2013

Helicopters operated by more than one flight crew member shall be equipped with a flight crew interphone system, including headsets and microphones for use by all flight crew members.

AMC1 NCO.IDE.H.135 Flight crew interphone system

ED Decision 2014/016/R

GENERAL

- (a) The flight crew interphone system should not be of a handheld type.
- (b) A headset consists of a communication device which includes two earphones to receive and a microphone to transmit audio signals to the helicopter's communication system. To comply with the minimum performance requirements, the earphones and microphone should match the communication system's characteristics and the flight crew compartment environment. The headset should be adequately adjustable in order to fit the pilot's head. Headset boom microphones should be of the noise cancelling type.

- (c) If the intention is to utilise noise cancelling earphones, the pilot-in-command should ensure that the earphones do not attenuate any aural warnings or sounds necessary for alerting the flight crew on matters related to the safe operation of the helicopter.

GM1 NCO.IDE.H.135 Flight crew interphone system

ED Decision 2014/016/R

HEADSET

The term 'headset' includes any aviation helmet incorporating headphones and microphone worn by a flight crew member.

NCO.IDE.H.140 Seats, seat safety belts, restraint systems and child restraint devices

Regulation (EU) 2019/1384

- (a) Helicopters shall be equipped with:
- (1) a seat or berth for each person on board who is aged 24 months or more, or a station for each crew member or task specialist on board;
 - (2) a seat belt on each passenger seat and restraining belts for each berth, and restraint devices for each station;
 - (3) for helicopters first issued with an individual CofA after 31 December 2012, a seat belt with an upper torso restraint system for each passenger who is aged 24 months or more;
 - (4) a child restraint device for each person on board younger than 24 months; and
 - (5) a seat belt with upper torso restraint system incorporating a device that will automatically restrain the occupant's torso in the event of rapid deceleration on each flight crew seat.
- (b) A seat belt with upper torso restraint system shall have a single point release.

AMC1 NCO.IDE.H.140 Seats, seat safety belts, restraint systems and child restraint devices

ED Decision 2019/019/R

CHILD RESTRAINT DEVICES (CRDs)

- (a) A CRD is considered to be acceptable if:
- (1) it is a supplementary loop belt manufactured with the same techniques and the same materials of the approved safety belts; or
 - (2) it complies with (b).
- (b) Provided the CRD can be installed properly on the respective helicopter seat, the following CRDs are considered acceptable:
- (1) CRDs approved for use in aircraft according to the European Technical Standard Order ETSO-C100c on Aviation Child Safety Device (ACSD);
 - (2) CRDs approved by EASA through a Type Certificate or Supplemental Type Certificate;

- (3) Child seats approved for use in motor vehicles on the basis of the technical standard specified in (i). The child seat must be also approved for use in aircraft on the basis of the technical standard specified in either point (ii) or point (iii):
 - (i) UN Standard ECE R44-04 (or 03), or ECE R129 bearing the respective 'ECE R' label; and
 - (ii) German 'Qualification Procedure for Child Restraint Systems for Use in Aircraft' (TÜV Doc.: TÜV/958-01/2001) bearing the label 'For Use in Aircraft'; or
 - (iii) Other technical standard acceptable to the competent authority. The child seat should hold a qualification sign that it can be used in aircraft.
 - (4) Child seats approved for use in motor vehicles and aircraft according to Canadian CMVSS 213/213.1 bearing the respective label;
 - (5) Child seats approved for use in motor vehicles and aircraft according to US FMVSS No 213 and bearing one or two labels displaying the following two sentences:
 - (i) 'THIS CHILD RESTRAINT SYSTEM CONFORMS TO ALL APPLICABLE FEDERAL MOTOR VEHICLE SAFETY STANDARDS'; and
 - (ii) in red letters 'THIS RESTRAINT IS CERTIFIED FOR USE IN MOTOR VEHICLES AND AIRCRAFT';
 - (6) Child seats approved for use in motor vehicles and aircraft according to Australia/New Zealand's technical standard AS/NZS 1754:2013 bearing the green part on the label displaying 'For Use in Aircraft'; and
 - (7) CRDs manufactured and tested according to other technical standards equivalent to those listed above. The devices should be marked with an associated qualification sign, which shows the name of the qualification organisation and a specific identification number, related to the associated qualification project. The qualifying organisation should be a competent and independent organisation that is acceptable to the competent authority.
- (c) Location
- (1) Forward-facing child seats may be installed on both forward- and rearward-facing passenger seats, but only when fitted in the same direction as the passenger seat on which they are positioned. Rearward-facing child seats should only be installed on forward-facing passenger seats. A child seat may not be installed within the radius of action of an airbag unless it is obvious that the airbag is de-activated or it can be demonstrated that there is no negative impact from the airbag.
 - (2) An infant/child in a CRD should be located in the vicinity of a floor level exit.
 - (3) An infant/child in a CRD should not hinder evacuation for any passenger.
- (d) Installation
- (1) CRDs tested and approved for use in aircraft should only be installed on a suitable passenger seat by the method shown in the manufacturer's instructions provided with each CRD and with the type of connecting device they are approved for the installation in aircraft. CRDs designed to be installed only by means of rigid bar lower anchorages (ISOFIX or equivalent) should only be used on passenger seats equipped with such connecting devices and should not be secured by passenger seat lap belt.

- (2) All safety and installation instructions should be followed carefully by the responsible person accompanying the infant/child. Operators should prohibit the use of a CRD not installed on the passenger seat according to the manufacturer's instructions or not approved for use in aircraft.
 - (3) If a forward-facing child seat with a rigid backrest is to be fastened by a seat lap belt, the restraint device should be fastened when the backrest of the passenger seat on which it rests is in a reclined position. Thereafter, the backrest is to be positioned upright. This procedure ensures better tightening of the child seat on the aircraft seat if the aircraft seat is reclinable.
 - (4) The buckle of the adult safety belt should be easily accessible for both opening and closing, and should be in line with the seat belt halves (not canted) after tightening.
 - (5) Forward-facing restraint devices with an integral harness must not be installed such that the adult safety belt is secured over the infant.
- (e) Operation
- (1) Each CRD should remain secured to a passenger seat during all phases of flight, unless it is properly stowed when not in use.
 - (2) Where a child seat is adjustable in recline, it should be in an upright position for all occasions when passenger restraint devices are required.

AMC2 NCO.IDE.H.140 Seats, seat safety belts, restraint systems and child restraint devices

ED Decision 2014/016/R

UPPER TORSO RESTRAINT SYSTEM

The following systems are deemed to be compliant with the requirement for an upper torso restraint system:

- (a) a seat belt with a diagonal shoulder strap;
- (b) a restraint system having a seat belt and two shoulder straps that may be used independently;
- (c) a restraint system having a seat belt, two shoulder straps and additional straps that may be used independently.

SEAT BELT

A seat belt with diagonal shoulder strap (three anchorage points) is deemed to be compliant with the requirement for a seat belt (two anchorage points).

NCO.IDE.H.145 First-aid kit

Regulation (EU) No 800/2013

- (a) Helicopters shall be equipped with a first-aid kit.
- (b) The first-aid kit shall be:
 - (1) readily accessible for use; and
 - (2) kept up-to-date.

AMC1 NCO.IDE.H.145 First-aid kit

ED Decision 2021/005/R

CONTENT OF FIRST-AID KITS

- (a) First-aid kits should be equipped with appropriate and sufficient medications and instrumentation. However, these kits should be supplemented by the operator according to the characteristics of the operation (scope of operation, flight duration, number and demographics of passengers, etc.).
- (b) The following should be included in the FAKs:
 - (1) bandages (assorted sizes, including a triangular bandage),
 - (2) burns dressings (large and small),
 - (3) wound dressings (large and small),
 - (4) adhesive dressings (assorted sizes),
 - (5) antiseptic wound cleaner,
 - (6) safety scissors,
 - (7) disposable gloves,
 - (8) disposable resuscitation aid, and
 - (9) surgical masks.

AMC2 NCO.IDE.H.145 First-aid kit

ED Decision 2014/016/R

MAINTENANCE OF FIRST-AID KIT

To be kept up-to-date, the first-aid kit should be:

- (a) inspected periodically to confirm, to the extent possible, that contents are maintained in the condition necessary for their intended use;
- (b) replenished at regular intervals, in accordance with instructions contained on their labels, or as circumstances warrant; and
- (c) replenished after use in-flight at the first opportunity where replacement items are available.

GM1 NCO.IDE.H.145 First-aid kit

ED Decision 2021/005/R

LOCATION AND USE

The location of the first-aid kit is normally indicated using internationally recognisable signs.

The FAK 'should be readily accessible for use' in helicopter operations should be understood as the first-aid kit being either accessible in flight or immediately after landing.

In some operations, it is not practicable to use the first-aid kit during flight. Therefore, the first-aid kit can be carried in the cargo compartment, where it will be easily accessible for use as soon as the aircraft has landed, when the following conditions are met:

- (a) precautionary landing sites are available;
- (b) the lack of cabin space is such that movement or use of the first-aid kit is impaired; and

- (c) the installation of the first-aid kit in the cabin is not practicable.

GM2 NCO.IDE.H.145 First-aid kit

ED Decision 2021/005/R

CONTENT OF FIRST-AID KITS

The operator may supplement first-aid kits according to the characteristics of the operation based on a risk assessment. The assessment does not require an approval by the competent authority.

NCO.IDE.H.155 Supplemental oxygen – non-pressurised helicopters

Regulation (EU) 2016/1119

Non-pressurised helicopters operated when an oxygen supply is required in accordance with [NCO.OP.190](#) shall be equipped with oxygen storage and dispensing apparatus capable of storing and dispensing the required oxygen supplies.

AMC1 NCO.IDE.H.155 Supplemental oxygen – non-pressurised helicopters

ED Decision 2014/016/R

DETERMINATION OF OXYGEN

The amount of oxygen should be determined on the basis of cabin pressure altitude and flight duration, consistent with the operating procedures, including emergency procedures, established for each operation and the routes to be flown as specified in the AFM.

AMC2 NCO.IDE.H.155 Supplemental oxygen supply – non-pressurised helicopters

ED Decision 2016/018/R

OXYGEN SUPPLY

The need for oxygen supply, when required by [NCO.OP.190](#), may be met either by means of installed equipment or portable equipment.

NCO.IDE.H.160 Hand fire extinguishers

Regulation (EU) No 800/2013

- (a) Helicopters, except ELA2 helicopters, shall be equipped with at least one hand fire extinguisher:
- (1) in the flight crew compartment; and
 - (2) in each passenger compartment that is separate from the flight crew compartment, except if the compartment is readily accessible to the flight crew.
- (b) The type and quantity of extinguishing agent for the required fire extinguishers shall be suitable for the type of fire likely to occur in the compartment where the extinguisher is intended to be used and to minimise the hazard of toxic gas concentration in compartments occupied by persons.

NCO.IDE.H.165 Marking of break-in points

Regulation (EU) No 800/2013

If areas of the helicopter's fuselage suitable for break-in by rescue crews in an emergency are marked, such areas shall be marked as shown in Figure 1.

Figure 1

Marking of break-in points

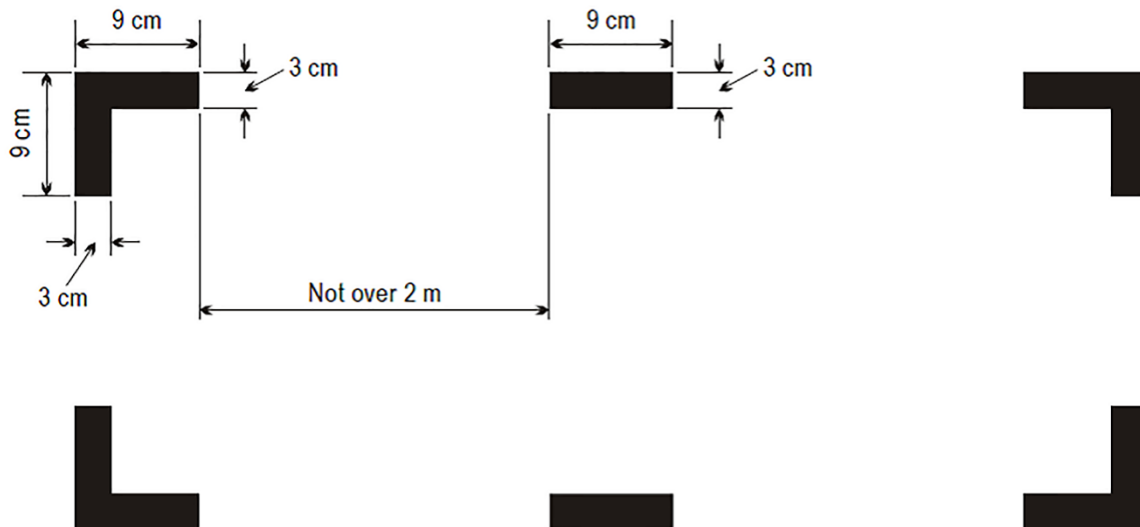

AMC1 NCO.IDE.H.165 Marking of break-in points

ED Decision 2014/016/R

MARKINGS — COLOUR AND CORNERS

- (a) The colour of the markings should be red or yellow and, if necessary, should be outlined in white to contrast with the background.
- (b) If the corner markings are more than 2 m apart, intermediate lines 9 cm x 3 cm should be inserted so that there is no more than 2 m between adjacent markings.

NCO.IDE.H.170 Emergency locator transmitter (ELT)

Regulation (EU) No 800/2013

- (a) Helicopters certified for a maximum passenger seating configuration above six shall be equipped with:
 - (1) an automatic ELT; and
 - (2) one survival ELT (ELT(S)) in a life-raft or life-jacket when the helicopter is operated at a distance from land corresponding to more than 3 minutes flying time at normal cruising speed.
- (b) Helicopters certified for a maximum passenger seating configuration of six or less shall be equipped with an ELT(S) or a personal locator beacon (PLB), carried by a crew member or a passenger.

- (c) ELTs of any type and PLBs shall be capable of transmitting simultaneously on 121,5 MHz and 406 MHz.

AMC1 NCO.IDE.H.170 Emergency locator transmitter (ELT)

ED Decision 2014/016/R

BATTERIES

- (a) All batteries used in ELTs or PLBs should be replaced (or recharged, if the battery is rechargeable) when the equipment has been in use for more than 1 cumulative hour or in the following cases:
- (1) Batteries specifically designed for use in ELTs and having an airworthiness release certificate (EASA Form 1 or equivalent) should be replaced (or recharged, if the battery is rechargeable) before the end of their useful life in accordance with the maintenance instructions applicable to the ELT.
 - (2) Standard batteries manufactured in accordance with an industry standard and not having an airworthiness release certificate (EASA Form 1 or equivalent), when used in ELTs should be replaced (or recharged, if the battery is rechargeable) when 50 % of their useful life (or for rechargeable, 50 % of their useful life of charge), as established by the battery manufacturer, has expired.
 - (3) All batteries used in PLBs should be replaced (or recharged, if the battery is rechargeable) when 50 % of their useful life (or for rechargeable, 50 % of their useful life of charge), as established by the battery manufacturer, has expired.
 - (4) The battery useful life (or useful life of charge) criteria in (1),(2) and (3) do not apply to batteries (such as water-activated batteries) that are essentially unaffected during probable storage intervals.
- (b) The new expiry date for a replaced (or recharged) battery should be legibly marked on the outside of the equipment.

AMC2 NCO.IDE.H.170 Emergency locator transmitter (ELT)

ED Decision 2021/008/R

TYPES OF ELT AND GENERAL TECHNICAL SPECIFICATIONS

- (a) The ELT required by this provision should be one of the following:
- (1) Automatic fixed (ELT(AF)). An automatically activated ELT that is permanently attached to an aircraft and is designed to aid SAR teams in locating the crash site.
 - (2) Automatic portable (ELT(AP)). An automatically activated ELT that is rigidly attached to an aircraft before a crash, but is readily removable from the aircraft after a crash. It functions as an ELT during the crash sequence. If the ELT does not employ an integral antenna, the aircraft-mounted antenna may be disconnected and an auxiliary antenna (stored on the ELT case) attached to the ELT. The ELT can be tethered to a survivor or a life-raft. This type of ELT is intended to aid SAR teams in locating the crash site or survivor(s).
 - (3) Automatic deployable (ELT(AD)). An ELT that is rigidly attached to the aircraft before the crash and that is automatically deployed and activated by an impact, and, in some cases, also by water sensors. This type of ELT should float in water and is intended to aid SAR

teams in locating the crash site. The ELT(AD) may be either a stand-alone beacon or an inseparable part of a deployable recorder.

- (4) Survival ELT (ELT(S)). An ELT that is removable from an aircraft, stowed so as to facilitate its ready use in an emergency, and manually activated by a survivor. An ELT(S) may be activated manually or automatically (e.g. by water activation). It should be designed either to be tethered to a life-raft or a survivor. A water-activated ELT(S) is not an ELT(AP).
- (b) To minimise the possibility of damage in the event of crash impact, the automatic ELT should be rigidly fixed to the aircraft structure, as far aft as is practicable, with its antenna and connections arranged so as to maximise the probability of the signal being transmitted after a crash.
- (c) Any ELT carried should operate in accordance with the relevant provisions of ICAO Annex 10, Volume III, and should be registered with the national agency responsible for initiating search and rescue or other nominated agency.

AMC3 NCO.IDE.H.170 Emergency locator transmitter (ELT)

ED Decision 2014/016/R

PLB TECHNICAL SPECIFICATIONS

- (a) A personal locator beacon (PLB) should have a built-in GNSS receiver with a *cosmicheskaya sistyema poiska aviarynich sudov* — search and rescue satellite-aided tracking (COSPAS-SARSAT) type approval number. However, devices with a COSPAS-SARSAT number belonging to series 700 are excluded as this series of numbers identifies the special-use beacons not meeting all the technical requirements and all the tests specified by COSPAS-SARSAT.
- (b) Any PLB carried should be registered with the national agency responsible for initiating search and rescue or other nominated agency.

AMC4 NCO.IDE.H.170 Emergency locator transmitter (ELT)

ED Decision 2014/016/R

BRIEFING ON PLB USE

When a PLB is carried by a passenger, he/she should be briefed on its characteristics and use by the pilot-in-command before the flight.

GM1 NCO.IDE.H.170 Emergency locator transmitter (ELT)

ED Decision 2021/008/R

TERMINOLOGY

[GM1 CAT.IDE.H.280](#) contains explanations of terms used in point [NCO.IDE.H.170](#) and in the related AMC.

NCO.IDE.H.175 Flight over water

Regulation (EU) No 800/2013

- (a) Helicopters shall be equipped with a life-jacket for each person on board or equivalent individual flotation device for each person on board younger than 24 months, which shall be worn or stowed in a position that is readily accessible from the seat or berth of the person for whose use it is provided, when:

- (1) flying over water beyond autorotational distance from land where in case of the critical engine failure, the helicopter is not able to sustain level flight; or
 - (2) flying over water at a distance of land corresponding to more than 10 minutes flying at normal cruising speed, where in case of the critical engine failure, the helicopter is able to sustain level flight; or
 - (3) taking off or landing at an aerodrome/operating site where the take-off or approach path is over water.
- (b) Each life-jacket or equivalent individual flotation device shall be equipped with a means of electric illumination for the purpose of facilitating the location of persons.
- (c) The pilot-in-command of a helicopter operated on a flight over water at a distance from land corresponding to more than 30 minutes flying time at normal cruising speed or 50 NM, whichever is less, shall determine the risks to survival of the occupants of the helicopter in the event of a ditching, based on which he/she shall determine the carriage of:
- (1) equipment for making the distress signals;
 - (2) life-rafts in sufficient numbers to carry all persons on board, stowed so as to facilitate their ready use in emergency; and
 - (3) life-saving equipment, to provide the means of sustaining life, as appropriate to the flight to be undertaken.
- (d) The pilot-in-command shall determine the risks to survival of the occupants of the helicopter in the event of a ditching, when deciding if the life-jackets required in (a) shall be worn by all occupants.

AMC1 NCO.IDE.H.175 Flight over water

ED Decision 2014/016/R

ACCESSIBILITY OF LIFE-JACKETS

The life-jacket, if not worn, should be accessible from the seat or berth of the person for whose use it is provided, with a safety belt or a restraint system fastened.

RISK ASSESSMENT

- (a) When conducting the risk assessment, the pilot-in-command should base his/her decision, as far as is practicable, on the Implementing Rules and AMCs applicable to the operation of the helicopter.
- (b) The pilot-in-command should, for determining the risk, take the following operating environment and conditions into account:
 - (1) sea state;
 - (2) sea and air temperatures;
 - (3) the distance from land suitable for making an emergency landing; and
 - (4) the availability of search and rescue facilities.

GM1 NCO.IDE.H.175 Flight over water

ED Decision 2014/016/R

SEAT CUSHIONS

Seat cushions are not considered to be flotation devices.

NCO.IDE.H.180 Survival equipment

Regulation (EU) No 800/2013

Helicopters, operated over areas in which search and rescue would be especially difficult, shall be equipped with such signalling devices and life-saving equipment, including means of sustaining life, as may be appropriate to the area overflown.

AMC1 NCO.IDE.H.180 Survival equipment

ED Decision 2014/016/R

GENERAL

Helicopters operated across areas in which search and rescue would be especially difficult should be equipped with the following:

- (a) signalling equipment to make the distress signals;
- (b) at least one ELT(S) or a PLB, carried by the pilot-in-command or a passenger; and
- (c) additional survival equipment for the route to be flown taking account of the number of persons on board.

AMC2 NCO.IDE.H.180 Survival equipment

ED Decision 2014/016/R

ADDITIONAL SURVIVAL EQUIPMENT

- (a) The following additional survival equipment should be carried when required:
 - (1) 500 ml of water for each four, or fraction of four, persons on board;
 - (2) one knife;
 - (3) first-aid equipment; and
 - (4) one set of air/ground codes.
- (b) If any item of equipment contained in the above list is already carried on board the helicopter in accordance with another requirement, there is no need for this to be duplicated.

GM1 NCO.IDE.H.180 Survival equipment

ED Decision 2014/016/R

SIGNALLING EQUIPMENT

The signalling equipment for making distress signals is described in ICAO Annex 2, Rules of the Air.

GM2 NCO.IDE.H.180 Survival equipment

ED Decision 2014/016/R

AREAS IN WHICH SEARCH AND RESCUE WOULD BE ESPECIALLY DIFFICULT

The expression 'areas in which search and rescue would be especially difficult' should be interpreted, in this context, as meaning:

- (a) areas so designated by the competent authority responsible for managing search and rescue; or
- (b) areas that are largely uninhabited and where:
 - (1) the authority referred to in (a) has not published any information to confirm whether search and rescue would be or would not be especially difficult; and
 - (2) the authority referred to in (a) does not, as a matter of policy, designate areas as being especially difficult for search and rescue.

NCO.IDE.H.185 All helicopters on flights over water – ditching

Regulation (EU) 2019/1384

Helicopters flying over water in a hostile environment beyond a distance of 50 NM from land shall be either of the following:

- (a) designed for landing on water in accordance with the relevant certification specifications;
- (b) certified for ditching in accordance with the relevant certification specifications;
- (c) fitted with emergency flotation equipment.

AMC1 NCO.IDE.H.185 All helicopters on flights over water – ditching

ED Decision 2016/022/R

The considerations of [AMC1 SPA.HOFO.165\(d\)](#) should apply in respect of emergency flotation equipment.

NCO.IDE.H.190 Radio communication equipment

Regulation (EU) No 800/2013

- (a) Where required by the airspace being flown helicopters shall be equipped with radio communication equipment capable of conducting two-way communication with those aeronautical stations and on those frequencies to meet airspace requirements.
- (b) Radio communication equipment, if required by (a), shall provide for communication on the aeronautical emergency frequency 121,5 MHz.
- (c) When more than one communications equipment unit is required, each shall be independent of the other or others to the extent that a failure in any one will not result in failure of any other.
- (d) When a radio communication system is required, and in addition to the flight crew interphone system required in [NCO.IDE.H.135](#), helicopters shall be equipped with a transmit button on the flight controls for each required pilot and/or crew member at his/her working station.

NCO.IDE.H.195 Navigation equipment

Regulation (EU) 2019/1384

- (a) Helicopters operated over routes that cannot be navigated by reference to visual landmarks shall be equipped with navigation equipment that will enable them to proceed in accordance with:
 - (1) the ATS flight plan, if applicable; and
 - (2) the applicable airspace requirements.
- (b) Helicopters shall have sufficient navigation equipment to ensure that, in the event of the failure of one item of equipment at any stage of the flight, the remaining equipment shall allow safe navigation in accordance with (a), or an appropriate contingency action, to be completed safely.
- (c) Helicopters operated on flights in which it is intended to land in IMC shall be equipped with navigation equipment capable of providing guidance to a point from which a visual landing can be performed. This equipment shall be capable of providing such guidance for each aerodrome at which is intended to land in IMC and for any designated alternate aerodromes.
- (d) For PBN operations the aircraft shall meet the airworthiness certification requirements for the appropriate navigation specification.
- (e) Helicopters shall be equipped with surveillance equipment in accordance with the applicable airspace requirements.

AMC1 NCO.IDE.H.195 Navigation equipment

ED Decision 2014/016/R

NAVIGATION WITH VISUAL REFERENCE TO LANDMARKS

Where helicopters, with the surface in sight, can proceed according to the ATS flight plan by navigation with visual reference to landmarks, no additional equipment is needed to comply [NCO.IDE.H.195\(a\)\(1\)](#).

GM1 NCO.IDE.H.195 Navigation equipment

ED Decision 2014/016/R

APPLICABLE AIRSPACE REQUIREMENTS

For helicopters being operated under European air traffic control, the applicable airspace requirements include the Single European Sky legislation.

GM2 NCO.IDE.H.195 Navigation equipment

ED Decision 2016/018/R

AIRCRAFT ELIGIBILITY FOR PBN SPECIFICATION NOT REQUIRING SPECIFIC APPROVAL

- (a) The performance of the aircraft is usually stated in the AFM/POH.
- (b) Where such a reference cannot be found in the AFM/POH, other information provided by the aircraft manufacturer as TC holder, the STC holder or the design organisation having a privilege to approve minor changes may be considered.
- (c) The following documents are considered acceptable sources of information:
 - (1) AFM/POH, supplements thereto, and documents directly referenced in the AFM/POH;

-
- (2) FCOM or similar document;
 - (3) Service Bulletin or Service Letter issued by the TC holder or STC holder;
 - (4) approved design data or data issued in support of a design change approval;
 - (5) any other formal document issued by the TC or STC holders stating compliance with PBN specifications, AMC, Advisory Circulars (AC) or similar documents issued by the State of Design; and
 - (6) written evidence obtained from the State of Design.
- (d) Equipment qualification data, in itself, is not sufficient to assess the PBN capabilities of the aircraft, since the latter depend on installation and integration.
- (e) As some PBN equipment and installations may have been certified prior to the publication of the PBN Manual and the adoption of its terminology for the navigation specifications, it is not always possible to find a clear statement of aircraft PBN capability in the AFM/POH. However, aircraft eligibility for certain PBN specifications can rely on the aircraft performance certified for PBN procedures and routes prior to the publication of the PBN Manual.
- (f) Below, various references are listed which may be found in the AFM/POH or other acceptable documents (see listing above) in order to consider the aircraft's eligibility for a specific PBN specification if the specific term is not used.
- (g) RNAV 5
- (1) If a statement of compliance with any of the following specifications or standards is found in the acceptable documentation as listed above, the aircraft is eligible for RNAV 5 operations.
 - (i) B-RNAV;
 - (ii) RNAV 1;
 - (iii) RNP APCH;
 - (iv) RNP 4;
 - (v) A-RNP;
 - (vi) AMC 20-4;
 - (vii) JAA TEMPORARY GUIDANCE MATERIAL, LEAFLET NO. 2 (TGL 2)
 - (viii) JAA AMJ 20X2;
 - (ix) FAA AC 20-130A for en route operations;
 - (x) FAA AC 20-138 for en route operations; and
 - (xi) FAA AC 90-96.
- (h) RNAV 1/RNAV 2
- (1) If a statement of compliance with any of the following specifications or standards is found in the acceptable documentation as listed above, the aircraft is eligible for RNAV 1/RNAV 2 operations.
 - (i) RNAV 1;
 - (ii) PRNAV;
 - (iii) US RNAV type A;

- (iv) FAA AC 20-138 for the appropriate navigation specification;
 - (v) FAA AC 90-100A;
 - (vi) JAA TEMPORARY GUIDANCE MATERIAL, LEAFLET NO. 10 Rev1 (TGL 10); and
 - (vii) FAA AC 90-100.
 - (2) However, if position determination is exclusively computed based on VOR-DME, the aircraft is not eligible for RNAV 1/RNAV 2 operations.
- (i) RNP 1/RNP 2 continental
- (1) If a statement of compliance with any of the following specifications or standards is found in the acceptable documentation as listed above, the aircraft is eligible for RNP 1/RNP 2 continental operations.
 - (i) A-RNP;
 - (ii) FAA AC 20-138 for the appropriate navigation specification; and
 - (iii) FAA AC 90-105.
 - (2) Alternatively, if a statement of compliance with any of the following specifications or standards is found in the acceptable documentation as listed above and position determination is primarily based on GNSS, the aircraft is eligible for RNP 1/RNP 2 continental operations. However, in these cases, loss of GNSS implies loss of RNP 1/RNP 2 capability.
 - (i) JAA TEMPORARY GUIDANCE MATERIAL, LEAFLET NO. 10 (TGL 10) (any revision); and
 - (ii) FAA AC 90-100.
- (j) RNP APCH — LNAV minima
- (1) If a statement of compliance with any of the following specifications or standards is found in the acceptable documentation as listed above, the aircraft is eligible for RNP APCH — LNAV operations.
 - (i) A-RNP;
 - (ii) AMC 20-27;
 - (iii) AMC 20-28;
 - (iv) FAA AC 20-138 for the appropriate navigation specification; and
 - (v) FAA AC 90-105 for the appropriate navigation specification.
 - (2) Alternatively, if a statement of compliance with RNP 0.3 GNSS approaches in accordance with any of the following specifications or standards is found in the acceptable documentation as listed above, the aircraft is eligible for RNP APCH — LNAV operations. Any limitation such as ‘within the US National Airspace’ may be ignored since RNP APCH procedures are assumed to meet the same ICAO criteria around the world.
 - (i) JAA TEMPORARY GUIDANCE MATERIAL, LEAFLET NO. 3 (TGL 3);
 - (ii) AMC 20-4;
 - (iii) FAA AC 20-130A; and
 - (iv) FAA AC 20-138.

-
- (k) RNP APCH — LNAV/VNAV minima
- (1) If a statement of compliance with any of the following specifications or standards is found in the acceptable documentation as listed above, the aircraft is eligible for RNP APCH — LNAV/VNAV operations.
 - (i) A-RNP;
 - (ii) AMC 20-27 with Baro VNAV;
 - (iii) AMC 20-28;
 - (iv) FAA AC 20-138; and
 - (v) FAA AC 90-105 for the appropriate navigation specification.
 - (2) Alternatively, if a statement of compliance with FAA AC 20-129 is found in the acceptable documentation as listed above, and the aircraft complies with the requirements and limitations of EASA SIB 2014-04¹, the aircraft is eligible for RNP APCH — LNAV/VNAV operations. Any limitation such as ‘within the US National Airspace’ may be ignored since RNP APCH procedures are assumed to meet the same ICAO criteria around the world.
- (l) RNP APCH — LPV minima
- (1) If a statement of compliance with any of the following specifications or standards is found in the acceptable documentation as listed above, the aircraft is eligible for RNP APCH — LPV operations.
 - (i) AMC 20-28;
 - (ii) FAA AC 20-138 for the appropriate navigation specification; and
 - (iii) FAA AC 90-107.
 - (2) For aircraft that have a TAWS Class A installed and do not provide Mode-5 protection on an LPV approach, the DH is limited to 250 ft.
- (m) RNAV 10
- (1) If a statement of compliance with any of the following specifications or standards is found in the acceptable documentation as listed above, the aircraft is eligible for RNAV 10 operations.
 - (i) RNP 10;
 - (ii) FAA AC 20-138 for the appropriate navigation specification;
 - (iii) AMC 20-12;
 - (iv) FAA Order 8400.12 (or later revision); and
 - (v) FAA AC 90-105.
- (n) RNP 4
- (1) If a statement of compliance with any of the following specifications or standards is found in the acceptable documentation as listed above, the aircraft is eligible for RNP 4 operations.
 - (i) FAA AC 20-138B or later, for the appropriate navigation specification;

¹ <http://ad.easa.europa.eu/ad/2014-04>

- (ii) FAA Order 8400.33; and
 - (iii) FAA AC 90-105 for the appropriate navigation specification.
- (o) RNP 2 oceanic
- (1) If a statement of compliance with FAA AC 90-105 for the appropriate navigation specification is found in the acceptable documentation as listed above, the aircraft is eligible for RNP 2 oceanic operations.
 - (2) If the aircraft has been assessed eligible for RNP 4, the aircraft is eligible for RNP 2 oceanic.
- (p) Special features
- (1) RF in terminal operations (used in RNP 1 and in the initial segment of the RNP APCH)
 - (i) If a statement of demonstrated capability to perform an RF leg, certified in accordance with any of the following specifications or standards, is found in the acceptable documentation as listed above, the aircraft is eligible for RF in terminal operations:
 - (A) AMC 20-26; and
 - (B) FAA AC 20-138B or later.
 - (ii) If there is a reference to RF and a reference to compliance with AC 90-105, then the aircraft is eligible for such operations.
- (q) Other considerations
- (1) In all cases, the limitations in the AFM/POH need to be checked, in particular the use of AP or FD which can be required to reduce the FTE primarily for RNP APCH, RNAV 1, and RNP 1.
 - (2) Any limitation such as 'within the US National Airspace' may be ignored since RNP APCH procedures are assumed to meet the same ICAO criteria around the world.

GM3 NCO.IDE.H.195 Navigation equipment

ED Decision 2016/018/R

GENERAL

- (a) The PBN specifications for which the aircraft complies with the relevant airworthiness criteria are set out in the AFM/POH, together with any limitations to be observed.
- (b) Because functional and performance requirements are defined for each navigation specification, an aircraft approved for an RNP specification is not automatically approved for all RNAV specifications. Similarly, an aircraft approved for an RNP or RNAV specification having a stringent accuracy requirement (e.g. RNP 0.3 specification) is not automatically approved for a navigation specification having a less stringent accuracy requirement (e.g. RNP 4).

RNP 4

- (c) For RNP 4, at least two LRNSs, capable of navigating to RNP 4, and listed in the AFM/POH, may be operational at the entry point of the RNP 4 airspace. If an item of equipment required for RNP 4 operations is unserviceable, then the pilot-in-command may consider an alternate route or diversion for repairs. For multi-sensor systems, the AFM/POH may permit entry if one GNSS sensor is lost after departure, provided one GNSS and one inertial sensor remain available.

AMC1 NCO.IDE.H.195(a) Navigation equipment

ED Decision 2022/012/R

NAVIGATION EQUIPMENT — RNAV SUBSTITUTION

An RNAV system may be used to substitute for conventional navigation aids and radio equipment, without monitoring of the raw data from conventional navigation aids, under the conditions defined in [AMC1 NCO.IDE.A.195\(a\)](#).

GM1 NCO.IDE.H.195(a) Navigation equipment

ED Decision 2022/012/R

NAVIGATION EQUIPMENT — SCOPE OF RNAV SUBSTITUTION

- (a) Applications of RNAV substitution include use to:
- (1) determine aircraft position relative to or distance from a VOR, marker, DME fix or a named fix defined by a VOR radial or NDB bearing;
 - (2) navigate to or from a VOR, or NDB, except as lateral guidance in the FAS of an IAP;
 - (3) hold over a VOR, NDB, or DME fix;
 - (4) fly an arc based upon DME;
 - (5) fly an overlay of a conventional departure, arrival, approach or route except as lateral guidance in the FAS of an IAP.
- (b) RNAV substitution for ADF, marker and VOR may be used where airborne and/or ground-based equipment is not available.
- (c) RNAV substitution for DME may be used where the ground-based DME transponder is unserviceable or the airborne DME transceiver is found to be unserviceable in flight. Caution must be exercised by the pilot-in-command when calculating and using GNSS distances to the active waypoint as reference points are often different.

GM2 NCO.IDE.H.195(a) Navigation equipment

ED Decision 2022/012/R

NAVIGATION EQUIPMENT — SUITABILITY OF THE RNAV SYSTEM FOR RNAV SUBSTITUTION

GNSS (E)TSOs are referenced in [AMC1 NCO.IDE.A.195\(a\)](#) since most of the aircraft conducting NCO are equipped with an RNAV stand-alone system which exclusively bases its positioning on GNSS.

GM3 NCO.IDE.H.195(a) Navigation equipment

ED Decision 2022/012/R

NAVIGATION EQUIPMENT — RNAV SUBSTITUTION — OPERATING PROCEDURE

Although RNAV substitution may not be used for lateral guidance in the FAS, this does not preclude the use of the RNAV system to fly the FAS, provided that raw data from the associated conventional navigation aids is monitored.

AMC1 NCO.IDE.H.195(b) Navigation equipment

ED Decision 2022/012/R

APPROPRIATE CONTINGENCY ACTION

An appropriate contingency action is an alternative offered in [NCO.IDE.H.195\(b\)](#) to completion of the planned flight to a safe landing, either at the planned destination or a destination alternate, using normal procedures and using navigation equipment meeting the requirements of [NCO.IDE.H.100](#), installed for redundancy or as a backup.

The contingency action should be considered before flight and take into account the information identified by flight preparation according to [NCO.OP.135](#). It may depend on the flight and availability of navigation solutions (satellites, ground navaids, etc.) and weather conditions (IMC, VMC) along the flight.

The contingency action addresses partial loss of navigation capability. An appropriate contingency action to meet the requirements of [NCO.IDE.H.195\(b\)](#) does not rely on the performance of any function of the item of equipment whose potential failure is being considered. For example, in considering the failure of a VOR/LOC/DME receiver, none of the functions of that receiver should be relied upon in the contingency action.

Examples of contingency actions include:

- seeking navigational assistance from ATS, using communication, navigation and surveillance systems that remain operational, to enable a safe instrument approach or a safe descent to VMC;
- unusually long periods of dead reckoning.

A contingency action is required such that the failure of one item of navigation equipment has a reasonable likelihood of a safe outcome to the flight, consistent with other risks to which the operation is exposed.

NCO.IDE.H.200 Transponder

Regulation (EU) No 800/2013

Where required by the airspace being flown, helicopters shall be equipped with a secondary surveillance radar (SSR) transponder with all the required capabilities.

AMC1 NCO.IDE.H.200 Transponder

ED Decision 2014/016/R

GENERAL

- (a) The secondary surveillance radar (SSR) transponders of helicopters being operated under European air traffic control should comply with any applicable Single European Sky legislation.
- (b) If the Single European Sky legislation is not applicable, the SSR transponders should operate in accordance with the relevant provisions of Volume IV of ICAO Annex 10.

NCO.IDE.H.205 Management of aeronautical databases

Regulation (EU) 2016/1119

- (a) Aeronautical databases used on certified aircraft system applications shall meet data quality requirements that are adequate for the intended use of the data.

- (b) The pilot-in-command shall ensure the timely distribution and insertion of current and unaltered aeronautical databases to the aircraft that require them.
- (c) Notwithstanding any other occurrence reporting requirements as defined in Regulation (EU) No 376/2014, the pilot-in-command shall report to the database provider instances of erroneous, inconsistent or missing data that might be reasonably expected to constitute a hazard to flight.

In such cases, the pilot-in-command shall not use the affected data.

AMC1 NCO.IDE.H.205 Management of aeronautical databases

ED Decision 2017/003/R

AERONAUTICAL DATABASES

When the operator of an aircraft uses an aeronautical database that supports an airborne navigation application as a primary means of navigation used to meet the airspace usage requirements, the database provider should be a Type 2 DAT provider certified in accordance with Regulation (EU) 2017/373 or equivalent.

GM1 NCO.IDE.H.205 Management of aeronautical databases

ED Decision 2017/003/R

AERONAUTICAL DATABASE APPLICATIONS

The certification of a Type 2 DAT provider in accordance with Regulation (EU) 2017/373 ensures data integrity and compatibility with the certified aircraft application/equipment.

GM2 NCO.IDE.H.205 Management of aeronautical databases

ED Decision 2017/003/R

TIMELY DISTRIBUTION

The operator should distribute current and unaltered aeronautical databases to all aircraft requiring them in accordance with the validity period of the databases or in accordance with an established procedure if no validity period is defined.

GM3 NCO.IDE.H.205 Management of aeronautical databases

ED Decision 2017/003/R

STANDARDS FOR AERONAUTICAL DATABASES AND DAT PROVIDERS

- (a) A 'Type 2 DAT provider' is an organisation as defined in Article 2(5)(b) of Regulation (EU) 2017/373.
- (b) Equivalent to a certified 'Type 2 DAT provider' is defined in any Aviation Safety Agreement between the European Union and a third country, including any Technical Implementation Procedures, or any Working Arrangements between EASA and the competent authority of a third country.

SUBPART E: SPECIFIC REQUIREMENTS

SECTION 1 – GENERAL

NCO.SPEC.100 Scope

Regulation (EU) 2015/140

This subpart establishes specific requirements to be followed by a pilot-in-command conducting non-commercial specialised operations with other-than complex motor-powered aircraft.

AMC1 NCO.SPEC.100 Scope

ED Decision 2019/019/R

CRITERIA

The pilot-in-command should consider the following criteria to determine whether an activity falls within the scope of specialised operations:

- (a) the aircraft is flown close to the surface to fulfil the mission;
- (b) abnormal manoeuvres are performed;
- (c) special equipment is necessary to fulfil the mission and which affects the manoeuvrability of the aircraft;
- (d) substances are released from the aircraft during the flight where these substances are either harmful or affect the manoeuvrability of the aircraft;
- (e) external loads or goods are lifted or towed;
- (f) persons enter or leave the aircraft during flight; or
- (g) the flight falls under the definition of 'maintenance check flight'.

GM1 NCO.SPEC.100 Scope

ED Decision 2019/019/R

LIST OF SPECIALISED OPERATIONS

- (a) Specialised operations include the following activities:
 - (1) helicopter external loads operations;
 - (2) helicopter survey operations;
 - (3) human external cargo operations;
 - (4) parachute operations and skydiving;
 - (5) agricultural flights;
 - (6) aerial photography flights;
 - (7) glider towing;
 - (8) aerial advertising flights;
 - (9) calibration flights;

- (10) construction work flights, including stringing power line operations, clearing saw operations;
 - (11) oil spill work;
 - (12) avalanche mining operations;
 - (13) survey operations, including aerial mapping operations, pollution control activity;
 - (14) news media flights, television and movie flights;
 - (15) special events flights, including such as flying display, competition flights;
 - (16) aerobatic flights;
 - (17) animal herding and rescue flights and veterinary dropping flights;
 - (18) maritime funeral operations;
 - (19) scientific research flights (other than those under Annex I to Regulation (EU) 2018/1139);
 - (20) cloud seeding; and
 - (21) maintenance check flights.
- (b) For other operations, the pilot-in-command can apply the criteria specified in [AMC1 NCO.SPEC.100](#) to determine whether an activity falls within the scope of specialised operations.

NCO.SPEC.105 Checklist

Regulation (EU) No 379/2014

- (a) Before commencing a specialised operation, the pilot-in-command shall conduct a risk assessment, assessing the complexity of the activity to determine the hazards and associated risks inherent in the operation and establish mitigating measures.
- (b) A specialised operation shall be performed in accordance with a checklist. Based on the risk assessment, the pilot-in-command shall establish such checklist appropriate to the specialised activity and aircraft used, taking account of any section of this subpart.
- (c) The checklist that is relevant to the duties of the pilot-in-command, crew members and task specialists shall be readily accessible on each flight.
- (d) The checklist shall be regularly reviewed and updated, as appropriate.

GM1 NCO.SPEC.105 Checklist

ED Decision 2014/016/R

DEVELOPMENT OF CHECKLISTS

For developing the checklist, the pilot-in-command should duly take into account at least the following items:

- (a) nature and complexity of the activity:
 - (1) the nature of the flight and the risk exposure, e.g. low height;
 - (2) the complexity of the activity taking into account the necessary pilot skills and level of experience, ground support, safety and individual protective equipment;

- (3) the operational environment and geographical area, e.g., congested hostile environment, mountainous areas, sea areas, or desert areas;
- (4) the result of the risk assessment and evaluation;
- (b) aircraft and equipment:
 - (1) the category of aircraft to be used for the activity should be indicated, e.g. helicopter/aeroplane, single/multi-engined;
 - (2) all equipment required for the activity should be listed;
- (c) crew members:
 - (1) crew composition;
 - (2) minimum crew experience and training provisions; and
 - (3) recency provisions;
- (d) task specialists:
 - (1) description of the task specialists' function(s)
 - (2) minimum crew experience and training provisions; and
 - (3) recency provisions;
 - (4) briefing;
- (e) aircraft performance:

this chapter should detail the specific performance requirements to be applied, in order to ensure an adequate power margin;
- (f) normal procedures and emergency procedures:
 - (1) operating procedures for the flight crew, including the coordination with task specialists;
 - (2) ground procedures for the task specialists;
- (g) ground equipment:

this chapter should detail the nature, number and location of ground equipment required for the activity;
- (h) records:

it should be determined which records specific to these flight(s) are to be kept, such as task details, aircraft registration, pilot-in-command, flight times, weather and any remarks, including a record of occurrences affecting flight safety or the safety of persons or property on the ground.

GM2 NCO.SPEC.105 Checklists

ED Decision 2014/016/R

TEMPLATE FORMS

The following templates are examples, which could be used for developing checklist.

(a) Template Form A — Risk assessment (RA)

Date:	RA of Responsible:
Purpose:	
Type of operation and brief description:	
Participants, working group:	
Preconditions, assumptions and simplifications:	
Data used:	
Description of the analysis method:	
External context:	
<ul style="list-style-type: none"> — Regulatory requirements — Approvals — Environmental conditions (visibility, wind, turbulence, contrast, light, elevation, etc.; unless evident from the checklists) — Stakeholders and their potential interest 	
Internal context:	
<ul style="list-style-type: none"> — Type(s) of aircraft — Personnel and qualifications — Combination/similarity with other operations/SOPs — Other RA used/considered/plugged in 	
Existing barriers and emergency preparedness:	
Monitoring and follow up:	
Description of the risk:	
Risk evaluation:	
Conclusions:	

(b) Template Form B — Hazard identification (HI)

Date: _____ HI of Responsible: _____

Phase of operation	Haz ref	Hazard / accidental event	Cause / threat	Current Treatment Measures (TM)	Further treatment required	TM ref	Comment

Haz ref: A unique number for hazards, e.g., for use in a database

TM ref: A unique number for the treatment method

(c) Template Form C — Mitigating measures

Date:..... RA of Responsible:.....

Phase of operation	Haz ref	Hazard/ accidental event	Current Treatment Measures (TM)/ controls	TM ref	L	C	Further treatment required

Haz ref: A unique number for hazards, e.g., for use in a database

TM ref: A unique number for the treatment method

L: Likelihood (probability)

C: Consequence

(d) Template register A — Risk register

Ref	Operation/ Procedure	Ref	Generic hazard	Ref	Accidental event	Treatment/ control	L	C	Monitoring

L: Likelihood (probability)
 C: Consequence

NCO.SPEC.110 Pilot-in-command responsibilities and authority

Regulation (EU) 2016/1119

Whenever crew members or task specialists are involved in the operation, the pilot-in-command shall

- (a) ensure compliance of crew members and task specialists with [NCO.SPEC.115](#) and [NCO.SPEC.120](#);
- (b) not commence a flight if any crew member or task specialist is incapacitated from performing duties by any cause such as injury, sickness, fatigue or the effects of any psychoactive substance;
- (c) not continue a flight beyond the nearest weather-permissible aerodrome or operating site when any crew member or task specialist’s capacity to perform duties is significantly reduced from causes such as fatigue, sickness or lack of oxygen;
- (d) ensure that crew members and task specialists comply with the laws, regulations and procedures of those States where operations are conducted;
- (e) ensure that all crew members and task specialists are able to communicate with each other in a common language; and
- (f) ensure that task specialists and crew members use supplemental oxygen continuously whenever he/she determines that at the altitude of the intended flight the lack of oxygen might result in impairment of the faculties of crew members or harmfully affect task specialists. If the pilot-in-command cannot determine how the lack of oxygen might affect the occupants on board, he/she shall ensure that task specialists and crew members use supplemental oxygen continuously whenever the cabin altitude exceeds 10 000 ft for a period of more than 30 minutes and whenever the cabin altitude exceeds 13 000 ft.

AMC1 NCO.SPEC.110(f) Pilot-in-command responsibilities and authority

ED Decision 2016/018/R

DETERMINATION OF SUPPLEMENTAL OXYGEN NEED

When determining the need for supplemental oxygen carriage and use, the pilot-in-command should:

- (a) in the preflight phase:
 - (1) be aware of hypoxia conditions and associated risks;
 - (2) consider the following objective conditions for the intended flight:
 - (i) altitude;
 - (ii) duration of the flight; and
 - (iii) any other relevant operational conditions;
 - (3) consider individual conditions of flight crew members and task specialists in relation to:
 - (i) altitude of the place of residence;
 - (ii) smoking;
 - (iii) experience in flights at high altitudes;
 - (iv) actual medical conditions and medications;
 - (v) age;
 - (vi) disabilities; and
 - (vii) any other relevant factor that may be detected, or reported by the person; and
 - (4) when relevant, ensure that all flight crew members and task specialists are briefed on hypoxia conditions and symptoms, as well as on the usage of supplemental oxygen equipment.
- (b) during flight:
 - (1) monitor for early symptoms of hypoxia conditions; and
 - (2) if detecting early symptoms of hypoxia conditions:
 - (i) consider to return to a safe altitude, and
 - (ii) ensure that supplemental oxygen is used, if available.

GM1 NCO.SPEC.110(f) Pilot-in-command responsibilities and authority

ED Decision 2016/018/R

DETERMINATION OF SUPPLEMENTAL OXYGEN NEED

- (a) The responsibility of the pilot-in-command for safety of all persons on board, as required by [NCO.GEN.105\(a\)\(1\)](#), includes the determination of need for supplemental oxygen use.
- (b) The altitudes above which [NCO.SPEC.110\(f\)](#) requires oxygen to be available and used are applicable to those cases when the pilot-in-command cannot determine the need for supplemental oxygen. However, if the pilot-in-command is able to make this determination,

he/she may elect in the interest of safety to require oxygen also for operations at or below such altitudes.

- (c) The pilot-in-command should be aware that flying below altitudes mentioned in [NCO.SPEC.110\(f\)](#) does not provide absolute protection against hypoxia symptoms, should individual conditions and aptitudes be prevalent.

GM2 NCO.SPEC.110(f) Pilot-in-command responsibilities and authority

ED Decision 2016/018/R

DETERMINATION OF OXYGEN NEED — BEFORE FLIGHT

Detailed information and guidance on hypoxia conditions and symptoms, content of the briefing on hypoxia and assessment of individual conditions may be found in the EASA leaflet 'Hypoxia'.

DETERMINATION OF OXYGEN NEED — IN FLIGHT

Several methods for monitoring hypoxia early symptoms may be used and some methods may be aided by personal equipment, such as finger-mounted pulse oximeters. Detailed information and guidance on entering hypoxia conditions, on hypoxia symptoms early detection, and on use of personal equipment such as finger-mounted pulse oximeters or equivalent may be found in the EASA leaflet 'Hypoxia'.

NCO.SPEC.115 Crew responsibilities

Regulation (EU) 2018/1042

- (a) The crew member shall be responsible for the proper execution of his/her duties. Crew duties shall be specified in the checklist.
- (b) During critical phases of the flight or whenever deemed necessary by the pilot-in-command in the interest of safety, the crew member shall be restrained at his/her assigned station, unless otherwise specified in the checklist.
- (c) During flight, the flight crew member shall keep his/her safety belt fastened while at his/her station.
- (d) During flight, at least one qualified flight crew member shall remain at the controls of the aircraft at all times.
- (e) The crew member shall not undertake duties on an aircraft:
- (1) if he/she knows or suspects that he/she is suffering from fatigue as referred to in 7.f. of Annex IV to Regulation (EC) No 216/2008 or feels otherwise unfit to perform his/her duties; or
 - (2) when under the influence of psychoactive substances or for other reasons as referred to in 7.g of Annex IV to Regulation (EC) No 216/2008.
- (f) The crew member who undertakes duties for more than one operator shall:
- (1) maintain his/her individual records regarding flight and duty times and rest periods as referred to in Annex III (Part-ORO), Subpart FTL to Regulation (EU) No 965/2012, if applicable; and
 - (2) provide each operator with the data needed to schedule activities in accordance with the applicable FTL requirements.

- (g) The crew member shall report to the pilot-in-command:
- (1) any fault, failure, malfunction or defect, which he/she believes may affect the airworthiness or safe operation of the aircraft, including emergency systems; and
 - (2) any incident that was endangering, or could endanger, the safety of the operation.

AMC1 NCO.SPEC.115(a) Crew responsibilities

ED Decision 2022/012/R

PILOT DUTIES — RECORDING OF FLIGHT TIME

- (a) The pilot should only record flight time for the purpose of meeting experience requirements in specialised operations defined in AMC1 ORO.FC.146(f) and [AMC1 SPO.SPEC.HESLO.100](#) if NCO.SPEC applies.
- (b) The list of specialised operations in [GM1 NCO.SPEC.100](#) may be used for the purpose of (a).

NCO.SPEC.120 Task specialists responsibilities

Regulation (EU) 2018/394

- (a) The task specialist shall be responsible for the proper execution of his/her duties. Task specialists' duties shall be specified in the checklist.
- (b) During critical phases of the flight or whenever deemed necessary by the pilot-in-command in the interest of safety, the task specialist shall be restrained at his/her assigned station, unless otherwise specified in the checklist.
- (c) The task specialist shall ensure that he/she is restrained when carrying out specialised tasks with external doors opened or removed.
- (d) The task specialist shall report to the pilot-in-command:
- (1) any fault, failure, malfunction or defect, which he/she believes may affect the airworthiness or safe operation of the aircraft, including emergency systems; and
 - (2) any incident that was endangering, or could endanger, the safety of the operation.

NCO.SPEC.125 Safety briefing

Regulation (EU) No 379/2014

- (a) Before take-off, the pilot-in-command shall brief task specialists on:
- (1) emergency equipment and procedures;
 - (2) operational procedures associated with the specialised task before each flight or series of flights.
- (b) The briefing referred to in (a)(2) may not be required if task specialists have been instructed on the operational procedures before the start of the operating season in that calendar year.

AMC1 NCO.SPEC.125 Safety briefing

ED Decision 2014/016/R

TASK SPECIALISTS

- (a) Safety briefings should ensure that task specialists are familiar with all aspects of the operation, including their responsibilities.

- (b) Such briefings should include, as appropriate:
- (1) behaviour on the ground and in-flight, including emergency procedures;
 - (2) procedures for boarding and disembarking;
 - (3) procedures for loading and unloading the aircraft;
 - (4) use of doors in normal and emergency operations;
 - (5) use of communication equipment and hand signals;
 - (6) precautions in case of a landing on sloping ground; and
 - (7) in addition to the items listed from (b)(1) to (b)(6) before take-off:
 - (i) location of emergency exits;
 - (ii) restrictions regarding smoking;
 - (iii) restrictions regarding the use of portable electronic equipment; and
 - (iv) stowage of tools and hand baggage.
- (c) Briefings may be given as a verbal presentation or by issuing the appropriate procedures and instructions in written form. Before commencement of the flight, their understanding should be confirmed.

NCO.SPEC.130 Minimum obstacle clearance altitudes – IFR flights

Regulation (EU) No 379/2014

The pilot-in-command shall establish minimum flight altitudes for each flight providing the required terrain clearance for all route segments to be flown in IFR. The minimum flight altitudes shall not be lower than those published by the State overflown.

NCO.SPEC.145 Simulated situations in flight

Regulation (EU) No 379/2014

Unless a task specialist is on-board the aircraft for training, the pilot-in-command shall, when carrying task specialists, not simulate:

- (a) situations that require the application of abnormal or emergency procedures; or
- (b) flight in instrument meteorological conditions (IMC).

NCO.SPEC.150 Ground proximity detection

Regulation (EU) No 379/2014

If installed, the ground proximity warning system may be disabled during those specialised tasks, which by their nature require the aircraft to be operated within a distance from the ground below that which would trigger the ground proximity warning system.

NCO.SPEC.155 Airborne collision avoidance system (ACAS II)

Regulation (EU) No 379/2014

Notwithstanding [NCO.OP.200](#), the ACAS II may be disabled during those specialised tasks, which by their nature require the aircraft to be operated within a distance from each other below that which would trigger the ACAS.

NCO.SPEC.160 Release of dangerous goods

Regulation (EU) No 379/2014

The pilot-in-command shall not operate an aircraft over congested areas of cities, towns or settlements or over an open-air assembly of persons when releasing dangerous goods.

NCO.SPEC.165 Carriage and use of weapons

Regulation (EU) 379/2014

- (a) The pilot-in-command shall ensure that, when weapons are carried on a flight for the purpose of a specialised task, these are secured when not in use.
- (b) The task specialist using the weapon shall take all necessary measures to prevent the aircraft and persons on board or on the ground from being endangered.

NCO.SPEC.170 Performance and operating criteria – aeroplanes

Regulation (EU) No 379/2014

When operating an aeroplane at a height of less than 150 m (500 ft) above a non-congested area, for operations of aeroplanes that are not able to sustain level flight in the event of a critical engine failure, the pilot-in-command shall have:

- (a) established operational procedures to minimise the consequences of an engine failure; and
- (b) briefed all crew members and task specialists on board on the procedures to be carried out in the event of a forced landing.

NCO.SPEC.175 Performance and operating criteria – helicopters

Regulation (EU) No 379/2014

- (a) The pilot-in-command may operate an aircraft over congested areas provided that:
 - (1) the helicopter is certified in category A or B; and
 - (2) safety measures are established to prevent undue hazard to persons or property on the ground
- (b) The pilot-in-command shall have:
 - (1) established operational procedures to minimise the consequences of an engine failure; and
 - (2) briefed all crew members and task specialists on board on the procedures to be carried out in the event of a forced landing.
- (c) The pilot-in-command shall ensure that the mass at take-off, landing or hover shall not exceed the maximum mass specified for:
 - (1) a hover out of ground effect (HOGE) with all engines operating at the appropriate power rating; or
 - (2) if conditions prevail that a HOGE is not likely to be established, the helicopter mass shall not exceed the maximum mass specified for a hover in ground effect (HIGE) with all engines operating at the appropriate power rating, provided prevailing conditions allow a hover in ground effect at the maximum specified mass.

GM1 NCO.SPEC.175(c) Performance and operating criteria – helicopters

ED Decision 2014/016/R

GENERAL

- (a) Even when the surface allows a hover in ground effect (HIGE), the likelihood of, for example, dust or blowing snow may necessitate hover out of ground effect (HOGE) performance.
- (b) Wind conditions on some sites, particularly downdraft in mountainous areas, may require a reduction in the helicopter mass in order to ensure that an out of ground effect hover can be achieved at the operational site in the conditions prevailing.

SECTION 2 – HELICOPTER EXTERNAL SLING LOAD OPERATIONS (HESLO)

NCO.SPEC.HESLO.100 Checklist

Regulation (EU) No 379/2014

The checklist for HESLO shall contain:

- (a) normal, abnormal and emergency procedures;
- (b) relevant performance data;
- (c) required equipment;
- (d) any limitations; and
- (e) responsibilities and duties of the pilot-in-command, and, if applicable, crew members and task specialists.

GM1 NCO.SPEC.HESLO.100 Checklist

ED Decision 2017/011/R

REFERENCES

The following references to the AMC and GM of Annex VIII (Part-SPO) provide further guidance for the development of checklists.

- (a) [AMC1 SPO.SPEC.HESLO.100](#) provides a generic framework for the development of standard operating procedures (SOP) for HESLO operations. This AMC can be regarded as a good practice example for developing the checklist for HESLO operations.
- (b) [GM1 SPO.SPEC.HESLO.100](#) provides guidance for initial pilot training for HESLO types 1, 2, 3 and 4.

NCO.SPEC.HESLO.105 Specific HESLO equipment

Regulation (EU) No 379/2014

The helicopter shall be equipped with at least:

- (a) one cargo safety mirror or alternative means to see the hook(s)/load; and
- (b) one load meter, unless there is another method of determining the weight of the load.

NCO.SPEC.HESLO.110 Transportation of dangerous goods

Regulation (EU) No 379/2017

The operator transporting dangerous goods to or from unmanned sites or remote locations shall apply to the competent authority for an exemption from the provisions of the Technical Instructions if they intend not to comply with the requirements of those Instructions.

SECTION 3 – HUMAN EXTERNAL CARGO OPERATIONS (HEC)

NCO.SPEC.HEC.100 Checklist

Regulation (EU) No 800/2013

The checklist for HEC shall contain:

- (a) normal, abnormal and emergency procedures;
- (b) relevant performance data;
- (c) required equipment;
- (d) any limitations; and
- (e) responsibilities and duties of the pilot-in-command, and, if applicable, crew members and task specialists.

GM1 NCO.SPEC.HEC.100 Checklist

ED Decision 2014/016/R

REFERENCES

[AMC1 SPO.SPEC.HEC.100](#) of Annex VIII (Part-SPO) provides a generic framework for the development of SOP for HEC operations. This AMC can be regarded as a good practice example for developing the checklist for HEC operations.

NCO.SPEC.HEC.105 Specific HEC equipment

Regulation (EU) 2019/1384

- (a) The helicopter shall be equipped with:
 - (1) hoist operations equipment or cargo hook;
 - (2) one cargo safety mirror or alternative means to see the hook; and
 - (3) one load meter, unless there is another method of determining the weight of the load.
- (b) The installation of all hoist and cargo hook equipment other than a simple PCDS, and any subsequent modifications shall have an airworthiness approval appropriate to the intended function.

SECTION 4 – PARACHUTE OPERATIONS (PAR)

NCO.SPEC.PAR.100 Checklist

Regulation (EU) No 379/2014

The checklist for PAR shall contain:

- (a) normal, abnormal and emergency procedures;
- (b) relevant performance data;
- (c) required equipment;
- (d) any limitations; and
- (e) responsibilities and duties of the pilot-in-command, and, if applicable, crew members and task specialists.

NCO.SPEC.PAR.105 Carriage of crew members and task specialists

Regulation (EU) No 379/2014

The requirement laid down in [NCO.SPEC.120\(c\)](#) shall not be applicable for task specialists performing parachute jumping.

NCO.SPEC.PAR.110 Seats

Regulation (EU) No 379/2014

Notwithstanding NCO.IDE.A.140(a)(1) and NCO.IDE.H.140(a)(1), the floor of the aircraft may be used as a seat, provided means are available for the task specialist to hold or strap on.

NCO.SPEC.PAR.115 Supplemental oxygen

Regulation (EU) No 379/2014

Notwithstanding NCO.SPEC.110(f), the requirement to use supplemental oxygen shall not be applicable for crew members other than the pilot-in-command and for task specialists carrying out duties essential to the specialised task, whenever the cabin altitude:

- (a) exceeds 13 000 ft, for a period of not more than 6 minutes; or
- (b) exceeds 15 000 ft, for a period of not more than 3 minutes.

NCO.SPEC.PAR.120 Release of dangerous goods

Regulation (EU) 2019/1384

Notwithstanding point [NCO.SPEC.160](#), parachutists may carry smoke trail devices and exit the aircraft for the purpose of parachute display over congested areas of cities, towns or settlements or over an open-air assembly of persons, provided those devices are manufactured for that purpose.

SECTION 5 – AEROBATIC FLIGHTS (ABF)

NCO.SPEC.ABF.100 Checklist

Regulation (EU) No 379/2014

The checklist for ABF shall contain:

- (a) normal, abnormal and emergency procedures;
- (b) relevant performance data;
- (c) required equipment;
- (d) any limitations; and
- (e) responsibilities and duties of the pilot-in-command, and, if applicable, crew members and task specialists.

NCO.SPEC.ABF.105 Documents and information

Regulation (EU) No 379/2014

The following documents and information listed in [NCO.GEN.135\(a\)](#) need not be carried during aerobatic flights:

- (a) details of the filed ATS flight plan, if applicable;
- (b) current and suitable aeronautical charts for the route/area of the proposed flight and all routes along which it is reasonable to expect that the flight may be diverted; and
- (c) procedures and visual signals information for use by intercepting and intercepted aircraft.

NCO.SPEC.ABF.110 Equipment

Regulation (EU) No 379/2014

The following equipment requirements need not be applicable to aerobatic flights:

- (a) first-aids kit as laid down in [NCO.IDE.A.145](#) and [NCO.IDE.H.145](#);
- (b) hand-fire extinguishers as laid down in [NCO.IDE.A.160](#) and [NCO.IDE.H.180](#); and
- (c) emergency locator transmitters or personal locator beacons as laid down in [NCO.IDE.A.170](#) and [NCO.IDE.H.170](#).

SECTION 6 – MAINTENANCE CHECK FLIGHTS (MCF)

NCO.SPEC.MCF.100 Levels of maintenance check flights

Regulation (EU) 2019/1384

Before conducting a maintenance check flight, the operator shall determine the applicable level of the maintenance check flight as follows:

- (a) a “Level A” maintenance check flight for a flight where the use of abnormal or emergency procedures, as defined in the aircraft flight manual, is expected, or where a flight is required to prove the functioning of a backup system or other safety devices;
- (b) a “Level B” maintenance check flight for any maintenance check flight other than a “Level A” maintenance check flight.

NCO.SPEC.MCF.105 Operational limitations

Regulation (EU) 2019/1387

- (a) By way of derogation from point [NCO.GEN.105\(a\)\(4\)](#) of this Annex, a maintenance check flight may be conducted with an aircraft that has been released to service with incomplete maintenance in accordance with points M.A.801(f) of Annex I (Part-M), 145.A.50(e) of Annex II (Part-145) or ML.A.801(f) of Annex Vb (Part-ML) to Commission Regulation (EU) No 1321/2014.
- (b) By way of derogation from point [NCO.IDE.A.105](#) or [NCO.IDE.H.105](#), the pilot-in-command may conduct a flight with inoperative or missing items of equipment or functions required for the flight if those inoperative or missing items of equipment or functions have been identified in the checklist referred to in point [NCO.SPEC.MCF.110](#).

NCO.SPEC.MCF.110 Checklist and safety briefing

Regulation (EU) 2019/1384

- (a) The checklist referred to in point [NCO.SPEC.105](#) shall be updated as needed before each maintenance check flight and shall consider the operating procedures that are planned to be followed during the particular maintenance check flight.
- (b) Notwithstanding point [NCO.SPEC.125\(b\)](#), a safety briefing of the task specialist shall be required before each maintenance check flight.

GM1 NCO.SPEC.MCF.110 Checklist and safety briefing

ED Decision 2019/019/R

SPECIFIC PROCEDURES

Specific preparation for a maintenance check flight (MCF) is essential. In addition to the standard considerations before a typical flight (weather, aircraft weight and balance, pre-flight inspection, checklists, etc.), the pilot should:

- (a) inform ATC of the particular MCF;
- (b) if needed, agree on the appropriate airspace;
- (c) understand the airworthiness status of the aircraft;
- (d) assess the complexity of the flight; and
- (e) develop appropriate strategies to mitigate potential risks.

The operator planning to conduct an MCF should develop checklists for the in-flight assessment of the unreliable systems, considering relevant abnormal and emergency procedures. When developing the checklists, the operator should consider the applicable documentation available from the type certificate holder or other valid documentation.

The pilot-in-command should only allow on board the persons needed for the purpose of the flight and brief the crew and task specialist on abnormal and emergency procedures relevant for the MCF.

NCO.SPEC.MCF.120 Flight crew requirements

Regulation (EU) 2019/1384

When selecting a flight crew member for a maintenance check flight, the operator shall consider the aircraft complexity and the level of the maintenance check flight as defined in point [NCO.SPEC.MCF.100](#).

AMC1 NCO.SPEC.MCF.120 Flight crew requirements

ED Decision 2019/019/R

SELECTION OF PILOT-IN-COMMAND FOR A LEVEL-A MCF

The operator may select a flight instructor to act as pilot-in-command for a 'Level A' MCF on other than complex motor-powered aircraft.

NCO.SPEC.MCF.125 Crew composition and persons on board

Regulation (EU) 2019/1384

- (a) The pilot-in-command shall identify the need for additional crew members or task specialists, or both, before each intended maintenance check flight, taking into consideration the expected flight crew member or task specialist workload and the risk assessment.
- (b) The pilot-in-command shall not allow persons on board other than those required under point (a) during a "Level A" maintenance check flight.

GM1 NCO.SPEC.MCF.125 Crew composition and persons on board

ED Decision 2019/019/R

TASK SPECIALIST

The task specialist should be trained as necessary in crew coordination procedures as well as emergency procedures and be appropriately equipped.

NCO.SPEC.MCF.130 Simulated abnormal or emergency procedures in flight

Regulation (EU) 2019/1387

By way of derogation from point [NCO.SPEC.145](#), a pilot-in-command may simulate situations that require the application of abnormal or emergency procedures with a task specialist on board if the simulation is required to meet the intention of the flight and if it has been identified in the check list referred to in point [NCO.SPEC.MCF.110](#) or in operating procedures.

NCO.SPEC.MCF.140 Systems and equipment

Regulation (EU) 2019/1384

When a maintenance check flight is intended to check the proper functioning of a system or equipment, that system or equipment shall be identified as potentially unreliable, and appropriate mitigation measures shall be agreed prior to the flight in order to minimise risks to flight safety.

ANNEX VIII (PART-SPO)

SPO.GEN.005 Scope

Regulation (EU) 2019/1384

- (a) This Annex applies to any specialised operation where the aircraft is used for specialised activities such as agriculture, construction, photography, surveying, observation and patrol, aerial advertisement or maintenance check flights.
- (b) Notwithstanding (a), non-commercial specialised operations with other-than complex motor-powered aircraft shall comply with Annex VII (Part-NCO).
- (c) Notwithstanding point (a), the following operations with other-than complex motor-powered aircraft may be conducted in accordance with Annex VII (Part-NCO):
 - (1) competition flights or flying displays, on the condition that the remuneration or any valuable consideration given for such flights is limited to recovery of direct costs and a proportionate contribution to annual costs, as well as prizes of no more than a value specified by the competent authority.
 - (2) parachute dropping, sailplane towing with an aeroplane or aerobatic flights performed either by a training organisation having its principal place of business in a Member State and being referred to in Article 10a of Regulation (EU) No 1178/2011, or by an organisation created with the aim of promoting aerial sport or leisure aviation, on the condition that the aircraft is operated by the organisation on the basis of ownership or dry lease, that the flight does not generate profits distributed outside of the organisation, and that whenever non-members of the organisation are involved, such flights represent only a marginal activity of the organisation.

AMC1 SPO.GEN.005 Scope

ED Decision 2014/018/R

CRITERIA

The operators should consider the following criteria to determine whether an activity falls within the scope of specialised operations:

- (a) the aircraft is flown close to the surface to fulfil the mission;
- (b) abnormal manoeuvres are performed;
- (c) special equipment is necessary to fulfil the mission and which affects the manoeuvrability of the aircraft;
- (d) substances are released from the aircraft during the flight where these substances are either harmful or affect the manoeuvrability of the aircraft;
- (e) external loads or goods are lifted or towed; or
- (f) persons enter or leave the aircraft during flight.

GM1 SPO.GEN.005 Scope

ED Decision 2015/006/R

LIST OF SPECIALISED OPERATIONS

- (a) Specialised operations include the following activities:
- (1) helicopter external loads operations;
 - (2) helicopter survey operations;
 - (3) human external cargo operations;
 - (4) parachute operations and skydiving;
 - (5) agricultural flights;
 - (6) aerial photography flights;
 - (7) glider towing;
 - (8) aerial advertising flights;
 - (9) calibration flights;
 - (10) construction work flights, including stringing power line operations, clearing saw operations;
 - (11) oil spill work;
 - (12) avalanche mining operations;
 - (13) survey operations, including aerial mapping operations, pollution control activity;
 - (14) news media flights, television and movie flights;
 - (15) special events flights, including such as flying display and competition flights;
 - (16) aerobatic flights;
 - (17) animal herding, animal rescue flights and veterinary dropping flights;
 - (18) maritime funeral operations;
 - (19) scientific research flights (other than those under Annex II to Regulation (EC) No 216/2008);
 - (20) cloud seeding; and
 - (21) sensational flights: flights involving extreme aerobatic manoeuvres carried out for the purpose of allowing the persons on board to experience zero gravity, high G-forces or similar sensations.
- (b) For other operations, the operator can apply the criteria specified in [AMC1 SPO.GEN.005](#) to determine whether an activity falls within the scope of specialised operations.

SUBPART A: GENERAL REQUIREMENTS

SPO.GEN.100 Competent authority

Regulation (EU) 2019/1384

The competent authority shall be the authority designated by the Member State in which the operator has its principal place of business, is established or is residing.

GM1 SPO.GEN.100 Competent authority

ED Decision 2019/019/R

DETERMINING THE PLACE WHERE AN OPERATOR IS RESIDING

For the purpose of Regulation (EU) No 965/2012, the concept of ‘place where the operator is residing’ is mainly addressed to a natural person.

The place where the operator resides is the place where the operator complies with his or her tax obligations.

Several criteria can be used to help determining a person’s place of residence. These include, for example:

- (a) the duration of a person’s presence on the territory of the countries concerned;
- (b) the person’s family status and ties;
- (c) the person’s housing situation and how permanent it is;
- (d) the place where the person pursues professional or non-profit activities;
- (e) characteristics of the person’s professional activity; and
- (f) Member State where the person resides for taxation purposes.

SPO.GEN.101 Means of compliance

Regulation (EU) No 379/2014

Alternative means of compliance to those adopted by the Agency may be used by an operator to establish compliance with Regulation (EC) No 216/2008 and its Implementing Rules.

SPO.GEN.105 Crew responsibilities

Regulation (EU) 2018/1042

- (a) The crew member shall be responsible for the proper execution of his/her duties. Crew duties shall be specified in the standard operating procedures (SOP) and, where appropriate, in the operations manual.
- (b) During critical phases of the flight or whenever deemed necessary by the pilot-in-command in the interest of safety, the crew member shall be restrained at his/her assigned station, unless otherwise specified in the SOP.
- (c) During flight, the flight crew member shall keep his/her safety belt fastened while at his/her station.
- (d) During flight, at least one qualified flight crew member shall remain at the controls of the aircraft at all times.

- (e) The crew member shall not undertake duties on an aircraft:
 - (1) if he/she knows or suspects that he/she is suffering from fatigue as referred to in 7.f. of Annex IV to Regulation (EC) No 216/2008 or feels otherwise unfit to perform his/her duties; or
 - (2) when under the influence of psychoactive substances or for other reasons as referred to in 7.g of Annex IV to Regulation (EC) No 216/2008.
- (f) The crew member who undertakes duties for more than one operator shall:
 - (1) maintain his/her individual records regarding flight and duty times and rest periods as referred to in Annex III (Part-ORO), Subpart FTL to Regulation (EU) No 965/2012, if applicable; and
 - (2) provide each operator with the data needed to schedule activities in accordance with the applicable FTL requirements.
- (g) The crew member shall report to the pilot-in-command:
 - (1) any fault, failure, malfunction or defect, which he/she believes may affect the airworthiness or safe operation of the aircraft, including emergency systems; and
 - (2) any incident that was endangering, or could endanger, the safety of the operation.

AMC1 SPO.GEN.105(a) Crew responsibilities

ED Decision 2022/012/R

CREW DUTIES — RECORDING OF FLIGHT TIME

The following should apply for the purpose of recording flight time in accordance with [AMC2 SPO.OP.230\(i\)](#) and meeting experience requirements in specialised operations defined in AMC1 ORO.FC.146(f) and [AMC1 SPO.SPEC.HESLO.100](#):

- (a) Flight time should be recorded as flight time in a specialised activity if one of the following applies:
 - (1) The aircraft has external equipment or is in a configuration that requires the use of a specific SOP.
 - (2) A task specialist is on board, or a person indispensable to the mission is being carried in accordance with Article 5(7).
 - (3) The crew applies a specific SOP in the course of a specialised activity.
- (b) Irrespective of the scope of Part-SPO, if none of the above applies (e.g. ferry flights), the flight time should not be recorded as a specialised activity.
- (c) The list of specialised operations in GM1 SPO.SPEC.005 may be used for the purpose of (a).

GM1 SPO.GEN.105(e)(2) Crew member responsibilities

ED Decision 2014/018/R

GENERAL

In accordance with 7.g. of Annex IV to Regulation (EC) No 216/2008¹ (Essential Requirements for air operations), a crew member must not perform duties on board an aircraft when under the influence of psychoactive substances or alcohol or when unfit due to injury, fatigue, medication, sickness or other similar causes. This should be understood as including the following:

- (a) effects of deep water diving and blood donation, and allowing for a certain time period between these activities and returning to flying; and
- (b) without prejudice to more restrictive national regulations, the consumption of alcohol while on duty or less than 8 hours prior to the commencement of duties, and commencing a flight duty period with a blood alcohol level in excess of 0.2 per thousand.

SPO.GEN.106 Task specialists responsibilities

Regulation (EU) 2018/394

- (a) The task specialist shall be responsible for the proper execution of his/her duties. Task specialists' duties shall be specified in the SOP.
- (b) During critical phases of the flight or whenever deemed necessary by the pilot-in-command in the interest of safety, the task specialist shall be restrained at his/her assigned station, unless otherwise specified in the SOP.
- (c) The task specialist shall ensure that he/she is restrained when carrying out specialised tasks with external doors opened or removed.
- (d) The task specialist shall report to the pilot-in-command:
 - (1) any fault, failure, malfunction or defect, which he/she believes may affect the airworthiness or safe operation of the aircraft, including emergency systems; and
 - (2) any incident that was endangering, or could endanger, the safety of the operation.

SPO.GEN.107 Pilot-in-command responsibilities and authority

Regulation (EU) 2018/1975

- (a) The pilot-in-command shall be responsible for:
 - (1) the safety of the aircraft and of all crew members, task specialists and cargo on board during aircraft operations;
 - (2) the initiation, continuation, termination or diversion of a flight in the interest of safety;
 - (3) ensuring that all operational procedures and checklists are complied with in accordance with the appropriate manual;
 - (4) only commencing a flight if he/she is satisfied that all operational limitations referred to in 2.a.3 of Annex IV to Regulation (EC) No 216/2008 are complied with, as follows:

¹ Regulation (EC) No 216/2008 of the European Parliament and of the Council of 20 February 2008 on common rules in the field of civil aviation and establishing a European Aviation Safety Agency, and repealing Council Directive 91/670/EEC, Regulation (EC) No 1592/2002 and Directive 2004/36/EC (OJ L 79, 19.3.2008, p. 1). Regulation as last amended by Commission Regulation (EU) No 6/2013 of 8 January 2013 (OJ L 4, 9.1.2013, p. 34).

-
- (i) the aircraft is airworthy;
 - (ii) the aircraft is duly registered;
 - (iii) instruments and equipment required for the execution of that flight are installed in the aircraft and are operative, unless operation with inoperative equipment is permitted by the minimum equipment list (MEL) or equivalent document, if applicable, as required in points [SPO.IDE.A.105](#) or [SPO.IDE.H.105](#);
 - (iv) the mass of the aircraft and, the centre of gravity location are such that the flight can be conducted within the limits prescribed in the airworthiness documentation;
 - (v) all equipment and baggage is properly loaded and secured;
 - (vi) the aircraft operating limitations as specified in the aircraft flight manual (AFM) will not be exceeded at any time during the flight; and
 - (vii) any navigational database required for PBN is suitable and current;
- (5) not commencing a flight if he/she, or any other crew member or task specialist is incapacitated from performing duties by any cause such as injury, sickness, fatigue or the effects of any psychoactive substance;
- (6) not continuing a flight beyond the nearest weather-permissible aerodrome or operating site when his/her or any other crew member or task specialist's capacity to perform duties is significantly reduced from causes such as fatigue, sickness or lack of oxygen;
- (7) deciding on acceptance of the aircraft with unserviceabilities in accordance with the configuration deviation list (CDL) or MEL, if applicable;
- (8) recording utilisation data and all known or suspected defects in the aircraft at the termination of the flight, or series of flights, in the aircraft technical log or journey log for the aircraft; and
- (9) ensuring that:
- (i) flight recorders are not disabled or switched off during flight;
 - (ii) in the event of an occurrence other than an accident or a serious incident that shall be reported according to [ORO.GEN.160\(a\)](#), flight recorders' recordings are not intentionally erased; and
 - (iii) in the event of an accident or a serious incident, or if preservation of recordings of flight recorders is directed by the investigating authority:
 - (A) flight recorders' recordings are not intentionally erased;
 - (B) flight recorders are deactivated immediately after the flight is completed; and
 - (C) precautionary measures to preserve the recordings of flight recorders are taken before leaving the flight crew compartment.
- (b) The pilot-in-command shall have the authority to refuse carriage of or disembark any person or cargo that may represent a potential hazard to the safety of the aircraft or its occupants.
- (c) The pilot-in-command shall, as soon as possible, report to the appropriate air traffic services (ATS) unit any hazardous weather or flight conditions encountered that are likely to affect the safety of other aircraft.

- (d) Notwithstanding the provision of (a)(6), in a multi-crew operation the pilot-in-command may continue a flight beyond the nearest weather-permissible aerodrome when adequate mitigating procedures are in place.
- (e) The pilot-in-command shall, in an emergency situation that requires immediate decision and action, take any action he/she considers necessary under the circumstances in accordance with 7.d. of Annex IV to Regulation (EC) No 216/2008. In such cases he/she may deviate from rules, operational procedures and methods in the interest of safety.
- (f) The pilot-in-command shall submit a report of an act of unlawful interference without delay to the competent authority and shall inform the designated local authority.
- (g) The pilot-in-command shall notify the nearest appropriate authority by the quickest available means of any accident involving the aircraft that results in serious injury or death of any person or substantial damage to the aircraft or property.

AMC1 SPO.GEN.107 Pilot-in-command responsibilities and authority

ED Decision 2016/021/R

FLIGHT PREPARATION FOR PBN OPERATIONS

- (a) The flight crew should ensure that RNAV 1, RNAV 2, RNP 1 RNP 2, and RNP APCH routes or procedures to be used for the intended flight, including for any alternate aerodromes, are selectable from the navigation database and are not prohibited by NOTAM.
- (b) The flight crew should take account of any NOTAMs or operator briefing material that could adversely affect the aircraft system operation along its flight plan including any alternate aerodromes.
- (c) When PBN relies on GNSS systems for which RAIM is required for integrity, its availability should be verified during the preflight planning. In the event of a predicted continuous loss of fault detection of more than five minutes, the flight planning should be revised to reflect the lack of full PBN capability for that period.
- (d) For RNP 4 operations with only GNSS sensors, a fault detection and exclusion (FDE) check should be performed. The maximum allowable time for which FDE capability is projected to be unavailable on any one event is 25 minutes. If predictions indicate that the maximum allowable FDE outage will be exceeded, the operation should be rescheduled to a time when FDE is available.
- (e) For RNAV 10 operations, the flight crew should take account of the RNAV 10 time limit declared for the inertial system, if applicable, considering also the effect of weather conditions that could affect flight duration in RNAV 10 airspace. Where an extension to the time limit is permitted, the flight crew will need to ensure that en route that radio facilities are serviceable before departure, and to apply radio updates in accordance with any AFM limitation.

AMC2 SPO.GEN.107 Pilot-in-command responsibilities and authority

ED Decision 2016/021/R

DATABASE SUITABILITY

- (a) The flight crew should check that any navigational database required for PBN operations includes the routes and procedures required for the flight.

DATABASE CURRENCY

- (b) The database validity (current AIRAC cycle) should be checked before the flight.
- (c) Navigation databases should be current for the duration of the flight. If the AIRAC cycle is due to change during flight, the flight crew should follow procedures established by the operator to ensure the accuracy of navigation data, including the suitability of navigation facilities used to define the routes and procedures for the flight.
- (d) An expired database may only be used if the following conditions are satisfied:
 - (1) the operator has confirmed that the parts of the database which are intended to be used during the flight and any contingencies that are reasonable to expect are not changed in the current version;
 - (2) any NOTAMs associated with the navigational data are taken into account;
 - (3) maps and charts corresponding to those parts of the flight are current and have not been amended since the last cycle;
 - (4) any MEL limitations are observed; and
 - (5) the database has expired by no more than 28 days.

GM1 SPO.GEN.107 Pilot-in-command responsibilities and authority

ED Decision 2019/008/R

GENERAL

In accordance with point 1.3 of Annex V to Regulation (EU) 2018/1139 (Essential Requirements for air operations), the pilot-in-command is responsible for the operation and safety of the aircraft and for the safety of all crew members, task specialists and cargo on board. This includes the following:

- (a) the safety of all persons and cargo on board, as soon as he/she arrives on board, until he/she leaves the aircraft at the end of the flight; and
- (b) the operation and safety of the aircraft:
 - (1) for aeroplanes, from the moment it is first ready to move for the purpose of flight until the moment it comes to rest at the end of the flight and the engine(s) used as primary propulsion unit(s) is/are shut down;
 - (2) for helicopters, from the moment the engine(s) are started until the helicopter comes to rest at the end of the flight with the engine(s) shut down and the rotor blades stopped.

GM1 SPO.GEN.107(a)(8) Pilot-in-command responsibilities and authority

ED Decision 2014/018/R

RECORDING UTILISATION DATA

Where an aircraft conducts a series of flights of short duration — such as a helicopter doing a series of lifts — and the aircraft is operated by the same pilot-in-command, the utilisation data for the series of flights may be recorded in the aircraft technical log or journey log as a single entry.

GM1 SPO.GEN.107(a)(9) Pilot-in-command responsibilities and authority

ED Decision 2015/030/R

IDENTIFICATION OF THE SEVERITY OF AN OCCURRENCE BY THE PILOT-IN-COMMAND

The definitions of an accident and a serious incident as well as examples thereof can be found in Regulation (EU) No 996/2010 of the European Parliament and of the Council.

AMC1 SPO.GEN.107(c) Pilot-in-command responsibilities and authority

ED Decision 2014/018/R

REPORTING OF HAZARDOUS FLIGHT CONDITIONS

- (a) These reports should include any detail which may be pertinent to the safety of other aircraft.
- (b) Such reports should be made whenever any of the following conditions are encountered or observed:
 - (1) severe turbulence;
 - (2) severe icing;
 - (3) severe mountain wave;
 - (4) thunderstorms, with or without hail, that are obscured, embedded, widespread or in squall lines;
 - (5) heavy dust storm or heavy sandstorm;
 - (6) volcanic ash cloud; and
 - (7) unusual and/or increasing volcanic activity or a volcanic eruption.
- (c) When other meteorological conditions not listed above, e.g. wind shear, are encountered that, in the opinion of the pilot-in-command, may affect the safety or the efficiency of other aircraft operations, the pilot-in-command should advise the appropriate air traffic services (ATS) unit as soon as practicable.

AMC1 SPO.GEN.107(e) Pilot-in-command responsibilities and authority

ED Decision 2014/018/R

VIOLATION REPORTING

If required by the State in which the incident occurs, the pilot-in-command should submit a report on any such violation to the appropriate authority of the said State; in that event, the pilot-in-command should also submit a copy of it to the competent authority. Such reports should be submitted as soon as possible and normally within 10 days.

SPO.GEN.110 Compliance with laws, regulations and procedures

Regulation (EU) No 379/2014

The pilot-in-command, crew members and task specialists shall comply with the laws, regulations and procedures of those States where operations are conducted.

SPO.GEN.115 Common language

Regulation (EU) No 379/2014

The operator shall ensure that all crew members and task specialists are able to communicate with each other in a common language.

SPO.GEN.119 Taxiing of aircraft

Regulation (EU) 2015/140

The operator shall establish procedures for taxiing of aircraft in order to ensure safe operation and in order to enhance runway safety.

AMC1 SPO.GEN.119 Taxiing of aircraft

ED Decision 2015/006/R

PROCEDURES FOR TAXIING

Procedures for taxiing should include at least the following:

- (a) application of sterile flight deck crew compartment procedures;
- (b) use of standard radio-telephony (RTF) phraseology;
- (c) use of lights;
- (d) measures to enhance the situational awareness of the pilot-in-command. The following list of typical items should be adapted by the operator to take into account its operational environment:
 - (1) the pilot-in-command should have the necessary aerodrome layout charts available;
 - (2) if applicable, the pilot taxiing the aircraft should announce in advance his/her intentions to the pilot monitoring;
 - (3) if applicable, all taxi clearances should be heard, and should be understood by the pilot-in-command;
 - (4) if applicable, all taxi clearances should be cross-checked against the aerodrome chart and aerodrome surface markings, signs and lights;
 - (5) an aircraft taxiing on the manoeuvring area should stop and hold at all lighted stop bars, and may proceed further when an explicit clearance to enter or cross the runway has been issued by the aerodrome control tower, and when the stop bar lights are switched off;
 - (6) if the pilot-in-command is unsure of his/her position, he/she should stop the aircraft and contact air traffic control;
 - (7) any action, which may disturb the pilot-in-command from the taxi activity, should be avoided or done with the parking brake set.

SPO.GEN.120 Taxiing of aeroplanes

Regulation (EU) No 379/2014

The operator shall ensure that an aeroplane is only taxied on the movement area of an aerodrome if the person at the controls:

- (a) is an appropriately qualified pilot; or

- (b) has been designated by the operator and:
 - (1) is trained to taxi the aeroplane;
 - (2) is trained to use the radio telephone, if radio communications are required;
 - (3) has received instruction in respect of aerodrome layout, routes, signs, marking, lights, air traffic control (ATC) signals and instructions, phraseology and procedures; and
 - (4) is able to conform to the operational standards required for safe aeroplane movement at the aerodrome.

GM1 SPO.GEN.120 Taxiing of aeroplanes

ED Decision 2015/006/R

SAFETY-CRITICAL ACTIVITY

- (a) Taxiing should be treated as a safety-critical activity due to the risks related to the movement of the aeroplane and the potential for a catastrophic event on the ground.
- (b) Taxiing is a high-workload phase of flight that requires the full attention of the flight crew.

GM1 SPO.GEN.120(b)(4) Taxiing of aeroplanes

ED Decision 2014/018/R

SKILLS AND KNOWLEDGE

The person designated by the operator to taxi an aeroplane should possess the following skills and knowledge:

- (a) positioning of the aeroplane to ensure safety when starting engine;
- (b) getting ATIS reports and taxi clearance, where applicable;
- (c) interpretation of airfield markings/lights/signals/indicators;
- (d) interpretation of marshalling signals, where applicable;
- (e) identification of suitable parking area;
- (f) maintaining lookout and right-of-way rules and complying with ATC or marshalling instructions when applicable;
- (g) avoidance of adverse effect of propeller slipstream or jet wash on other aeroplanes, aerodrome facilities and personnel;
- (h) inspection of taxi path when surface conditions are obscured;
- (i) communication with others when controlling an aeroplane on the ground;
- (j) interpretation of operational instructions;
- (k) reporting of any problem that may occur while taxiing an aeroplane; and
- (l) adapting the taxi speed in accordance with prevailing aerodrome, traffic, surface and weather conditions.

SPO.GEN.125 Rotor engagement

Regulation (EU) No 379/2014

A helicopter rotor shall only be turned under power for the purpose of flight with a qualified pilot at the controls.

GM1 SPO.GEN.125 Rotor engagement

ED Decision 2014/018/R

INTENT OF THE RULE

- (a) The following two situations where it is allowed to turn the rotor under power should be distinguished:
 - (1) for the purpose of flight, as described in the implementing rule;
 - (2) for maintenance purposes.
- (b) Rotor engagement for the purpose of flight: it should be noted that the pilot should not leave the control when the rotors are turning. For example, the pilot is not allowed to get out of the aircraft in order to welcome persons and adjust their seat belts with the rotors turning.
- (c) Rotor engagement for the purpose of maintenance: the implementing rule, however, should not prevent ground runs being conducted by qualified personnel other than pilots for maintenance purposes.

The following conditions should be applied:

- (1) The operator should ensure that the qualification of personnel, other than pilots, who are authorised to conduct maintenance runs, is described in the appropriate manual.
- (2) Ground runs should not include taxiing the helicopter.
- (3) There should be no other persons on board.
- (4) Maintenance runs should not include collective increase or auto pilot engagement (risk of ground resonance).

SPO.GEN.130 Portable electronic devices

Regulation (EU) No 379/2014

The operator shall not permit any person to use a portable electronic device (PED) on board an aircraft that could adversely affect the performance of the aircraft's systems and equipment.

GM1 SPO.GEN.130 Portable electronic devices

ED Decision 2014/032/R

DEFINITIONS

- (a) Definition and categories of PEDs

PEDs are any kind of electronic device, typically but not limited to consumer electronics, brought on board the aircraft by crew members, passengers, or as part of the cargo and that are not included in the approved aircraft configuration. All equipment that is able to consume electrical energy falls under this definition. The electrical energy can be provided from internal sources as batteries (chargeable or non-rechargeable) or the devices may also be connected to specific aircraft power sources.

PEDs include the following two categories:

- (1) Non-intentional transmitters can non-intentionally radiate RF transmissions, sometimes referred to as spurious emissions. This category includes, but is not limited to, calculators, cameras, radio receivers, audio and video players, electronic games and toys; when these devices are not equipped with a transmitting function.
- (2) Intentional transmitters radiate RF transmissions on specific frequencies as part of their intended function. In addition, they may radiate non-intentional transmissions like any PED. The term 'transmitting PED' (T-PED) is used to identify the transmitting capability of the PED. Intentional transmitters are transmitting devices such as RF-based remote control equipment, which may include some toys, two-way radios (sometimes referred to as private mobile radio), mobile phones of any type, satellite phones, computers with mobile phone data connection, wireless local area network (WLAN) or Bluetooth capability. After deactivation of the transmitting capability, e.g. by activating the so-called 'flight mode' or 'flight safety mode', the T-PED remains a PED having non-intentional emissions.

(b) Definition of the switched-off status

Many PEDs are not completely disconnected from the internal power source when switched off. The switching function may leave some remaining functionality e.g. data storage, timer, clock, etc. These devices can be considered switched off when in the deactivated status. The same applies for devices having no transmitting capability and are operated by coin cells without further deactivation capability, e.g. wrist watches.

GM2 SPO.GEN.130 Portable electronic devices

ED Decision 2014/032/R

GENERAL

- (a) PEDs can pose a risk of interference with electronically operated aircraft systems. Those systems could range from the electronic engine control, instruments, navigation or communication equipment and autopilots to any other type of avionic equipment on the aircraft. The interference can result in on-board systems malfunctioning or providing misleading information and communication disturbance. These can also lead to an increased workload for the flight crew.
- (b) Interference may be caused by transmitters being part of the PED's functionality or by unintentional transmissions from the PED. Due to the likely proximity of the PED to any electronically operated aircraft system and the generally limited shielding found in small aircraft, the risk of interference is to be considered higher than that for larger aircraft with metal airframes.
- (c) During certification of the aircraft, when qualifying the aircraft functions consideration may only have been made of short-term exposure to a high radiating field, with an acceptable mitigating measure being a return to normal function after removal of the threat. This certification assumption may not be true when operating the transmitting PED on board the aircraft.
- (d) It has been found that compliance with the electromagnetic compatibility (EMC) Directive 2004/108/EC and related European standards as indicated by the CE marking is not sufficient to exclude the existence of interference. A well-known interference is the demodulation of the transmitted signal from GSM (global system for mobile communications) mobile phones leading to audio disturbances in other systems. Similar interferences are difficult to predict during the PED design and protecting the aircraft's electronic systems against the full range of potential

interferences is practically impossible. Therefore, not operating PEDs on-board aircraft is the safest option, especially as effects may not be identified immediately but under the most inconvenient circumstances.

- (e) Guidance to follow in case of fire caused by PEDs is provided by the International Civil Aviation Organisation, 'Emergency response guidance for aircraft incidents involving dangerous goods', ICAO Doc 9481-AN/928.

SPO.GEN.131 Use of electronic flight bags (EFBs)

Regulation (EU) 2018/1975

- (a) Where an EFB is used on board an aircraft, the operator shall ensure that it does not adversely affect the performance of the aircraft systems or equipment, or the ability of the flight crew member to operate the aircraft.
- (b) Prior to using a type B EFB application, the operator shall:
 - (1) conduct a risk assessment related to the use of the EFB device that hosts the application, to the EFB application concerned and its associated function(s), identifying the associated risks and ensuring that they are appropriately mitigated; the risk assessment shall address the risks associated with the human-machine interface of the EFB device and the EFB application concerned; and
 - (2) establish an EFB administration system, including procedures and training requirements for the administration and use of the EFB device and the EFB application.

AMC1 SPO.GEN.131(a) Use of electronic flight bags (EFBs)

ED Decision 2014/018/R

ELECTRONIC FLIGHT BAGS (EFBS) — HARDWARE — COMPLEX AIRCRAFT

In addition to [AMC1 CAT.GEN.MPA.141\(a\)](#), the following should be considered:

SUITABILITY OF THE HARDWARE — COMPLEX AIRCRAFT

- (a) Display characteristics

Consideration should be given to the long-term degradation of a display as a result of abrasion and ageing. AMC 25-11 (paragraph 3.16a) may be used as guidance to assess luminance and legibility aspects.

Information displayed on the EFB should be legible to the typical user at the intended viewing distance(s) and under the full range of lighting conditions expected in a flight crew compartment, including direct sunlight.

Users should be able to adjust the screen brightness of an EFB independently of the brightness of other displays in the flight crew compartment. In addition, when incorporating an automatic brightness adjustment, it should operate independently for each EFB in the flight crew compartment. Brightness adjustment using software means may be acceptable provided that this operation does not adversely affect the flight crew workload.

Buttons and labels should have adequate illumination for night use. 'Buttons and labels' refers to hardware controls located on the display itself.

All controls should be properly labelled for their intended function, except if no confusion is possible.

The 90-degree viewing angle on either side of each flight crew member's line of sight may be unacceptable for certain EFB applications if aspects of the display quality are degraded at large viewing angles (e.g. the display colours wash out or the displayed colour contrast is not discernible at the installation viewing angle).

(b) Power source

The design of a portable EFB system should consider the source of electrical power, the independence of the power sources for multiple EFBs, and the potential need for an independent battery source. A non-exhaustive list of factors to be considered includes:

- (1) the possibility to adopt operational procedures to ensure an adequate level of safety (for example, ensure a minimum level of charge before departure);
- (2) the possible redundancy of portable EFBs to reduce the risk of exhausted batteries;
- (3) the availability of backup battery packs to assure an alternative source of power.

Battery-powered EFBs that have aircraft power available for recharging the internal EFB batteries are considered to have a suitable backup power source.

For EFBs that have an internal battery power source and that are used as an alternative for paper documentation that is required by [SPO.GEN.140](#), the operator should either have at least one EFB connected to an aircraft power bus or have established mitigation means and procedures to ensure that sufficient power with acceptable margins will be available during the whole flight.

(c) Environmental testing

Environmental testing, in particular testing for rapid decompression, should be performed when the EFB hosts applications that are required to be used during flight following a rapid decompression and/or when the EFB environmental operational range is potentially insufficient with respect to the foreseeable flight crew compartment operating conditions.

The information from the rapid-decompression test of an EFB is used to establish the procedural requirements for the use of that EFB device in a pressurised aircraft. Rapid-decompression testing should follow the EUROCAE ED-14D/RTCA DO-160D (or later revisions) guidelines for rapid-decompression testing up to the maximum operating altitude of the aircraft at which the EFB is to be used.

- (1) Pressurised aircraft: when a portable EFB has successfully completed rapid-decompression testing, then no mitigating procedures for depressurisation events need to be developed. When a portable EFB has failed the rapid-decompression testing while turned ON, but successfully completed it when turned OFF, then procedures should ensure that at least one EFB on board the aircraft remains OFF during the applicable flight phases or that it is configured so that no damage will be incurred should rapid decompression occur in flight at an altitude higher than 10 000 ft above mean sea level (AMSL).

If an EFB system has not been tested or it has failed the rapid-decompression test, then alternate procedures or paper backup should be available.

- (2) Non-pressurised aircraft: rapid-decompression testing is not required for an EFB used in a non-pressurised aircraft. The EFB should be demonstrated to reliably operate up to the maximum operating altitude of the aircraft. If the EFB cannot be operated at the maximum operating altitude of the aircraft, procedures should be established to preclude

operation of the EFB above the maximum demonstrated EFB operating altitude while still maintaining availability of any required aeronautical information displayed on the EFB.

The results of testing performed on a specific EFB model configuration (as identified by the EFB hardware manufacturer) may be applied to other aircraft installations and these generic environmental tests may not need to be duplicated. The operator should collect and retain:

- (1) evidence of these tests that have already been accomplished; or
- (2) suitable alternative procedures to deal with the total loss of the EFB system.

Rapid decompression tests do not need to be repeated if the EFB model identification and the battery type do not change.

The testing of operational EFBs should be avoided if possible to preclude the infliction of unknown damage to the unit during testing.

Operators should account for the possible loss or erroneous functioning of the EFB in abnormal environmental conditions.

The safe stowage and the use of the EFB under any foreseeable environmental conditions in the flight crew compartment, including turbulence, should be evaluated.

AMC2 SPO.GEN.131(a) Use of electronic flight bags (EFBs)

ED Decision 2019/008/R

ELECTRONIC FLIGHT BAGS (EFBS) — HARDWARE — NON-COMPLEX AIRCRAFT

The same considerations as those in [AMC1 NCO.GEN.125](#) should apply in respect of EFB hardware.

AMC1 SPO.GEN.131(b) Use of electronic flight bags (EFBs)

ED Decision 2019/008/R

ELECTRONIC FLIGHT BAGS (EFBS) — SOFTWARE — COMPLEX AIRCRAFT

The same considerations as those in [AMC1 CAT.GEN.MPA.141\(b\)](#), [AMC2 CAT.GEN.MPA.141\(b\)](#) and [AMC3 CAT.GEN.MPA.141\(b\)](#) should apply in respect of EFB software.

AMC2 SPO.GEN.131(b) Use of electronic flight bags (EFBs)

ED Decision 2019/008/R

ELECTRONIC FLIGHT BAGS (EFBS) — SOFTWARE — NON-COMPLEX AIRCRAFT

The same considerations as those in [AMC2 NCO.GEN.125](#) should apply in respect of EFB software.

AMC1 SPO.GEN.131(b)(1) Use of electronic flight bags (EFBs)

ED Decision 2019/008/R

RISK ASSESSMENT — COMPLEX AIRCRAFT

- (a) General

Prior to the use of any EFB system, the operator should perform a risk assessment for all type B EFB applications and for the related hardware as part of its hazard identification and risk management process.

The operator may make use of a risk assessment established by the software developer. However, the operator should ensure that its specific operational environment is taken into account.

The risk assessment should:

- (1) evaluate the risks associated with the use of an EFB;
- (2) identify potential losses of function or malfunction (with detected and undetected erroneous outputs) and the associated failure scenarios;
- (3) analyse the operational consequences of these failure scenarios;
- (4) establish mitigating measures; and
- (5) ensure that the EFB system (hardware and software) achieves at least the same level of accessibility, usability, and reliability as the means of presentation it replaces.

In considering the accessibility, usability, and reliability of the EFB system, the operator should ensure that the failure of the complete EFB system as well as of individual applications, including corruption or loss of data and erroneously displayed information, has been assessed and that the risks have been mitigated to an acceptable level.

This risk assessment should be defined before the beginning of the trial period and should be amended accordingly, if necessary, at the end of this trial period. The results of the trial should establish the configuration and use of the system.

When the EFB system is intended to be introduced alongside a paper-based system, only the failures that would not be mitigated by the use of the paper-based system need to be addressed. In all other cases, a complete risk assessment should be performed.

(b) Assessing and mitigating the risks

Some parameters of EFB applications may depend on entries made by flight crew/dispatchers, whereas others may be default parameters from within the system that are subject to an administration process (e.g. the runway line-up allowance in an aircraft performance application). In the first case, mitigation means would mainly concern training and flight crew procedure aspects, whereas in the second case, mitigation means would more likely focus on the EFB administration and data management aspects.

The analysis should be specific to the operator concerned and should address at least the following points:

- (1) The minimisation of undetected erroneous outputs from applications and assessment of the worst-credible scenario;
- (2) Erroneous outputs from the software application including:
 - (i) a description of the corruption scenarios; and
 - (ii) a description of the mitigation means;
- (3) Upstream processes including:
 - (i) the reliability of root data used in applications (e.g. qualified input data, such as databases produced under ED-76/DO-200A 'Standards for Processing Aeronautical Data');
 - (ii) the software application validation and verification checks according to appropriate industry standards, if applicable; and

- (iii) the independence between application software components, e.g. robust partitioning between EFB applications and other airworthiness certified software applications;
- (4) A description of the mitigation means to be used following the detected failure of an application, or of a detected erroneous output;
- (5) The need for access to an alternate power supply in order to ensure the availability of software applications, especially if they are used as a source of required information.

As part of the mitigation means, the operator should consider establishing a reliable alternative means to provide the information available on the EFB system.

The mitigation means could be, for example, one of, or a combination of, the following:

- (1) the system design (including hardware and software);
- (2) a backup EFB device, possibly supplied from a different power source;
- (3) EFB applications being hosted on more than one platform;
- (4) a paper backup (e.g. quick reference handbook (QRH)); and
- (5) procedural means;

Depending on the outcome of its risk assessment, the operator may also consider performing an operational evaluation test before allowing unrestricted use of its EFB devices and applications.

EFB system design features such as those assuring data integrity and the accuracy of performance calculations (e.g. a 'reasonableness' or 'range' check) may be integrated in the risk assessment to be performed by the operator.

(c) Changes

The operator should update its EFB risk assessment based on the planned changes to its EFB system.

However, modifications to the operator's EFB system which:

- (1) do not bring any change to the calculation algorithms and/or to the HMI of a type B EFB application;
 - (2) introduce a new type A EFB application or modify an existing one (provided its software classification remains type A);
 - (3) do not introduce any additional functionality to an existing type B EFB application;
 - (4) update an existing database necessary to use an existing type B EFB application; or
 - (5) do not require a change to the flight crew training or operational procedures,
- may be introduced by the operator without having to update its risk assessment.

These changes should, nevertheless, be controlled and properly tested prior to use in flight.

The modifications in the following non-exhaustive list are considered to meet these criteria:

- (1) operating system updates;
- (2) chart or airport database updates;
- (3) updates to introduce fixes (patches); and

- (4) installation and modification of a type A EFB application.

GM1 SPO.GEN.131(b)(1) Use of electronic flight bags (EFBs)

ED Decision 2019/008/R

RISK ASSESSMENT— NON-COMPLEX AIRCRAFT

The operator of non-complex motor-powered aircraft should at least perform the check before the flight actions described in paragraph (b) of [AMC2 NCO.GEN.125](#).

AMC1 SPO.GEN.131(b)(2) Use of electronic flight bags (EFBs)

ED Decision 2019/008/R

EFB ADMINISTRATION — COMPLEX AIRCRAFT

The operator should ensure:

- (a) that adequate support is provided to the EFB users for all the applications installed;
- (b) that potential security issues associated with the application installed have been checked;
- (c) that hardware and software configuration is appropriately managed and that no unauthorised software is installed.

The operator should ensure that miscellaneous software applications do not adversely impact on the operation of the EFB and should include miscellaneous software applications in the scope of EFB configuration management;

- (d) that only a valid version of the application software and current data packages are installed on the EFB system; and
- (e) the integrity of the data packages used by the applications installed.

AMC2 SPO.GEN.131(b)(2) Use of electronic flight bags (EFBs)

ED Decision 2019/008/R

PROCEDURES — COMPLEX AIRCRAFT

The procedures for the administration or the use of the EFB device and the type B EFB application may be fully or partly integrated in the operations manual.

- (a) General

If an EFB system generates information similar to that generated by existing certified systems, procedures should clearly identify which information source will be the primary, which source will be used for backup information, and under which conditions the backup source should be used. Procedures should define the actions to be taken by the flight crew when information provided by an EFB system is not consistent with that from other flight crew compartment sources, or when one EFB system shows different information than the other.

In the case of EFB applications providing information which might be affected by Notice(s) to Airmen (NOTAMS) (e.g. Airport moving map display (AMMD), performance calculation, etc.), the procedure for the use of these applications should include the handling of the relevant NOTAMS before their use.

(b) Flight crew awareness of EFB software/database revisions

The operator should have a process in place to verify that the configuration of the EFB, including software application versions and, where applicable, database versions, are up to date. Flight crew members should have the ability to easily verify the validity of database versions used on the EFB. Nevertheless, flight crew members should not be required to confirm the revision dates for other databases that do not adversely affect flight operations, such as maintenance log forms or a list of airport codes. An example of a date-sensitive revision is that applied to an aeronautical chart database. Procedures should specify what actions should be taken if the software applications or databases loaded on the EFB system are outdated.

(c) Workload mitigation and/or control

The operator should ensure that additional workload created by using an EFB system is adequately mitigated and/or controlled. The operator should ensure that, while the aircraft is in flight or moving on the ground, flight crew members do not become preoccupied with the EFB system at the same time. Workload should be shared between flight crew members to ensure ease of use and continued monitoring of other flight crew functions and aircraft equipment. This should be strictly applied in flight and the operator should specify any times when the flight crew members may not use the specific EFB application.

(d) Dispatch

The operator should establish dispatch criteria for the EFB system, when type B EFB applications that replace paper products are hosted. The operator should ensure that the availability of the EFB system is confirmed by preflight checks. Instructions to the flight crew should clearly define the actions to be taken in the event of any EFB system deficiency.

Mitigation may be in the form of maintenance and/or operational procedures for items such as:

- (1) replacement of batteries at defined intervals as required;
- (2) ensuring that there is a fully charged backup battery on board;
- (3) the flight crew checking the battery charging level before departure; and
- (4) the flight crew switching off the EFB in a timely manner when the aircraft power source is lost.

In the event of a partial or complete failure of the EFB, specific dispatch procedures should be followed. These procedures should be included either in the minimum equipment list (MEL) or in the operations manual and should ensure an acceptable level of safety.

Particular attention should be paid to establishing specific dispatch procedures allowing to obtain operational data (e.g. performance data) in the event of a failure of an EFB that hosts an application providing such calculated data.

When the integrity of data input and output is verified by cross-checking and gross-error checks, the same checking principle should be applied to alternative dispatch procedures to ensure equivalent protection.

(e) Maintenance

Procedures should be established for the routine maintenance of the EFB system and detailing how unserviceability and failures are to be dealt with to ensure that the integrity of the EFB system is preserved. Maintenance procedures should also include the secure handling of updated information and how this information is validated and then promulgated in a timely manner and in a complete format to all users.

As part of the EFB system's maintenance, the operator should ensure that the EFB system batteries are periodically checked and replaced as required.

Should a fault or failure of the system arise, it is essential that such failures are brought to the immediate attention of the flight crew and that the system is isolated until rectification action is taken. In addition to backup procedures, to deal with system failures, a reporting system should be in place so that the necessary action, either to a particular EFB system or to the whole system, is taken in order to prevent the use of erroneous information by flight crew members.

(f) Security

The EFB system (including any means used for updating it) should be secure from unauthorised intervention (e.g. by malicious software). The operator should ensure that the system is adequately protected at the software level and that the hardware is appropriately managed (e.g. the identification of the person to whom the hardware is released, protected storage when the hardware is not in use) throughout the operational lifetime of the EFB system. The operator should ensure that prior to each flight the EFB operational software works as specified and the EFB operational data is complete and accurate. Moreover, a system should be in place to ensure that the EFB does not accept a data load that contains corrupted contents. Adequate measures should be in place for the compilation and secure distribution of data to the aircraft.

Procedures should be transparent and easy to understand, to follow and to oversee that:

- (1) if an EFB is based on consumer electronics (e.g. a laptop) which can be easily removed, manipulated, or replaced by a similar component, that special consideration is given to the physical security of the hardware;
- (2) portable EFB platforms are subject to allocation tracking to specific aircraft or persons;
- (3) where a system has input ports, and especially if widely known protocols are used through these ports or internet connections are offered, that special consideration is given to the risks associated with these ports;
- (4) where physical media are used to update the EFB system, and especially if widely known types of physical media are used, that the operator uses technologies and/or procedures to assure that unauthorised content cannot enter the EFB system through these media.

The required level of EFB security depends on the criticality of the functions used (e.g. an EFB that only holds a list of fuel prices may require less security than an EFB used for performance calculations).

Beyond the level of security required to assure that the EFB can properly perform its intended functions, the level of security that is ultimately required depends on the capabilities of the EFB.

(g) Electronic signatures

Some applicable requirements may require a signature when issuing or accepting a document (e.g. load sheet, technical logbook, notification to captain (NOTOC)). In order to be accepted as being equivalent to a handwritten signature, electronic signatures used in EFB applications need, as a minimum, to fulfil the same objectives and should assure the same degree of security as the handwritten or any other form of signature that they are intended to replace. [GM1 SPO.POL.115](#) provides guidance related to the required handwritten signature or its equivalent for mass and balance documentation.

On a general basis, in the case of legally required signatures, an operator should have in place procedures for electronic signatures that guarantee:

- (1) their uniqueness: a signature should identify a specific individual and should be difficult to duplicate;
- (2) their significance: an individual using an electronic signature should take deliberate and recognisable action to affix their signature;
- (3) their scope: the scope of the information being affirmed with an electronic signature should be clear to the signatory and to the subsequent readers of the record, record entry, or document;
- (4) their security: the security of an individual's handwritten signature is maintained by ensuring that it is difficult for another individual to duplicate or alter it;
- (5) their non-repudiation: an electronic signature should prevent a signatory from denying that they affixed a signature to a specific record, record entry, or document; the more difficult it is to duplicate a signature, the more likely it is that the signature was created by the signatory; and
- (6) their traceability: an electronic signature should provide positive traceability to the individual who signed a record, record entry, or any other document.

An electronic signature should retain those qualities of a handwritten signature that guarantee its uniqueness. Systems using either a PIN or a password with limited validity (timewise) may be appropriate in providing positive traceability to the individual who affixed it. Advanced electronic signatures, qualified certificates and secured signature-creation devices needed to create them in the context of Regulation (EU) No 910/2014¹ are typically not required for EFB operations.

AMC3 SPO.GEN.131(b)(2) Use of electronic flight bags (EFBs)

ED Decision 2019/008/R

FLIGHT CREW TRAINING — COMPLEX AIRCRAFT

Flight crew members should be given specific training on the use of the EFB system before it is operationally used.

Training should at least include the following:

- (a) an overview of the system architecture;
- (b) preflight checks of the system;
- (c) limitations of the system;
- (d) specific training on the use of each application and the conditions under which the EFB may and may not be used;
- (e) restrictions on the use of the system, including cases where the entire system, or some parts of it, are not available;
- (f) procedures for normal operations, including cross-checking of data entry and computed information;
- (g) procedures to handle abnormal situations, such as a late runway change or a diversion to an alternate aerodrome;

¹ Regulation (EU) No 910/2014 of the European Parliament and of the Council of 23 July 2014 on electronic identification and trust services for electronic transactions in the internal market and repealing Directive 1999/93/EC (OJ L 257, 28.8.2014, p. 73).

- (h) procedures to handle emergency situations;
- (i) phases of the flight when the EFB system may and may not be used;
- (j) human factors considerations, including crew resource management (CRM);
- (k) additional training for new applications or changes to the hardware configuration;
- (l) actions following the failure of component(s) of the EFB, including cases of battery smoke or fire; and
- (m) management of conflicting information.

AMC4 SPO.GEN.131(b)(2) Use of electronic flight bags (EFBs)

ED Decision 2019/008/R

PERFORMANCE AND MASS AND BALANCE APPLICATIONS — COMPLEX AIRCRAFT

(a) General

Performance and mass and balance applications should be based on existing published data found in the AFM or performance manual and should account for the applicable CAT.POL performance requirements. The applications may use algorithms or data spreadsheets to determine results. They may have the capability to interpolate within the information contained in the published data for the particular aircraft but should not extrapolate beyond it.

To protect against intentional and unintentional modifications, the integrity of the database files related to performance and mass and balance (the performance database, airport database, etc.) should be checked by the program before performing any calculations. This check can be run once at the start-up of the application.

Each software version should be identified by a unique version number. The performance and mass and balance applications should record each computation performed (inputs and outputs) and the operator should ensure that this information is retained for at least 3 months.

The operator should ensure that aircraft performance or mass and balance data provided by the application is correct compared with the data derived from the AFM (e.g. for take-off and landing performance data) or from other reference data sources (e.g. mass and balance manuals or databases, in flight performance manuals or databases) under a representative cross-check of conditions (e.g. for take-off and landing performance applications: take-off and landing performance data on dry, wet, and contaminated runways, with different wind conditions and aerodrome pressure altitudes, etc.).

The operator should define any new roles that the flight crew and, if applicable, the flight dispatcher, may have in creating, reviewing, and using performance calculations supported by EFB systems.

(b) Testing

The verification of compliance of a performance or mass and balance application should include software testing activities performed with the software version candidate for operational use.

The testing can be performed either by the operator or a third party, as long as the testing process is documented and the responsibilities identified.

The testing activities should include reliability testing and accuracy testing.

Reliability testing should show that the application in its operating environment (operating system (OS) and hardware included) is stable and deterministic, i.e. identical answers are generated each time the process is entered with identical parameters.

Accuracy testing should demonstrate that the aircraft performance or mass and balance computations provided by the application are correct in comparison with data derived from the AFM or other reference data sources, under a representative cross section of conditions (e.g. for take-off and landing performance applications: runway state and slope, different wind conditions and pressure altitudes, various aircraft configurations including failures with a performance impact, etc.).

The verification should include a sufficient number of comparison results from representative calculations throughout the entire operating envelope of the aircraft, considering corner points, routine and break points.

Any difference compared to the reference data that is judged significant should be examined. When differences are due to more conservative calculations or reduced margins that were purposely built into the approved data, this approach should be clearly specified. Compliance with the applicable certification and operational rules needs to be assessed in any case.

The testing method should be described. The testing may be automated when all the required data is available in an appropriate electronic format, but in addition to performing thorough monitoring of the correct functioning and design of the testing tools and procedures, operators are strongly suggested to perform additional manual verification. It could be based on a few scenarios for each chart or table of the reference data, including both operationally representative scenarios and 'corner-case' scenarios.

The testing of a software revision should, in addition, include non-regression testing and testing of any fix or change.

Furthermore, an operator should perform tests related to its customisation of the applications and to any element pertinent to its operation that was not covered at an earlier stage (e.g. airport database verification).

(c) Procedures

Specific care is needed regarding the crew procedures concerning take-off and landing performance or mass and balance applications. The crew procedures should ensure that:

- (1) calculations are performed independently by each flight crew member before data outputs are accepted for use;
- (2) a formal cross-check is made before data outputs are accepted for use; such cross-checks should utilise the independent calculations described above, together with the output of the same data from other sources on the aircraft;
- (3) a gross-error check is performed before data outputs are accepted for use; such gross-error checks may use either a 'rule of thumb' or the output of the same data from other sources on the aircraft; and
- (4) in the event of a loss of functionality of an EFB through either the loss of a single application, or the failure of the device hosting the application, an equivalent level of safety can be maintained; consistency with the EFB risk assessment assumptions should be confirmed.

(d) Training

The training should emphasise the importance of executing all take-off and landing performance or mass and balance calculations in accordance with the SOPs to assure fully independent calculations.

Furthermore, due to the optimisation at different levels brought by performance applications, the flight crew members may be confronted with new procedures and different aircraft behaviour (e.g. the use of multiple flap settings for take-off). The training should be designed and provided accordingly.

Where an application allows the computing of both dispatch results (from regulatory and factored calculations) and other results, the training should highlight the specificities of those results. Depending on the representativeness of the calculation, the flight crew should be trained on any operational margins that might be required.

The training should also address the identification and the review of default values, if any, and assumptions about the aircraft status or environmental conditions made by the application.

(e) Specific considerations for mass and balance applications

In addition to the figures, a diagram displaying the mass and its associated centre of gravity (CG) should be provided.

(f) Human-factors-specific considerations

Input data and output data (i.e. results) shall be clearly separated from each other. All the information necessary for a given calculation task should be presented together or be easily accessible.

All input and output data should include correct and unambiguous terms (names), units of measurement (e.g. kg or lb), and, when applicable, an index system and a CG-position declaration (e.g. Arm/%MAC). The units should match the ones from the other flight-crew-compartment sources for the same kind of data.

Airspeeds should be provided in a way that is directly useable in the flight crew compartment, unless the unit clearly indicates otherwise (e.g. Knots Calibrated Air Speed (KCAS)). Any difference between the type of airspeed provided by the EFB application and the type provided by the AFM or flight crew operating manual (FCOM) performance charts should be mentioned in the flight crew guides and training material.

If the landing performance application allows the computation of both dispatch results (regulatory, factored) and other results (e.g. in-flight or unfactored), the flight crew members should be made aware of the computation mode used.

(1) Inputs

The application should allow users to clearly distinguish user entries from default values or entries imported from other aircraft systems.

Performance applications should allow the flight crew to check whether a certain obstacle is included in the performance calculation and/or to include new or revised or new obstacle information in the performance calculations.

(2) Outputs

All critical assumptions for performance calculation (e.g. the use of thrust reversers, full or reduced thrust/power rating) should be clearly displayed. The assumptions made

about any calculation should be at least as clear to the flight crew members as similar information would be on a tabular chart.

All output data should be available in numbers.

The application should indicate when a set of entries results in an unachievable operation (for instance, a negative stopping margin) with a specific message or colour scheme. This should be done in accordance with the relevant provisions on messages and the use of colours.

In order to allow a smooth workflow and to prevent data entry errors, the layout of the calculation outputs should be such that it is consistent with the data entry interface of the aircraft applications in which the calculation outputs are used (e.g. flight management systems).

(3) Modifications

The user should be able to easily modify performance calculations, especially when making last-minute changes.

The results of calculations and any outdated input fields should be deleted whenever:

- (i) modifications are entered;
- (ii) the EFB is shut down or the performance application is closed; or
- (iii) the EFB or the performance application has been in a standby or 'background' mode for too long, i.e. such that it is likely that when it is used again, the inputs or outputs will be outdated.

AMC5 SPO.GEN.131(b)(2) Use of electronic flight bags (EFBs)

ED Decision 2019/008/R

AIRPORT MOVING MAP DISPLAY (AMMD) APPLICATION WITH OWN-SHIP POSITION — COMPLEX AIRCRAFT

(a) General

An AMMD application should not be used as the primary means of navigation for taxiing and should be only used in conjunction with other materials and procedures identified within the operating concept (see paragraph (e)).

When an AMMD is in use, the primary means of navigation for taxiing remains the use of normal procedures and direct visual observation out of the flight-crew-compartment window.

Thus, as recognised in ETSO-C165a, an AMMD application with a display of own-ship position is considered to have a minor safety effect for malfunctions that cause the incorrect depiction of aircraft position (own-ship), and the failure condition for the loss of function is classified as 'no safety effect'.

(b) Minimum requirements

AMMD software that complies with European Technical Standard Order ETSO-C165a is considered to be acceptable.

In addition, the system should provide the means to display the revision number of the software installed.

To achieve the total system accuracy requirements of ETSO-C165a, an airworthiness-approved sensor using the global positioning system (GPS) in combination with a medium-accuracy

database compliant with EUROCAE ED-99C/RTCA DO-272C, 'User Requirements for Aerodrome Mapping Information' (or later revisions) is considered one acceptable means.

Alternatively, the use of non-certified commercial off-the-shelf (COTS) position sources may be acceptable in accordance with [AMC6 SPO.GEN.131\(b\)\(2\)](#).

(c) Data provided by the AMMD software application developer

The operator should ensure that the AMMD software application developer provides the appropriate data including:

(1) installation instructions or equivalent as per ETSO-C165a Section 2.2 addressing:

- (i) the identification of each specific EFB system computing platform (including the hardware platform and the operating system version) with which this AMMD software application and database was demonstrated to be compatible;
- (ii) the installation procedures and limitations for each applicable platform (e.g. required memory resources, configuration of Global Navigation Satellite System (GNSS) antenna position);
- (iii) the interface description data including the requirements for external sensors providing data inputs; and
- (iv) means to verify that the AMMD has been installed correctly and is functioning properly;

(2) any AMMD limitations, and known installation, operational, functional, or performance issues of the AMMD.

(d) AMMD software installation in the EFB

The operator should review the documents and the data provided by the AMMD developer, and ensure that the installation requirements of the AMMD software in the specific EFB platform and aircraft are addressed. Operators are required to perform any verification activities proposed by the AMMD software application developer, as well as identify and perform any additional integration activities that needs to be completed;

(e) Operational procedures

Changes to operational procedures of the aircraft (e.g. flight crew procedures) should be documented in the operations manual or user's guide as appropriate. In particular, the documentation should highlight that the AMMD is designed to assist flight crew members in orienting themselves on the airport surface so as to improve the flight crew members' positional awareness during taxiing and that it is not to be used as the basis for ground manoeuvring.

(f) Training requirements

The operator may use flight crew procedures to mitigate some hazards. These should include limitations on the use of the AMMD function or application. As the AMMD could be a compelling display and the procedural restrictions are a key component of the mitigation, training should be provided in support of an AMMD implementation.

All mitigation means that rely on flight crew procedures should be included in the flight crew training. Details of the AMMD training should be included in the operator's overall EFB training.

AMC6 SPO.GEN.131(b)(2) Use of electronic flight bags (EFBs)

ED Decision 2019/008/R

USE OF COMMERCIAL OFF-THE-SHELF (COTS) POSITION SOURCE — COMPLEX AIRCRAFT

COTS position sources may be used for AMMD EFB applications and for EFB applications displaying the own-ship position in flight when the following considerations are complied with:

(a) Characterisation of the receiver:

The position should originate from an airworthiness approved GNSS receiver, or from a COTS GNSS receiver fully characterised in terms of technical specifications and featuring an adequate number of channels (12 or more).

The EFB application should, in addition to position and velocity data, receive a sufficient number of parameters related to the fix quality and integrity to allow compliance with the accuracy requirements (e.g. the number of satellites and constellation geometry parameters such as dilution of position (DOP), 2D/3D fix).

(b) Installation aspects:

COTS position sources are C-PEDs and their installation and use should follow the requirements of [SPO.GEN.130](#).

If the external COTS position source transmits wirelessly, cybersecurity aspects have to be considered.

(c) Practical evaluation:

As variables can be introduced by the placement of the antennas in the aircraft and the characteristics of the aircraft itself (e.g. heated and/or shielded windshield effects), the tests have to take place on the type of aircraft in which the EFB will be operated, with the antenna positioned at the location to be used in service.

(1) COTS used as a position source for AMMD

The test installation should record the data provided by the COTS position source to the AMMD application.

The analysis should use the the recorded parameters to demonstrate that the AMMD requirements are satisfactorily complied with in terms of the total system accuracy (taking into account database errors, latency effects, display errors, and uncompensated antenna offsets) within 50 metres (95 %). The availability should be sufficient to prevent distraction or increased workload due to frequent loss of position.

When demonstrating compliance with the following requirements of DO-257A, the behaviour of the AMMD system should be evaluated in practice:

- (i) indication of degraded position accuracy within 1 second (Section 2.2.4 (22)); and
- (ii) indication of a loss of positioning data within 5 seconds (Section 2.2.4 (23)); conditions to consider are both a loss of the GNSS satellite view (e.g. antenna failure) and a loss of communication between the receiver and the EFB.

(2) COTS position source used for applications displaying own-ship position in flight:

Flight trials should demonstrate that the COTS GNSS availability is sufficient to prevent distraction or increased workload due to frequent loss of position.

AMC7 SPO.GEN.131(b)(2) Use of electronic flight bags (EFBs)

ED Decision 2019/008/R

CHART APPLICATIONS — COMPLEX AIRCRAFT

The navigation charts that are depicted should contain the information necessary, in an appropriate form, to perform the operation safely. Consideration should be given to the size, resolution and position of the display to ensure legibility whilst retaining the ability to review all information required to maintain adequate situational awareness. The identification of risks associated with the human-machine interface, as part of the operator's risk assessment, is key to identifying acceptable mitigation means, e.g.:

- (a) to establish procedures to reduce the risk of making errors;
- (b) to control and mitigate the additional workload related to EFB use;
- (c) to ensure the consistency of colour-coding and symbology philosophies between EFB applications and their compatibility with other flight crew compartment applications; and
- (d) to consider aspects of crew resource management (CRM) when using an EFB system.

In the case of chart application displaying own-ship position in flight, [AMC9 SPO.GEN.131\(b\)\(2\)](#) is applicable.

AMC8 SPO.GEN.131(b)(2) Use of electronic flight bags (EFBs)

ED Decision 2019/008/R

IN-FLIGHT WEATHER APPLICATIONS — COMPLEX AIRCRAFT

- (a) General

An in-flight weather (IFW) application is an EFB function or application enabling the flight crew to access meteorological information. It is designed to increase situational awareness and to support the flight crew when making strategic decisions.

An IFW function or application may be used to access both information required to be on board (e.g. World Area Forecast Centre (WAFIC) data) and supplemental weather information.

The use of IFW applications should be non-safety-critical and not necessary for the performance of the flight. In order to be non-safety-critical, IFW data should not be used to support tactical decisions and/or as a substitute for certified aircraft systems (e.g. weather radar).

Any current information from the meteorological documentation required to be on board or from aircraft primary systems should always prevail over the information from an IFW application.

The displayed meteorological information may be forecasted and/or observed, and may be updated on the ground and/or in flight. It should be based on data from certified meteorological services providers or other reliable sources evaluated by the operator.

The meteorological information provided to the flight crew should be as far as possible consistent with the information available to users of ground-based aviation meteorological information (e.g. operations control centre (OCC), dispatchers, etc.) in order to establish common situational awareness and to facilitate collaborative decision-making.

(b) Display

Meteorological information should be presented to the flight crew in a format that is appropriate to the content of the information; coloured graphical depiction is encouraged whenever practicable.

The IFW display should enable the flight crew to:

- (1) distinguish between observed and forecasted weather data;
- (2) identify the currency or age and validity time of the weather data;
- (3) access the interpretation of the weather data (e.g. the legend);
- (4) obtain positive and clear indications of any missing information or data and determine areas of uncertainty when making decisions to avoid hazardous weather; and
- (5) be aware of the data-link means status enabling necessary IFW data exchanges.

Meteorological information in IFW applications may be displayed, for example, as an overlay over navigation charts, over geographical maps, or it may be a stand-alone weather depiction (e.g. radar plots, satellite images, etc.).

If meteorological information is overlaid on navigation charts, special consideration should be given to HMI issues in order to avoid adverse effects on the basic chart functions.

In case of display of own-ship position in flight, [AMC9 SPO.GEN.131\(b\)\(2\)](#) is applicable.

The meteorological information may require reformatting to accommodate, for example, the display size or the depiction technology. However, any reformatting of the meteorological information should preserve both the geo-location and intensity of the meteorological conditions regardless of projection, scaling, or any other types of processing.

(c) Training and procedures

The operator should establish procedures for the use of an IFW application.

The operator should provide adequate training to the flight crew members before using an IFW application. This training should address:

- (1) limitations of the use of an IFW application:
 - (i) acceptable use (strategic planning only);
 - (ii) information required to be on board; and
 - (iii) latency of observed weather information and the hazards associated with utilisation of old information;
- (2) information on the display of weather data:
 - (i) type of displayed information (forecasted, observed);
 - (ii) symbology (symbols, colours); and
 - (iii) interpretation of meteorological information;
- (3) identification of failures and malfunctions (e.g. incomplete uplinks, data-link failures, missing info);
- (4) human factors issues:
 - (i) avoiding fixation; and

- (ii) managing workload.

AMC9 SPO.GEN.131(b)(2) Use of electronic flight bags (EFBs)

ED Decision 2019/008/R

APPLICATIONS DISPLAYING OWN-SHIP POSITION IN FLIGHT — COMPLEX AIRCRAFT

(a) Limitations

The display of own-ship position in flight as an overlay to other EFB applications should not be used as a primary source of information to fly or navigate the aircraft.

Except on VFR flights over routes navigated by reference to visual landmark, the display of the own-ship symbol is allowed only in aircraft having a certified navigation display (moving map).

In the specific case of IFW applications, the display of own-ship on such applications is restricted to aircraft equipped with a weather radar.

(b) Position source and accuracy

The display of own-ship position may be based on a certified GNSS or GNSS based (e.g. GPS/IRS) position from certified aircraft equipment or on a portable COTS position source in accordance with [AMC6 SPO.GEN.131\(b\)\(2\)](#).

The own-ship symbol should be removed and the flight crew notified if:

- (1) the estimated accuracy is not sufficient for the intended operations;
- (2) the position data is reported as invalid by the GNSS receiver; or
- (3) the position data is not received for 5 seconds.

(c) Charting data considerations

The display of own-ship position is only allowed when the underlying map/chart data is designed using a projection system that is suitable for aeronautical use.

If the map involves raster images that have been stitched together into a larger single map, it should be demonstrated that the stitching process does not introduce distortion or map errors that would not correlate properly with a GNSS-based own-ship symbol.

(d) Human machine interface (HMI)

(1) Interface

The flight crew should be able to unambiguously differentiate the EFB function from avionics functions available in the cockpit, and in particular with the navigation display.

A sufficiently legible text label 'AIRCRAFT POSITION NOT TO BE USED FOR NAVIGATION' or equivalent should be continuously displayed by the application if the own-ship position depiction is visible in the current display area over a terminal chart (i.e. SID, STAR, or instrument approach) or a depiction of a terminal procedure.

(2) Display of own-ship symbol

The own-ship symbol should be different from the ones used by certified aircraft systems intended for primary navigation.

If directional data is available, the own-ship symbol may indicate directionality. If direction is not available, the own-ship symbol should not imply directionality.

The colour coding should not be inconsistent with the manufacturer philosophy

(3) Data displayed

The current map orientation should be clearly, continuously and unambiguously indicated (e.g., Track-up vs North-up).

If the software supports more than one directional orientation for the own-ship symbol (e.g., Track-up vs North-up), the current own-ship symbol orientation should be indicated.

The chart display in track-up mode should not create usability or readability issues. In particular, chart data should not be rotated in a manner that affects readability.

The application zoom levels should be appropriate for the function and content being displayed and in the context of providing supplemental position awareness.

The pilot should be able to obtain information about the operational status of the own-ship function (e.g. active, deactivated, degraded).

During IFR, day VFR without visual reference or night VFR flights, the following parameters' values should not be displayed:

- (i) Track/heading;
- (ii) Estimated time of arrival (ETA);
- (iii) Altitude;
- (iv) Geographical coordinates of the current location of the aircraft; and
- (v) Aircraft speed.

(4) Controls

If a panning and/or range selection function is available, the EFB application should provide a clear and simple method to return to an own-ship-oriented display.

A means to disable the display of the own-ship position should be provided to the flight crew.

(e) Training and procedures

The procedures and training should emphasise the fact that the display of own-ship position on charts or IFW EFB applications should not be used as a primary source of information to fly or navigate the aircraft or as a primary source of weather information.

(1) Procedures:

The following considerations should be addressed in the procedures for the use of charts or IFW EFB application displaying the own-ship position in flight by the flight crew:

- (i) Intended use of the display of own-ship position in flight on charts or IFW EFB applications;
- (ii) Inclusion of the EFB into the regular scan of flight deck systems indications. In particular, systematic cross-check with avionics before being used, whatever the position source; and
- (iii) Actions to be taken in case of the identification of a discrepancy between the EFB and avionics.

(2) Training:

Crew members should be trained on the procedures for the use of the application, including the regular cross-check with avionics and the action in case of discrepancy.

GM1 SPO.GEN.131(b)(2) Use of electronic flight bags (EFBs)

ED Decision 2019/008/R

IN-FLIGHT WEATHER (IFW) APPLICATIONS — COMPLEX AIRCRAFT

'Reliable sources' of data used by IFW applications are the organisations evaluated by the operator as being able to provide an appropriate level of data assurance in terms of accuracy and integrity. It is recommended that the following aspects be considered during that evaluation:

- (a) The organisation should have a quality assurance system in place that covers the data source selection, acquisition/import, processing, validity period check, and the distribution phase;
- (b) Any meteorological product provided by the organisation that is within the scope of the meteorological information included in the flight documentation as defined in MET.TR.215(e) (Annex V (Definitions of terms used in Annexes II to XIII) to Commission Regulation (EU) 2016/1377) should originate only from authoritative sources or certified providers and should not be transformed or altered, except for the purpose of packaging the data in the correct format. The organisation's process should provide assurance that the integrity of those products is preserved in the data for use by the IFW application.

GM2 SPO.GEN.131(b)(2) Use of electronic flight bags (EFBs)

ED Decision 2019/008/R

USE OF COMMERCIAL OFF-THE-SHELF (COTS) POSITION SOURCE – PRATICAL EVALUATION — COMPLEX AIRCRAFT

The tests should consist of a statistically relevant sample of taxiing. It is recommended to include taxiing at airports that are representative of the more complex airports typically accessed by the operator. Taxiing segment samples should include data that is derived from runways and taxiways, and should include numerous turns, in particular of 90 degrees or more, and segments in straight lines at the maximum speed at which the own-ship symbol is displayed. Taxiing segment samples should include parts in areas of high buildings such as terminals. The analysis should include at least 25 inbound and/or outbound taxiing segments between the parking location and the runway.

During the tests, any unusual events (such as observing the own-ship symbol in a location on the map that is notably offset compared to the actual position, the own-ship symbol changing to non-directional when the aircraft is moving, and times when the own-ship symbol disappears from the map display) should be noted. For the test, the pilot should be instructed to diligently taxi on the centre line.

GM3 SPO.GEN.131(b)(2) Use of electronic flight bags (EFBs)

ED Decision 2019/008/R

APPLICATIONS DISPLAYING OWN-SHIP POSITION IN FLIGHT

The depiction of a circle around the EFB own-ship symbol may be used to differentiate it from the avionics one.

SPO.GEN.135 Information on emergency and survival equipment carried

Regulation (EU) No 379/2014

The operator shall, at all times, have available for immediate communication to rescue coordination centres (RCCs) lists containing information on the emergency and survival equipment carried on board.

AMC1 SPO.GEN.135 Information on emergency and survival equipment carried

ED Decision 2014/018/R

CONTENT OF INFORMATION

The information, compiled in a list, should include, as applicable:

- (a) the number, colour and type of life rafts and pyrotechnics;
- (b) details of emergency medical supplies and water supplies; and
- (c) the type and frequencies of the emergency portable radio equipment.

SPO.GEN.140 Documents, manuals and information to be carried

Regulation (EU) 2019/1387

- (a) The following documents, manuals and information shall be carried on each flight as originals or copies unless otherwise specified below:
 - (1) the AFM, or equivalent document(s);
 - (2) the original certificate of registration;
 - (3) the original certificate of airworthiness (CofA);
 - (4) the noise certificate, if applicable;
 - (5) a copy of the declaration as specified in [ORO.DEC.100](#) and, if applicable, a copy of the authorisation as specified in [ORO.SPO.110](#);
 - (6) the list of specific approvals, if applicable;
 - (7) the aircraft radio licence, if applicable;
 - (8) the third party liability insurance certificate(s);
 - (9) the journey log, or equivalent, for the aircraft;
 - (10) the aircraft technical log, in accordance with to Regulation (EU) No 1321/2014, if applicable;
 - (11) details of the filed ATS flight plan, if applicable;
 - (12) current and suitable aeronautical charts for the route/area of the proposed flight and all routes along which it is reasonable to expect that the flight may be diverted;
 - (13) procedures and visual signals information for use by intercepting and intercepted aircraft;
 - (14) information concerning search and rescue services for the area of the intended flight;

- (15) the current parts of the operations manual and/or SOP or AFM that are relevant to the duties of crew members and task specialists, which shall be easily accessible to them;
 - (16) the MEL or CDL, if applicable;
 - (17) appropriate notices to airmen (NOTAMs) and aeronautical information service (AIS) briefing documentation;
 - (18) appropriate meteorological information, if applicable;
 - (19) cargo manifests, if applicable; and
 - (20) any other documentation that may be pertinent to the flight or is required by the States concerned with the flight.
- (b) Notwithstanding (a), the documents and information in (a)(2) to (a)(11) and (a)(14), (a)(17), (a)(18) and (a)(19) may be retained at the aerodrome or operating site on flights:
- (1) intending to take off and land at the same aerodrome or operating site; or
 - (2) remaining within a distance or area determined by the competent authority in accordance with [ARO.OPS.210](#).
- (c) In case of loss or theft of documents specified in (a)(2) to (a)(8), the operation may continue until the flight reaches its destination or a place where replacement documents can be provided.
- (d) The operator shall make available, within a reasonable time of being requested to do so by the competent authority, the documentation required to be carried on board.

AMC1 SPO.GEN.140 Documents, manuals and information to be carried

ED Decision 2014/018/R

GENERAL

The documents, manuals and information may be available in a form other than on printed paper. An electronic storage medium is acceptable if accessibility, usability and reliability can be assured.

GM1 SPO.GEN.140(a)(1) Documents, manuals and information to be carried

ED Decision 2014/018/R

AFM OR EQUIVALENT DOCUMENT

‘Aircraft flight manual (AFM), or equivalent document’ means the flight manual for the aircraft or other documents containing information required for the operation of the aircraft within the terms of its certificate of airworthiness, unless these data are available in the parts of the operations manual carried on board.

AMC1 SPO.GEN.140(a)(3) Documents, manuals and information to be carried

ED Decision 2014/018/R

CERTIFICATE OF AIRWORTHINESS

The certificate of airworthiness should be a normal certificate of airworthiness, a restricted certificate of airworthiness or a permit to fly issued in accordance with the applicable airworthiness requirements.

GM1 SPO.GEN.140(a)(9) Documents, manuals and information to be carried

ED Decision 2014/018/R

JOURNEY LOG OR EQUIVALENT

'Journey log or equivalent' means in this context that the required information may be recorded in documentation other than a log book, such as the operational flight plan or the aircraft technical log.

AMC1 SPO.GEN.140(a)(12) Documents, manuals and information to be carried

ED Decision 2014/018/R

CURRENT AND SUITABLE AERONAUTICAL CHARTS

- (a) The aeronautical charts carried should contain data appropriate to the applicable air traffic regulations, rules of the air, flight altitudes, area/route and nature of the operation. Due consideration should be given to carriage of textual and graphic representations of:
 - (1) aeronautical data including, as appropriate for the nature of the operation:
 - (i) airspace structure;
 - (ii) significant points, navigation aids (navaids) and air traffic services (ATS) routes;
 - (iii) navigation and communication frequencies;
 - (iv) prohibited, restricted and danger areas; and
 - (v) sites of other relevant activities that may hazard the flight; and
 - (2) topographical data, including terrain and obstacle data.
- (b) A combination of different charts and textual data may be used to provide adequate and current data.
- (c) The aeronautical data should be appropriate for the current aeronautical information regulation and control (AIRAC) cycle.
- (d) The topographical data should be reasonably recent, having regard to the nature of the planned operation.

AMC1 SPO.GEN.140(a)(13) Documents, manuals and information to be carried

ED Decision 2014/018/R

PROCEDURES AND VISUAL SIGNALS FOR USE BY INTERCEPTING AND INTERCEPTED AIRCRAFT

The procedures and the visual signals information for use by intercepting and intercepted aircraft should reflect those contained in the International Civil Aviation Organisation's (ICAO) Annex 2. This may be part of the operations manual.

GM1 SPO.GEN.140(a)(14) Documents, manuals and information to be carried

ED Decision 2014/018/R

SEARCH AND RESCUE INFORMATION

This information is usually found in the State's aeronautical information publication.

AMC1 SPO.GEN.140(a)(18) Documents, manuals and information to be carried

ED Decision 2022/005/R

APPROPRIATE METEOROLOGICAL INFORMATION

The appropriate meteorological information should be relevant to the planned operation, as specified in point (a) of point MET.TR.215 of Annex V (Part MET) to [Regulation \(EU\) 2017/373](#), and comprise the following:

- (a) the meteorological information that is specified in point (e) of point MET.TR.215 of Part-MET; and
- (b) supplemental meteorological information:
 - (1) information other than that specified in point (a), which should be based on data from certified meteorological service providers; or
 - (2) information from other reliable sources of meteorological information that should be evaluated by the operator.

GM1 SPO.GEN.140(a)(18) Documents, manuals, and information to be carried

ED Decision 2022/005/R

DATA FROM CERTIFIED METEOROLOGICAL SERVICE PROVIDERS

In addition to GM1 SPO.GEN.140(a)(18) and in the context of point (b)(1) of [AMC1 SPO.GEN.140\(a\)\(18\)](#), the operator may consider that any meteorological information that is provided by the organisation within the scope of the meteorological information included in the flight documentation defined in point (e) of point MET.TR.215 of Part-MET should originate only from authoritative sources or certified providers, and should not be transformed or tampered, except for the purpose of presenting the data in the correct format. The organisation's process should provide assurance that the integrity of such service is preserved in the data to be used by both flight crews and operators, regardless of their form.

GM2 SPO.GEN.140(a)(18) Documents, manuals, and information to be carried

ED Decision 2022/005/R

INFORMATION FROM OTHER RELIABLE SOURCES OF METEOROLOGICAL INFORMATION

In the context of point (b)(2) of [AMC1 SPO.GEN.140\(a\)\(18\)](#), reliable sources of meteorological information are organisations that are able to provide an appropriate level of data assurance in terms of accuracy and integrity. The operator may consider in the evaluation that the organisation has a quality assurance system in place that covers source selection, acquisition/import, processing, validity period check, and distribution phase of data.

GM3 SPO.GEN.140(a)(18) Documents, manuals, and information to be carried

ED Decision 2022/005/R

SUPPLEMENTAL METEOROLOGICAL INFORMATION AND SUPPLEMENTARY INFORMATION

Supplemental meteorological information: when operating under specific provisions and without the meteorological information from a certified service provider, the operator should use 'supplemental meteorological information', such as digital imagery. Related information can be found in point (e)(4) of [AMC1 CAT.OP.MPA.192](#).

Supplementary information: it is included in point (a) of [AMC1 CAT.GEN.MPA.180\(a\)\(18\)](#) and refers to meteorological information to be reported in specific cases such as freezing precipitation, blowing snow, thunderstorm, etc.

GM1 SPO.GEN.140(a)(20) Documents, manuals and information to be carried

ED Decision 2014/018/R

DOCUMENTS THAT MAY BE PERTINENT TO THE FLIGHT

Any other documents that may be pertinent to the flight or required by the States concerned with the flight may include, for example, forms to comply with reporting requirements.

STATES CONCERNED WITH THE FLIGHT

The States concerned are those of origin, transit, overflight and destination of the flight.

SPO.GEN.145 Handling of flight recorder recordings: preservation, production, protection and use

Regulation (EU) 2019/1387

- (a) Following an accident, a serious incident or an occurrence identified by the investigating authority, the operator of an aircraft shall preserve the original recorded data of the flight recorders for a period of 60 days or until otherwise directed by the investigating authority.
- (b) The operator shall conduct operational checks and evaluations of recordings to ensure the continued serviceability of the flight recorders which are required to be carried.
- (c) The operator shall ensure that the recordings of flight parameters and data link communication messages required to be recorded on flight recorders are preserved. However, for the purpose

of testing and maintaining those flight recorders, up to 1 hour of the oldest recorded data at the time of testing may be erased.

- (d) The operator shall keep and maintain up to date documentation that presents the necessary information to convert raw flight data into flight parameters expressed in engineering units.
- (e) The operator shall make available any flight recorder recordings that have been preserved, if so determined by the competent authority.
- (f) Without prejudice to Regulations (EU) No 996/2010 and (EU) 2016/679, and except for ensuring flight recorder serviceability:
 - (1) audio recordings from a flight recorder shall not be disclosed or used unless all the following conditions are fulfilled:
 - (i) a procedure related to the handling of such audio recordings and of their transcript is in place;
 - (ii) all crew members and maintenance personnel concerned have given their prior consent;
 - (iii) such audio recordings are used only for maintaining or improving safety.
 - (1a) When flight recorder audio recordings are inspected for ensuring flight recorder serviceability, the operator shall protect the privacy of those audio recordings and make sure that they are not disclosed or used for purposes other than ensuring flight recorder serviceability.
 - (2) Flight parameters or data link messages recorded by a flight recorder shall not be used for purposes other than for the investigation of an accident or an incident that is subject to mandatory reporting. That limitation shall not apply, unless such recordings meet any of the following conditions:
 - (i) are used by the operator for airworthiness or maintenance purposes only;
 - (ii) are de-identified;
 - (iii) are disclosed under secure procedures.
 - (3) Except for ensuring flight recorder serviceability, images of the flight crew compartment that are recorded by a flight recorder shall not be disclosed or used unless all of the following conditions are fulfilled:
 - (i) a procedure related to the handling of such image recordings is in place;
 - (ii) all crew members and maintenance personnel concerned have given their prior consent;
 - (iii) such image recordings are used only for maintaining or improving safety.
 - (3a) When images of the flight crew compartment that are recorded by a flight recorder are inspected for ensuring the serviceability of the flight recorder, then:
 - (i) those images shall not be disclosed or used for purposes other than ensuring flight recorder serviceability;
 - (ii) if body parts of crew members are likely to be visible on the images, the operator shall ensure the privacy of those images.

AMC1 SPO.GEN.145(a) Handling of flight recorder recordings: preservation, production, protection and use

ED Decision 2015/030/R

PRESERVATION OF RECORDED DATA FOR INVESTIGATION

- (a) The operator should establish procedures to ensure that flight recorder recordings are preserved for the investigating authority.
- (b) These procedures should include:
 - (1) instructions for flight crew members to deactivate the flight recorders immediately after completion of the flight and inform relevant personnel that the recording of the flight recorders should be preserved. These instructions should be readily available on board; and
 - (2) instructions to prevent inadvertent reactivation, test, repair or reinstallation of the flight recorders by operator personnel or during maintenance or ground handling activities performed by third parties.

GM1 SPO.GEN.145(a) Handling of flight recorder recordings: preservation, production, protection and use

ED Decision 2015/030/R

REMOVAL OF RECORDERS IN CASE OF AN INVESTIGATION

The need for removal of the recorders from the aircraft is determined by the investigating authority with due regard to the seriousness of an occurrence and the circumstances, including the impact on the operation.

AMC1 SPO.GEN.145(b) Handling of flight recorder recordings: preservation, production, protection and use

ED Decision 2021/005/R

INSPECTIONS AND CHECKS OF RECORDINGS

- (a) The operator should perform an inspection of the FDR recording and the CVR recording every year unless one or more of the following applies:
 - (1) If the flight recorder records on magnetic wire or uses frequency modulation technology, the time interval between two inspections of the recording should not exceed 3 months.
 - (2) If the flight recorder is solid-state and the flight recorder system is fitted with continuous monitoring for proper operation, the time interval between two inspections of the recording may be up to 2 years.
 - (3) In the case of an aircraft equipped with two solid-state flight data and cockpit voice combination recorders, where
 - (i) the flight recorder systems are fitted with continuous monitoring for proper operation, and
 - (ii) the flight recorders share the same flight data acquisition, a comprehensive inspection of the recording needs only to be performed for one flight recorder position. The inspection of the recordings should be performed alternately so that each flight recorder position is inspected at least every 4 years.

- (4) Where all the following conditions are met, the inspection of FDR recording is not needed:
- (i) the aircraft flight data is collected in the frame of a flight data monitoring (FDM) programme;
 - (ii) the data acquisition of mandatory flight parameters is the same for the FDR and for the recorder used for the FDM programme;
 - (iii) an inspection similar to the inspection of the FDR recording and covering all mandatory flight parameters is conducted on the FDM data at time intervals not exceeding 2 years; and
 - (iv) the FDR is solid-state and the FDR system is fitted with 'continuous monitoring for proper operation'.
- (b) The operator should perform every 5 years an inspection of the data link recording.
- (c) The operator should perform at time intervals not exceeding 2 years, an inspection of the recording of flight recorders other than an FDR, which are installed on an aircraft in order to ensure compliance with SPO.IDE.A.146 or SPO.IDE.H.146.
- (d) When installed, the aural or visual means for preflight checking of the flight recorders for proper operation should be used on each day when the aircraft is operated. When no such means is available for a flight recorder, the operator should perform an operational check of this flight recorder at intervals not exceeding 150 flight hours or 7 calendar days of operation, whichever is considered more suitable by the operator.
- (e) The operator should check every 5 years, or in accordance with the recommendations of the sensor manufacturer, that the parameters dedicated to the FDR and not monitored by other means are being recorded within the calibration tolerances and that there is no discrepancy in the engineering conversion routines for these parameters.

GM1 SPO.GEN.145(b) Handling of flight recorder recordings: preservation, production, protection and use

ED Decision 2021/005/R

INSPECTION OF THE FLIGHT RECORDERS' RECORDINGS FOR ENSURING SERVICEABILITY

- (a) The inspection of the recorded flight parameters usually consists of the following:
- (1) Making a copy of the complete recording file.
 - (2) Converting the recording to parameters expressed in engineering units in accordance with the documentation required to be held.
 - (3) Examining a whole flight in engineering units to evaluate the validity of all mandatory parameters. This could reveal defects or noise in the measuring and processing chains and indicate necessary maintenance actions. The following should be considered:
 - (i) when applicable, each parameter should be expressed in engineering units and checked for different values of its operational range. For this purpose, some parameters may need to be inspected at different flight phases; and
 - (ii) (only applicable to an FDR) if the parameter is delivered by a digital data bus and the same data are utilised for the operation of the aircraft, then a reasonableness check may be sufficient; otherwise a correlation check may need to be performed:

- (A) a reasonableness check is understood in this context as a subjective, qualitative evaluation, requiring technical judgement, of the recordings from a complete flight; and
 - (B) a correlation check is understood in this context as the process of comparing data recorded by the flight data recorder against the corresponding data derived from flight instruments, indicators or the expected values obtained during specified portion(s) of a flight profile or during ground checks that are conducted for that purpose.
- (4) Retaining the most recent copy of the complete recording file and the corresponding recording inspection report that includes references to the documentation required to be held.
- (b) When performing the inspection of an audio recording from a flight recorder, precautions need to be taken to comply with [SPO.GEN.145\(f\)\(1a\)](#). The inspection of the audio recording usually consists of:
- (1) checking that the flight recorder operates correctly for the nominal duration of the recording;
 - (2) examining samples of in-flight audio recording from the flight recorder for evidence that the signal is acceptable on each channel and in all phases of flight; and
 - (3) preparing and retaining an inspection report.
- (c) The inspection of the DLR recording usually consists of:
- (1) Checking the consistency of the data link recording with other recordings for example, during a designated flight, the flight crew speaks out a few data link messages sent and received. After the flight, the data link recording and the CVR recording are compared for consistency.
 - (2) Retaining the most recent copy of the complete recording and the corresponding inspection report.
- (d) When inspecting images recorded by a flight recorder, precautions need to be taken to comply with [SPO.GEN.145\(f\)\(3a\)](#). The inspection of such images usually consists of the following:
- (1) checking that the flight recorder operates correctly for the nominal duration of the recording;
 - (2) examining samples of images recorded in different flight phases for evidence that the images of each camera are of acceptable quality; and
 - (3) preparing and retaining an inspection report.

GM2 SPO.GEN.145(b) Handling of flight recorder recordings: preservation, production, protection and use

ED Decision 2016/012/R

MONITORING AND CHECKING THE PROPER OPERATION OF FLIGHT RECORDERS – EXPLANATION OF TERMS

For the understanding of the terms used in [AMC1 SPO.GEN.145\(b\)](#):

- (a) ‘operational check of the flight recorder’ means a check of the flight recorder for proper operation. It is not a check of the quality of the recording and, therefore, it is not equivalent to

an inspection of the recording. This check can be carried out by the flight crew or through a maintenance task.

- (b) 'aural or visual means for preflight checking the flight recorders for proper operation' means an aural or visual means for the flight crew to check before the flight the results of an automatically or manually initiated test of the flight recorders for proper operation. Such a means provides for an operational check that can be performed by the flight crew.
- (c) 'flight recorder system' means the flight recorder, its dedicated sensors and transducers, as well as its dedicated acquisition and processing equipment.
- (d) 'continuous monitoring for proper operation' means for a flight recorder system, a combination of system monitors and/or built-in test functions which operates continuously in order to detect the following:
 - (1) loss of electrical power to the flight recorder system;
 - (2) failure of the equipment performing acquisition and processing;
 - (3) failure of the recording medium and/or drive mechanism; and
 - (4) failure of the recorder to store the data in the recording medium as shown by checks of the recorded data including, as reasonably practicable for the storage medium concerned, correct correspondence with the input data.

However, detections by the continuous monitoring for proper operation do not need to be automatically reported to the flight crew compartment.

GM3 SPO.GEN.145(b) Handling of flight recorder recordings: preservation, production, protection and use

ED Decision 2021/005/R

CVR AUDIO QUALITY

Additional guidance material for performing the CVR recording inspection may be found in the document of the French Bureau d'Enquêtes et d'Analyses, titled 'Guidance on CVR recording inspection' and dated October 2018 or later.

AMC1 SPO.GEN.145(f)(1) Handling of flight recorder recordings: preservation, production, protection and use

ED Decision 2021/005/R

USE OF AUDIO RECORDINGS FOR MAINTAINING OR IMPROVING SAFETY

- (a) The procedure related to the handling of audio recordings from flight recorders and of their transcripts should be documented and signed by all parties (aircraft operator, crew members, maintenance personnel if applicable). This procedure should take into account Regulation (EU) 2016/679 and, as a minimum, define:
 - (1) the method to obtain the consent of all crew members and maintenance personnel concerned;
 - (2) an access and security policy that restricts access to audio recordings from flight recorders and their transcripts to specifically authorised persons identified by their position;

- (3) a retention policy and accountability, including the measures to be taken to ensure the security of audio recordings from flight recorders and transcripts thereof and their protection from misuse. The retention policy should specify the period of time after which such audio recordings and identified transcripts are destroyed;
 - (4) a description of the uses made of audio recordings from flight recorders and their transcripts;
 - (5) the participation of flight crew member representatives in the assessment of audio recordings from flight recorders and their transcripts;
 - (6) the conditions under which advisory briefing or remedial training should take place; this should always be carried out in a constructive and non-punitive manner; and
 - (7) the conditions under which actions other than advisory briefing or remedial training may be taken for reasons of gross negligence or significant continuing safety concern.
- (b) Each time an audio recording file from a flight recorder is read out under the conditions defined by [SPO.GEN.145\(f\)\(1\)](#):
- (1) parts of the audio recording file that contain information with a privacy content should be deleted to the extent possible, and it should not be permitted that the detail of information with a privacy content is transcribed; and
 - (2) the operator should retain, and when requested, provide to the competent authority:
 - (i) information on the use made (or the intended use) of the audio recording file; and
 - (ii) evidence that the persons concerned consented to the use made (or the intended use) of the audio recording file.
- (c) The person who fulfils the role of a safety manager should be responsible for the protection and use of audio recordings from flight recorders and transcripts thereof, as well as for the assessment of issues and their transmission to the manager(s) responsible for the process concerned.
- (d) In case a third party is involved in the use of audio recordings from flight recorders, contractual agreements with this third party should cover the aspects enumerated in (a) and (b).

AMC1 SPO.GEN.145(f)(1a) Handling of flight recorder recordings: preservation, production, protection and use

ED Decision 2021/005/R

INSPECTION OF AUDIO RECORDINGS FOR ENSURING SERVICEABILITY

- (a) When an inspection of the audio recordings from a flight recorder is performed for ensuring audio quality and intelligibility of recorded communications:
- (1) the privacy of the audio recordings should be ensured (e.g. by locating the replay equipment in a separated area and/or using headsets);
 - (2) access to the replay equipment should be restricted to specifically authorised persons identified by their position;
 - (3) provision should be made for the secure storage of the recording medium, the audio recording files and copies thereof;
 - (4) the audio recording files and copies thereof should be destroyed not earlier than 2 months and not later than 1 year after completion of the inspection of the audio

- recordings, except that audio samples with no privacy content may be retained for enhancing this inspection (e.g. for comparing audio quality);
- (5) only the accountable manager of the operator and, when identified to comply with [ORO.GEN.200](#), the person fulfilling the role of safety manager should be entitled to request a copy of the audio recording files.
- (b) The conditions enumerated in (a) should also be complied with if the inspection of the audio recordings is subcontracted to a third party. The contractual agreements with the third party should explicitly cover these aspects.

AMC1 SPO.GEN.145(f)(3) Handling of flight recorder recordings: preservation, production, protection and use

ED Decision 2021/005/R

USE OF IMAGES FROM THE FLIGHT CREW COMPARTMENT FOR MAINTAINING OR IMPROVING SAFETY

- (a) The procedure related to the handling of images of the flight crew compartment that are recorded by a flight recorder should be documented and signed by all parties (aircraft operator, crew members, maintenance personnel if applicable). This procedure should take into account Regulation (EU) 2016/679 and, as a minimum, define the following aspects:
- (1) the method to obtain the consent of all crew members and maintenance personnel concerned;
 - (2) an access and security policy that restricts access to the image recordings to specifically authorised persons identified by their position;
 - (3) a retention policy and accountability, including the measures to ensure the security of the image recordings and their protection from misuse;
 - (4) a description of the uses made of the image recordings.
- (b) Each time a recording file from a flight recorder and containing images of the flight crew compartment is read out for purposes other than to ensure the serviceability of that flight recorder:
- (1) images that contain information with a privacy content should be deleted to the extent possible, and it should not be permitted that the detail of information with a privacy content is transcribed; and
 - (2) the operator should retain and, when requested, provide the competent authority with:
 - (i) information on the use made (or the intended use) of the recording file; and
 - (ii) evidence that the flight crew members concerned consented to the use made (or the intended use) of the flight crew compartment images.
- (c) The person fulfilling the role of safety manager should be responsible for the protection and use of images of the flight crew compartment that are recorded by a flight recorder, as well as for the assessment of issues and their transmission to the manager(s) responsible for the process concerned.
- (d) In case a third party is involved in the use of images of the flight crew compartment that are recorded by a flight recorder, contractual agreements with this third party should cover the aspects enumerated in (a) and (b).

AMC1 SPO.GEN.145(f)(3a) Handling of flight recorder recordings: preservation, production, protection and use

ED Decision 2021/005/R

INSPECTION OF IMAGES OF THE FLIGHT CREW COMPARTMENT FOR ENSURING SERVICEABILITY

- (a) When images of the flight crew compartment recorded by a flight recorder are inspected for ensuring the serviceability of the flight recorder, and any body part of a crew member is likely to be visible on these images, then:
- (1) the privacy of the image recordings should be ensured (e.g. by locating the replay equipment in a separated area);
 - (2) access to the replay equipment should be restricted to specifically authorised persons identified by their position;
 - (3) provisions should be made for the secure storage of the recording medium, the image recording files and copies thereof;
 - (4) the image recording files and copies thereof should be destroyed not earlier than 2 months and not later than 1 year after completion of the inspection of the image recordings. Images that do not contain any body part of a person may be retained for enhancing this inspection (e.g. for comparing image quality); and
 - (5) only the accountable manager of the operator and, when identified to comply with [ORO.GEN.200](#), the safety manager should be entitled to request a copy of the image recording files.
- (b) The conditions enumerated in (a) should also be complied with if the inspection of the image recording is subcontracted to a third party. The contractual agreements with the third party should explicitly cover these aspects.

GM1 SPO.GEN.145(f) Handling of flight recorder recordings: preservation, production, protection and use

ED Decision 2021/005/R

FLIGHT CREW COMPARTMENT

If there are no compartments to physically segregate the flight crew from the passengers during the flight, the 'flight crew compartment' in point (f) of [SPO.GEN.145](#) should be understood as the area including:

- (a) the flight crew seats;
- (b) aircraft and engine controls;
- (c) aircraft instruments;
- (d) windshield and windows used by the flight crew to get an external view while seated at their duty station; and
- (e) circuit breakers accessible by the flight crew while seated at their duty station.

SPO.GEN.150 Transport of dangerous goods

Regulation (EU) No 379/2014

- (a) The transport of dangerous goods by air shall be conducted in accordance with Annex 18 to the Chicago Convention as last amended and amplified by the Technical Instructions for the Safe Transport of Dangerous Goods by Air (ICAO Doc 9284-AN/905), including its attachments, supplements and any other addenda or corrigenda.
- (b) Dangerous goods shall only be transported by an operator approved in accordance with Annex V (Part-SPA), subpart G, to Regulation (EU) No 965/2012 except when:
 - (1) they are not subject to the Technical Instructions in accordance with Part 1 of those Instructions;
 - (2) they are carried by task specialists or crew members or are in baggage which has been separated from its owner, in accordance with Part 8 of the Technical Instructions;
 - (3) required on board the aircraft for specialised purposes in accordance with the Technical Instructions;
 - (4) they are used to facilitate flight safety where carriage aboard the aircraft is reasonable to ensure their timely availability for operational purposes, whether or not such articles and substances are required to be carried or intended to be used in connection with a particular flight.
- (c) The operator shall establish procedures to ensure that all reasonable measures are taken to prevent dangerous goods from being carried on board inadvertently.
- (d) The operator shall provide personnel with the necessary information enabling them to carry out their responsibilities, as required by the Technical Instructions.
- (e) The operator shall, in accordance with the Technical Instructions, report without delay to the competent authority and the appropriate authority of the State of occurrence in the event of:
 - (1) any dangerous good accident or incidents;
 - (2) the finding of dangerous goods carried by task specialists or crew, or in their baggage, when not in accordance with Part 8 of the Technical Instructions.
- (f) The operator shall ensure that task specialists are provided with information about dangerous goods.
- (g) The operator shall ensure that notices giving information about the transport of dangerous goods are provided at acceptance points for cargo as required by the Technical Instructions.

GM1 SPO.GEN.150(a) Transport of dangerous goods

ED Decision 2014/018/R

GENERAL

- (a) The requirement to transport dangerous goods by air in accordance with the Technical Instructions is irrespective of whether:
 - (1) the flight is wholly or partly within or wholly outside the territory of a State; or
 - (2) an approval to carry dangerous goods in accordance with Annex V (Part-SPA), Subpart DG is held.
- (b) The Technical Instructions provide that in certain circumstances dangerous goods, which are normally forbidden on an aircraft, may be carried. These circumstances include cases of

extreme urgency or, when other forms of transport are inappropriate or when full compliance with the prescribed requirements is contrary to the public interest. In these circumstances all the States concerned may grant exemptions from the provisions of the Technical Instructions provided that an overall level of safety that is at least equivalent to that provided by the Technical Instructions is achieved. Although exemptions are most likely to be granted for the carriage of dangerous goods that are not permitted in normal circumstances, they may also be granted in other circumstances, such as when the packaging to be used is not provided for by the appropriate packing method or the quantity in the packaging is greater than that permitted. The Technical Instructions also make provision for some dangerous goods to be carried when an approval has been granted only by the State of Origin and the competent authority.

- (c) When an exemption is required, the States concerned are those of origin, transit, overflight and destination of the consignment and that of the operator. For the State of overflight, if none of the criteria for granting an exemption are relevant, an exemption may be granted based solely on whether it is believed that an equivalent level of safety in air transport has been achieved.
- (d) The Technical Instructions provide that exemptions and approvals are granted by the 'appropriate national authority', which is intended to be the authority responsible for the particular aspect against which the exemption or approval is being sought. The operator should ensure that all relevant conditions on an exemption or approval are met.
- (e) The exemption or approval referred to in (b) to (d) is in addition to the approval required by Annex V (Part-SPA).

AMC1 SPO.GEN.150(e) Transport of dangerous goods

ED Decision 2014/018/R

DANGEROUS GOODS ACCIDENT AND INCIDENT REPORTING

- (a) Any type of dangerous goods incident or accident should be reported. For this purpose, the Technical Instructions consider that reporting of undeclared and misdeclared dangerous goods found in cargo also applies to items of operators' stores that are classified as dangerous goods.
- (b) The first report should be dispatched within 72 hours of the event. It may be sent by any means, including e-mail, telephone or fax. This report should include the details that are known at that time, under the headings identified in (c). If necessary, a subsequent report should be made as soon as possible giving all the details that were not known at the time the first report was sent. If a report has been made verbally, written confirmation should be sent as soon as possible.
- (c) The first and any subsequent report should be as precise as possible and contain the following data, where relevant:
 - (1) date of the incident or accident or the finding of undeclared or misdeclared dangerous goods;
 - (2) location and flight date;
 - (3) description of the goods;
 - (4) proper shipping name (including the technical name, if appropriate) and United Nations (UN)/identification (ID) number, when known;
 - (5) class or division and any subsidiary risk;
 - (6) type of packaging, and the packaging specification marking on it;
 - (7) quantity;

- (8) any other relevant details;
 - (9) suspected cause of the incident or accident;
 - (10) action taken;
 - (11) any other reporting action taken; and
 - (12) name, title, address and telephone number of the person making the report.
- (d) Copies of relevant documents and any photographs taken should be attached to the report.
- (e) A dangerous goods accident or incident may also constitute an aircraft accident, serious incident or incident. The criteria for reporting both types of occurrence should be met.
- (f) The following dangerous goods reporting form should be used, but other forms, including electronic transfer of data, may be used provided that at least the minimum information of this AMC is supplied:

DANGEROUS GOODS OCCURRENCE REPORT			DGOR No:
1. Operator:	2. Date of Occurrence:	3. Local time of occurrence:	
4. Flight date:		5. Reserved:	
6. Departure aerodrome:		7. Destination aerodrome:	
8. Aircraft type:		9. Aircraft registration:	
10. Location of occurrence:		11. Origin of the goods:	
12. Description of the occurrence, including details of injury, damage, etc. (if necessary continue on the reverse of this form)			
13. Proper shipping name (including the technical name):			14. UN/ID No (when known):
15. Class/Division (when known):	16. Subsidiary risk(s):	17. Packing group:	18. Category (Class 7 only):
19. Type of packaging:	20. Packaging specification marking:	21. No of packages:	22. Quantity (or transport index, if applicable):
23. Other relevant information (including suspected cause, any action taken):			
24. Name and title of person making report:		25. Telephone No:	
26. Company:		27. Reporters ref:	
28. Address:		29. Signature:	
		30. Date:	
Description of the occurrence (continuation)			

Notes for completion of the form:

1. A dangerous goods accident is as defined in [Annex I](#). For this purpose serious injury is as defined in Regulation (EU) No 996/2010 of the European Parliament and of the Council¹.
2. The initial report should be dispatched unless exceptional circumstances prevent this. This occurrence report form, duly completed, should be sent as soon as possible, even if all the information is not available.
3. Copies of all relevant documents and any photographs should be attached to this report.
4. Any further information, or any information not included in the initial report, should be sent as soon as possible to the authorities identified in [SPO.GEN.150\(e\)](#).
5. Providing it is safe to do so, all dangerous goods, packaging, documents, etc. relating to the occurrence should be retained until after the initial report has been sent to the authorities identified in [SPO.GEN.150\(e\)](#), and they have indicated whether or not these should continue to be retained.

SPO.GEN.155 Release of dangerous goods

Regulation (EU) No 379/2014

The operator shall not operate an aircraft over congested areas of cities, towns or settlements or over an open-air assembly of persons when releasing dangerous goods.

SPO.GEN.160 Carriage and use of weapons

Regulation (EU) No 379/2014

- (a) The operator shall ensure that, when weapons are carried on a flight for the purpose of a specialised task, these are secured when not in use.
- (b) The task specialist using the weapon shall take all necessary measures to prevent the aircraft and persons on board or on the ground from being endangered.

SPO.GEN.165 Admission to the flight crew compartment

Regulation (EU) No 379/2014

The pilot-in-command shall make the final decision regarding the admission to the flight crew compartment and shall ensure that:

- (a) admission to the flight crew compartment does not cause distraction or interference with the operation of the flight; and
- (b) all persons carried in the flight crew compartment are made familiar with the relevant safety procedures.

¹ Regulation (EU) No 996/2010 of the European Parliament and of the Council of 20 October 2010 on the investigation and prevention of accidents and incidents in civil aviation and repealing Directive 94/56/EC (OJ L 295, 12.11.2010, p. 35).

SUBPART B: OPERATIONAL PROCEDURES

SPO.OP.100 Use of aerodromes and operating sites

Regulation (EU) No 379/2014

The operator shall only use aerodromes and operating sites that are adequate for the type of aircraft and operation concerned.

AMC1 SPO.OP.100 Use of aerodromes and operating sites

ED Decision 2014/018/R

USE OF OPERATING SITES MOTOR-POWERED AIRCRAFT

- (a) When defining adequate operating sites for use for the type(s) of aircraft and operation(s) concerned, the operator should take account of the following:
- (1) An adequate site is a site that the operator considers to be satisfactory, taking account of the applicable performance requirements and site characteristics.
 - (2) The operator should have in place a procedure for the survey of operating sites by a competent person. Such a procedure should take account for possible changes to the operating site characteristics that may have taken place since last surveyed.
- (b) Operating sites that are pre-surveyed should be specifically specified in the operations manual. The operations manual should contain diagrams or ground and aerial photographs, depiction (pictorial) and description of:
- (1) the overall dimensions of the operating site;
 - (2) location and height of relevant obstacles to approach and take-off profiles and in the manoeuvring area;
 - (3) approach and take-off flight paths;
 - (4) surface condition (blowing dust/snow/sand);
 - (5) provision of control of third parties on the ground, if applicable;
 - (6) lighting, if applicable;
 - (7) procedure for activating the operating site in accordance with national regulations, if applicable;
 - (8) other useful information, for example details of the appropriate ATS agency and frequency; and
 - (9) site suitability with reference to available aircraft performance.
- (c) Where the operator specifically permits operation from sites that are not pre-surveyed, the pilot-in-command should make, from the air a judgement on the suitability of a site. At least (b)(1) to (b)(6) inclusive and (b)(9) should be considered. Operations to non-pre-surveyed operating sites by night should not be conducted.

SPO.OP.101 Altimeter check and settings

Regulation (EU) 2021/2237

- (a) The operator shall establish procedures for altimeter checking before each departure.
- (b) The operator shall establish procedures for altimeter settings for all phases of flight, which shall take into account the procedures established by the State of the aerodrome or the State of the airspace, if applicable.

GM1 SPO.OP.101 Altimeter check and settings

ED Decision 2022/014/R

ALTIMETER SETTING PROCEDURES

The following paragraphs of ICAO Doc 8168 (PANS-OPS), Volume III provide recommended guidance on how to develop the altimeter setting procedure:

- (a) 3.2 'Pre-flight operational test';
- (b) 3.3 'Take-off and climb';
- (c) 3.5 'Approach and landing'.

SPO.OP.105 Specification of isolated aerodromes – aeroplanes

Regulation (EU) 2021/1296

For the selection of alternate aerodromes and the fuel/energy planning and in-flight re-planning policy, the operator shall not consider an aerodrome as an isolated aerodrome unless the flying time to the nearest weather-permissible destination alternate aerodrome is more than:

- (a) for aeroplanes with reciprocating engines, 60 minutes; or
- (b) for turbine-engined aeroplanes, 90 minutes.

GM1 SPO.OP.105 Specification of isolated aerodromes – aeroplanes

ED Decision 2022/005/R

USE OF AN AERODROME AS AN ISOLATED AERODROME

The concept of an isolated aerodrome allows the operator to use aerodromes that would otherwise be impossible or impractical to use with sufficient fuel to fly to the destination aerodrome and then to a destination alternate aerodrome, provided that operational criteria are used to ensure a safe-landing option, for example by specifying a point of no return (PNR). If alternate fuel is carried, the operator is not required to consider the aerodrome as isolated and use the aforementioned operational criteria.

SPO.OP.110 Aerodrome operating minima – aeroplanes and helicopters

Regulation (EU) 2021/2237

- (a) The operator shall establish aerodrome operating minima for each departure, destination or alternate aerodrome that is planned to be used in order to ensure separation of the aircraft from terrain and obstacles and to mitigate the risk of loss of visual references during the visual flight segment of instrument approach operations.

- (b) The method used to establish aerodrome operating minima shall take all the following elements into account:
- (1) the type, performance, and handling characteristics of the aircraft;
 - (2) the equipment available on the aircraft for the purpose of navigation, acquisition of visual references, and/or control of the flight path during take-off, approach, landing, and missed approach;
 - (3) any conditions or limitations stated in the aircraft flight manual (AFM);
 - (4) the dimensions and characteristics of the runways/final approach and take-off areas (FATOs) that may be selected for use;
 - (5) the adequacy and performance of the available visual and non-visual aids and infrastructure;
 - (6) the obstacle clearance altitude/height (OCA/H) for the instrument approach procedures (IAPs);
 - (7) the obstacles in the climb-out areas and the necessary clearance margins;
 - (8) any non-standard characteristics of the aerodrome, the IAP or the local environment;
 - (9) the composition of the flight crew, their competence and experience;
 - (10) the IAP;
 - (11) the aerodrome characteristics and the available air navigation services (ANS);
 - (12) any minima that may be promulgated by the State of the aerodrome;
 - (13) the conditions prescribed in any specific approvals for low-visibility operations (LVOs) or operations with operational credits; and
 - (14) the relevant operational experience of the operator.
- (c) The operator shall specify a method of determining aerodrome operating minima in the operations manual.

AMC1 SPO.OP.110 Aerodrome operating minima – aeroplanes and helicopters

ED Decision 2014/018/R

COMMERCIALLY AVAILABLE INFORMATION

An acceptable method of specifying aerodrome operating minima is through the use of commercially available information.

AMC2 SPO.OP.110 Aerodrome operating minima — aeroplanes and helicopters

ED Decision 2022/012/R

GENERAL

- (a) The aerodrome operating minima should not be lower than those specified in [AMC5 SPO.OP.110](#) or [AMC4 SPO.OP.110\(c\)](#).
- (b) Whenever practical, approaches should be flown as stabilised approaches (SAs). Different procedures may be used for a particular approach to a particular runway.

- (c) Whenever practical, non-precision approaches should be flown using the continuous descent final approach (CDFA) technique. Different procedures may be used for a particular approach to a particular runway.
- (d) For approaches not flown using the CDFA technique: when calculating the minima in accordance with [AMC5 SPO.OP.110](#), the applicable minimum runway visual range (RVR) should be increased by 200 m for Category A and B aeroplanes and by 400 m for Category C and D aeroplanes, provided that the resulting RVR/converted meteorological visibility (CMV) value does not exceed 5 000 m. SAp or CDFA should be used as soon as facilities are improved to allow these techniques.

AMC3 SPO.OP.110 Aerodrome operating minima — aeroplanes and helicopters

ED Decision 2022/014/R

TAKE-OFF OPERATIONS

- (a) General
 - (1) Take-off minima should be expressed as VIS or RVR limits, taking into account all relevant factors for each aerodrome planned to be used and aircraft characteristics and equipment. Where there is a specific need to see and avoid obstacles on departure and/or for a forced landing, additional conditions, e.g. ceiling, should be specified.
 - (2) The pilot-in-command should not commence take-off unless the weather conditions at the aerodrome of departure are equal to or better than the applicable minima for landing at that aerodrome, unless a weather-permissible take-off alternate aerodrome is available.
 - (3) When the reported VIS is below that required for take-off and the RVR is not reported, a take-off should only be commenced if the pilot-in-command can determine that the visibility along the take-off runway/area is equal to or better than the required minimum.
 - (4) When no reported VIS or RVR is available, a take-off should only be commenced if the pilot-in-command can determine that the visibility along the take-off runway/area is equal to or better than the required minimum.
- (b) Visual reference
 - (1) The take-off minima should be selected to ensure sufficient guidance to control the aircraft in the event of both a rejected take-off in adverse circumstances and a continued take-off after failure of the critical engine.
 - (2) For night operations, the prescribed runway lights should be in operation to mark the runway and any obstacles.

TAKE-OFF OPERATIONS WITH HELICOPTERS AND COMPLEX MOTOR-POWERED AEROPLANES

- (c) Required RVR or VIS
 - (1) Complex motor-powered aeroplanes
 - (i) For multi-engined aeroplanes with such performance that in the event of a critical engine failure at any point during take-off the aeroplane can either stop or continue the take-off to a height of 1 500 ft above the aerodrome while clearing obstacles by the required margins, the take-off minima specified by the operator should be expressed as RVR or VIS values not lower than those specified in Table 1.

- (ii) Multi-engined aeroplanes without the performance to comply with the conditions in (c)(1)(i) in the event of a critical engine failure may need to reland immediately and to see and avoid obstacles in the take-off area. Such aeroplanes may be operated to the following take-off minima provided that they are able to comply with the applicable obstacle clearance criteria, assuming engine failure at the specified height:
 - (A) The take-off minima specified by the operator should be based upon the height from which the one-engine-inoperative (OEI) net take-off flight path can be constructed.
 - (B) The RVR minima used should not be lower than either of the values specified in Table 1 or Table 2.
- (iii) For single-engined complex aeroplane operations, the take-off minima specified by the operator should be expressed as RVR/CMV values not lower than those specified in Table 1 below.

Unless the operator makes use of a risk period, whenever the surface in front of the runway does not allow for a safe forced landing, the RVR/CMV values should not be lower than 800 m. In this case, the proportion of the flight to be considered starts at the lift-off position and ends when the aeroplane is able to turn back and land on the runway in the opposite direction or glide to the next landing site in case of power loss.
- (iv) When the RVR or the VIS is not available, the pilot-in-command should not commence take-off unless he or she can determine that the actual conditions satisfy the applicable take-off minima.

Table 1
Take-off — aeroplanes (without LVTO approval)
RVR or VIS

Facilities	RVR or VIS (m)*
Day only: Nil**	500
Day: at least runway edge lights or runway centre line markings Night: at least runway edge lights or runway centre line lights and runway end lights	400

* The reported RVR or VIS value representative of the initial part of the take-off run can be replaced by pilot assessment.

** The pilot is able to continuously identify the take-off surface and maintain directional control.

Table 2
Take-off — aeroplanes (without an LVTO approval)
Assumed engine failure height above the take-off runway versus RVR or VIS

Assumed engine failure height above the take-off runway (ft)	RVR or VIS (m)*
<50	400
51–100	400
101–150	400
151–200	500
201–300	1 000
>300 or if no positive take-off flight path can be constructed	1 500

* The reported RVR or VIS value representative of the initial part of the take-off run can be replaced by pilot assessment.

(2) Helicopters

- (i) For helicopters having a mass where it is possible to reject the take-off and land on the FATO in case of the critical engine failure being recognised at or before the take-off decision point (TDP), the operator should specify an RVR or VIS as take-off minima in accordance with Table 3.
- (ii) For all other cases, the pilot-in-command should operate to take-off minima of 800 m RVR or VIS and remain clear of cloud during the take-off manoeuvre until reaching the performance capabilities of (c)(2)(i).
- (iii) For point-in-space (PinS) departures to an initial departure fix (IDF), the take-off minima should be selected to ensure sufficient guidance to see and avoid obstacles and return to the heliport if the flight cannot continue visually to the IDF.

Table 3

Take-off — helicopters (without LVTO approval)

RVR or VIS

Onshore aerodromes or operating sites with instrument flight rules (IFR) departure procedures	RVR or VIS (m)**
No light and no markings (day only)	400 or the rejected take-off distance, whichever is the greater
No markings (night)	800
Runway edge/FATO light and centre line marking	400
Runway edge/FATO light, centre line marking and relevant RVR information	400
Offshore helideck*	
Two-pilot operations	400
Single-pilot operations	500

* The take-off flight path to be free of obstacles.

** On PinS departures to IDF, VIS should not be less than 800 m and ceiling should not be less than 250 ft.

AMC4 SPO.OP.110 Aerodrome operating minima — aeroplanes and helicopters

ED Decision 2022/014/R

DETERMINATION OF THE DH/MDH FOR INSTRUMENT APPROACH OPERATIONS — AEROPLANES

- (a) The decision height (DH) to be used for a 3D approach operation or a 2D approach operation flown using the continuous descent final approach (CDFA) technique should not be lower than the highest of:
 - (1) the obstacle clearance height (OCH) for the category of aircraft;
 - (2) the published approach procedure DH or minimum descent height (MDH) where applicable;
 - (3) the system minima specified in Table 4;

- (4) the minimum DH permitted for the runway specified in Table 5; or
 - (5) the minimum DH specified in the AFM or equivalent document, if stated.
- (b) The MDH for a 2D approach operation flown not using CDFA technique should not be lower than the highest of:
- (1) the OCH for the category of aircraft;
 - (2) the published approach procedure MDH where applicable;
 - (3) the system minimum specified in Table 4;
 - (4) the lowest MDH permitted for the runway specified in Table 5; or
 - (5) the lowest MDH specified in the AFM, if stated.

DETERMINATION OF THE DH/MDH FOR INSTRUMENT APPROACH OPERATIONS — HELICOPTERS

- (c) The DH or MDH should not be lower than the highest of:
- (1) the OCH for the category of aircraft;
 - (2) the published approach procedure DH or MDH where applicable;
 - (3) the system minima specified in Table 4;
 - (4) the lowest DH or MDH permitted for the runway/FATO specified in Table 6 if applicable;
or
 - (5) the lowest DH or MDH specified in the AFM, if stated.

Table 4
System minima — all aircraft

Facility	Lowest DH/MDH (ft)
ILS/MLS/GLS	200
GNSS/SBAS (LPV)	200*
Precision approach radar (PAR)	200
GNSS/SBAS (LP)	250
GNSS (LNAV)	250
GNSS/Baro VNAV (LNAV/VNAV)	250
Helicopter PinS approach	250**
LOC with or without DME	250
SRA (terminating at ½ NM)	250
SRA (terminating at 1 NM)	300
SRA (terminating at 2 NM or more)	350
VOR	300
VOR/DME	250
NDB	350
NDB/DME	300
VDF	350

* For localiser performance with vertical guidance (LPV), a DH of 200 ft may be used only if the published final approach segment (FAS) datablock sets a vertical alert limit not exceeding 35 m. Otherwise, the DH should not be lower than 250 ft.

- ** For PinS approaches with instructions to ‘proceed VFR’ to an undefined or virtual destination, the DH or MDH should be with reference to the ground below the missed approach point (MAPt).

Table 5
Runway type minima — aeroplanes

Runway type	Lowest DH/MDH (ft)
Precision approach (PA) runway, category I	200
NPA runway	250
Non-instrument runway	Circling minima as shown in Table 1 in SPO.OP.112

Table 6
Type of runway/FATO versus lowest DH/MDH — helicopters

Type of runway/FATO	Lowest DH/MDH (ft)
PA runway, category I	200
NPA runway	
Non-instrument runway	
Instrument FATO	200
FATO	250

Table 6 does not apply to helicopter PinS approaches with instructions to ‘proceed VFR’.

AMC5 SPO.OP.110 Aerodrome operating minima — aeroplanes and helicopters

ED Decision 2022/014/R

DETERMINATION OF RVR OR VIS FOR INSTRUMENT APPROACH OPERATIONS — AEROPLANES

- (a) The RVR or VIS for straight-in instrument approach operations should not be less than the greatest of the following:
- (1) the minimum RVR or VIS for the type of runway used according to Table 7;
 - (2) the minimum RVR determined according to the MDH or DH and class of lighting facility according to Table 8; or
 - (3) the minimum RVR according to the visual and non-visual aids and on-board equipment used according to Table 9.

If the value determined in (1) is a VIS, then the result is a minimum VIS. In all other cases, the result is a minimum RVR.

- (b) For Category A and B aeroplanes, if the RVR or VIS determined in accordance with (a) is greater than 1 500 m, then 1 500 m should be used.
- (c) If the approach is flown with a level flight segment at or above the MDA/H, then 200 m should be added to the RVR calculated in accordance with (a) and (b) for Category A and B aeroplanes and 400 m for Category C and D aeroplanes.

- (d) The visual aids should comprise standard runway day markings, runway edge lights, threshold lights, runway end lights and approach lights as defined in Table 8.

Table 7
Type of runway versus minimum RVR or VIS — aeroplanes

Type of runway	Minimum RVR or VIS (m)
PA runway, category I	RVR 550
NPA runway	RVR 750
Non-instrument runway	VIS according to Table 1 in SPO.OP.112 (Circling minima)

Table 8
RVR versus DH/MDH

DH or MDH (ft)			Class of lighting facility			
			FALS	IALS	BALS	NALS
			RVR (m)			
200	—	210	550	750	1 000	1 200
211	—	240	550	800	1 000	1 200
241	—	250	550	800	1 000	1 300
251	—	260	600	800	1 100	1 300
261	—	280	600	900	1 100	1 300
281	—	300	650	900	1 200	1 400
301	—	320	700	1 000	1 200	1 400
321	—	340	800	1 100	1 300	1 500
341	—	360	900	1 200	1 400	1 600
361	—	380	1 000	1 300	1 500	1 700
381	—	400	1 100	1 400	1 600	1 800
401	—	420	1 200	1 500	1 700	1 900
421	—	440	1 300	1 600	1 800	2 000
441	—	460	1 400	1 700	1 900	2 100
461	—	480	1 500	1 800	2 000	2 200
481	—	500	1 500	1 800	2 100	2 300
501	—	520	1 600	1 900	2 100	2 400
521	—	540	1 700	2 000	2 200	2 400
541	—	560	1 800	2 100	2 300	2 400
561	—	580	1 900	2 200	2 400	2 400
581	—	600	2 000	2 300	2 400	2 400
601	—	620	2 100	2 400	2 400	2 400
621	—	640	2 200	2 400	2 400	2 400
641	—	660	2 300	2 400	2 400	2 400
661	and above		2 400	2 400	2 400	2 400

Table 9

Visual and non-visual aids and/or on-board equipment versus minimum RVR — aeroplanes

Type of approach	Facilities	Lowest RVR	
		Multi-pilot operations	Single-pilot operations
3D operations Final approach track offset $\leq 15^\circ$ for category A and B aeroplanes or $\leq 5^\circ$ for Category C and D aeroplanes	runway touchdown zone lights (RTZL) and runway centre line lights (RCLL)	No limitation	
	without RTZL and RCLL but using HUDLS or equivalent system; autopilot or flight director to the DH	No limitation	600 m
	No RTZL and RCLL, not using HUDLS or equivalent system or autopilot to the DH	750 m	800 m
3D operations	runway touchdown zone lights (RTZL) and runway centre line lights (RCLL) and Final approach track offset $> 15^\circ$ for Category A and B aeroplanes or Final approach track offset $> 5^\circ$ for Category C and D aeroplanes	800 m	1 000 m
	without RTZL and RCLL but using HUDLS or equivalent system; autopilot or flight director to the DH and Final approach track offset $> 15^\circ$ for Category A and B aeroplanes or Final approach track offset $> 5^\circ$ for Category C and D aeroplanes	800 m	1 000 m
2D operations	Final approach track offset $\leq 15^\circ$ for category A and B aeroplanes or $\leq 5^\circ$ for Category C and D aeroplanes	750 m	2D operations
	Final approach track offset $> 15^\circ$ for Category A and B aeroplanes	1 000 m	1 000 m
	Final approach track offset $> 5^\circ$ for Category C and D aeroplanes	1 200 m	1 200 m

Table 10

Approach lighting systems — aeroplanes

Class of lighting facility	Length, configuration and intensity of approach lights
FALS	CAT I lighting system (HIALS ≥ 720 m) distance coded centre line, barrette centre line
IALS	Simple approach lighting system (HIALS 420–719 m) single source, barrette
BALS	Any other approach lighting system (HIALS, MALS or ALS 210–419 m)
NALS	Any other approach lighting system (HIALS, MALS or ALS < 210 m) or no approach lights

- (e) For night operations or for any operation where credit for visual aids is required, the lights should be on and serviceable except as provided for in Table 15.
- (f) Where any visual or non-visual aid specified for the approach and assumed to be available in the determination of operating minima is unavailable, revised operating minima will need to be determined.

AMC6 SPO.OP.110 Aerodrome operating minima – aeroplanes and helicopters

ED Decision 2022/012/R

DETERMINATION OF RVR OR VIS FOR TYPE A INSTRUMENT APPROACH AND TYPE B CAT I INSTRUMENT APPROACH OPERATIONS — HELICOPTERS

- (a) For IFR operations, the RVR or VIS should not be less than the greatest of:
 - (1) the minimum RVR or VIS for the type of runway/FATO used according to Table 11;
 - (2) the minimum RVR determined according to the MDH or DH and class of lighting facility according to Table 12; or
 - (3) for PinS operations with instructions to ‘proceed visually’, the distance between the MAPt of the PinS and the FATO or its approach light system.

If the value determined in (1) is a VIS, then the result is a minimum VIS. In all other cases, the result is a minimum RVR.

- (b) For PinS operations with instructions to ‘proceed VFR’, the VIS should be compatible with visual flight rules.
- (c) For Type A instrument approaches where the MAPt is within ½ NM of the landing threshold, the approach minima specified for FALS may be used regardless of the length of approach lights available. However, FATO/runway edge lights, threshold lights, end lights and FATO/runway markings are still required.
- (d) An RVR of less than 800 m should not be used except when using a suitable autopilot coupled to an ILS, MLS, GLS or LPV, in which case normal minima apply.
- (e) For night operations, ground lights should be available to illuminate the FATO/runway and any obstacles.
- (f) The visual aids should comprise standard runway day markings, runway edge lights, threshold lights and runway end lights and approach lights as specified in Table 13.
- (g) For night operations or for any operation where credit for runway and approach lights as defined in Table 13 is required, the lights should be on and serviceable except as provided for in Table 15.

Table 11

Type of runway/FATO versus minimum RVR — helicopters

Type of runway/FATO	Minimum RVR or VIS (m)
PA runway, category I NPA runway Non-instrument runway	RVR 550
Instrument FATO FATO	RVR 550 RVR or VIS 800

Table 12
Onshore helicopter instrument approach minima

DH/MDH (ft)	Facilities versus RVR (m)			
	FALS	IALS	BALS	NALS
200	550	600	700	1 000
201–249	550	650	750	1 000
250–299	600*	700*	800	1 000
300 and above	750*	800	900	1 000

* Minima on 2D approach operations should be no lower than 800 m.

Table 13
Approach lighting systems — helicopters

Class of lighting facility	Length, configuration and intensity of approach lights
FALS	CAT I lighting system (HIALS \geq 720 m) distance coded centre line, barrette centre line
IALS	Simple approach lighting system (HIALS 420–719 m) single source, barrette
BALS	Any other approach lighting system (HIALS, MALS or ALS 210–419 m)
NALS	Any other approach lighting system (HIALS, MALS or ALS $<$ 210 m) or no approach lights

AMC7 SPO.OP.110 Aerodrome operating minima — aeroplanes and helicopters

ED Decision 2022/012/R

VISUAL APPROACH OPERATIONS

For a visual approach operation, the runway visual range (RVR) should not be less than 800 m.

AMC8 SPO.OP.110 Aerodrome operating minima — aeroplanes and helicopters

ED Decision 2022/012/R

CONVERSION OF VISIBILITY TO CMV — AEROPLANES

The following conditions apply to the use of CMV instead of RVR:

- (a) If the reported RVR is not available, a CMV may be substituted for the RVR, except:
 - (1) to satisfy take-off minima; or
 - (2) for the purpose of continuation of an approach in LVO.
- (b) If the minimum RVR for an approach is more than the maximum value assessed by the aerodrome operator, then CMV should be used.
- (c) In order to determine CMV from visibility:
 - (1) for flight planning purposes, a factor of 1.0 should be used;

- (2) for purposes other than flight planning, the conversion factors specified in Table 14 should be used.

Table 14
Conversion of reported VIS to RVR/CMV

Light elements in operation	RVR/CMV = reported VIS x	
	Day	Night
HI approach and runway lights	1.5	2.0
Any type of light installation other than above	1.0	1.5
No lights	1.0	not applicable

AMC9 SPO.OP.110 Aerodrome operating minima — aeroplanes and helicopters

ED Decision 2022/014/R

EFFECT ON LANDING MINIMA OF TEMPORARILY FAILED OR DOWNGRADED GROUND EQUIPMENT — COMPLEX MOTOR-POWERED AIRCRAFT

- (a) General

These instructions are intended for both pre-flight and in-flight use. It is, however, not expected that the pilot-in-command would consult such instructions after passing 1 000 ft above the aerodrome. If failures of ground aids are announced at such a late stage, the approach could be continued at the pilot-in-command's discretion. If failures are announced before such a late stage in the approach, their effect on the approach should be considered as described in Table 15 and, if considered necessary, the approach should be abandoned.

- (b) Conditions applicable to Table 15:

- (1) multiple failures of runway/FATO lights other than those indicated in Table 15 should not be acceptable;
- (2) failures of approach and runway/FATO lights are acceptable at the same time, and the most demanding consequence should be applied; and
- (3) failures other than ILS or MLS affect the RVR only and not the DH.

Table 15
Failed or downgraded equipment — effect on landing minima

Failed or downgraded equipment	Effect on landing minima	
	Type B	Type A
Navaid standby transmitter	No effect	
Outer marker (ILS only)	No effect if the required height or glide path can be checked using other means, e.g. DME fix	APV — not applicable NPA with FAF: no effect unless used as FAF If the FAF cannot be identified (e.g. no method available for timing of descent), NPA operations cannot be conducted
Middle marker (ILS only)	No effect	No effect unless used as MAPt

Failed or downgraded equipment	Effect on landing minima	
	Type B	Type A
RVR Assessment Systems	No effect	
Approach lights	Minima as for NALS	
Approach lights except the last 210 m	Minima as for BALS	
Approach lights except the last 420 m	Minima as for IALS	
Standby power for approach lights	No effect	
Edge lights, threshold lights and runway end lights	Day — no effect Night — not allowed	
Centre line lights	Aeroplanes: No effect if flight director (F/D), HUDLS or auto-land; otherwise RVR 750 m Helicopters: No effect on CAT I and SA CAT I approach operations.	No effect
Centre line lights spacing increased to 30 m	No effect	
TDZ lights	Aeroplanes: No effect if F/D, HUDLS or auto-land; otherwise RVR 750 m Helicopters: No effect.	No effect
Taxiway lighting system	No effect	

AMC10 SPO.OP.110 Aerodrome operating minima — aeroplanes and helicopters

ED Decision 2022/012/R

EFFECT ON LANDING MINIMA OF TEMPORARILY FAILED OR DOWNGRADED GROUND EQUIPMENT — OTHER-THAN COMPLEX MOTOR-POWERED AIRCRAFT

- Non-precision approaches requiring a final approach fix (FAF) and/or MAPt should not be conducted where a method of identifying the appropriate fix is not available.
- Where approach lighting is partly unavailable, minima should take account of the serviceable length of approach lighting.

GM1 SPO.OP.110 Aerodrome operating minima — aeroplanes and helicopters

ED Decision 2022/012/R

AIRCRAFT CATEGORIES

- Aircraft categories should be based on the indicated airspeed at threshold (V_{AT}), which is equal to the stalling speed (V_{SO}) multiplied by 1.3 or where published 1-g (gravity) stall speed (V_{S1g}) multiplied by 1.23 in the landing configuration at the maximum certified landing mass. If both V_{SO} and V_{S1g} are available, the higher resulting V_{AT} should be used.

- (b) The aircraft categories specified in Table 1 should be used.

Table 16

Aircraft categories corresponding to VAT values

Aircraft category	V _{AT}
A	Less than 91 kt
B	from 91 to 120 kt
C	from 121 to 140 kt
D	from 141 to 165 kt
E	from 166 to 210 kt

GM2 SPO.OP.110 Aerodrome operating minima – aeroplanes and helicopters

ED Decision 2014/018/R

CONTINUOUS DESCENT FINAL APPROACH (CDFA) — AEROPLANES

- (a) Introduction

- (1) Controlled flight into terrain (CFIT) is a major hazard in aviation. Most CFIT accidents occur in the final approach segment of non-precision approaches; the use of stabilised-approach criteria on a continuous descent with a constant, predetermined vertical path is seen as a major improvement in safety during the conduct of such approaches. Operators should ensure that the following techniques are adopted as widely as possible, for all approaches.
- (2) The elimination of level flight segments at MDA close to the ground during approaches, and the avoidance of major changes in attitude and power/thrust close to the runway that can destabilise approaches, are seen as ways to reduce operational risks significantly.
- (3) The term CDFA has been selected to cover a flight technique for any type of NPA operation.
- (4) The advantages of CDFA are as follows:
 - (i) the technique enhances safe approach operations by the utilisation of standard operating practices;
 - (ii) the technique is similar to that used when flying an ILS approach, including when executing the missed approach and the associated missed approach procedure manoeuvre;
 - (iii) the aeroplane attitude may enable better acquisition of visual cues;
 - (iv) the technique may reduce pilot workload;
 - (v) the approach profile is fuel efficient;
 - (vi) the approach profile affords reduced noise levels; and
 - (vii) the technique affords procedural integration with APV operations.

- (b) CDFA

- (1) Continuous descent final approach is defined in [Annex I](#) to the Regulation on Air operations.

- (2) An approach is only suitable for application of a CDFA technique when it is flown along a nominal vertical profile; a nominal vertical profile is not forming part of the approach procedure design, but can be flown as a continuous descent. The nominal vertical profile information may be published or displayed on the approach chart to the pilot by depicting the nominal slope or range/distance vs height. Approaches with a nominal vertical profile are considered to be:
- (i) NDB, NDB/DME;
 - (ii) VOR, VOR/DME;
 - (iii) LOC, LOC/DME;
 - (iv) VDF, SRA; and
 - (v) GNSS/LNAV.
- (3) Stabilised approach (SAP) is defined in [Annex I](#) to the Regulation on Air Operations.
- (i) The control of the descent path is not the only consideration when using the CDFA technique. Control of the aeroplane's configuration and energy is also vital to the safe conduct of an approach.
 - (ii) The control of the flight path, described above as one of the requirements for conducting an SAP, should not be confused with the path requirements for using the CDFA technique.
 - (iii) The predetermined approach slope requirements for applying the CDFA technique are established by the following:
 - (A) the published 'nominal' slope information when the approach has a nominal vertical profile; and
 - (B) the designated final-approach segment minimum of 3 NM, and maximum, when using timing techniques, of 8 NM.
 - (iv) An SAP will never have any level segment of flight at DA/H or MDA/H, as applicable. This enhances safety by mandating a prompt missed approach procedure manoeuvre at DA/H or MDA/H.
 - (v) An approach using the CDFA technique will always be flown as an SAP, since this is a requirement for applying CDFA. However, an SAP does not have to be flown using the CDFA technique, for example a visual approach.

GM3 SPO.OP.110 Aerodrome operating minima – aeroplanes and helicopters

ED Decision 2014/018/R

ONSHORE AERODROME DEPARTURE PROCEDURES — OPERATIONS WITH NON-COMPLEX HELICOPTERS

The cloud base and visibility should be such as to allow the helicopter to be clear of cloud at the take-off decision point (TDP), and for the pilot flying to remain in sight of the surface until reaching the minimum speed for flight in instrument meteorological conditions, as given in the AFM.

GM4 SPO.OP.110 Aerodrome operating minima – aeroplanes and helicopters

ED Decision 2014/018/R

TAKE-OFF MINIMA — OPERATIONS WITH COMPLEX HELICOPTERS

- (a) To ensure sufficient control of the helicopter in IMC, the speed, before entering in IMC, should be above the minimum authorised speed in IMC, V_{mini} . This is a limitation in the AFM. Therefore, the lowest speed before entering in IMC is the highest of V_{toss} (velocity take-off safety speed) and V_{mini} .
- (b) As example, V_{toss} is 45 kt and V_{mini} 60 kt. In that case, the take-off minima have to include the distance to accelerate to 60 kt. The take-off distance should be increased accordingly.

GM5 SPO.OP.110 Aerodrome operating minima — aeroplanes and helicopters

ED Decision 2022/012/R

APPROACH LIGHTING SYSTEMS — ICAO, FAA

The following table provides a comparison of the ICAO and FAA specifications.

Table 17

Approach lighting systems — ICAO and FAA specifications

Class of lighting facility	Length, configuration and intensity of approach lights
FALS	ICAO: CAT I lighting system (HIALS \geq 720 m) distance coded centre line, barrette centre line FAA: ALSF1, ALSF2, SSALR, MALSR, high- or medium-intensity and/or flashing lights, 720 m or more
IALS	ICAO: simple approach lighting system (HIALS 420–719 m) single source, barrette FAA: MALSF, MALS, SALS/SALSF, SSALF, SSALS, high- or medium-intensity and/or flashing lights, 420–719 m
BALS	Any other approach lighting system (e.g. HIALS, MALS or ALS 210–419 m) FAA: ODALS, high- or medium-intensity or flashing lights 210–419 m
NALS	Any other approach lighting system (e.g. HIALS, MALS or ALS $<$ 210 m) or no approach lights

GM6 SPO.OP.110 Aerodrome operating minima — aeroplanes and helicopters

ED Decision 2022/012/R

IAPs — SBAS OPERATIONS

- (a) SBAS LPV operations with a DH of 200 ft depend on an SBAS approved for operations down to a DH of 200 ft.
- (b) The following systems are in operational use or in a planning phase:
 - (1) European geostationary navigation overlay service (EGNOS), operational in Europe;
 - (2) wide area augmentation system (WAAS), operational in the USA;
 - (3) multi-functional satellite augmentation system (MSAS), operational in Japan;

- (4) system of differential correction and monitoring (SDCM), planned by Russia;
- (5) GPS-aided geo-augmented navigation (GAGAN) system, planned by India; and
- (6) satellite navigation augmentation system (SNAS), planned by China.

GM7 SPO.OP.110 Aerodrome operating minima — aeroplanes and helicopters

ED Decision 2022/012/R

MEANS TO DETERMINE THE REQUIRED RVR BASED ON DH AND LIGHTING FACILITIES

The values in Table 8 are derived from the formula below:

$RVR (m) = [(DH/MDH (ft) \times 0.3048)/\tan\alpha] - \text{length of approach lights (m)}$,

where α is the calculation angle, being a default value of 3.00° increasing in steps of 0.10° for each line in Table 8 up to 3.77° and then remaining constant. An upper RVR limit of 2 400 m has been applied to the table.

GM8 SPO.OP.110 Aerodrome operating minima — aeroplanes and helicopters

ED Decision 2022/012/R

USE OF DH FOR NPAs FLOWN USING THE CONTINUOUS DESCENT FINAL APPROACH (CDFA) TECHNIQUE

The safety of using the MDH as DH in CDFA operations has been verified by at least two independent analyses concluding that a CDFA using MDH as DH without any add-on is safer than the traditional step-down and level flight NPA operation. A comparison was made between the safety level of using MDH as DH without an add-on with the well-established safety level resulting from the ILS collision risk model (CRM). The NPA used was the most demanding, i.e. most tightly designed NPA, which offers the least additional margins. It should be noted that the design limits of the ILS approach design, e.g. the maximum glide path (GP) angle of 3.5 degrees, must be observed for the CDFA in order to keep the validity of the comparison.

There is a wealth of operational experience in Europe confirming the above-mentioned analytical assessments. It cannot be expected that each operator is able to conduct similar safety assessments, and this is not necessary. The safety assessments already performed take into account the most demanding circumstances at hand, like the most tightly designed NPA procedures and other 'worst-case scenarios'. The assessments naturally focus on cases where the controlling obstacle is located in the missed approach area.

However, it is necessary for operators to assess whether their cockpit procedures and training are adequate to ensure minimal height loss in case of a go-around manoeuvre. Suitable topics for the safety assessment required by each operator may include:

- understanding of the CDFA concept including use of the MDA/H as DA/H;
- cockpit procedures that ensure flight on speed, on path, and with proper configuration and energy management;
- cockpit procedures that ensure gradual decision-making; and
- identification of cases where an increase of the DA/H may be necessary because of non-standard circumstances, etc.

GM9 SPO.OP.110 Aerodrome operating minima — aeroplanes and helicopters

ED Decision 2022/012/R

INCREMENTS SPECIFIED BY THE COMPETENT AUTHORITY

Additional increments to the published minima may be specified by the competent authority in order to take into account certain operations, such as downwind approaches, single-pilot operations, or approaches flown not using the CDFA technique.

GM10 SPO.OP.110 Aerodrome operating minima — aeroplanes and helicopters

ED Decision 2022/014/R

USE OF COMMERCIALY AVAILABLE INFORMATION

When an operator uses commercially available information to establish aerodrome operating minima, the operator remains responsible for ensuring that the information used is accurate and suitable for its operation, and that the aerodrome operating minima are calculated in accordance with the method specified in Part C of its operations manual.

The operator should apply the procedures in [ORO.GEN.205](#) 'Contracted activities'.

GM1 SPO.OP.110(b)(5) Aerodrome operating minima

ED Decision 2022/012/R

VISUAL AND NON-VISUAL AIDS AND INFRASTRUCTURE

'Visual and non-visual aids and infrastructure' refers to all equipment and facilities required for the procedure to be used for the intended instrument approach operation. This includes but is not limited to lights, markings, ground- or space-based radio aids, etc.

SPO.OP.112 Aerodrome operating minima — circling operations with aeroplanes

Regulation (EU) 2021/2237

- (a) The minimum descent height (MDH) for a circling approach operation with aeroplanes shall not be lower than the highest of:
 - (1) the published circling OCH for the aeroplane category;
 - (2) the minimum circling height derived from Table 1; or
 - (3) the decision height (DH)/MDH of the preceding IAP.
- (b) The minimum visibility for a circling approach operation with aeroplanes shall be the highest of:
 - (1) the circling visibility for the aeroplane category, if published; or
 - (2) the minimum visibility derived from Table 1.

Table 1
MDH and minimum visibility for circling per aeroplane category

	Aeroplane category			
	A	B	C	D
MDH (ft)	400	500	600	700
Minimum VIS (m)	1 500	1 600	2 400	3 600

GM1 SPO.OP.112 Aerodrome operating minima — circling operations with aeroplanes

ED Decision 2022/012/R

SUPPLEMENTAL INFORMATION

- (a) The purpose of this guidance material is to provide operators with supplemental information regarding the application of aerodrome operating minima in relation to circling approaches.
- (b) Conduct of flight — general:
 - (1) the MDH and OCH included in the procedure are referenced to aerodrome elevation;
 - (2) the MDA is referenced to mean sea level;
 - (3) for these procedures, the applicable visibility is the VIS; and
 - (4) operators should provide tabular guidance of the relationship between height above threshold and the in-flight visibility required to obtain and sustain visual contact during the circling manoeuvre.
- (c) Instrument approach followed by visual manoeuvring (circling) without prescribed tracks:
 - (1) When the aeroplane is on the initial instrument approach, before visual reference is stabilised, but not below MDA/H, the aeroplane should follow the corresponding instrument approach procedure (IAP) until the appropriate instrument MAPt is reached.
 - (2) At the beginning of the level flight phase at or above the MDA/H, the instrument approach track should be maintained until the pilot:
 - (i) estimates that, in all probability, visual contact with the runway of intended landing or the runway environment will be maintained during the entire circling procedure;
 - (ii) estimates that the aeroplane is within the circling area before commencing circling; and
 - (iii) is able to determine the aeroplane's position in relation to the runway of intended landing with the aid of the appropriate visual references.
 - (3) If the pilot cannot comply with the conditions in (c)(2) at the MAPt, then a missed approach should be executed in accordance with the IAP.
 - (4) After the aeroplane has left the track of the initial instrument approach, the flight phase outbound from the runway should be limited to an appropriate distance, which is required to align the aeroplane onto the final approach. Such manoeuvres should be conducted to enable the aeroplane to:
 - (i) attain a controlled and stable descent path to the intended landing runway; and

- (ii) remain within the circling area and in such a way that visual contact with the runway of intended landing or runway environment is maintained at all times.
 - (5) Flight manoeuvres should be carried out at an altitude/height that is not less than the circling MDA/H.
 - (6) Descent below the MDA/H should not be initiated until the threshold of the runway to be used has been appropriately identified. The aeroplane should be in a position to continue with a normal rate of descent and land within the touchdown zone (TDZ).
- (d) Instrument approach followed by a visual manoeuvring (circling) with prescribed track.
- (1) The aeroplane should remain on the initial IAP until one of the following is reached:
 - (i) the prescribed divergence point to commence circling on the prescribed track; or
 - (ii) the MAPt.
 - (2) The aeroplane should be established on the instrument approach track in level flight at or above the MDA/H at or by the circling manoeuvre divergence point.
 - (3) If the divergence point is reached before the required visual reference is acquired, a missed approach should be initiated not later than the MAPt and completed in accordance with the initial instrument approach procedure.
 - (4) When commencing the prescribed circling manoeuvre at the published divergence point, the subsequent manoeuvres should be conducted to comply with the published routing and published heights/altitudes.
 - (5) Unless otherwise specified, once the aeroplane is established on the prescribed track(s), the published visual reference does not need to be maintained unless:
 - (i) required by the State of the aerodrome; or
 - (ii) the circling MAPt (if published) is reached.
 - (6) If the prescribed circling manoeuvre has a published MAPt and the required visual reference has not been obtained by that point, a missed approach should be executed in accordance with (e)(2) and (e)(3).
 - (7) Subsequent further descent below MDA/H should only commence when the required visual reference has been obtained.
 - (8) Unless otherwise specified in the procedure, final descent should not be commenced from the MDA/H until the threshold of the intended landing runway has been identified and the aeroplane is in a position to continue with a normal rate of descent to land within the TDZ.
- (e) Missed approach
- (1) Missed approach during the instrument procedure prior to circling:
 - (i) if the missed approach procedure is required to be flown when the aeroplane is positioned on the instrument approach track, and before commencing the circling manoeuvre, the published missed approach for the instrument approach should be followed; or
 - (ii) if the IAP is carried out with the aid of an ILS, an MLS or a SAP, the MAPt associated with an ILS or an MLS procedure without glide path (GP-out procedure) or the SAP, where applicable, should be used.

- (2) If a prescribed missed approach is published for the circling manoeuvre, this overrides the manoeuvres prescribed below.
- (3) If visual reference is lost while circling to land after the aeroplane has departed from the initial instrument approach track, the missed approach specified for that particular instrument approach should be followed. It is expected that the pilot will make an initial climbing turn toward the intended landing runway to a position overhead of the aerodrome where the pilot will establish the aeroplane in a climb on the instrument missed approach segment.
- (4) The aeroplane should not leave the visual manoeuvring (circling) area, which is obstacle protected, unless:
 - (i) established on the appropriate missed approach procedure; or
 - (ii) at minimum sector altitude (MSA).
- (5) All turns should be made in the same direction and the aeroplane should remain within the circling protected area while climbing to either:
 - (i) the altitude assigned to any published circling missed approach manoeuvre if applicable;
 - (ii) the altitude assigned to the missed approach of the initial instrument approach;
 - (iii) the MSA;
 - (iv) the minimum holding altitude (MHA) applicable for transition to a holding facility or fix, or continue to climb to an MSA; or
 - (v) as directed by ATS.

When the missed approach procedure is commenced on the 'downwind' leg of the circling manoeuvre, an 'S' turn may be undertaken to align the aeroplane on the initial instrument approach missed approach path, provided the aeroplane remains within the protected circling area.

The pilot-in-command should be responsible for ensuring adequate terrain clearance during the above-stipulated manoeuvres, particularly during the execution of a missed approach initiated by ATS.

- (6) Because the circling manoeuvre may be accomplished in more than one direction, different patterns will be required to establish the aeroplane on the prescribed missed approach course depending on its position at the time visual reference is lost. In particular, all turns are to be in the prescribed direction if this is restricted, e.g. to the west/east (left or right hand) to remain within the protected circling area.
- (7) If a missed approach procedure is published for a particular runway onto which the aeroplane is conducting a circling approach and the aeroplane has commenced a manoeuvre to align with the runway, the missed approach for this direction may be accomplished. The ATS unit should be informed of the intention to fly the published missed approach procedure for that particular runway.
- (8) The pilot-in-command should advise ATS when any missed approach procedure has been commenced, the height/altitude the aeroplane is climbing to and the position the aeroplane is proceeding towards and/or heading the aeroplane is established on.

SPO.OP.113 Aerodrome operating minima – onshore circling operations with helicopters

Regulation (EU) No 379/2014

The MDH for an onshore circling operation with helicopters shall not be lower than 250 ft and the meteorological visibility not less than 800 m.

SPO.OP.115 Departure and approach procedures – aeroplanes and helicopters

Regulation (EU) No 379/2014

- (a) The pilot-in-command shall use the departure and approach procedures established by the State of the aerodrome, if such procedures have been published for the runway or FATO to be used.
- (b) The pilot-in-command may deviate from a published departure route, arrival route or approach procedure:
 - (1) provided obstacle clearance criteria can be observed, full account is taken of the operating conditions and any ATC clearance is adhered to; or
 - (2) when being radar-vectorred by an ATC unit.
- (c) In the case of operations with complex motor-powered aircraft, the final approach segment shall be flown visually or in accordance with the published approach procedures.

AMC1 SPO.OP.115 Departure and approach procedures — aeroplanes and helicopters

ED Decision 2022/012/R

APPROACH FLIGHT TECHNIQUE — AEROPLANES

- (a) All approach operations should be flown as SAp operations.
- (b) The CDFA technique should be used for NPA procedures.

SPO.OP.116 Performance-based navigation – aeroplanes and helicopters

Regulation (EU) 2016/1199

The operator shall ensure that, when PBN is required for the route or procedure to be flown:

- (a) the relevant PBN specification is stated in the AFM or other document that has been approved by the certifying authority as part of an airworthiness assessment or is based on such approval; and
- (b) the aircraft is operated in conformance with the relevant navigation specification and limitations in the AFM or other document mentioned above.

AMC1 SPO.OP.116 Performance-based navigation – aeroplanes and helicopters

ED Decision 2016/021/R

PBN OPERATIONS

For operations where a navigation specification for performance-based navigation (PBN) has been prescribed and no specific approval is required in accordance with [SPA.PBN.100](#), the operator should:

- (a) establish operating procedures specifying:
 - (1) normal, abnormal and contingency procedures;
 - (2) electronic navigation database management; and
 - (3) relevant entries in the minimum equipment list (MEL);
- (b) specify the flight crew qualification and proficiency constraints and ensure that the training programme for relevant personnel is consistent with the intended operation; and
- (c) ensure continued airworthiness of the area navigation system.

AMC2 SPO.OP.116 Performance-based navigation – aeroplanes and helicopters

ED Decision 2022/014/R

MONITORING AND VERIFICATION

- (a) Preflight and general considerations
 - (1) At navigation system initialisation, the flight crew should confirm that the navigation database is current and verify that the aircraft position has been entered correctly, if required.
 - (2) The active flight plan, if applicable, should be checked by comparing the charts or other applicable documents with navigation equipment and displays. This includes confirmation of the departing runway and the waypoint sequence, reasonableness of track angles and distances, any altitude or speed constraints, and, where possible, which waypoints are fly-by and which are fly-over. Where relevant, the RF leg arc radii should be confirmed.
 - (3) The flight crew should check that the navigation aids critical to the operation of the intended PBN procedure are available.
 - (4) The flight crew should confirm the navigation aids that should be excluded from the operation, if any.
 - (5) An arrival, approach or departure procedure should not be used if the validity of the procedure in the navigation database has expired.
 - (6) The flight crew should verify that the navigation systems required for the intended operation are operational.
- (b) Departure
 - (1) Prior to commencing a take-off on a PBN procedure, the flight crew should check that the indicated aircraft position is consistent with the actual aircraft position at the start of the take-off roll (aeroplanes) or lift-off (helicopters).

- (2) Where GNSS is used, the signal should be acquired before the take-off roll (aeroplanes) or lift-off (helicopters) commences.
 - (3) Unless automatic updating of the actual departure point is provided, the flight crew should ensure initialisation on the runway or FATO by means of a manual runway threshold or intersection update, as applicable. This is to preclude any inappropriate or inadvertent position shift after take-off.
- (c) Arrival and approach
- (1) The flight crew should verify that the navigation system is operating correctly and the correct arrival procedure and runway (including any applicable transition) are entered and properly depicted.
 - (2) Any published altitude and speed constraints should be observed.
 - (3) The flight crew should check approach procedures (including alternate aerodromes if needed) as extracted by the system (e.g. CDU flight plan page) or presented graphically on the moving map, in order to confirm the correct loading and the reasonableness of the procedure content.
 - (4) Prior to commencing the approach operation (before the IAF), the flight crew should verify the correctness of the loaded procedure by comparison with the appropriate approach charts. This check should include:
 - (i) the waypoint sequence;
 - (ii) reasonableness of the tracks and distances of the approach legs and the accuracy of the inbound course; and
 - (iii) the vertical path angle, if applicable.
- (d) Altimetry settings for RNP APCH operations using Baro VNAV
- (1) Barometric settings
 - (i) The flight crew should set and confirm the correct altimeter setting and check that the two altimeters provide altitude values that do not differ more than 100 ft at the most at or before the FAF.
 - (ii) The flight crew should fly the procedure with:
 - (A) a current local altimeter setting source available — a remote or regional altimeter setting source should not be used; and
 - (B) the QNH/QFE, as appropriate, set on the aircraft's altimeters.
 - (2) Temperature compensation
 - (i) For RNP APCH operations to LNAV/VNAV minima using Baro VNAV:
 - (A) the flight crew should not commence the approach when the aerodrome temperature is outside the promulgated aerodrome temperature limits for the procedure unless the area navigation system is equipped with approved temperature compensation for the final approach;
 - (B) when the temperature is within promulgated limits, the flight crew should not make compensation to the altitude at the FAF; and

- (C) since only the final approach segment is protected by the promulgated aerodrome temperature limits, the flight crew should consider the effect of temperature on terrain and obstacle clearance in other phases of flight.
- (ii) For RNP APCH operations to LNAV minima, the flight crew should consider the effect of temperature on terrain and obstacle clearance in all phases of flight, in particular on any step-down fix.
- (e) Sensor and lateral navigation accuracy selection
 - (1) For multi-sensor systems, the flight crew should verify, prior to approach, that the GNSS sensor is used for position computation.
 - (2) Flight crew of aircraft with RNP input selection capability should confirm that the indicated RNP value is appropriate for the PBN operation.

AMC3 SPO.OP.116 Performance-based navigation – aeroplanes and helicopters

ED Decision 2016/021/R

MANAGEMENT OF THE NAVIGATION DATABASE

- (a) For RNAV 1, RNAV 2, RNP 1, RNP 2, and RNP APCH, the flight crew should neither insert nor modify waypoints by manual entry into a procedure (departure, arrival or approach) that has been retrieved from the database. User-defined data may be entered and used for waypoint altitude/speed constraints on a procedure where said constraints are not included in the navigation database coding.
- (b) For RNP 4 operations, the flight crew should not modify waypoints that have been retrieved from the database. User-defined data (e.g. for flex-track routes) may be entered and used.
- (c) The lateral and vertical definition of the flight path between the FAF and the missed approach point (MAPt) retrieved from the database should not be revised by the flight crew.

AMC4 SPO.OP.116 Performance-based navigation – aeroplanes and helicopters

ED Decision 2016/021/R

DISPLAYS AND AUTOMATION

- (a) For RNAV 1, RNP 1, and RNP APCH operations, the flight crew should use a lateral deviation indicator, and where available, flight director and/or autopilot in lateral navigation mode.
- (b) The appropriate displays should be selected so that the following information can be monitored:
 - (1) the computed desired path;
 - (2) aircraft position relative to the lateral path (cross-track deviation) for FTE monitoring; and
 - (3) aircraft position relative to the vertical path (for a 3D operation).
- (c) The flight crew of an aircraft with a lateral deviation indicator (e.g. CDI) should ensure that lateral deviation indicator scaling (full-scale deflection) is suitable for the navigation accuracy associated with the various segments of the procedure.

- (d) The flight crew should maintain procedure centrelines unless authorised to deviate by ATC or demanded by emergency conditions.
- (e) Cross-track error/deviation (the difference between the area-navigation-system-computed path and the aircraft-computed position) should normally be limited to $\pm \frac{1}{2}$ time the RNAV/RNP value associated with the procedure. Brief deviations from this standard (e.g. overshoots or undershoots during and immediately after turns) up to a maximum of 1 time the RNAV/RNP value should be allowable.
- (f) For a 3D approach operation, the flight crew should use a vertical deviation indicator and, where required by AFM limitations, a flight director or autopilot in vertical navigation mode.
- (g) Deviations below the vertical path should not exceed 75 ft at any time, or half-scale deflection where angular deviation is indicated, and not more than 75 ft above the vertical profile, or half-scale deflection where angular deviation is indicated, at or below 1 000 ft above aerodrome level. The flight crew should execute a missed approach if the vertical deviation exceeds this criterion unless the flight crew has in sight the visual references required to continue the approach.

AMC5 SPO.OP.116 Performance-based navigation – aeroplanes and helicopters

ED Decision 2016/021/R

VECTERING AND POSITIONING

- (a) ATC tactical interventions in the terminal area may include radar headings, 'direct to' clearances which bypass the initial legs of an approach procedure, interceptions of an initial or intermediate segments of an approach procedure or the insertion of additional waypoints loaded from the database.
- (b) In complying with ATC instructions, the flight crew should be aware of the implications for the navigation system.
- (c) 'Direct to' clearances may be accepted to the IF provided that it is clear to the flight crew that the aircraft will be established on the final approach track at least 2 NM before the FAF.
- (d) 'Direct to' clearance to the FAF should not be acceptable. Modifying the procedure to intercept the final approach track prior to the FAF should be acceptable for radar-vectored arrivals or otherwise only with ATC approval.
- (e) The final approach trajectory should be intercepted no later than the FAF in order for the aircraft to be correctly established on the final approach track before starting the descent (to ensure terrain and obstacle clearance).
- (f) 'Direct to' clearances to a fix that immediately precede an RF leg should not be permitted.
- (g) For parallel offset operations en route in RNP 4 and A-RNP, transitions to and from the offset track should maintain an intercept angle of no more than 45° unless specified otherwise by ATC.

AMC6 SPO.OP.116 Performance-based navigation – aeroplanes and helicopters

ED Decision 2016/021/R

ALERTING AND ABORT

- (a) Unless the flight crew has sufficient visual reference to continue the approach operation to a safe landing, an RNP APCH operation should be discontinued if:
 - (1) navigation system failure is annunciated (e.g. warning flag);
 - (2) lateral or vertical deviations exceed the tolerances; and
 - (3) loss of the on-board monitoring and alerting system.
- (b) Discontinuing the approach operation may not be necessary for a multi-sensor navigation system that includes demonstrated RNP capability without GNSS in accordance with the AFM.
- (c) Where vertical guidance is lost while the aircraft is still above 1 000 ft AGL, the flight crew may decide to continue the approach to LNAV minima, when supported by the navigation system.

AMC7 SPO.OP.116 Performance-based navigation – aeroplanes and helicopters

ED Decision 2016/021/R

CONTINGENCY PROCEDURES

- (a) The flight crew should make the necessary preparation to revert to a conventional arrival procedure where appropriate. The following conditions should be considered:
 - (1) failure of the navigation system components including navigation sensors, and a failure effecting flight technical error (e.g. failures of the flight director or autopilot);
 - (2) multiple system failures affecting aircraft performance;
 - (3) coasting on inertial sensors beyond a specified time limit; and
 - (4) RAIM (or equivalent) alert or loss of integrity function.
- (b) In the event of loss of PBN capability, the flight crew should invoke contingency procedures and navigate using an alternative means of navigation.
- (c) The flight crew should notify ATC of any problem with PBN capability.
- (d) In the event of communication failure, the flight crew should continue with the operation in accordance with published lost communication procedures.

AMC8 SPO.OP.116 Performance-based navigation – aeroplanes and helicopters

ED Decision 2016/021/R

RNAV 10

- (a) Operating procedures and routes should take account of the RNAV 10 time limit declared for the inertial system, if applicable, considering also the effect of weather conditions that could affect flight duration in RNAV 10 airspace.

- (b) The operator may extend RNAV 10 inertial navigation time by position updating. The operator should calculate, using statistically-based typical wind scenarios for each planned route, points at which updates can be made, and the points at which further updates will not be possible.

GM1 SPO.OP.116 Performance-based navigation – aeroplanes and helicopters

ED Decision 2016/021/R

DESCRIPTION

- (a) For both, RNP X and RNAV X designations, the 'X' (where stated) refers to the lateral navigation accuracy (total system error) in NM, which is expected to be achieved at least 95 % of the flight time by the population of aircraft operating within the airspace, route or procedure. For RNP APCH and A-RNP, the lateral navigation accuracy depends on the segment.
- (b) PBN may be required on notified routes, for notified procedures and in notified airspace.

RNAV 10

- (c) For purposes of consistency with the PBN concept, this Regulation is using the designation 'RNAV 10' because this specification does not include on-board performance monitoring and alerting.
- (d) However, it should be noted that many routes still use the designation 'RNP 10' instead of 'RNAV 10'. 'RNP 10' was used as designation before the publication of the fourth edition of ICAO Doc 9613 in 2013. The terms 'RNP 10' and 'RNAV 10' should be considered equivalent.

SPO.OP.120 Noise abatement procedures

Regulation (EU) No 379/2014

The pilot-in-command shall take into account published noise abatement procedures to minimise the effect of aircraft noise while ensuring that safety has priority over noise abatement.

AMC1 SPO.OP.120 Noise abatement procedures

ED Decision 2014/018/R

NADP DESIGN — OPERATIONS WITH COMPLEX MOTOR-POWERED AIRCRAFT

- (a) For each aeroplane type two departure procedures should be defined, in accordance with ICAO Doc. 8168 (Procedures for Air Navigation Services, 'PANS-OPS'), Volume I:
- (1) noise abatement departure procedure one (NADP 1), designed to meet the close-in noise abatement objective; and
 - (2) noise abatement departure procedure two (NADP 2), designed to meet the distant noise abatement objective.
- (b) For each type of NADP (1 and 2), a single climb profile should be specified for use at all aerodromes, which is associated with a single sequence of actions. The NADP 1 and NADP 2 profiles may be identical.

GM1 SPO.OP.120 Noise abatement procedures

ED Decision 2014/018/R

TERMINOLOGY — OPERATIONS WITH COMPLEX MOTOR-POWERED AEROPLANES

- (a) 'Climb profile' means in this context the vertical path of the NADP as it results from the pilot's actions (engine power reduction, acceleration, slats/flaps retraction).
- (b) 'Sequence of actions' means the order in which these pilot's actions are done and their timing.

GENERAL

- (c) The rule addresses only the vertical profile of the departure procedure. Lateral track has to comply with the standard instrument departure (SID).

EXAMPLE

- (d) For a given aeroplane type, when establishing the distant NADP, the operator should choose either to reduce power first and then accelerate, or to accelerate first and then wait until slats/flaps are retracted before reducing power. The two methods constitute two different sequences of actions.
- (e) For an aeroplane type, each of the two departure climb profiles may be defined by one sequence of actions (one for close-in, one for distant) and two above aerodrome level (AAL) altitudes/heights. These are:
 - (1) the altitude of the first pilot's action (generally power reduction with or without acceleration). This altitude should not be less than 800 ft AAL; or
 - (2) the altitude of the end of the noise abatement procedure. This altitude should usually not be more than 3 000 ft AAL.
- (f) These two altitudes may be runway specific when the aeroplane flight management system (FMS) has the relevant function that permits the crew to change thrust reduction and/or acceleration altitude/height. If the aeroplane is not FMS equipped or the FMS is not fitted with the relevant function, two fixed heights should be defined and used for each of the two NADPs.

SPO.OP.125 Minimum obstacle clearance altitudes – IFR flights

Regulation (EU) No 379/2014

- (a) The operator shall specify a method to establish minimum flight altitudes that provide the required terrain clearance for all route segments to be flown in IFR.
- (b) The pilot-in-command shall establish minimum flight altitudes for each flight based on this method. The minimum flight altitudes shall not be lower than those published by the State overflown.

AMC1 SPO.OP.125 Minimum obstacle clearance altitudes – IFR flights

ED Decision 2014/018/R

GENERAL

Commercially available information specifying minimum obstacle clearance altitudes may be used.

SPO.OP.130 Fuel/energy scheme – aeroplanes and helicopters

Regulation (EU) 2021/1296

- (a) The operator shall establish, implement, and maintain a fuel/energy scheme that comprises:
 - (1) a fuel/energy planning and in-flight re-planning policy; and
 - (2) an in-flight fuel/energy management policy.
- (b) The fuel/energy scheme shall:
 - (1) be appropriate for the type(s) of operation performed; and
 - (2) correspond to the capability of the operator to support its implementation.

SPO.OP.131 Fuel/energy scheme – fuel/energy planning and in flight re-planning policy – aeroplanes and helicopters

Regulation (EU) 2021/1296

- (a) As part of the fuel/energy scheme, the operator shall establish a fuel/energy planning and in-flight re-planning policy to ensure that the aircraft carries a sufficient amount of usable fuel/energy to safely complete the planned flight and to allow for deviations from the planned operation.
- (b) The operator shall ensure that the fuel/energy planning of flights is based upon at least the following elements:
 - (1) procedures contained in the operations manual as well as:
 - (i) current aircraft-specific data derived from a fuel/energy consumption monitoring system or, if not available;
 - (ii) data provided by the aircraft manufacturer; and
 - (2) the operating conditions under which the flight is to be conducted including:
 - (i) aircraft fuel/energy consumption data;
 - (ii) anticipated masses;
 - (iii) anticipated meteorological conditions;
 - (iv) the effects of deferred maintenance items and/or configuration deviations; and
 - (v) anticipated delays.
- (c) For aeroplanes, the operator shall ensure that the pre-flight calculation of the usable fuel/energy that is required for a flight includes:
 - (1) taxi fuel/energy that shall not be less than the amount expected to be used prior to take-off;
 - (2) trip fuel/energy that shall be the amount of fuel/energy that is required to enable the aeroplane to fly from take-off, or from the point of in-flight re-planning, to landing at the destination aerodrome;
 - (3) contingency fuel/energy that shall be the amount of fuel/energy required to compensate for unforeseen factors;

-
- (4) destination alternate fuel/energy
 - (i) when a flight is operated with at least one destination alternate aerodrome, it shall be the amount of fuel/energy required to fly from the destination aerodrome to the destination alternate aerodrome; or
 - (ii) when a flight is operated with no destination alternate aerodrome, it shall be the amount of fuel/energy required to hold at the destination aerodrome to compensate for the lack of a destination alternate aerodrome;
 - (5) final reserve fuel/energy that shall be protected to ensure a safe landing; the operator shall take into account all of the following, and in the following order of priority, to determine the quantity of the final reserve fuel/energy:
 - (i) the severity of the hazard to persons or property that may result from an emergency landing after fuel/energy starvation;
 - (ii) the likelihood of unexpected circumstances that the final reserve fuel/energy may no longer be protected;
 - (6) additional fuel/energy, if required by the type of operation; it shall be the amount of fuel/energy to enable the aeroplane to perform a safe landing at a fuel/energy en route alternate aerodrome (fuel/energy ERA aerodrome critical scenario) in the event of an engine failure or loss of pressurisation, whichever requires the greater amount of fuel/energy, based on the assumption that such a failure occurs at the most critical point along the route; this additional fuel/energy is required only if the minimum amount of fuel/energy that is calculated according to points (c)(2) to (c)(5) is not sufficient for such an event;
 - (7) extra fuel/energy to take into account anticipated delays or specific operational constraints; and
 - (8) discretionary fuel/energy, if required by the pilot-in-command.
- (d) For helicopters, the operator shall ensure that the pre-flight calculation of the usable fuel/energy that is required for a flight includes all of the following:
- (1) fuel/energy to fly to the aerodrome or operating site of intended landing;
 - (2) if a destination alternate is required, destination alternate fuel/energy, which shall be the amount of fuel/energy that is required to execute a missed approach at the aerodrome or operating site of intended landing, and thereafter, to fly to the specified destination alternate, approach and land; and
 - (3) final reserve fuel/energy, which shall be protected to ensure a safe landing; the operator shall take into account all of the following, and in the following order of priority, to determine the quantity of the final reserve fuel/energy:
 - (i) the severity of the hazard to persons or property that may result from an emergency landing after fuel/energy starvation; and
 - (ii) the likelihood of such unexpected circumstances that the final reserve fuel/energy may no longer be protected;
 - (4) extra fuel/energy to take into account anticipated delays or specific operational constraints; and
 - (5) discretionary fuel/energy, if required by the pilot-in-command.

- (e) The operator shall ensure that, if a flight has to proceed to a destination aerodrome other than the one originally planned, in-flight re-planning procedures for calculating the required usable fuel/energy are available and comply with points (c)(2) to (c)(7) for aeroplanes, and point (d) for helicopters.
- (f) The pilot in command shall only commence a flight or continue in the event of in-flight re-planning, when satisfied that the aircraft carries at least the planned amount of usable fuel/energy and oil to safely complete the flight.

AMC1 SPO.OP.131 Fuel/energy scheme — fuel/energy planning and in-flight re-planning policy — aeroplanes and helicopters

ED Decision 2022/005/R

AEROPLANES

For the fuel planning policy, the amount of the required usable fuel for a flight should not be less than the sum of the following:

- (a) taxi fuel that should take into account the local conditions at the departure aerodrome and the APU consumption;
- (b) trip fuel that should include:
 - (1) fuel for take-off and climb from the aerodrome elevation to the initial cruising level/altitude, taking into account the expected departure routing;
 - (2) fuel from the top of climb to the top of descent, including any step climb/descent;
 - (3) fuel from the top of descent to the point where the approach procedure is initiated, taking into account the expected arrival routing; and
 - (4) fuel for making an approach and landing at the destination aerodrome;
- (c) contingency fuel that should be:
 - (1) 5 % of the planned trip fuel or, in the event of in-flight re-planning, 5 % of the trip fuel for the remainder of the flight; or
 - (2) an amount to fly for 5 minutes at holding speed at 1 500 ft (450 m) above the destination aerodrome in standard conditions,whichever is higher;
- (d) destination alternate fuel that should be:
 - (1) when the aeroplane is operated with one destination alternate aerodrome:
 - (i) fuel for a missed approach from the applicable DA/H or MDA/H at the destination aerodrome to the missed-approach altitude, taking into account the complete missed-approach procedure;
 - (ii) fuel for climb from the missed-approach altitude to the cruising level/altitude, taking into account the expected departure routing;
 - (iii) fuel for cruising from the top of climb to the top of descent, taking into account the expected routing;
 - (iv) fuel for descent from the top of descent to the point where the approach is initiated, taking into account the expected arrival routing; and

- (v) fuel for making an approach and landing at the destination alternate aerodrome;
- (2) when the aeroplane is operated with no destination alternate aerodrome, the amount of fuel to hold for 15 minutes at 1 500 ft (450 m) in standard conditions above the destination aerodrome elevation;
- (3) when the aerodrome of intended landing is an isolated aerodrome:
 - (i) for aeroplanes with reciprocating engines, the amount of fuel required to fly either for 45 minutes plus 15 % of the flight time planned for cruising, including the FRF, or for 2 hours, whichever is less; or
 - (ii) for turbine-engined aeroplanes, the amount of fuel required to fly for 2 hours with normal cruise consumption above the destination aerodrome, including the FRF.
- (e) FRF that should not be less than the fuel required to fly:
 - (1) for 10 minutes at normal cruising altitude under VFR by day, taking off and landing at the same aerodrome/landing site, and always remaining within sight of that aerodrome/landing site;
 - (2) for 30 minutes at normal cruising altitude for other VFR flights by day; and
 - (3) for 45 minutes at normal cruising altitude under VFR by night, and under IFR for aeroplanes with reciprocating engines; and
 - (4) for 30 minutes at holding speed at 1 500 ft (450 m) above the aerodrome elevation in standard conditions, which is calculated according to the estimated mass on arrival under VFR by night and under IFR for turbine-engined aeroplanes,

Note: When the operator follows point (e)(1) for the FRF, the operator should specify in the standard operating procedures (SOPs):

 - the type of operation in which such reduced RFR may be used; and
 - the methods of reading and calculating the remaining fuel.
- (f) additional fuel that should be the amount of fuel that allows the aeroplane to proceed, in the event of an engine failure or loss of pressurisation, from the most critical point along the route to a fuel en route alternate (fuel ERA) aerodrome in the relevant aircraft configuration, hold there for 15 minutes at 1 500 ft (450 m) above the aerodrome elevation in standard conditions, make an approach, and land;
- (g) extra fuel if there are anticipated delays or specific operational constraints; and
- (h) discretionary fuel, if required by the pilot-in-command.

HELICOPTERS

- (i) The FRF should not be less than the fuel required to fly:
 - (1) for 10 minutes at best-range speed, provided that the helicopter remains within 25 NM of the aerodrome/operating site of departure, under VFR;
 - (2) for 20 minutes at best-range speed for flights other than the ones referred to in (i)(1) under VFR; and
 - (3) for 30 minutes at holding speed at 1 500 ft (450 m) above the destination or destination alternate under IFR.

- (j) If point (i)(1) is used for the FRF, the operator should specify in the SOPs:
 - (1) the type of operation in which such reduced FRF may be used; and
 - (2) methods of reading and calculating the remaining fuel.

AMC1 SPO.OP.131(a)(1)(ii) Fuel and oil supply – helicopters

ED Decision 2014/018/R

REDUCED RESERVE FUEL

- (a) The operator should specify in the SOP:
 - (1) the type of activity where such reduced reserve fuel may be used; and
 - (2) methods of reading and calculating the remaining fuel.
- (b) Refuelling facilities should be available at the aerodrome/operating site.

SPO.OP.135 Safety briefing

Regulation (EU) No 379/2014

- (a) The operator shall ensure that, prior to take-off task specialists are given a briefing on:
 - (1) emergency equipment and procedures;
 - (2) operational procedures associated with the specialised task before each flight or series of flights
- (b) The briefing referred to in (a)(2) may be replaced by an initial and recurrent training programme. In such case the operator shall also define recency requirements.

AMC1 SPO.OP.135 Safety briefing

ED Decision 2014/018/R

TASK SPECIALISTS — GENERAL

- (a) The purpose of operational briefing is to ensure that task specialists are familiar with all aspects of the operation, including their responsibilities.
- (b) Such briefing should include, as appropriate:
 - (1) behaviour on the ground and in-flight, including emergency procedures;
 - (2) procedures for boarding and disembarking;
 - (3) procedures for loading and unloading the aircraft;
 - (4) use of doors in normal and emergency operations;
 - (5) use of communication equipment and hand signals;
 - (6) precautions in case of a landing on sloping ground; and
 - (7) in addition to the items listed from (b)(1) to (b)(6) before take-off:
 - (i) location of emergency exits;
 - (ii) restrictions regarding smoking;
 - (iii) restrictions regarding the use of portable electronic equipment; and
 - (iv) stowage of tools and hand baggage.

- (c) The briefing may be given as a verbal presentation or by issuing the appropriate procedures and instructions in written form. Before commencement of the flight, their understanding should be confirmed.

SPO.OP.140 Flight preparation

Regulation (EU) 2021/2237

- (a) Before commencing a flight, the pilot-in-command shall ascertain by every reasonable means available that the space-based facilities, ground and/or water facilities, including communication facilities and navigation aids available and directly required on such flight, for the safe operation of the aircraft, are adequate for the type of operation under which the flight is to be conducted.
- (b) Before commencing a flight, the pilot-in-command shall be familiar with all available meteorological information appropriate to the intended flight. Preparation for a flight away from the vicinity of the place of departure, and for every flight under IFR, shall include:
- (1) a study of the available current meteorological reports and forecasts; and
 - (2) the planning of an alternative course of action to provide for the eventuality that the flight cannot be completed as planned, because of meteorological conditions.

SPO.OP.143 Destination alternate aerodromes planning minima — aeroplanes

Regulation (EU) 2021/2237

An aerodrome shall not be specified as a destination alternate aerodrome unless the available current meteorological information indicates, for the period from 1 hour before until 1 hour after the estimated time of arrival, or from the actual time of departure to 1 hour after the estimated time of arrival, whichever is the shorter period,

- (a) for an alternate aerodrome with an available instrument approach operation with DH less than 250 ft,
- (1) a ceiling of at least 200 ft above the DH or MDH associated with the instrument approach operation; and
 - (2) a visibility of at least the higher of 1 500 m and 800 m above the instrument approach operation RVR/VIS minima; or
- (b) for an alternate aerodrome with an instrument approach operation with DH or MDH 250 ft or more,
- (1) a ceiling of at least 400 ft above the DH or MDH associated with the instrument approach operation; and
 - (2) a visibility of at least 3 000 m; or
- (c) for an alternate aerodrome without an instrument approach procedure,
- (1) a ceiling of at least the higher of 2 000 ft and the minimum safe IFR height; and
 - (2) a visibility of at least 5 000 m.

SPO.OP.144 Destination alternate aerodrome planning minima — helicopters

Regulation (EU) 2021/2237

The operator shall only select an aerodrome as a destination alternate aerodrome if the available current meteorological information indicates, for the period from 1 hour before until 1 hour after the estimated time of arrival, or from the actual time of departure to 1 hour after the estimated time of arrival, whichever is the shorter period,

- (a) for an alternate aerodrome with an IAP:
 - (1) a ceiling of at least 200 ft above the DH or MDH associated with the IAP; and
 - (2) a visibility of at least 1 500 m by day or 3 000 m by night; or
- (b) for an alternate aerodrome without an IAP:
 - (1) a ceiling of at least 2 000 ft or the minimum safe IFR height, whichever is greater; and
 - (2) a visibility of at least 1 500 m by day or 3 000 m by night.

SPO.OP.145 Take-off alternate aerodromes — complex motor-powered aeroplanes

Regulation (EU) 2021/2237

- (a) For IFR flights, the pilot-in-command shall specify at least one weather-permissible take-off alternate aerodrome in the flight plan if the meteorological conditions at the aerodrome of departure are at or below the applicable aerodrome operating minima or if it would not be possible to return to the aerodrome of departure for other reasons.
- (b) The take-off alternate aerodrome shall be located within the following distance from the aerodrome of departure:
 - (1) for aeroplanes having two engines, not more than a distance equivalent to a flight time of 1 hour at the single-engine cruise speed in still air standard conditions; and
 - (2) for aeroplanes having three or more engines, not more than a distance equivalent to a flight time of 2 hours at the one-engine-inoperative (OEI) cruise speed according to the AFM in still air standard conditions.
- (c) For an aerodrome to be selected as a take-off alternate aerodrome the available information shall indicate that, at the estimated time of use, the conditions will be at or above the aerodrome operating minima for that operation.

SPO.OP.150 Destination alternate aerodromes — aeroplanes

Regulation (EU) 2021/1296

For IFR flights, the pilot-in-command shall specify at least one weather-permissible destination alternate aerodrome in the flight plan, unless:

- (a) the available current meteorological information indicates that, for the period from 1 hour before until 1 hour after the estimated time of arrival, or from the actual time of departure to 1 hour after the estimated time of arrival, whichever is the shorter period, the approach and landing may be made under visual meteorological conditions (VMC); or

- (b) the place of intended landing is designated as an isolated aerodrome and:
- (1) an instrument approach procedure is prescribed for the aerodrome of intended landing; and
 - (2) available current meteorological information indicates that both following meteorological conditions will exist from 2 hours before to 2 hours after the estimated time of arrival, or from the actual time of departure to 2 hours after the estimated time of arrival whichever is the shorter period:
 - (i) a cloud base of at least 300 m (1 000 ft) above the minimum associated with the instrument approach procedure;
 - (ii) visibility of at least 5,5 km or of 4 km more than the minimum associated with the procedure.

SPO.OP.151 Destination alternate aerodromes – helicopters

Regulation (EU) 2016/1199

For IFR flights, the pilot-in-command shall specify at least one weather-permissible destination alternate aerodrome in the flight plan, unless:

- (a) an instrument approach procedure is prescribed for the aerodrome of intended landing and the available current meteorological information indicates that the following meteorological conditions will exist from 2 hours before to 2 hours after the estimated time of arrival, or from the actual time of departure to 2 hours after the estimated time of arrival, whichever is the shorter period:
 - (1) a cloud base of at least 120 m (400 ft) above the minimum associated with the instrument approach procedure; and
 - (2) visibility of at least 1 500 m more than the minimum associated with the procedure; or
- (b) the place of intended landing is isolated and:
 - (1) an instrument approach procedure is prescribed for the aerodrome of intended landing;
 - (2) available current meteorological information indicates that the following meteorological conditions will exist from 2 hours before to 2 hours after the estimated time of arrival:
 - (i) the cloud base is at least 120 m (400 ft) above the minimum associated with the instrument approach procedure;
 - (ii) visibility is at least 1 500 m more than the minimum associated with the procedure.

SPO.OP.152 Destination aerodromes – instrument approach operations

Regulation (EU) 2016/1199

The pilot-in-command shall ensure that sufficient means are available to navigate and land at the destination aerodrome or at any destination alternate aerodrome in the case of loss of capability for the intended approach and landing operation.

AMC1 SPO.OP.152 Destination aerodromes — instrument approach operations

ED Decision 2022/012/R

PBN OPERATIONS

- (a) When the operator intends to use PBN, the operator should either:
- (1) demonstrate that the GNSS is robust against loss of capability; or
 - (2) select an aerodrome as a destination alternate aerodrome only if an IAP that does not rely on a GNSS is available either at that aerodrome or at the destination aerodrome.

GNSS ROBUSTNESS AGAINST LOSS OF CAPABILITY — HELICOPTERS

- (b) The operator may demonstrate robustness against the loss of capability of the GNSS if all of the following criteria are met:
- (1) SBAS or GBAS are available and used.
 - (2) The failure of a single receiver or system should not compromise the navigation capability required for the intended instrument approach.
 - (3) The temporary jamming of all GNSS frequencies should not compromise the navigation capability required for the intended route. The operator should provide a procedure to deal with such cases unless other sensors are available to continue on the intended route.
 - (4) The duration of a jamming event should be determined as follows:
 - (i) Considering the average speed and height of a helicopter flight, the duration of a jamming event may be considered to be less than 2 minutes.
 - (ii) The time needed for the GNSS system to re-start and provide the aircraft position and navigation guidance should also be considered.
 - (iii) Based on (i) and (ii) above, the operator should establish the duration of the loss of GNSS navigation data due to jamming. This duration should be no less than 3 minutes, and may be no longer than 4 minutes.
 - (5) The operator should ensure resilience to jamming for the duration determined in (4) above, as follows:
 - (i) If the altitude of obstacles on both sides of the flight path are higher than the planned altitude for a given segment of the flight, the operator should ensure no excessive drift on either side by relying on navigation sensors such as inertial systems with performance in accordance with the intended function.
 - (ii) If (i) does not apply and the operator cannot rely on sensors other than GNSS, the operator should develop a procedure to ensure that a drift from the intended route during the jamming event has no adverse consequences on the safety of the flight. This procedure may involve air traffic services.
 - (6) The operator should ensure that no space weather event is predicted to disrupt the GNSS reliability and integrity at both the destination and the alternate.
 - (7) The operator should verify the availability of RAIM for all phases of flight based on GNSS, including navigation to the alternate.
 - (8) The operator's MEL should reflect the elements in points (b)(1) and (b)(2).

OPERATIONAL CREDITS

- (c) To comply with point SPO.OP.153, when the operator intends to use ‘operational credits’ (e.g. EFVS, SA CAT I, etc.), the operator should select an aerodrome as destination alternate aerodrome only if an approach procedure that does not rely on the same ‘operational credit’ is available either at that aerodrome or at the destination aerodrome.

GM1 SPO.OP.152 Destination aerodromes – instrument approach operations

ED Decision 2016/021/R

INTENT OF AMC1

- (a) The limitation applies only to destination alternate aerodromes for flights when a destination alternate aerodrome is required. A take-off or en route alternate aerodrome with instrument approach procedures relying on GNSS may be planned without restrictions. A destination aerodrome with all instrument approach procedures relying solely on GNSS may be used without a destination alternate aerodrome if the conditions for a flight without a destination alternate aerodrome are met.
- (b) The term ‘available’ means that the procedure can be used in the planning stage and complies with planning minima requirements.

GM2 SPO.OP.152 Destination aerodromes — instrument approach operations

ED Decision 2022/012/R

GNSS ROBUSTNESS AGAINST LOSS OF CAPABILITY — HELICOPTERS

- (a) Redundancy of on-board systems ensures that no single on-board equipment failure (e.g. antenna, GNSS receiver, FMS, or navigation display failure) results in the loss of the GNSS capability.
- (b) Any shadowing of the GNSS signal or jamming of all GNSS frequencies from the ground is expected to be of a very short duration and affect a very small area. Additional sensors or functions such as inertial coasting may be used during jamming events. Jamming should be considered on all segments of the intended route, including the approach.
- (c) The availability of GNSS signals can be compromised if space weather events cause ‘loss of lock’ conditions and more than one satellite signal may be lost on a given GNSS frequency. Until space weather forecasts are available, the operator may use ‘nowcasts’ as short-term predictions for helicopter flights of short durations.
- (d) SBAS also contributes to mitigate space weather effects, both by providing integrity messages and by correcting ionosphere-induced errors.
- (e) Even though SBAS should be available and used, RAIM should remain available autonomously. In case of loss of the SBAS, the route and the approach to the destination or alternate should still be flown with an available RAIM function.
- (f) When available, GNSS based on more than one constellation and more than one frequency may provide better integrity and redundancy regarding failures in the space segment of the GNSS, jamming, and resilience to space weather events.

SPO.OP.155 Refuelling with persons embarking, on board or disembarking

Regulation (EU) 2021/1296

- (a) The aircraft shall not be refuelled with aviation gasoline (AVGAS) or wide-cut type fuel or a mixture of these types of fuel, when persons are embarking, on board or disembarking.
- (b) For all other types of fuel/energy, necessary precautions shall be taken and the aircraft shall be properly manned by qualified personnel ready to initiate and direct an evacuation of the aircraft by the most practical and expeditious means available.

AMC1 SPO.OP.155 Refuelling with persons embarking, on board or disembarking

ED Decision 2022/005/R

OPERATIONAL PROCEDURES — AEROPLANES

- (a) Operational procedures should specify that at least the following precautions are taken:
 - (1) One qualified person should remain at a specified location during fuelling operations with persons on board. This qualified person should be capable of handling emergency procedures concerning fire protection and firefighting, handling communications and initiating and directing an evacuation.
 - (2) Two-way communication should be established and should remain available by the aeroplane's inter-communication system or other suitable means between the ground crew supervising the refuelling and the qualified personnel on board the aeroplane; the involved personnel should remain within easy reach of the system of communication.
 - (3) Flight crew members and task specialists should be warned that refuelling will take place.
 - (4) 'Fasten seat belts' signs should be off.
 - (5) 'No smoking' signs should be on, together with interior lighting to enable emergency exits to be identified.
 - (6) Task specialists should be instructed to unfasten their seat belts and refrain from smoking.
 - (7) If the presence of fuel vapour is detected inside the aeroplane, or any other hazard arises during refuelling, fuelling should be stopped immediately.
 - (8) The ground area beneath the exits intended for emergency evacuation and slide deployment areas should be kept clear.
 - (9) Provision should be made for a safe and rapid evacuation.

AMC2 SPO.OP.155 Refuelling with persons embarking, on board or disembarking

ED Decision 2022/005/R

OPERATIONAL PROCEDURES — helicopters

When the helicopter rotors are stopped, the efficiency and speed of task specialists disembarking from and re-embarking on board helicopters is such that disembarking before refuelling and re-embarking after refuelling is the general practice. However, if such operations are needed, the operator should

refer to [AMC1 SPO.OP.157](#) and [AMC2 SPO.OP.157](#). Operational procedures to be described in the operations manual (OM) should specify that at least the relevant precautions of the aforementioned AMC are taken.

GM1 SPO.OP.155 Refuelling with persons embarking, on board or disembarking

ED Decision 2014/018/R

AIRCRAFT REFUELLING PROVISIONS AND GUIDANCE ON SAFE REFUELLING PRACTICES

Provisions concerning aircraft refuelling are contained in Volume I (Aerodrome Design and Operations) of ICAO Annex 14 (Aerodromes), and guidance on safe refuelling practices is contained in Parts 1 and 8 of the ICAO Airport Services Manual (Doc 9137).

SPO.OP.157 Refuelling with engine(s) and/or rotors turning – helicopters

Regulation (EU) 2021/1296

- (a) Refuelling with engine(s) and/or rotors turning shall only be conducted:
 - (1) with no task specialists embarking or disembarking;
 - (2) if the operator of the aerodrome or operating site allows such operations;
 - (3) in accordance with any specific procedures and limitations in the aircraft flight manual (AFM);
 - (4) with JET A or JET A-1 fuel types; and
 - (5) in the presence of the appropriate rescue and firefighting (RFF) facilities or equipment.
- (b) The operator shall assess the risks associated with refuelling with engine(s) and/or rotors turning.
- (c) The operator shall establish appropriate procedures to be followed by all involved personnel, such as crew members, task specialists, and ground operations personnel.
- (d) The operator shall ensure that its crew members, ground operations personnel, as well as any task specialist involved in the procedures, are appropriately trained.
- (e) The operator shall ensure that the helicopter refuelling procedures with engine(s) and/or rotors turning are specified in the operations manual.

AMC1 SPO.OP.157 Refuelling with engine(s) and/or rotors turning – helicopters

ED Decision 2022/005/R

OPERATIONAL PROCEDURES — NO TASK SPECIALISTS ON BOARD

Operational procedures in the OM should specify that at least the following precautions are taken:

- (a) all necessary information should be exchanged in advance with the aerodrome operator, operating-site operator, and refuelling operator;
- (b) the procedures to be used by crew members should be defined;

- (c) the procedures to be used by the operator's ground operations personnel that may be in charge of refuelling or assisting in emergency evacuations should be described;
- (d) the operator's training programmes for crew members and for the operator's ground operations personnel should be described;
- (e) the minimum distance between the helicopter turning parts and the refuelling vehicle or installations should be defined when the refuelling takes place outside an aerodrome or at an aerodrome where there are no such limitations;
- (f) besides any rescue and firefighting services (RFFSs) that are required to be available by aerodrome regulations, an additional handheld fire extinguisher with the equivalent of 5 kg of dry powder should be immediately available and ready for use;
- (g) a means for a two-way communication between the crew and the person in charge of refuelling should be defined and established;
- (h) if fuel vapour is detected inside the helicopter, or any other hazard arises, refuelling/defuelling should be stopped immediately;
- (i) one pilot should stay at the controls, constantly monitor the refuelling, and be ready to shut off the engines and evacuate at all times; and
- (j) any additional precautions should be taken, as determined by the risk assessment.

AMC2 SPO.OP.157 Refuelling with the engine(s) running and/or rotors turning — helicopters

ED Decision 2022/005/R

OPERATIONAL PROCEDURES — TASK SPECIALISTS ON BOARD

In addition to [AMC1 SPO.OP.157](#), for refuelling with task specialists on board, operational procedures in the OM should specify that at least the following precautions are taken:

- (a) the positioning of the helicopter and the corresponding helicopter evacuation strategy should be defined taking into account the wind as well as the refuelling facilities or vehicles;
- (b) on a heliport, the ground area beneath the exits that are intended for emergency evacuation should be kept clear;
- (c) an additional task specialist briefing as well as instructions should be defined, and the 'No smoking' signs should be on unless 'No smoking' placards are installed;
- (d) interior lighting should be set to enable identification of emergency exits;
- (e) the use of doors during refuelling should be defined: doors on the refuelling side should remain closed, while doors on the opposite side should remain unlocked or, weather permitting, open unless otherwise specified in the AFM; and
- (f) at least one suitable person or appropriately trained task specialist capable of implementing emergency procedures for firefighting, communications, as well for initiating and directing an evacuation, should remain at a specified location; this person should not be the qualified pilot at the controls or the person performing the refuelling.

GM1 SPO.OP.157 Refuelling with the engine(s) and/or rotors turning — helicopters

ED Decision 2022/005/R

RISK ASSESSMENT

The risk assessment should explain why it is not practical to refuel with the engine(s) and rotors stopped, identify the additional hazards, and describe how the additional risks are controlled. Helicopter offshore operations (HOFO) are typical operations where the benefits should outweigh the risks if mitigation measures are taken.

Guidance on safe refuelling practices is contained in ICAO Doc 9137 Airport Services Manual, Parts 1 and 8.

The operator's risk assessment may include, but not be limited to, the following risks, hazards and mitigation measures:

- (a) risk related to refuelling with rotors turning;
- (b) risk related to the shutting down of the engines, including the risk of failures during start-up;
- (c) environmental conditions, such as wind limitations, displacement of exhaust gases, and blade sailing;
- (d) risk related to human factors and fatigue management, especially for single-pilot operations for long periods of time;
- (e) risk mitigation, such as the safety features of the fuel installation, rescue and firefighting (RFF) capability, number of personnel members available, ease of emergency evacuation of the helicopter, etc.;
- (f) assessment of the use of radio transmitting equipment;
- (g) determination of the use of seat belts; and
- (h) review of the portable electronic device (PED) policy.

SPO.OP.160 Use of headset

Regulation (EU) 2018/394

Each flight crew member required to be on duty in the flight crew compartment shall wear a headset with boom microphone or equivalent and use it as the primary device to communicate with ATS, other crew members and task specialists.

SPO.OP.165 Smoking

Regulation (EU) No 379/2014

The pilot-in-command shall not allow smoking on board or during refuelling or defuelling of the aircraft.

SPO.OP.170 Meteorological conditions

Regulation (EU) 2021/2237

- (a) The pilot-in-command shall only commence or continue a VFR flight if the latest available meteorological information indicates that the meteorological conditions along the route and at the intended destination at the estimated time of use will be at or above the applicable VFR operating minima.

- (b) The pilot-in-command shall only commence or continue an IFR flight towards the planned destination aerodrome if the latest available meteorological information indicates that, at the estimated time of arrival, the meteorological conditions at the destination or at least one destination alternate aerodrome are at or above the applicable aerodrome operating minima.
- (c) If a flight contains VFR and IFR segments, the meteorological information referred to in (a) and (b) shall be applicable as far as relevant.

AMC1 SPO.OP.170 Meteorological conditions

ED Decision 2014/018/R

EVALUATION OF METEOROLOGICAL CONDITIONS

Pilots should carefully evaluate the available meteorological information relevant to the proposed flight, such as applicable surface observations, winds and temperatures aloft, terminal and area forecasts, air meteorological information reports (AIRMETs), significant meteorological information (SIGMET) and pilot reports. The ultimate decision whether, when, and where to make the flight rests with the pilot-in-command. Pilots should continue to re-evaluate changing weather conditions.

AMC2 SPO.OP.170 Meteorological conditions

ED Decision 2014/018/R

APPLICATION OF AERODROME FORECASTS (TAF & TREND)

Where a terminal area forecast (TAF) or meteorological aerodrome or aeronautical report (METAR) with landing forecast (TREND) is used as forecast, the following criteria should be used:

- (a) From the start of a TAF validity period up to the time of applicability of the first subsequent 'FM...' or 'BECMG' or, if no 'FM' or 'BECMG' is given, up to the end of the validity period of the TAF, the prevailing weather conditions forecast in the initial part of the TAF should be applied.
- (b) From the time of observation of a METAR up to the time of applicability of the first subsequent 'FM...' or 'BECMG' or, if no 'FM' or 'BECMG' is given, up to the end of the validity period of the TREND, the prevailing weather conditions forecast in the METAR should be applied.
- (c) Following FM (alone) or BECMG AT, any specified change should be applied from the time of the change.
- (d) Following BECMG (alone), BECMG FM, BECMG TL, BECMG FM TL:
 - (1) in the case of deterioration, any specified change should be applied from the start of the change; and
 - (2) in the case of improvement, any specified change should be applied from the end of the change.
- (e) In a period indicated by TEMPO (alone), TEMPO FM, TEMPO TL, TEMPO FM TL, PROB30/40 (alone):
 - (1) deteriorations associated with persistent conditions in connection with e.g. haze, mist, fog, dust/sandstorm, continuous precipitation should be applied;
 - (2) deteriorations associated with transient/showery conditions in connection with short-lived weather phenomena, e.g. thunderstorms, showers may be ignored; and
 - (3) improvements should in all cases be disregarded.

- (f) In a period indicated by PROB30/40 TEMPO:
- (1) deteriorations may be disregarded; and
 - (2) improvements should be disregarded.

Note: Abbreviations used in the context of this AMC are as follows:

FM:	from
BECMG:	becoming
AT:	at
TL:	till
TEMPO:	temporarily
PROB:	probability

GM1 SPO.OP.170 Meteorological conditions

ED Decision 2014/018/R

CONTINUATION OF A FLIGHT

In the case of in-flight re-planning, continuation of a flight refers to the point from which a revised flight plan applies.

SPO.OP.175 Ice and other contaminants – ground procedures

Regulation (EU) No 379/2014

- (a) The pilot-in-command shall only commence take-off if the aircraft is clear of any deposit that might adversely affect the performance or controllability of the aircraft, except as permitted in the AFM.
- (b) In the case of operations with complex motor-powered aircraft, the operator shall establish procedures to be followed when ground de-icing and anti-icing and related inspections of the aircraft are necessary to allow the safe operation of the aircraft.

GM1 SPO.OP.175 Ice and other contaminants – ground procedures

ED Decision 2021/005/R

TERMINOLOGY

Terms used in the context of de-icing/anti-icing have the meaning defined in the following subparagraphs.

- (a) 'Anti-icing': the process of protecting the aircraft to prevent contamination due to existing or expected weather, typically by applying anti-icing fluids on uncontaminated aircraft surfaces.
- (b) 'Anti-icing fluid' includes, but is not limited to, the following:
 - (1) Typically, Type II, III or IV fluid (neat or diluted), normally applied unheated (*);
 - (2) Type I fluid/water mixture heated to minimum 60°C at the nozzle.

(*) When de-icing and anti-icing in a one-step process, Type II and Type IV fluids are typically applied diluted and heated.
- (c) 'Clear ice': a coating of ice, generally clear and smooth, but with some air pockets. It forms on exposed objects, the temperatures of which are at, below or slightly above the freezing

temperature, by the freezing of super-cooled drizzle, droplets or raindrops. Clear ice is very difficult to be detected visually.

- (d) 'Cold soaked surface frost (CSSF)': frost developed on cold soaked aircraft surfaces by sublimation of air humidity. This effect can take place at ambient temperatures above 0 °C. Cold soaked aircraft surfaces are more common on aircraft that have recently landed. External surfaces of fuel tanks (e.g. wing skins) are typical areas of CSSF formation (known in this case as cold soaked fuel frost (CSFF)), due to the thermal inertia of very cold fuel that remains on the tanks after landing.
 - (e) 'Conditions conducive to aircraft icing on the ground': freezing fog, freezing precipitation, frost, rain or high humidity (on cold soaked wings), hail, ice pellets, snow or mixed rain and snow, etc.
 - (f) 'Contamination': all forms of frozen or semi-frozen deposits on an aircraft, such as frost, snow, slush or ice.
 - (g) 'Contamination check': a check of the aircraft for contamination to establish the need for de-icing.
 - (h) 'De-icing': the process of eliminating frozen contamination from aircraft surfaces, typically by applying de-icing fluids.
 - (i) 'De-icing fluid': such fluid includes, but is not limited to, the following:
 - (1) Heated water;
 - (2) Preferably, Type I fluid (neat or diluted (typically));
 - (3) Type II, III or IV fluid (neat or diluted).
- The de-icing fluid is normally applied heated to ensure maximum efficiency and its freezing point should be at the outside air temperature (OAT) or below.
- (j) 'De-icing/anti-icing': this is the combination of de-icing and anti-icing performed in either one or two steps.
 - (k) 'Ground ice detection system (GIDS)': a system used during aircraft ground operations to inform the personnel involved in the operation and/or the flight crew about the presence of frost, ice, snow or slush on the aircraft surfaces.
 - (l) 'Holdover time (HOT)': the period of time during which an anti-icing fluid provides protection against frozen contamination to the treated aircraft surfaces. It depends among other variables, on the type and intensity of the precipitation, OAT, wind, the particular fluid (or fluid Type) and aircraft design and aircraft configuration during the treatment.
 - (m) 'Liquid water equivalent (LWE) system': an automated weather measurement system that determines the LWE precipitation rate in conditions of frozen or freezing precipitation. The system provides flight crew with continuously updated information on the fluid protection capability under varying weather conditions.
 - (n) 'Lowest operational use temperature (LOUT)': the lowest temperature at which a fluid has been tested and certified as acceptable in accordance with the appropriate aerodynamic acceptance test whilst still maintaining a freezing point buffer of not less than:
 - (1) 10°C for a Type I fluid; or
 - (2) 7°C for Type II, III or IV fluids.
 - (o) 'Post-treatment check', 'Post- de-icing check' or 'Post- de-icing/anti-icing check': an external check of the aircraft after de-icing and/or anti-icing treatment accomplished by qualified staff

and from suitably elevated observation points (e.g. from the de-icing/anti-icing equipment itself or other elevated equipment) to ensure that the aircraft is free from frost, ice, snow, or slush.

- (p) 'Pre-take-off check': The flight crew should continuously monitor the weather conditions after the de-icing/anti-icing treatment to assess whether the applied holdover time is still appropriate. Within the aircraft's HOT and prior to take-off, the flight crew should check the aircraft's wings or representative aircraft surfaces for frozen contaminants.
- (q) 'Pre-take-off contamination check': a check of the treated surfaces for contamination, performed when the HOT has been exceeded or if any doubt exists regarding the continued effectiveness of the applied anti-icing treatment. It is normally accomplished externally, just before commencement of the take-off run.

ANTI-ICING CODES

- (r) Upon completion of the anti-icing treatment, a qualified staff provides the anti-icing code to the flight crew as follows: 'the fluid Type/the fluid name (except for Type I)/concentration (except for Type I)/local time at start of anti-icing/date (optional)/the statement 'post- de-icing/anti-icing check completed' (if check completed). Example:

'TYPE II / MANUFACTURER, BRAND X / 75% / 1335 / 15FEB20 / POST- DE-ICING/ANTI-ICING CHECK COMPLETED'.
- (s) When a two-step de-icing/anti-icing operation has been carried out, the anti-icing code should be determined by the second step fluid.

GM2 SPO.OP.175 Ice and other contaminants – ground procedures

ED Decision 2021/005/R

DE-ICING/ANTI-ICING — PROCEDURES

- (a) De-icing and/or anti-icing procedures should take into account manufacturer's recommendations, including those that are type-specific, and should cover:
 - (1) contamination checks, including detection of clear ice and under-wing frost; limits on the thickness/area of contamination published in the AFM or other manufacturers' documentation should be followed;
 - (2) procedures to be followed if de-icing and/or anti-icing procedures are interrupted or unsuccessful;
 - (3) post-treatment checks;
 - (4) pre-take-off checks;
 - (5) pre-take-off contamination checks;
 - (6) the recording of any incidents relating to de-icing and/or anti-icing; and
 - (7) the responsibilities of all personnel involved in de-icing and/or anti-icing.
- (b) Operator's procedures should ensure the following:
 - (1) When aircraft surfaces are contaminated by ice, frost, slush or snow, they are de-iced prior to take-off according to the prevailing conditions. Removal of contaminants may be performed with mechanical tools, fluids (including hot water), infrared heat or forced air, taking account of aircraft type-specific provisions.

- (2) Account is taken of the wing skin temperature versus OAT, as this may affect:
 - (i) the need to carry out aircraft de-icing and/or anti-icing; and/or
 - (ii) the performance of the de-icing/anti-icing fluids.
- (3) When freezing precipitation occurs or there is a risk of freezing precipitation occurring that would contaminate the surfaces at the time of take-off, aircraft surfaces should be anti-iced. Anti-icing fluids (neat or diluted) should not be applied at OAT below their LOU_T. If both de-icing and anti-icing are required, the procedure may be performed in a one- or two-step process, depending upon weather conditions, available equipment, available fluids and the desired HOT. One-step de-icing/anti-icing means that de-icing and anti-icing are carried out at the same time, using a mixture of de-icing/anti-icing fluid and water. Two-step de-icing/anti-icing means that de-icing and anti-icing are carried out in two separate steps. The aircraft is first de-iced using heated water only or a heated mixture of de-icing/anti-icing fluid and water. After completion of the de-icing operation, a layer of a mixture of de-icing/anti-icing fluid and water, or of de-icing /anti-icing fluid only, is sprayed over the aircraft surfaces. The second step will be taken before the first step fluid freezes (typically within 3 minutes but severe conditions may shorten this) and, if necessary, area by area.
- (4) When an aircraft is anti-iced and a longer HOT is needed/desired, the use of a less diluted thickened fluid may be considered.
- (5) All restrictions relative to OAT and fluid application (including, but not necessarily limited to, temperature and pressure) published by the fluid manufacturer and/or aircraft manufacturer, are followed and procedures, limitations and recommendations to prevent the formation of fluid residues are followed.
- (6) During conditions conducive to aircraft icing on the ground or after de-icing and/or anti-icing, an aircraft is not dispatched for departure unless it has been given a contamination check or a post-treatment check by a trained and qualified person. This check should cover all treated surfaces of the aircraft and be performed from points offering sufficient visibility to these parts. To ensure that there is no clear ice on suspect areas, it may also be necessary to make a physical check (e.g. tactile).
- (7) The required entry is made in the technical log.
- (8) The commander continually monitors the environmental situation after the performed treatment. Prior to take-off, he/she performs a pre-take-off check, which is an assessment of whether the applied HOT is still appropriate. This pre-take-off check includes, but is not limited to, factors such as precipitation, wind and OAT.
- (9) If any doubt exists as to whether a deposit may adversely affect the aircraft's performance and/or controllability characteristics, the commander should arrange for a re-treatment or a pre-take-off contamination check to be performed in order to verify that the aircraft's surfaces are free of contamination. Special methods and/or equipment may be necessary to perform this check, especially at night time or in extremely adverse weather conditions. If this check cannot be performed just before take-off, re-treatment should be applied.
- (10) When re-treatment is necessary, any residue of the previous treatment should be removed, and a completely new de-icing/anti-icing treatment should be applied.

-
- (11) When a ground ice detection system (GIDS) is used to perform an aircraft surfaces check prior to and/or after a treatment, the use of GIDS by suitably trained personnel should be part of the procedure.
- (c) Special operational considerations
- (1) When using thickened de-icing/anti-icing fluids, the operator should consider a two-step deicing/anti-icing procedure, the first step preferably with hot water and/or un-thickened fluids.
 - (2) The use of de-icing/anti-icing fluids should be in accordance with the aircraft manufacturer's documentation. This is particularly important for thickened fluids to assure sufficient flow-off during take-off. Avoid applying excessive thickened fluid on the horizontal tail of aircraft with unpowered elevator controls.
 - (3) The operator should comply with any type-specific operational provision(s), such as an aircraft mass decrease and/or a take-off speed increase associated with a fluid application.
 - (4) The operator should take into account any flight handling procedures (stick force, rotation speed and rate, take-off speed, aircraft attitude etc.) laid down by the aircraft manufacturer when associated with a fluid application.
 - (5) The limitations or handling procedures resulting from (c)(3) and/or (c)(4) above should be part of the flight crew pre take-off briefing.
- (d) Communications
- (1) Before aircraft treatment. When the aircraft is to be treated with the flight crew on board, the flight and personnel involved in the operation should confirm the fluid to be used, the extent of treatment required and any aircraft type-specific procedure(s) to be used. Any other information needed to apply the HOT tables should be exchanged.
 - (2) Anti-icing code. The operator's procedures should include an anti-icing code, which indicates the treatment the aircraft has received. This code provides the flight crew with the minimum details necessary to estimate a HOT and confirms that the aircraft is free of contamination.
 - (3) After treatment. Before reconfiguring or moving the aircraft, the flight crew should receive a confirmation from the qualified personnel involved in the operation that all de-icing and/or anti-icing operations are complete and that all personnel and equipment are clear of the aircraft.
- (e) Holdover protection & LWE systems
- The operator should publish in the operations manual (OM), when required, the HOTs in the form of a table or a diagram, to account for the various types of ground icing conditions and the different types and concentrations of fluids used. However, the times of protection shown in these tables are to be used as guidelines only and are normally used in conjunction with the pre-take-off check.
- An operator may choose to operate using LWE systems instead of HOT tables whenever the required means for using these systems are in place.

(f) Training

The operator's initial and recurrent de-icing training programmes (including communication training) for flight crew and for other personnel involved in de-icing operations should include additional training if any of the following is introduced:

- (1) a new method, procedure and/or technique;
- (2) a new type of fluid and/or equipment; or
- (3) a new type of aircraft.

(g) Contracting

When the operator contracts de-icing/anti-icing functions, the operator should ensure that the contractor complies with the operator's training/qualification procedures, together with any specific procedures in respect of:

- (1) roles and responsibilities;
- (2) de-icing and/or anti-icing methods and procedures;
- (3) fluids to be used, including precautions for storage, preparation for use and chemical incompatibilities;
- (4) specific aircraft provisions (e.g. no-spray areas, propeller/engine de-icing, APU operation etc.);
- (5) different checks to be conducted; and
- (6) procedures for communications with flight crew and any other third party involved.

(h) Special maintenance considerations

(1) General

The operator should take proper account of the possible side-effects of fluid use. Such effects may include, but are not necessarily limited to, dried and/or re-hydrated residues, corrosion and the removal of lubricants.

(2) Special considerations regarding residues of dried fluids

The operator should establish procedures to prevent or detect and remove residues of dried fluid. If necessary, the operator should establish appropriate inspection intervals based on the recommendations of the airframe manufacturers and/or the operator's own experience:

(i) Dried fluid residues

Dried fluid residues could occur when surfaces have been treated and the aircraft has not subsequently been flown and has not been subject to precipitation. The fluid may then have dried on the surfaces.

(ii) Re-hydrated fluid residues

Repetitive application of thickened de-icing/anti-icing fluids may lead to the subsequent formation/build-up of a dried residue in aerodynamically quiet areas, such as cavities and gaps. This residue may re-hydrate if exposed to high humidity conditions, precipitation, washing, etc., and increase to many times its original size/volume. This residue will freeze if exposed to conditions at or below 0 °C. This may cause moving parts, such as elevators, ailerons, and flap actuating mechanisms to stiffen or jam in-flight. Re-hydrated residues may also form on

exterior surfaces, which can reduce lift, increase drag and stall speed. Re-hydrated residues may also collect inside control surface structures and cause clogging of drain holes or imbalances to flight controls. Residues may also collect in hidden areas, such as around flight control hinges, pulleys, grommets, on cables and in gaps.

- (iii) Operators are strongly recommended to obtain information about the fluid dry-out and re-hydration characteristics from the fluid manufacturers and to select products with optimised characteristics.
- (iv) Additional information should be obtained from fluid manufacturers for handling, storage, application and testing of their products.

GM3 SPO.OP.175 Ice and other contaminants – ground procedures

ED Decision 2021/005/R

DE-ICING/ANTI-ICING — BACKGROUND INFORMATION

Further guidance material on this issue is given in the ICAO Manual of Aircraft Ground De-icing/Anti-icing Operations (Doc 9640).

(a) General

- (1) Any deposit of frost, ice, snow or slush on the external surfaces of an aircraft may drastically affect its flying qualities because of reduced aerodynamic lift, increased drag, modified stability and control characteristics. Furthermore, freezing deposits may cause moving parts, such as elevators, ailerons, flap actuating mechanism, etc., to jam and create a potentially hazardous condition. Propeller/engine/APU/systems performance may deteriorate due to the presence of frozen contaminants on blades, intakes and components. Also, engine operation may be seriously affected by the ingestion of snow or ice, thereby causing engine stall or compressor damage. In addition, ice/frost may form on certain external surfaces (e.g. wing upper and lower surfaces, etc.) due to the effects of cold fuel/structures, even in ambient temperatures well above 0°C.
- (2) Procedures established by the operator for de-icing and/or anti-icing are intended to ensure that the aircraft is clear of contamination so that degradation of aerodynamic characteristics or mechanical interference will not occur and, following anti-icing, to maintain the airframe in that condition during the appropriate HOT.
- (3) Under certain meteorological conditions, de-icing and/or anti-icing procedures may be ineffective in providing sufficient protection for continued operations. Examples of these conditions are freezing rain, ice pellets and hail snow exceeding certain intensities, high wind velocity, and fast-dropping OAT. No HOT guidelines exist for these conditions.
- (4) Material for establishing operational procedures can be found, for example, in:
 - (i) ICAO Annex 3 'Meteorological Service for International Air Navigation';
 - (ii) ICAO 'Manual of Aircraft Ground De-icing/Anti-icing Operations';
 - (iii) SAE AS6285 'Aircraft Ground Deicing/Anti-Icing Processes';
 - (iv) SAE AS6286 'Aircraft Ground Deicing/Anti-Icing Training and Qualification Program';
 - (v) SAE AS6332 'Aircraft Ground Deicing/Anti-icing Quality Management';

-
- (vi) SAE ARP6257 'Aircraft Ground De/Anti-Icing Communication Phraseology for Flight and Ground Crews';
 - (vii) FAA Holdover Time Guidelines
 - (viii) FAA 8900.xxx series Notice 'Revised FAA-Approved Deicing Program Updates, Winter 20xx-20yy'.
- (b) Fluids
- (1) Type I fluid: Due to its properties, Type I fluid forms a thin, liquid-wetting film on surfaces to which it is applied which, under certain weather conditions, gives a very limited HOT. For anti-icing purposes the fluid/water mixture should have a freezing point of at least 10 °C below OAT; increasing the concentration of fluid in the fluid/water mix does not provide any extension in HOT.
 - (2) Type II and Type IV fluids contain thickeners which enable the fluid to form a thicker liquid-wetting film on surfaces to which it is applied. Generally, this fluid provides a longer HOT than Type I fluids in similar conditions.
 - (3) Type III fluid is a thickened fluid especially intended for use on aircraft with low rotation speeds.
 - (4) Fluids used for de-icing and/or anti-icing should be acceptable to the operator and the aircraft manufacturer. These fluids normally conform to specifications such as SAE AMS1424 (Type I) or SAE AMS1428 (Types II, III and IV). Use of non-conforming fluids is not recommended due to their characteristics being unknown. The anti-icing and aerodynamic properties of thickened fluids may be seriously degraded by, for example, inappropriate storage, treatment, application, application equipment, age and in case they are applied on top of non-chemically compatible de-icing fluids.
- (c) Holdover protection
- (1) Holdover protection is achieved by a layer of anti-icing fluid remaining on and protecting aircraft surfaces for a period of time. With a one-step de-icing/anti-icing procedure, the HOT begins at the commencement of de-icing/anti-icing. With a two-step procedure, the HOT begins at the commencement of the second (anti-icing) step. The holdover protection runs out:
 - (i) at the commencement of the take-off roll (due to aerodynamic shedding of fluid);
or
 - (ii) when frozen deposits start to form or accumulate on treated aircraft surfaces, thereby indicating the loss of effectiveness of the fluid.
 - (2) The duration of holdover protection may vary depending on the influence of factors other than those specified in the HOT tables. Guidance should be provided by the operator to take account of such factors, which may include:
 - (i) atmospheric conditions, e.g. exact type and rate of precipitation, wind direction and velocity, relative humidity and solar radiation; and
 - (ii) the aircraft and its surroundings, such as aircraft component inclination angle, contour and surface roughness, surface temperature, operation in close proximity to other aircraft (jet or propeller blast) and ground equipment and structures.

- (3) HOTs are not meant to imply that flight is safe in the prevailing conditions if the specified HOT has not been exceeded. Certain meteorological conditions, such as freezing drizzle or freezing rain, may be beyond the certification envelope of the aircraft.

SPO.OP.176 Ice and other contaminants – flight procedures

Regulation (EU) No 379/2014

- (a) The pilot-in-command shall only commence a flight or intentionally fly into expected or actual icing conditions if the aircraft is certified and equipped to cope with such conditions as referred to in 2.a.5 of Annex IV to Regulation (EC) No 216/2008.
- (b) If icing exceeds the intensity of icing for which the aircraft is certified or if an aircraft not certified for flight in known icing conditions encounters icing, the pilot-in-command shall exit the icing conditions without delay, by a change of level and/or route, and if necessary by declaring an emergency to ATC.
- (c) In the case of operations with complex motor-powered aircraft, the operator shall establish procedures for flights in expected or actual icing conditions.

AMC1 SPO.OP.176 Ice and other contaminants – flight procedures

ED Decision 2014/018/R

FLIGHT IN EXPECTED OR ACTUAL ICING CONDITIONS

- (a) The procedures to be established by the operator should take account of the design, the equipment, the configuration of the aircraft and the necessary training. For these reasons, different aircraft types operated by the same company may require the development of different procedures. In every case, the relevant limitations are those that are defined in the AFM and other documents produced by the manufacturer.
- (b) The operator should ensure that the procedures take account of the following:
- (1) the equipment and instruments that should be serviceable for flight in icing conditions;
 - (2) the limitations on flight in icing conditions for each phase of flight. These limitations may be imposed by the aircraft's de-icing or anti-icing equipment or the necessary performance corrections that have to be made;
 - (3) the criteria the flight crew should use to assess the effect of icing on the performance and/or controllability of the aircraft;
 - (4) the means by which the flight crew detects, by visual cues or the use of the aircraft's ice detection system, that the flight is entering icing conditions; and
 - (5) the action to be taken by the flight crew in a deteriorating situation (which may develop rapidly) resulting in an adverse effect on the performance and/or controllability of the aircraft, due to:
 - (i) the failure of the aircraft's anti-icing or de-icing equipment to control a build-up of ice; and/or
 - (ii) ice build-up on unprotected areas.
- (c) Training for dispatch and flight in expected or actual icing conditions. The content of the operations manual should reflect the training, both conversion and recurrent, that flight crew and all other relevant operational personnel require in order to comply with the procedures for dispatch and flight in icing conditions:

- (1) instruction on how to recognise, from weather reports or forecasts that are available before flight commences or during flight, the risks of encountering icing conditions along the planned route and on how to modify, as necessary, the departure and in-flight routes or profiles;
- (2) instruction on the operational and performance limitations or margins;
- (3) the use of in-flight ice detection, anti-icing and de-icing systems in both normal and abnormal operation; and
- (4) instruction on the differing intensities and forms of ice accretion and the consequent action which should be taken.

SPO.OP.180 Take-off conditions — aeroplanes and helicopters

Regulation (EU) 2021/2237

Before commencing take-off, the pilot-in-command shall be satisfied that:

- (a) the meteorological conditions at the aerodrome or the operating site and the condition of the runway/FATO intended to be used will not prevent a safe take-off and departure; and
- (b) the selected aerodrome operating minima are consistent with all of the following:
 - (1) the operative ground equipment;
 - (2) the operative aircraft systems;
 - (3) the aircraft performance;
 - (4) flight crew qualifications.

SPO.OP.185 Simulated situations in flight

Regulation (EU) No 379/2014

Unless a task specialist is on-board the aircraft for training, the pilot-in-command shall, when carrying task specialists, not simulate:

- (a) situations that require the application of abnormal or emergency procedures; or
- (b) flight in instrument meteorological conditions (IMC).

SPO.OP.190 Fuel/energy scheme — in-flight fuel/energy management policy

Regulation (EU) 2021/1296

- (a) The operator of complex motor-powered aircraft shall establish procedures to ensure that in-flight fuel/energy checks and fuel/energy management are performed.
- (b) The pilot-in-command shall monitor the amount of usable fuel/energy remaining on board to ensure that it is protected and not less than the fuel/energy that is required to proceed to an aerodrome or operating site where a safe landing can be made.
- (c) The pilot-in-command shall advise air traffic control (ATC) of a 'minimum fuel/energy' state by declaring 'MINIMUM FUEL' when the pilot-in-command has:
 - (1) committed to land at a specific aerodrome or operating site; and

- (2) calculated that any change to the existing clearance to that aerodrome or operating site, or other air traffic delays, may result in landing with less than the planned final reserve fuel/energy.
- (d) The pilot-in-command shall declare a situation of ‘fuel/energy emergency’ by broadcasting ‘MAYDAY MAYDAY MAYDAY FUEL’ when the usable fuel/energy estimated to be available upon landing at the nearest aerodrome or operating site where a safe landing can be made is less than the planned final reserve fuel/energy.

GM1 SPO.OP.190(b)&(d) Fuel/energy scheme — in-flight fuel/energy management policy

ED Decision 2022/005/R

FINAL RESERVE FUEL PROTECTION

To ensure a safe landing, the pilot needs to protect the final reserve fuel (FRF) in accordance with point [SPO.OP.131](#). The objective of the FRF protection is to ensure that a safe landing is made at any aerodrome or operating site when unforeseen circumstances may not allow to safely complete the flight, as originally planned.

When the FRF can no longer be protected, then a fuel emergency needs to be declared, as per point [SPO.OP.190\(d\)](#), and any landing option explored (e.g. for aeroplanes, aerodromes not assessed by the operator, military aerodromes, closed runways), including deviating from rules, operational procedures, and methods in the interest of safety (as per point [CAT.GEN.MPA.105\(b\)](#)).

ICAO Doc 9976 Flight Planning and Fuel Management (FPFM) Manual and the EASA Fuel Manual contain further detailed guidance on the development of a comprehensive in-flight fuel management policy and related procedures.

GM1 SPO.OP.190(c) Fuel/energy scheme — in-flight fuel/energy management policy

ED Decision 2022/005/R

‘MINIMUM FUEL’ DECLARATION

The ‘MINIMUM FUEL’ declaration informs the ATC that all planned landing options have been reduced to a specific aerodrome or operating site of intended landing, and for helicopters, that no other landing site is available. It also informs the ATC that any change to the existing clearance may result in landing with less than the planned FRF/energy. This is not an emergency situation but an indication that an emergency situation is possible, should any additional delay occur.

The pilot should not expect any form of priority handling as a result of a ‘MINIMUM FUEL’ declaration. However, the ATC should advise the flight crew of any additional expected delays, as well as coordinate with other ATC units when transferring the control of the aircraft, to ensure that the other ATC units are aware of the flight’s fuel/energy state.

ICAO Doc 9976 Flight Planning and Fuel Management (FPFM) Manual (1st Edition, 2015) and the EASA Fuel Manual contain guidance on declaring ‘MINIMUM FUEL’.

SPO.OP.195 Use of supplemental oxygen

Regulation (EU) No 379/2014

- (a) The operator shall ensure that task specialists and crew members use supplemental oxygen continuously whenever the cabin altitude exceeds 10 000 ft for a period of more than 30

minutes and whenever the cabin altitude exceeds 13 000 ft, unless otherwise approved by the competent authority and in accordance with SOPs.

- (b) Notwithstanding (a) and except for parachute operations, short excursions of a specified duration above 13 000 ft without using supplemental oxygen on other-than complex aeroplanes and helicopters may be undertaken with a prior approval of the competent authority based on the consideration of the following:
- (1) the duration of the excursion above 13 000 ft is not more than 10 minutes or, if needed for a longer period, the time strictly necessary to the accomplishment of the specialised task;
 - (2) the flight is not conducted above 16 000 ft;
 - (3) the safety briefing in accordance with [SPO.OP.135](#) includes adequate information to crew members and tasks specialists on the effects of hypoxia;
 - (4) SOPs for the concerned operation reflecting (1), (2) and (3);
 - (5) the previous experience of the operator in conducting operations above 13 000 ft without using supplemental oxygen;
 - (6) the individual experience of crew members and task specialists and their physiological adaptation to high altitudes; and
 - (7) the altitude of the base where the operator is established or the operations are conducted from.

SPO.OP.200 Ground proximity detection

Regulation (EU) No 379/2014

- (a) When undue proximity to the ground is detected by a flight crew member or by a ground proximity warning system, the pilot flying shall take corrective action immediately in order to establish safe flight conditions.
- (b) The ground proximity warning system may be disabled during those specialised tasks, which by their nature require the aircraft to be operated within a distance from the ground below that which would trigger the ground proximity warning system.

GM1 SPO.OP.200 Ground proximity detection

ED Decision 2014/018/R

GUIDANCE MATERIAL FOR TERRAIN AWARENESS WARNING SYSTEM (TAWS) FLIGHT CREW TRAINING PROGRAMMES

- (a) Introduction
- (1) This GM contains performance-based training objectives for TAWS flight crew training.
 - (2) The training objectives cover five areas: theory of operation; pre-flight operations; general in-flight operations; response to TAWS cautions; response to TAWS warnings.
 - (3) The term 'TAWS' in this GM means a ground proximity warning system (GPWS) enhanced by a forward-looking terrain avoidance function. Alerts include both cautions and warnings.
 - (4) The content of this GM is intended to assist operators who are producing training programmes. The information it contains has not been tailored to any specific aircraft or

TAWS equipment, but highlights features that are typically available where such systems are installed. It is the responsibility of the individual operator to determine the applicability of the content of this Guidance Material to each aircraft and TAWS equipment installed and their operation. Operators should refer to the AFM and/or aircraft/flight crew operating manual (A/FCOM), or similar documents, for information applicable to specific configurations. If there should be any conflict between the content of this Guidance Material and that published in the other documents described above, then the information contained in the AFM or A/FCOM will take precedence.

(b) Scope

- (1) The scope of this GM is designed to identify training objectives in the areas of: academic training; manoeuvre training; initial evaluation; recurrent qualification. Under each of these four areas, the training material has been separated into those items that are considered essential training items and those that are considered to be desirable. In each area, objectives and acceptable performance criteria are defined.
- (2) No attempt is made to define how the training programme should be implemented. Instead, objectives are established to define the knowledge that a pilot operating a TAWS is expected to possess and the performance expected from a pilot who has completed TAWS training. However, the guidelines do indicate those areas in which the pilot receiving the training should demonstrate his/her understanding, or performance, using a real-time, interactive training device, i.e. a flight simulator. Where appropriate, notes are included within the performance criteria that amplify or clarify the material addressed by the training objective.

(c) Performance-based training objectives

- (1) TAWS academic training
 - (i) This training is typically conducted in a classroom environment. The knowledge demonstrations specified in this section may be completed through the successful completion of written tests or by providing correct responses to non-real-time computer-based training (CBT) questions.
 - (ii) Theory of operation. The pilot should demonstrate an understanding of TAWS operation and the criteria used for issuing cautions and warnings. This training should address system operation. Objective: to demonstrate knowledge of how a TAWS functions. Criteria: the pilot should demonstrate an understanding of the following functions:
 - (A) Surveillance
 - (a) The GPWS computer processes data supplied from an air data computer, a radio altimeter, an instrument landing system (ILS)/microwave landing system (MLS)/multi-mode (MM) receiver, a roll attitude sensor, and actual position of the surfaces and of the landing gear.
 - (b) The forward-looking terrain avoidance function utilises an accurate source of known aircraft position, such as that which may be provided by a flight management system (FMS) or global positioning system (GPS), or an electronic terrain database. The source and scope of the terrain, obstacle and airport data, and features such as the terrain clearance floor, the runway picker, and geometric altitude (where provided), should all be described.

- (c) Displays required to deliver TAWS outputs include a loudspeaker for voice announcements, visual alerts (typically amber and red lights) and a terrain awareness display (that may be combined with other displays). In addition, means should be provided for indicating the status of the TAWS and any partial or total failures that may occur.
- (B) Terrain avoidance. Outputs from the TAWS computer provide visual and audio synthetic voice cautions and warnings to alert the flight crew about potential conflicts with terrain and obstacles.
- (C) Alert thresholds. Objective: to demonstrate knowledge of the criteria for issuing cautions and warnings. Criteria: the pilot should be able to demonstrate an understanding of the methodology used by a TAWS to issue cautions and alerts and the general criteria for the issuance of these alerts, including:
 - (a) basic GPWS alerting modes specified in the ICAO standard:
 - Mode 1: excessive sink rate;
 - Mode 2: excessive terrain closure rate;
 - Mode 3: descent after take-off or missed approach;
 - Mode 4: unsafe proximity to terrain; and
 - Mode 5: descent below ILS glide slope (caution only);
 - (b) an additional, optional alert mode:
Mode 6: radio altitude call-out (information only); and
 - (c) TAWS cautions and warnings that alert the flight crew to obstacles and terrain ahead of the aircraft in line with or adjacent to its projected flight path (forward-looking terrain avoidance (FLTA) and premature descent alert (PDA) functions).
- (D) TAWS limitations. Objective: to verify that the pilot is aware of the limitations of TAWS. Criteria: the pilot should demonstrate knowledge and an understanding of TAWS limitations identified by the manufacturer for the equipment model installed, such as:
 - (a) navigation should not be predicated on the use of the terrain display;
 - (b) unless geometric altitude data is provided, use of predictive TAWS functions is prohibited when altimeter subscale settings display 'QFE' (atmospheric pressure at aerodrome elevation/runway threshold);
 - (c) nuisance alerts can be issued if the aerodrome of intended landing is not included in the TAWS airport database;
 - (d) in cold weather operations, corrective procedures should be implemented by the pilot unless the TAWS has in-built compensation, such as geometric altitude data;
 - (e) loss of input data to the TAWS computer could result in partial or total loss of functionality. Where means exist to inform the flight crew that functionality has been degraded, this should be known and the consequences understood;

- (f) radio signals not associated with the intended flight profile (e.g. ILS glide path transmissions from an adjacent runway) may cause false alerts;
 - (g) inaccurate or low accuracy aircraft position data could lead to false or non-annunciation of terrain or obstacles ahead of the aircraft; and
 - (h) minimum equipment list (MEL) restrictions should be applied in the event of the TAWS becoming partially or completely unserviceable. (It should be noted that basic GPWS has no forward-looking capability.)
 - (E) TAWS inhibits. Objective: to verify that the pilot is aware of the conditions under which certain functions of a TAWS are inhibited. Criteria: the pilot should demonstrate knowledge and an understanding of the various TAWS inhibits, including the following means of:
 - (a) silencing voice alerts;
 - (b) inhibiting ILS glide path signals (as may be required when executing an ILS back beam approach);
 - (c) inhibiting flap position sensors (as may be required when executing an approach with the flaps not in a normal position for landing);
 - (d) inhibiting the FLTA and PDA functions; and
 - (e) selecting or deselecting the display of terrain information, together with appropriate annunciation of the status of each selection.
- (2) Operating procedures. The pilot should demonstrate the knowledge required to operate TAWS avionics and to interpret the information presented by a TAWS. This training should address the following topics:
 - (i) Use of controls. Objective: to verify that the pilot can properly operate all TAWS controls and inhibits. Criteria: the pilot should demonstrate the proper use of controls, including the following means by which:
 - (A) before flight, any equipment self-test functions can be initiated;
 - (B) TAWS information can be selected for display; and
 - (C) all TAWS inhibits can be operated and what the consequent annunciations mean with regard to loss of functionality.
 - (ii) Display interpretation. Objective: to verify that the pilot understands the meaning of all information that can be annunciated or displayed by a TAWS. Criteria: the pilot should demonstrate the ability to properly interpret information annunciated or displayed by a TAWS, including the following:
 - (A) knowledge of all visual and aural indications that may be seen or heard;
 - (B) response required on receipt of a caution;
 - (C) response required on receipt of a warning; and
 - (D) response required on receipt of a notification that partial or total failure of the TAWS has occurred (including annunciation that the present aircraft position is of low accuracy).
 - (iii) Use of basic GPWS or use of the FLTA function only. Objective: to verify that the pilot understands what functionality will remain following loss of the GPWS or of

- the FLTA function. Criteria: the pilot should demonstrate knowledge of how to recognise the following:
- (A) un-commanded loss of the GPWS function, or how to isolate this function and how to recognise the level of the remaining controlled flight into terrain (CFIT) protection (essentially, this is the FLTA function); and
 - (B) un-commanded loss of the FLTA function, or how to isolate this function and how to recognise the level of the remaining CFIT protection (essentially, this is the basic GPWS).
- (iv) Crew coordination. Objective: to verify that the pilot adequately briefs other flight crew members on how TAWS alerts will be handled. Criteria: the pilot should demonstrate that the pre-flight briefing addresses procedures that will be used in preparation for responding to TAWS cautions and warnings, including the following:
- (A) the action to be taken, and by whom, in the event that a TAWS caution and/or warning is issued; and
 - (B) how multi-function displays will be used to depict TAWS information at take-off, in the cruise and for the descent, approach, landing (and any missed approach). This will be in accordance with procedures specified by the operator, who will recognise that it may be more desirable that other data is displayed at certain phases of flight and that the terrain display has an automatic 'pop-up' mode in the event that an alert is issued.
- (v) Reporting rules. Objective: to verify that the pilot is aware of the rules for reporting alerts to the controller and other authorities. Criteria: the pilot should demonstrate knowledge of the following:
- (A) when, following recovery from a TAWS alert or caution, a transmission of information should be made to the appropriate ATC unit; and
 - (B) the type of written report that is required, how it is to be compiled and whether any cross-reference should be made in the aircraft technical log and/or voyage report (in accordance with procedures specified by the operator), following a flight in which the aircraft flight path has been modified in response to a TAWS alert, or if any part of the equipment appears not to have functioned correctly.
- (vi) Alert thresholds. Objective: to demonstrate knowledge of the criteria for issuing cautions and warnings. Criteria: the pilot should be able to demonstrate an understanding of the methodology used by a TAWS to issue cautions and warnings and the general criteria for the issuance of these alerts, including awareness of the following:
- (A) modes associated with basic GPWS, including the input data associated with each; and
 - (B) visual and aural annunciations that can be issued by TAWS and how to identify which are cautions and which are warnings.
- (3) TAWS manoeuvre training. The pilot should demonstrate the knowledge required to respond correctly to TAWS cautions and warnings. This training should address the following topics:

- (i) Response to cautions:
 - (A) Objective: to verify that the pilot properly interprets and responds to cautions. Criteria: the pilot should demonstrate an understanding of the need, without delay:
 - (a) to initiate action required to correct the condition that has caused the TAWS to issue the caution and to be prepared to respond to a warning, if this should follow; and
 - (b) if a warning does not follow the caution, to notify the controller of the new position, heading and/or altitude/flight level of the aircraft, and what the pilot-in-command intends to do next.
 - (B) The correct response to a caution might require the pilot to:
 - (a) reduce a rate of descent and/or to initiate a climb;
 - (b) regain an ILS glide path from below, or to inhibit a glide path signal if an ILS is not being flown;
 - (c) select more flap, or to inhibit a flap sensor if the landing is being conducted with the intent that the normal flap setting will not be used;
 - (d) select gear down; and/or
 - (e) initiate a turn away from the terrain or obstacle ahead and towards an area free of such obstructions if a forward-looking terrain display indicates that this would be a good solution and the entire manoeuvre can be carried out in clear visual conditions.
- (ii) Response to warnings. Objective: to verify that the pilot properly interprets and responds to warnings. Criteria: the pilot should demonstrate an understanding of the following:
 - (A) The need, without delay, to initiate a climb in the manner specified by the operator.
 - (B) The need, without delay, to maintain the climb until visual verification can be made that the aircraft will clear the terrain or obstacle ahead or until above the appropriate sector safe altitude (if certain about the location of the aircraft with respect to terrain) even if the TAWS warning stops. If, subsequently, the aircraft climbs up through the sector safe altitude, but the visibility does not allow the flight crew to confirm that the terrain hazard has ended, checks should be made to verify the location of the aircraft and to confirm that the altimeter subscale settings are correct.
 - (C) When workload permits that, the flight crew should notify the air traffic controller of the new position and altitude/flight level and what the pilot-in-command intends to do next.
 - (D) That the manner in which the climb is made should reflect the type of aircraft and the method specified by the aircraft manufacturer (which should be reflected in the operations manual) for performing the escape manoeuvre. Essential aspects will include the need for an increase in pitch attitude, selection of maximum thrust, confirmation that external sources of drag

- (e.g. spoilers/speed brakes) are retracted and respect of the stick shaker or other indication of eroded stall margin.
- (E) That TAWS warnings should never be ignored. However, the pilot's response may be limited to that which is appropriate for a caution, only if:
- (a) the aircraft is being operated by day in clear, visual conditions; and
 - (b) it is immediately clear to the pilot that the aircraft is in no danger in respect of its configuration, proximity to terrain or current flight path.
- (4) TAWS initial evaluation:
- (i) The flight crew member's understanding of the academic training items should be assessed by means of a written test.
 - (ii) The flight crew member's understanding of the manoeuvre training items should be assessed in a flight simulation training device (FSTD) equipped with TAWS visual and aural displays and inhibit selectors similar in appearance and operation to those in the aircraft that the pilot will fly. The results should be assessed by a flight simulation training instructor, synthetic flight examiner, type rating instructor or type rating examiner.
 - (iii) The range of scenarios should be designed to give confidence that proper and timely responses to TAWS cautions and warnings will result in the aircraft avoiding a CFIT accident. To achieve this objective, the pilot should demonstrate taking the correct action to prevent a caution developing into a warning and, separately, the escape manoeuvre needed in response to a warning. These demonstrations should take place when the external visibility is zero, though there is much to be learnt if, initially, the training is given in 'mountainous' or 'hilly' terrain with clear visibility. This training should comprise a sequence of scenarios, rather than be included in line orientated flight training (LOFT).
 - (iv) A record should be made, after the pilot has demonstrated competence, of the scenarios that were practised.
- (5) TAWS recurrent training:
- (i) TAWS recurrent training ensures that pilots maintain the appropriate TAWS knowledge and skills. In particular, it reminds pilots of the need to act promptly in response to cautions and warnings and of the unusual attitude associated with flying the escape manoeuvre.
 - (ii) An essential item of recurrent training is the discussion of any significant issues and operational concerns that have been identified by the operator. Recurrent training should also address changes to TAWS logic, parameters or procedures and to any unique TAWS characteristics of which pilots should be aware.
- (6) Reporting procedures:
- (i) Verbal reports. Verbal reports should be made promptly to the appropriate ATC unit:
 - (A) whenever any manoeuvre has caused the aircraft to deviate from an air traffic clearance;

- (B) when, following a manoeuvre that has caused the aircraft to deviate from an air traffic clearance, the aircraft has returned to a flight path that complies with the clearance; and/or
 - (C) when an air traffic control unit issues instructions that, if followed, would cause the pilot to manoeuvre the aircraft towards terrain or obstacle or it would appear from the display that a potential CFIT occurrence is likely to result.
- (ii) Written reports. Written reports should be submitted in accordance with the operator's occurrence reporting scheme and they should also be recorded in the aircraft technical log:
- (A) whenever the aircraft flight path has been modified in response to a TAWS alert (false, nuisance or genuine);
 - (B) whenever a TAWS alert has been issued and is believed to have been false; and/or
 - (C) if it is believed that a TAWS alert should have been issued, but was not.
- (iii) Within this GM, and with regard to reports:
- (A) the term 'false' means that the TAWS issued an alert that could not possibly be justified by the position of the aircraft in respect to terrain and it is probable that a fault or failure in the system (equipment and/or input data) was the cause;
 - (B) the term 'nuisance' means that the TAWS issued an alert that was appropriate, but was not needed because the flight crew could determine by independent means that the flight path was, at that time, safe;
 - (C) the term 'genuine' means that the TAWS issued an alert that was both appropriate and necessary;
 - (D) the report terms described above are only meant to be assessed after the occurrence is over, to facilitate subsequent analysis, the adequacy of the equipment and the programmes it contains. The intention is not for the flight crew to attempt to classify an alert into any of these three categories when visual and/or aural cautions or warnings are annunciated.

SPO.OP.205 Airborne collision avoidance system (ACAS)

Regulation (EU) 2016/1199

- (a) The operator shall establish operational procedures and training programmes when ACAS is installed and serviceable so that the flight crew is appropriately trained in the avoidance of collisions and competent in the use of ACAS II equipment.
- (b) The ACAS II may be disabled during those specialised tasks, which by their nature require the aircraft to be operated within a distance from each other below that which would trigger the ACAS.

GM1 SPO.OP.205 Airborne collision avoidance system (ACAS)

ED Decision 2019/019/R

GENERAL

- (a) The ACAS operational procedures and training programmes established by the operator should take into account this Guidance Material. It incorporates advice contained in:
 - (1) ICAO Annex 10, Volume IV;
 - (2) ICAO Doc 8168 (PANS-OPS), Volume III; and
 - (3) ICAO PANS-ATM.
- (b) Additional guidance material on ACAS may be referred to, including information available from such sources as EUROCONTROL.

ACAS FLIGHT CREW TRAINING

- (c) During the implementation of ACAS, several operational issues were identified that had been attributed to deficiencies in flight crew training programmes. As a result, the issue of flight crew training has been discussed within the ICAO, which has developed guidelines for operators to use when designing training programmes.
- (d) This Guidance Material contains performance-based training objectives for ACAS II flight crew training. Information contained here related to traffic advisories (TAs) is also applicable to ACAS I and ACAS II users. The training objectives cover five areas: theory of operation; pre-flight operations; general in-flight operations; response to TAs; and response to resolution advisories (RAs).
- (e) The information provided is valid for version 7 and 7.1 (ACAS II). Where differences arise, these are identified.
- (f) The performance-based training objectives are further divided into the areas of: academic training; manoeuvre training; initial evaluation and recurrent qualification. Under each of these four areas, the training material has been separated into those items which are considered essential training items and those which are considered desirable. In each area, objectives and acceptable performance criteria are defined.
- (g) ACAS academic training
 - (1) This training is typically conducted in a classroom environment. The knowledge demonstrations specified in this section may be completed through the successful completion of written tests or through providing correct responses to non-real-time computer-based training (CBT) questions.
 - (2) Essential items
 - (i) Theory of operation. The flight crew member should demonstrate an understanding of ACAS II operation and the criteria used for issuing TAs and RAs. This training should address the following topics:
 - (A) System operation
Objective: to demonstrate knowledge of how ACAS functions.
Criteria: the flight crew member should demonstrate an understanding of the following functions:
 - (a) Surveillance

- (1) ACAS interrogates other transponder-equipped aircraft within a nominal range of 14 NM.
 - (2) ACAS surveillance range can be reduced in geographic areas with a large number of ground interrogators and/or ACAS II-equipped aircraft.
 - (3) If the operator's ACAS implementation provides for the use of the Mode S extended squitter, the normal surveillance range may be increased beyond the nominal 14 NM. However, this information is not used for collision avoidance purposes.
- (b) Collision avoidance
- (1) TAs can be issued against any transponder-equipped aircraft that responds to the ICAO Mode C interrogations, even if the aircraft does not have altitude reporting capability.
 - (2) RAs can be issued only against aircraft that are reporting altitude and in the vertical plane only.
 - (3) RAs issued against an ACAS-equipped intruder are co-ordinated to ensure complementary RAs are issued.
 - (4) Failure to respond to an RA deprives own aircraft of the collision protection provided by own ACAS.
 - (5) Additionally, in ACAS-ACAS encounters, failure to respond to an RA also restricts the choices available to the other aircraft's ACAS and thus renders the other aircraft's ACAS less effective than if own aircraft were not ACAS equipped.
- (B) Advisory thresholds
- Objective: to demonstrate knowledge of the criteria for issuing TAs and RAs.
- Criteria: the flight crew member should demonstrate an understanding of the methodology used by ACAS to issue TAs and RAs and the general criteria for the issuance of these advisories, including the following:
- (a) ACAS advisories are based on time to closest point of approach (CPA) rather than distance. The time should be short and vertical separation should be small, or projected to be small, before an advisory can be issued. The separation standards provided by ATS are different from the miss distances against which ACAS issues alerts.
 - (b) Thresholds for issuing a TA or an RA vary with altitude. The thresholds are larger at higher altitudes.
 - (c) A TA occurs from 15 to 48 seconds and an RA from 15 to 35 seconds before the projected CPA.
 - (d) RAs are chosen to provide the desired vertical miss distance at CPA. As a result, RAs can instruct a climb or descent through the intruder aircraft's altitude.
- (C) ACAS limitations
- Objective: to verify that the flight crew member is aware of the limitations of ACAS.

Criteria: the flight crew member should demonstrate knowledge and understanding of ACAS limitations, including the following:

- (a) ACAS will neither track nor display non-transponder-equipped aircraft, nor aircraft not responding to ACAS Mode C interrogations.
 - (b) ACAS will automatically fail if the input from the aircraft's barometric altimeter, radio altimeter or transponder is lost.
 - (1) In some installations, the loss of information from other on-board systems such as an inertial reference system (IRS) or attitude heading reference system (AHRS) may result in an ACAS failure. Individual operators should ensure that their flight crews are aware of the types of failure which will result in an ACAS failure.
 - (2) ACAS may react in an improper manner when false altitude information is provided to own ACAS or transmitted by another aircraft. Individual operators should ensure that their flight crew are aware of the types of unsafe conditions which can arise. Flight crew members should ensure that when they are advised, if their own aircraft is transmitting false altitude reports, an alternative altitude reporting source is selected, or altitude reporting is switched off.
 - (c) Some aeroplanes within 380 ft above ground level (AGL) (nominal value) are deemed to be 'on ground' and will not be displayed. If ACAS is able to determine an aircraft below this altitude is airborne, it will be displayed.
 - (d) ACAS may not display all proximate transponder-equipped aircraft in areas of high density traffic.
 - (e) The bearing displayed by ACAS is not sufficiently accurate to support the initiation of horizontal manoeuvres based solely on the traffic display.
 - (f) ACAS will neither track nor display intruders with a vertical speed in excess of 10 000 ft/min. In addition, the design implementation may result in some short-term errors in the tracked vertical speed of an intruder during periods of high vertical acceleration by the intruder.
 - (g) Ground proximity warning systems/ground collision avoidance systems (GPWSs/GCASs) warnings and wind shear warnings take precedence over ACAS advisories. When either a GPWS/GCAS or wind shear warning is active, ACAS aural annunciations will be inhibited and ACAS will automatically switch to the 'TA only' mode of operation.
- (D) ACAS inhibits

Objective: to verify that the flight crew member is aware of the conditions under which certain functions of ACAS are inhibited.

Criteria: the flight crew member should demonstrate knowledge and understanding of the various ACAS inhibits, including the following:

- (a) 'Increase Descent' RAs are inhibited below 1 450 ft AGL.

- (b) 'Descend' RAs are inhibited below 1 100 ft AGL.
 - (c) All RAs are inhibited below 1 000 ft AGL.
 - (d) All TA aural annunciations are inhibited below 500 ft AGL.
 - (e) Altitude and configuration under which 'Climb' and 'Increase Climb' RAs are inhibited. ACAS can still issue 'Climb' and 'Increase Climb' RAs when operating at the aeroplane's certified ceiling. (In some aircraft types, 'Climb' or 'Increase Climb' RAs are never inhibited.)
- (ii) Operating procedures

The flight crew member should demonstrate the knowledge required to operate the ACAS avionics and interpret the information presented by ACAS. This training should address the following:

(A) Use of controls

Objective: to verify that the pilot can properly operate all ACAS and display controls.

Criteria: demonstrate the proper use of controls, including the following:

- (a) Aircraft configuration required to initiate a self-test.
- (b) Steps required to initiate a self-test.
- (c) Recognising when the self-test was successful and when it was unsuccessful. When the self-test is unsuccessful, recognising the reason for the failure and, if possible, correcting the problem.
- (d) Recommended usage of range selection. Low ranges are used in the terminal area and the higher display ranges are used in the en-route environment and in the transition between the terminal and en-route environment.
- (e) Recognising that the configuration of the display does not affect the ACAS surveillance volume.
- (f) Selection of lower ranges when an advisory is issued, to increase display resolution.
- (g) Proper configuration to display the appropriate ACAS information without eliminating the display of other needed information.
- (h) If available, recommended usage of the above/below mode selector. The above mode should be used during climb and the below mode should be used during descent.
- (i) If available, proper selection of the display of absolute or relative altitude and the limitations of using this display if a barometric correction is not provided to ACAS.

(B) Display interpretation

Objective: to verify that the flight crew member understands the meaning of all information that can be displayed by ACAS. The wide variety of display implementations require the tailoring of some criteria. When the training programme is developed, these criteria should be expanded to cover details for the operator's specific display implementation.

Criteria: the flight crew member should demonstrate the ability to properly interpret information displayed by ACAS, including the following:

- (a) Other traffic, i.e. traffic within the selected display range that is not proximate traffic, or causing a TA or RA to be issued.
- (b) Proximate traffic, i.e. traffic that is within 6 NM and $\pm 1\ 200$ ft.
- (c) Non-altitude reporting traffic.
- (d) No bearing TAs and RAs.
- (e) Off-scale TAs and RAs: the selected range should be changed to ensure that all available information on the intruder is displayed.
- (f) TAs: the minimum available display range that allows the traffic to be displayed should be selected, to provide the maximum display resolution.
- (g) RAs (traffic display): the minimum available display range of the traffic display that allows the traffic to be displayed should be selected, to provide the maximum display resolution.
- (h) RAs (RA display): flight crew members should demonstrate knowledge of the meaning of the red and green areas or the meaning of pitch or flight path angle cues displayed on the RA display. Flight crew members should also demonstrate an understanding of the RA display limitations, i.e. if a vertical speed tape is used and the range of the tape is less than 2 500 ft/min, an increase rate RA cannot be properly displayed.
- (i) If appropriate, awareness that navigation displays oriented on 'Track-Up' may require a flight crew member to make a mental adjustment for drift angle when assessing the bearing of proximate traffic.

(C) Use of the TA only mode

Objective: to verify that a flight crew member understands the appropriate times to select the TA only mode of operation and the limitations associated with using this mode.

Criteria: the flight crew member should demonstrate the following:

- (a) Knowledge of the operator's guidance for the use of TA only.
- (b) Reasons for using this mode. If TA only is not selected when an airport is conducting simultaneous operations from parallel runways separated by less than 1 200 ft, and to some intersecting runways, RAs can be expected. If, for any reason, TA only is not selected and an RA is received in these situations, the response should comply with the operator's approved procedures.
- (c) All TA aural annunciations are inhibited below 500 ft AGL. As a result, TAs issued below 500 ft AGL may not be noticed unless the TA display is included in the routine instrument scan.

(D) Crew coordination

Objective: to verify that the flight crew member understands how ACAS advisories will be handled.

Criteria: the flight crew member should demonstrate knowledge of the crew procedures that should be used when responding to TAs and RAs, including the following:

- (a) task sharing between the pilot flying and the pilot monitoring;
- (b) expected call-outs; and
- (c) communications with ATC.

(E) Phraseology rules

Objective: to verify that the flight crew member is aware of the rules for reporting RAs to the controller.

Criteria: the flight crew member should demonstrate the following:

- (a) the use of the phraseology contained in ICAO PANS-OPS;
- (b) an understanding of the procedures contained in ICAO PANS-ATM and ICAO Annex 2; and
- (c) the understanding that verbal reports should be made promptly to the appropriate ATC unit:
 - (1) whenever any manoeuvre has caused the aeroplane to deviate from an air traffic clearance;
 - (2) when, subsequent to a manoeuvre that has caused the aeroplane to deviate from an air traffic clearance, the aeroplane has returned to a flight path that complies with the clearance; and/or
 - (3) when air traffic issue instructions that, if followed, would cause the crew to manoeuvre the aircraft contrary to an RA with which they are complying.

(F) Reporting rules

Objective: to verify that the flight crew member is aware of the rules for reporting RAs to the operator.

Criteria: the flight crew member should demonstrate knowledge of where information can be obtained regarding the need for making written reports to various States when an RA is issued. Various States have different reporting rules and the material available to the flight crew member should be tailored to the operator's operating environment. This responsibility is satisfied by the flight crew member reporting to the operator according to the applicable reporting rules.

(3) Non-essential items: advisory thresholds

Objective: to demonstrate knowledge of the criteria for issuing TAs and RAs.

Criteria: the flight crew member should demonstrate an understanding of the methodology used by ACAS to issue TAs and RAs and the general criteria for the issuance of these advisories, including the following:

- (i) The minimum and maximum altitudes below/above which TAs will not be issued.
- (ii) When the vertical separation at CPA is projected to be less than the ACAS-desired separation, a corrective RA that requires a change to the existing vertical speed will

be issued. This separation varies from 300 ft at low altitude to a maximum of 700 ft at high altitude.

- (iii) When the vertical separation at CPA is projected to be just outside the ACAS-desired separation, a preventive RA that does not require a change to the existing vertical speed will be issued. This separation varies from 600 to 800 ft.
- (iv) RA fixed range thresholds vary between 0.2 and 1.1 NM.

(h) ACAS manoeuvre training

- (1) Demonstration of the flight crew member's ability to use ACAS displayed information to properly respond to TAs and RAs should be carried out in a full flight simulator equipped with an ACAS display and controls similar in appearance and operation to those in the aircraft. If a full flight simulator is utilised, crew resource management (CRM) should be practised during this training.
- (2) Alternatively, the required demonstrations can be carried out by means of an interactive CBT with an ACAS display and controls similar in appearance and operation to those in the aircraft. This interactive CBT should depict scenarios in which real-time responses should be made. The flight crew member should be informed whether or not the responses made were correct. If the response was incorrect or inappropriate, the CBT should show what the correct response should be.
- (3) The scenarios included in the manoeuvre training should include: corrective RAs; initial preventive RAs; maintain rate RAs; altitude crossing RAs; increase rate RAs; RA reversals; weakening RAs; and multi-aircraft encounters. The consequences of failure to respond correctly should be demonstrated by reference to actual incidents such as those publicised in EUROCONTROL ACAS II Bulletins (available on the EUROCONTROL website).

(i) TA responses

Objective: to verify that the pilot properly interprets and responds to TAs.

Criteria: the pilot should demonstrate the following:

- (A) Proper division of responsibilities between the pilot flying and the pilot monitoring. The pilot flying should fly the aircraft using any type-specific procedures and be prepared to respond to any RA that might follow. For aircraft without an RA pitch display, the pilot flying should consider the likely magnitude of an appropriate pitch change. The pilot monitoring should provide updates on the traffic location shown on the ACAS display, using this information to help visually acquire the intruder.
- (B) Proper interpretation of the displayed information. Flight crew members should confirm that the aircraft they have visually acquired is that which has caused the TA to be issued. Use should be made of all information shown on the display, note being taken of the bearing and range of the intruder (amber circle), whether it is above or below (data tag), and its vertical speed direction (trend arrow).
- (C) Other available information should be used to assist in visual acquisition, including ATC 'party-line' information, traffic flow in use, etc.
- (D) Because of the limitations described, the pilot flying should not manoeuvre the aircraft based solely on the information shown on the ACAS display. No attempt should be made to adjust the current flight path in anticipation of

what an RA would advise, except that if own aircraft is approaching its cleared level at a high vertical rate with a TA present, vertical rate should be reduced to less than 1 500 ft/min.

- (E) When visual acquisition is attained, and as long as no RA is received, normal right of way rules should be used to maintain or attain safe separation. No unnecessary manoeuvres should be initiated. The limitations of making manoeuvres based solely on visual acquisition, especially at high altitude or at night, or without a definite horizon should be demonstrated as being understood.

(ii) RA responses

Objective: to verify that the pilot properly interprets and responds to RAs.

Criteria: the pilot should demonstrate the following:

- (A) Proper response to the RA, even if it is in conflict with an ATC instruction and even if the pilot believes that there is no threat present.
- (B) Proper task sharing between the pilot flying and the pilot monitoring. The pilot flying should respond to a corrective RA with appropriate control inputs. The pilot monitoring should monitor the response to the RA and should provide updates on the traffic location by checking the traffic display. Proper CRM should be used.
- (C) Proper interpretation of the displayed information. The pilot should recognise the intruder causing the RA to be issued (red square on display). The pilot should respond appropriately.
- (D) For corrective RAs, the response should be initiated in the proper direction within 5 seconds of the RA being displayed. The change in vertical speed should be accomplished with an acceleration of approximately $\frac{1}{4}$ g (gravitational acceleration of 9.81 m/sec²).
- (E) Recognition of the initially displayed RA being modified. Response to the modified RA should be properly accomplished, as follows:
 - (a) For increase rate RAs, the vertical speed change should be started within 2½ seconds of the RA being displayed. The change in vertical speed should be accomplished with an acceleration of approximately $\frac{1}{2}$ g.
 - (b) For RA reversals, the vertical speed reversal should be started within 2½ seconds of the RA being displayed. The change in vertical speed should be accomplished with an acceleration of approximately $\frac{1}{3}$ g.
 - (c) For RA weakenings, the vertical speed should be modified to initiate a return towards the original clearance.
 - (d) An acceleration of approximately $\frac{1}{4}$ g will be achieved if the change in pitch attitude corresponding to a change in vertical speed of 1 500 ft/min is accomplished in approximately 5 seconds, and of $\frac{1}{3}$ g if the change is accomplished in approximately 3 seconds. The change in pitch attitude required to establish a rate of climb or descent of 1 500 ft/min from level flight will be approximately 6° when the true

airspeed (TAS) is 150 kt, 4° at 250 kt, and 2° at 500 kt. (These angles are derived from the formula: 1 000 divided by TAS.)

- (F) Recognition of altitude crossing encounters and the proper response to these RAs.
 - (G) For preventive RAs, the vertical speed needle or pitch attitude indication should remain outside the red area on the RA display.
 - (H) For maintain rate RAs, the vertical speed should not be reduced. Pilots should recognise that a maintain rate RA may result in crossing through the intruder's altitude.
 - (I) When the RA weakens, or when the green 'fly to' indicator changes position, the pilot should initiate a return towards the original clearance, and when 'clear of conflict' is annunciated, the pilot should complete the return to the original clearance.
 - (J) The controller should be informed of the RA as soon as time and workload permit, using the standard phraseology.
 - (K) When possible, an ATC clearance should be complied with while responding to an RA. For example, if the aircraft can level at the assigned altitude while responding to RA (an 'adjust vertical speed' RA (version 7) or 'level off' (version 7.1), it should be done; the horizontal (turn) element of an ATC instruction should be followed.
 - (L) Knowledge of the ACAS multi-aircraft logic and its limitations, and that ACAS can optimise separations from two aircraft by climbing or descending towards one of them. For example, ACAS only considers intruders that it considers to be a threat when selecting an RA. As such, it is possible for ACAS to issue an RA against one intruder that results in a manoeuvre towards another intruder that is not classified as a threat. If the second intruder becomes a threat, the RA will be modified to provide separation from that intruder.
- (i) ACAS initial evaluation
- (1) The flight crew member's understanding of the academic training items should be assessed by means of a written test or interactive CBT that records correct and incorrect responses to phrased questions.
 - (2) The flight crew member's understanding of the manoeuvre training items should be assessed in a full flight simulator equipped with an ACAS display and controls similar in appearance and operation to those in the aircraft the flight crew member will fly, and the results assessed by a qualified instructor, inspector, or check airman. The range of scenarios should include: corrective RAs; initial preventive RAs; maintain rate RAs; altitude crossing RAs; increase rate RAs; RA reversals; weakening RAs; and multi-threat encounters. The scenarios should also include demonstrations of the consequences of not responding to RAs, slow or late responses, and manoeuvring opposite to the direction called for by the displayed RA.
 - (3) Alternatively, exposure to these scenarios can be conducted by means of an interactive CBT with an ACAS display and controls similar in appearance and operation to those in the aircraft the pilot will fly. This interactive CBT should depict scenarios in which real-

time responses should be made and a record made of whether or not each response was correct.

- (j) ACAS recurrent training
 - (1) ACAS recurrent training ensures that flight crew members maintain the appropriate ACAS knowledge and skills. ACAS recurrent training should be integrated into and/or conducted in conjunction with other established recurrent training programmes. An essential item of recurrent training is the discussion of any significant issues and operational concerns that have been identified by the operator. Recurrent training should also address changes to ACAS logic, parameters or procedures and to any unique ACAS characteristics which flight crew members should be made aware of.
 - (2) It is recommended that the operator's recurrent training programmes using full flight simulators include encounters with conflicting traffic when these simulators are equipped with ACAS. The full range of likely scenarios may be spread over a 2 year period. If a full flight simulator, as described above, is not available, use should be made of an interactive CBT that is capable of presenting scenarios to which pilot responses should be made in real-time.

SPO.OP.210 Approach and landing conditions — aeroplanes and helicopters

Regulation (EU) 2021/2237

Before commencing an approach operation, the pilot-in-command shall be satisfied that:

- (a) the meteorological conditions at the aerodrome or the operating site and the condition of the runway/FATO intended to be used will not prevent a safe approach, landing or go-around, considering the performance information contained in the operations manual; and
- (b) the selected aerodrome operating minima are consistent with all of the following:
 - (1) the operative ground equipment;
 - (2) the operative aircraft systems;
 - (3) the aircraft performance;
 - (4) flight crew qualifications.

AMC1 SPO.OP.210 Approach and landing conditions — aeroplanes

ED Decision 2021/005/R

LANDING DISTANCE ASSESSMENT— COMPLEX AEROPLANES

- (a) The in-flight landing distance assessment should be based on the latest available weather report and runway condition report (RCR) or equivalent information based on the RCR.
- (b) The assessment should be initially carried out when the weather report and the RCR are obtained, usually around top of descent. If the planned duration of the flight does not allow the flight crew to carry out the assessment in non-critical phases of flight, the assessment should be carried out before departure.
- (c) When meteorological conditions may lead to a degradation of the runway surface condition, the assessment should include consideration of how much deterioration in runway surface friction characteristics may be tolerated, so that a quick decision can be made prior to landing.

- (d) The flight crew should monitor the evolution of the actual conditions during the approach, to ensure that they do not degrade below the condition that was previously determined to be the minimum acceptable.
- (e) The in-flight determination of the landing distance should be done in such a way that either:
 - (1) the landing distance available (LDA) on the intended runway is at least 115 % of the landing distance at the estimated time of landing, determined in accordance with the performance information for the assessment of the landing distance at time of arrival (LDTA); or
 - (2) if performance information for the assessment of the LDTA is not available, the LDA on the intended runway at the estimated time of landing is at least the landing distance determined at the time of dispatch.
- (f) If performance information for the assessment of the LDTA is available, it should be based on approved data contained in the AFM, or on other data that is either determined in accordance with the applicable certification standards for aeroplanes or determined by EASA.
- (g) Whenever the runway braking action encountered during the landing roll is not as good as reported by the aerodrome operator in the RCR, the pilot-in-command should notify the air traffic services (ATS) by means of a special air-report (AIREP) as soon as practicable.

LANDING DISTANCE ASSESSMENT — OTHER-THAN-COMPLEX AEROPLANES

- (a) The in-flight landing distance assessment should be based on the latest available weather report and, if available, RCR.
- (b) The assessment should be initially carried out when weather report and RCR are obtained, usually around top of descent. If the planned duration of the flight does not allow the flight crew to carry out the assessment in non-critical phases of flight, the assessment should be carried out before departure.
- (c) When meteorological conditions may lead to a degradation of the runway surface condition, the assessment should include consideration of how much deterioration in runway surface friction characteristics may be tolerated, so that a quick decision can be made prior to landing.
- (d) Whenever the runway braking action encountered during the landing roll is not as good as reported by the aerodrome operator in the RCR, the pilot-in-command should notify ATS by means of an AIREP as soon as practicable.

GM1 SPO.OP.210 Approach and landing conditions — aeroplanes

ED Decision 2021/005/R

LANDING DISTANCE — COMPLEX AEROPLANES

The assessment of the landing distance begins with the acquisition of the latest available weather information and the RCR. The information provided in the RCR is divided in two sections:

- (a) The 'aircraft performance' section which contains information that is directly relevant in a performance computation.
- (b) The 'situational awareness' section which contains information that the flight crew should be aware of for a safe operation, but which does not have a direct impact on the performance assessment.

The 'aircraft performance' section of the RCR includes an RWYCC, the contaminant type, depth and coverage for each third of the runway.

The determination of the RWYCC is based on the use of the runway condition assessment matrix (RCAM); however, the presentation of the information in the RCAM is appropriate for use by aerodrome personnel trained and competent in assessing the runway condition in a way that is relevant to aircraft performance. While full implementation of the RCAM standard will eventually no longer require the flight crew to derive from various information available to them the appropriate runway condition to be used for the landing performance assessment at the time of arrival, it is desirable that pilots maintain an understanding of the performance effect of various components considered in the assessment.

It is the task of the aerodrome personnel to report the appropriate RWYCC in order to allow the flight crew to assess the landing performance characteristics of the runway in use. When no RWYCC is available in winter conditions, the RCAM provides the flight crew with a combination of the relevant information (runway surface conditions: state and/or contaminant or AIREP in order to determine the RWYCC.

Table 1 below is an excerpt of the RCAM and permits to carry out the primary assessment based on the reported contaminant type and depth, as well as on the OAT.

Table 1: Association between the runway surface condition and the RWYCC based on the reported contaminant type and depth and on the OAT

Runway surface condition	Surface condition descriptor	Depth	Notes	RWYCC	
Dry		n/a		6	
Wet	Damp (any visible dampness)	3 mm or less	Including wet or contaminated runways below 25 % coverage in each runway third	5	
	Wet				
Slippery wet				3	
Contaminated	Compacted snow	Any	At or below OAT – 15 °C	4	
			3	3	
	Dry snow	3 mm or less		5	
			More than 3 mm up to 100 mm	Including when any depth occurs on top of compacted snow	3
			Any	On top of ice	02
	Frost ¹	Any		5	
	Ice	Any	In cold and dry conditions	1	
	Slush	3 mm or less		5	
			More than 3 mm up to 15 mm		2
	Standing water	3 mm or less		5	
			More than 3 mm up to 15 mm		2
			Any	On top of ice	02
	Wet ice	Any		02	
Wet snow	3 mm or less		5		

	More than 3 mm up to 30 mm	Including when any depth occurs on top of compacted snow	3
	Any	On top of ice	02

Note 1: Under certain conditions, frost may cause the surface to become very slippery.

Note 2: Operations in conditions where less-than-poor braking action prevails are prohibited.

Note 3: The runway surface temperature should preferably be used where available.

A primary assessment may have to be downgraded by the aerodrome operator based on an AIREP of lower braking action than the one typically associated with the type and depth of contaminant on the runway or any other observation.

Upgrading a RWYCC 5, 4, 3 or 2 determined by the aerodrome operator from the observed contaminant type is not allowed.

A RWYCC 1 or 0 maybe be upgraded by the aerodrome operator to a maximum of RWYCC 3. The reason for the upgrade will be specified in the ‘situational awareness’ section of the RCR.

When the aerodrome operator is approved for operations on specially prepared winter runways, in accordance with Annex V (Part-ADR.OPS) to Regulation (EU) No 139/2014, the RWYCC of a runway that is contaminated with compacted snow or ice, may be upgraded to RWYCC 4 depending upon a specific treatment of the runway. In such cases, the reason for the upgrade will be specified in the ‘situational awareness’ section of the RCR.

GM2 SPO.OP.210 Approach and landing conditions — aeroplanes

ED Decision 2021/005/R

RCR, RWYCC and RCAM — COMPLEX AEROPLANES

A detailed description of the RCR format and content, the RWYCC and the RCAM may be found in Annex V (Part-ADR.OPS) to Regulation (EU) No 139/2014. Further guidance may be found in the following documents:

- (a) ICAO Doc 9981 ‘PANS Aerodromes’;
- (b) ICAO Doc 4444 ‘PANS ATM’;
- (c) ICAO Doc 10064 ‘Aeroplane Performance Manual’; and
- (d) ICAO Circular 355 ‘Assessment, Measurement and Reporting of Runway Surface Conditions’.

RUNWAY CONDITION REPORT (RCR) — OTHER-THAN-COMPLEX AEROPLANES

When the aerodrome reports the runway conditions by means of an RCR, the information thereby contained, includes a RWYCC. The determination of the RWYCC is based on the use of the RCAM. The RCAM correlates the RWYCC with the contaminant present on the runway and the braking action.

A detailed description of the RCR format and content, the RWYCC and the RCAM may be found in Annex V (Part-ADR.OPS) to Regulation (EU) No 139/2014. Further guidance may be found in the following documents:

- (a) ICAO Doc 9981 ‘PANS Aerodromes’;
- (b) ICAO Doc 4444 ‘PANS ATM’;

- (c) ICAO Doc 10064 ‘Aeroplane Performance Manual’; and
- (d) ICAO Circular 355 ‘Assessment, Measurement and Reporting of Runway Surface Conditions’.

GM3 SPO.OP.210 Approach and landing conditions — aeroplanes

ED Decision 2021/005/R

COMPLEX MOTO-POWERED AEROPLANES — PERFORMANCE INFORMATION FOR THE ASSESSMENT OF LDTA

Guidance on performance information for the assessment of the LDTA may be found in:

- (a) [AMC1 CAT.OP.MPA.303\(e\)](#) of the AMC & GM to Annex IV (Part CAT) to Regulation (EU) No 965/2012; and
- (b) ICAO Doc 10064 ‘Aeroplane Performance Manual’.

GM4 SPO.OP.210 Approach and landing conditions — aeroplanes

ED Decision 2021/005/R

REPORTING ON RUNWAY BRAKING ACTION — COMPLEX AEROPLANES

The role of the flight crew in the runway surface condition reporting process does not end once a safe landing has been achieved. While the aerodrome operator is responsible for generating the RCR, flight crew are responsible for providing accurate braking action reports.

The flight crew braking action reports provide feedback to the aerodrome operator regarding the accuracy of the RCR resulting from the observed runway surface conditions.

ATC passes these braking action reports to the aerodrome operator, which in turn uses them in conjunction with the RCAM to determine if it is necessary to downgrade or upgrade the RWYCC.

During busy times, runway inspections and maintenance may be less frequent and need to be sequenced with arrivals. Therefore, aerodrome operators may depend on braking action reports to confirm that the runway surface condition is not deteriorating below the assigned RCR.

Since both the ATC and the aerodrome operator rely on accurate braking action reports, flight crew should use standardised terminology in accordance with ICAO Doc 4444 — ‘PANS ATM’.

The following Table 1 shows the correlation between the terminology to be used in the AIREP to report the braking action and the RWYCC.

Table 1: Association between AIREP and RWYCC

AIREP (braking action)	Description	RWYCC
N/A		6
GOOD	Braking deceleration is normal for the wheel braking effort applied AND directional control is normal.	5
GOOD TO MEDIUM	Braking deceleration OR directional control is between good and medium.	4
MEDIUM	Braking deceleration is noticeably reduced for the wheel braking effort applied OR directional control is noticeably reduced.	3
MEDIUM TO POOR	Braking deceleration OR directional control is between medium and poor.	2

POOR	Braking deceleration is significantly reduced for the wheel braking effort applied OR directional control is significantly reduced.	1
LESS THAN POOR	Braking deceleration is minimal to non-existent for the wheel braking effort applied OR directional control is uncertain.	0

An AIREP should be transmitted to the ATC, in accordance with one of the following specifications, as applicable:

- (a) Good braking action is reported as 'BRAKING ACTION GOOD'.
- (b) Good to medium braking action is reported as 'BRAKING ACTION GOOD TO MEDIUM'.
- (c) Medium braking action is reported as 'BRAKING ACTION MEDIUM'.
- (d) Medium to poor braking action is reported as 'BRAKING ACTION MEDIUM TO POOR'.
- (e) Poor braking action is reported as 'BRAKING ACTION POOR'.
- (f) Less than poor braking action is reported as 'BRAKING ACTION LESS THAN POOR'.

In some cases, the differences between two consecutive levels of the six braking action categories between 'Good' and 'Less than Poor' may be too subtle for the flight crew to detect. It is therefore acceptable for the flight crew to report on a more coarse scale of 'Good', 'Medium' and 'Poor'.

Whenever requested by ATC, or if the braking action encountered during the landing roll is not as previously reported by the aerodrome operator in the RCR, pilots should provide a braking action report. This is especially important and safety relevant where the experienced braking action is worse than the braking action associated with any RWYCC code currently in effect for that portion of the runway concerned.

When the experienced braking action is better than that reported by the aerodrome operator, it is important to report this information, which may trigger further actions for the aerodrome operator in order to upgrade the RCR.

If an aircraft-generated braking action report is available, it should be transmitted, identifying its origin accordingly. If the flight crew have reason to modify the aircraft-generated braking action report based on their judgement, the commander should be able to amend such report.

A braking action AIREP of 'Less than Poor' leads to a runway closure until the aerodrome operator can improve the runway condition.

An air safety report should be submitted whenever flight safety has been endangered due to low braking action.

GM5 SPO.OP.210 Approach and landing conditions — aeroplanes

ED Decision 2021/005/R

FLIGHT CREW TRAINING

Flight crew should be trained on the use of the RCR, on the use of performance data for the assessment of the LDTA, if available, and on reporting braking action using the AIREP format.

Guidance to develop the content of the training may be found in:

- (a) [AMC1 CAT.OP.MPA.303](#) & [CAT.OP.MPA.311](#) of the AMC & GM to Annex IV (Part CAT) to Regulation (EU) No 965/2012, as applicable to the intended operations;
- (b) ICAO Doc 10064 'Aeroplane Performance Manual'; and

- (c) ICAO Circular 355 'Assessment, Measurement and Reporting of Runway Surface Conditions'.

FLIGHT CREW TRAINING — OTHER-THAN-COMPLEX AEROPLANES

When the aerodrome reports the runway conditions by means of a RCR, flight crew should be trained on the use of the RCR for the assessment of the landing distance, and on reporting braking action using the AIREP format. Guidance to develop the content of the training may be found in:

- (a) ICAO Doc 10064 'Aeroplane Performance Manual'; and
(b) ICAO Circular 355 'Assessment, Measurement and Reporting of Runway Surface Conditions'.

SPO.OP.211 Approach and landing conditions – helicopters*Regulation (EU) 2019/1387*

Before commencing an approach to land, the pilot-in-command shall be satisfied that, according to the information available, the weather at the aerodrome or the operating site and the condition of the final approach and take-off area (FATO) intended to be used would not prevent a safe approach, landing or missed approach.

AMC1 SPO.OP.211 Approach and landing conditions — helicopters*ED Decision 2021/005/R***FATO SUITABILITY**

The in-flight determination of the FATO suitability should be based on the latest available meteorological report.

SPO.OP.215 Commencement and continuation of approach*Regulation (EU) 2021/2237*

- (a) For aeroplanes, if the reported visibility (VIS) or controlling RVR for the runway to be used for landing is less than the applicable minimum, then an instrument approach operation shall not be continued:
- (1) past a point at which the aeroplane is 1 000 ft above the aerodrome elevation; or
 - (2) into the final approach segment (FAS) if the DH or MDH is higher than 1 000 ft.
- (b) For helicopters, if the reported RVR is less than 550 m and the controlling RVR for the runway to be used for landing is less than the applicable minimum, then an instrument approach operation shall not be continued:
- (1) past a point at which the helicopter is 1 000 ft above the aerodrome elevation; or
 - (2) into the FAS if the DH or MDH is higher than 1 000 ft.
- (c) If the required visual reference is not established, a missed approach shall be executed at or before the DA/H or the MDA/H.
- (d) If the required visual reference is not maintained after DA/H or MDA/H, a go-around shall be executed promptly.
- (e) Notwithstanding point (a), in the case where no RVR is reported, and the reported VIS is lower, but the converted meteorological visibility (CMV) is greater than the applicable minimum, then the instrument approach can be continued to the DA/H or MDA/H.

- (f) Notwithstanding points (a) and (b), if there is no intention to land, the instrument approach may be continued to the DA/H or the MDA/H. A missed approach shall be executed at or before the DA/H or the MDA/H.

GM1 SPO.OP.215 Commencement and continuation of approach

ED Decision 2022/012/R

APPLICATION OF RVR OR VIS REPORTS — AEROPLANES

- (a) There is no prohibition on the commencement of an approach based on the reported RVR or VIS. The restriction in [SPO.OP.215](#) applies only if the RVR or VIS is reported and applies to the continuation of the approach past a point where the aircraft is 1 000 ft above the aerodrome elevation or in the FAS, as applicable.

APPLICATION OF RVR OR VIS REPORTS — HELICOPTERS

- (b) There is no prohibition on the commencement of an approach based on the reported RVR. The restriction in [SPO.OP.215](#) applies to the continuation of the approach past a point where the aircraft is 1 000 ft above the aerodrome elevation or into the FAS, as applicable.

The prohibition to continue the approach applies only if the RVR is reported and is below 550 m and is below the operating minima. There is no prohibition based on VIS.

- (c) If the reported RVR is 550 m or greater, but it is less than the RVR calculated in accordance with [AMC5 CAT.OP.MPA.110](#), a go-around is likely to be necessary since visual reference may not be established at the DH or MDH. Similarly, in the absence of an RVR report, the reported visibility or a digital image may indicate that a go-around is likely. The pilot-in-command should consider available options, based on a thorough assessment of risk, such as diverting to an alternate, before commencing the approach.

APPLICATION OF RVR OR VIS REPORTS — ALL AIRCRAFT

- (d) If a deterioration in the RVR or VIS is reported once the aircraft is below 1 000 ft or in the FAS, as applicable, then there is no requirement for the approach to be discontinued. In this situation, the normal visual reference requirements would apply at the DA/H.
- (e) Where additional RVR information is provided (e.g. midpoint and stop end), this is advisory; such information may be useful to the pilot in order to determine whether there will be sufficient visual reference to control the aircraft during roll-out and taxi. For operations where the aircraft will be controlled manually during roll-out, Table 1 in [AMC1 SPA.LVO.100\(a\)](#) provides an indication of the RVR that may be required to allow manual lateral control of the aircraft on the runway.

AMC1 SPO.OP.215(a) Commencement and continuation of approach

ED Decision 2022/012/R

MINIMUM RVR FOR CONTINUATION OF APPROACH — AEROPLANES

- (a) The controlling RVR should be the touchdown RVR.
- (b) If the touchdown RVR is not reported, then the midpoint RVR should be the controlling RVR.
- (c) Where the RVR is not available, CMV should be used, except for the purpose of continuation of an approach in LVO in accordance with [AMC8 SPO.OP.110](#).

AMC1 SPO.OP.215(b) Commencement and continuation of approach

ED Decision 2022/012/R

MINIMUM RVR FOR CONTINUATION OF APPROACH — HELICOPTERS

- (a) The controlling RVR should be the touchdown RVR.
- (b) If the touchdown RVR is not reported, then the midpoint RVR should be the controlling RVR.

AMC1 SPO.OP.215(c) Commencement and continuation of approach

ED Decision 2022/012/R

VISUAL REFERENCES FOR INSTRUMENT APPROACH OPERATIONS

For instrument approach operations Type A and CAT I instrument approach operations Type B, at least one of the visual references specified below should be distinctly visible and identifiable to the pilot at the MDA/H or the DA/H:

- (a) elements of the approach lighting system;
- (b) the threshold;
- (c) the threshold markings;
- (d) the threshold lights;
- (e) the threshold identification lights;
- (f) the visual glide path indicator;
- (g) the TDZ or TDZ markings;
- (h) the TDZ lights;
- (i) FATO/runway edge lights;
- (j) for helicopter PinS approaches, the identification beacon light and visual ground reference;
- (k) for helicopter PinS approaches, the identifiable elements of the environment defined on the instrument chart;
- (l) for helicopter PinS approaches with instructions to 'proceed VFR', sufficient visual cues to determine that VFR criteria are met; or
- (m) other visual references specified in the operations manual.

GM1 SPO.OP.215(f) Commencement and continuation of approach

ED Decision 2022/012/R

APPROACHES WITH NO INTENTION TO LAND

The approach may be continued to the DA/H or the MDA/H regardless of the reported RVR or VIS. Such operations should be coordinated with the air traffic services (ATS).

SPO.OP.230 Standard operating procedures

Regulation (EU) No 379/2014

- (a) Before commencing a specialised operation, the operator shall conduct a risk assessment, assessing the complexity of the activity to determine the hazards and associated risks inherent in the operation and establish mitigating measures.
- (b) Based on the risk assessment, the operator shall establish standard operating procedures (SOP) appropriate to the specialised activity and aircraft used taking account of the requirements of subpart E. The SOP shall be part of the operations manual or a separate document. SOP shall be regularly reviewed and updated, as appropriate.
- (c) The operator shall ensure that specialised operations are performed in accordance with SOP.

AMC1 SPO.OP.230 Standard operating procedures

ED Decision 2014/018/R

DEVELOPMENT OF STANDARD OPERATING PROCEDURES

- (a) SOPs should be developed to a standard format in accordance with [AMC2 SPO.OP.230](#) (SOP template) and taking into account the results of the risk assessment process.
- (b) SOPs should be based on a systematic risk assessment to ensure that the risks associated with the task are acceptable. The risk assessment should describe the activity in detail, identify the relevant hazards, analyse the causes and consequences of accidental events and establish methods to treat the associated risk.

AMC2 SPO.OP.230 Standard operating procedures

ED Decision 2022/012/R

TEMPLATE

- (a) Nature and complexity of the activity:
 - (1) The nature of the activity and exposure. The nature of the flight and the risk exposure (e.g. low height) should be described.
 - (2) The complexity of the activity. Detail should be provided on how demanding the activity is with regard to the required piloting skills, the crew composition, the necessary level of experience, the ground support, safety and individual protective equipment that should be provided for persons involved.
 - (3) The operational environment and geographical area. The operational environment and geographical area over which the operation takes place should be described:
 - (i) congested hostile environment: aircraft performance standard, compliance with rules of the air, mitigation of third party risk;
 - (ii) mountain areas: altitude, performance, the use/non-use of oxygen with mitigating procedures;
 - (iii) sea areas: sea state and temperature, risk of ditching, availability of search and rescue, survivability, carriage of safety equipment;
 - (iv) desert areas: carriage of safety equipment, reporting procedures, search and rescue information; and
 - (v) other areas.

-
- (4) The application of risk assessment and evaluation. The method of application of (a)(1) to (a)(3) to the particular operation so as to minimise risk should be described. The description should reference the risk assessment and the evaluation on which the procedure is based. The SOPs should:
- (i) contain elements relevant to the operational risk management performed during flight;
 - (ii) contain limitations, where required, such as weather, altitudes, speeds, power margins, masses, landing site size; and
 - (iii) list functions required to monitor the operation. Special monitoring requirements in addition to the normal functions should be described in the SOPs.
- (b) Aircraft and equipment:
- (1) The aircraft. The category of aircraft to be used for the activity should be indicated (e.g. helicopter/aeroplane, single/multi-engined, other-than complex motor-powered/complex motor-powered, classic tail rotor/Fenestron/no tail rotor (NOTAR) equipped). In particular, for helicopters, the necessary level of performance certification (Category A/B) should be specified.
 - (2) Equipment. All equipment required for the activity should be listed. This includes installed equipment certified in accordance with Part-21 as well as equipment approved in accordance with other officially recognised standards. A large number of activities require, in addition to the standard radio communication equipment, additional air-to-ground communication equipment. This should be listed and the operational procedure should be defined.
- (c) Crew members:
- (1) The crew composition, including the following, should be specified:
 - (i) minimum flight crew (according to the appropriate manual); and
 - (ii) additional flight crew.
 - (2) In addition, for flight crew members, the following should be specified:
 - (i) selection criteria (initial qualification, flight experience, experience of the activity);
 - (ii) initial training (volume and content of the training); and
 - (iii) recent experience requirement and/or recurrent training (volume and content of the training).
 - (3) If the operator specifies a crew composition of more than one pilot, the following should apply:
 - (i) the SOPs should ensure that the pilot flying and pilot monitoring functions are possible from either pilot's seat throughout the flight; and
 - (ii) the operator should adapt the SOPs to the specified crew composition.

The criteria listed in (c)(2)(i) to (c)(2)(iii) should take into account the operational environment and the complexity of the activity and should be detailed in the training programmes.

(d) Task specialists:

- (1) Whenever a task specialist is required, his/her function on board should be clearly defined. In addition, the following should be specified:
 - (i) selection criteria (initial background, experience of the activity);
 - (ii) initial training (volume and content of the training); and
 - (iii) recent experience requirement and/or recurrent training (volume and content of the training).

The criteria listed in (d)(1) should take into account the specialisation of the task specialist and should be detailed in the training programmes.

- (2) There is a large number of activities for which task specialists are required. This chapter should detail the following for such personnel:
 - (i) specialisation;
 - (ii) previous experience; and
 - (iii) training or briefing.

Briefing or specific training for task specialists referred to in (d)(2) should be detailed in the training programmes.

(e) Performance:

This chapter should detail the specific performance requirements to be applied, in order to ensure an adequate power margin.

(f) Normal procedures:

- (1) Operating procedures. The operating procedures to be applied by the flight crew, including the coordination with task specialists.
- (2) Ground procedures. The procedures to be applied by the task specialists should be described, e.g. loading/unloading, cargo hook operation.

(g) Emergency procedures:

- (1) Operating procedures. The emergency procedures to be applied by the flight crew, the coordination with the task specialist and coordination between the flight crew and task specialists should be described.
- (2) Ground procedures. The emergency procedures to be applied by the task specialists (e.g. in the case of a forced landing) should be specified.

(h) Ground equipment:

This chapter should detail the nature, number and location of ground equipment required for the activity, such as:

- (1) refuelling facilities, dispenser and storage;
- (2) firefighting equipment;
- (3) size of the operating site (landing surface, loading/unloading area); and
- (4) ground markings.

(i) Records:

It should be determined which records specific to the flight(s) are to be kept, such as task details, aircraft registration, pilot-in-command, flight times, weather and any remarks, including a record of occurrences affecting flight safety or the safety of persons or property on the ground.

GM1 SPO.OP.230 Standard operating procedures

ED Decision 2014/018/R

TEMPLATE FORMS

Figure 1 — Development of a SOP based on a risk assessment

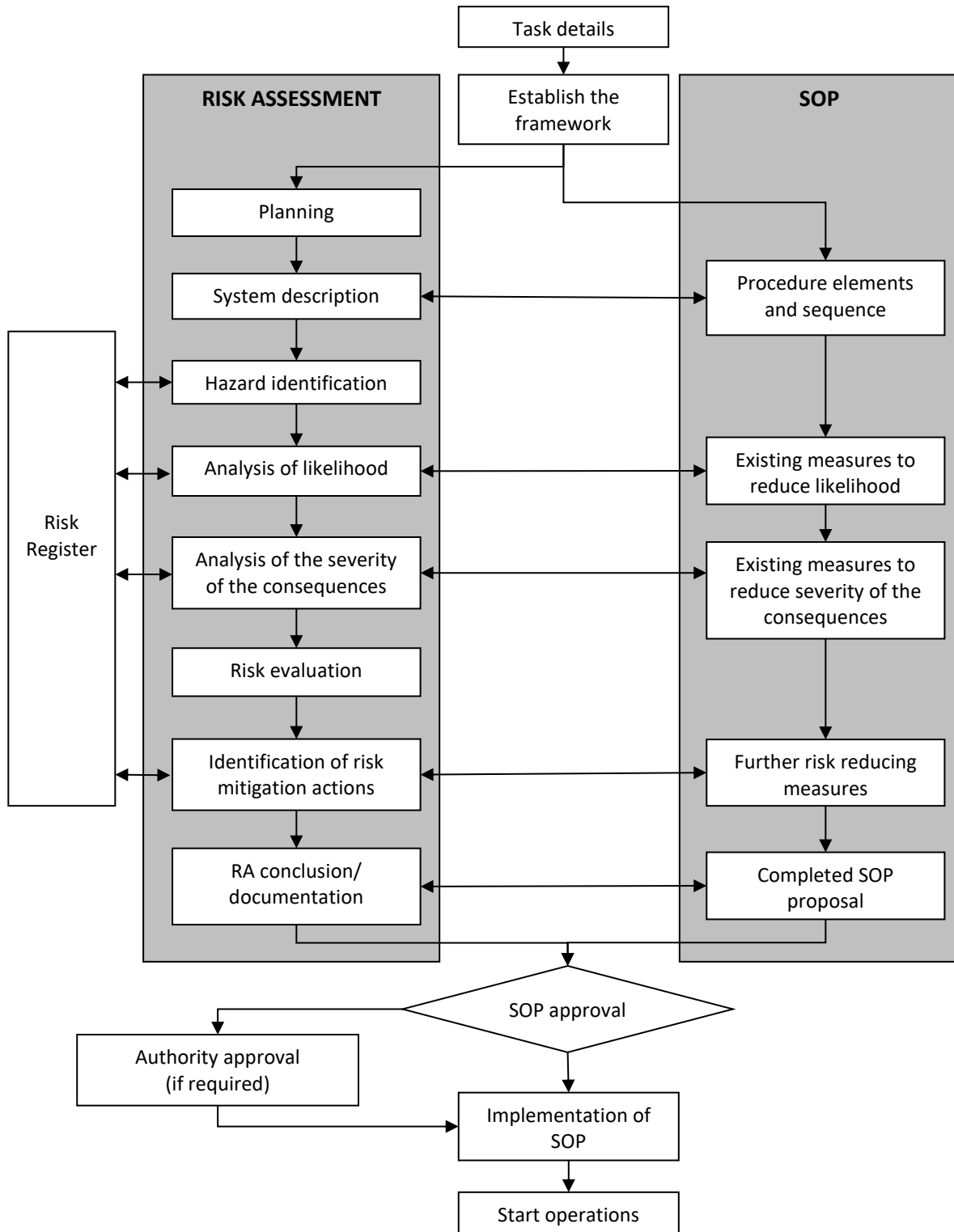

Template Form A — Risk assessment (RA)

Date: RA of Responsible:
Purpose:
Type of operation and brief description:
Participants, working group:
Preconditions, assumptions and simplifications:
Data used:
Description of the analysis method:
External context: <ul style="list-style-type: none"> Regulatory requirements Approvals Environmental conditions (visibility, wind, turbulence, contrast, light, elevation, etc. unless evident from the SOPs) Stakeholders and their potential interest
Internal context: <ul style="list-style-type: none"> Type(s) of aircraft Personnel and qualifications Combination/similarity with other operations/SOPs Other RA used/considered/plugged in
Existing barriers and emergency preparedness:
Monitoring and follow up:
Description of the risk:
Risk evaluation:
Conclusions:

Template Form B — Hazard identification (HI)

Date:HI of Responsible:

Phase of operation	Hazard ref	Hazard	Causes	Existing controls	Controls ref	Comments

Note:

Haz ref: A unique number for hazards, e.g. for use in a database

Controls ref: A unique number for the existing controls

Template Form C — Mitigating measures

Date: RA of Responsible:

Phase of operation	Haz ref	Consequence	Existing mitigation actions	Mitigation ref	L	S	Further mitigation required

Note:

Haz ref: A unique number for hazards, e.g. for use in a database

Mitigation ref: A unique number for the mitigation actions

L: Likelihood

S: Severity

Template register A — risk register

Ref	Operation/ Procedure	Ref	Hazard	Ref	Consequences	Mitigation actions	L	S	Monitoring

Note:

L: Likelihood

S: Severity

SPO.OP.235 EFVS 200 operations

Regulation (EU) 2021/2237

- (a) An operator that intends to conduct EFVS 200 operations with operational credits and without a specific approval shall ensure that:
 - (1) the aircraft is certified for the intended operations;
 - (2) only runways, FATOs and IAPs suitable for EFVS operations are used;

- (3) the flight crew are competent to conduct the intended operation and a training and checking programme for the flight crew members and relevant personnel involved in the flight preparation is established;
 - (4) operating procedures are established;
 - (5) any relevant information is documented in the minimum equipment list (MEL);
 - (6) any relevant information is documented in the maintenance programme;
 - (7) safety assessments are carried out and performance indicators are established to monitor the level of safety of the operation; and
 - (8) the aerodrome operating minima take into account the capability of the system used.
- (b) The operator shall not conduct EFVS 200 operations when conducting LVOs.
- (c) Notwithstanding point (a)(1), the operator may use EVSs meeting the minimum criteria to conduct EFVS 200 operations, provided that this is approved by the competent authority.

GM1 SPO.OP.235 EFVS 200 operations

ED Decision 2022/012/R

GENERAL

- (a) EFVS operations exploit the improved visibility provided by the EFVS to extend the visual segment of an instrument approach. EFVSs cannot be used to extend the instrument segment of an approach and thus the DH for EFVS 200 operations is always the same as for the same approach conducted without EFVS.
- (b) Equipment for EFVS 200 operations
- (1) In order to conduct EFVS 200 operations, a certified EFVS is used (EFVS-A or EFVS-L). An EFVS is an enhanced vision system (EVS) that also incorporates a flight guidance system and displays the image on a HUD or equivalent display. The flight guidance system will incorporate aircraft flight information and flight symbology.
 - (2) In multi-pilot operations, a suitable display of EFVS sensory imagery is provided to the pilot monitoring.
- (c) Suitable approach procedures
- (1) Types of approach operation are specified in [AMC1 SPO.OP.235\(a\)\(2\)](#).
EFVS 200 operations are used for 3D approach operations. This may include operations based on NPA procedures, approach procedures with vertical guidance and PA procedures including approach operations requiring specific approvals, provided that the operator holds the necessary approvals.
 - (2) Offset approaches
Refer to [AMC1 SPO.OP.235\(a\)\(2\)](#).
 - (3) Circling approaches
EFVSs incorporate a HUD or an equivalent system so that the EFVS image of the scene ahead of the aircraft is visible in the pilot's forward external FOV. Circling operations require the pilot to maintain visual references that may not be directly ahead of the aircraft and may not be aligned with the current flight path. EFVSs cannot therefore be used in place of natural visual reference for circling approaches.

- (d) Aerodrome operating minima for EFVS 200 operations are determined in accordance with [AMC1 SPO.OP.235\(a\)\(8\)](#).

The performance of EFVSs depends on the technology used and weather conditions encountered. Table 1 'Operations utilising EFVS: RVR reduction' has been developed after an operational evaluation of two different EVSs, both using infrared sensors, along with data and support provided by the FAA. Approaches were flown in a variety of conditions including fog, rain and snow showers, as well as at night to aerodromes located in mountainous terrain. Table 1 contains conservative figures to cater for the expected performance of infrared sensors in the variety of conditions that might be encountered. Some systems may have better capability than those used for the evaluation, but credit cannot be taken for such performance in EFVS 200 operations.

- (e) The conditions for commencement and continuation of the approach are in accordance with [SPO.OP.215](#).

Pilots conducting EFVS 200 operations may commence an approach and continue that approach below 1 000 ft above the aerodrome or into the FAS if the reported RVR or CMV is equal to or greater than the lowest RVR minima determined in accordance with [AMC1 SPO.OP.235\(a\)\(8\)](#) and if all the conditions for the conduct of EFVS 200 operations are met.

Should any equipment required for EFVS 200 operations be unserviceable or unavailable, the conditions to conduct EFVS 200 operations would not be satisfied, and the approach should not be commenced. In the event of failure of the equipment required for EFVS 200 operations after the aircraft descends below 1 000 ft above the aerodrome or into the FAS, the conditions of [SPO.OP.230](#) would no longer be satisfied unless the RVR reported prior to commencement of the approach was sufficient for the approach to be flown without the use of EFVS in lieu of natural vision.

- (f) EFVS image requirements at the DA/H are specified in [AMC1 SPO.OP.235\(a\)\(4\)](#).

The requirements for features to be identifiable on the EFVS image in order to continue approach below the DH are more stringent than the visual reference requirements for the same approach flown without EFVS. The more stringent standard is needed because the EFVS might not display the colour of lights used to identify specific portions of the runway and might not consistently display the runway markings. Any visual approach path indicator using colour-coded lights may be unusable.

- (g) Obstacle clearance in the visual segment

The 'visual segment' is the portion of the approach between the DH or the MAPt and the runway threshold. In the case of EFVS 200 operations, this part of the approach may be flown using the EFVS image as the primary reference and obstacles may not always be identifiable on an EFVS image. The operational assessment specified in [AMC1 SPO.OP.235\(a\)\(2\)](#) is therefore required to ensure obstacle clearance during the visual segment.

- (h) Visual reference requirements at 200 ft above the threshold

For EFVS 200 operations, natural visual reference is required by a height of 200 ft above the runway threshold. The objective of this requirement is to ensure that the pilot will have sufficient visual reference to land. The visual reference should be the same as that required for the same approach flown without the use of EFVS.

Some EFVSs may have additional requirements that have to be fulfilled at this height to allow the approach to continue, such as a requirement to check that elements of the EFVS display

remain correctly aligned and scaled to the external view. Any such requirements will be detailed in the AFM and included in the operator's procedures.

(i) Specific approval for EFVS

In order to use EFVS without natural visual reference below 200 ft above the threshold, the operator needs to hold a specific approval in accordance with Part-SPA.

(j) Go-around

A go-around will be promptly executed if the required visual references are not maintained on the EFVS image at any time after the aircraft has descended below the DA/H or if the required visual references are not distinctly visible and identifiable using natural vision after the aircraft is below 200 ft. It is considered more likely that an EFVS 200 operation could result in the initiation of a go-around below the DA/H than the equivalent approach flown without EFVS and thus the operational assessment required by [AMC1 SPO.OP.235\(a\)\(2\)](#) takes into account the possibility of a balked landing.

An obstacle free zone (OFZ) may also be provided for CAT I PA procedures. Where an OFZ is not provided for a CAT I precision approach, this will be indicated on the approach chart. NPA procedures and approach procedures with vertical guidance provide obstacle clearance for the missed approach based on the assumption that a go-around is executed at the MAPt and not below the MDH.

AMC1 SPO.OP.235(a)(1) EFVS 200 operations

ED Decision 2022/012/R

EQUIPMENT CERTIFICATION

For EFVS 200 operations, the aircraft should be equipped with an approach system using EFVS-A or a landing system using EFVS-L.

AMC1 SPO.OP.235(a)(2) EFVS 200 operations

ED Decision 2022/012/R

AERODROMES AND INSTRUMENT PROCEDURES SUITABLE FOR EFVS 200 OPERATIONS

- (a) For EFVS 200 operations, the operator should verify the suitability of a runway before authorising EFVS operations to that runway through an operational assessment taking into account the following elements:
- (1) the obstacle situation;
 - (2) the type of aerodrome lighting;
 - (3) the available IAPs;
 - (4) the aerodrome operating minima; and
 - (5) any non-standard conditions that may affect the operations.
- (b) EFVS 200 operations should only be conducted as 3D operations, using an IAP in which the final approach track is offset by a maximum of 3 degrees from the extended centre line of the runway.
- (c) The IAP should be designed in accordance with PANS-OPS, Volume I (ICAO Doc 8168) or equivalent criteria.

AMC2 SPO.OP.235(a)(2) EFVS 200 operations

ED Decision 2022/014/R

VERIFICATION OF THE SUITABILITY OF RUNWAYS FOR EFVS 200 OPERATIONS

The operational assessment before authorising the use of a runway for EFVS 200 operations may be conducted as follows:

- (a) Check whether the runway has been promulgated as suitable for EFVS 200 operations or is certified as a PA category II or III runway by the State of the aerodrome. If this is so, then check whether and where the approach and runway lights installed (notably incandescent or LED lights) are adequate for the EFVS equipment used by the operator.
- (b) If the check in point (a) above comes out negative (the runway is not promulgated as EFVS suitable or is not category II or III), then proceed as follows:
 - (1) For straight-in IAPs, US Standard for Terminal Instrument Procedures (TERPS) may be considered to be acceptable as an equivalent to PANS-OPS. If other design criteria than PANS-OPS or US TERPS are used, the operations should not be conducted.
 - (2) If an OFZ is established, this will ensure adequate obstacle protection from 960 m before the threshold. If an OFZ is not established or if the DH for the approach is above 250 ft, then check whether there is a visual segment surface (VSS).
 - (3) VSSs are required for procedures published after 15 March 2007, but the existence of the VSS has to be verified through an aeronautical information publication (AIP), operations manual Part C, or direct contact with the aerodrome. Where the VSS is established, it may not be penetrated by obstacles. If the VSS is not established or is penetrated by obstacles and an OFZ is not established, then the operations should not be conducted. Note: obstacles of a height of less than 50 ft above the threshold may be disregarded when assessing the VSS.
 - (4) Runways with obstacles that require visual identification and avoidance should not be accepted.
 - (5) For the obstacle protection of a balked landing where an OFZ is not established, the operator may specify that pilots follow a departure procedure in the event of a balked landing, in which case it is necessary to verify that the aircraft will be able to comply with the climb gradients published for the instrument departure procedures for the expected landing conditions.
 - (6) Perform an assessment of the suitability of the runway which should include whether the approach and runway lights installed (notably incandescent or LED lights) are adequate for the EFVS equipment used by the operator.
- (c) If the AFM stipulates specific requirements for approach procedures, then the operational assessment should verify that these requirements can be met.

AMC1 SPO.OP.235(a)(3) EFVS 200 operations

ED Decision 2022/012/R

INITIAL TRAINING FOR EFVS 200 OPERATIONS

Operators should ensure that flight crew members complete the following conversion training before being authorised to conduct EFVS operations unless credits related to training and checking for previous experience on similar aircraft types are defined in the operational suitability data established in accordance with [Regulation \(EU\) No 748/2012](#):

-
- (a) A course of ground training including at least the following:
- (1) characteristics and limitations of head-up displays (HUDs) or equivalent display systems including information presentation and symbology;
 - (2) EFVS sensor performance in different weather conditions, sensor limitations, scene interpretation, visual anomalies and other visual effects;
 - (3) EFVS display, control, modes, features, symbology, annunciations and associated systems and components;
 - (4) the interpretation of EFVS imagery;
 - (5) the interpretation of approach and runway lighting systems and display characteristics when using EFVS;
 - (6) pre-flight planning and selection of suitable aerodromes and approach procedures;
 - (7) principles of obstacle clearance requirements;
 - (8) the use and limitations of RVR assessment systems;
 - (9) normal, abnormal and emergency procedures for EFVS 200 operations;
 - (10) the effect of specific aircraft/system malfunctions;
 - (11) human factors aspects of EFVS 200 operations; and
 - (12) qualification requirements for pilots to obtain and retain approval for EFVS 200 operations.
- (b) A course of FSTD training and/or flight training in two phases as follows:
- (1) Phase one (EFVS 200 operations with aircraft and all equipment serviceable) — objectives:
 - (i) understand the operation of equipment required for EFVS 200 operations;
 - (ii) understand operating limitations of the installed EFVS;
 - (iii) practise the use of HUD or equivalent display systems;
 - (iv) practise the set-up and adjustment of EFVS equipment in different conditions (e.g. day and night);
 - (v) practise the monitoring of automatic flight control systems, EFVS information and status annunciators;
 - (vi) practise the interpretation of EFVS imagery;
 - (vii) become familiar with the features needed on the EFVS image to continue approach below the DH;
 - (viii) practise the identification of visual references using natural vision while using EFVS equipment;
 - (ix) master the manual aircraft handling relevant to EFVS 200 operations including, where appropriate, the use of the flare cue and guidance for landing;
 - (x) practise coordination with other crew members; and
 - (xi) become proficient at procedures for EFVS 200 operations.

- (2) Phase one of the training should include the following exercises:
 - (i) the required checks for satisfactory functioning of equipment, both on the ground and in flight;
 - (ii) the use of HUD or equivalent display systems during all phases of flight;
 - (iii) approach using the EFVSs installed on the aircraft to the appropriate DH and transition to visual flight and landing;
 - (iv) approach with all engines operating using the EFVS, down to the appropriate DH followed by a missed approach, all without external visual reference, as appropriate.
- (3) Phase two (EFVS 200 operations with aircraft and equipment failures and degradations) — objectives:
 - (i) understand the effect of known aircraft unserviceabilities including use of the MEL;
 - (ii) understand the effect of failed or downgraded equipment on aerodrome operating minima;
 - (iii) understand the actions required in response to failures and changes in the status of the EFVS including HUD or equivalent display systems;
 - (iv) understand the actions required in response to failures above and below the DH;
 - (v) practise abnormal operations and incapacitation procedures; and
 - (vi) become proficient at dealing with failures and abnormal situations during EFVS 200 operations.
- (4) Phase two of the training should include the following exercises:
 - (i) approaches with engine failures at various stages of the approach;
 - (ii) approaches with failures of the EFVS at various stages of the approach, including failures between the DH and the height below which an approach should not be continued if natural visual reference is not acquired, require either:
 - (A) reversion to head down displays to control missed approach; or
 - (B) reversion to flight with downgraded or no guidance to control missed approaches from the DH or below, including those which may result in a touchdown on the runway;
 - (iii) incapacitation procedures appropriate to EFVS 200 operations;
 - (iv) failures and procedures applicable to the specific EFVS installation and aircraft type; and
 - (v) FSTD training, which should include minimum eight approaches.

AMC2 SPO.OP.235(a)(3) EFVS 200 operations

ED Decision 2022/012/R

RECURRENT TRAINING AND CHECKING FOR EFVS 200 OPERATIONS

- (a) The operator should ensure that the pilots' competence to perform EFVS 200 operations. To do so, pilots should be trained every 6 months by performing at least two approaches on each type of aircraft operated.

- (b) The operator should ensure that the pilots' competence to perform EFVS 200 operations is checked at each required operator proficiency check by performing at least two approaches on each type of aircraft operated, of which one should be flown without natural vision to 200 ft.

AMC3 SPO.OP.235(a)(3) EFVS 200 operations

ED Decision 2022/012/R

RECENT EXPERIENCE REQUIREMENTS FOR EFVS 200 OPERATIONS

Pilots should complete a minimum of four approaches using the operator's procedures for EFVS 200 operations during the validity period of the periodic operator proficiency check unless credits related to currency are defined in the operational suitability data established in accordance with [Regulation \(EU\) No 748/2012](#).

AMC4 SPO.OP.235(a)(3) EFVS 200 operations

ED Decision 2022/012/R

DIFFERENCES TRAINING FOR EFVS 200 OPERATIONS

- (a) The operator should ensure that the flight crew members authorised to conduct EFVS 200 operations are provided with differences training or familiarisation whenever there is a change to any of the following:
- (1) the technology used in the flight guidance and flight control system;
 - (2) the HUD or equivalent display systems;
 - (3) the operating procedures.
- (b) The differences training should:
- (1) meet the objectives of the appropriate initial training course;
 - (2) take into account the flight crew members' previous experience; and
 - (3) take into account the operational suitability data established in accordance with [Regulation \(EU\) No 748/2012](#).

AMC5 SPO.OP.235(a)(3) EFVS 200 operations

ED Decision 2022/012/R

TRAINING FOR EFVS 200 OPERATIONS

If a flight crew member is to be authorised to operate as pilot flying and pilot monitoring during EFVS 200 operations, then the flight crew member should complete the required FSTD training for each operating capacity.

GM1 SPO.OP.235(a)(3) EFVS 200 operations

ED Decision 2022/012/R

RECURRENT CHECKING FOR EFVS 200 OPERATIONS

In order to provide the opportunity to practise decision-making in the event of system failures and failure to acquire natural visual reference, the recurrent training and checking for EFVS 200 operations is recommended to periodically include different combinations of equipment failures, go-around due to loss of visual reference, and landings.

AMC1 SPO.OP.235(a)(4) EFVS 200 operations

ED Decision 2022/012/R

OPERATING PROCEDURES FOR EFVS 200 OPERATIONS

- (a) For EFVS 200 operations, the following should apply:
- (1) the pilot flying should use the EFVS throughout the approach;
 - (2) in multi-pilot operations, a suitable display of EFVS sensory imagery should be provided to the pilot monitoring;
 - (3) the approach between the FAF and the DA/H should be flown using vertical flight path guidance;
 - (4) the approach may be continued below the DA/H provided that the pilot can identify on the EFVS image either:
 - (i) the approach light system; or
 - (ii) both of the following:
 - (A) the runway threshold identified by the beginning of the runway landing surface, the threshold lights or the runway end identifier lights; and
 - (B) the TDZ identified by the TDZ lights, the TDZ runway markings or the runway lights;
 - (5) a missed approach should be executed promptly if the required visual reference is not distinctly visible and identifiable to the pilot without reliance on the EFVS by 200 ft above the threshold.
- (b) Operating procedures for EFVS 200 operations should:
- (1) be consistent with the AFM;
 - (2) be appropriate to the technology and equipment to be used;
 - (3) specify the duties and responsibilities of each flight crew member in each relevant phase of flight;
 - (4) ensure that flight crew workload is managed to facilitate effective decision-making and monitoring of the aircraft; and
 - (5) deviate to the minimum extent practicable from normal procedures used for routine operations.
- (c) Operating procedures should include:
- (1) the required checks for the satisfactory functioning of the aircraft equipment, both before departure and in flight;
 - (2) the correct seating and eye position;
 - (3) determination of aerodrome operating minima;
 - (4) the required visual references at the DH;
 - (5) the action to be taken if natural visual reference is not acquired by 200 ft;
 - (6) the action to be taken in the event of loss of the required visual reference; and
 - (7) procedures for balked landing.

- (d) Operating procedures for EFVS 200 operations should be included in the operations manual.

AMC1 SPO.OP.235(a)(8) EFVS 200 operations

ED Decision 2022/012/R

AERODROME OPERATING MINIMA — EFVS 200 OPERATIONS

When conducting EFVS 200 operations:

- (a) the DA/H used should be the same as for operations without EFVS;
- (b) the lowest RVR minima to be used should be determined by reducing the RVR presented in:
 - (1) Table 8 in [AMC5 SPO.OP.110](#) in accordance with Table 1 below for aeroplanes;
 - (2) Table 12 of [AMC6 SPO.OP.110](#) in accordance with Table 1 below for helicopters;
- (c) in case of failed or downgraded equipment, Table 15 in [AMC9 SPO.OP.110](#) should apply.

Table 1

Operations utilising EFVS: RVR reduction

RVR (m) presented in Table 8 in AMC5 SPO.OP.110 or in Table 12 of AMC6 SPO.OP.110	RVR (m) for EFVS 200 operations
550	550
600	550
650	550
700	550
750	550
800	550
900	600
1 000	650
1 100	750
1 200	800
1 300	900
1 400	900
1 500	1 000
1 600	1 100
1 700	1 100
1 800	1 200
1 900	1 300
2 000	1 300
2 100	1 400
2 200	1 500
2 300	1 500
2 400	1 600

AMC1 SPO.OP.235(c) EFVS 200 operations

ED Decision 2022/012/R

EFVS 200 WITH LEGACY SYSTEMS UNDER AN APPROVAL

The EVS should be certified before 1 January 2022 as ‘EVS with an operational credit’.

GM1 SPO.OP.235(c) EFVS 200 operations

ED Decision 2022/012/R

The competent authority referred to in [SPO.OP.235](#) point (c) is the competent authority for the oversight of the operator, as established in [ORO.GEN.105](#).

SUBPART C: AIRCRAFT PERFORMANCE AND OPERATING LIMITATIONS

SPO.POL.100 Operating limitations – all aircraft

Regulation (EU) 2018/394

- (a) During any phase of operation, the loading, the mass and the centre of gravity (CG) position of the aircraft shall comply with any limitation specified in the appropriate manual.
- (b) Placards, listings, instrument markings, or combinations thereof, containing those operating limitations prescribed by the AFM for visual presentation, shall be displayed in the aircraft.

AMC1 SPO.POL.100 Operating Limitations – all aircraft

ED Decision 2014/018/R

APPROPRIATE MANUAL

The appropriate manual containing operating limitations may be the AFM or an equivalent document, or the operations manual, if more restrictive.

SPO.POL.105 Mass and balance

Regulation (EU) 2018/1975

- (a) The operator shall ensure that the mass and the CG of the aircraft have been established by actual weighing prior to the initial entry into service of the aircraft. The accumulated effects of modifications and repairs on the mass and balance shall be accounted for and properly documented. Such information shall be made available to the pilot-in-command. The aircraft shall be reweighed if the effect of modifications on the mass and balance is not accurately known.
- (b) The weighing shall be accomplished by the manufacturer of the aircraft or by an approved maintenance organisation.

GM1 SPO.POL.105 Mass and balance

ED Decision 2018/003/R

GENERAL — OPERATIONS WITH OTHER-THAN COMPLEX MOTOR-POWERED AIRCRAFT

- (a) New aircraft that have been weighed at the factory may be placed into operation without reweighing if the mass records and balance records have been adjusted for alterations or modifications to the aircraft. Aircraft transferred from one EU operator to another EU operator do not have to be weighed prior to use by the receiving operator unless the mass and balance cannot be accurately established by calculation.
- (b) The mass and the centre of gravity (CG) position of an aircraft should be revised whenever the cumulative changes to the dry operating mass exceed $\pm 0.5\%$ of the maximum landing mass or for aeroplanes the cumulative change in CG position exceeds 0.5% of the mean aerodynamic chord. This may be done by weighing the aircraft or by calculation. If the AFM requires to record changes to mass and CG position below these thresholds, or to record changes in any case, and make them known to the pilot-in-command, mass and CG position should be revised accordingly and made known to the pilot-in-command.

AMC1 SPO.POL.105(b) Mass and balance

ED Decision 2014/018/R

WEIGHING OF AN AIRCRAFT — OPERATIONS WITH COMPLEX MOTOR POWERED AIRCRAFT

- (a) New aircraft that have been weighed at the factory may be placed into operation without reweighing if the mass and balance records have been adjusted for alterations or modifications to the aircraft. Aircraft transferred from one EU operator to another EU operator do not have to be weighed prior to use by the receiving operator unless the mass and balance cannot be accurately established by calculation.
- (b) The mass and centre of gravity (CG) position of an aircraft should be revised whenever the cumulative changes to the dry operating mass exceed $\pm 0.5\%$ of the maximum landing mass or for aeroplanes the cumulative change in CG position exceeds 0.5% of the mean aerodynamic chord. This should be done either by weighing the aircraft or by calculation.
- (c) When weighing an aircraft, normal precautions should be taken, which are consistent with good practices such as:
 - (1) checking for completeness of the aircraft and equipment;
 - (2) determining that fluids are properly accounted for;
 - (3) ensuring that the aircraft is clean; and
 - (4) ensuring that weighing is accomplished in an enclosed building.
- (d) Any equipment used for weighing should be properly calibrated, zeroed and used in accordance with the manufacturer's instructions. Each scale should be calibrated either by the manufacturer, by a civil department of weights and measures or by an appropriately authorised organisation within 2 years or within a time period defined by the manufacturer of the weighing equipment, whichever is less. The equipment should enable the mass of the aircraft to be established accurately. One single accuracy criterion for weighing equipment cannot be given. However, the weighing accuracy is considered satisfactory if the accuracy criteria in Table 1 are met by the individual scales/cells of the weighing equipment used:

Table 1: Accuracy criteria for weighing equipment

For a scale/cell load	An accuracy of
below 2 000 kg	$\pm 1\%$
from 2 000 kg to 20 000 kg	± 20 kg
above 20 000 kg	$\pm 0.1\%$

CG LIMITS — OPERATIONAL CG ENVELOPE AND IN-FLIGHT CG

In the Certificate Limitations section of the AFM, forward and aft CG limits are specified. These limits ensure that the certification stability and control criteria are met throughout the whole flight and allow the proper trim setting for take-off. The operator should ensure that these limits are respected by:

- (a) defining and applying operational margins to the certified CG envelope in order to compensate for the following deviations and errors:
 - (1) deviations of actual CG at empty or operating mass from published values due, for example, to weighing errors, unaccounted modifications and/or equipment variations.
 - (2) Deviations in fuel distribution in tanks from the applicable schedule.

- (3) Deviations in the distribution of cargo in the various compartments as compared with the assumed load distribution as well as inaccuracies in the actual mass of cargo.
 - (5) Deviations of the actual CG of cargo load within individual cargo compartments or cabin sections from the normally assumed mid position.
 - (6) Deviations of the CG caused by gear and flap positions and by application of the prescribed fuel usage procedure, unless already covered by the certified limits.
 - (7) Deviations caused by in-flight movement of crew members and task specialist.
- (b) Defining and applying operational procedures in order to:
- (1) take into account any significant CG travel during flight caused by persons movement; and
 - (2) take into account any significant CG travel during flight caused by fuel consumption/transfer.

SPO.POL.110 Mass and balance system – commercial operations with aeroplanes and helicopters and non-commercial operations with complex motor-powered aircraft

Regulation (EU) 2021/1296

- (a) The operator shall establish a mass and balance system to determine for each flight or series of flights the following:
- (1) aircraft dry operating mass;
 - (2) mass of the traffic load;
 - (3) mass of the fuel/energy load;
 - (4) aircraft load and load distribution;
 - (5) take-off mass, landing mass, and zero fuel/energy mass; and
 - (6) applicable aircraft centre of gravity (CG) positions.
- (b) The flight crew shall be provided with a means of replicating and verifying any mass and balance computation based on electronic calculations.
- (c) The operator shall establish procedures to enable the pilot-in-command to determine the mass of the fuel/energy load by using the actual density or, if not known, the density calculated in accordance with a method specified in the operations manual.

AMC1 SPO.POL.110(a)(1) Mass and balance system – commercial operations with aeroplanes and helicopters and non-commercial operations with complex motor-powered aircraft

ED Decision 2014/018/R

DRY OPERATING MASS

The dry operating mass should include:

- (a) crew and equipment, and
- (b) removable task specialist equipment, if applicable.

AMC1 SPO.POL.110(a)(2) Mass and balance system – commercial operations with aeroplanes and helicopters and non-commercial operations with complex motor-powered aircraft

ED Decision 2014/018/R

SPECIAL STANDARD MASSES FOR TRAFFIC LOAD

The operator should use standard mass values for other load items. These standard masses should be calculated on the basis of a detailed evaluation of the mass of the items.

GM1 SPO.POL.110(a)(2) Mass and balance system – commercial operations with aeroplanes and helicopters and non-commercial operations with complex motor-powered aircraft

ED Decision 2014/018/R

TRAFFIC LOAD

Traffic load includes task specialists.

AMC1 SPO.POL.110(a)(3) Mass and balance system – commercial operations with aeroplanes and helicopters and non-commercial operations with complex motor-powered aircraft

ED Decision 2014/018/R

FUEL LOAD

The mass of the fuel load should be determined by using its actual relative density or a standard relative density.

GM1 SPO.POL.110(a)(3) Mass and balance system – commercial operations with aeroplanes and helicopters and non-commercial operations with complex motor-powered aircraft

ED Decision 2014/018/R

FUEL DENSITY

- (a) If the actual fuel density is not known, the operator may use standard fuel density values for determining the mass of the fuel load. Such standard values should be based on current fuel density measurements for the airports or areas concerned.
- (b) Typical fuel density values are:
 - (1) Gasoline (piston engine fuel) – 0.71 ;
 - (2) JET A1 (Jet fuel JP 1) – 0.79 ;
 - (3) JET B (Jet fuel JP 4) – 0.76 ;
 - (4) Oil – 0.88.

AMC1 SPO.POL.110(a)(4) Mass and balance system – commercial operations with aeroplanes and helicopters and non-commercial operations with complex motor-powered aircraft

ED Decision 2014/018/R

LOADING - STRUCTURAL LIMITS

The loading should take into account additional structural limits such as the floor strength limitations, the maximum load per running metre, the maximum mass per cargo compartment, and/or the maximum seating limits as well as in-flight changes in loading.

GM1 SPO.POL.110(b) Mass and balance system – commercial operations with aeroplanes and helicopters and non-commercial operations with complex motor-powered aircraft

ED Decision 2014/018/R

GENERAL

The mass and balance computation may be available in flight planning documents or separate systems and may include standard load profiles.

SPO.POL.115 Mass and balance data and documentation – commercial operations with aeroplanes and helicopters and non-commercial operations with complex motor-powered aircraft

Regulation (EU) 2021/1296

- (a) The operator shall establish mass and balance data and produce mass and balance documentation prior to each flight, or series of flights, specifying the load and its distribution in such a way that the mass and balance limits of the aircraft are not exceeded. The mass and balance documentation shall contain the following information:
- (1) aircraft registration and type;
 - (2) flight identification, number and date, as applicable;
 - (3) name of the pilot-in-command;
 - (4) name of the person who prepared the document;
 - (5) dry operating mass and the corresponding CG of the aircraft;
 - (6) mass of the fuel/energy at take-off and mass of trip fuel/energy;
 - (7) mass of consumables other than fuel/energy, if applicable;
 - (8) load components;
 - (9) take-off mass, landing mass, and zero fuel/energy mass;
 - (10) applicable aircraft CG positions; and
 - (11) the limiting mass and CG values.
- (b) Where mass and balance data and documentation is generated by a computerised mass and balance system, the operator shall verify the integrity of the output data.

AMC1 SPO.POL.115 Mass and balance data and documentation – commercial operations with aeroplanes and helicopters and non-commercial operations with complex motor-powered aircraft

ED Decision 2014/018/R

GENERAL

- (a) The mass and balance documentation should:
 - (1) enable the pilot-in-command to determine that the load and its distribution are within the mass and balance limits of the aircraft; and
 - (2) include advise to the pilot-in-command whenever a non-standard method has been used for determining the mass of the load.
- (b) The information above may be available in flight planning documents or mass and balance systems.
- (c) Any last minute change should be brought to the attention of the pilot-in-command and entered in the flight planning documents containing the mass and balance information and mass and balance systems.
- (d) Where mass and balance documentation is generated by a computerised mass and balance system, the operator should verify the integrity of the output data at intervals not exceeding six months.
- (e) A copy of the final mass and balance documentation may be sent to aircraft via data link or may be made available to the pilot-in-command by other means for its acceptance.
- (f) The person supervising the loading of the aircraft should confirm by hand signature or equivalent that the load and its distribution are in accordance with the mass and balance documentation given to the pilot in command. The pilot-in-command should indicate his acceptance by hand signature or equivalent.

GM1 SPO.POL.115 Mass and balance data and documentation – commercial operations with aeroplanes and helicopters and non-commercial operations with complex motor-powered aircraft

ED Decision 2014/018/R

SIGNATURE OR EQUIVALENT

Where a signature by hand is impracticable or it is desirable to arrange the equivalent verification by electronic means, as referred to in [AMC1 SPO.POL.115\(f\)](#), the following conditions should be applied in order to make an electronic signature the equivalent of a conventional hand-written signature:

- (a) electronic 'signing' by entering a personal identification number (PIN) code with appropriate security, etc.;
- (b) entering the PIN code generates a print-out of the individual's name and professional capacity on the relevant document(s) in such a way that it is evident, to anyone having a need for that information, who has signed the document;
- (c) the computer system logs information to indicate when and where each PIN code has been entered;

- (d) the use of the PIN code is, from a legal and responsibility point of view, considered to be fully equivalent to signature by hand;
- (e) the requirements for record keeping remain unchanged; and
- (f) all personnel concerned are made aware of the conditions associated with electronic signature and this is documented.

AMC1 SPO.POL.115(b) Mass and balance data and documentation – commercial operations with aeroplanes and helicopters and non-commercial operations with complex motor-powered aircraft

ED Decision 2014/018/R

INTEGRITY

The operator should verify the integrity of mass and balance data and documentation generated by a computerised mass and balance system, at intervals not exceeding six months. The operator should establish a system to check that amendments of its input data are incorporated properly in the system and that the system is operating correctly on a continuous basis.

AMC2 SPO.POL.115(b) Mass and balance data and documentation – commercial operations with aeroplanes and helicopters and non-commercial operations with complex motor-powered aircraft

ED Decision 2014/018/R

MASS AND BALANCE DOCUMENTATION SENT VIA DATA LINK

Whenever the mass and balance documentation is sent to the aircraft via data link, a copy of the final mass and balance documentation as accepted by the pilot-in-command should be available on the ground.

GM1 SPO.POL.115(b) Mass and balance data and documentation – commercial operations with aeroplanes and helicopters and non-commercial operations with complex motor-powered aircraft

ED Decision 2014/018/R

ON BOARD INTEGRATED MASS AND BALANCE COMPUTER SYSTEM

An on-board integrated mass and balance computer system may be an aircraft installed system capable of receiving input data either from other aircraft systems or from a mass and balance system on ground, in order to generate mass and balance data as an output.

GM2 SPO.POL.115(b) Mass and balance data and documentation – commercial operations with aeroplanes and helicopters and non-commercial operations with complex motor-powered aircraft

ED Decision 2014/018/R

STAND-ALONE COMPUTERISED MASS AND BALANCE SYSTEM

A stand-alone computerised mass and balance system may be a computer, either as part of an electronic flight bag (EFB) system or solely dedicated to mass and balance purposes, requiring input from the user, in order to generate mass and balance data as an output.

SPO.POL.116 Mass and balance data and documentation – alleviations

Regulation (EU) No 379/2014

Notwithstanding [SPO.POL.115\(a\)\(5\)](#), the CG position may not need not be on the mass and balance documentation, if the load distribution is in accordance with a pre-calculated balance table or if it can be shown that for the planned operations a correct balance can be ensured, whatever the real load is.

SPO.POL.120 Performance – general

Regulation (EU) No 379/2014

The pilot-in-command shall only operate the aircraft if the performance is adequate to comply with the applicable rules of the air and any other restrictions applicable to the flight, the airspace or the aerodromes or operating sites used, taking into account the charting accuracy of any charts and maps used.

SPO.POL.125 Take-off mass limitations – complex motor-powered aeroplanes

Regulation (EU) No 379/2014

The operator shall ensure that:

- (a) the mass of the aeroplane at the start of take-off shall not exceed the mass limitations:
 - (1) at take-off, as required in [SPO.POL.130](#);
 - (2) en-route with one engine inoperative (OEI), as required in [SPO.POL.135](#); and
 - (3) at landing, as required in [SPO.POL.140](#),allowing for expected reductions in mass as the flight proceeds, and for fuel jettisoning;
- (b) the mass at the start of take-off shall never exceed the maximum take-off mass specified in the AFM for the pressure altitude appropriate to the elevation of the aerodrome or operating site, and if used as a parameter to determine the maximum take-off mass, any other local atmospheric condition; and
- (c) the estimated mass for the expected time of landing at the aerodrome or operating site of intended landing and at any destination alternate aerodrome shall never exceed the maximum landing mass specified in the AFM for the pressure altitude appropriate to the elevation of those aerodromes or operating sites and if used as a parameter to determine the maximum landing mass, any other local atmospheric condition.

SPO.POL.130 Take-off – complex motor-powered aeroplanes

Regulation (EU) No 379/2014

- (a) When determining the maximum take-off mass, the pilot-in-command shall take the following into account:
- (1) the calculated take-off distance shall not exceed the take-off distance available with a clearway distance not exceeding half of the take-off run available;
 - (2) the calculated take-off run shall not exceed the take-off run available;
 - (3) a single value of V1 shall be used for the rejected and continued take-off, where a V1 is specified in the AFM; and
 - (4) on a wet or contaminated runway, the take-off mass shall not exceed that permitted for a take-off on a dry runway under the same conditions.
- (b) Except for an aeroplane equipped with turboprop engines and a maximum take-off mass at or below 5 700 kg, in the event of an engine failure during take-off, the pilot-in-command shall ensure that the aeroplane is able:
- (1) to discontinue the take-off and stop within the accelerate-stop distance available or the runway available; or
 - (2) to continue the take-off and clear all obstacles along the flight path by an adequate margin until the aeroplane is in a position to comply with [SPO.POL.135](#).

AMC1 SPO.POL.130(a) Take-off – complex motor-powered aeroplanes

ED Decision 2014/018/R

TAKE-OFF MASS

The following should be considered for determining the maximum take-off mass:

- (a) the pressure altitude at the aerodrome;
- (b) the ambient temperature at the aerodrome;
- (c) the runway surface condition and the type of runway surface;
- (d) the runway slope in the direction of take-off;
- (e) not more than 50 % of the reported head-wind component or not less than 150 % of the reported tailwind component; and
- (f) the loss, if any, of runway length due to alignment of the aeroplane prior to take-off.

AMC1 SPO.POL.130(a)(4) Take-off – complex motor-powered aeroplanes

ED Decision 2014/018/R

CONTAMINATED RUNWAY PERFORMANCE DATA

Wet and contaminated runway performance data, if made available by the manufacturer, should be taken into account. If such data is not made available, the operator should account for wet and contaminated runway conditions by using the best information available.

GM1 SPO.POL.130(a)(4) Take-off – complex motor-powered aeroplanes

ED Decision 2021/005/R

RUNWAY SURFACE CONDITION

Operation on runways contaminated with water, slush, snow or ice implies uncertainties with regard to runway friction and contaminant drag and therefore to the achievable performance and control of the aeroplane during take-off or landing, since the actual conditions may not completely match the assumptions on which the performance information is based. In the case of a contaminated runway, the first option for the pilot-in-command is to wait until the runway is cleared. If this is impracticable, he or she may consider a take-off or landing, provided that he or she has applied the applicable performance adjustments, and any further safety measures he or she considers justified under the prevailing conditions. The excess runway length available including the criticality of the overrun area should also be considered.

The determination of take-off performance data for wet and contaminated runways should be based on the reported runway surface condition in terms of contaminant and depth.

AMC1 SPO.POL.130(b)(2) Take-off – complex motor-powered aeroplanes

ED Decision 2014/018/R

ADEQUATE MARGIN

The adequate margin should be defined in the operations manual.

GM1 SPO.POL.130(b)(2) Take-off – complex motor-powered aeroplanes

ED Decision 2014/018/R

ADEQUATE MARGIN

`An adequate margin` is illustrated by the appropriate examples included in Attachment C to ICAO Annex 6, Part I.

SPO.POL.135 En-route – one engine inoperative – complex motor-powered aeroplanes

Regulation (EU) No 379/2014

The pilot-in-command shall ensure that in the event of an engine becoming inoperative at any point along the route, a multi-engined aeroplane shall be able to continue the flight to an adequate aerodrome or operating site without flying below the minimum obstacle clearance altitude at any point.

SPO.POL.140 Landing – complex motor-powered aeroplanes

Regulation (EU) No 379/2014

The pilot-in-command shall ensure that at any aerodrome or operating site, after clearing all obstacles in the approach path by a safe margin, the aeroplane shall be able to land and stop, or a seaplane to come to a satisfactory low speed, within the landing distance available. Allowance shall be made for

expected variations in the approach and landing techniques, if such allowance has not been made in the scheduling of performance data.

AMC1 SPO.POL.140 Landing – complex motor-powered aeroplanes

ED Decision 2014/018/R

GENERAL

The following should be considered to ensure that an aeroplane is able to land and stop, or a seaplane to come to a satisfactorily low speed, within the landing distance available:

- (a) the pressure altitude at the aerodrome;
- (b) the runway surface condition and the type of runway surface;
- (c) the runway slope in the direction of landing;
- (d) not more than 50 % of the reported head-wind component or not less than 150 % of the reported tailwind component;
- (e) use of the most favourable runway, in still air; and
- (f) use of the runway most likely to be assigned considering the probable wind speed and direction and the ground handling characteristics of the aeroplane, and considering other conditions such as landing aids and terrain.

AMC2 SPO.POL.140 Landing – complex motor-powered aeroplanes

ED Decision 2014/018/R

ALLOWANCES

Allowances should be stated in the operations manual.

GM1 SPO.POL.140 Landing – complex motor-powered aeroplanes

ED Decision 2021/005/R

WET AND CONTAMINATED RUNWAY DATA

The determination of landing performance data should be based on information provided in the OM on the reported RWYCC. The RWYCC is determined by the aerodrome operator using the RCAM and associated procedures defined in ICAO Doc 9981 'PANS Aerodromes'. The RWYCC is reported through an RCR in the SNOWTAM format in accordance with ICAO Annex 15.

SPO.POL.145 Performance and operating criteria – aeroplanes

Regulation (EU) No 379/2014

When operating an aeroplane at a height of less than 150 m (500 ft) above a non-congested area, for operations of aeroplanes that are not able to sustain level flight in the event of a critical engine failure, the operator shall:

- (a) establish operational procedures to minimise the consequences of an engine failure;
- (b) establish a training programme for crew members; and
- (c) ensure that all crew members and task specialists on board are briefed on the procedures to be carried out in the event of a forced landing.

AMC1 SPO.POL.145(a) and (b) Performance and operating criteria – aeroplanes, and AMC1 SPO.POL.146(b)(1) and (2) Performance and operating criteria – helicopters

ED Decision 2014/018/R

OPERATIONAL PROCEDURES AND TRAINING PROGRAMME

- (a) The operational procedures should be based on the manufacturer's recommended procedures where they exist.
- (b) The crew member training programme should include briefing, demonstration or practice, as appropriate, of the operational procedures necessary to minimise the consequences of an engine failure.

SPO.POL.146 Performance and operating criteria – helicopters

Regulation (EU) No 379/2014

- (a) The pilot-in-command may operate an aircraft over congested areas provided that:
 - (1) the helicopter is certified in category A or B; and
 - (2) safety measures are established to prevent undue hazard to persons or property on the ground and the operation and its SOP is authorised.
- (b) The operator shall:
 - (1) establish operational procedures to minimise the consequences of an engine failure;
 - (2) establish a training programme for crew members; and
 - (3) ensure that all crew members and task specialists on board are briefed on the procedures to be carried out in the event of a forced landing.
- (c) The operator shall ensure that the mass at take-off, landing or hover shall not exceed the maximum mass specified for:
 - (1) a hover out of ground effect (HOGE) with all engines operating at the appropriate power rating; or
 - (2) if conditions prevail that a HOGE is not likely to be established, the helicopter mass shall not exceed the maximum mass specified for a hover in ground effect (HIGE) with all engines operating at the appropriate power rating, provided prevailing conditions allow a hover in ground effect at the maximum specified mass.

AMC1 SPO.POL.146(c) Performance and operating criteria – helicopters

ED Decision 2014/018/R

MAXIMUM SPECIFIED MASSES

- (a) The operator should establish a procedure to determine maximum specified masses for HIGE and HOGE before each flight or series of flights.
- (b) This procedure should take into account ambient temperature at the aerodrome or operating site, pressure altitude and wind conditions data available.

GM1 SPO.POL.146(c) Performance and operating criteria – helicopters

ED Decision 2014/018/R

GENERAL

- (a) Even when the surface allows a hover in ground effect (HIGE), the likelihood of, for example, dust or blowing snow may necessitate hover out of ground effect (HOGE) performance.
- (b) Wind conditions on some sites (particularly in mountainous areas and including downdraft) may require a reduction in the helicopter mass in order to ensure that an out of ground effect hover can be achieved at the operational site in the conditions prevailing.

SUBPART D: INSTRUMENTS, DATA AND EQUIPMENT

SECTION 1 – AEROPLANES

SPO.IDE.A.100 Instruments and equipment – general

Regulation (EU) 2019/1384

- (a) Instruments and equipment required by this Subpart shall be approved in accordance with the applicable airworthiness requirements if they are:
- (1) used by the flight crew to control the flight path;
 - (2) used to comply with [SPO.IDE.A.215](#);
 - (3) used to comply with [SPO.IDE.A.220](#); or
 - (4) installed in the aeroplane.
- (b) The following items, when required under this Subpart, do not need an equipment approval:
- (1) spare fuses;
 - (2) independent portable lights;
 - (3) an accurate time piece;
 - (4) chart holder;
 - (5) first-aid kits;
 - (6) survival and signalling equipment;
 - (7) sea anchor and equipment for mooring;
 - (8) a simple PCDS used by a task specialist as a restraint device.
- (c) Instruments, equipment or accessories not required under this Annex (Part-SPO) as well as any other equipment which is not required under this Regulation, but carried on a flight, shall comply with the following requirements:
- (1) the information provided by those instruments, equipment or accessories shall not be used by the flight crew members to comply with Annex II to Regulation (EU) 2018/1139 or points [SPO.IDE.A.215](#) and [SPO.IDE.A.220](#) of this Annex;
 - (2) the instruments, equipment or accessories shall not affect the airworthiness of the aeroplane, even in the case of failures or malfunction.
- (d) Instruments and equipment shall be readily operable or accessible from the station where the flight crew member that needs to use it is seated.
- (e) Those instruments that are used by a flight crew member shall be so arranged as to permit the flight crew member to see the indications readily from his/her station, with the minimum practicable deviation from the position and line of vision which he/she normally assumes when looking forward along the flight path.
- (f) All required emergency equipment shall be easily accessible for immediate use.

GM1 SPO.IDE.A.100(a) Instruments and equipment – general

ED Decision 2014/018/R

APPLICABLE AIRWORTHINESS REQUIREMENTS

The applicable airworthiness requirements for approval of instruments and equipment required by this Part are the following:

- (a) Commission Regulation (EU) No 748/2012¹ for aeroplanes registered in the EU; and
- (b) Airworthiness requirements of the State of registry for aeroplanes registered outside the EU.

GM1 SPO.IDE.A.100(b) Instruments and equipment – general

ED Decision 2014/018/R

REQUIRED INSTRUMENTS AND EQUIPMENT THAT DO NOT NEED TO BE APPROVED IN ACCORDANCE WITH THE APPLICABLE AIRWORTHINESS REQUIREMENTS

The functionality of non-installed instruments and equipment required by this Subpart and that do not need an equipment approval, as listed in [SPO.IDE.A.100\(b\)](#), should be checked against recognised industry standards appropriate to the intended purpose. The operator is responsible for ensuring the maintenance of these instruments and equipment.

GM1 SPO.IDE.A.100(c) Instruments and equipment – general

ED Decision 2014/018/R

NOT REQUIRED INSTRUMENTS AND EQUIPMENT THAT DO NOT NEED TO BE APPROVED IN ACCORDANCE WITH THE APPLICABLE AIRWORTHINESS REQUIREMENTS, BUT ARE CARRIED ON A FLIGHT

- (a) The provision of this paragraph does not exempt any installed instrument or item of equipment from complying with the applicable airworthiness requirements. In this case, the installation should be approved as required in the applicable airworthiness requirements and should comply with the applicable Certification Specifications.
- (b) The failure of additional non-installed instruments or equipment not required by this Part or by the applicable airworthiness requirements or any applicable airspace requirements should not adversely affect the airworthiness and/or the safe operation of the aeroplane. Examples may be the following:
 - (1) portable electronic flight bag (EFB);
 - (2) portable electronic devices carried by crew members or task specialists; and
 - (3) non-installed task specialist equipment.

GM1 SPO.IDE.A.100(d) Instruments and equipment – general

ED Decision 2014/018/R

POSITIONING OF INSTRUMENTS

This requirement implies that whenever a single instrument is required in an aeroplane operated in a multi-crew environment, the instrument needs to be visible from each flight crew station.

¹ Commission Regulation (EU) No 748/2012 of 3 August 2012 laying down implementing rules for the airworthiness and environmental certification of aircraft and related products, parts and appliances, as well as for the certification of design and production organisations, (OJ L 224, 21.8.2012, p. 1).

SPO.IDE.A.105 Minimum equipment for flight

Regulation (EU) 2019/1384

A flight shall not be commenced when any of the aeroplane's instruments, items of equipment or functions required for the intended flight are inoperative or missing, unless either of the following conditions is fulfilled:

- (a) the aeroplane is operated in accordance with the minimum equipment list (MEL);
- (b) for complex motor-powered aeroplanes and for any aeroplane used in commercial operations, the operator is approved by the competent authority to operate the aeroplane within the constraints of the master minimum equipment list (MMEL) in accordance with point ORO.MLR.105(j) of Annex III;
- (c) the aeroplane is subject to a permit to fly issued in accordance with the applicable airworthiness requirements.

AMC1 SPO.IDE.A.105 Minimum equipment for flight

ED Decision 2021/005/R

MANAGEMENT OF THE STATUS OF CERTAIN INSTRUMENTS, EQUIPMENT OR FUNCTIONS

The operator should control and retain the status of the instruments, equipment or functions required for the intended operation, that are not controlled for the purpose of continuing airworthiness management.

GM1 SPO.IDE.A.105 Minimum equipment for flight

ED Decision 2021/005/R

MANAGEMENT OF THE STATUS OF CERTAIN INSTRUMENTS, EQUIPMENT OR FUNCTIONS

- (a) The operator should define responsibilities and procedures to retain and control the status of instruments, equipment or functions required for the intended operation, that are not controlled for the purpose of continuing airworthiness management.
- (b) Examples of such instruments, equipment or functions may be, but are not limited to, equipment related to navigation approvals as FM immunity or certain software versions.

SPO.IDE.A.110 Spare electrical fuses

Regulation (EU) No 379/2014

Aeroplanes shall be equipped with spare electrical fuses, of the ratings required for complete circuit protection, for replacement of those fuses that are allowed to be replaced in flight.

GM1 SPO.IDE.A.110 Spare electrical fuses

ED Decision 2014/018/R

FUSES

A spare electrical fuse means a replaceable fuse in the flight crew compartment, not an automatic circuit breaker or circuit breakers in the electric compartments.

SPO.IDE.A.115 Operating lights

Regulation (EU) No 379/2014

Aeroplanes operated at night shall be equipped with:

- (a) an anti-collision light system;
- (b) navigation/position lights;
- (c) a landing light;
- (d) lighting supplied from the aeroplane's electrical system to provide adequate illumination for all instruments and equipment essential to the safe operation of the aeroplane;
- (e) lighting supplied from the aeroplane's electrical system to provide illumination in all cabin compartments;
- (f) an independent portable light for each crew member station; and
- (g) lights to conform with the International Regulations for Preventing Collisions at Sea if the aeroplane is operated as a seaplane.

SPO.IDE.A.120 Operations under VFR – flight and navigational instruments and associated equipment

Regulation (EU) 2019/1384

- (a) Aeroplanes operated under VFR by day shall be equipped with a means of measuring and displaying the following:
 - (1) magnetic heading,
 - (2) time in hours, minutes and seconds,
 - (3) barometric altitude,
 - (4) indicated airspeed,
 - (5) Mach number whenever speed limitations are expressed in terms of Mach number, and
 - (6) slip for complex motor-powered aeroplanes.
- (b) Aeroplanes operating under VMC at night shall be, in addition to (a), equipped with:
 - (1) a means of measuring and displaying the following:
 - (i) turn and slip,
 - (ii) attitude,
 - (iii) vertical speed, and
 - (iv) stabilised heading;
 - (2) a means of indicating when the supply of power to the gyroscopic instruments is not adequate.
- (c) Complex motor-powered aeroplanes operating under VMC over water and out of sight of the land shall be, in addition to (a) and (b), equipped with a means of preventing malfunction of the airspeed indicating system due to condensation or icing.
- (d) Aeroplanes operated in conditions where they cannot be maintained in a desired flight path without reference to one or more additional instruments, shall be, in addition to (a) and (b),

equipped with a means of preventing malfunction of the airspeed indicating system required in (a)(4) due to condensation or icing.

- (e) Whenever two pilots are required for the operation, aeroplanes shall be equipped with an additional separate means of displaying the following:
- (1) barometric altitude,
 - (2) indicated airspeed,
 - (3) slip, or turn and slip, as applicable,
 - (4) attitude, if applicable,
 - (5) vertical speed, if applicable
 - (6) stabilised heading, if applicable, and
 - (7) Mach number whenever speed limitations are expressed in terms of Mach number, if applicable.

AMC1 SPO.IDE.A.120 & SPO.IDE.A.125 Operations under VFR & operations under IFR – flight and navigational instruments and associated equipment

ED Decision 2014/018/R

INTEGRATED INSTRUMENTS

- (a) Individual equipment requirements may be met by combinations of instruments, by integrated flight systems or by a combination of parameters on electronic displays. The information so available to each required pilot should not be less than that required in the applicable operational requirements, and the equivalent safety of the installation should be approved during type certification of the aeroplane for the intended type of operation.
- (b) The means of measuring and indicating turn and slip, aeroplane attitude and stabilised aeroplane heading may be met by combinations of instruments or by integrated flight director systems, provided that the safeguards against total failure, inherent in the three separate instruments, are retained.

AMC2 SPO.IDE.A.120 Operations under VFR – flight and navigational instruments and associated equipment

ED Decision 2014/018/R

LOCAL FLIGHTS

For flights that do not exceed 60 minutes' duration, that take off and land at the same aerodrome, and that remain within 50 NM of that aerodrome, an equivalent means of complying with [SPO.IDE.A.120\(b\)\(1\)\(i\)](#), (b)(1)(ii) may be:

- (a) a turn and slip indicator;
- (b) a turn co-ordinator; or
- (c) both an attitude indicator and a slip indicator.

GM1 SPO.IDE.A.120 Operations under VFR – flight and navigational instruments and associated equipment

ED Decision 2014/018/R

SLIP INDICATION

Non-complex motor-powered aeroplanes should be equipped with a means of measuring and displaying slip.

AMC1 SPO.IDE.A.120(a)(1) & SPO.IDE.A.125(a)(1) Operations under VFR & operations under IFR – flight and navigational instruments and associated equipment

ED Decision 2014/018/R

MEANS OF MEASURING AND DISPLAYING MAGNETIC HEADING

The means of measuring and displaying magnetic direction should be a magnetic compass or equivalent.

AMC1 SPO.IDE.A.120(a)(2) & SPO.IDE.A.125(a)(2) Operations under VFR & operations under IFR – flight and navigational instruments and associated equipment

ED Decision 2014/018/R

MEANS OF MEASURING AND DISPLAYING THE TIME — COMPLEX MOTOR-POWERED AIRCRAFT

An acceptable means of compliance is a clock displaying hours, minutes and seconds, with a sweep-second pointer or digital presentation.

MEANS OF MEASURING AND DISPLAYING THE TIME — OTHER-THAN COMPLEX MOTOR-POWERED AIRCRAFT

An acceptable means of measuring and displaying the time in hours, minutes and seconds may be a wrist watch capable of the same functions.

AMC1 SPO.IDE.A.120(a)(3) & SPO.IDE.A.125(a)(3) Operations under VFR operations & operations under IFR – flight and navigational instruments and associated equipment

ED Decision 2019/019/R

CALIBRATION OF THE MEANS OF MEASURING AND DISPLAYING PRESSURE ALTITUDE

The instrument measuring and displaying barometric altitude should be of a sensitive type calibrated in feet (ft), with a sub-scale setting, calibrated in hectopascals/millibars, adjustable for any barometric pressure likely to be set during flight.

AMC1 SPO.IDE.A.120(a)(4) & SPO.IDE.A.125(a)(4) Operations under VFR & operations under IFR – flight and navigational instruments and associated equipment

ED Decision 2015/006/R

CALIBRATION OF THE INSTRUMENT INDICATING AIRSPEED

- (a) The instrument indicating airspeed should be calibrated in knots (kt).
- (b) In the case of aeroplanes with a maximum certified take-off mass (MCTOM) below 2 000 kg, calibration in kilometres per hour (kph) or in miles per hour (mph) is acceptable when such units are used in the AFM.

AMC1 SPO.IDE.A.120(c) & SPO.IDE.A.125(d) Operations under VFR & operations under IFR – flight and navigational instruments and associated equipment

ED Decision 2014/018/R

MEANS OF PREVENTING MALFUNCTION DUE TO CONDENSATION OR ICING

The means of preventing malfunction due to either condensation or icing of the airspeed indicating system should be a heated pitot tube or equivalent.

AMC1 SPO.IDE.A.120(e) & SPO.IDE.A.125(c) Operations under VFR & operations under IFR – flight and navigational instruments and associated equipment

ED Decision 2014/018/R

MULTI-PILOT OPERATIONS – DUPLICATE INSTRUMENTS

Duplicate instruments include separate displays for each pilot and separate selectors or other associated equipment where appropriate.

SPO.IDE.A.125 Operations under IFR – flight and navigational instruments and associated equipment

Regulation (EU) 2019/1384

Aeroplanes operated under IFR shall be equipped with:

- (a) a means of measuring and displaying the following:
 - (1) magnetic heading,
 - (2) time in hours, minutes and seconds,
 - (3) barometric altitude,
 - (4) indicated airspeed,
 - (5) vertical speed,
 - (6) turn and slip,
 - (7) attitude,

- (8) stabilised heading,
 - (9) outside air temperature, and
 - (10) Mach number, whenever speed limitations are expressed in terms of Mach number;
- (b) a means of indicating when the supply of power to the gyroscopic instruments is not adequate.
- (c) whenever two pilots are required for the operation, an additional separate means of displaying for the second pilot:
- (1) barometric altitude,
 - (2) indicated airspeed,
 - (3) vertical speed,
 - (4) turn and slip,
 - (5) attitude,
 - (6) stabilised heading, and
 - (7) Mach number whenever speed limitations are expressed in terms of Mach number, if applicable;
- (d) a means of preventing malfunction of the airspeed indicating system required in (a)(4) and (c)(2) due to condensation or icing; and
- (e) complex motor-powered aeroplanes when operated under IFR shall, in addition to (a), (b), (c) and (d), be equipped with:
- (1) an alternate source of static pressure;
 - (2) a chart holder in an easily readable position that can be illuminated for night operations;
 - (3) a second independent means of measuring and displaying altitude unless already installed to comply with (e)(1); and
 - (4) an emergency power supply, independent of the main electrical generating system, for the purpose of operating and illuminating an attitude indicating system for a minimum period of 30 minutes. The emergency power supply shall be automatically operative after the total failure of the main electrical generating system and clear indication shall be given on the instrument or on the instrument panel that the attitude indicator is being operated by emergency power.

GM1 SPO.IDE.A.125 Operations under IFR – flight and navigational instruments and associated equipment

ED Decision 2014/018/R

ALTERNATE SOURCE OF STATIC PRESSURE

Aeroplanes should be equipped with an alternate source of static pressure.

GM1 SPO.IDE.A.125(a)(3) Operations under IFR – flight and navigational instruments and associated equipment

ED Decision 2014/018/R

ALTIMETERS

Altimeters with counter drum-pointer or equivalent presentation are considered to be less susceptible to misinterpretation for aeroplanes operating above 10 000 ft.

AMC1 SPO.IDE.A.125(a)(9) Operations under IFR – flight and navigational instruments and associated equipment

ED Decision 2014/018/R

MEANS OF DISPLAYING OUTSIDE AIR TEMPERATURE

- (a) The means of displaying outside air temperature should be calibrated in degrees Celsius.
- (b) In the case of aeroplanes with a maximum certified take-off mass (MCTOM) below 2 000 kg, calibration in degrees Fahrenheit is acceptable, when such unit is used in the AFM.
- (c) The means of displaying outside air temperature may be an air temperature indicator that provides indications that are convertible to outside air temperature.

AMC1 SPO.IDE.A.125(e)(2) Operations under IFR – flight and navigational instruments and associated equipment

ED Decision 2014/018/R

CHART HOLDER

An acceptable means of compliance with the chart holder requirement for complex motor-powered aeroplanes is to display a pre-composed chart on an electronic flight bag (EFB).

SPO.IDE.A.126 Additional equipment for single-pilot operation under IFR

Regulation (EU) No 379/2014

Complex motor-powered aeroplanes operated under IFR with a single pilot shall be equipped with an autopilot with at least altitude hold and heading mode.

SPO.IDE.A.130 Terrain awareness warning system (TAWS)

Regulation (EU) 2018/1042

- (a) Turbine-powered aeroplanes with a maximum certified take-off mass (MCTOM) of more than 5 700 kg or an MOPSC of more than nine shall be equipped with a TAWS that meets the requirements for:
 - (1) class A equipment, as specified in an acceptable standard, in the case of aeroplanes for which the individual certificate of airworthiness (CofA) was first issued after 1 January 2011; or
 - (2) class B equipment, as specified in an acceptable standard, in the case of aeroplanes for which the individual CofA was first issued on or before 1 January 2011.

- (b) When used in commercial operations, turbine-powered aeroplanes for which the individual CofA was first issued after 1 January 2019 and having an MCTOM of 5 700 kg or less and an MOPSC of six to nine shall be equipped with a TAWS that meets the requirements for class B equipment, as specified in an acceptable standard.

AMC1 SPO.IDE.A.130 Terrain awareness warning system (TAWS)

ED Decision 2014/018/R

EXCESSIVE DOWNWARDS GLIDESLOPE DEVIATION WARNING FOR CLASS A TAWS

The requirement for a Class A TAWS to provide a warning to the flight crew for excessive downwards glideslope deviation should apply to all final approach glideslopes with angular vertical navigation (VNAV) guidance, whether provided by the instrument landing system (ILS), microwave landing system (MLS), satellite-based augmentation system approach procedure with vertical guidance (SBAS APV (localiser performance with vertical guidance approach LPV)), ground-based augmentation system (GBAS (GPS landing system, GLS)) or any other systems providing similar guidance. The same requirement should not apply to systems providing vertical guidance based on barometric VNAV.

GM1 SPO.IDE.A.130 Terrain awareness warning system (TAWS)

ED Decision 2014/018/R

ACCEPTABLE STANDARD FOR TAWS

An acceptable standard for Class A and Class B TAWS may be the applicable European Technical Standards Order (ETSO) issued by the Agency or equivalent.

SPO.IDE.A.131 Airborne collision avoidance system (ACAS II)

Regulation (EU) No 379/2014

Unless otherwise provided for by Regulation (EU) No 1332/2011, turbine-powered aeroplanes with an MCTOM of more than 5 700 kg shall be equipped with ACAS II.

SPO.IDE.A.132 Airborne weather detecting equipment – complex motor-powered aeroplanes

Regulation (EU) No 379/2014

The following aeroplanes shall be equipped with airborne weather detecting equipment when operated at night or in IMC in areas where thunderstorms or other potentially hazardous weather conditions, regarded as detectable with airborne weather detecting equipment, may be expected to exist along the route:

- (a) pressurised aeroplanes;
- (b) non-pressurised aeroplanes with an MCTOM of more than 5 700 kg.

AMC1 SPO.IDE.A.132 Airborne weather detecting equipment – complex motor-powered aeroplanes

ED Decision 2014/018/R

GENERAL

The airborne weather detecting equipment should be an airborne weather radar. However, for propeller-driven pressurised aeroplanes with an MCTOM not more than 5 700 kg and an maximum

certified seating configuration of not more than nine, other equipment capable of detecting thunderstorms and other potentially hazardous weather conditions, regarded as detectable with airborne weather radar equipment, are also acceptable.

SPO.IDE.A.133 Additional equipment for operations in icing conditions at night – complex motor-powered aeroplanes

Regulation (EU) No 379/2014

- (a) Aeroplanes operated in expected or actual icing conditions at night shall be equipped with a means to illuminate or detect the formation of ice.
- (b) The means to illuminate the formation of ice shall not cause glare or reflection that would handicap flight crew members in the performance of their duties.

SPO.IDE.A.135 Flight crew interphone system

Regulation (EU) No 379/2014

Aeroplanes operated by more than one flight crew member shall be equipped with a flight crew interphone system, including headsets and microphones for use by all flight crew members.

AMC1 SPO.IDE.A.135 Flight crew interphone system

ED Decision 2014/018/R

TYPE OF FLIGHT CREW INTERPHONE

The flight crew interphone system should not be of a handheld type.

SPO.IDE.A.140 Cockpit voice recorder

- (a) The following aeroplanes shall be equipped with a CVR:
 - (1) aeroplanes with an MCTOM of more than 27 000 kg and first issued with an individual CofA on or after 1 January 2016; and
 - (2) aeroplanes with an MCTOM of more than 2 250 kg:
 - (i) certified for operation with a minimum crew of at least two pilots;
 - (ii) equipped with turbojet engine(s) or more than one turboprop engine; and
 - (iii) for which a type certificate is first issued on or after 1 January 2016.
- (b) The CVR shall be capable of retaining data recorded during at least:
 - (1) the preceding 25 hours for aeroplanes with an MCTOM of more than 27 000 kg and first issued with an individual CofA on or after 1 January 2022; or
 - (2) the preceding 2 hours in all other cases.
- (c) The CVR shall record with reference to a timescale:
 - (1) voice communications transmitted from or received in the flight crew compartment by radio;
 - (2) flight crew members' voice communications using the interphone system and the public address system, if installed;

- (3) the aural environment of the flight crew compartment, including, without interruption, the audio signals received from each boom and mask microphone in use; and
 - (4) voice or audio signals identifying navigation or approach aids introduced into a headset or speaker.
- (d) The CVR shall start automatically to record prior to the aeroplane moving under its own power and shall continue to record until the termination of the flight when the aeroplane is no longer capable of moving under its own power.
- (e) In addition to (d), depending on the availability of electrical power, the CVR shall start to record as early as possible during the cockpit checks prior to engine start at the beginning of the flight until the cockpit checks immediately following engine shutdown at the end of the flight.
- (f) If the CVR is not deployable, it shall have a device to assist in locating it under water. By 1 January 2020 at the latest, this device shall have a minimum underwater transmission time of 90 days. If the CVR is deployable, it shall have an automatic emergency locator transmitter.

AMC1 SPO.IDE.A.140 Cockpit voice recorder

ED Decision 2015/021/R

GENERAL

- (a) The operational performance requirements for cockpit voice recorders (CVRs) should be those laid down in the European Organisation for Civil Aviation Equipment (EUROCAE) Document ED-112 (Minimum Operational Performance Specification for Crash Protected Airborne Recorder Systems), dated March 2003, including Amendments n°1 and n°2, or any later equivalent standard produced by EUROCAE.
- (b) The operational performance requirements for equipment dedicated to the CVR should be those laid down in the European Organisation for Civil Aviation Equipment (EUROCAE) Document ED-56A (Minimum Operational Performance Requirements For Cockpit Voice Recorder Systems) dated December 1993, or EUROCAE Document ED-112 (Minimum Operational Performance Specification for Crash Protected Airborne Recorder Systems) dated March 2003, including Amendments n°1 and n°2, or any later equivalent standard produced by EUROCAE.

SPO.IDE.A.145 Flight data recorder

Regulation (EU) 2015/2338

- (a) Aeroplanes with an MCTOM of more than 5 700 kg and first issued with an individual CofA on or after 1 January 2016 shall be equipped with an FDR that uses a digital method of recording and storing data and for which a method of readily retrieving that data from the storage medium is available.
- (b) The FDR shall record the parameters required to determine accurately the aeroplane flight path, speed, attitude, engine power, configuration and operation and be capable of retaining data recorded during at least the preceding 25 hours.
- (c) Data shall be obtained from aeroplane sources that enable accurate correlation with information displayed to the flight crew.
- (d) The FDR shall start automatically to record the data prior to the aeroplane being capable of moving under its own power and shall stop automatically after the aeroplane is incapable of moving under its own power.

- (e) If the FDR is not deployable, it shall have a device to assist in locating it under water. By 1 January 2020 at the latest, this device shall have a minimum underwater transmission time of 90 days. If the FDR is deployable, it shall have an automatic emergency locator transmitter.

AMC1 SPO.IDE.A.145 Flight data recorder

ED Decision 2016/012/R

OPERATIONAL PERFORMANCE REQUIREMENTS FOR AEROPLANES FIRST ISSUED WITH AN INDIVIDUAL CofA ON OR AFTER 1 JANUARY 2016 AND BEFORE 1 JANUARY 2023

- (a) The operational performance requirements for flight data recorders (FDRs) should be those laid down in EUROCAE Document ED-112 (Minimum Operational Performance Specification for Crash Protected Airborne Recorder Systems) dated March 2003, including Amendments No 1 and No 2, or any later equivalent standard produced by EUROCAE.
- (b) The flight data recorder should record, with reference to a timescale, the list of parameters in Table 1 and Table 2, as applicable.
- (c) The parameters to be recorded should meet the performance specifications (designated ranges, sampling intervals, accuracy limits and minimum resolution in read-out) as defined in the relevant tables of EUROCAE Document ED-112 (Minimum Operational Performance Specification for Crash Protected Airborne Recorder Systems), dated March 2003, including Amendments No 1 and No 2, or any later equivalent standard produced by EUROCAE.

Table 1: All Aeroplanes

No [*]	Parameter
1a	Time; or
1b	Relative time count
1c	Global navigation satellite system (GNSS) time synchronisation
2	Pressure altitude
3	Indicated airspeed; or calibrated airspeed
4	Heading (primary flight crew reference) — when true or magnetic heading can be selected, the primary heading reference, a discrete indicating selection, should be recorded
5	Normal acceleration
6	Pitch attitude
7	Roll attitude
8	Manual radio transmission keying and CVR/FDR synchronisation reference.
9	Engine thrust/power
9a	Parameters required to determine propulsive thrust/power on each engine
9b	Flight crew compartment thrust/power lever position for aeroplanes with no mechanical link between engine and flight crew compartment))
14	Total or outside air temperature
16	Longitudinal acceleration (body axis)
17	Lateral acceleration
18	Primary flight control surface and/or primary flight control pilot input (for aeroplanes with control systems in which movement of a control surface will back drive the pilot's control, 'or' applies. For aeroplanes with control systems in which movement of a control surface will not back drive the pilot's control, 'and' applies. For multiple or split surfaces, a suitable combination of inputs is acceptable instead of recording each surface separately. For aeroplanes that have a flight control break-away capability that allows either pilot to operate the controls independently, record both inputs):
18a	Pitch axis

No*	Parameter
18b	Roll axis
18c	Yaw axis
19	Pitch trim surface position
23	Marker beacon passage
24	Warnings - in addition to the master warning each 'red' warning (including smoke warnings from other compartments) should be recorded when the warning condition cannot be determined from other parameters or from the CVR
25	Each navigation receiver frequency selection
27	Air-ground status. Air-ground status and a sensor of each landing gear if installed

* The number in the left hand column reflects the serial number depicted in EUROCAE ED-112.

Table 2: Aeroplanes for which the data source for the parameter is either used by aeroplane systems or is available on the instrument panel for use by the flight crew to operate the aeroplane

No*	Parameter
10	Flaps
10a	Trailing edge flap position
10b	Flight crew compartment control selection
11	Slats
11a	Leading edge flap (slat) position
11b	Flight crew compartment control selection
12	Thrust reverse status
13	Ground spoiler and speed brake:
13a	Ground spoiler position
13b	Ground spoiler selection
13c	Speed brake position
13d	Speed brake selection
15	Autopilot, autothrottle, automatic flight control system (AFCS) mode and engagement status
20	Radio altitude. For autoland/Category III operations, each radio altimeter should be recorded.
21	Vertical deviation – the approach aid in use should be recorded. For autoland/Category III operations, each system should be recorded.
21a	ILS/GPS/GLS glide path
21b	MLS elevation
21c	Integrated approach navigation (IAN)/integrated area navigation (IRNAV), vertical deviation
22	Horizontal deviation — the approach aid in use should be recorded. For autoland/CAT III operations, each system should be recorded. It is acceptable to arrange them so that at least one is recorded every second).
22a	ILS/GPS/GLS localiser
22b	MLS azimuth
22c	GNSS approach path/IRNAV lateral deviation
26	Distance measuring equipment (DME) 1 and 2 distances
26a	Distance to runway threshold(GLS)
26b	Distance to missed approach point (IRNAV/IAN)
28	Ground proximity warning system (GPWS)/TAWS/ground collision avoidance system (GCAS) status:
28a	Selection of terrain display mode, including pop-up display status
28b	Terrain alerts, including cautions and warnings and advisories
28c	On/off switch position
29	Angle of attack
30	Low pressure warning (each system):
30a	Hydraulic pressure

No*	Parameter
30b	Pneumatic pressure
31	Ground speed
32	Landing gear:
32a	Landing gear position
32b	Gear selector position
33	Navigation data:
33a	Drift angle
33b	Wind speed
33c	Wind direction
33d	Latitude
33e	Longitude
33f	GNSS augmentation in use
34	Brakes:
34a	Left and right brake pressure
34b	Left and right brake pedal position
35	Additional engine parameters (if not already recorded in parameter 9 of Table 1 of AMC1 SPO.IDE.A.145 and if the aeroplane is equipped with a suitable data source):
35a	Engine pressure ratio (EPR)
35b	N ₁
35c	Indicated vibration level
35d	N ₂
35e	Exhaust gas temperature (EGT)
35f	Fuel flow
35g	Fuel cut-off lever position
35h	N ₃
36	Traffic alert and collision avoidance system (TCAS)/ACAS - a suitable combination of discretes should be recorded to determine the status of the system:
36a	Combined control
36b	Vertical control
36c	Up advisory
36d	Down advisory
36e	Sensitivity level
37	Wind shear warning
38	Selected barometric setting
38a	Pilot
38b	Co-pilot
39	Selected altitude (all pilot selectable modes of operation) — to be recorded for the aeroplane where the parameter is displayed electronically
40	Selected speed (all pilot selectable modes of operation) — to be recorded for the aeroplane where the parameter is displayed electronically
41	Selected Mach (all pilot selectable modes of operation) — to be recorded for the aeroplane where the parameter is displayed electronically
42	Selected vertical speed (all pilot selectable modes of operation) — to be recorded for the aeroplane where the parameter is displayed electronically
43	Selected heading (all pilot selectable modes of operation) — to be recorded for the aeroplane where the parameter is displayed electronically
44	Selected flight path (All pilot selectable modes of operation) — to be recorded for the aeroplane where the parameter is displayed electronically:
44a	Course/desired track (DSTRK)
44b	Path angle
44c	Coordinates of final approach path (IRNAV/IAN)

No*	Parameter
45	Selected decision height — to be recorded for the aeroplane where the parameter is displayed electronically
46	Electronic flight instrument system (EFIS) display format:
46a	Pilot
46b	Co-pilot
47	Multi-function/engine/alerts display format
48	AC electrical bus status — each bus
49	DC electrical bus status — each bus
50	Engine bleed valve position
51	Auxiliary power unit (APU) bleed valve position
52	Computer failure — (all critical flight and engine control systems)
53	Engine thrust command
54	Engine thrust target
55	Computed centre of gravity (CG)
56	Fuel quantity in CG trim tank
57	Head-up display in use
58	Para visual display on
59	Operational stall protection, stick shaker and pusher activation
60	Primary navigation system reference:
60a	GNSS
60b	Inertial navigational system (INS)
60c	VHF omnidirectional radio range (VOR)/DME
60d	MLS
60e	Loran C
60f	ILS
61	Ice detection
62	Engine warning — each engine vibration
63	Engine warning — each engine over temperature
64	Engine warning — each engine oil pressure low
65	Engine warning — each engine over speed
66	Yaw trim surface position
67	Roll trim surface position
68	Yaw or sideslip angle
69	De-icing and/or anti-icing systems selection
70	Hydraulic pressure — each system
71	Loss of cabin pressure
72	Trim control input position in the flight crew compartment, pitch — when mechanical means for control inputs are not available, displayed trim position or trim command should be recorded
73	Trim control input position in the flight crew compartment, roll — when mechanical means for control inputs are not available, displayed trim position or trim command should be recorded
74	Trim control input position in the flight crew compartment, yaw — when mechanical means for control inputs are not available, displayed trim position or trim command should be recorded
75	All flight control input forces (for fly-by-wire flight control systems, where control surface position is a function of the displacement of the control input device only, it is not necessary to record this parameter):
75a	Control wheel
75b	Control column
75c	Rudder pedal

No*	Parameter
76	Event marker
77	Date
78	Actual navigation performance (ANP) or estimate of position error (EPE) or estimate of position uncertainty (EPU)

* The number in the left hand column reflects the serial number depicted in EUROCAE ED-112.

AMC2 SPO.IDE.A.145 Flight data recorder

ED Decision 2021/005/R

OPERATIONAL PERFORMANCE REQUIREMENTS FOR AEROPLANES FIRST ISSUED WITH AN INDIVIDUAL CofA ON OR AFTER 1 JANUARY 2023

- (a) The operational performance requirements for flight data recorders (FDRs) should be those laid down in EUROCAE Document 112A (Minimum Operational Performance Specification for Crash Protected Airborne Recorder Systems) dated September 2013, or any later equivalent standard produced by EUROCAE.
- (b) The FDR should, with reference to a timescale, record:
 - (1) the list of parameters in Table 1 below;
 - (2) the additional parameters listed in Table 2 below, when the information data source for the parameter is used by aeroplane systems or is available on the instrument panel for use by the flight crew to operate the aeroplane; and
 - (3) any dedicated parameters related to novel or unique design or operational characteristics of the aeroplane as determined by the Agency.
- (c) The parameters to be recorded should meet the performance specifications (range, sampling intervals, accuracy limits and resolution in read-out) as defined in the relevant tables of EUROCAE Document 112A, or any later equivalent standard produced by EUROCAE.

Table 1: FDR — all aeroplanes

No*	Parameter
1a	Time; or
1b	Relative time count
1c	Global navigation satellite system (GNSS) time synchronisation
2	Pressure altitude (including altitude values displayed on each flight crew member's primary flight display, unless the aeroplane is type certified before 1 January 2023 and recording the values displayed at the captain position or the first officer position would require extensive modification)
3	Indicated airspeed or calibrated airspeed (including values of indicated airspeed or calibrated airspeed displayed on each flight crew member's primary flight display, unless the aeroplane is type certified before 1 January 2023 and recording the values displayed at the captain position or the first officer position would require extensive modification)
4	Heading (primary flight crew reference) — when true or magnetic heading can be selected, the primary heading reference, a discrete indicating selection should be recorded
5	Normal acceleration
6	Pitch attitude — pitch attitude values displayed on each flight crew member's primary flight display should be recorded, unless the aeroplane is type certified before 1 January 2023 and recording the values displayed at the captain position or the first officer position would require extensive modification.

7	Roll attitude — roll attitude values displayed on each flight crew member’s primary flight display should be recorded, unless the aeroplane is type certified before 1 January 2023 and recording the values displayed at the captain position or the first officer position would require extensive modification.
8	Manual radio transmission keying and CVR/FDR synchronisation reference
9	Engine thrust/power:
9a	Parameters required to determine propulsive thrust/power on each engine, in both normal and reverse thrust
9b	Flight crew compartment thrust/power lever position (for aeroplanes with non-mechanically linked engine controls in the flight crew compartment)
14	Total or outside air temperature
16	Longitudinal acceleration (body axis)
17	Lateral acceleration
18	Primary flight control surface and/or primary flight control pilot input (For aeroplanes with control systems in which the movement of a control surface will back drive the pilot’s control, ‘or’ applies. For aeroplanes with control systems in which the movement of a control surface will not back drive the pilot’s control, ‘and’ applies. For multiple or split surfaces, a suitable combination of inputs is acceptable in lieu of recording each surface separately. For aeroplanes that have a flight control break-away capability that allows either pilot to operate the controls independently, record both inputs):
18a	Pitch axis
18b	Roll axis
18c	Yaw axis
19	Pitch trim surface position
23	Marker beacon passage
24	Warnings — in addition to the master warning, each ‘red’ warning that cannot be determined from other parameters or from the CVR and each smoke warning from other compartments should be recorded.
25	Each navigation receiver frequency selection
27	Air–ground status. Air–ground status and a sensor of each landing gear if installed

* The number in the left-hand column reflects the serial number depicted in EUROCAE Document 112A.

Table 2: FDR — Aeroplanes for which the data source for the parameter is either used by the aeroplane systems or is available on the instrument panel for use by the flight crew to operate the aeroplane

No*	Parameter
10	Flaps:
10a	Trailing edge flap position
10b	Flight crew compartment control selection
11	Slats:
11a	Leading edge flap (slat) position
11b	Flight crew compartment control selection
12	Thrust reverse status
13	Ground spoiler and speed brake:
13a	Ground spoiler position
13b	Ground spoiler selection
13c	Speed brake position
13d	Speed brake selection
15	Autopilot, autothrottle and automatic flight control system (AFCS): mode and engagement status (showing which systems are engaged and which primary modes are controlling the flight path and speed of the aircraft)

No*	Parameter
20	Radio altitude. For auto-land/category III operations, each radio altimeter should be recorded.
21	Vertical deviation — the approach aid in use should be recorded. For auto-land/category III operations, each system should be recorded:
21a	ILS/GPS/GLS glide path
21b	MLS elevation
21c	Integrated approach navigation (IAN)/Integrated Area Navigation (IRNAV), vertical deviation
22	Horizontal deviation — the approach aid in use should be recorded. For auto-land/category III operations, each system should be recorded:
22a	ILS/GPS/GLS localiser
22b	MLS azimuth
22c	Integrated approach navigation (IAN) /Integrated Area Navigation IRNAV lateral deviation, vertical deviation
26	Distance measuring equipment (DME) 1 and 2 distances:
26a	Distance to runway threshold (GLS)
26b	Distance to missed approach point (IRNAV/IAN)
28	Ground proximity warning system (GPWS)/terrain awareness warning system (TAWS)/ground collision avoidance system (GCAS) status — a suitable combination of discrettes unless recorder capacity is limited in which case a single discrete for all modes is acceptable:
28a	Selection of terrain display mode, including pop-up display status
28b	Terrain alerts, including cautions and warnings and advisories
28c	On/off switch position
29	Angle of attack
30	Low pressure warning (each system):
30a	Hydraulic pressure
30b	Pneumatic pressure
31	Ground speed
32	Landing gear:
32a	Landing gear position
32b	Gear selector position
33	Navigation data:
33a	Drift angle
33b	Wind speed
33c	Wind direction
33d	Latitude
33e	Longitude
33f	GNSS augmentation in use
34	Brakes:
34a	Left and right brake pressure
34b	Left and right brake pedal position
35	Additional engine parameters (if not already recorded in Parameter 9 of Table 1, and if the aeroplane is equipped with a suitable data source):
35a	Engine pressure ratio (EPR)
35b	N1
35c	Indicated vibration level
35d	N2
35e	Exhaust gas temperature (EGT)
35f	Fuel flow
35g	Fuel cut-off lever position
35h	N3
35i	

No*	Parameter
	Engine fuel metering valve position (or equivalent parameter from the system that directly controls the flow of fuel into the engine) — for aeroplanes type certified before 1 January 2023, to be recorded only if this does not require extensive modification.
36	Traffic alert and collision avoidance system (TCAS)/airborne collision avoidance system (ACAS) — a suitable combination of discretés should be recorded to determine the status of the system:
36a	Combined control
36b	Vertical control
36c	Up advisory
36d	Down advisory
36e	Sensitivity level
37	Wind shear warning
38	Selected barometric setting — to be recorded for the aeroplane where the parameter is displayed electronically:
38a	Pilot selected barometric setting
38b	Co-pilot selected barometric setting
39	Selected altitude (all pilot selectable modes of operation) — to be recorded for the aeroplane where the parameter is displayed electronically
40	Selected speed (all pilot selectable modes of operation) — to be recorded for the aeroplane where the parameter is displayed electronically
41	Selected Mach (all pilot selectable modes of operation) — to be recorded for the aeroplane where the parameter is displayed electronically
42	Selected vertical speed (all pilot selectable modes of operation) — to be recorded for the aeroplane where the parameter is displayed electronically
43	Selected heading (all pilot selectable modes of operation) — to be recorded for the aeroplane where the parameter is displayed electronically
44	Selected flight path (all pilot selectable modes of operation) — to be recorded for the aeroplane where the parameter is displayed electronically:
44a	Course/desired track (DSTRK)
44b	Path angle
44c	Coordinates of final approach path (IRNAV/IAN)
45	Selected decision height — to be recorded for the aeroplane where the parameter is displayed electronically
46	Electronic flight instrument system (EFIS) display format, showing the display system status:
46a	Pilot
46b	Co-pilot
47	Multi-function/engine/alerts display format, showing the display system status
48	Alternating current (AC) electrical bus status — each bus
49	Direct current (DC) electrical bus status — each bus
50	Engine bleed valve(s) position
51	Auxiliary power unit (APU) bleed valve(s) position
52	Computer failure — all critical flight and engine control systems
53	Engine thrust command
54	Engine thrust target
55	Computed centre of gravity (CG)
56	Fuel quantity in CG trim tank
57	Head-up display in use
58	Paravisual display on
59	Operational stall protection, stick shaker and pusher activation
60	Primary navigation system reference:

No*	Parameter
60a	GNSS
60b	Inertial navigational system (INS)
60c	VHF omnidirectional radio range (VOR)/distance measuring equipment (DME)
60d	MLS
60e	Loran C
60f	ILS
61	Ice detection
62	Engine warning — each engine vibration
63	Engine warning — each engine over temperature
64	Engine warning — each engine oil pressure low
65	Engine warning — each engine overspeed
66	Yaw trim surface position
67	Roll trim surface position
68	Yaw or sideslip angle
69	De-icing and/or anti-icing systems selection
70	Hydraulic pressure — each system
71	Loss of cabin pressure
72	Trim control input position in the flight crew compartment, pitch — when mechanical means for control inputs are not available, displayed trim position or trim command should be recorded.
73	Trim control input position in the flight crew compartment, roll — when mechanical means for control inputs are not available, displayed trim position or trim command should be recorded.
74	Trim control input position in the flight crew compartment, yaw — when mechanical means for control inputs are not available, displayed trim position or trim command should be recorded.
75	All flight control input forces (for fly-by-wire flight control systems, where control surface position is a function of the displacement of the control input device only, it is not necessary to record this parameter):
75a	Control wheel input forces
75b	Control column input forces
75c	Rudder pedal input forces
76	Event marker
77	Date
78	Actual navigation performance (ANP) or estimate of position error (EPE) or estimate of position uncertainty (EPU)
79	Cabin pressure altitude — for aeroplanes type certified before 1 January 2023, to be recorded only if this does not require extensive modification
80	Aeroplane computed weight — for aeroplanes type certified before 1 January 2023, to be recorded only if this does not require extensive modification
81	Flight director command:
81a	Left flight director pitch command — for aeroplanes type certified before 1 January 2023, to be recorded only if this does not require extensive modification
81b	Left flight director roll command — for aeroplanes type certified before 1 January 2023, to be recorded only if this does not require extensive modification
81c	Right flight director pitch command — for aeroplanes type certified before 1 January 2023, to be recorded only if this does not require extensive modification
81d	Right flight director roll command — for aeroplanes type certified before 1 January 2023, to be recorded only if this does not require extensive modification
82	Vertical speed — for aeroplanes type certified before 1 January 2023, to be recorded only if this does not require extensive modification

* The number in the left-hand column reflects the serial number depicted in EUROCAE Document 112A.

SPO.IDE.A.146 Lightweight flight recorder

Regulation (EU) 2019/1387

- (a) Turbine-engined aeroplanes with an MCTOM of 2 250 kg or more and aeroplanes with an MOPSC of more than 9 shall be equipped with a flight recorder if all the following conditions are met:
 - (1) they are not within the scope of point SPO.IDE.A.145(a);
 - (2) they are used for commercial operations;
 - (3) they are first issued with an individual CofA on or after 5 September 2022.
- (b) The flight recorder shall record, by means of flight data or images, information that is sufficient to determine the flight path and aircraft speed.
- (c) The flight recorder shall be capable of retaining the flight data and the images recorded during at least the preceding 5 hours.
- (d) The flight recorder shall automatically start to record prior to the aeroplane being capable of moving under its own power and shall stop automatically after the aeroplane is no longer capable of moving under its own power.
- (e) If the flight recorder records images or audio of the flight crew compartment, then a function shall be provided which can be operated by the pilot-in-command and which modifies image and audio recordings made before the operation of that function, so that those recordings cannot be retrieved using normal replay or copying techniques.

AMC1 SPO.IDE.A.146 Lightweight flight recorder

ED Decision 2021/005/R

OPERATIONAL PERFORMANCE REQUIREMENTS

- (a) If the flight recorder records flight data, it should record at least the following parameters:
 - (1) relative time count,
 - (2) pitch attitude or pitch rate,
 - (3) roll attitude or roll rate,
 - (4) heading (magnetic or true) or yaw rate,
 - (5) latitude,
 - (6) longitude,
 - (7) positioning system: estimated error (if available),
 - (8) pressure altitude or altitude from a positioning system,
 - (9) time,
 - (10) ground speed,
 - (11) positioning system: track (if available),
 - (12) normal acceleration,
 - (13) longitudinal acceleration,
 - (14) lateral acceleration.

- (b) If the flight recorder records images, it should capture views of the main instrument displays at the pilot station, or at both pilot stations when the aeroplane is certified for operation with a minimum crew of two pilots. The recorded image quality should allow reading the following indications during most of the flight:
- (1) magnetic heading,
 - (2) time,
 - (3) pressure altitude,
 - (4) indicated airspeed,
 - (5) vertical speed,
 - (6) turn and slip,
 - (7) attitude,
 - (8) Mach number (if displayed),
 - (9) stabilised heading, and
 - (10) tachometer indication or equivalent indication of propulsive thrust or power.
- (c) If the flight recorder records a combination of images and flight data, each flight parameter listed in (a) should be recorded as flight data or by means of images.
- (d) The flight parameters listed in (a), which are recorded as flight data, should meet the performance specifications (range, sampling intervals, accuracy limits and resolution in read-out) as defined in the relevant table of EUROCAE Document ED-112 'Minimum Operational Performance Specification for Crash Protected Airborne Recorder Systems', dated March 2003, or EUROCAE Document ED-155 'Minimum Operational Performance Specification for Lightweight Flight Recording Systems', dated July 2009, or any later equivalent standard accepted by EASA.
- (e) The operational performance requirements for the flight recorder should be those laid down in:
- (1) EUROCAE Document ED-155 or any later equivalent standard accepted by EASA for lightweight flight recorders; or
 - (2) EUROCAE Document ED-112 or any later equivalent standard accepted by EASA for crash-protected flight recorders.

GM1 SPO.IDE.A.146 Lightweight flight recorder

ED Decision 2021/005/R

ADDITIONAL USEFUL INFORMATION

- (a) Experience has shown the usefulness, for analysing incidents and for training purposes, of recording additional information. In particular, cockpit audio and information on the handling of the aircraft (such as position of flight controls, position of engine controls, fuel and oil indications, aircraft configuration selection), and an external view are very useful for such purposes. To capture such information, simple equipment such as an integrated microphone and integrated camera may be sufficient.
- (b) If the flight recorder includes optional capabilities such as described in (a), their recording duration is recommended to be at least 2 hours.

- (c) If the flight recorder is capable of acquiring flight parameters from some aircraft system, it is advised to give priority to the flight parameters listed in Annex II-B to EUROCAE Document ED-155 or the flight parameters listed in Annex II-A to EUROCAE Document ED-112. Indeed, these flight parameters were selected based on their relevance in many safety investigations.

GM1 SPO.IDE.A.146(e) Lightweight flight recorder

ED Decision 2021/005/R

FUNCTION TO MODIFY IMAGE AND AUDIO RECORDINGS

The purpose of the function modifying image and audio recordings is to allow the flight crew to protect their privacy by making such recordings inaccessible using normal techniques. The activation of this function is subject to the approval of the pilot-in-command (refer to [SPO.GEN.107](#)). However, the equipment manufacturer or a safety investigation authority might still be able to retrieve these recordings using special techniques.

GM2 SPO.IDE.A.146 Lightweight flight recorder

ED Decision 2021/005/R

INSTALLATION OF CAMERAS

When cameras are installed for the purpose of SPO.IDE.A.146, it is advised to install them so that they do not capture images of head and shoulders of the flight crew members whilst seated in their normal operating position.

GM3 SPO.IDE.A.146 Lightweight flight recorder

ED Decision 2021/005/R

RECORDING ACCURACY OF ATTITUDE RATE PARAMETERS

In the case of attitude rate parameters (pitch rate parameter, yaw rate parameter, roll rate parameter), the accuracy limit specified in EUROCAE Document ED-155, dated July 2009, was found to be unclear. Therefore, the following additional guidance is provided:

- (a) If the attitude rate parameter is provided by an approved system of the aeroplane, accuracy greater than as provided by this system is not expected for this attitude rate parameter.
- (b) If the attitude rate parameter is provided by a dedicated gyroscope, it is advisable that the gyroscope meets the following performance:
- (1) errors caused by linear accelerations less than $\pm 3^\circ/\text{sec}$ (equivalent to $\pm 1\%$ of $300^\circ/\text{sec}$ recording range) for all combinations of parameter values and linear acceleration values in the respective ranges $[-300^\circ/\text{sec}; +300^\circ/\text{sec}]$ and $[-3g; +6g]$;
 - (2) errors caused by to temperature less than $\pm 5^\circ/\text{sec}$ for all combinations of parameter values and temperature values in the respective ranges $[-300^\circ/\text{sec}; +300^\circ/\text{sec}]$ and $[-40^\circ\text{C}; +85^\circ\text{C}]$;
 - (3) angular random walk of the gyroscope equal to or less than $2^\circ/\sqrt{\text{hour}}$; and
 - (4) bias stability of the gyroscope significantly less than $360^\circ/\text{hour}$ (for instance, $50^\circ/\text{hour}$).

SPO.IDE.A.150 Data link recording

Regulation (EU) 2015/2338

- (a) Aeroplanes first issued with an individual CofA on or after 1 January 2016 that have the capability to operate data link communications and are required to be equipped with a CVR shall record on a recorder, where applicable:
- (1) data link communication messages related to ATS communications to and from the aeroplane, including messages applying to the following applications:
 - (i) data link initiation;
 - (ii) controller-pilot communication;
 - (iii) addressed surveillance;
 - (iv) flight information;
 - (v) as far as is practicable, given the architecture of the system, aircraft broadcast surveillance;
 - (vi) as far as is practicable, given the architecture of the system, aircraft operational control data; and
 - (vii) as far as is practicable, given the architecture of the system, graphics;
 - (2) information that enables correlation to any associated records related to data link communications and stored separately from the aeroplane; and
 - (3) information on the time and priority of data link communications messages, taking into account the system's architecture.
- (b) The recorder shall use a digital method of recording and storing data and information and a method for readily retrieving that data. The recording method shall allow the data to match the data recorded on the ground.
- (c) The recorder shall be capable of retaining data recorded for at least the same duration as set out for CVRs in [SPO.IDE.A.140](#).
- (d) If the recorder is not deployable, it shall have a device to assist in locating it under water. By 1 January 2020 at the latest, this device shall have a minimum underwater transmission time of 90 days. If the recorder is deployable, it shall have an automatic emergency locator transmitter.
- (e) The requirements applicable to the start and stop logic of the recorder are the same as the requirements applicable to the start and stop logic of the CVR contained in [SPO.IDE.A.140\(d\) and \(e\)](#).

AMC1 SPO.IDE.A.150 Data link recording

ED Decision 2014/018/R

GENERAL

- (a) As a means of compliance with [SPO.IDE.A.150\(a\)](#) the recorder on which the data link messages are recorded may be:
- (1) the CVR;
 - (2) the FDR;
 - (3) a combination recorder when [SPO.IDE.A.155](#) is applicable; or

- (4) a dedicated flight recorder. In that case, the operational performance requirements for this recorder should be those laid down in EUROCAE Document ED-112 (Minimum Operational Performance Specification for Crash Protected Airborne Recorder Systems), dated March 2003, including amendments No°1 and No 2, or any later equivalent standard produced by EUROCAE.
- (b) As a means of compliance with [SPO.IDE.A.150\(a\)\(2\)](#) the operator should enable correlation by providing information that allows an accident investigator to understand what data was provided to the aircraft and, when the provider identification is contained in the message, by which provider.
- (c) The timing information associated with the data link communications messages required to be recorded by [SPO.IDE.A.150\(a\)\(3\)](#) should be capable of being determined from the airborne-based recordings. This timing information should include at least the following:
- (1) the time each message was generated;
 - (2) the time any message was available to be displayed by the flight crew;
 - (3) the time each message was actually displayed or recalled from a queue; and
 - (4) the time of each status change.
- (d) The message priority should be recorded when it is defined by the protocol of the data link communication message being recorded.
- (e) The expression ‘taking into account the system’s architecture’, in [SPO.IDE.A.150\(a\)\(3\)](#), means that the recording of the specified information may be omitted if the existing source systems involved would require a major upgrade. The following should be considered:
- (1) the extent of the modification required;
 - (2) the down-time period; and
 - (3) equipment software development.
- (f) Data link communications messages that support the applications in Table 1 below should be recorded.
- (g) Further details on the recording requirements can be found in the recording requirement matrix in Appendix D.2 of EUROCAE Document ED-93 (Minimum Aviation System Performance Specification for CNS/ATM Recorder Systems), dated November 1998.

Table 1: Data link recording

Item No	Application Type	Application Description	Required Recording Content
1	Data link initiation	This includes any application used to log on to, or initiate, a data link service. In future air navigation system (FANS)-1/A and air traffic navigation (ATN), these are ATS facilities notification (AFN) and context management (CM), respectively.	C
2	Controller/pilot communication	This includes any application used to exchange requests, clearances, instructions and reports between the flight crew and controllers on the ground. In FANS-1/A and ATN, this includes the controller pilot data link communications (CPDLC) application.	C

Item No	Application Type	Application Description	Required Recording Content
		It also includes applications used for the exchange of oceanic clearances (OCL) and departure clearances (DCL), as well as data link delivery of taxi clearances.	
3	Addressed surveillance	This includes any surveillance application in which the ground sets up contracts for delivery of surveillance data. In FANS-1/A and ATN, this includes the automatic dependent surveillance-contract (ADS-C) application.	C, F2
4	Flight information	This includes any application used for delivery of flight information data to specific aeroplanes. This includes for example digital automatic terminal information service (D ATIS), data link operational terminal information service (D OTIS), digital weather information services (data link-meteorological aerodrome or aeronautical report (D-METAR) or terminal weather information for pilots (TWIP)), data link flight information service (D-FIS), and Notice to Airmen (electronic NOTAM) delivery.	C
5	Broadcast surveillance	This includes elementary and enhanced surveillance systems, as well as automatic dependent surveillance-broadcast (ADS-B) output data.	M*, F2
6	Aeronautical operational control (AOC) data	This includes any application transmitting or receiving data used for AOC purposes (in accordance with the ICAO definition of AOC). Such systems may also process aeronautical administrative communication (AAC) messages, but there is no requirement to record AAC messages	M*
7	Graphics	This includes any application receiving graphical data to be used for operational purposes (i.e. excluding applications that are receiving such things as updates to manuals).	M* F1

GM1 SPO.IDE.A.150 Data link recording

ED Decision 2014/018/R

GENERAL

- (a) The letters and expressions in Table 1 of [AMC1 SPO.IDE.A.150](#) have the following meaning:
- (1) C: complete contents recorded.
 - (2) M: information that enables correlation with any associated records stored separately from the aeroplane.
 - (3) *: applications that are to be recorded only as far as is practicable, given the architecture of the system.
 - (4) F1: graphics applications may be considered as AOC messages when they are part of a data link communications application service run on an individual basis by the operator itself in the framework of the operational control.
 - (5) F2: where parametric data sent by the aeroplane, such as Mode S, is reported within the message, it should be recorded unless data from the same source is recorded on the FDR.

- (b) The definitions of the applications type in Table 1 of [AMC1 SPO.IDE.A.150](#) are described in Table 1 below.

Table 1: Definitions of the applications type

Item No	Application Type	Messages	Comments
1	CM		CM is an ATN service
2	AFN		AFN is a FANS 1/A service
3	CPDLC		All implemented up and downlink messages to be recorded
4	ADS-C	ADS-C reports	All contract requests and reports recorded
		Position reports	Only used within FANS 1/A. Mainly used in oceanic and remote areas.
5	ADS-B	Surveillance data	Information that enables correlation with any associated records stored separately from the aeroplane.
6	D-FIS		D-FIS is an ATN service. All implemented up and downlink messages to be recorded
7	TWIP	TWIP messages	Terminal weather information for pilots
8	D-ATIS	ATIS messages	Refer to EUROCAE ED-89A, dated December 2003: Data Link Application System Document (DLASD) for the 'ATIS' data link service
9	OCL	OCL messages	Refer to EUROCAE ED-106A, dated March 2004: Data Link Application System Document (DLASD) for 'Oceanic Clearance' (OCL) data link service
10	DCL	DCL messages	Refer to EUROCAE ED-85A, dated December 2005: Data Link Application System Document (DLASD) for 'Departure Clearance' data link service
11	Graphics	Weather maps & other graphics	Graphics exchanged in the framework of procedures within the operational control, as specified in Part-ORO. Information that enables correlation with any associated records stored separately from the aeroplane.
12	AOC	Aeronautical operational control messages	Messages exchanged in the framework of procedures within the operational control, as specified in Part-ORO. Information that enables correlation with any associated records stored separately from the aeroplane. Definition in EUROCAE ED-112, dated March 2003.
13	Surveillance	Downlinked aircraft parameters (DAP)	As defined in ICAO Annex 10 Volume IV (Surveillance systems and ACAS).

AAC	aeronautical administrative communications
ADS-B	automatic dependent surveillance — broadcast
ADS-C	automatic dependent surveillance — contract
AFN	aircraft flight notification
AOC	aeronautical operational control
ATIS	automatic terminal information service
ATSC	air traffic service communication
CAP	controller access parameters
CPDLC	controller pilot data link communications
CM	configuration/context management
D-ATIS	digital ATIS

D-FIS	data link flight information service
D-METAR	data link meteorological airport report
DCL	departure clearance
FANS	Future Air Navigation System
FLIPCY	flight plan consistency
OCL	oceanic clearance
SAP	system access parameters
TWIP	terminal weather information for pilots

GM1 SPO.IDE.A.150(a) Data link recording

ED Decision 2015/030/R

APPLICABILITY OF THE DATA LINK RECORDING REQUIREMENT

- (a) If it is certain that the aeroplane cannot use data link communication messages for ATS communications corresponding to any application designated by [SPO.IDE.A.150\(a\)\(1\)](#), then the data link recording requirement does not apply.
- (b) Examples where the aeroplane cannot use data link communication messages for ATS communications include but are not limited to the cases where:
 - (1) the aeroplane data link communication capability is disabled permanently and in a way that it cannot be enabled again during the flight;
 - (2) data link communications are not used to support air traffic service (ATS) in the area of operation of the aeroplane; and
 - (3) the aeroplane data link communication equipment cannot communicate with the equipment used by ATS in the area of operation of the aeroplane.

SPO.IDE.A.155 Flight data and cockpit voice combination recorder

Regulation (EU) No 379/2014

Compliance with CVR requirements and FDR requirements may be achieved by:

- (a) one flight data and cockpit voice combination recorder if the aeroplane has to be equipped with a CVR or an FDR; or
- (b) two flight data and cockpit voice combination recorders if the aeroplane has to be equipped with a CVR and an FDR.

AMC1 SPO.IDE.A.155 Flight data and cockpit voice combination recorder

ED Decision 2014/018/R

GENERAL

When two flight data and cockpit voice combination recorders are installed, one should be located near the flight crew compartment in order to minimise the risk of data loss due to a failure of the wiring that gathers data to the recorder. The other should be located at the rear section of the aeroplane, in order to minimise the risk of data loss due to recorder damage in the case of a crash.

GM1 SPO.IDE.A.155 Flight data and cockpit voice combination recorder

ED Decision 2014/018/R

GENERAL

- (a) A flight data and cockpit voice combination recorder is a flight recorder that records:
- (1) all voice communications and the aural environment required by [SPO.IDE.A.140](#); and
 - (2) all parameters and specifications required by [SPO.IDE.A.145](#),
with the same specifications required by [SPO.IDE.A.140](#) and [SPO.IDE.A.145](#).
- (b) In addition a flight data and cockpit voice combination recorder may record data link communication messages and related information required by [SPO.IDE.A.150](#).

SPO.IDE.A.160 Seats, seat safety belts and restraint systems

Regulation (EU) 2019/1384

Aeroplanes shall be equipped with:

- (a) a seat or station for each crew member or task specialist on board;
- (b) a seat belt on each seat, and restraint devices for each station;
- (c) for other-than-complex motor-powered aeroplanes, a seat belt with upper torso restraint system on each flight crew seat, having a single point release for aeroplanes having a CofA first issued on or after 25 August 2016;
- (d) for complex motor-powered aeroplanes, a seat belt with upper torso restraint system, incorporating a device that will automatically restrain the occupant's torso in the event of rapid deceleration:
 - (1) on each flight crew seat and on any seat alongside a pilot's seat; and
 - (2) on each observer's seat located in the flight crew compartment.
- (e) The seat belt with upper torso restraint system required under point (d) shall have:
 - (1) a single point release;
 - (2) on flight crew members seats and on any seat alongside a pilot's seat, either of the following:
 - (i) two shoulder straps and a seat belt that may be used independently;
 - (ii) a diagonal shoulder strap and a seat belt that may be used independently for the following aeroplanes:
 - (A) aeroplanes with an MCTOM of 5 700 kg or less and with an MOPSC of nine or less that are compliant with the emergency landing dynamic conditions defined in the applicable certification specification;
 - (B) aeroplanes with an MCTOM of 5 700 kg or less and with an MOPSC of nine or less that are not compliant with the emergency landing dynamic conditions defined in the applicable certification specification and having an individual CofA first issued before 25 August 2016.

AMC1 SPO.IDE.A.160 Seats, seat safety belts and restraint systems

ED Decision 2016/021/R

UPPER TORSO RESTRAINT SYSTEM FOR OTHER-THAN COMPLEX MOTOR-POWERED AEROPLANES

- (a) The following systems are deemed to be compliant with the requirement for an upper torso restraint system:
- (1) A seat belt with a diagonal shoulder strap;
 - (2) A restraint system having a seat belt and two shoulder straps that may be used independently; and
 - (3) A restraint system having a seat belt, two shoulder straps and additional straps that may be used independently.
- (b) The use of the upper torso restraint independently from the use of the seat belt is intended as an option for the comfort of the occupant of the seat in those phases of flight where only the seat belt is required to be fastened. A restraint system including a seat belt and an upper torso restraint that both remain permanently fastened is also acceptable.

UPPER TORSO RESTRAINT SYSTEM FOR COMPLEX MOTOR-POWERED AEROPLANES

- (a) A restraint system, including a seat belt, two shoulder straps and additional straps is deemed to be compliant with the requirement for restraint systems with two shoulder straps.
- (b) An upper torso restraint system which restrains permanently the torso of the occupant is deemed to be compliant with the requirement for an upper torso restraint system incorporating a device that will automatically restrain the occupant's torso in the event of rapid deceleration.
- (c) The use of the upper torso restraint independently from the use of the seat belt is intended as an option for the comfort of the occupant of the seat in those phases of flight where only the seat belt is required to be fastened. A restraint system including a seat belt and an upper torso restraint that both remain permanently fastened is also acceptable.

SEAT BELT

A seat belt with a diagonal shoulder strap (three anchorage points) is deemed to be compliant with the requirement for a seat belt (two anchorage points).

GM1 SPO.IDE.A.160 Seats, seat safety belts, restraint systems

ED Decision 2014/018/R

EMERGENCY LANDING DYNAMIC CONDITIONS

Emergency landing dynamic conditions are defined in 23.562 of CS-23 or equivalent and in 25.562 of CS-25 or equivalent.

SPO.IDE.A.165 First-aid kit

Regulation (EU) No 379/2014

- (a) Aeroplanes shall be equipped with a first-aid kit.
- (b) The first-aid kit shall be:
- (1) readily accessible for use; and
 - (2) kept up-to-date.

AMC1 SPO.IDE.A.165 First-aid kit

ED Decision 2021/005/R

CONTENT OF FIRST-AID KITS — OTHER-THAN COMPLEX MOTOR-POWERED AEROPLANES

- (a) First-aid kits (FAKs) should be equipped with appropriate and sufficient medications and instrumentation. However, these kits should be supplemented by the operator according to the characteristics of the operation (scope of operation, flight duration, number and demographics of passengers, etc.).
- (b) The following should be included in the FAKs:
 - (1) bandages (assorted sizes, including a triangular bandage),
 - (2) burns dressings (large and small),
 - (3) wound dressings (large and small),
 - (4) adhesive dressings (assorted sizes),
 - (5) antiseptic wound cleaner,
 - (6) safety scissors,
 - (7) disposable gloves,
 - (8) disposable resuscitation aid, and
 - (9) surgical masks.

AMC2 SPO.IDE.A.165 First-aid kit

ED Decision 2021/005/R

CONTENT OF FIRST-AID KITS — COMPLEX MOTOR-POWERED AEROPLANES

- (a) First-aid kits should be equipped with appropriate and sufficient medications and instrumentation. However, these kits should be supplemented by the operator according to the characteristics of the operation (scope of operation, flight duration, number and demographics of passengers, etc.).
- (b) The following should be included in the FAKs:
 - (1) Equipment:
 - (i) bandages (assorted sizes, including a triangular bandage);
 - (ii) burns dressings (unspecified);
 - (iii) wound dressings (large and small);
 - (iv) adhesive dressings (assorted sizes);
 - (v) adhesive tape;
 - (vi) adhesive wound closures;
 - (vii) safety pins;
 - (viii) safety scissors;
 - (ix) antiseptic wound cleaner;
 - (x) disposable resuscitation aid;

- (xi) disposable gloves;
 - (xii) tweezers: splinter;
 - (xiii) thermometers (non-mercury); and
 - (xiv) surgical masks.
- (2) Medications:
- (i) simple analgesic;
 - (ii) antiemetic — non-injectable;
 - (iii) nasal decongestant;
 - (iv) gastrointestinal antacid, in the case of aeroplanes carrying more than nine persons;
 - (v) anti-diarrhoeal medication, in the case of aeroplanes carrying more than nine persons; and
 - (vi) antihistamine.
- (3) Other content. The operator should make the instructions readily available. If an electronic format is available, then all instructions should be kept on the same device. If a paper format is used, then the instructions should be kept in the same kit with the applicable equipment and medication. The instructions should include, as a minimum, the following:
- (i) a list of contents in at least two languages (English and one other). This should include information on the effects and side effects of medications carried;
 - (ii) first-aid handbook, current edition;
 - (iii) Basic life support instructions cards (summarising and depicting the current algorithm for basic life support);
 - (iv) medical incident report form;
 - (v) biohazard disposal bags; and
 - (vi) bag-valve masks for adults.
- (4) Additional equipment. The operators should carry additional equipment based on a risk assessment that considers the specificities and the nature of their specialised operations:
- (i) automated external defibrillator (AED);
 - (ii) suitable airway management device (e.g. supraglottic airway devices, oropharyngeal or nasopharyngeal airways); and
 - (iii) eye irrigator.

AMC3 SPO.IDE.A.165 First-aid kit

ED Decision 2014/018/R

MAINTENANCE OF FIRST-AID KIT

To be kept up to date, the first-aid kit should be:

- (a) inspected periodically to confirm, to the extent possible, that contents are maintained in the condition necessary for their intended use;

- (b) replenished at regular intervals, in accordance with instructions contained on their labels, or as circumstances warrant; and
- (c) replenished after use in-flight at the first opportunity where replacement items are available.

GM1 SPO.IDE.A.165 First-aid kit

ED Decision 2021/005/R

LOCATION

The location of the first-aid kit in the cabin is normally indicated using internationally recognisable signs.

GM2 SPO.IDE.A.165 First-aid kit

ED Decision 2021/005/R

storage

As a best practice and wherever practicable, the emergency medical equipment listed under [AMC2 SPO.IDE.A.165](#) should be kept close together.

GM3 SPO.IDE.A.165 First-aid kit

ED Decision 2021/005/R

CONTENT OF FIRST-AID KITS

The operator may supplement first-aid kits according to the characteristics of the operation based on a risk assessment. The assessment does not require an approval by the competent authority.

GM4 SPO.IDE.A.165 First-aid kit

ED Decision 2021/005/R

LITHIUM BATTERIES

Risks related to the presence of lithium batteries should be assessed. All equipment powered by lithium batteries carried on an aeroplane should comply with the provisions of [AMC1 CAT.GEN.MPA.140\(f\)](#) including applicable technical standards such as (E)TSO-C142.

SPO.IDE.A.170 Supplemental oxygen – pressurised aeroplanes

Regulation (EU) No 379/2014

- (a) Pressurised aeroplanes operated at flight altitudes for which the oxygen supply is required in accordance with (b) shall be equipped with oxygen storage and dispensing apparatus capable of storing and dispensing the required oxygen supplies.
- (b) Pressurised aeroplanes operated above flight altitudes at which the pressure altitude in the cabin compartments is above 10 000 ft shall carry enough breathing oxygen to supply all crew members and task specialists at least:
 - (1) for any period when the cabin pressure altitude exceeds 15 000 ft, but in no case less than 10 minutes' supply;
 - (2) for any period when, in the event of loss of pressurisation and taking into account the circumstances of the flight, the pressure altitude in the flight crew and cabin compartment will be between 14 000 ft and 15 000 ft;

- (3) for any period in excess of 30 minutes when the pressure altitude in the flight crew and cabin compartment will be between 10 000 ft and 14 000 ft; and
 - (4) for no less than 10 minutes, in the case of aeroplanes operated at pressure altitudes above 25 000 ft, or operated below that altitude, but under conditions that will not allow them to descend safely to a pressure altitude of 13 000 ft within 4 minutes.
- (c) Pressurised aeroplanes operated at flight altitudes above 25 000 ft shall, in addition, be equipped with:
- (1) a device to provide a warning indication to the flight crew of any loss of pressurisation; and
 - (2) in the case of complex motor-powered aeroplanes, quick donning masks for flight crew members.

AMC1 SPO.IDE.A.170 Supplemental oxygen – pressurised aeroplanes

ED Decision 2014/018/R

DETERMINATION OF OXYGEN

- (a) In the determination of oxygen for the routes to be flown, it is assumed that the aeroplane will descend in accordance with the emergency procedures specified in the AFM, without exceeding its operating limitations, to a flight altitude that will allow the flight to be completed safely (i.e. flight altitudes ensuring adequate terrain clearance, navigational accuracy, hazardous weather avoidance, etc.).
- (b) The amount of oxygen should be determined on the basis of cabin pressure altitude, flight duration and on the assumption that a cabin pressurisation failure will occur at the pressure altitude or point of flight that is most critical from the standpoint of oxygen need.
- (c) Following a cabin pressurisation failure, the cabin pressure altitude should be considered to be the same as the aeroplane pressure altitude unless it can be demonstrated to the competent authority that no probable failure of the cabin or pressurisation system will result in a cabin pressure altitude equal to the aeroplane pressure altitude. Under these circumstances, the demonstrated maximum cabin pressure altitude may be used as a basis for determination of oxygen supply.

GM1 SPO.IDE.A.170(c)(2) Supplemental oxygen – pressurised aeroplanes

ED Decision 2014/018/R

QUICK DONNING MASKS

A quick donning mask is a type of mask that:

- (a) can be placed on the face from its ready position, properly secured, sealed and supplying oxygen upon demand, with one hand and within 5 seconds and will thereafter remain in position, both hands being free;
- (b) can be donned without disturbing eye glasses and without delaying the flight crew member from proceeding with assigned emergency duties;
- (c) once donned, does not prevent immediate communication between the flight crew members and other crew members over the aircraft intercommunication system; and
- (d) does not inhibit radio communications.

SPO.IDE.A.175 Supplemental oxygen – non-pressurised aeroplanes

Regulation (EU) No 379/2014

- (a) Non-pressurised aeroplanes operated at flight altitudes when the oxygen supply is required in accordance with (b) shall be equipped with oxygen storage and dispensing apparatus capable of storing and dispensing the required oxygen supplies.
- (b) Non-pressurised aeroplanes operated above flight altitudes at which the pressure altitude in the cabin compartments is above 10 000 ft shall carry enough breathing oxygen to supply:
 - (1) all crew members for any period in excess of 30 minutes when the pressure altitude in the cabin compartment will be between 10 000 ft and 13 000 ft; and
 - (2) all persons on board for any period that the pressure altitude in the cabin compartment will be above 13 000 ft.
- (c) Notwithstanding (b), excursions of a specified duration between 13 000 ft and 16 000 ft may be undertaken without oxygen supplies, in accordance with [SPO.OP.195\(b\)](#).

AMC1 SPO.IDE.A.175 Supplemental oxygen – non-pressurised aeroplanes

ED Decision 2014/018/R

DETERMINATION OF OXYGEN

- (a) In the determination of oxygen for the routes to be flown, it is assumed that the aeroplane will descend in accordance with the emergency procedures specified in the AFM, without exceeding its operating limitations, to a flight altitude that will allow the flight to be completed safely (i.e. flight altitudes ensuring adequate terrain clearance, navigational accuracy, hazardous weather avoidance etc.).
- (b) The amount of oxygen should be determined on the basis of cabin pressure altitude and flight duration.

SPO.IDE.A.180 Hand fire extinguishers

Regulation (EU) 2018/1975

- (a) Aeroplanes, except ELA1 aeroplanes, shall be equipped with at least one hand fire extinguisher:
 - (1) in the flight crew compartment; and
 - (2) in each cabin compartment that is separate from the flight crew compartment, except if the compartment is readily accessible to the flight crew.
- (b) The type and quantity of extinguishing agent for the required fire extinguishers shall be suitable for the type of fire likely to occur in the compartment where the extinguisher is intended to be used and to minimise the hazard of toxic gas concentration in compartments occupied by persons.

AMC1 SPO.IDE.A.180 Hand fire extinguishers

ED Decision 2014/018/R

NUMBER, LOCATION AND TYPE

- (a) The number and location of hand fire extinguishers should be such as to provide adequate availability for use, account being taken of the number and size of the cabin compartments, the

need to minimise the hazard of toxic gas concentrations and the location of toilets, galleys, etc. These considerations may result in the number of fire extinguishers being greater than the minimum required.

- (b) There should be at least one hand fire extinguisher installed in the flight crew compartment and this should be suitable for fighting both flammable fluid and electrical equipment fires. Additional hand fire extinguishers may be required for the protection of other compartments accessible to the flight crew or task specialist in flight. Dry chemical fire extinguishers should not be used in the flight crew compartment, or in any compartment not separated by a partition from the flight crew compartment, because of the adverse effect on vision during discharge and, if conductive, interference with electrical contacts by the chemical residues.
- (c) Where only one hand fire extinguisher is required in the cabin compartments, it should be located near the task specialist's station, where provided.
- (d) Where two or more hand fire extinguishers are required in the cabin compartments and their location is not otherwise dictated by consideration of (a), an extinguisher should be located near each end of the cabin with the remainder distributed throughout the cabin as evenly as is practicable.
- (e) Unless an extinguisher is clearly visible, its location should be indicated by a placard or sign. Appropriate symbols may also be used to supplement such a placard or sign.

SPO.IDE.A.181 Crash axe and crowbar

Regulation (EU) No 379/2014

Aeroplanes with an MCTOM of more than 5 700 kg shall be equipped with at least one crash axe or crowbar located in the flight crew compartment.

SPO.IDE.A.185 Marking of break-in points

Regulation (EU) No 379/2014

If areas of the aeroplane's fuselage suitable for break-in by rescue crews in an emergency are marked, such areas shall be marked as shown in Figure 1.

Figure 1
Marking of break-in points

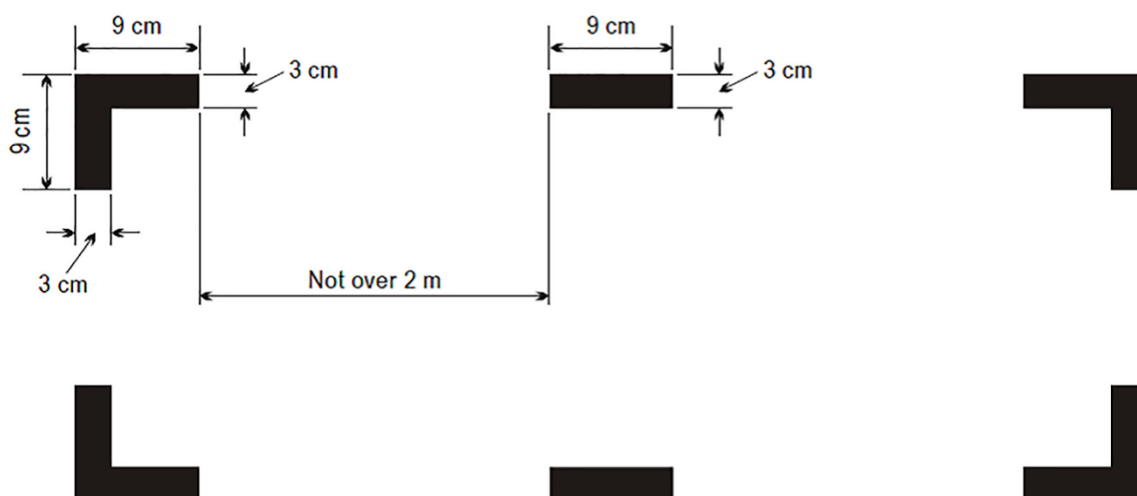

AMC1 SPO.IDE.A.185 Marking of break-in points

ED Decision 2014/018/R

COLOUR AND CORNERS' MARKING

- (a) The colour of the markings should be red or yellow and, if necessary, should be outlined in white to contrast with the background.
- (b) If the corner markings are more than 2 m apart, intermediate lines 9 cm x 3 cm should be inserted so that there is no more than 2 m between adjacent markings.

SPO.IDE.A.190 Emergency locator transmitter (ELT)

Regulation (EU) 2015/2338

- (a) Aeroplanes shall be equipped with:
 - (1) an ELT of any type or an aircraft localisation means meeting the requirement of Annex IV (Part CAT), [CAT.GEN.MPA.210](#), to Regulation (EU) No 965/2012, when first issued with an individual CofA on or before 1 July 2008;
 - (2) an automatic ELT or an aircraft localisation means meeting the requirement of Annex IV (Part CAT), [CAT.GEN.MPA.210](#), to Regulation (EU) No 965/2012, when first issued with an individual CofA after 1 July 2008; or
 - (3) a survival ELT (ELT(S)) or a personal locator beacon (PLB), carried by a crew member or a task specialist, when certified for a maximum seating configuration of six or less.
- (b) ELTs of any type and PLBs shall be capable of transmitting simultaneously on 121,5 MHz and 406 MHz.

AMC1 SPO.IDE.A.190 Emergency locator transmitter (ELT)

ED Decision 2014/018/R

BATTERIES

- (a) All batteries used in ELTs or PLBs should be replaced (or recharged, if the battery is rechargeable) when the equipment has been in use for more than 1 cumulative hour or in the following cases:
 - (1) Batteries specifically designed for use in ELTs and having an airworthiness release certificate (EASA Form 1 or equivalent) should be replaced (or recharged, if the battery is rechargeable) before the end of their useful life in accordance with the maintenance instructions applicable to the ELT.
 - (2) Standard batteries manufactured in accordance with an industry standard and not having an airworthiness release certificate (EASA Form 1 or equivalent), when used in ELTs should be replaced (or recharged, if the battery is rechargeable) when 50 % of their useful life (or for rechargeable, 50 % of their useful life of charge), as established by the battery manufacturer, has expired.
 - (3) All batteries used in PLBs should be replaced (or recharged, if the battery is rechargeable) when 50 % of their useful life (or for rechargeable, 50 % of their useful life of charge), as established by the battery manufacturer, has expired.
 - (4) The battery useful life (or useful life of charge) criteria in (1),(2) and (3) do not apply to batteries (such as water-activated batteries) that are essentially unaffected during probable storage intervals.

- (b) The new expiry date for a replaced (or recharged) battery should be legibly marked on the outside of the equipment.

AMC2 SPO.IDE.A.190 Emergency locator transmitter (ELT)

ED Decision 2021/008/R

TYPES OF ELT AND GENERAL TECHNICAL SPECIFICATIONS

- (a) Point (a) of [AMC2 CAT.IDE.A.280](#) lists the applicable types of ELTs.
- (b) To minimise the possibility of damage in the event of a crash impact, the ELT(AF), ELT(AP), ELT(AD), or ELT(DT) should be rigidly fixed to the aircraft structure, as far aft as practicable, with its antenna and connections arranged so as to maximise the probability of the signal being transmitted after a crash.
- (c) Point (c) of [AMC2 CAT.IDE.A.280](#) on crash survivability and homing-signal capability applies.
- (d) Any ELT carried should operate in accordance with the relevant provisions of ICAO Annex 10, Volume III and should be registered with the national agency responsible for initiating search and rescue or other nominated agency.

AMC3 SPO.IDE.A.190 Emergency locator transmitter (ELT)

ED Decision 2014/018/R

PLB TECHNICAL SPECIFICATIONS

- (a) A personal locator beacon (PLB) should have a built-in GNSS receiver with a *cosmicheskaya sistyema poiska aviarynich sudov* — search and rescue satellite-aided tracking (COSPAS-SARSAT) type approval number. However, devices with a COSPAS-SARSAT with a number belonging to series 700 are excluded as this series of numbers identifies the special-use beacons not meeting all the technical requirements and all the tests specified by COSPAS-SARSAT.
- (b) Any PLB carried should be registered with the national agency responsible for initiating search and rescue or other nominated agency.

AMC4 SPO.IDE.A.190 Emergency locator transmitter (ELT)

ED Decision 2014/018/R

BRIEFING ON PLB USE

When a PLB is carried by a task specialist, he/she should be briefed on its characteristics and use by the pilot-in-command before the flight.

GM1 SPO.IDE.A.190 Emergency locator transmitter (ELT)

ED Decision 2021/008/R

TERMINOLOGY

[GM1 CAT.IDE.A.280](#) contains explanations of terms used in point [SPO.IDE.A.190](#) and in the related AMC.

GM2 SPO.IDE.A.190 Emergency locator transmitter (ELT)

ED Decision 2014/018/R

MAXIMUM CERTIFIED SEATING CONFIGURATION

The maximum certified seating configuration does not include flight crew seats.

GM3 SPO.IDE.A.190 Emergency locator transmitter (ELT)

ED Decision 2021/008/R

ADDITIONAL GUIDANCE

The guidance provided in [GM2 CAT.IDE.A.280](#) is also applicable to point [SPO.IDE.A.190](#).

SPO.IDE.A.195 Flight over water

Regulation (EU) No 379/2014

- (a) The following aeroplanes shall be equipped with a life-jacket for each person on board, that shall be worn or stowed in a position that is readily accessible from the seat or station of the person for whose use it is provided:
- (1) single-engine landplanes when:
 - (i) flying over water beyond gliding distance from land; or
 - (ii) taking off or landing at an aerodrome or operating site where, in the opinion of the pilot-in-command, the take-off or approach path is so disposed over water that there would be a likelihood of a ditching;
 - (2) seaplanes operated over water; and
 - (3) aeroplanes operated at a distance away from land where an emergency landing is possible greater than that corresponding to 30 minutes at normal cruising speed or 50 NM, whichever is less.
- (b) Each life-jacket shall be equipped with a means of electric illumination for the purpose of facilitating the location of persons.
- (c) Seaplanes operated over water shall be equipped with:
- (1) a sea anchor and other equipment necessary to facilitate mooring, anchoring or manoeuvring the aeroplane on water, appropriate to its size, weight and handling characteristics; and
 - (2) equipment for making the sound signals as prescribed in the International Regulations for Preventing Collisions at Sea, where applicable.
- (d) The pilot-in-command of an aeroplane operated at a distance away from land where an emergency landing is possible greater than that corresponding to 30 minutes at normal cruising speed or 50 NM, whichever is the lesser, shall determine the risks to survival of the occupants of the aeroplane in the event of a ditching, based on which he/she shall determine the carriage of:
- (1) equipment for making the distress signals;
 - (2) life-rafts in sufficient numbers to carry all persons on board, stowed so as to facilitate their ready use in emergency; and

- (3) life-saving equipment, to provide the means of sustaining life, as appropriate to the flight to be undertaken.

AMC1 SPO.IDE.A.195 Flight over water

ED Decision 2014/018/R

ACCESSIBILITY OF LIFE-JACKETS

The life-jacket, if not worn, should be accessible from the seat or station of the person for whose use it is provided, with a safety belt or a restraint system fastened.

MEANS OF ILLUMINATION FOR LIFE-JACKETS

The means of electric illumination should be a survivor locator light as defined in the applicable ETSO issued by the Agency or equivalent.

RISK ASSESSMENT

- (a) When conducting the risk assessment, the pilot-in-command should base his/her decision, as far as is practicable, on the Implementing Rules and AMCs applicable to the operation of the aeroplane.
- (b) The pilot-in-command should, for determining the risk, take the following operating environment and conditions into account:
 - (1) sea state;
 - (2) sea and air temperatures;
 - (3) the distance from land suitable for making an emergency landing; and
 - (4) the availability of search and rescue facilities.

AMC2 SPO.IDE.A.195 Flight over water

ED Decision 2014/018/R

LIFE RAFTS AND EQUIPMENT FOR MAKING DISTRESS SIGNALS

- (a) The following should be readily available with each life-raft:
 - (1) means for maintaining buoyancy;
 - (2) a sea anchor;
 - (3) life-lines and means of attaching one life-raft to another;
 - (4) paddles for life-rafts with a capacity of six or less;
 - (5) means of protecting the occupants from the elements;
 - (6) a water-resistant torch;
 - (7) signalling equipment to make the pyrotechnic distress signals described in ICAO Annex 2, Rules of the Air;
 - (8) 100 g of glucose tablets for each four, or fraction of four, persons that the life-raft is designed to carry;
 - (9) at least 2 litres of drinkable water provided in durable containers or means of making sea water drinkable or a combination of both; and
 - (10) first-aid equipment.

- (b) As far as practicable, items listed in (a) should be contained in a pack.

GM1 SPO.IDE.A.195 Flight over water

ED Decision 2014/018/R

SEAT CUSHIONS

Seat cushions are not considered to be flotation devices.

SPO.IDE.A.200 Survival equipment

Regulation (EU) No 379/2014

- (a) Aeroplanes operated over areas in which search and rescue would be especially difficult shall be equipped with:
- (1) signalling equipment to make the distress signals;
 - (2) at least one survival ELT (ELT(S)); and
 - (3) additional survival equipment for the route to be flown taking account of the number of persons on board.
- (b) The additional survival equipment specified in (a)(3) does not need to be carried when the aeroplane:
- (1) remains within a distance from an area where search and rescue is not especially difficult corresponding to:
 - (i) 120 minutes at one-engine-inoperative (OEI) cruising speed for aeroplanes capable of continuing the flight to an aerodrome with the critical engine(s) becoming inoperative at any point along the route or planned diversion routes; or
 - (ii) 30 minutes at cruising speed for all other aeroplanes; or
 - (2) remains within a distance no greater than that corresponding to 90 minutes at cruising speed from an area suitable for making an emergency landing, for aeroplanes certified in accordance with the applicable airworthiness standard.

AMC1 SPO.IDE.A.200 Survival equipment

ED Decision 2014/018/R

ADDITIONAL SURVIVAL EQUIPMENT

- (a) The following additional survival equipment should be carried when required:
- (1) 500 ml of water for each four, or fraction of four, persons on board;
 - (2) one knife;
 - (3) first-aid equipment; and
 - (4) one set of air/ground codes.
- (b) In addition, when polar conditions are expected, the following should be carried:
- (1) a means of melting snow;
 - (2) one snow shovel and one ice saw;

- (3) sleeping bags for use by 1/3 of all persons on board and space blankets for the remainder or space blankets for all persons on board; and
 - (4) one arctic/polar suit for each crew member
- (c) If any item of equipment contained in the above list is already carried on board the aircraft in accordance with another requirement, there is no need for this to be duplicated.

AMC1 SPO.IDE.A.200(a)(2) Survival equipment

ED Decision 2014/018/R

SURVIVAL ELT

An ELT(AP) may be used to replace one required ELT(S) provided that it meets the ELT(S) requirements. A water-activated ELT(S) is not an ELT(AP).

AMC1 SPO.IDE.A.200(b)(2) Survival equipment

ED Decision 2014/018/R

APPLICABLE AIRWORTHINESS STANDARD

The applicable airworthiness standard should be CS-25 or equivalent.

GM1 SPO.IDE.A.200 Survival equipment

ED Decision 2014/018/R

SIGNALLING EQUIPMENT

The signalling equipment for making distress signals is described in ICAO Annex 2, Rules of the Air.

GM2 SPO.IDE.A.200 Survival equipment

ED Decision 2014/018/R

AREAS IN WHICH SEARCH AND RESCUE WOULD BE ESPECIALLY DIFFICULT

The expression 'areas in which search and rescue would be especially difficult' should be interpreted, in this context, as meaning:

- (a) areas so designated by the authority responsible for managing search and rescue; or
- (b) areas that are largely uninhabited and where:
 - (1) the authority referred to in (a) not published any information to confirm whether search and rescue would be or would not be especially difficult; and
 - (2) the authority referred to in (a) does not, as a matter of policy, designate areas as being especially difficult for search and rescue.

SPO.IDE.A.205 Individual protective equipment

Regulation (EU) No 379/2014

Each person on board shall wear individual protective equipment that is adequate for the type of operation being undertaken.

GM1 SPO.IDE.A.205 Individual protective equipment

ED Decision 2014/018/R

TYPES OF INDIVIDUAL PROTECTIVE EQUIPMENT

Personal protective equipment should include, but is not limited to: flying suits, gloves, helmets, protective shoes, etc.

SPO.IDE.A.210 Headset

Regulation (EU) No 379/2014

- (a) Aeroplanes shall be equipped with a headset with a boom microphone or equivalent for each flight crew member at their assigned station in the flight crew compartment.
- (b) Aeroplanes operated under IFR or at night shall be equipped with a transmit button on the manual pitch and roll control for each required flight crew member.

AMC1 SPO.IDE.A.210 Headset

ED Decision 2014/018/R

GENERAL

- (a) A headset consists of a communication device that includes two earphones to receive and a microphone to transmit audio signals to the aeroplane's communication system. To comply with the minimum performance requirements, the earphones and microphone should match the communication system's characteristics and the flight crew compartment environment. The headset should be adequately adjustable in order to fit the flight crew's head. Headset boom microphones should be of the noise cancelling type.
- (b) If the intention is to utilise noise cancelling earphones, the operator should ensure that the earphones do not attenuate any aural warnings or sounds necessary for alerting the flight crew on matters related to the safe operation of the aeroplane.

GM1 SPO.IDE.A.210 Headset

ED Decision 2014/018/R

GENERAL

The term 'headset' includes any aviation helmet incorporating headphones and microphone worn by a flight crew member.

SPO.IDE.A.215 Radio communication equipment

Regulation (EU) No 379/2014

- (a) Aeroplanes operated under IFR or at night, or when required by the applicable airspace requirements, shall be equipped with radio communication equipment that, under normal radio propagating conditions, shall be capable of:
 - (1) conducting two-way communication for aerodrome control purposes;
 - (2) receiving meteorological information at any time during flight;
 - (3) conducting two-way communication at any time during flight with those aeronautical stations and on those frequencies prescribed by the appropriate authority; and
 - (4) providing for communication on the aeronautical emergency frequency 121,5 MHz.

- (b) When more than one communication equipment unit is required, each shall be independent of the other or others to the extent that a failure in any one will not result in failure of any other.

AMC1 SPO.IDE.A.215 & SPO.IDE.A.220 Radio communication equipment & Navigation equipment

ED Decision 2021/005/R

PERFORMANCE-BASED COMMUNICATION AND SURVEILLANCE (PBCS) OPERATIONS

For operations in airspaces where required communication performance (RCP) and required surveillance performance (RSP) for PBCS have been prescribed, the operator should:

- (a) ensure that communication and surveillance equipment meet the prescribed RCP and RSP specifications respectively, as shown by an AFM statement or equivalent.
- (b) ensure that operational constraints are reflected in the MEL;
- (c) establish and include in the OM:
 - (1) normal, abnormal and contingency procedures;
 - (2) the flight crew qualification and proficiency constraints; and
 - (3) a training programme for relevant personnel consistent with the intended operations;
- (d) ensure continued airworthiness of the communication equipment and surveillance equipment in accordance with the appropriate RCP and RSP specifications respectively;
- (e) ensure that the contracted communication service provider (CSP) for the airspace being flown complies with the required RCP and RSP specifications as well as monitoring, recording and notification requirements; and
- (f) participate to monitoring programmes established in the airspace being flown in order to:
 - (1) submit the relevant reports of observed communication and surveillance performance respectively; and
 - (2) establish a process for immediate corrective action in case a non-compliance with the appropriate RCP or RSP specifications is detected.

GM1 SPO.IDE.A.215 Radio communication equipment

ED Decision 2014/018/R

APPLICABLE AIRSPACE REQUIREMENTS

For aeroplanes being operated under European air traffic control, the applicable airspace requirements include the Single European Sky legislation.

GM1 SPO.IDE.A.215 & SPO.IDE.A.220 Radio communication equipment & Navigation equipment

ED Decision 2021/005/R

PBCS OPERATIONS — GENERAL

Detailed guidance material on PBCS operations may be found in the following documents:

- (a) ICAO Doc 9869 'Performance-based Communication and Surveillance (PBCS) Manual'
- (b) ICAO Doc 10037 'Global Operational Data Link (GOLD) Manual'

PBCS OPERATIONS — AIRCRAFT ELIGIBILITY

- (a) The aircraft eligibility for compliance with the required RCP/RSP specifications should be demonstrated by the aircraft manufacturer or equipment supplier and be specific to each individual aircraft or the combination of the aircraft type and the equipment. The demonstrated compliance with specific RCP/RSP specifications may be documented in one of the following documents:
- (1) the type certificate (TC);
 - (2) the supplemental type certificate (STC);
 - (3) the aeroplane flight manual (AFM) or AFM Supplement; or
 - (4) a compliance statement from the manufacturer or the holder of the design approval of the data link installation, approved by the State of Design.
- (b) In addition to the indication of compliance with specific RCP/RSP specifications, the aircraft manufacturer or equipment supplier should document any associated operating limitations, information and procedures in the AFM or other appropriate documents.

PBCS OPERATIONS — MEL ENTRIES

- (a) The operator should amend the MEL, in accordance with the items identified by the aircraft manufacturer or equipment supplier in the master minimum equipment list (MMEL) or MMEL supplement, in relation to PBCS capability, to address the impact of losing an associated system/sub-system on data link operational capability.
- (b) As an example, equipment required in current FANS 1/A-capable aircraft, potentially affecting RCP and RSP capabilities, may be the following:
- (1) VHF, SATCOM, or HFDL1 radios, as applicable;
 - (2) ACARS management unit (MU)/communications management unit (CMU);
 - (3) flight management computer (FMC) integration; and
 - (4) printer, if procedures require its use.

PBCS OPERATIONS — OPERATING PROCEDURES

The operator should establish operating procedures for the flight crew and other relevant personnel, such as but not limited to, flight dispatchers and maintenance personnel. These procedures should cover the usage of PBCS-relevant systems and include as a minimum:

- (a) pre-flight planning requirements including MEL consideration and flight plan filing;
- (b) actions to be taken in the data link operation, to include specific RCP/RSP required cases;
- (c) actions to be taken for the loss of data link capability while in and prior to entering the airspace requiring specific RCP/RSP specifications. Examples may be found in ICAO Doc 10037;
- (d) problem reporting procedures to the local/regional PBCS monitoring body or central reporting body as applicable; and
- (e) compliance with specific regional requirements and procedures, if applicable.

PBCS OPERATIONS — QUALIFICATION AND TRAINING

- (a) The operator should ensure that flight crew and other relevant personnel such as flight dispatchers and maintenance personnel are proficient with PBCS operations. A separate training programme is not required if data link communication is integrated in the current

training programme. However, the operator should ensure that the existing training programme incorporates a basic PBCS concept and requirements for flight crew and other personnel that have direct impact on overall data link performance required for the provisions of ATS such as reduced separation.

(b) The elements covered during the training should be as a minimum:

(1) Flight crew

- (i) Data link communication system theory relevant to operational use;
- (ii) AFM limitations;
- (iii) Normal pilot response to data link communication messages;
- (iv) Message elements in the message set used in each environment;
- (v) RCP/RSP specifications and their performance requirements;
- (vi) Implementation of performance-based reduced separation with associated RCP/RSP specifications or other possible performance requirements associated with their routes;
- (vii) Other ATM operations involving data link communication services;
- (viii) Normal, non-normal and contingency procedures; and
- (ix) Data link communication failure/problem and reporting.

Note (1) If flight crew has already been trained on data link operations, additional training only on PBCS is required, addressing a basic concept and requirements that have direct impact on overall data link performance required for provisions of ATS (e.g. reduced separation).

Note (2) Training may be provided through training material and other means that simulate the functionality.

(2) Dispatchers/flight operations officers

- (i) Proper use of data link and PBCS flight plan designators;
- (ii) Air traffic service provider's separation criteria and procedures relevant to RCP/RSP specifications;
- (iii) MEL remarks or exceptions based on data link communication;
- (iv) Procedures for transitioning to voice communication and other contingency procedures related to the operation in the event of abnormal behavior of the data link communication;
- (v) Coordination with the ATS unit related to, or following a special data link communication exceptional event (e.g. log-on or connection failures); and
- (vi) Contingency procedures to transition to a different separation standard when data link communication fails.

(3) Engineering and maintenance personnel

- (i) Data link communication equipment including its installation, maintenance and modification;
- (ii) MEL relief and procedures for return to service authorisations; and

- (iii) Correction of reported non-performance of data link system.

PBCS OPERATIONS — CONTINUED AIRWORTHINESS

- (a) The operator should ensure that aircraft systems are properly maintained to continue to meet the applicable RCP/RSP specifications.
- (b) The operator should ensure that the following elements are documented and managed appropriately:
- (1) configuration and equipment list detailing the pertinent hardware and software components for the aircraft/fleet(s) applicable to the specific RCP/RSP operation;
 - (2) configuration control for subnetwork, communication media and routing policies; and
 - (3) description of systems including display and alerting functions (including message sets).

PBCS OPERATIONS — CSP COMPLIANCE

- (a) The operator should ensure that their contracted CSPs notify the ATS units of any failure condition that may have an impact on PBCS operations. Notification should be made to all relevant ATS units regardless of whether the CSP has a contract with them.
- (b) The operator may demonstrate the compliance of their contracted CSP through service level agreements (SLAs)/contractual arrangements for data link services or through a joint agreement among PBCS stakeholders such as a Memorandum of Understanding (MOU) or a PBCS Charter.

PBCS OPERATIONS — PBCS CHARTER

A PBCS charter has been developed by PBCS stakeholders and is available as an alternative to SLAs in order to validate the agreement between the operator and the CSP for compliance with RCP/RSP required for PBCS operations. The charter is hosted on the website www.FANS-CRA.com where operators and CSPs can subscribe.

PBCS OPERATIONS — PARTICIPATION IN MONITORING PROGRAMMES

- (a) The operator should establish a process to participate in local or regional PBCS monitoring programmes and provide the following information, including any subsequent changes, to monitoring bodies:
- (1) operator name;
 - (2) operator contact details; and
 - (3) other coordination information as applicable, including appropriate information means for the CSP/SSP service fail notification.
- (b) The process should also address the actions to be taken with respect to problem reporting and resolution of deficiencies, such as:
- (1) reporting problems identified by the flight crew or other personnel to the PBCS monitoring bodies associated with the route of flight on which the problem occurred
 - (2) disclosing operational data in a timely manner to the appropriate PBCS monitoring bodies when requested for the purposes of investigating a reported problem
 - (3) investigating and resolving the cause of the deficiencies reported by the PBCS monitoring bodies.

SPO.IDE.A.220 Navigation equipment

Regulation (EU) 2019/1384

- (a) Aeroplanes shall be equipped with navigation equipment that will enable them to proceed in accordance with:
 - (1) the ATS flight plan, if applicable; and
 - (2) the applicable airspace requirements.
- (b) Aeroplanes shall have sufficient navigation equipment to ensure that, in the event of the failure of one item of equipment at any stage of the flight, the remaining equipment shall allow safe navigation in accordance with (a), or an appropriate contingency action to be completed safely.
- (c) Aeroplanes operated on flights in which it is intended to land in IMC shall be equipped with suitable equipment capable of providing guidance to a point from which a visual landing can be performed. This equipment shall be capable of providing such guidance for each aerodrome at which it is intended to land in IMC and for any designated alternate aerodromes.
- (d) For PBN operations the aircraft shall meet the airworthiness certification requirements for the appropriate navigation specification.
- (e) Aeroplanes shall be equipped with surveillance equipment in accordance with the applicable airspace requirements.

AMC1 SPO.IDE.A.220 Navigation equipment

ED Decision 2014/018/R

NAVIGATION WITH VISUAL REFERENCE TO LANDMARKS — OTHER-THAN COMPLEX AEROPLANES

Where other-than complex aeroplanes, with the surface in sight, can proceed according to the ATS flight plan by navigation with visual reference to landmarks, no additional equipment is needed to comply with [SPO.IDE.A.220\(a\)\(1\)](#).

GM1 SPO.IDE.A.220 Navigation equipment

ED Decision 2016/021/R

AIRCRAFT ELIGIBILITY FOR PBN SPECIFICATION NOT REQUIRING SPECIFIC APPROVAL

- (a) The performance of the aircraft is usually stated in the AFM.
- (b) Where such a reference cannot be found in the AFM, other information provided by the aircraft manufacturer as TC holder, the STC holder or the design organisation having a privilege to approve minor changes may be considered.
- (c) The following documents are considered acceptable sources of information:
 - (1) AFM, supplements thereto, and documents directly referenced in the AFM;
 - (2) FCOM or similar document;
 - (3) Service Bulletin or Service Letter issued by the TC holder or STC holder;
 - (4) approved design data or data issued in support of a design change approval;
 - (5) any other formal document issued by the TC or STC holders stating compliance with PBN specifications, AMC, Advisory Circulars (AC) or similar documents issued by the State of Design; and
 - (6) written evidence obtained from the State of Design.

-
- (d) Equipment qualification data, in itself, is not sufficient to assess the PBN capabilities of the aircraft, since the latter depend on installation and integration.
- (e) As some PBN equipment and installations may have been certified prior to the publication of the PBN Manual and the adoption of its terminology for the navigation specifications, it is not always possible to find a clear statement of aircraft PBN capability in the AFM. However, aircraft eligibility for certain PBN specifications can rely on the aircraft performance certified for PBN procedures and routes prior to the publication of the PBN Manual.
- (f) Below, various references are listed which may be found in the AFM or other acceptable documents (see listing above) in order to consider the aircraft's eligibility for a specific PBN specification if the specific term is not used.
- (g) RNAV 5
- (1) If a statement of compliance with any of the following specifications or standards is found in the acceptable documentation as listed above, the aircraft is eligible for RNAV 5 operations.
- (i) B-RNAV;
 - (ii) RNAV 1;
 - (iii) RNP APCH;
 - (iv) RNP 4;
 - (v) A-RNP;
 - (vi) AMC 20-4;
 - (vii) JAA TEMPORARY GUIDANCE MATERIAL, LEAFLET NO. 2 (TGL 2);
 - (viii) JAA AMJ 20X2;
 - (ix) FAA AC 20-130A for en route operations;
 - (x) FAA AC 20-138 for en route operations; and
 - (xi) FAA AC 90-96.
- (h) RNAV 1/RNAV 2
- (1) If a statement of compliance with any of the following specifications or standards is found in the acceptable documentation as listed above, the aircraft is eligible for RNAV 1/RNAV 2 operations.
- (i) RNAV 1;
 - (ii) PRNAV
 - (iii) US RNAV type A;
 - (iv) FAA AC 20-138 for the appropriate navigation specification;
 - (v) FAA AC 90-100A;
 - (vi) JAA TEMPORARY GUIDANCE MATERIAL, LEAFLET NO. 10 Rev1 (TGL 10); and
 - (vii) FAA AC 90-100.
- (2) However, if position determination is exclusively computed based on VOR-DME, the aircraft is not eligible for RNAV 1/RNAV 2 operations.

-
- (i) RNP 1/RNP 2 continental
- (1) If a statement of compliance with any of the following specifications or standards is found in the acceptable documentation as listed above, the aircraft is eligible for RNP 1/RNP 2 continental operations.
- (i) A-RNP;
 - (ii) FAA AC 20-138 for the appropriate navigation specification; and
 - (iii) FAA AC 90-105.
- (2) Alternatively, if a statement of compliance with any of the following specifications or standards is found in the acceptable documentation as listed above and position determination is primarily based on GNSS, the aircraft is eligible for RNP 1/RNP 2 continental operations. However, in these cases, loss of GNSS implies loss of RNP 1/RNP 2 capability.
- (i) JAA TEMPORARY GUIDANCE MATERIAL, LEAFLET NO. 10 (TGL 10) (any revision); and
 - (ii) FAA AC 90-100.
- (j) RNP APCH — LNAV minima
- (1) If a statement of compliance with any of the following specifications or standards is found in the acceptable documentation as listed above, the aircraft is eligible for RNP APCH — LNAV operations.
- (i) A-RNP;
 - (ii) AMC 20-27;
 - (iii) AMC 20-28;
 - (iv) FAA AC 20-138 for the appropriate navigation specification; and
 - (v) FAA AC 90-105 for the appropriate navigation specification.
- (2) Alternatively, if a statement of compliance with RNP 0.3 GNSS approaches in accordance with any of the following specifications or standards is found in the acceptable documentation as listed above, the aircraft is eligible for RNP APCH — LNAV operations. Any limitation such as ‘within the US National Airspace’ may be ignored since RNP APCH procedures are assumed to meet the same ICAO criteria around the world.
- (i) JAA TEMPORARY GUIDANCE MATERIAL, LEAFLET NO. 3 (TGL 3);
 - (ii) AMC 20-4;
 - (iii) FAA AC 20-130A; and
 - (iv) FAA AC 20-138.
- (k) RNP APCH — LNAV/VNAV minima
- (1) If a statement of compliance with any of the following specifications or standards is found in the acceptable documentation as listed above, the aircraft is eligible for RNP APCH — LNAV/VNAV operations.
- (i) A-RNP;
 - (ii) AMC 20-27 with Baro VNAV;

- (iii) AMC 20-28;
 - (iv) FAA AC 20-138; and
 - (v) FAA AC 90-105 for the appropriate navigation specification.
 - (2) Alternatively, if a statement of compliance with FAA AC 20-129 is found in the acceptable documentation as listed above, and the aircraft complies with the requirements and limitations of EASA SIB 2014-04¹, the aircraft is eligible for RNP APCH — LNAV/VNAV operations. Any limitation such as ‘within the US National Airspace’ may be ignored since RNP APCH procedures are assumed to meet the same ICAO criteria around the world.
- (l) RNP APCH — LPV minima
- (1) If a statement of compliance with any of the following specifications or standards is found in the acceptable documentation as listed above, the aircraft is eligible for RNP APCH — LPV operations.
 - (i) AMC 20-28;
 - (ii) FAA AC 20-138 for the appropriate navigation specification; and
 - (iii) FAA AC 90-107.
 - (2) For aircraft that have a TAWS Class A installed and do not provide Mode-5 protection on an LPV approach, the DH is limited to 250 ft.
- (m) RNAV 10
- (1) If a statement of compliance with any of the following specifications or standards is found in the acceptable documentation as listed above, the aircraft is eligible for RNAV 10 operations.
 - (i) RNP 10;
 - (ii) FAA AC 20-138 for the appropriate navigation specification;
 - (iii) AMC 20-12;
 - (iv) FAA Order 8400.12 (or later revision); and
 - (v) FAA AC 90-105.
- (n) RNP 4
- (1) If a statement of compliance with any of the following specifications or standards is found in the acceptable documentation as listed above, the aircraft is eligible for RNP 4 operations.
 - (i) FAA AC 20-138B or later, for the appropriate navigation specification;
 - (ii) FAA Order 8400.33; and
 - (iii) FAA AC 90-105 for the appropriate navigation specification.
- (o) RNP 2 oceanic
- (1) If a statement of compliance with FAA AC 90-105 for the appropriate navigation specification is found in the acceptable documentation as listed above, the aircraft is eligible for RNP 2 oceanic operations.

¹ <http://ad.easa.europa.eu/ad/2014-04>

- (2) If the aircraft has been assessed eligible for RNP 4, the aircraft is eligible for RNP 2 oceanic.
- (p) Special features
 - (1) RF in terminal operations (used in RNP 1 and in the initial segment of the RNP APCH)
 - (i) If a statement of demonstrated capability to perform an RF leg, certified in accordance with any of the following specifications or standards, is found in the acceptable documentation as listed above, the aircraft is eligible for RF in terminal operations:
 - (A) AMC 20-26; and
 - (B) FAA AC 20-138B or later.
 - (ii) If there is a reference to RF and a reference to compliance with AC 90-105, then the aircraft is eligible for such operations.
- (q) Other considerations
 - (1) In all cases, the limitations in the AFM need to be checked, in particular the use of AP or FD which can be required to reduce the FTE primarily for RNP APCH, RNAV 1, and RNP 1.
 - (2) Any limitation such as 'within the US National Airspace' may be ignored since RNP APCH procedures are assumed to meet the same ICAO criteria around the world.

GM2 SPO.IDE.A.220 Navigation equipment

ED Decision 2016/021/R

GENERAL

- (a) The PBN specifications for which the aircraft complies with the relevant airworthiness criteria are set out in the AFM, together with any limitations to be observed.
- (b) Because functional and performance requirements are defined for each navigation specification, an aircraft approved for an RNP specification is not automatically approved for all RNAV specifications. Similarly, an aircraft approved for an RNP or RNAV specification having a stringent accuracy requirement (e.g. RNP 0.3 specification) is not automatically approved for a navigation specification having a less stringent accuracy requirement (e.g. RNP 4).

RNP 4

- (c) For RNP 4, at least two LRNSs, capable of navigating to RNP 4, and listed in the AFM, may be operational at the entry point of the RNP 4 airspace. If an item of equipment required for RNP 4 operations is unserviceable, then the flight crew may consider an alternate route or diversion for repairs. For multi-sensor systems, the AFM may permit entry if one GNSS sensor is lost after departure, provided one GNSS and one inertial sensor remain available.

SPO.IDE.A.225 Transponder

Regulation (EU) No 379/2014

Where required by the airspace being flown, aeroplanes shall be equipped with a secondary surveillance radar (SSR) transponder with all the required capabilities.

AMC1 SPO.IDE.A.225 Transponder

ED Decision 2014/018/R

GENERAL

- (a) The secondary surveillance radar (SSR) transponders of aeroplanes being operated under European air traffic control should comply with any applicable Single European Sky legislation.
- (b) If the Single European Sky legislation is not applicable, the SSR transponders should operate in accordance with the relevant provisions of Volume IV of ICAO Annex 10.

SPO.IDE.A.230 Management of aeronautical databases

Regulation (EU) 2016/1199

- (a) Aeronautical databases used on certified aircraft system applications shall meet data quality requirements that are adequate for the intended use of the data.
- (b) The operator shall ensure the timely distribution and insertion of current and unaltered aeronautical databases to all aircraft that require them.
- (c) Notwithstanding any other occurrence reporting requirements as defined in Regulation (EU) No 376/2014, the operator shall report to the database provider instances of erroneous, inconsistent or missing data that might be reasonably expected to constitute a hazard to flight.

In such cases, the operator shall inform flight crew and other personnel concerned, and shall ensure that the affected data is not used.

AMC1 SPO.IDE.A.230 Management of aeronautical databases

ED Decision 2017/003/R

AERONAUTICAL DATABASES

When the operator of an aircraft uses an aeronautical database that supports an airborne navigation application as a primary means of navigation used to meet the airspace usage requirements, the database provider should be a Type 2 DAT provider certified in accordance with Regulation (EU) 2017/373 or equivalent.

GM1 SPO.IDE.A.230 Management of aeronautical databases

ED Decision 2017/003/R

AERONAUTICAL DATABASE APPLICATIONS

- (a) Applications using aeronautical databases for which Type 2 DAT providers should be certified in accordance with Regulation (EU) 2017/373 may be found in GM1 DAT.OR.100.
- (b) The certification of a Type 2 DAT provider in accordance with Regulation (EU) 2017/373 ensures data integrity and compatibility with the certified aircraft application/equipment.

GM2 SPO.IDE.A.230 Management of aeronautical databases

ED Decision 2017/003/R

TIMELY DISTRIBUTION

The operator should distribute current and unaltered aeronautical databases to all aircraft requiring them in accordance with the validity period of the databases or in accordance with a procedure established in the operations manual if no validity period is defined.

GM3 SPO.IDE.A.230 Management of aeronautical databases

ED Decision 2017/003/R

STANDARDS FOR AERONAUTICAL DATABASES AND DAT PROVIDERS

- (a) A 'Type 2 DAT provider' is an organisation as defined in Article 2(5)(b) of Regulation (EU) 2017/373.
- (b) Equivalent to a certified 'Type 2 DAT provider' is defined in any Aviation Safety Agreement between the European Union and a third country, including any Technical Implementation Procedures, or any Working Arrangements between EASA and the competent authority of a third country.

SECTION 2 – HELICOPTERS

SPO.IDE.H.100 Instruments and equipment – general

Regulation (EU) 2019/1384

- (a) Instruments and equipment required by this Subpart shall be approved in accordance with the applicable airworthiness requirements if they are:
 - (1) used by the flight crew to control the flight path;
 - (2) used to comply with [SPO.IDE.H.215](#);
 - (3) used to comply with [SPO.IDE.H.220](#); or
 - (4) installed in the helicopter.
- (b) The following items, when required by this Subpart, do not need an equipment approval:
 - (1) independent portable lights;
 - (2) an accurate time piece;
 - (3) first-aid kit;
 - (4) survival and signalling equipment;
 - (5) sea anchor and equipment for mooring;
 - (6) child restraint device;
 - (7) a simple PCDS used by a task specialist as a restraint device.
- (c) Instruments, equipment or accessories not required under this Annex (Part-SPO), as well as any other equipment that is not required under this Regulation, but carried on a flight, shall comply with the following requirements:
 - (1) the information provided by those instruments, equipment or accessories shall not be used by the flight crew members to comply with Annex II to Regulation (EU) 2018/1139 or points [SPO.IDE.H.215](#) and [SPO.IDE.H.220](#) of this Annex;
 - (2) the instruments, equipment or accessories shall not affect the airworthiness of the helicopter, even in the case of failures or malfunction.
- (d) Instruments and equipment shall be readily operable or accessible from the station where the flight crew member that needs to use it is seated.

- (e) Those instruments that are used by a flight crew member shall be so arranged as to permit the flight crew member to see the indications readily from his/her station, with the minimum practicable deviation from the position and line of vision which he/she normally assumes when looking forward along the flight path.
- (f) All required emergency equipment shall be easily accessible for immediate use.

GM1 SPO.IDE.H.100(a) Instruments and equipment – general

ED Decision 2014/018/R

APPLICABLE AIRWORTHINESS REQUIREMENTS

The applicable airworthiness requirements for approval of instruments and equipment required by this Part are the following:

- (a) Commission Regulation (EU) No 748/2012 for helicopters registered in the EU; and
- (b) Airworthiness requirements of the state of registry for helicopters registered outside the EU.

GM1 SPO.IDE.H.100(b) Instruments and equipment – general

ED Decision 2014/018/R

REQUIRED INSTRUMENTS AND EQUIPMENT THAT DO NOT NEED TO BE APPROVED IN ACCORDANCE WITH THE APPLICABLE AIRWORTHINESS REQUIREMENTS

The functionality of non-installed instruments and equipment required by this Subpart and that do not need an equipment approval, as listed in [SPO.IDE.H.100\(b\)](#), should be checked against recognised industry standards appropriate to the intended purpose. The operator is responsible for ensuring the maintenance of these instruments and equipment.

GM1 SPO.IDE.H.100(c) Instruments and equipment – general

ED Decision 2014/018/R

NOT REQUIRED INSTRUMENTS AND EQUIPMENT THAT DO NOT NEED TO BE APPROVED IN ACCORDANCE WITH THE APPLICABLE AIRWORTHINESS REQUIREMENTS, BUT ARE CARRIED ON A FLIGHT

- (a) The provision of this paragraph does not exempt any installed instrument or item of equipment from complying with the applicable airworthiness requirements. In this case, the installation should be approved as required in the applicable airworthiness requirements and should comply with the applicable Certification Specifications.
- (b) The failure of additional non-installed instruments or equipment not required by this Part or by the applicable airworthiness requirements or any applicable airspace requirements should not adversely affect the airworthiness and/or the safe operation of the helicopter. Examples may be the following:
 - (1) portable electronic flight bag (EFB);
 - (2) portable electronic devices carried by crew members or task specialists; and
 - (3) non-installed task specialists equipment.

GM1 SPO.IDE.H.100(d) Instruments and equipment – general

ED Decision 2014/018/R

POSITIONING OF INSTRUMENTS

This requirement implies that whenever a single instrument is required in a helicopter operated in a multi-crew environment, the instrument needs to be visible from each flight crew station.

SPO.IDE.H.105 Minimum equipment for flight

Regulation (EU) 2019/1384

A flight shall not be commenced when any of the helicopter's instruments, items of equipment or functions required for the intended flight is inoperative or missing, unless either of the following conditions is fulfilled:

- (a) the helicopter is operated in accordance with the minimum equipment list (MEL);
- (b) for complex motor-powered helicopters, and for any helicopter used in commercial operations, the operator is approved by the competent authority to operate the helicopter within the constraints of the master minimum equipment list (MMEL) in accordance with point [ORO.MLR.105\(j\)](#) of Annex III;
- (c) the helicopter is subject to a permit to fly issued in accordance with the applicable airworthiness requirements.

AMC1 SPO.IDE.H.105 Minimum equipment for flight

ED Decision 2021/005/R

MANAGEMENT OF THE STATUS OF CERTAIN INSTRUMENTS, EQUIPMENT OR FUNCTIONS

The operator should control and retain the status of the instruments, equipment or functions required for the intended operation, that are not controlled for the purpose of continuing airworthiness management.

GM1 SPO.IDE.H.105 Minimum equipment for flight

ED Decision 2021/005/R

MANAGEMENT OF THE STATUS OF CERTAIN INSTRUMENTS, EQUIPMENT OR FUNCTIONS

- (a) The operator should define responsibilities and procedures to retain and control the status of instruments, equipment or functions required for the intended operation, that are not controlled for the purpose of continuing airworthiness management.
- (b) Examples of such instruments, equipment or functions may be, but are not limited to, equipment related to navigation approvals as FM immunity or certain software versions.

SPO.IDE.H.115 Operating lights

Regulation (EU) No 379/2014

Helicopters operated at night shall be equipped with:

- (a) an anti-collision light system;
- (b) navigation/position lights;
- (c) a landing light;

- (d) lighting supplied from the helicopter's electrical system to provide adequate illumination for all instruments and equipment essential to the safe operation of the helicopter;
- (e) lighting supplied from the helicopter's electrical system to provide illumination in all cabin compartments;
- (f) an independent portable light for each crew member station; and
- (g) lights to conform with the International Regulations for Preventing Collisions at Sea if the helicopter is amphibious.

AMC1 SPO.IDE.H.115 Operating lights

ED Decision 2014/018/R

LANDING LIGHT

The landing light should be trainable, at least in the vertical plane, or optionally be an additional fixed light or lights positioned to give a wide spread of illumination.

SPO.IDE.H.120 Operations under VFR – flight and navigational instruments and associated equipment

Regulation (EU) 2019/1384

- (a) Helicopters operated under VFR by day shall be equipped with a means of measuring and displaying the following:
 - (1) magnetic heading,
 - (2) time in hours, minutes and seconds,
 - (3) barometric altitude,
 - (4) indicated airspeed, and
 - (5) slip.
- (b) Helicopters operated under VMC overwater and out of sight of the land or under VMC at night, shall be, in addition to (a), equipped with:
 - (1) a means of measuring and displaying:
 - (i) attitude,
 - (ii) vertical speed, and
 - (iii) stabilised heading;
 - (2) a means of indicating when the supply of power to the gyroscopic instruments is not adequate; and
 - (3) for complex motor-powered helicopters, a means of preventing malfunction of the airspeed indicating system required in (a)(4) due to condensation or icing.
- (c) Helicopters operated when the visibility is less than 1 500 m, or in conditions where they cannot be maintained in a desired flight path without reference to one or more additional instruments, shall be, in addition to (a) and (b), equipped with a means of preventing malfunction of the airspeed indicating system required in (a)(4) due to condensation or icing.

- (d) Whenever two pilots are required for the operation, helicopters shall be equipped with an additional separate means of displaying:
- (1) barometric altitude,
 - (2) indicated airspeed,
 - (3) slip,
 - (4) attitude, if applicable,
 - (5) vertical speed, if applicable, and
 - (6) stabilised heading, if applicable.

AMC1 SPO.IDE.H.120 & SPO.IDE.H.125 Operations under VFR & operations under IFR – flight and navigational instruments and associated equipment

ED Decision 2014/018/R

INTEGRATED INSTRUMENTS

- (a) Individual equipment requirements may be met by combinations of instruments, by integrated flight systems or by a combination of parameters on electronic displays. The information so available to each required pilot should not be less than that required in the applicable operational requirements, and the equivalent safety of the installation should be approved during type certification of the helicopter for the intended type of operation.
- (b) The means of measuring and indicating turn and slip, helicopter attitude and stabilised helicopter heading may be met by combinations of instruments or by integrated flight director systems, provided that the safeguards against total failure, inherent in the three separate instruments, are retained.

AMC1 SPO.IDE.H.120(a)(1) & SPO.IDE.H.125(a)(1) Operations under VFR & operations under IFR – flight and navigational instruments and associated equipment

ED Decision 2014/018/R

MEANS OF MEASURING AND DISPLAYING MAGNETIC HEADING

The means of measuring and displaying magnetic direction should be a magnetic compass or equivalent.

AMC1 SPO.IDE.H.120(a)(2) & SPO.IDE.H.125(a)(2) Operations under VFR & operations under IFR – flight and navigational instruments and associated equipment

ED Decision 2014/018/R

MEANS OF MEASURING AND DISPLAYING THE TIME — COMPLEX MOTOR-POWERED AIRCRAFT

An acceptable means of compliance is a clock displaying hours, minutes and seconds, with a sweep-second pointer or digital presentation.

MEANS OF MEASURING AND DISPLAYING THE TIME — OTHER-THAN-COMPLEX MOTOR-POWERED AIRCRAFT

An acceptable means of measuring and displaying the time in hours, minutes and seconds may be a wrist watch capable of the same functions.

AMC1 SPO.IDE.H.120(a)(3) & SPO.IDE.H.125(a)(3) Operations under VFR & operations under IFR – flight and navigational instruments and associated equipment*ED Decision 2014/018/R***CALIBRATION OF THE MEANS OF MEASURING AND DISPLAYING PRESSURE ALTITUDE**

The instrument measuring and displaying pressure altitude should be of a sensitive type calibrated in feet (ft), with a sub-scale setting, calibrated in hectopascals/millibars, adjustable for any barometric pressure likely to be set during flight.

AMC1 SPO.IDE.H.120(a)(4) & SPO.IDE.H.125(a)(4) Operations under VFR & operations under IFR – flight and navigational instruments and associated equipment*ED Decision 2015/006/R***CALIBRATION OF THE INSTRUMENT INDICATING AIRSPEED**

- (a) The instrument indicating airspeed should be calibrated in knots (kt).
- (b) In the case of helicopters with an MCTOM below 2 000 kg, calibration in kilometres per hour (kph) or in miles per hour (mph) is acceptable when such units are used in the AFM.

AMC1 SPO.IDE.H.120(a)(5) Operations under VFR – flight and navigational instruments and associated equipment*ED Decision 2014/018/R***SLIP**

For other-than complex helicopters the means of measuring and displaying slip may be a slip string for operations under VFR.

AMC1 SPO.IDE.H.120(b)(1)(iii) & SPO.IDE.H.125(a)(8) Operations under VFR & operations under IFR – flight and navigational instruments and associated equipment*ED Decision 2014/018/R***STABILISED HEADING**

Stabilised direction should be achieved for VFR flights by a gyroscopic direction indicator, whereas for IFR flights, this should be achieved through a magnetic gyroscopic direction indicator.

AMC1 SPO.IDE.H.120(b)(3) & SPO.IDE.H.125(d) Operations under VFR & operations under IFR – flight and navigational instruments and associated equipment

ED Decision 2014/018/R

MEANS OF PREVENTING MALFUNCTION DUE TO CONDENSATION OR ICING

The means of preventing malfunction due to either condensation or icing of the airspeed indicating system should be a heated pitot tube or equivalent.

AMC1 SPO.IDE.H.120(d) Operations under VFR — flight and navigational instruments and associated equipment

ED Decision 2022/012/R

MULTI-PILOT OPERATIONS

Two pilots should be considered to be required by the operation if multi-pilot operations are required by one of the following:

- (a) the AFM;
- (b) at night, the operations manual.

GM1 SPO.IDE.H.120(d) Operations under VFR — flight and navigational instruments and associated equipment

ED Decision 2022/012/R

MULTI-PILOT OPERATIONS ON A VOLUNTARY BASIS — HELICOPTERS OPERATED BY DAY UNDER VFR

If the AFM permits single-pilot operations, and the operator decides that the crew composition is more than one pilot for day VFR operations only, then point [SPO.IDE.H.120\(d\)](#) does not apply. Additional displays, including those referred to in [SPO.IDE.H.120\(d\)](#), may be required under point [SPO.IDE.H.100\(e\)](#).

AMC1 SPO.IDE.H.120(d) & SPO.IDE.H.125(c) Operations under VFR & operations under IFR – flight and navigational instruments and associated equipment

ED Decision 2014/018/R

MULTI-PILOT OPERATIONS — DUPLICATE INSTRUMENTS

Duplicate instruments include separate displays for each pilot and separate selectors or other associated equipment where appropriate.

SPO.IDE.H.125 Operations under IFR – flight and navigational instruments and associated equipment

Regulation (EU) 2019/1384

Helicopters operated under IFR shall be equipped with:

- (a) a means of measuring and displaying:

- (1) magnetic heading,
 - (2) time in hours, minutes and seconds,
 - (3) barometric altitude,
 - (4) indicated airspeed,
 - (5) vertical speed,
 - (6) slip,
 - (7) attitude,
 - (8) stabilised heading, and
 - (9) outside air temperature;
- (b) a means of indicating when the supply of power to the gyroscopic instruments is not adequate;
- (c) whenever two pilots are required for the operation, an additional separate means of displaying:
- (1) barometric altitude,
 - (2) indicated airspeed,
 - (3) vertical speed,
 - (4) slip,
 - (5) attitude, and
 - (6) stabilised heading;
- (d) a means of preventing malfunction of the airspeed indicating system required by (a)(4) and (c)(2) due to condensation or icing;
- (e) an additional means of measuring and displaying attitude as a standby instrument; and
- (f) the following for complex motor-powered helicopters:
- (1) an alternate source of static pressure; and
 - (2) a chart holder in an easily readable position that can be illuminated for night operations.

GM1 SPO.IDE.H.125(a)(3) Operations under IFR – flight and navigational instruments and associated equipment

ED Decision 2014/018/R

ALTIMETERS

Altimeters with counter drum-pointer or equivalent presentation are considered to be less susceptible to misinterpretation for helicopters operating above 10 000 ft.

AMC1 SPO.IDE.H.125(a)(9) Operations under IFR – flight and navigational instruments and associated equipment

ED Decision 2014/018/R

MEANS OF DISPLAYING OUTSIDE AIR TEMPERATURE

- (a) The means of displaying outside air temperature should be calibrated in degrees Celsius.

- (b) In the case of helicopters with a maximum certified take-off mass (MCTOM) below 2 000 kg, calibration in degrees Fahrenheit is acceptable, when such unit is used in the AFM.
- (c) The means of displaying outside air temperature may be an air temperature indicator that provides indications that are convertible to outside air temperature.

AMC1 SPO.IDE.H.125(c) Operations under IFR — flight and navigational instruments and associated equipment

ED Decision 2022/012/R

MULTI-PILOT OPERATIONS

Two pilots should be considered to be required by the operation if multi-pilot operations are required by one of the following:

- (a) the AFM;
- (b) the operations manual.

AMC1 SPO.IDE.H.125(f)(2) Operations under IFR – flight and navigational instruments and associated equipment

ED Decision 2014/018/R

CHART HOLDER

An acceptable means of compliance with the chart holder requirement would be to display a pre-composed chart on an electronic flight bag (EFB).

SPO.IDE.H.126 Additional equipment for single-pilot operation under IFR

Regulation (EU) No 379/2014

Helicopters operated under IFR with a single pilot shall be equipped with an autopilot with at least altitude hold and heading mode.

SPO.IDE.H.132 Airborne weather detecting equipment – complex motor-powered helicopters

Regulation (EU) No 379/2014

Helicopters operated under IFR or at night shall be equipped with airborne weather detecting equipment when current weather reports indicate that thunderstorms or other potentially hazardous weather conditions, regarded as detectable with airborne weather detecting equipment, may be expected to exist along the route to be flown.

AMC1 SPO.IDE.H.132 Airborne weather detecting equipment – complex motor-powered helicopters

ED Decision 2014/018/R

GENERAL

The airborne weather detecting equipment should be an airborne weather radar.

SPO.IDE.H.133 Additional equipment for operations in icing conditions at night – complex motor-powered helicopters

Regulation (EU) No 379/2014

- (a) Helicopters operated in expected or actual icing conditions at night shall be equipped with a means to illuminate or detect the formation of ice.
- (b) The means to illuminate the formation of ice shall not cause glare or reflection that would handicap flight crew members in the performance of their duties.

SPO.IDE.H.135 Flight crew interphone system

Regulation (EU) No 379/2014

Helicopters operated by more than one flight crew member shall be equipped with a flight crew interphone system, including headsets and microphones for use by all flight crew members.

AMC1 SPO.IDE.H.135 Flight crew interphone system

ED Decision 2014/018/R

TYPE OF FLIGHT CREW INTERPHONE

The flight crew interphone system should not be of a handheld type.

SPO.IDE.H.140 Cockpit voice recorder

Regulation (EU) 2015/2338

- (a) Helicopters with an MCTOM of more than 7 000 kg and first issued with an individual CofA on or after 1 January 2016 shall be equipped with a CVR.
- (b) The CVR shall be capable of retaining data recorded during at least the preceding 2 hours.
- (c) The CVR shall record with reference to a timescale:
 - (1) voice communications transmitted from or received in the flight crew compartment by radio;
 - (2) flight crew members' voice communications using the interphone system and the public address system, if installed;
 - (3) the aural environment of the cockpit, including, without interruption, the audio signals received from each crew microphone; and
 - (4) voice or audio signals identifying navigation or approach aids introduced into a headset or speaker.
- (d) The CVR shall start automatically to record prior to the helicopter moving under its own power and shall continue to record until the termination of the flight when the helicopter is no longer capable of moving under its own power.
- (e) In addition to (d), depending on the availability of electrical power, the CVR shall start to record as early as possible during the cockpit checks prior to engine start at the beginning of the flight until the cockpit checks immediately following engine shutdown at the end of the flight.
- (f) If the CVR is not deployable, it shall have a device to assist in locating it under water. By 1 January 2020 at the latest, this device shall have a minimum underwater transmission time of 90 days. If the CVR is deployable, it shall have an automatic emergency locator transmitter.

AMC1 SPO.IDE.H.140 Cockpit voice recorder

ED Decision 2015/021/R

GENERAL

- (a) The operational performance requirements for cockpit voice recorders (CVRs) should be those laid down in EUROCAE Document ED-112 (Minimum Operational Performance Specification for Crash Protected Airborne Recorder Systems March 2003, including Amendments No°1 and 2, or any later equivalent standard produced by EUROCAE.
- (b) The operational performance requirements for equipment dedicated to the CVR should be those laid down in the European Organisation for Civil Aviation Equipment (EUROCAE) Document ED-56A (Minimum Operational Performance Requirements For Cockpit Voice Recorder Systems) dated December 1993, or EUROCAE Document ED-112 (Minimum Operational Performance Specification for Crash Protected Airborne Recorder Systems) dated March 2003, including Amendments n°1 and n°2, or any later equivalent standard produced by EUROCAE.

SPO.IDE.H.145 Flight data recorder

Regulation (EU) 2015/2338

- (a) Helicopters with an MCTOM of more than 3 175 kg and first issued with an individual CofA on or after 1 January 2016 shall be equipped with an FDR that uses a digital method of recording and storing data and for which a method of readily retrieving that data from the storage medium is available.
- (b) The FDR shall record the parameters required to determine accurately the helicopter flight path, speed, attitude, engine power, configuration and operation and be capable of retaining data recorded during at least the preceding 10 hours.
- (c) Data shall be obtained from helicopter sources that enable accurate correlation with information displayed to the flight crew.
- (d) The FDR shall start automatically to record the data prior to the helicopter being capable of moving under its own power and shall stop automatically after the helicopter is incapable of moving under its own power.
- (e) If the FDR is not deployable, it shall have a device to assist in locating it under water. By 1 January 2020 at the latest, this device shall have a minimum underwater transmission time of 90 days. If the FDR is deployable, it shall have an automatic emergency locator transmitter.

AMC1 SPO.IDE.H.145 Flight data recorder

ED Decision 2016/012/R

OPERATIONAL PERFORMANCE REQUIREMENTS FOR HELICOPTERS HAVING AN MCTOM OF MORE THAN 3 175 KG AND FIRST ISSUED WITH AN INDIVIDUAL CofA ON OR AFTER 1 JANUARY 2016 AND BEFORE 1 JANUARY 2023

- (a) The operational performance requirements for flight data recorders (FDRs) should be those laid down in EUROCAE Document ED-112 (Minimum Operational Performance Specification for Crash Protected Airborne Recorder Systems) dated March 2003, including amendments No°1 and No°2, or any later equivalent standard produced by EUROCAE.
- (b) The FDR should record, with reference to a timescale, the list of parameters in Table 1 and Table 2, as applicable.

- (c) The parameters recorded by the FDR should meet, as far as practicable, the performance specifications (designated ranges, sampling intervals, accuracy limits and minimum resolution in read-out) defined in EUROCAE ED-112, including amendments No°1 and No°2, or any later equivalent standard produced by EUROCAE.
- (d) FDR systems for which some recorded parameters do not meet the performance specifications of EUROCAE Document ED-112 may be acceptable to the Agency.

Table 1: FDR parameters — All helicopters

No*	Parameter
1	Time or relative time count
2	Pressure altitude
3	Indicated airspeed
4	Heading
5	Normal acceleration
6	Pitch attitude
7	Roll attitude
8	Manual radio transmission keying CVR/FDR synchronisation reference
9	Power on each engine:
9a	Free power turbine speed (N _F)
9b	Engine torque
9c	Engine gas generator speed (N _G)
9d	Flight crew compartment power control position
9e	Other parameters to enable engine power to be determined
10	Rotor:
10a	Main rotor speed
10b	Rotor brake (if installed)
11	Primary flight controls — Pilot input and/or control output position (if applicable)
11a	Collective pitch
11b	Longitudinal cyclic pitch
11c	Lateral cyclic pitch
11d	Tail rotor pedal
11e	Controllable stabilator (if applicable)
11f	Hydraulic selection
12	Hydraulics low pressure (each system should be recorded.)
13	Outside air temperature
18	Yaw rate or yaw acceleration
20	Longitudinal acceleration (body axis)
21	Lateral acceleration
25	Marker beacon passage
26	Warnings — a discrete should be recorded for the master warning, gearbox low oil pressure and as failure. Other 'red' warnings should be recorded where the warning condition cannot be determined from other parameters or from the cockpit voice recorder.
27	Each navigation receiver frequency selection
37	Engine control modes

* The number in the left hand column reflects the serial number depicted in EUROCAE ED-112.

Table 2: FDR parameters — Helicopters for which the data source for the parameter is either used by helicopter systems or is available on the instrument panel for use by the flight crew to operate the helicopter.

No [*]	Parameter
14	AFCS mode and engagement status
15	Stability augmentation system engagement (each system should be recorded)
16	Main gear box oil pressure
17	Gear box oil temperature
17a	Main gear box oil temperature
17b	Intermediate gear box oil temperature
17c	Tail rotor gear box oil temperature
19	Indicated sling load force (if signals readily available)
22	Radio altitude
23	Vertical deviation — the approach aid in use should be recorded.
23a	ILS glide path
23b	MLS elevation
23c	GNSS approach path
24	Horizontal deviation — the approach aid in use should be recorded.
24a	ILS localiser
24b	MLS azimuth
24c	GNSS approach path
28	DME 1 & 2 distances
29	Navigation data
29a	Drift angle
29b	Wind speed
29c	Wind direction
29d	Latitude
29e	Longitude
29f	Ground speed
30	Landing gear or gear selector position
31	Engine exhaust gas temperature (T ₄)
32	Turbine inlet temperature (TIT/ITT)
33	Fuel contents
34	Altitude rate (vertical speed) — only necessary when available from cockpit instruments
35	Ice detection
36	Helicopter health and usage monitor system (HUMS)
36a	Engine data
36b	Chip detector
36c	Track timing
36d	Exceedance discretets
36e	Broadband average engine vibration
38	Selected barometric setting — to be recorded for helicopters where the parameter is displayed electronically
38a	Pilot
38b	Co-pilot
39	Selected altitude (all pilot selectable modes of operation) — to be recorded for the helicopters where the parameter is displayed electronically
40	Selected speed (all pilot selectable modes of operation) — to be recorded for the helicopters where the parameter is displayed electronically
41	Not used (selected Mach)

No*	Parameter
42	Selected vertical speed (all pilot selectable modes of operation) — to be recorded for the helicopters where the parameter is displayed electronically
43	Selected heading (all pilot selectable modes of operation) — to be recorded for the helicopters where the parameter is displayed electronically
44	Selected flight path (all pilot selectable modes of operation) — to be recorded for the helicopters where the parameter is displayed electronically
45	Selected decision height (all pilot selectable modes of operation) — to be recorded for the helicopters where the parameter is displayed electronically
46	EFIS display format
47	Multi-function/engine/alerts display format
48	Event marker

* The number in the left hand column reflects the serial number depicted in EUROCAE ED-112.

AMC2 SPO.IDE.H.145 Flight data recorder

ED Decision 2016/021/R

OPERATIONAL PERFORMANCE REQUIREMENTS FOR HELICOPTERS HAVING AN MCTOM OF MORE THAN 3 175 KG AND FIRST ISSUED WITH AN INDIVIDUAL CoFA ON OR AFTER 1 JANUARY 2023

- (a) The operational performance requirements for flight data recorders (FDRs) should be those laid down in EUROCAE Document 112A (Minimum Operational Performance Specification for Crash Protected Airborne Recorder Systems) dated September 2013, or any later equivalent standard produced by EUROCAE.
- (b) The FDR should, with reference to a timescale, record:
- (1) the list of parameters in Table 1 below;
 - (2) the additional parameters listed in Table 2 below, when the information data source for the parameter is used by helicopter systems or is available on the instrument panel for use by the flight crew to operate the helicopter; and
 - (3) any dedicated parameters related to novel or unique design or operational characteristics of the helicopter as determined by the Agency.
- (c) The parameters to be recorded should meet the performance specifications (range, sampling intervals, accuracy limits and resolution in read-out) as defined in the relevant tables of EUROCAE Document 112A, or any later equivalent standard produced by EUROCAE.

Table 1: FDR — All helicopters

No*	Parameter
1	Time or relative time count
2	Pressure altitude
3	Indicated airspeed or calibrated airspeed
4	Heading
5	Normal acceleration
6	Pitch attitude
7	Roll attitude
8	Manual radio transmission keying CVR/FDR synchronisation reference
9	Power on each engine:
9a	Free power turbine speed (N _F)

No*	Parameter
9b	Engine torque
9c	Engine gas generator speed (N _G)
9d	Flight crew compartment power control position
9e	Other parameters to enable engine power to be determined
10	Rotor:
10a	Main rotor speed
10b	Rotor brake (if installed)
11	Primary flight controls — pilot input or control output position if it is possible to derive either the control input or the control movement (one from the other) for all modes of operation and flight regimes. Otherwise, pilot input and control output position
11a	Collective pitch
11b	Longitudinal cyclic pitch
11c	Lateral cyclic pitch
11d	Tail rotor pedal
11e	Controllable stabilator (if applicable)
11f	Hydraulic selection
12	Hydraulics low pressure (each system should be recorded)
13	Outside air temperature
18	Yaw rate or yaw acceleration
20	Longitudinal acceleration (body axis)
21	Lateral acceleration
25	Marker beacon passage
26	Warnings — including master warning, gearbox low oil pressure and stability augmentation system failure, and other ‘red’ warnings where the warning condition cannot be determined from other parameters or from the cockpit voice recorder.
27	Each navigation receiver frequency selection
37	Engine control modes

* The number in the left-hand column reflects the serial numbers depicted in EUROCAE Document 112A.

Table 2: Helicopters for which the data source for the parameter is either used by the helicopter systems or is available on the instrument panel for use by the flight crew to operate the helicopter

No*	Parameter
14	AFCS mode and engagement status (showing which systems are engaged and which primary modes are controlling the flight path)
15	Stability augmentation system engagement (each system should be recorded)
16	Main gear box oil pressure
17	Gear box oil temperature:
17a	Main gear box oil temperature
17b	Intermediate gear box oil temperature
17c	Tail rotor gear box oil temperature
19	Indicated sling load force (if signals readily available)
22	Radio altitude
23	Vertical deviation — the approach aid in use should be recorded:
23a	ILS glide path
23b	MLS elevation
23c	GNSS approach path
24	Horizontal deviation — the approach aid in use should be recorded:
24a	ILS localiser

No*	Parameter
24b	MLS azimuth
24c	GNSS approach path
28	DME 1 & 2 distances
29	Navigation data:
29a	Drift angle
29b	Wind speed
29c	Wind direction
29d	Latitude
29e	Longitude
29f	Ground speed
30	Landing gear or gear selector position
31	Engine exhaust gas temperature (T ₄)
32	Turbine inlet temperature (TIT)/interstage turbine temperature (ITT)
33	Fuel contents
34	Altitude rate (vertical speed) — only necessary when available from cockpit instruments
35	Ice detection
36	Helicopter health and usage monitor system (HUMS):
36a	Engine data
36b	Chip detector
36c	Track timing
36d	Exceedance discretets
36e	Broadband average engine vibration
38	Selected barometric setting — to be recorded for helicopters where the parameter is displayed electronically:
38a	Pilot
38b	Co-pilot
39	Selected altitude (all pilot selectable modes of operation) — to be recorded for the helicopters where the parameter is displayed electronically.
40	Selected speed (all pilot selectable modes of operation) — to be recorded for the helicopters where the parameter is displayed electronically.
41	Selected Mach (all pilot selectable modes of operation) — to be recorded for the helicopters where the parameter is displayed electronically.
42	Selected vertical speed (all pilot selectable modes of operation) — to be recorded for the helicopters where the parameter is displayed electronically.
43	Selected heading (all pilot selectable modes of operation) — to be recorded for the helicopters where the parameter is displayed electronically.
44	Selected flight path (all pilot selectable modes of operation) — to be recorded for the helicopters where the parameter is displayed electronically.
45	Selected decision height (all pilot selectable modes of operation) — to be recorded for the helicopters where the parameter is displayed electronically.
46	EFIS display format (showing the display system status):
46a	Pilot
46b	First officer
47	Multi-function/engine/alerts display format (showing the display system status)
48	Event marker
49	Status of ground proximity warning system (GPWS)/terrain awareness warning system (TAWS)/ground collision avoidance system (GCAS):
49a	Selection of terrain display mode including pop-up display status — for helicopters type certified before 1 January 2023, to be recorded only if this does not require extensive modification.
49b	

No*	Parameter
49c	Terrain alerts, both cautions and warnings, and advisories — for helicopters type certified before 1 January 2023, to be recorded only if this does not require extensive modification. On/off switch position — for helicopters type certified before 1 January 2023, to be recorded only if this does not require extensive modification.
50	Traffic alert and collision avoidance system (TCAS)/airborne collision avoidance system (ACAS):
50a	Combined control — for helicopters type certified before 1 January 2023, to be recorded only if this does not require extensive modification.
50b	Vertical control — for helicopters type certified before 1 January 2023, to be recorded only if this does not require extensive modification.
50c	Up advisory — for helicopters type certified before 1 January 2023, to be recorded only if this does not require extensive modification.
50d	Down advisory — for helicopters type certified before 1 January 2023, to be recorded only if this does not require extensive modification.
50e	Sensitivity level — for helicopters type certified before 1 January 2023, to be recorded only if this does not require extensive modification.
51	Primary flight controls — pilot input forces:
51a	Collective pitch — for helicopters type certified before 1 January 2023, to be recorded only if this does not require extensive modification.
51b	Longitudinal cyclic pitch — for helicopters type certified before 1 January 2023, to be recorded only if this does not require extensive modification.
51c	Lateral cyclic pitch — for helicopters type certified before 1 January 2023, to be recorded only if this does not require extensive modification.
51d	Tail rotor pedal — for helicopters type certified before 1 January 2023, to be recorded only if this does not require extensive modification.
52	Computed centre of gravity — for helicopters type certified before 1 January 2023, to be recorded only if this does not require extensive modification.
53	Helicopter computed weight — for helicopters type certified before 1 January 2023, to be recorded only if this does not require extensive modification.

* The number in the left-hand column reflects the serial numbers depicted in EUROCAE Document 112A.

SPO.IDE.H.146 Lightweight flight recorder

Regulation (EU) 2021/1296

- (a) Turbine-engined helicopters with an MCTOM of 2 250 kg or more shall be equipped with a flight recorder if all the following conditions are met:
 - (1) they are not within the scope of point [SPO.IDE.H.145\(a\)](#);
 - (2) they are used for commercial operations;
 - (3) they are first issued with an individual CofA on or after 5 September 2022.
- (b) The flight recorder shall record, by means of flight data or images, information that is sufficient to determine the flight path and aircraft speed.
- (c) The flight recorder shall be capable of retaining the flight data and the images recorded during at least the preceding 5 hours.
- (d) The flight recorder shall automatically start to record prior to the helicopter being capable of moving under its own power and shall stop automatically after the helicopter is no longer capable of moving under its own power.
- (e) If the flight recorder records images or audio of the flight crew compartment, then a function shall be provided which can be operated by the pilot-in-command and which modifies image

and audio recordings made before the operation of that function, so that those recordings cannot be retrieved using normal replay or copying techniques.

AMC1 SPO.IDE.H.146 Lightweight flight recorder

ED Decision 2021/005/R

OPERATIONAL PERFORMANCE REQUIREMENTS

- (a) If the flight recorder records flight data, it should record at least the following parameters:
- (1) relative time count,
 - (2) pitch attitude or pitch rate,
 - (3) roll attitude or roll rate,
 - (4) heading (magnetic or true) or yaw rate,
 - (5) latitude,
 - (6) longitude,
 - (7) positioning system: estimated error (if available),
 - (8) pressure altitude or altitude from a positioning system,
 - (9) time,
 - (10) ground speed,
 - (11) positioning system: track (if available),
 - (12) normal acceleration,
 - (13) longitudinal acceleration, and
 - (14) lateral acceleration.
- (b) If the flight recorder records images, it should capture views of the main instrument displays at the pilot station, or at both pilot stations when the helicopter is certified for operation with a minimum crew of two pilots. The recorded image quality should allow reading the following indications during most of the flight:
- (1) magnetic or true heading,
 - (2) time (if presented on the front instrument panel),
 - (3) pressure altitude,
 - (4) indicated airspeed,
 - (5) vertical speed,
 - (6) slip,
 - (7) OAT,
 - (8) attitude (if displayed),
 - (9) stabilised heading (if displayed), and
 - (10) main rotor speed.
- (c) If the flight recorder records a combination of images and flight data, each flight parameter listed in (a) should be recorded as flight data or by means of images.

- (d) The flight parameters listed in (a), which are recorded as flight data, should meet the performance specifications (range, sampling intervals, accuracy limits and resolution in read-out) as defined in the relevant table of EUROCAE Document ED-112 ‘Minimum Operational Performance Specification for Crash Protected Airborne Recorder Systems’, dated March 2003, or EUROCAE Document ED-155 ‘Minimum Operational Performance Specification for Lightweight Flight Recording Systems’, dated July 2009, or any later equivalent standard accepted by EASA.
- (e) The operational performance requirements for the flight recorder should be those laid down in:
- (1) EUROCAE Document ED-155 or any later equivalent standard accepted by EASA for lightweight flight recorders; or
 - (2) EUROCAE Document ED-112 or any later equivalent standard accepted by EASA for crash-protected flight recorders.

GM1 SPO.IDE.H.146 Lightweight flight recorder

ED Decision 2021/005/R

ADDITIONAL USEFUL INFORMATION

Refer to [GM1 SPO.IDE.A.146](#).

GM1 SPO.IDE.H.146(e) Lightweight flight recorder

ED Decision 2021/005/R

FUNCTION TO MODIFY IMAGE AND AUDIO RECORDINGS

Refer to [GM1 SPO.IDE.A.146\(e\)](#).

GM2 SPO.IDE.H.146 Lightweight flight recorder

ED Decision 2021/005/R

INSTALLATION OF CAMERAS

Refer to [GM2 SPO.IDE.A.146](#).

GM3 SPO.IDE.H.146 Lightweight flight recorder

ED Decision 2021/005/R

RECORDING ACCURACY OF ATTITUDE RATE PARAMETERS

Refer to [GM3 SPO.IDE.A.146](#).

SPO.IDE.H.150 Data link recording

Regulation (EU) 2015/2338

- (a) Helicopters first issued with an individual CofA on or after 1 January 2016 that have the capability to operate data link communications and are required to be equipped with a CVR shall record on a recorder, where applicable:
- (1) data link communication messages related to ATS communications to and from the helicopter, including messages applying to the following applications:
 - (i) data link initiation;

- (ii) controller-pilot communication;
 - (iii) addressed surveillance;
 - (iv) flight information;
 - (v) as far as is practicable, given the architecture of the system, aircraft broadcast surveillance;
 - (vi) as far as is practicable, given the architecture of the system, aircraft operational control data; and
 - (vii) as far as is practicable, given the architecture of the system, graphics;
- (2) information that enables correlation to any associated records related to data link communications and stored separately from the helicopter; and
- (3) information on the time and priority of data link communications messages, taking into account the system's architecture.
- (b) The recorder shall use a digital method of recording and storing data and information and a method for readily retrieving that data. The recording method shall allow the data to match the data recorded on the ground.
- (c) The recorder shall be capable of retaining data recorded for at least the same duration as set out for CVRs in [SPO.IDE.H.140](#).
- (d) If the recorder is not deployable, it shall have a device to assist in locating it under water. By 1 January 2020 at the latest, this device shall have a minimum underwater transmission time of 90 days. If the recorder is deployable, it shall have an automatic emergency locator transmitter.
- (e) The requirements applicable to the start and stop logic of the recorder are the same as the requirements applicable to the start and stop logic of the CVR contained in [SPO.IDE.H.140\(d\) and \(e\)](#).

AMC1 SPO.IDE.H.150 Data link recording

ED Decision 2014/018/R

GENERAL

- (a) As a means of compliance with [SPO.IDE.H.150](#), the recorder on which the data link messages are recorded should be:
- (1) the CVR;
 - (2) the FDR;
 - (3) a combination recorder when [SPO.IDE.H.155](#) is applicable; or
 - (4) a dedicated flight recorder. In such case, the operational performance requirements for this recorder should be those laid down in EUROCAE Document ED-112 (Minimum Operational Performance Specification for Crash Protected Airborne Recorder Systems), dated March 2003, including amendments No^o1 and No^o2, or any later equivalent standard produced by EUROCAE.
- (b) As a means of compliance with [SPO.IDE.H.150\(a\)\(2\)](#), the operator should enable correlation by providing information that allows an accident investigator to understand what data was provided to the aircraft and, when the provider identification is contained in the message, by which provider.

- (c) The timing information associated with the data link communications messages required to be recorded by [SPO.IDE.H.150\(a\)\(3\)](#) should be capable of being determined from the airborne-based recordings. This timing information should include at least the following:
- (1) the time each message was generated;
 - (2) the time any message was available to be displayed by the flight crew;
 - (3) the time each message was actually displayed or recalled from a queue; and
 - (4) the time of each status change.
- (d) The message priority should be recorded when it is defined by the protocol of the data link communication message being recorded.
- (e) The expression ‘taking into account the system’s architecture’, in [SPO.IDE.H.150\(a\)\(3\)](#), means that the recording of the specified information may be omitted if the existing source systems involved would require a major upgrade. The following should be considered:
- (1) the extent of the modification required;
 - (2) the down-time period; and
 - (3) equipment software development.
- (f) Data link communications messages that support the applications in Table 1 should be recorded.
- (g) Further details on the recording requirements can be found in the recording requirement matrix in Appendix D.2 of EUROCAE Document ED-93 (Minimum Aviation System Performance Specification for CNS/ATM Recorder Systems), dated November 1998.

Table 1: Data link recording

Item No	Application Type	Application Description	Required Recording Content
1	Data link initiation	This includes any application used to log on to, or initiate, a data link service. In future air navigation system (FANS)-1/A and air traffic navigation (ATN), these are ATS facilities notification (AFN) and context management (CM), respectively.	C
2	Controller/pilot communication	This includes any application used to exchange requests, clearances, instructions and reports between the flight crew and controllers on the ground. In FANS-1/A and ATN, this includes the controller pilot data link communications (CPDLC) application. It also includes applications used for the exchange of oceanic clearances (OCL) and departure clearances (DCL), as well as data link delivery of taxi clearances.	C
3	Addressed surveillance	This includes any surveillance application in which the ground sets up contracts for delivery of surveillance data. In FANS-1/A and ATN, this includes the automatic dependent surveillance-contract (ADS-C) application.	C, F2
4	Flight information	This includes any application used for delivery of flight information data to specific aeroplanes. This includes for example data link-automatic terminal information service (D-ATIS), data link-operational terminal information service (D-OTIS), digital weather information services (D-METAR or	C

Item No	Application Type	Application Description	Required Recording Content
		TWIP), data link-flight information service (D-FIS) and Notice to Airmen (electronic NOTAM) delivery.	
5	Broadcast surveillance	This includes elementary and enhanced surveillance systems, as well as automatic dependent surveillance-broadcast (ADS-B) output data.	M*, F2
6	AOC data	This includes any application transmitting or receiving data used for AOC purposes (in accordance with the ICAO definition of AOC). Such systems may also process AAC messages, but there is no requirement to record AAC messages	M*
7	Graphics	This includes any application receiving graphical data to be used for operational purposes (i.e. excluding applications that are receiving such things as updates to manuals).	M* F1

GM1 SPO.IDE.H.150 Data link recording

ED Decision 2019/019/R

GENERAL

- (a) The letters and expressions in Table 1 of [AMC1 SPO.IDE.H.150](#) have the following meaning:
- (1) C: complete contents recorded.
 - (2) M: information that enables correlation with any associated records stored separately from the helicopter.
 - (3) *: applications that are to be recorded only as far as is practicable, given the architecture of the system.
 - (4) F1: graphics applications may be considered as AOC messages when they are part of a data link communications application service run on an individual basis by the operator itself in the framework of the operational control.
 - (5) F2: where parametric data sent by the helicopter, such as Mode S, is reported within the message, it should be recorded unless data from the same source is recorded on the FDR.
- (b) The definitions of the applications type in Table 1 of [AMC1 SPO.IDE.H.150](#) are described in Table 1 below.

Table 1: Definitions of the applications type

Item No	Application Type	Messages	Comments
1	CM		CM is an ATN service
2	AFN		AFN is a FANS 1/A service
3	CPDLC		All implemented up and downlink messages to be recorded
4	ADS-C	ADS-C reports	All contract requests and reports recorded

Item No	Application Type	Messages	Comments
		Position reports	Only used within FANS 1/A. Mainly used in oceanic and remote areas.
5	ADS-B	Surveillance data	Information that enables correlation with any associated records stored separately from the helicopter.
6	D-FIS		D-FIS is an ATN service. All implemented up and downlink messages to be recorded
7	TWIP	TWIP messages	Terminal weather information for pilots
8	D ATIS	ATIS messages	Refer to EUROCAE ED-89A, dated December 2003: Data Link Application System Document (DLASD) for the 'ATIS' data link service
9	OCL	OCL messages	Refer to EUROCAE ED-106A, dated March 2004: Data Link Application System Document (DLASD) for 'Oceanic Clearance' (OCL) data link service
10	DCL	DCL messages	Refer to EUROCAE ED-85A, dated March 2003: Data Link Application System Document (DLASD) for 'Departure Clearance' data link service
11	Graphics	Weather maps & other graphics	Graphics exchanged in the framework of procedures within the operational control, as specified in Part-ORO. Information that enables correlation with any associated records stored separately from the helicopter.
12	AOC	Aeronautical operational control messages	Messages exchanged in the framework of procedures within the operational control, as specified in Part-ORO. Information that enables correlation with any associated records stored separately from the helicopter. Definition in EUROCAE ED-112, dated March 2003.
13	Surveillance	Downlinked Aircraft Parameters (DAP)	As defined in ICAO Annex 10 Volume IV (Surveillance systems and ACAS).

AAC	aeronautical administrative communications
ADS-B	automatic dependent surveillance — broadcast
ADS-C	automatic dependent surveillance — contract
AFN	aircraft flight notification
AOC	aeronautical operational control
ATIS	automatic terminal information service
ATSC	air traffic service communication
CAP	controller access parameters
CPDLC	controller pilot data link communications
CM	configuration/context management
D-ATIS	digital ATIS
D-FIS	data link flight information service
D-METAR	data link meteorological airport report
DCL	departure clearance
FANS	Future Air Navigation System
FLIPCY	flight plan consistency
OCL	oceanic clearance
SAP	system access parameters
TWIP	terminal weather information for pilots

GM1 SPO.IDE.H.150(a) Data link recording

ED Decision 2015/030/R

APPLICABILITY OF THE DATA LINK RECORDING REQUIREMENT

- (a) If it is certain that the helicopter cannot use data link communication messages for ATS communications corresponding to any application designated by [SPO.IDE.H.150\(a\)\(1\)](#), then the data link recording requirement does not apply.
- (b) Examples where the helicopter cannot use data link communication messages for ATS communications include but are not limited to the cases where:
 - (1) the helicopter data link communication capability is disabled permanently and in a way that it cannot be enabled again during the flight;
 - (2) data link communications are not used to support air traffic service (ATS) in the area of operation of the helicopter; and
 - (3) the helicopter data link communication equipment cannot communicate with the equipment used by ATS in the area of operation of the helicopter.

SPO.IDE.H.155 Flight data and cockpit voice combination recorder

Regulation (EU) No 379/2014

Compliance with CVR and FDR requirements may be achieved by one flight data and cockpit voice combination recorder.

GM1 SPO.IDE.H.155 Flight data and cockpit voice combination recorder

ED Decision 2014/018/R

COMBINATION RECORDERS

- (a) A flight data and cockpit voice combination recorder is a flight recorder that records:
 - (1) all voice communications and the aural environment required by [SPO.IDE.H.140](#); and
 - (2) all parameters and specifications required by [SPO.IDE.H.145](#),with the same specifications required by [SPO.IDE.H.140](#) and [SPO.IDE.H.145](#).
- (b) In addition, a flight data and cockpit voice combination recorder may record data link communication messages and related information required by [SPO.IDE.H.150](#).

SPO.IDE.H.160 Seats, seat safety belts and restraint systems

Regulation (EU) No 379/2014

- (a) Helicopters shall be equipped with:
 - (1) a seat or station for each crew member or task specialist on board;
 - (2) a seat belt on each seat, and restraint devices for each station;
 - (3) for helicopters first issued with an individual CofA after 31 December 2012, a seat belt with an upper torso restraint system for each seat; and

- (4) a seat belt with upper torso restraint system incorporating a device that will automatically restrain the occupant's torso in the event of rapid deceleration on each flight crew seat.
- (b) A seat belt with upper torso restraint system shall have a single point release.

AMC2 SPO.IDE.H.160 Seats, seat safety belts and restraint systems

ED Decision 2014/018/R

UPPER TORSO RESTRAINT SYSTEM

The following systems are deemed to be compliant with the requirement for an upper torso restraint system:

- (a) For other-than complex helicopters, a seat belt with a diagonal shoulder strap;
- (b) For all helicopters, a restraint system having a seat belt and two shoulder straps that may be used independently.
- (c) For all helicopters, a restraint system having a seat belt, two shoulder straps and additional straps that may be used independently.

SEAT BELT

A seat belt with a diagonal shoulder strap (three anchorage points) is deemed to be compliant with the requirement for a seat belt (two anchorage points).

SPO.IDE.H.165 First-aid kit

Regulation (EU) No 379/2014

- (a) Helicopters shall be equipped with a first-aid kit.
- (b) The first-aid kit shall be:
 - (1) readily accessible for use; and
 - (2) kept up-to-date.

AMC1 SPO.IDE.H.165 First-aid kit

ED Decision 2021/005/R

CONTENT OF FIRST-AID KITS — OTHER-THAN COMPLEX MOTOR-POWERED HELICOPTERS

- (a) First-aid kits should be equipped with appropriate and sufficient medications and instrumentation. However, these kits should be supplemented by the operator according to the characteristics of the operation (scope of operation, flight duration, number and demographics of persons on board, etc.).
- (b) The following should be included in the FAKs:
 - (1) bandages (assorted sizes, including a triangular bandage),
 - (2) burns dressings (large and small),
 - (3) wound dressings (large and small),
 - (4) adhesive dressings (assorted sizes),
 - (5) antiseptic wound cleaner,

- (6) safety scissors,
- (7) disposable gloves,
- (8) disposable resuscitation aid, and
- (9) surgical masks.

AMC2 SPO.IDE.H.165 First-aid kit

ED Decision 2021/005/R

CONTENT OF FIRST-AID KITS — COMPLEX MOTOR-POWERED HELICOPTERS

- (a) First-aid kits should be equipped with appropriate and sufficient medications and instrumentation. However, these kits should be supplemented by the operator according to the characteristics of the operation (scope of operation, flight duration, number and demographics of persons on board, etc.).
- (b) The following should be included in the FAKs:
 - (1) Equipment
 - (i) bandages (assorted sizes, including a triangular bandage);
 - (ii) burns dressings (unspecified);
 - (iii) wound dressings (large and small);
 - (iv) adhesive dressings (assorted sizes);
 - (v) adhesive tape;
 - (vi) adhesive wound closures;
 - (vii) safety pins;
 - (viii) safety scissors;
 - (ix) antiseptic wound cleaner;
 - (x) disposable resuscitation aid;
 - (xi) disposable gloves;
 - (xii) tweezers: splinter;
 - (xiii) thermometers (non-mercury); and
 - (xiv) surgical masks.
 - (2) Medications
 - (i) simple analgesic;
 - (ii) antiemetic — non-injectable;
 - (iii) nasal decongestant;
 - (iv) gastrointestinal antacid, in the case of helicopters carrying more than nine persons;
 - (v) anti-diarrhoeal medication in the case of helicopters carrying more than nine persons; and
 - (vi) antihistamine.

- (3) Other content. The operator should make available instructions either in a paper-based or an electronic format. If an electronic format is available, then all instructions should be kept on the same device. If a paper format is used, then the instructions should be kept in the same kit with the applicable equipment and medication. The instructions should include, as a minimum, the following:
- (i) a list of contents in at least two languages (English and one other). This should include information on the effects and side effects of medications carried;
 - (ii) first-aid handbook, current edition;
 - (iii) Basic life support instructions cards (summarising and depicting the current algorithm for basic life support);
 - (iv) medical incident report form;
 - (v) biohazard disposal bags.; and
 - (vi) bag-valve masks for adults.
- (4) Additional equipment. The operators should carry additional equipment based on an assessment that considers the specificities and the nature of their specialised operations:
- (i) automated external defibrillator (AED);
 - (ii) suitable airway management device (e.g. supraglottic airway devices, oropharyngeal and nasopharyngeal airways); and
 - (iii) eye irrigator.

AMC3 SPO.IDE.H.165 First-aid kit

ED Decision 2014/018/R

MAINTENANCE OF FIRST-AID KIT

To be kept up to date, the first-aid kit should be:

- (a) inspected periodically to confirm, to the extent possible, that contents are maintained in the condition necessary for their intended use;
- (b) replenished at regular intervals, in accordance with instructions contained on their labels, or as circumstances warrant; and
- (c) replenished after use in-flight at the first opportunity where replacement items are available.

GM1 SPO.IDE.H.165 First-aid kit

ED Decision 2021/005/R

LOCATION AND USE

The location of the first-aid kit is normally indicated using internationally recognisable signs.

The first-aid kit 'should be readily accessible for use' in helicopter operations should be understood as the first-aid kit being either accessible in flight or immediately after landing.

In some operations it is not practicable to use the first-aid kit during flight. Therefore, the first-aid kit can be carried in the cargo compartment, where it will be easily accessible for use as soon as the aircraft has landed, when the following conditions are met:

- (a) precautionary landing sites are available;

- (b) the lack of cabin space is such that movement or use of the first-aid kit is impaired; and
- (c) the installation of the first-aid kit in the cabin is not practicable.

GM2 SPO.IDE.H.165 First-aid kit

ED Decision 2021/005/R

STORAGE

As a best practice and wherever practicable, the emergency medical equipment listed under [AMC2 SPO.IDE.H.165](#) should be kept close together.

GM3 SPO.IDE.H.165 First-aid kit

ED Decision 2021/005/R

CONTENT OF FIRST-AID KITS

The operator may supplement first-aid kits according to the characteristics of the operation based on a risk assessment. The assessment does not require an approval by the competent authority.

GM4 SPO.IDE.H.165 First-aid kit

ED Decision 2021/005/R

LITHIUM BATTERIES

Risks related to the presence of lithium batteries should be assessed. All equipment powered by lithium batteries carried on an aeroplane should comply with the provisions of [AMC1 CAT.GEN.MPA.140\(f\)](#) including applicable technical standards such as (E)TSO-C142.

SPO.IDE.H.175 Supplemental oxygen – non-pressurised helicopters

Regulation (EU) No 379/2014

- (a) Non-pressurised helicopters operated at flight altitudes when the oxygen supply is required in accordance with (b) shall be equipped with oxygen storage and dispensing apparatus capable of storing and dispensing the required oxygen supplies.
- (b) Non-pressurised helicopters operated above flight altitudes at which the pressure altitude in the cabin compartments is above 10 000 ft shall carry enough breathing oxygen to supply:
 - (1) all crew members for any period in excess of 30 minutes when the pressure altitude in the cabin compartment will be between 10 000 ft and 13 000 ft; and
 - (2) all crew members and task specialists for any period that the pressure altitude in the cabin compartment will be above 13 000 ft.
- (c) Notwithstanding (b), excursions of a specified duration between 13 000 ft and 16 000 ft may be undertaken without oxygen supplies, -in accordance with [SPO.OP.195\(b\)](#).

AMC1 SPO.IDE.H.175 Supplemental oxygen – non-pressurised helicopters

ED Decision 2014/018/R

DETERMINATION OF OXYGEN

The amount of oxygen should be determined on the basis of cabin pressure altitude and flight duration, consistent with the operating procedures, including emergency, procedures, established for each operation and the routes to be flown as specified in the AFM.

SPO.IDE.H.180 Hand fire extinguishers

Regulation (EU) No 379/2014

- (a) Helicopters, except ELA2 helicopters, shall be equipped with at least one hand fire extinguisher:
 - (1) in the flight crew compartment; and
 - (2) in each cabin compartment that is separate from the flight crew compartment, except if the compartment is readily accessible to the flight crew.
- (b) The type and quantity of extinguishing agent for the required fire extinguishers shall be suitable for the type of fire likely to occur in the compartment where the extinguisher is intended to be used and to minimise the hazard of toxic gas concentration in compartments occupied by persons.

AMC1 SPO.IDE.H.180 Hand fire extinguishers

ED Decision 2014/018/R

NUMBER, LOCATION AND TYPE

- (a) The number and location of hand fire extinguishers should be such as to provide adequate availability for use, account being taken of the number and size of the cabin compartments, the need to minimise the hazard of toxic gas concentrations and the location of toilets, galleys, etc. These considerations may result in the number of fire extinguishers being greater than the minimum required.
- (b) There should be at least one hand fire extinguisher installed in the flight crew compartment and this should be suitable for fighting both flammable fluid and electrical equipment fires. Additional hand fire extinguishers may be required for the protection of other compartments accessible to the flight crew or task specialist in flight. Dry chemical fire extinguishers should not be used in the flight crew compartment, or in any compartment not separated by a partition from the flight crew compartment, because of the adverse effect on vision during discharge and, if conductive, interference with electrical contacts by the chemical residues.
- (c) Where only one hand fire extinguisher is required in the cabin compartments, it should be located near the task specialist's station, where provided.
- (d) Where two or more hand fire extinguishers are required in the cabin compartments and their location is not otherwise dictated by consideration of (a), an extinguisher should be located near each end of the cabin with the remainder distributed throughout the cabin as evenly as is practicable.
- (e) Unless an extinguisher is clearly visible, its location should be indicated by a placard or sign. Appropriate symbols may also be used to supplement such a placard or sign.

SPO.IDE.H.185 Marking of break-in points

Regulation (EU) No 379/2014

If areas of the helicopter's fuselage suitable for break-in by rescue crews in an emergency are marked, such areas shall be marked as shown in Figure 1.

Figure 1

Marking of break-in points

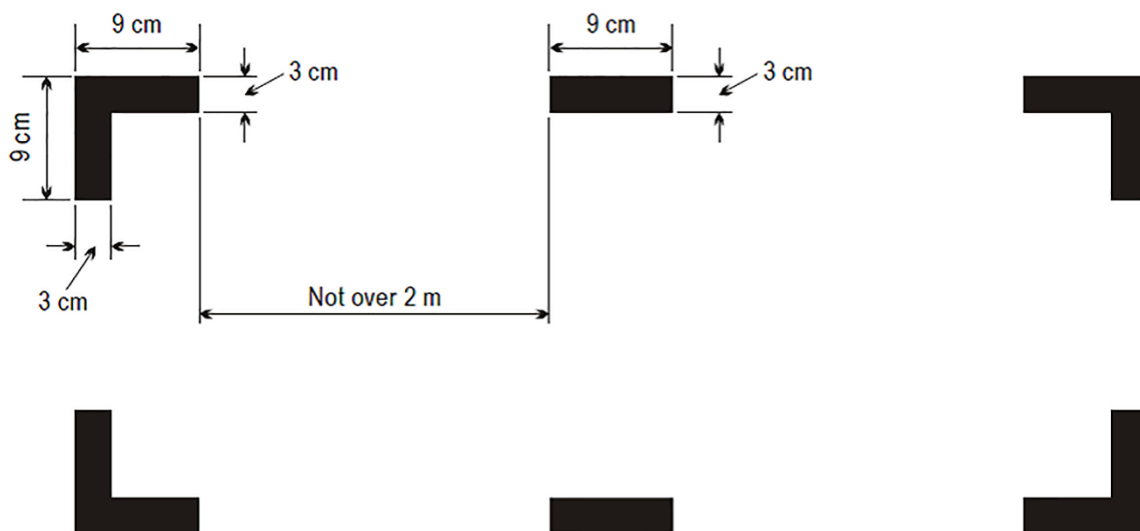

AMC1 SPO.IDE.H.185 Marking of break-in points

ED Decision 2014/018/R

COLOUR AND CORNERS' MARKING

- (a) The colour of the markings should be red or yellow and, if necessary, should be outlined in white to contrast with the background.
- (b) If the corner markings are more than 2 m apart, intermediate lines 9 cm x 3 cm should be inserted so that there is no more than 2 m between adjacent markings.

SPO.IDE.H.190 Emergency locator transmitter (ELT)

Regulation (EU) No 379/2014

- (a) Helicopters certified for a maximum seating configuration above six shall be equipped with:
 - (1) an automatic ELT; and
 - (2) one survival ELT (ELT(S)) in a life-raft or life-jacket when the helicopter is operated at a distance from land corresponding to more than 3 minutes flying time at normal cruising speed.
- (b) Helicopters certified for a maximum seating configuration of six or less shall be equipped with an ELT(S) or a personal locator beacon (PLB), carried by a crew member or a task specialist.
- (c) ELTs of any type and PLBs shall be capable of transmitting simultaneously on 121,5 MHz and 406 MHz.

AMC1 SPO.IDE.H.190 Emergency locator transmitter (ELT)

ED Decision 2014/018/R

BATTERIES

- (a) All batteries used in ELTs or PLBs should be replaced (or recharged if the battery is rechargeable) when the equipment has been in use for more than 1 cumulative hour or in the following cases:
- (1) Batteries specifically designed for use in ELTs and having an airworthiness release certificate (EASA Form 1 or equivalent) should be replaced (or recharged, if the battery is rechargeable) before the end of their useful life in accordance with the maintenance instructions applicable to the ELT.
 - (2) Standard batteries manufactured in accordance with an industry standard and not having an airworthiness release certificate (EASA Form 1 or equivalent), when used in ELTs should be replaced (or recharged if the battery is rechargeable) when 50 % of their useful life (or for rechargeable, 50 % of their useful life of charge), as established by the battery manufacturer, has expired.
 - (3) All batteries used in PLBs should be replaced (or recharged, if the battery is rechargeable) when 50 % of their useful life (or for rechargeable 50 % of their useful life of charge), as established by the battery manufacturer, has expired.
 - (4) The battery useful life (or useful life of charge) criteria in (1),(2) and (3) do not apply to batteries (such as water-activated batteries) that are essentially unaffected during probable storage intervals.
- (b) The new expiry date for a replaced (or recharged) battery should be legibly marked on the outside of the equipment.

AMC2 SPO.IDE.H.190 Emergency locator transmitter (ELT)

ED Decision 2021/008/R

TYPES OF ELTs AND GENERAL TECHNICAL SPECIFICATIONS

- (a) The ELT required by this provision should be one of the following:
- (1) Automatic fixed (ELT(AF)). An automatically activated ELT that is permanently attached to an aircraft and is designed to aid SAR teams in locating the crash site.
 - (2) Automatic portable (ELT(AP)). An automatically activated ELT that is rigidly attached to an aircraft before a crash, but is readily removable from the aircraft after a crash. It functions as an ELT during the crash sequence. If the ELT does not employ an integral antenna, the aircraft-mounted antenna may be disconnected and an auxiliary antenna (stored on the ELT case) attached to the ELT. The ELT can be tethered to a survivor or a life-raft. This type of ELT is intended to aid SAR teams in locating the crash site or survivor(s).
 - (3) Automatic deployable (ELT(AD)). An ELT that is rigidly attached to the aircraft before the crash and that is automatically deployed and activated by an impact, and, in some cases, also by water sensors. This type of ELT should float in water and is intended to aid SAR teams in locating the crash site. The ELT(AD) may be either a stand-alone beacon or an inseparable part of a deployable recorder.
 - (4) Survival ELT (ELT(S)). An ELT that is removable from an aircraft, stowed so as to facilitate its ready use in an emergency, and manually activated by a survivor. An ELT(S) may be

activated manually or automatically (e.g. by water activation). It should be designed to be tethered to a life-raft or a survivor. A water-activated ELT(S) is not an ELT(AP).

- (b) To minimise the possibility of damage in the event of crash impact, the automatic ELT should be rigidly fixed to the aircraft structure, as far aft as is practicable, with its antenna and connections arranged so as to maximise the probability of the signal being transmitted after a crash.
- (c) Any ELT carried should operate in accordance with the relevant provisions of ICAO Annex 10, Volume III and should be registered with the national agency responsible for initiating search and rescue or other nominated agency.

AMC3 SPO.IDE.H.190 Emergency locator transmitter (ELT)

ED Decision 2014/018/R

PLB TECHNICAL SPECIFICATIONS

- (a) A personal locator beacon (PLB) should have a built-in GNSS receiver with a *cosmicheskaya sistyema poiska aviarynich sudov* — search and rescue satellite-aided tracking (COSPAS-SARSAT) type approval number. However, devices with a COSPAS-SARSAT with a number belonging to series 700 are excluded as this series of numbers identifies the special-use beacons not meeting all the technical requirements and all the tests specified by COSPAS-SARSAT.
- (b) Any PLB carried should be registered with the national agency responsible for initiating search and rescue or other nominated agency.

AMC4 SPO.IDE.H.190 Emergency locator transmitter (ELT)

ED Decision 2014/018/R

BRIEFING ON PLB USE

When a PLB is carried by a task specialist, he/she should be briefed on its characteristics and use by the pilot-in-command before the flight.

GM1 SPO.IDE.H.190 Emergency locator transmitter (ELT)

ED Decision 2021/008/R

TERMINOLOGY

[GM1 CAT.IDE.H.280](#) contains explanations of terms used in point [SPO.IDE.H.190](#) and in the related AMC.

GM2 SPO.IDE.H.190 Emergency locator transmitter (ELT)

ED Decision 2014/018/R

MAXIMUM CERTIFIED SEATING CONFIGURATION

The maximum certified seating configuration does not include flight crew seats.

GM3 SPO.IDE.H.190 Emergency locator transmitter (ELT)

ED Decision 2021/008/R

ADDITIONAL GUIDANCE

The guidance provided in [GM2 CAT.IDE.H.280](#) is applicable to point SPO.IDE.H.190.

SPO.IDE.H.195 Flight over water – other-than complex motor-powered helicopters

Regulation (EU) 2015/140

- (a) Helicopters shall be equipped with a life-jacket for each person on board, that shall be worn or stowed in a position that is readily accessible from the seat or station of the person for whose use it is provided, when:
 - (1) flying over water beyond autorotational distance from the land where in case of the critical engine failure, the helicopter is not able to sustain level flight; or
 - (2) flying over water at a distance of land corresponding to more than 10 minutes flying at normal cruising speed, where in case of the critical engine failure, the helicopter is able to sustain level flight; or
 - (3) taking off or landing at an aerodrome/operating site where the take-off or approach path is over water.
- (b) Each life-jacket shall be equipped with a means of electric illumination for the purpose of facilitating the location of persons.
- (c) The pilot-in-command of a helicopter operated on a flight over water at a distance from land corresponding to more than 30 minutes flying time at normal cruising speed or 50 NM, whichever is less, shall determine the risks to survival of the occupants of the helicopter in the event of a ditching, based on which he/she shall determine the carriage of:
 - (1) equipment for making the distress signals;
 - (2) life-rafts in sufficient numbers to carry all persons on board, stowed so as to facilitate their ready use in emergency; and
 - (3) life-saving equipment to provide the means of sustaining life, as appropriate to the flight to be undertaken.
- (d) The pilot-in-command shall determine the risks to survival of the occupants of the helicopter in the event of a ditching, when deciding if the life-jackets required in (a) shall be worn by all occupants.

AMC1 SPO.IDE.H.195 Flight over water – other-than complex motor-powered helicopters

ED Decision 2014/018/R

ACCESSIBILITY OF LIFE-JACKETS

The life-jacket, if not worn, should be accessible from the seat or station of the person for whose use it is provided, with a safety belt or a restraint system fastened.

MEANS OF ILLUMINATION FOR LIFE-JACKETS

The means of electric illumination should be a survivor locator light as defined in the applicable ETSO issued by the Agency or equivalent.

RISK ASSESSMENT

- (a) When conducting the risk assessment, the pilot-in-command should base his/her decision, as far as is practicable, on the Implementing Rules and AMCs applicable to the operation of the helicopter.

- (b) The pilot-in-command should, for determining the risk, take the following operating environment and conditions into account:
- (1) sea state;
 - (2) sea and air temperatures;
 - (3) the distance from land suitable for making an emergency landing; and
 - (4) the availability of search and rescue facilities.

GM1 SPO.IDE.H.195 Flight over water – other-than complex motor-powered helicopters

ED Decision 2014/018/R

SEAT CUSHIONS

Seat cushions are not considered to be flotation devices.

SPO.IDE.H.197 Life-jackets – complex motor-powered helicopters

Regulation (EU) No 379/2014

- (a) Helicopters shall be equipped with a life-jacket for each person on board, that shall be worn or stowed in a position that is readily accessible from the seat or station of the person for whose use it is provided, when:
- (1) operated on a flight over water at a distance from land corresponding to more than 10 minutes flying time at normal cruising speed, where in the case of the critical engine failure, the helicopter is able to sustain level flight;
 - (2) operated on a flight over water beyond auto-rotational distance from the land, where in the case of the critical engine failure, the helicopter is not able to sustain level flight; or
 - (3) taking off or landing at an aerodrome or operating site where the take-off or approach path is so disposed over water that in the event of a mishap there would be the likelihood of a ditching.
- (b) Each life-jacket shall be equipped with a means of electric illumination for the purpose of facilitating the location of persons.

AMC1 SPO.IDE.H.197 Life-jackets – complex motor-powered helicopters

ED Decision 2014/018/R

ACCESSIBILITY OF LIFE-JACKETS

The life-jacket, if not worn, should be accessible from the seat or station of the person for whose use it is provided, with a safety belt or a restraint system fastened.

MEANS OF ILLUMINATION FOR LIFE-JACKETS

The means of electric illumination should be a survivor locator light as defined in the applicable ETSO issued by the Agency or equivalent.

GM1 SPO.IDE.H.197 Life-jackets – complex motor-powered helicopters

ED Decision 2014/018/R

SEAT CUSHIONS

Seat cushions are not considered to be flotation devices.

SPO.IDE.H.198 Survival suits – complex motor-powered helicopters

Regulation (EU) 2016/1199

Each person on board shall wear a survival suit when so determined by the pilot-in-command based on a risk assessment taking into account the following conditions:

- (a) flights over water beyond autorotational distance or safe forced-landing distance from land, where, in the case of a critical engine failure, the helicopter is not able to sustain level flight; and
- (b) the weather report or forecasts available to the pilot-in-command indicate that the sea temperature will be less than plus 10 °C during the flight.

GM1 SPO.IDE.H.198 Survival suits – complex motor-powered helicopters

ED Decision 2014/018/R

ESTIMATING SURVIVAL TIME

- (a) Introduction
 - (1) A person accidentally immersed in cold seas (typically offshore Northern Europe) will have a better chance of survival if he/she is wearing an effective survival suit in addition to a life-jacket. By wearing the survival suit, he/she can slow down the rate which his/her body temperature falls and, consequently, protect himself/herself from the greater risk of drowning brought about by incapacitation due to hypothermia.
 - (2) The complete survival suit system – suit, life-jacket and clothes worn under the suit – should be able to keep the wearer alive long enough for the rescue services to find and recover him/her. In practice the limit is about 3 hours. If a group of persons in the water cannot be rescued within this time they are likely to have become so scattered and separated that location will be extremely difficult, especially in the rough water typical of Northern European sea areas. If it is expected that in water protection could be required for periods greater than 3 hours, improvements should, rather, be sought in the search and rescue procedures than in the immersion suit protection.
- (b) Survival times
 - (1) The aim should be to ensure that a person in the water can survive long enough to be rescued, i.e. the survival time should be greater than the likely rescue time. The factors affecting both times are shown in Figure 1. The figure emphasises that survival time is influenced by many factors, physical and human. Some of the factors are relevant to survival in cold water and some are relevant in water at any temperature.

Figure 1: The survival equation

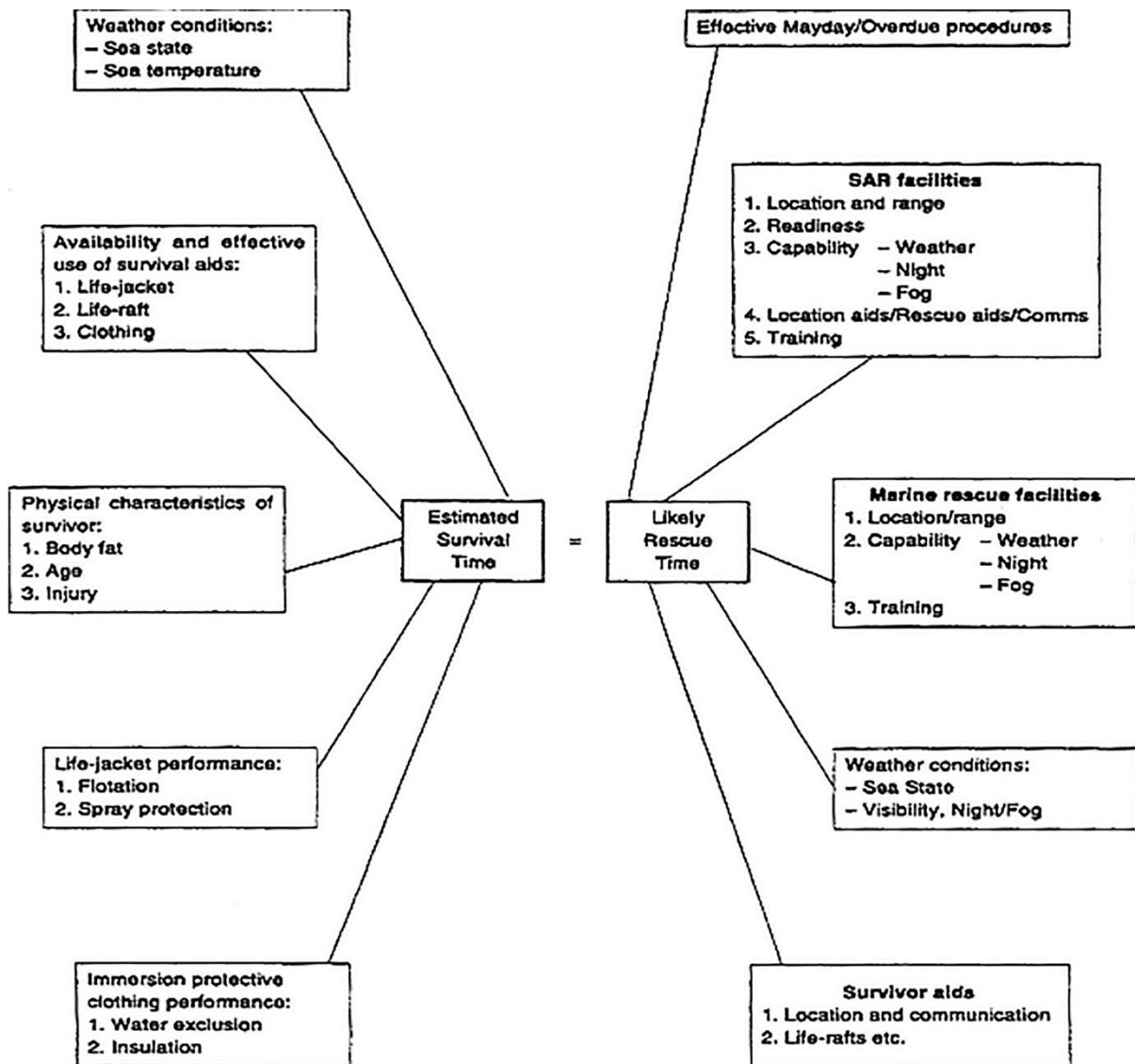

- (2) Broad estimates of likely survival times for the thin individual offshore are given in Table 1 below. As survival time is significantly affected by the prevailing weather conditions at the time of immersion, the Beaufort wind scale has been used as an indicator of these surface conditions.

Table 1: Timescale within which the most vulnerable individuals are likely to succumb to the prevailing conditions.

Clothing assembly	Beaufort wind force	Times within which the most vulnerable individuals are likely to drown	
		(water temp 5°C)	(water temp 13°C)
Working clothes (no immersion suit)	0 – 2	Within ¼ hour	Within 1 ¼ hours
	3 – 4	Within ½ hour	Within ½ hour
	5 and above	Significantly less than ½ hour	Significantly less than ½ hour
Immersion suit worn over working	0 – 2	May well exceed 3 hours	May well exceed 3 hours
	3 – 4	Within 2 ¾ hours	May well exceed 3 hours

Clothing assembly	Beaufort wind force	Times within which the most vulnerable individuals are likely to drown	
		(water temp 5°C)	(water temp 13°C)
clothes (with leakage inside suit)	5 and above	Significantly less than 2 ¾ hours. May well exceed 1 hour	May well exceed 3 hours

- (3) Consideration should also be given to escaping from the helicopter itself should it submerge or invert in the water. In this case escape time is limited to the length of time the occupants can hold their breath. The breath holding time can be greatly reduced by the effect of cold shock. Cold shock is caused by the sudden drop in skin temperature on immersion, and is characterised by a gasp reflex and uncontrolled breathing. The urge to breath rapidly becomes overwhelming and, if still submerged, the individual will inhale water resulting in drowning. Delaying the onset of cold shock by wearing an immersion suit will extend the available escape time from a submerged helicopter.
- (4) The effects of water leakage and hydrostatic compression on the insulation quality of clothing are well recognised. In a nominally dry system the insulation is provided by still air trapped within the clothing fibres and between the layers of suit and clothes. It has been observed that many systems lose some of their insulating capacity either because the clothes under the 'waterproof' survival suit get wet to some extent or because of hydrostatic compression of the whole assembly. As a result of water leakage and compression, survival times will be shortened. The wearing of warm clothing under the suit is recommended.
- (5) Whatever type of survival suit and other clothing is provided, it should not be forgotten that significant heat loss can occur from the head.

SPO.IDE.H.199 Life-rafts, survival ELTs and survival equipment on extended overwater flights – complex motor-powered helicopters

Regulation (EU) No 379/2014

Helicopters operated:

- (a) on a flight over water at a distance from land corresponding to more than 10 minutes flying time at normal cruising speed where in the case of the critical engine failure, the helicopter is able to sustain level flight; or
- (b) on a flight over water at a distance corresponding to more than 3 minutes flying time at normal cruising speed, where in the case of the critical engine failure, the helicopter is not able to sustain level flight, and if so determined by the pilot-in-command by means of a risk assessment, shall be equipped with:
 - (1) at least one life-raft with a rated capacity of not less than the maximum number of persons on board, stowed so as to facilitate their ready use in emergency;
 - (2) at least one survival ELT (ELT(S)) for each required life-raft; and
 - (3) life-saving equipment, including means of sustaining life, as appropriate to the flight to be undertaken.

AMC1 SPO.IDE.H.199 Life-rafts, survival ELTs and survival equipment on extended overwater flights – complex motor-powered helicopters

ED Decision 2014/018/R

LIFE-RAFTS AND EQUIPMENT FOR MAKING DISTRESS SIGNALS

- (a) Each required life-raft should conform to the following specifications:
- (1) be of an approved design and stowed so as to facilitate their ready use in an emergency;
 - (2) be radar conspicuous to standard airborne radar equipment;
 - (3) when carrying more than one life-raft on board, at least 50 % of the rafts should be able to be deployed by the crew while seated at their normal station, where necessary by remote control; and
 - (4) life-rafts that are not deployable by remote control or by the crew should be of such weight as to permit handling by one person. 40 kg should be considered a maximum weight.
- (b) Each required life-raft should contain at least the following:
- (1) one approved survivor locator light;
 - (2) one approved visual signalling device;
 - (3) one canopy (for use as a sail, sunshade or rain catcher) or other mean to protect occupants from the elements;
 - (4) one radar reflector;
 - (5) one 20 m retaining line designed to hold the life-raft near the helicopter but to release it if the helicopter becomes totally submerged;
 - (6) one sea anchor; and
 - (7) one survival kit, appropriately equipped for the route to be flown, which should contain at least the following:
 - (i) one life-raft repair kit;
 - (ii) one bailing bucket;
 - (iii) one signalling mirror;
 - (iv) one police whistle;
 - (v) one buoyant raft knife;
 - (vi) one supplementary means of inflation;
 - (vii) sea sickness tablets;
 - (viii) one first-aid kit;
 - (ix) one portable means of illumination;
 - (x) 500 ml of pure water and one sea water desalting kit; and
 - (xi) one comprehensive illustrated survival booklet in an appropriate language.

SPO.IDE.H.200 Survival equipment

Regulation (EU) No 379/2014

Helicopters operated over areas in which search and rescue would be especially difficult shall be equipped with:

- (a) signalling equipment to make distress signals;
- (b) at least one survival ELT (ELT(S)); and
- (c) additional survival equipment for the route to be flown taking account of the number of persons on board.

AMC1 SPO.IDE.H.200 Survival equipment

ED Decision 2014/018/R

ADDITIONAL SURVIVAL EQUIPMENT

- (a) The following additional survival equipment should be carried when required:
 - (1) 500 ml of water for each four, or fraction of four, persons on board;
 - (2) one knife;
 - (3) first-aid equipment; and
 - (4) one set of air/ground codes.
- (b) In addition, when polar conditions are expected, the following should be carried:
 - (1) a means of melting snow;
 - (2) one snow shovel and one ice saw;
 - (3) sleeping bags for use by 1/3 of all persons on board and space blankets for the remainder or space blankets for all persons on board; and
 - (4) one arctic/polar suit for each crew member.
- (c) If any item of equipment contained in the above list is already carried on board the aircraft in accordance with another requirement, there is no need for this to be duplicated.

AMC1 SPO.IDE.H.200(b) Survival equipment

ED Decision 2014/018/R

SURVIVAL ELT

An ELT(AP) may be used to replace one required ELT(S) provided that it meets the ELT(S) requirements. A water-activated ELT(S) is not an ELT(AP).

GM1 SPO.IDE.H.200 Survival equipment

ED Decision 2014/018/R

SIGNALLING EQUIPMENT

The signalling equipment for making distress signals is described in ICAO Annex 2, Rules of the Air.

GM2 SPO.IDE.H.200 Survival equipment

ED Decision 2014/018/R

AREAS IN WHICH SEARCH AND RESCUE WOULD BE ESPECIALLY DIFFICULT

The expression 'areas in which search and rescue would be especially difficult' should be interpreted, in this context, as meaning:

- (a) areas so designated by the authority responsible for managing search and rescue; or
- (b) areas that are largely uninhabited and where:
 - (1) the authority referred to in (a) has not published any information to confirm whether search and rescue would be or would not be especially difficult; and
 - (2) the authority referred to in (a) does not, as a matter of policy, designate areas as being especially difficult for search and rescue.

SPO.IDE.H.202 Helicopters certified for operating on water – miscellaneous equipment

Regulation (EU) No 379/2014

Helicopters certified for operating on water shall be equipped with:

- (a) a sea anchor and other equipment necessary to facilitate mooring, anchoring or manoeuvring the helicopter on water, appropriate to its size, weight and handling characteristics; and
- (b) equipment for making the sound signals prescribed in the International Regulations for Preventing Collisions at Sea, where applicable.

GM1 SPO.IDE.H.202 Helicopters certificated for operating on water – miscellaneous equipment

ED Decision 2014/018/R

INTERNATIONAL REGULATIONS FOR PREVENTING COLLISIONS AT SEA

International Regulations for Preventing Collisions at Sea are those that were published by the International Maritime Organisation (IMO) in 1972.

SPO.IDE.H.203 All helicopters on flights over water – ditching

Regulation (EU) 2015/140

Complex motor-powered helicopters operated on a flight over water in a hostile environment at a distance from land corresponding to more than 10 minutes' flying time at normal cruising speed and other-than complex motor-powered helicopters flying over water in a hostile environment beyond a distance of 50 NM from land shall be:

- (a) designed for landing on water in accordance with the relevant airworthiness code;
- (b) certified for ditching in accordance with the relevant airworthiness code; or
- (c) fitted with emergency flotation equipment.

AMC1 SPO.IDE.H.203 All helicopters on flights over water – ditching

ED Decision 2016/022/R

EMERGENCY FLOTATION EQUIPMENT

The considerations of [AMC1 SPA.HOFO.165\(d\)](#) should apply in respect of emergency flotation equipment.

SPO.IDE.H.205 Individual protective equipment

Regulation (EU) No 379/2014

Each person on board shall wear individual protective equipment that is adequate for the type of operation being undertaken.

GM1 SPO.IDE.H.205 Individual protective equipment

ED Decision 2014/018/R

TYPES OF INDIVIDUAL PROTECTIVE EQUIPMENT

Personal protective equipment should include, but is not limited to: flying suits, gloves, helmets, protective shoes, etc.

SPO.IDE.H.210 Headset

Regulation (EU) No 379/2014

Whenever a radio communication and/or radio navigation system is required, helicopters shall be equipped with a headset with boom microphone or equivalent and a transmit button on the flight controls for each required pilot, crew member and/or task specialist at his/her assigned station.

AMC1 SPO.IDE.H.210 Headset

ED Decision 2014/018/R

GENERAL

- (a) A headset consists of a communication device that includes two earphones to receive and a microphone to transmit audio signals to the helicopter's communication system. To comply with the minimum performance requirements, the earphones and microphone should match the communication system's characteristics and the flight crew compartment environment. The headset should be adequately adjustable in order to fit the flight crew's head. Headset boom microphones should be of the noise cancelling type.
- (b) If the intention is to utilise noise cancelling earphones, the operator should ensure that the earphones do not attenuate any aural warnings or sounds necessary for alerting the flight crew on matters related to the safe operation of the helicopter.

GM1 SPO.IDE.H.210 Headset

ED Decision 2014/018/R

GENERAL

The term 'headset' includes any aviation helmet incorporating headphones and microphone worn by a flight crew member.

SPO.IDE.H.215 Radio communication equipment

Regulation (EU) No 379/2014

- (a) Helicopters operated under IFR or at night, or when required by the applicable airspace requirements, shall be equipped with radio communication equipment that, under normal radio propagating conditions, shall be capable of:
 - (1) conducting two-way communication for aerodrome control purposes;
 - (2) receiving meteorological information;
 - (3) conducting two-way communication at any time during flight with those aeronautical stations and on those frequencies prescribed by the appropriate authority; and
 - (4) providing for communication on the aeronautical emergency frequency 121,5 MHz.
- (b) When more than one communications equipment unit is required, each shall be independent of the other or others to the extent that a failure in any one will not result in failure of any other.
- (c) When a radio communication system is required, and in addition to the flight crew interphone system required in [SPO.IDE.H.135](#), helicopters shall be equipped with a transmit button on the flight controls for each required pilot and crew member at his/her assigned station.

GM1 SPO.IDE.H.215 Radio communication equipment

ED Decision 2014/018/R

APPLICABLE AIRSPACE REQUIREMENTS

For helicopters being operated under European air traffic control, the applicable airspace requirements include the Single European Sky legislation.

SPO.IDE.H.220 Navigation equipment

Regulation (EU) 2019/1384

- (a) Helicopters shall be equipped with navigation equipment that will enable them to proceed in accordance with:
 - (1) the ATS flight plan, if applicable; and
 - (2) the applicable airspace requirements.
- (b) Helicopters shall have sufficient navigation equipment to ensure that, in the event of the failure of one item of equipment at any stage of the flight, the remaining equipment shall allow safe navigation in accordance with (a), or an appropriate contingency action to be completed safely.
- (c) Helicopters operated on flights in which it is intended to land in IMC shall be equipped with navigation equipment capable of providing guidance to a point from which a visual landing can be performed. This equipment shall be capable of providing such guidance for each aerodrome at which it is intended to land in IMC and for any designated alternate aerodromes.
- (d) For PBN operations the aircraft shall meet the airworthiness certification requirements for the appropriate navigation specification.
- (e) Helicopters shall be equipped with surveillance equipment in accordance with the applicable airspace requirements.

AMC1 SPO.IDE.H.220 Navigation equipment

ED Decision 2014/018/R

NAVIGATION WITH VISUAL REFERENCE TO LANDMARKS — OTHER-THAN COMPLEX HELICOPTERS

Where other-than complex helicopters, with the surface in sight, can proceed according to the ATS flight plan by navigation with visual reference to landmarks, no additional equipment is needed to comply with [SPO.IDE.H.220\(a\)\(1\)](#).

GM1 SPO.IDE.H.220 Navigation equipment

ED Decision 2016/021/R

AIRCRAFT ELIGIBILITY FOR PBN SPECIFICATION NOT REQUIRING SPECIFIC APPROVAL

- (a) The performance of the aircraft is usually stated in the AFM.
- (b) Where such a reference cannot be found in the AFM, other information provided by the aircraft manufacturer as TC holder, the STC holder or the design organisation having a privilege to approve minor changes may be considered.
- (c) The following documents are considered acceptable sources of information:
 - (1) AFM, supplements thereto, and documents directly referenced in the AFM;
 - (2) FCOM or similar document;
 - (3) Service Bulletin or Service Letter issued by the TC holder or STC holder;
 - (4) approved design data or data issued in support of a design change approval;
 - (5) any other formal document issued by the TC or STC holders stating compliance with PBN specifications, AMC, Advisory Circulars (AC) or similar documents issued by the State of Design; and
 - (6) written evidence obtained from the State of Design.
- (d) Equipment qualification data, in itself, is not sufficient to assess the PBN capabilities of the aircraft, since the latter depend on installation and integration.
- (e) As some PBN equipment and installations may have been certified prior to the publication of the PBN Manual and the adoption of its terminology for the navigation specifications, it is not always possible to find a clear statement of aircraft PBN capability in the AFM. However, aircraft eligibility for certain PBN specifications can rely on the aircraft performance certified for PBN procedures and routes prior to the publication of the PBN Manual.
- (f) Below, various references are listed which may be found in the AFM or other acceptable documents (see listing above) in order to consider the aircraft's eligibility for a specific PBN specification if the specific term is not used.
- (g) RNAV 5
 - (1) If a statement of compliance with any of the following specifications or standards is found in the acceptable documentation as listed above, the aircraft is eligible for RNAV 5 operations.
 - (i) B-RNAV;
 - (ii) RNAV 1;
 - (iii) RNP APCH;

- (iv) RNP 4;
 - (v) A-RNP;
 - (vi) AMC 20-4;
 - (vii) JAA TEMPORARY GUIDANCE MATERIAL, LEAFLET NO. 2 (TGL 2)
 - (viii) JAA AMJ 20X2;
 - (ix) FAA AC 20-130A for en route operations;
 - (x) FAA AC 20-138 for en route operations; and
 - (xi) FAA AC 90-96.
- (h) RNAV 1/RNAV 2
- (1) If a statement of compliance with any of the following specifications or standards is found in the acceptable documentation as listed above, the aircraft is eligible for RNAV 1/RNAV 2 operations.
 - (i) RNAV 1;
 - (ii) PRNAV;
 - (iii) US RNAV type A;
 - (iv) FAA AC 20-138 for the appropriate navigation specification;
 - (v) FAA AC 90-100A;
 - (vi) JAA TEMPORARY GUIDANCE MATERIAL, LEAFLET NO. 10 Rev1 (TGL 10);
 - (vii) FAA AC 90-100.
 - (2) However, if position determination is exclusively computed based on VOR-DME, the aircraft is not eligible for RNAV 1/RNAV 2 operations.
- (i) RNP 1/RNP 2 continental
- (1) If a statement of compliance with any of the following specifications or standards is found in the acceptable documentation as listed above, the aircraft is eligible for RNP 1/RNP 2 continental operations.
 - (i) A-RNP;
 - (ii) FAA AC 20-138 for the appropriate navigation specification; and
 - (iii) FAA AC 90-105.
 - (2) Alternatively, if a statement of compliance with any of the following specifications or standards is found in the acceptable documentation as listed above and position determination is primarily based on GNSS, the aircraft is eligible for RNP 1/RNP 2 continental operations. However, in these cases, loss of GNSS implies loss of RNP 1/RNP 2 capability.
 - (i) JAA TEMPORARY GUIDANCE MATERIAL, LEAFLET NO. 10 (TGL 10) (any revision);
and
 - (ii) FAA AC 90-100.

-
- (j) RNP APCH — LNAV minima
- (1) If a statement of compliance with any of the following specifications or standards is found in the acceptable documentation as listed above, the aircraft is eligible for RNP APCH LNAV operations.
 - (i) A-RNP;
 - (ii) AMC 20-27;
 - (iii) AMC 20-28;
 - (iv) FAA AC 20-138 for the appropriate navigation specification; and
 - (v) FAA AC 90-105 for the appropriate navigation specification.
 - (2) Alternatively, if a statement of compliance with RNP 0.3 GNSS approaches in accordance with any of the following specifications or standards is found in the acceptable documentation as listed above, the aircraft is eligible for RNP APCH — LNAV operations. Any limitation such as ‘within the US National Airspace’ may be ignored since RNP APCH procedures are assumed to meet the same ICAO criteria around the world.
 - (i) JAA TEMPORARY GUIDANCE MATERIAL, LEAFLET NO. 3 (TGL 3);
 - (ii) AMC 20-4;
 - (iii) FAA AC 20-130A; and
 - (iv) FAA AC 20-138.
- (k) RNP APCH — LNAV/VNAV minima
- (1) If a statement of compliance with any of the following specifications or standards is found in the acceptable documentation as listed above, the aircraft is eligible for RNP APCH — LNAV/VNAV operations.
 - (i) A-RNP;
 - (ii) AMC 20-27 with Baro VNAV;
 - (iii) AMC 20-28;
 - (iv) FAA AC 20-138; and
 - (v) FAA AC 90-105 for the appropriate navigation specification.
 - (2) Alternatively, if a statement of compliance with FAA AC 20-129 is found in the acceptable documentation as listed above, and the aircraft complies with the requirements and limitations of EASA SIB 2014-04¹, the aircraft is eligible for RNP APCH — LNAV/VNAV operations. Any limitation such as ‘within the US National Airspace’ may be ignored since RNP APCH procedures are assumed to meet the same ICAO criteria around the world.
- (l) RNP APCH — LPV minima
- (1) If a statement of compliance with any of the following specifications or standards is found in the acceptable documentation as listed above, the aircraft is eligible for RNP APCH — LPV operations.
 - (i) AMC 20-28;

¹ <http://ad.easa.europa.eu/ad/2014-04>

- (ii) FAA AC 20-138 for the appropriate navigation specification; and
 - (iii) FAA AC 90-107.
 - (2) For aircraft that have a TAWS Class A installed and do not provide Mode-5 protection on an LPV approach, the DH is limited to 250 ft.
- (m) RNAV 10
- (1) If a statement of compliance with any of the following specifications or standards is found in the acceptable documentation as listed above, the aircraft is eligible for RNAV 10 operations.
 - (i) RNP 10;
 - (ii) FAA AC 20-138 for the appropriate navigation specification;
 - (iii) AMC 20-12;
 - (iv) FAA Order 8400.12 (or later revision); and
 - (v) FAA AC 90-105.
- (n) RNP 4
- (1) If a statement of compliance with any of the following specifications or standards is found in the acceptable documentation as listed above, the aircraft is eligible for RNP 4 operations.
 - (i) FAA AC 20-138B or later, for the appropriate navigation specification;
 - (ii) FAA Order 8400.33; and
 - (iii) FAA AC 90-105 for the appropriate navigation specification.
- (o) RNP 2 oceanic
- (1) If a statement of compliance with FAA AC 90-105 for the appropriate navigation specification is found in the acceptable documentation as listed above, the aircraft is eligible for RNP 2 oceanic operations.
 - (2) If the aircraft has been assessed eligible for RNP 4, the aircraft is eligible for RNP 2 oceanic.
- (p) Special features
- (1) RF in terminal operations (used in RNP 1 and in the initial segment of the RNP APCH)
 - (i) If a statement of demonstrated capability to perform an RF leg, certified in accordance with any of the following specifications or standards, is found in the acceptable documentation as listed above, the aircraft is eligible for RF in terminal operations:
 - (A) AMC 20-26;
 - (B) FAA AC 20-138B or later.
 - (ii) If there is a reference to RF and a reference to compliance with AC 90-105, then the aircraft is eligible for such operations.
- (q) Other considerations
- (1) In all cases, the limitations in the AFM need to be checked, in particular the use of AP or FD which can be required to reduce the FTE primarily for RNP APCH, RNAV 1, and RNP 1.

- (2) Any limitation such as ‘within the US National Airspace’ may be ignored since RNP APCH procedures are assumed to meet the same ICAO criteria around the world.

GM2 SPO.IDE.H.220 Navigation equipment

ED Decision 2016/021/R

GENERAL

- (a) The PBN specifications for which the aircraft complies with the relevant airworthiness criteria are set out in the AFM, together with any limitations to be observed.
- (b) Because functional and performance requirements are defined for each navigation specification, an aircraft approved for an RNP specification is not automatically approved for all RNAV specifications. Similarly, an aircraft approved for an RNP or RNAV specification having a stringent accuracy requirement (e.g. RNP 0.3 specification) is not automatically approved for a navigation specification having a less stringent accuracy requirement (e.g. RNP 4).

RNP 4

- (c) For RNP 4, at least two LRNSs, capable of navigating to RNP 4, and listed in the AFM, may be operational at the entry point of the RNP 4 airspace. If an item of equipment required for RNP 4 operations is unserviceable, then the flight crew may consider an alternate route or diversion for repairs. For multi-sensor systems, the AFM may permit entry if one GNSS sensor is lost after departure, provided one GNSS and one inertial sensor remain available.

SPO.IDE.H.225 Transponder

Regulation (EU) No 379/2014

Where required by the airspace being flown, helicopters shall be equipped with a secondary surveillance radar (SSR) transponder with all the required capabilities.

AMC1 SPO.IDE.H.225 Transponder

Regulation (EU) 2014/018/R

GENERAL

- (a) The SSR transponders of helicopters being operated under European air traffic control should comply with any applicable Single European Sky legislation.
- (b) If the Single European Sky legislation is not applicable, the SSR transponders should operate in accordance with the relevant provisions of Volume IV of ICAO Annex 10.

SPO.IDE.H.230 Management of aeronautical databases

Regulation (EU) 2016/1199

- (a) Aeronautical databases used on certified aircraft system applications shall meet data quality requirements that are adequate for the intended use of the data.
- (b) The operator shall ensure the timely distribution and insertion of current and unaltered aeronautical databases to all aircraft that require them.
- (c) Notwithstanding any other occurrence reporting requirements as defined in Regulation (EU) No 376/2014, the operator shall report to the database provider instances of erroneous, inconsistent or missing data that might be reasonably expected to constitute a hazard to flight.

In such cases, the operator shall inform flight crew and other personnel concerned, and shall ensure that the affected data is not used.

AMC1 SPO.IDE.H.230 Management of aeronautical databases

ED Decision 2014/018/R

AERONAUTICAL DATABASES

When the operator of an aircraft uses an aeronautical database that supports an airborne navigation application as a primary means of navigation used to meet the airspace usage requirements, the database provider should be a Type 2 DAT provider certified in accordance with Regulation (EU) 2017/373 or equivalent.

GM1 SPO.IDE.H.230 Management of aeronautical databases

ED Decision 2017/003/R

AERONAUTICAL DATABASE APPLICATIONS

- (a) Applications using aeronautical databases for which Type 2 DAT providers should be certified in accordance with Regulation (EU) 2017/373 may be found in GM1 DAT.OR.100.
- (b) The certification of a Type 2 DAT provider in accordance with Regulation (EU) 2017/373 ensures data integrity and compatibility with the certified aircraft application/equipment.

GM2 SPO.IDE.H.230 Management of aeronautical databases

ED Decision 2017/003/R

TIMELY DISTRIBUTION

The operator should distribute current and unaltered aeronautical databases to all aircraft requiring them in accordance with the validity period of the databases or in accordance with a procedure established in the operations manual if no validity period is defined.

GM3 SPO.IDE.H.230 Management of aeronautical databases

ED Decision 2017/003/R

STANDARDS FOR AERONAUTICAL DATABASES AND DAT PROVIDERS

- (a) A 'Type 2 DAT provider' is an organisation as defined in Article 2(5)(b) of Regulation (EU) 2017/373.
- (b) Equivalent to a certified 'Type 2 DAT provider' is defined in any Aviation Safety Agreement between the European Union and a third country, including any Technical Implementation Procedures, or any Working Arrangements between EASA and the competent authority of a third country.

SUBPART E: SPECIFIC REQUIREMENTS

SECTION 1 – HELICOPTER EXTERNAL SLING LOAD OPERATIONS (HESLO)

SPO.SPEC.HESLO.100 Standard operating procedures

Regulation (EU) 2019/1384

The standard operating procedures for HESLO shall specify:

- (a) the equipment to be carried, including its operating limitations and appropriate entries in the MEL, as applicable;
- (b) crew composition and experience requirements of crew members and task specialists;
- (c) the relevant theoretical and practical training for crew members to perform their tasks, the relevant training for task specialists to perform their tasks, and the qualification and nomination of persons providing such training to crew members and task specialists;
- (d) responsibilities and duties of crew members and task specialists;
- (e) helicopter performance criteria necessary to be met to conduct HESLO operations;
- (f) normal, abnormal and emergency procedures.

AMC1 SPO.SPEC.HESLO.100 Standard operating procedures

ED Decision 2017/012/R

STANDARD OPERATING PROCEDURES

- (a) Before conducting any HESLO, the operator should develop its SOPs taking into account the elements below.
- (b) Nature and complexity of the activity
 - (1) Nature of the activity and exposure:

Helicopter flights for the purpose of transporting external loads by different means, e.g. under slung, external pods or racks. These operations are usually performed at a low height.
 - (2) Complexity of the activity:

The complexity of the activity varies with the size and the shape of the load, the length of the rope and characteristics of the pick-up and drop-off zones, the time per load cycle, etc.

Table 1: HESLO types

HESLO 1:	short line, 20 metres (m) or less
HESLO 2:	long line, more than 20 m
HESLO 3:	specialised sling load, such as: Logging, insulators and pullers, traverse mounting, spinning of fibre cable, ice and snow removal from power lines, sawing, geophysical surveys, cable laying onto the ground or into ditches, avalanche control, landslide control
HESLO 4:	Advanced sling load such as: Tower erecting, wire stringing, disassembly of masts and towers

-
- (3) Operational environment and geographical area:
- HESLO may be performed over any geographical area. Special attention should be given to:
- (i) hostile and congested;
 - (ii) mountains;
 - (iii) sea;
 - (iv) jungle;
 - (v) desert; and
 - (vi) polar;
 - (vii) lakes and river canyons; and
 - (viii) environmentally sensitive areas (e.g. national parks, noise sensitive areas).
- (c) Equipment
- (1) The helicopter may be equipped with:
- (i) additional mirror(s) and/or video camera(s);
 - (ii) a bubble window;
 - (iii) supplementary hook(s) or multi-hook device(s); and
 - (iv) load data recorder (lifts, weights, torques, power, forces, shocks and electrical activities)
- (2) When conducting single-pilot vertical reference operations with no assistance of a task specialist or other crew member, additional engine monitoring in the pilot line of vision or an audio warning system is recommended.
- (3) All additional equipment used, e.g. ropes, cables, mechanical hooks, swivel hooks, nets, buckets, chainsaws, baskets, containers, should be manufactured according to applicable rules or recognised standards. The operator should be responsible for maintaining the serviceability of this equipment.
- (4) Adequate radio communication equipment (e.g. VHF, UHF, FM) should be installed and serviceable in the helicopter for co-ordination with the task specialists involved in the operation.
- (5) Task specialists involved in the operation should be equipped with hand-held communication equipment, protective helmets with integrated earphones and microphones, and the relevant personal protective equipment.
- (d) Crew members
- (1) Crew composition:
- (i) The minimum flight crew as stated in the approved AFM. For operational or training purposes, an additional crew member may assist the pilot-in-command (PIC) in a single-pilot operation. In such a case:
 - (A) procedures are in place for a crew member to monitor the flight, especially during the departure, approach and HESLO cycle, to ensure that a safe flight path is maintained; and

- (B) when a task specialist is tasked with assisting the pilot, the procedures according to which this assistance is taking place should be clearly defined.
 - (ii) For safety and/or operational purposes, task specialists should be instructed by the operator to fulfil specified tasks.
- (2) Pilot training for HESLO

Before acting as unsupervised PIC, the pilot should demonstrate to the operator that he/she has the required skills and knowledge.

- (i) Theoretical knowledge for HESLO 1:
 - (A) content of the operations manual (OM) including the relevant SOPs;
 - (B) AFM (limitations, performance, mass and balance, abnormal and emergency procedures, etc.);
 - (C) procedures (e.g. short line, long line, construction, wire stringing or cable laying flying techniques), as required for the operation;
 - (D) load and site preparation including load rigging techniques and external load procedures;
 - (E) special equipment used in the operation;
 - (F) training in human factor principles; and
 - (G) hazards and dangers.
- (ii) Theoretical knowledge for other HESLO levels should include the elements listed in point (i) above where additional knowledge to that of HESLO 1 is needed for the adequate HESLO level.
- (iii) Practical training defined in the operator's training programme:
 - (A) Flight instruction provided by a HESLO instructor; and
 - (B) Flight under the supervision of a HESLO instructor. The supervision should take place during HESLO missions, from inside the helicopter and on-site.

For the purpose of this AMC, a HESLO mission is defined as a flight or series of flights from point A to point B on a particular day and for commercial specialised operations, for a particular client.

- (3) Pilot experience
- (i) Prior to commencing training:
 - (A) 10 hours flight experience on the helicopter type;
 - (B) For HESLO 2: At least 100 HESLO cycles;
 - (C) For HESLO 3: At least 500 HESLO cycles; and
 - (D) For HESLO 4: At least 1 000 flight hours on helicopters and 2 000 HESLO cycles, including experience as unsupervised PIC in HESLO 2 or HESLO 3.
 - (ii) Before acting as PIC under the supervision of a HESLO instructor:
 - (A) For HESLO 1: At least 5 hours and 50 HESLO cycles flight instruction;
 - (B) For HESLO 2: In addition to HESLO 1 training, at least 2 hours and 20 HESLO cycles flight instruction with a long line of more than 20 metres.

- (C) For HESLO 3 and 4: A number of HESLO cycles flight instruction, as relevant to the activity to be performed and the required skills.
- (iii) Before acting as unsupervised PIC:
 - (A) For HELSO 1, 300 hours helicopter flight experience as PIC; and
 - (B) For HESLO 1: At least 8 hours, 80 HESLO cycles and 5 HESLO missions;
 - (C) For HESLO 2: At least 5 hours, 50 HESLO cycles and 5 HESLO missions with long line of more than 20 metres;
 - (D) For HESLO 3 and 4: A number of HESLO missions under the supervision of a HESLO instructor, as relevant to the activity to be performed and the required skills;
 - (E) For HESLO 3 and 4, 15 hours on the helicopter type, performing HESLO 1 and 2 operations;
 - (F) At least 20 hours gained in an operational environment similar to the environment of intended operation (desert, sea, jungle, mountains, etc.).
- (4) Pilot proficiency: Before acting as unsupervised PIC, pilot proficiency has been assessed as sufficient for the intended operations and environment under the relevant HESLO type, by a HESLO instructor nominated by the operator.
- (5) Pilot recurrent training and checking at least every two years:
 - (i) review of the load rigging techniques;
 - (ii) external load procedures;
 - (iii) review of the applicable flying techniques; and
 - (iv) review of human factor principles.
 - (v) A pilot who has performed 20 hours of relevant HESLO within the past 12 months may not need any further flight training other than in accordance with Part-ORO and Part-FCL.

(e) Task specialists

Before acting as task specialist, he/she should demonstrate to the operator that he/she has been trained appropriately and has the required skill and knowledge.

(1) Initial training

- (i) The initial training of task specialists should include at least:
 - (A) behaviour in a rotor turning environment and training in ground safety and emergency procedures;
 - (B) procedures including load rigging, usage and conservation (replacement) of LLD;
 - (C) helicopter marshalling signals;
 - (D) radio communication;
 - (E) selection and preparation of pick-up and drop-off sites, dangers on working places (downwash, loose goods, third people);
 - (F) handling and safety of the third party;

- (G) relevant training for the helicopter type;
 - (H) duties and responsibilities as described in the appropriate manual;
 - (I) perception and classification of flight obstacles (none, critical, danger), measures for safety;
 - (J) human factor principles; and
 - (K) for task specialists seated in the cockpit and whose tasks are to assist the pilot, the relevant CRM training elements as specified in [ORO.FC.115](#).
- (ii) The individual safety equipment appropriate to the operational environment and complexity of the activity should be described in the appropriate manual.
- (2) Recurrent training
- (i) The annual recurrent training should include the items listed in the initial training as described in (e)(1) above.
 - (ii) The operator should establish a formal qualification list for each task specialist.
 - (iii) The operator should establish a system of record keeping that allows adequate storage and reliable traceability of:
 - (A) the initial and recurrent training;
 - (B) Qualifications (qualification list).
- (3) Briefing of task specialists
- Briefings on the organisation and coordination between the flight crew and task specialists involved in the operation should take place prior to each operation. These briefings should include at least the following:
- (i) location and size of pick-up and drop-off site, operating altitude;
 - (ii) location of refuelling site and procedures to be applied;
 - (iii) load sequence, danger areas, performance and limitations, emergency procedures; and
 - (iv) for a task specialist who has not received the relevant elements of CRM training as specified in [ORO.FC.115](#), the operator's crew coordination concept including relevant elements of CRM.
- (4) Responsibility of task specialists operating on the ground:
- (i) Task specialists operating on the ground are responsible for the safe organisation of the ground operation, including:
 - (A) adequate selection and preparation of the pick-up and drop-off points and load rigging;
 - (B) appropriate communication and assistance to the flight crew and other task specialists; and
 - (C) access restriction on the pick-up and drop-off site.
 - (ii) If more than one task specialist is required for a task, one should be nominated as leading the activities. He/she should act as the main link between the flight crew and other task specialist(s) involved in the operation and is responsible for:

- (A) task specialist coordination and activities on the ground; and
- (B) the safety of the working area (loading and fuelling).

(f) HESLO instructor

The HESLO instructor should be assigned by the operator on the basis of the following:

- (1) the HESLO instructor for pilots should:
 - (i) be suitably qualified as determined by the operator and have a minimum experience of 500 hours HESLO;
 - (ii) have at least 10 hours HESLO experience as unsupervised PIC in the appropriate HESLO level on which instruction, supervision and proficiency assessments are to be provided; and
 - (iii) have attended the 'teaching and learning' part of the flight instructor or type rating instructor training, or have prior experience as an aerial work instructor subject to national rules.
- (2) the HESLO instructor for task specialists should be suitably qualified as determined by the operator and have at least 2 years of experience in HESLO operations.

(g) Performance

- (1) Power margins for HESLO operations:
 - (i) HESLO 1 and 2

The mass of the helicopter should not exceed the maximum mass specified in accordance with [SPO.POL.146\(c\)\(1\)](#) at the pick-up or drop-off site, whichever is higher, as stated in the appropriate manual.
 - (ii) HESLO 3 and 4

The mass of the helicopter should not exceed the maximum mass specified in accordance with [SPO.POL.146\(c\)\(1\)](#) at the pick-up or drop-off site, whichever is higher, as stated in the appropriate manual, and in the case of construction (montage) operations, reduced by 10% of the mass of the sling load capacity.

(h) Normal procedures

- (1) Operating procedures:

HESLO should be performed in accordance with the appropriate manual and appropriate operating procedures. These procedures should include, for each type of operation:

 - (i) crew individual safety equipment (e.g. helmet, fire-retardant suits);
 - (ii) crew responsibilities;
 - (iii) crew coordination and communication;
 - (iv) selection and size of pick-up and drop-off sites;
 - (v) selection of flight routes;
 - (vi) fuel management in the air and on the ground;
 - (vii) task management; and
 - (viii) third party risk management.

(2) Ground procedures:

The operator should specify appropriate procedures, including:

- (i) use of ground equipment;
- (ii) load rigging;
- (iii) size and weight assessment of loads;
- (iv) attachment of suitably prepared loads to the helicopter;
- (v) two-way radio communication procedures;
- (vi) selection of suitable pick-up and drop-off sites;
- (vii) safety instructions for task specialists operating on the ground;
- (viii) helicopter performances information;
- (ix) fuel management on the ground;
- (x) responsibility, organisation and task management of other personnel on the ground involved in the operation;
- (xi) third party risk management; and
- (xii) environmental protection.

(i) Emergency procedures

(1) Operating procedures for the flight crew:

In addition to the emergency procedures published in the AFM or OM, the operator should ensure that the flight crew:

- (i) is familiar with the appropriate emergency procedures;
- (ii) has appropriate knowledge of the emergency procedures for personnel on the ground involved in the operation; and
- (iii) reports emergencies as specified in the AFM or OM.

(2) Ground procedures:

The operator should ensure that the task specialist on the ground involved in the operation:

- (i) is familiar with the appropriate emergency procedures;
- (ii) has appropriate knowledge of the flight crew emergency procedures;
- (iii) reports emergencies as specified in the AFM or OM; and
- (iv) prevents, as far as possible, environmental pollution.

(j) Ground equipment

The operator should specify the use of ground equipment, such as fuel trucks, cables, strops, etc. in the AFM or OM, including at least:

- (1) minimum size of the operating site;
- (2) surface condition;
- (3) positioning of ground equipment on the operating site;

- (4) fuel handling;
- (5) environment protection plan; and
- (6) location and use of fire suppression equipment.

GM1 SPO.SPEC.HESLO.100 Standard operating procedures

ED Decision 2017/012/R

PILOT INITIAL TRAINING

The table below summarises minimum training standards.

Table 1: Training minimum standards

HESLO 1	<ul style="list-style-type: none"> — CPL(H) or ATPL(H) — PPL(H) only for non-commercial operations — Minimum 10 hours PIC on type — Type rating completed — HESLO ground instruction completed — Task specialist syllabus reviewed — HESLO 1 flight instruction completed: Minimum 5 hours/50 HESLO cycles — HESLO 1 flights under supervision completed — Minimum experience 8 hours/80 HESLO cycles/5 HESLO missions — Minimum 300 hours PIC(H) — HESLO 1 proficiency
HESLO 2	<ul style="list-style-type: none"> — CPL(H) or ATPL(H) — PPL(H) only for non-commercial operations — HESLO level 1 completed — Type rating completed — Minimum 10 hours PIC on type — HESLO 2 ground instruction completed — Task specialist syllabus reviewed — Minimum 100 HESLO cycles — HESLO 2 flight instruction completed: Minimum 2 hours/20 HESLO cycles with long line — HESLO 2 flights under supervision completed — Minimum experience 5 hours/50 HESLO 2 cycles/5 HESLO 2 missions — HESLO 2 proficiency
HESLO 3	<ul style="list-style-type: none"> — CPL(H) or ATPL(H) — PPL(H) only for non-commercial operations — HESLO level 1 completed to 20m — Min. 500 HESLO cycles — Type rating completed — Minimum 10 hours PIC on type — HESLO 3 ground instruction completed — Task specialist syllabus reviewed — Practical Task specialist training for logging — HESLO 3 flight instruction completed — HESLO 3 flights under supervision completed — HESLO 3 proficiency
HESLO 4	<ul style="list-style-type: none"> — CPL(H) or ATPL(H) — PPL(H) only for non-commercial operations — Minimum 1 000 hours (H) — HESLO level 2 or 3 completed — Minimum 2 000 HESLO cycles

- Type rating completed
- Minimum 10 hours PIC on type
- HESLO 4 ground instruction completed
- Practical load preparation training
- HESLO 4 flight instruction completed
- HESLO 4 flights under supervision completed
- HESLO 4 proficiency

HESLO ground instruction, HESLO flight training, HESLO flights under supervision and HESLO proficiency assessments may be combined with the operator's conversion course.

SPO.SPEC.HESLO.105 Specific HESLO equipment

Regulation (EU) No 379/2014

The helicopter shall be equipped with at least:

- (a) one cargo safety mirror or alternative means to see the hook(s)/load; and
- (b) one load meter, unless there is another method of determining the weight of the load.

SPO.SPEC.HESLO.110 Transportation of dangerous goods

Regulation (EU) No 379/2014

The operator transporting dangerous goods to or from unmanned sites or remote locations shall apply to the competent authority for an exemption from the provisions of the Technical Instructions if they intend not to comply with the requirements of those Instructions.

SECTION 2 – HUMAN EXTERNAL CARGO OPERATIONS (HEC)

SPO.SPEC.HEC.100 Standard operating procedures

Regulation (EU) 2019/1384

The standard operating procedures for HEC shall specify:

- (a) the equipment to be carried, including its operating limitations and appropriate entries in the MEL, as applicable;
- (b) crew composition and experience requirements of crew members and task specialists;
- (c) the relevant theoretical and practical training for crew members to perform their tasks, the relevant training for task specialists to perform their tasks, and the qualification and nomination of persons providing such training to crew members and task specialists;
- (d) responsibilities and duties of crew members and task specialists;
- (e) helicopter performance criteria necessary to be met to conduct HEC operations;
- (f) normal, abnormal and emergency procedures.

AMC1 SPO.SPEC.HEC.100 Standard operating procedures

ED Decision 2017/012/R

STANDARD OPERATING PROCEDURES

(a) Before conducting any HEC operations, the operator should develop its SOPs taking into account the elements below.

(b) Nature and complexity of the activity

(1) Nature of the activity and exposure:

HEC operations are usually performed at a low height.

(2) Complexity of the activity:

(i) The complexity of the activity varies with the length of the rope and characteristics of the pick-up and drop-off zones, etc.

Table 1: HEC levels

HEC 1:	Sling or cable length is less or equal to 25 m
HEC 2:	Sling or cable length is greater than 25 m

(3) Operational environment and geographical area:

HEC may be performed over any geographical area. Special attention should be given to:

(i) hostile congested and non-congested environment;

(ii) mountains;

(iii) sea;

(iv) jungle;

(v) desert;

(vi) arctic;

(vii) lakes and river canyons; and

(viii) environmentally sensitive areas (e.g. national parks, noise sensitive areas).

(c) Equipment

(1) The helicopter may be equipped with:

(i) additional mirror(s) and/or video camera(s);

(ii) a bubble window;

(iii) supplementary hook(s) or multi-hook device(s); and

(iv) load data recorder (lifts, weights, torques, power, forces, shocks and electrical activities).

(2) When conducting single-pilot vertical reference operations with no assistance of a task specialist or other crew member, additional engine monitoring in the pilot line of vision or an audio warning system is recommended.

(3) Adequate radio communication equipment (e.g. VHF, UHF, FM) should be installed in the helicopter for co-ordination with the task specialist involved in the operation.

-
- (4) Task specialists involved in the operation should be equipped with hand-held communication equipment, protective helmets with integrated earphones and microphones as well as personal protective equipment.
- (d) Crew members
- (1) Crew composition:
- (i) The minimum flight crew is stated in the approved AFM. For operational or training purposes, an additional qualified crew member may assist the PIC in a single-pilot operation. In such a case:
- (A) procedures are in place for a member of the flight crew to monitor the flight, especially during the departure, approach and HEC operations, to ensure that a safe flight path is maintained; and
- (B) when a task specialist is tasked with assisting the pilot, the procedures according to which this assistance is taking place should be clearly defined.
- (ii) For safety and/or operational purposes, a task specialist may be required by the operator to fulfil the task (e.g. to establish vertical reference or to operate the release safety device for the belly rope).
- (2) Pilot initial training:
- Before acting as PIC, the pilot should demonstrate to the operator that he/she has the required skills and knowledge, as follows:
- (i) Theoretical knowledge:
- (A) load rigging techniques;
- (B) external load procedures;
- (C) site organisation and safety measures;
- (D) short line, long line, construction, wire stringing or cable laying flying techniques, as required for the operation.
- (ii) Pilot experience prior to commencing the training:
- (A) 10 hours flight experience on the helicopter type;
- (B) type rating completed;
- (C) HESLO type 1 or 2 completed;
- (D) relevant experience in the field of operation;
- (E) training in human factor principles; and
- (F) ground instruction completed (marshaller syllabus).
- (iii) Pilot experience prior to commencing unsupervised HEC flights:
- (A) HEC flight instruction completed.
- (B) 1 000 hours helicopter flight experience as PIC.
- (C) for mountain operations, 500 hours of flight experience as PIC in mountain operations.
- (D) for HEC 2, HESLO type 2 completed.

-
- (3) Pilot proficiency prior to commencing unsupervised HEC flights:
- Pilot proficiency has been assessed as sufficient for the intended operations and environment under the relevant HEC level, by a HEC instructor nominated by the operator.
- (4) Pilot recurrent training and checking at least every two years:
- (i) review of the sling technique;
 - (ii) external load procedures;
 - (iii) training in human factor principles; and
 - (iv) review of the applicable flying techniques, which should take place during a training flight if the pilot has not performed HEC or HHO operations within the past 24 months.
- (5) Conditions of HEC instruction:
- (i) Maximum sling length according to the level applicable:
 - (A) 1 task specialist (with radio) at pickup point;
 - (B) 1 task specialist (with radio) at drop off point/on the line;
 - (C) helicopter fitted with cargo mirror/bubble window;
 - (D) flight instruction DC/: Cycles DC/minimum 10 cycles which of 5 Human Cargo Sling; and
 - (E) flight instruction solo with onsite supervision/Cycles solo/minimum 10 cycles.
 - (ii) HEC instructor:

The HEC instructor should be assigned by the operator on the basis of the following:

 - (A) the HEC instructor for pilots should:
 - have a minimum experience of 100 cycles in HEC operations at HEC levels equal to or greater than that on which instruction, supervision and proficiency assessment are to be provided; and
 - have attended the ‘teaching and learning’ part of the flight instructor or type rating instructor training, or have prior experience as an aerial work instructor subject to national rules;
 - (B) the HEC instructor for task specialists should be suitably qualified as determined by the operator and have at least 2 years of experience in HEC operations as a task specialist.
- (e) Task specialists
- Before acting as task specialists, they should demonstrate to the operator that they have been appropriately trained and have the required skills and knowledge including training on human factor principles.
- (1) Task specialists should receive training relevant to their tasks including:
- (i) fitting and removal of system; and

- (ii) normal procedure.

For task specialists in charge of assisting the pilot, the relevant CRM training elements as specified in [AMC1 ORO.FC.115](#).

(2) Briefings

Briefings on the organisation and coordination between flight crew and task specialist involved in the operation should take place prior to each operation. These briefings should include at least the following:

- (i) location and size of pick-up and drop-off site, operating altitude;
- (ii) location of refuelling site and procedures to be applied; and
- (iii) load sequence, danger areas, performance and limitations, emergency procedures.
- (iv) for task specialists who have not received the relevant elements of CRM training as specified in [AMC1 ORO.FC.115](#), the operator's crew coordination concept including relevant elements of crew resource management.

(3) Recurrent training

- (i) The annual recurrent training should include the items listed in the initial training as described in (e)(1) above.
- (ii) The operator should establish a formal qualification list for each task specialist.
- (iii) The operator should establish a system of record keeping that allows adequate storage and reliable traceability of:
 - (A) the initial and recurrent training;
 - (B) qualifications (qualification list).

(f) Performance

HEC should be performed with the following power margins: the mass of the helicopter should not exceed the maximum mass specified in accordance with [SPO.POL.146\(c\)\(1\)](#).

(g) Normal procedures

(1) Operating procedures:

HEC should be performed in accordance with the AFM. Operating procedures should include, for each type of operation:

- (i) crew individual safety equipment (e.g. helmet, fire retardant suits);
- (ii) crew responsibilities;
- (iii) crew coordination and communication;
- (iv) selection and size of pick-up and drop-off sites;
- (v) selection of flight routes;
- (vi) fuel management in the air and on the ground;
- (vii) task management; and
- (viii) third party risk management.

(2) Ground procedures:

The operator should specify appropriate procedures, including:

- (i) use of ground equipment;
- (ii) load rigging;
- (iii) size and weight assessment of loads;
- (iv) attachment of suitably prepared loads to the helicopter;
- (v) two-way radio communication procedures;
- (vi) selection of suitable pick-up and drop-off sites;
- (vii) safety instructions for ground task specialists or other persons required for the safe conduct of the operation;
- (viii) helicopter performances information;
- (ix) fuel management on the ground;
- (x) responsibility and organisation of the personnel on the ground involved in the operation;
- (xi) task management of personnel on the ground involved in the operation;
- (xii) third party risk management; and
- (xiii) environmental protection.

(h) Emergency procedures

(1) Operating procedures:

In addition to the emergency procedures published in the AFM or OM, the operator should ensure that the flight crew:

- (i) is familiar with the appropriate emergency procedures;
- (ii) has appropriate knowledge of the emergency procedures for personnel on the ground involved in the operation; and
- (iii) reports emergencies as specified in the AFM or OM.

(2) Ground procedures:

The operator should ensure that the task specialist on the ground involved in the operation:

- (i) is familiar with the appropriate emergency procedures;
- (ii) has appropriate knowledge of the emergency procedures for personnel on the ground involved in the operation;
- (iii) reports emergencies as specified in the AFM or OM; and
- (iv) prevents, as far as possible, environmental pollution.

SPO.SPEC.HEC.105 Specific HEC equipment

Regulation (EU) 2019/1384

- (a) The helicopter shall be equipped with:
 - (1) hoist operations equipment or cargo hook;
 - (2) one cargo safety mirror or alternative means to see the hook; and
 - (3) one load meter, unless there is another method of determining the weight of the load.
- (b) The installation of all hoist and cargo hook equipment other than a simple PCDS, and any subsequent modifications shall have an airworthiness approval appropriate to the intended function.

AMC1 SPO.SPEC.HEC.105(b) Specific HEC equipment

ED Decision 2014/018/R

AIRWORTHINESS APPROVAL FOR HEC EQUIPMENT

- (a) Hoist or cargo hook installations that have been certificated according to any of the following standards should be considered to satisfy the airworthiness criteria for HEC operations:
 - (1) CS 27.865 or CS 29.865;
 - (2) JAR 27 Amendment 2 (27.865) or JAR 29 Amendment 2 (29.865) or later;
 - (3) FAR 27 Amendment 36 (27.865) or later — including compliance with CS 27.865(c)(6); or
 - (4) FAR 29 Amendment 43 (29.865) or later.
- (b) Hoist or cargo hook installations that have been certified prior to the issuance of the airworthiness criteria for HEC as defined in (a) may be considered as eligible for HEC provided that following a risk assessment either:
 - (1) the service history of the hoist or cargo hook installation is found satisfactory to the competent authority; or
 - (2) for hoist or cargo hook installations with an unsatisfactory service history, additional substantiation to allow acceptance by the competent authority should be provided by the hoist or cargo hook installation certificate holder (type certificate (TC) or supplemental type certificate (STC)) on the basis of the following requirements:
 - (i) The hoist or cargo hook installation should withstand a force equal to a limit static load factor of 3.5, or some lower load factor, not less than 2.5, demonstrated to be the maximum load factor expected during hoist operations, multiplied by the maximum authorised external load.
 - (ii) The reliability of the primary and back up quick release systems at helicopter level should be established and failure mode and effect analysis at equipment level should be available. The assessment of the design of the primary and back up quick release systems should consider any failure that could be induced by a failure mode of any other electrical or mechanical rotorcraft system.
 - (iii) The appropriate manual should contain one-engine-inoperative (OEI) hover performance data or single engine failures procedures for the weights, altitudes, and temperatures throughout the flight envelope for which hoist or cargo hook operations are accepted.

- (iv) Information concerning the inspection intervals and retirement life of the hoist or cargo hook cable should be provided in the instructions for continued airworthiness.

SECTION 3 – PARACHUTE OPERATIONS (PAR)

SPO.SPEC.PAR.100 Standard operating procedures

Regulation (EU) No 379/2014

The standard operating procedures for PAR shall specify:

- (a) the equipment to be carried, including its operating limitations and appropriate entries in the MEL, as applicable;
- (b) crew composition and experience requirements of crew members and task specialists;
- (c) the relevant training for crew members and task specialists to perform their task and the qualification and nomination of persons providing such training to the crew members and task specialists;
- (d) responsibilities and duties of crew members and task specialists;
- (e) performance criteria necessary to be met to conduct parachute operations;
- (f) normal, abnormal and emergency procedures.

SPO.SPEC.PAR.105 Carriage of crew members and task specialists

Regulation (EU) No 379/2014

The requirement for task specialist's responsibilities as laid down in [SPO.GEN.106\(c\)](#) shall not be applicable for task specialists performing parachute jumping.

SPO.SPEC.PAR.110 Seats

Regulation (EU) No 379/2014

Notwithstanding [SPO.IDE.A.160\(a\)](#) and [SPO.IDE.H.160\(a\)\(1\)](#), the floor of the aircraft may be used as a seat, provided means are available for the task specialist to hold or strap on.

SPO.SPEC.PAR.115 Supplemental oxygen

Regulation (EU) No 379/2014

Notwithstanding [SPO.OP.195\(a\)](#), the requirement to use supplemental oxygen shall not be applicable for crew members other than the pilot-in-command and for task specialists carrying out duties essential to the specialised task, whenever the cabin altitude:

- (a) exceeds 13 000 ft, for a period of not more than 6 minutes.
- (b) exceeds 15 000 ft, for a period of not more 3 minutes.

SPO.SPEC.PAR.125 Releasing of dangerous goods

Regulation (EU) 2019/1384

Notwithstanding point [SPO.GEN.155](#), parachutists may exit the aircraft for the purpose of parachute display over congested areas of cities, towns or settlements or over an open-air assembly of persons whilst carrying smoke trail devices, provided those are manufactured for that purpose.

SECTION 4 – AEROBATIC FLIGHTS (ABF)

SPO.SPEC.ABF.100 Standard operating procedures

Regulation (EU) No 379/2014

The standard operating procedures for ABF shall specify:

- (a) the equipment to be carried, including its operating limitations and appropriate entries in the MEL, as applicable;
- (b) crew composition and experience requirements of crew members and task specialists;
- (c) the relevant training for crew members and task specialists to perform their task and the qualification and nomination of persons providing such training to the crew members and task specialists;
- (d) responsibilities and duties of crew members and task specialists;
- (e) performance criteria necessary to be met to conduct aerobatic flights;
- (f) normal, abnormal and emergency procedures.

SPO.SPEC.ABF.105 Documents, manuals and information to be carried

Regulation (EU) No 379/2014

The following documents listed in [SPO.GEN.140\(a\)](#) need not be carried during aerobatic flights:

- (a) details of the filed ATS flight plan, if applicable;
- (b) current and suitable aeronautical charts for the route/area of the proposed flight and all routes along which it is reasonable to expect that the flight may be diverted;
- (c) procedures and visual signals information for use by intercepting and intercepted aircraft; and
- (d) information concerning search and rescue services for the area of the intended flight.

SPO.SPEC.ABF.115 Equipment

Regulation (EU) No 379/2014

The following equipment requirements need not be applicable to aerobatic flights:

- (a) first-aids kit as laid down in [SPO.IDE.A.165](#) and [SPO.IDE.H.165](#);
- (b) hand-fire extinguishers as laid down in [SPO.IDE.A.180](#) and [SPO.IDE.H.180](#); and
- (c) emergency locator transmitters or personal locator beacons as laid down in [SPO.IDE.A.190](#) and [SPO.IDE.H.190](#).

SECTION 5 – MAINTENANCE CHECK FLIGHTS (MCFs)

SPO.SPEC.MCF.100 Levels of maintenance check flight

Regulation (EU) 2019/1387

Before conducting a maintenance check flight, the operator shall determine the applicable level of the maintenance check flight as follows:

- (a) “Level A” maintenance check flight for a flight where the use of abnormal or emergency procedures, as defined in the aircraft flight manual, is expected, or where a flight is required to prove the functioning of a backup system or other safety devices;
- (b) a “Level B” maintenance check flight for any maintenance check flights other than a “Level A” maintenance check flight.

SPO.SPEC.MCF.105 Flight programme for a 'Level A' maintenance check flight

Regulation (EU) 2019/1384

Before conducting a Level A maintenance check flight with a complex motor-powered aircraft, the operator shall develop and document a flight programme.

GM1 SPO.SPEC.MCF.105 Flight programme

ED Decision 2019/019/R

DOCUMENTATION WHEN DEVELOPING A FLIGHT PROGRAMME

When developing a flight programme, the operator should consider the applicable documentation available from the type certificate holder or other valid documentation such as the Flight Safety Foundation Functional Check Flight Compendium.

SPO.SPEC.MCF.110 Maintenance check flight manual for a 'Level A' maintenance check flight

Regulation (EU) 2019/1384

The operator conducting a “Level A” maintenance check flight shall:

- (a) describe those operations and associated procedures in the operations manual referred to in point [ORO.MLR.100](#) of Annex III or in a dedicated maintenance check flight manual;
- (b) update the manual when necessary;
- (c) inform all affected personnel of the manual and of its changes that are relevant to their duties;
- (d) provide the competent authority with the manual and its updates.

AMC1 SPO.SPEC.MCF.110 Maintenance check flight manual

ED Decision 2019/019/R

CONTENTS OF THE MAINTENANCE CHECK FLIGHT MANUAL

The items to be covered in the manual for a ‘Level A’ maintenance check flight (MCF) with complex motor-powered aircraft should be as follows:

- (a) General considerations:
 - (1) conditions requiring a MCF (e.g. heavy maintenance);
 - (2) appropriate maintenance release before the MCF;
 - (3) flight authorisation by the operator;
 - (4) process to develop a flight programme and procedures;
 - (5) relevant procedures to document MCFs in the aircraft records; and
 - (6) policy for the determination of a 'Level A' or 'Level B' MCF.
- (b) Aircraft status:
 - (1) requirements for the status of the aircraft prior to departure (e.g. MEL, CDL and multiple defects) for the purpose of conducting an MCF;
 - (2) fuel loading, if applicable;
 - (3) mass and balance, if applicable; and
 - (4) specific test and safety equipment.
- (c) Crew selection and other persons on board:
 - (1) qualifications;
 - (2) experience and recency;
 - (3) training; and
 - (4) persons on board.
- (d) Briefings:
 - (1) briefing participants;
 - (2) specific pre-flight briefing topics:
 - (i) aircraft status,
 - (ii) summary of maintenance,
 - (iii) flight programme, specific procedures and limitations,
 - (iv) crew members' responsibilities and coordination, and
 - (v) documents on board;
 - (3) information to ATC; and
 - (4) post-flight briefing.
- (e) Contents of the flight programme and procedures: the flight programme should be thoroughly developed by the operator using applicable current data. It should contain the checks to be performed in-flight and may include 'read and do' checklists where practicable. The following items should be included in the overall procedure:
 - (1) in-flight briefings;
 - (2) limits (not to be exceeded);
 - (3) specific entry conditions;
 - (4) task-sharing and call-outs;

- (5) potential risks and contingency plans;
 - (6) information to additional crew; and
 - (7) adequate available airspace and coordination with ATC.
- (f) External conditions:
- (1) weather and light conditions;
 - (2) terrain;
 - (3) ATC, airspace; and
 - (4) airport (runway, equipment)/operating site.
- (g) Documentation:
- (1) specific documentation on board;
 - (2) in-flight recordings;
 - (3) results of the MCF and related data; and
 - (4) accurate recording of the required maintenance actions after the flight.

SPO.SPEC.MCF.115 Flight crew requirements for a 'Level A' maintenance check flight

Regulation (EU) 2019/1384

- (a) The operator shall select adequate flight crew members considering the aircraft complexity and the level of the maintenance check flight. When selecting flight crew members for a “Level A” maintenance check flight with a complex motor-powered aircraft, the operator shall ensure all of the following:
- (1) that the pilot-in-command has followed a training course in accordance with point [SPO.SPEC.MCF.120](#); if the training has been conducted in a simulator, the pilot shall conduct at least one “Level A” maintenance check flight as a pilot monitoring or as an observer before flying as a pilot-in-command on a “Level A” maintenance check flight;
 - (2) that the pilot-in-command has completed on aircraft of the same aircraft category as the aircraft to be flown a minimum of 1 000 flight hours, of which at least 400 hours as a pilot-in-command in a complex motor-powered aircraft and at least 50 hours on the particular aircraft type.
- Notwithstanding point (2) of the first paragraph, if the operator introduces a new aircraft type to its operation and has assessed the pilot's qualifications in accordance with an established assessment procedure, the operator may select a pilot having less than 50 hours experience on the particular aircraft type.
- (b) Pilots holding a flight test rating in accordance with Regulation (EU) No 1178/2011 shall be given full credit for the training course stipulated in point (a)(1) of this point, provided that the pilots holding a flight test rating have obtained the required initial and recurrent crew resource management training in accordance with points [ORO.FC.115](#) and [ORO.FC.215](#) of Annex III.
- (c) A pilot-in-command shall not perform a “Level A” maintenance check flight on a complex motor-powered aircraft unless the pilot-in-command has carried out a “Level A” maintenance check flight within the preceding 36 months.

- (d) Recency as pilot-in-command on a “Level A” maintenance check flight is regained after performing a “Level A” maintenance check flight as an observer or a pilot monitoring, or after acting as the pilot-in-command in a “Level A” maintenance check flight in a simulator.

GM1 SPO.SPEC.MCF.115 and SPO.SPEC.MCF.120 Flight crew requirements for a “Level A” maintenance check flight & Flight crew training course for Level A maintenance check flights

ED Decision 2019/019/R

DEFINITION OF AIRCRAFT CATEGORY

In respect of the term ‘aircraft category’ used in the context of point (a) of [SPO.SPEC.MCF.115](#) and point (c) of [SPO.SPEC.MCF.120](#), it should be understood as ‘category of aircraft’ as defined in Commission Regulation (EU) No 1178/2011 (the Aircrew Regulation).

SPO.SPEC.MCF.120 Flight crew training course for Level A maintenance check flights

Regulation (EU) 2019/1384

- (a) The training course required for a “Level A” maintenance check flight shall be conducted in accordance with a detailed syllabus.
- (b) The flight instruction for the training course shall be conducted in either of the following ways:
- (1) in a simulator which, for training purposes, adequately reflects the reaction of the aircraft and its systems to the checks being conducted;
 - (2) during a flight in an aircraft demonstrating maintenance check flight techniques.
- (c) A training course followed on one aircraft category is considered valid for all aircraft types of that category.
- (d) When considering the aircraft used for the training and the aircraft to be flown during the maintenance check flight, the operator shall specify whether differences or familiarisation training is required and describe the contents of such a training.

AMC1 SPO.SPEC.MCF.120 Flight crew training course

ED Decision 2019/019/R

COURSE CONSIDERATIONS

- (a) The training course stipulated in point (a) of [SPO.SPEC.MCF.120](#) should comprise ground training followed by a demonstration in a simulator or aircraft of the techniques for the checks in flight and failure conditions. In a demonstration performed in an aircraft, the trainer should not simulate a failure condition that could induce a safety risk.
- (b) The ground training should cover the specified training syllabus (see [AMC2 SPO.SPEC.MCF.120](#)).
- (c) The flight demonstration should include the techniques for the most significant checks covered in the ground training. As part of this demonstration, the pilots under training should be given the opportunity to conduct checks themselves under supervision.
- (d) The ground training and flight demonstration should be provided by experienced flight crew with test or MCF experience. Flight demonstrations should be instructed by any of the following persons:

- (1) a type rating instructor currently authorised by the operator to conduct MCFs; or
 - (2) a pilot assigned by an aircraft manufacturer and experienced in conducting pre-delivery check flights; or
 - (3) a pilot holding a flight test rating.
- (e) Upon successful completion of the training, a record should be kept and a training certificate issued to the trainee.

AMC2 SPO.SPEC.MCF.120 Flight crew training course

ED Decision 2019/019/R

COURSE SYLLABUS

In the case of aeroplanes and helicopters, the training course syllabus should include the following subjects:

- (a) Legal aspects: regulations concerning MCFs.
- (b) Organisation of MCFs: crew composition, persons on board, definition of tasks and responsibilities, briefing requirements for all participants, decision-making, ATC, development of a flight programme.
- (c) Environmental conditions: weather and light requirements for all flight phases.
- (d) Flight preparation: aircraft status, weight and balance, flight profile, airfield limitations, list of checks.
- (e) Equipment and instrumentation: on-board access to various parameters.
- (f) Organisation on board: CRM, crew coordination and response to emergency situations.
- (g) Ground checks and engine runs: review of checks and associated techniques.
- (h) Taxi and rejected take-off: specifications and techniques.
- (i) Techniques for checks of various systems:
 - (1) **aeroplanes:** flight controls, high-speed and low-speed checks, autopilot and autothrottle, depressurisation, hydraulic, electricity, air conditioning, APU, fuel, anti-icing, navigation, landing gear, engine parameters and relight, air data systems.
 - (2) **helicopters:** flight controls, engine power topping, track and balance, high-wind start, autopilot, performance measurement, hydraulic, electricity, air conditioning, APU, fuel, anti-icing, navigation, landing gear, engine checks and relight, autorotation, air data systems.
- (j) Review of failure cases specific to these checks.
- (k) Post-flight analysis.

SPO.SPEC.MCF.125 Crew composition and persons on board

Regulation (EU) 2019/1384

- (a) The operator shall establish procedures to identify the need for additional task specialists.
- (b) For a “Level A” maintenance check flight, the operator shall define in its manual the policy for other persons on board.

- (c) For a “Level A” maintenance check flight, a task specialist or additional pilot is required in the flight crew compartment to assist the flight crew members, unless the aircraft configuration does not permit it or the operator can justify, considering the flight crew members workload based on the flight programme, that the flight crew members does not require additional assistance.

GM1 SPO.SPEC.MCF.125 Crew composition and persons on board

ED Decision 2019/019/R

TASK SPECIALIST’S ASSIGNED DUTIES, EQUIPMENT AND TRAINING

- (a) The operator should ensure that the task specialist is trained and briefed as necessary to assist the flight crew, including performing functions such as but not limited to:
- (1) assistance on ground for flight preparation;
 - (2) reading of a MCF checklist; and
 - (3) monitoring and recording of relevant aircraft or systems’ parameters.
- (b) If a task specialist’s assigned duties are not directly related to the flight operation but to the MCF (e.g. reporting from the cabin on a certain vibration or noise), the required training and briefing should be adequate to this function.
- (c) The task specialist should be trained as necessary in crew coordination procedures and emergency procedures and be appropriately equipped.
- (d) Only personnel (crew and task specialists) essential for the completion of the flight should be on board.

SPO.SPEC.MCF.130 Simulated abnormal or emergency procedures in flight

Regulation (EU) 2019/1384

By way of derogation from point [SPO.OP.185](#) a task specialist may be on board a “Level A” maintenance check flight if the task specialist is required to meet the intention of the flight and has been identified in the flight programme.

SPO.SPEC.MCF.135 Flight time limitations and rest requirements

Regulation (EU) 2019/1384

When assigning crew members to maintenance check flights, operators subject to [Subpart FTL](#) of Annex III (Part-ORO) shall apply the provisions of that Subpart.

SPO.SPEC.MCF.140 Systems and equipment

Regulation (EU) 2019/1384

When a maintenance check flight is intended to check the proper functioning of a system or equipment, that system or equipment shall be identified as potentially unreliable and appropriate mitigation measures shall be agreed prior to the flight in order to minimise risks to flight safety.

SPO.SPEC.MCF.145 Cockpit voice recorder, flight data recorder and data link recording requirements for AOC holders

Regulation (EU) 2019/1384

For a maintenance check flight of an aircraft otherwise used for CAT operations, the provisions for cockpit voice recorders (CVR), flight data recorders (FDR) and data link recorders (DLR) of Annex IV (Part-CAT) shall continue to apply.